

Publ. No. 2956  
Jan. 1975

# Instruction book

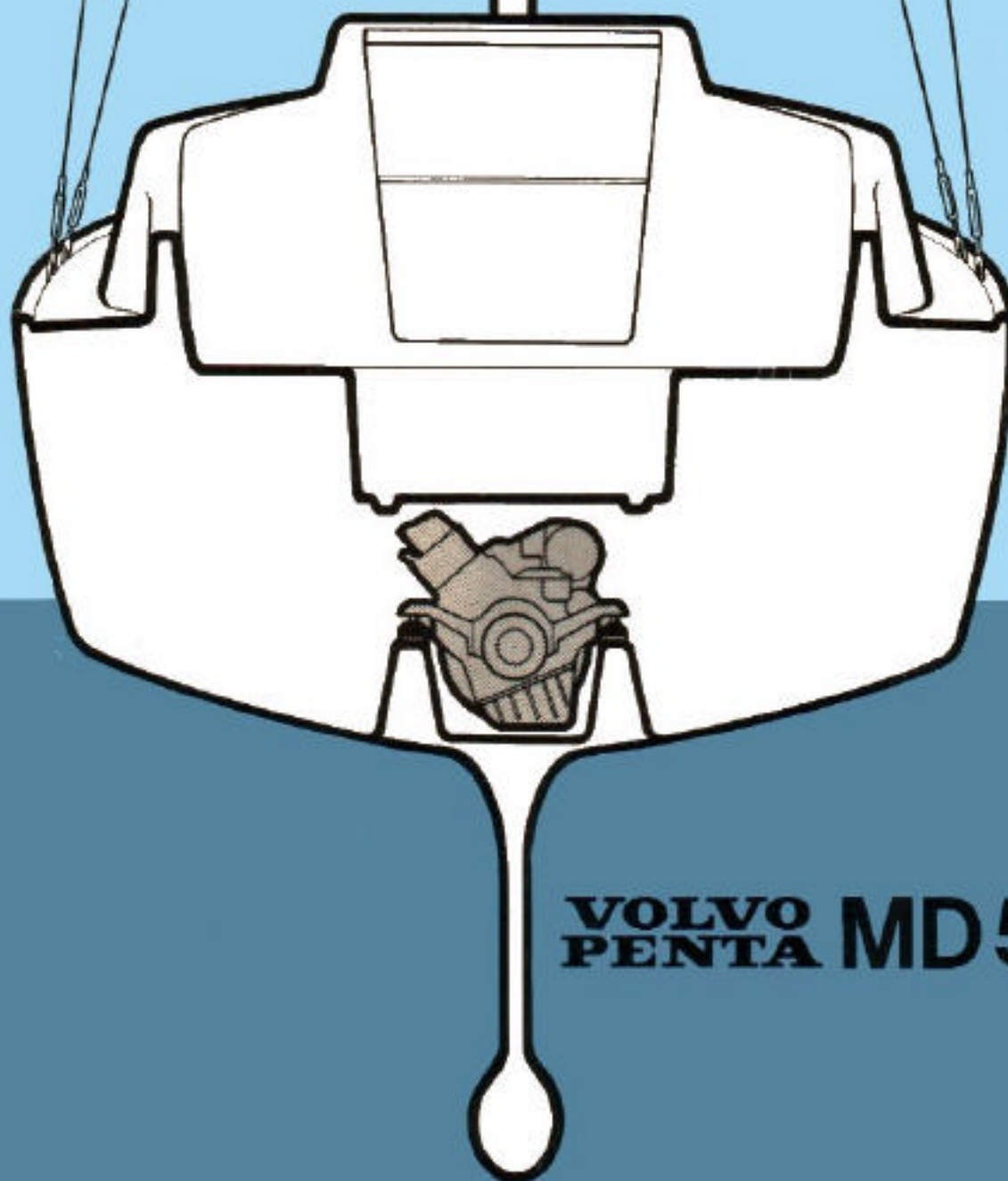

**VOLVO  
PENTA MD5A**



## **FOREWORD**

Before you start running your new Volvo Penta marine engine, you would be advised to read through this instruction book carefully. It contains all the information you need to run and service your engine in the best possible way.

Volvo Penta has built up an extensive service organization with service shops and specially trained personnel at your service.

Always contact your local Volvo Penta representative for advice and when in need of service and parts.

We are convinced that the demands on good running economy and top performance, which you have every right to expect of a quality product, will be met and that your engine will serve you faithfully on many pleasant cruises.

## **WARRANTY**

A warranty certificate is supplied with each engine. It contains the warranty conditions for the engine and should be studied carefully.

Also included is a report card which is to be completed by the dealer or boat seller. If our warranty is to apply, however, it is an absolute condition that the measures given in the "Check and Service Scheme" are carried out and that your engine and equipment are looked after according to the instructions in this manual. When in doubt, always get in touch with an authorized Volvo Penta dealer.

In all correspondence with your dealer and when ordering parts, state the type designation and serial number of the engine and reverse gear (see starboard side of engine).



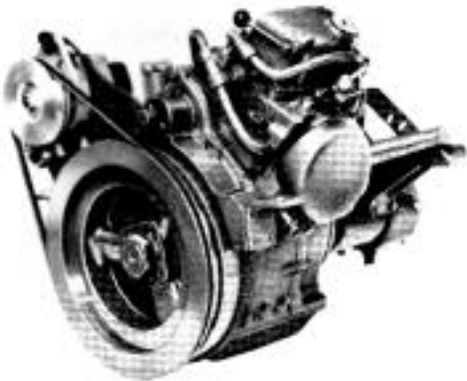

Presentation	2
General Information	3 - 4
Running Instructions	5 - 6
Starting the engine	5
Running instructions	6
Shutdown procedure	6
Technical Description	7 - 9
Checks and Service Scheme	10
Checks and Service	11 - 17
Check daily before starting	11
Check every 14 days	11 - 12
Service every 50 hours of operation	12 - 13
Service every 100 hours of operation	13 - 19
Laying-up and launching	20 - 23
Fault Tracing Scheme	24
Technical Data	25 - 26
Wiring Diagram	27
Engine Component Guide	28
Index, alphabetical order	29

**INSTRUMENT PANEL**



1. Switch, optional equipment
2. Warning lamp, "Excess temp."
3. Place for instrument (ø 52 mm opt. equipment)
4. Warning lamp, "No oil pressure"
5. Switch, optional equipment
6. Warning lamp, "No battery charging"
7. Siren, "No oil pressure, excess temp."
8. Key switch

**CONTROL SYSTEM**

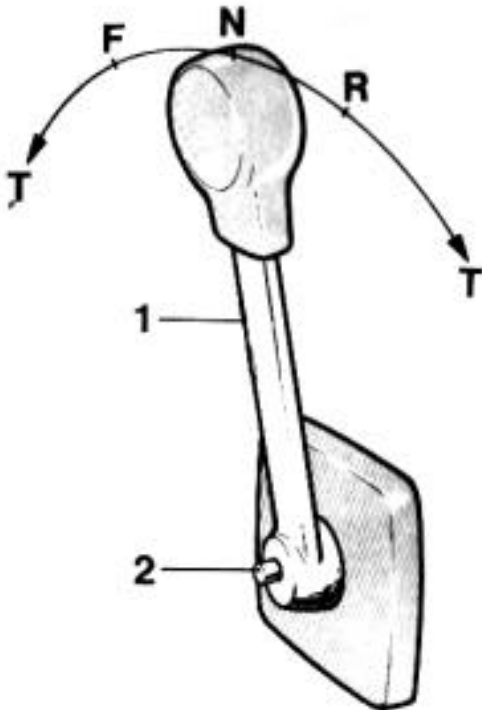

**Volvo Penta Single Control System**

For side mounting

1. Control lever
2. Disengaging button  
Push in the button when the control lever is in neutral and move the lever a bit forwards. Release button. The lever is now used only for engine speed control. To use the lever for both engine speed control and gear-changing, push in the button and pull back the lever to neutral.

N = Neutral  
 F = Control lever in position for running "Forward"  
 R = Control lever in position for running "Reverse"  
 T = Engine speed control

### Important information on the function of your engine:

#### FUEL

Use diesel fuel oil of quality "Autodiesel". Poorer fuel quality can cause interruptions in operation.

#### LUBRICATING OIL

Use only oil with quality CD (DS) according to the API system. Volvo Penta oil for diesel engines can be used with advantage since it meets these quality demands. See under "Technical Data" concerning the viscosity.

#### RUNNING-IN

A new marine engine must be run-in with due care during the first 20 hours of operation. If full output is taken out during this time, it should only be done for short periods.

**Oil change.** Change the engine lubricating oil and the oil filter after the engine has been run for 20 hours. See further under "Checks and Service".

#### ENGINE SPEED

Max. speed: 41.7 rev/sec (2500 rev/mm).

For choice of correct propeller, refer to the Volvo Penta propeller diagram. Check the engine speed with normal load in the boat. In order to utilize the maximum performance of the engine, an engine speed as high as possible should be chosen but not, however, greater than 41.7 rev/sec (2500 rev/mm).

NOTE. When the boat has been in the water for some time, the speed and max. rev/mm can drop due to marine growth on the hull. Prevent marine growth by painting the bottom of the boat with anti-fouling paint. See under "Measures taken when launching".

### SAFETY EQUIPMENT

Irrespective of whether the boat is being used for long cruises or short bathing trips, the boat should be equipped with the safety equipment listed below. It can, of course, be supplemented further according to personal tastes. Investigate at regular intervals to ensure that there is safety equipment on board and that it is in working order.

**LIFE-JACKETS** for all on board.

**FIRE EXTINGUISHER**, approved, at least one and installed where it is easy to get at.

**DISTRESS ROCKETS** and matches. Packed watertight.

**FIRST-AID BOX**

**TOOLS** suitable for the equipment on board.

**ON BOARD KIT** containing, e.g. impeller, etc.

**ANCHOR** with line.

**RADAR REFLECTOR**

**RADIO** for listening to, e.g., weather reports.

**COMPASS** which is deviated.

**BOAT HOOK** and paddle.

**MOORING ROPES**

**FOG-HORN** and whistle.

**FLOATING ANCHOR**

**TORCH**

### PREPARATIONS BEFORE STARTING

Make sure that:

There is no **FUEL LEAKAGE**

There is no **WATER LEAKAGE** from engine and hull

There is no **OIL LEAKAGE**

There is no **SMELL OF LP-GAS** in the deep cavities in the boat or elsewhere

The **OIL LEVEL** is correct

There is enough **FUEL** for the planned voyage







The proper **NAUTICAL CHARTS** are on board for the planned voyage

If there are some other persons on board, make sure that some of them is able to operate the boat.

If there are persons on board who have never been on a boat before, tell them where the life-jackets are located and where the fire-extinguisher is placed. Also tell them anything more you think necessary from a safety point of view. Should something unexpected happen during the voyage, it is very often too late to tell those on board how safety equipment works.

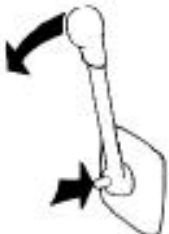

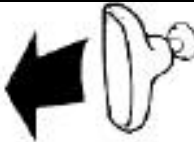

## STARTING THE ENGINE

	<p>Switch on the <b>main switch</b>. Start the <b>engine room fan</b> (if fitted) and let it run several minutes before starting the engine.</p>
	<p>Open the cock for the cooling water intake.</p>
	<p><b>Disengage the engine speed control</b> from the gear-changing as follows:</p> <p>Move the control lever to neutral, push in the red disengaging button, and move the lever slightly forwards. Release the button. The lever can now only operate the engine speed. Check to make sure that the stop control is pushed in.</p>
	<p><b>Turn the key switch</b> one stage to the right. The warning lamps for battery charging and oil pressure should now go on and the siren should sound. Push in and turn the key further to the right to start the engine. Release the key when the engine starts.</p> <p><b>Hand starter.</b> If the engine is started with the starting crank, the decompression handle on the rocker arm cover should first be folded up. Fold down this handle for running when the cranking has got the engine up in speed.</p>
	<p><b>Starting in cold weather</b> is facilitated if the cold-start control is pulled out. Push it in again after a while.</p>
	<p><b>Check immediately after starting</b> that the warning lamps for the oil pressure and battery charging are out and that the siren is quiet. <b>If any of the lamps are on and the siren is sounding, the engine must be stopped immediately and an investigation made.</b></p>
	<p><b>Run the engine warm</b> at rapid idle. Check to make sure that the cooling water flows out with the exhaust gases.</p> <p><b>NOTE.</b> The key switch should always be switched on as long as the engine is running to ensure that there is battery charging.</p>

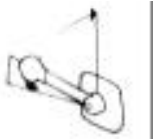

## RUNNING INSTRUCTIONS

	<p>Reduce to idle and check that the engine is running smoothly.</p> <p><b>Engage the control lever for gear-changing</b> as follows:</p> <p>Push in the red disengaging button and pull the lever back to neutral. Release the button. The control lever can now be used both for gear-changing and engine speed.</p>
---	--

## RUNNING

	<p>The single lever control has both engine speed and manoeuvring functions.</p> <p>F = Forward    N = Neutral R = Reverse    T = Engine speed control</p>
	<p>To achieve good running economy, the engine should not be run at max. speed for a longer period.</p>
	<p>Make sure that the battery charging warning lamp does not light when the engine is running. The siren will sound and the respective warning lamp go on if the engine temperature becomes excessive or the oil pressure too low.</p>

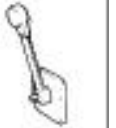
## SHUTDOWN PROCEDURE

	<p><b>After shutdown</b> the engine should be allowed to idle for a couple of minutes or so with the control lever in neutral.</p>
	<p><b>Stop the engine</b> by pulling out the stop control when the engine is idling. Then turn back the key switch to the initial position.</p>
	<p><b>Switch off the main switch.</b> NOTE. <b>This switch must never be switched off until the engine has stopped.</b></p> <p><b>Close</b> the fuel and cooling water cocks if the boat is not going to be used for some time.</p> <p><b>Check</b> for leakage before leaving the boat.</p> <p><b>In cold weather</b> and whenever there is risk of icing, the cooling water should be drained from the engine and reverse gear. See under "Laying-up and launching".</p>

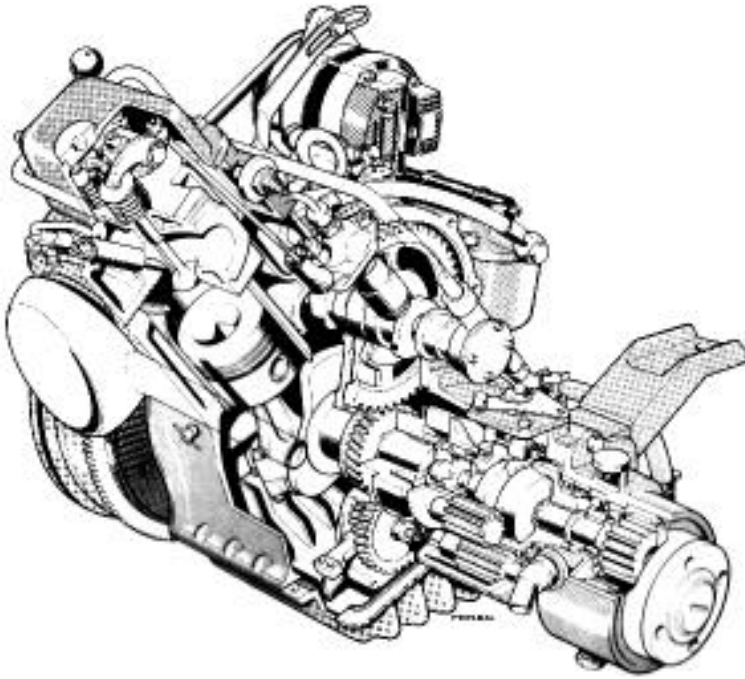

The MD5A is a single-cylinder, 4-stroke, marine diesel engine with direct injection and sea-water cooling.

## ENGINE ASSEMBLY

The engine block and cylinder head are made of cast iron. Cylinder angle 45°. The cylinder liner is replaceable. The engine has overhead valves.

## LUBRICATING SYSTEM

The lubricating system includes a full-flow oil filter which filters all the oil before it reaches the lubricating points. A relief valve in the oil pump prevents the oil pressure from becoming excessive.

## ELECTRICAL SYSTEM

The engine has a starter motor and alternator with built-in rectifier. Voltage regulation is taken care of by a transistorized regulator mounted on the alternator. The alternator makes it possible to charge two battery circuits independent of each other if a charging distributor (accessory) is fitted on the alternator.

A main fuse, which can easily be re-connected, is fixed to the engine. It protects the electrical system from damage in the event of overloading. The wiring diagrams for the engine and instrument panel are shown on page 27.

### FUEL SYSTEM

The fuel system contains a feed pump with pre-filter, fine filter, injection pump and injector. The feed pump, which is of the diaphragm type, has also a hand priming lever. Also fitted is a cold-start device with lever for connection of the push-pull control.

### COOLING SYSTEM

The engine is sea-water cooled. The cooling system includes a sea-water pump as well as a water distributor housing with thermostat.

The sea-water pump has an impeller of neoprene rubber driven by the camshaft via a rubber flange.

The thermostat installed in the water distributor housing regulates the water flow so that the water always flows through the exhaust manifold and out into the exhaust elbow irrespective of whether the engine is cold or warm.

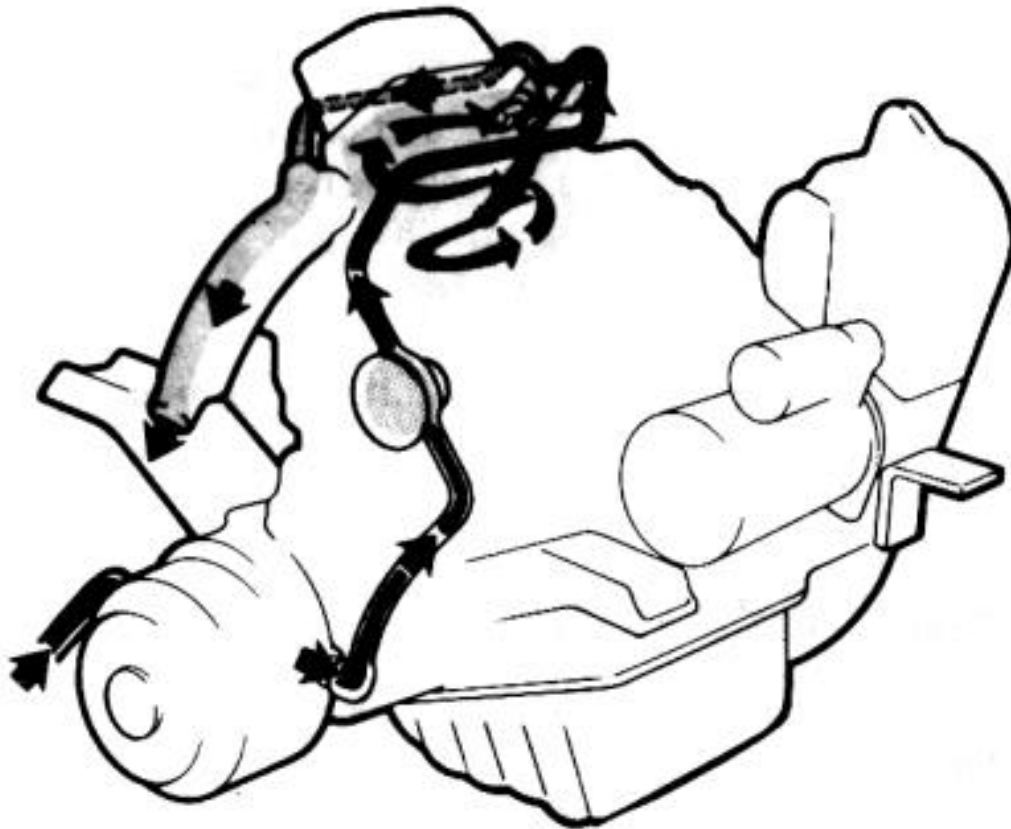

## REVERSE GEAR

The Volvo Penta reverse gear, type Mono Shift (MSB) has a reduction ratio of 1.91:1. The reduction gear is integrally built with the reverse gear. Power transmission from the engine to the reverse gear is via a rubber flange.

The Volvo Penta patented cone clutch is used for "Forward" and "Reverse" operation and ensures smooth and quiet engagement. Very small forces are required to operate the reverse gear.

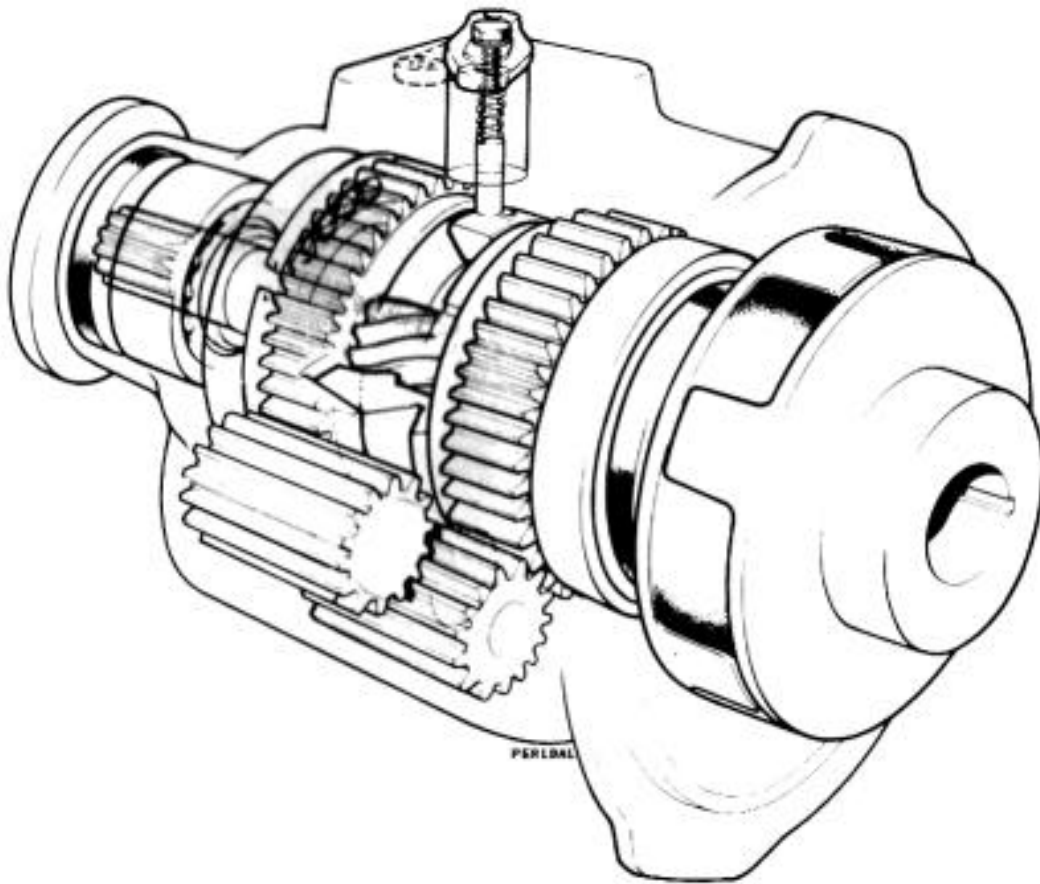

## CHECKS AND SERVICE SCHEME

Checks and service should be regularly carried out according to the intervals given below. Let an authorized Volvo Penta Service Shop look after your engine.

### CHECK DAILY BEFORE STARTING that

The oil level in the engine is between the marks on the dipstick

Page  
11

### CHECK every 14 days that

The oil level in the reverse gear is between the marks on the dipstick

11

The electrolyte level in the battery is correct

The belt tension

12

### SERVICE EVERY 50 HOURS OF OPERATION:

Change the oil in the engine

12

Change the oil in the reverse gear

13

Check and adjust the valve clearances

13

### SERVICE EVERY 100 HOURS OF OPERATIONS OR AT LEAST ONCE EACH SEASON:

Change the oil filter

13

Check the pulley belt

14

Check-tighten the cylinder head bolts

15

Check the cooling system

15

Check the electrical system (fuses, etc.)

16

Fuel system, filter, strainer, injector, venting

17-19

### SERVICE IN CONJUNCTION WITH LAYING-UP AND LAUNCHING THE BOAT

Inhibiting scheme I. Inhibiting measures carried out with boat in the water.

20

Inhibiting scheme II. Inhibiting measures carried out with boat on land.

21

Service in connection with launching.

22

## CHECK DAILY BEFORE STARTING

### OIL LEVEL IN ENGINE

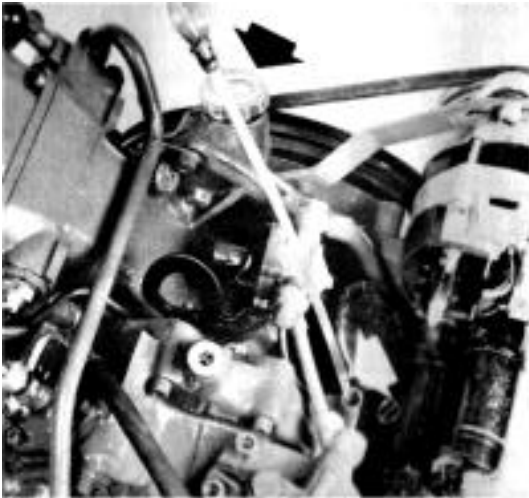

Each day before starting check that the oil level is between the marks on the dipstick. Top up with oil if necessary through the oil filler hole.

NOTE. Do not top up above the MAX. mark. Concerning choice of oil, see under "Technical Data".

## CHECKS every 14 days

### OIL LEVEL IN REVERSE GEAR

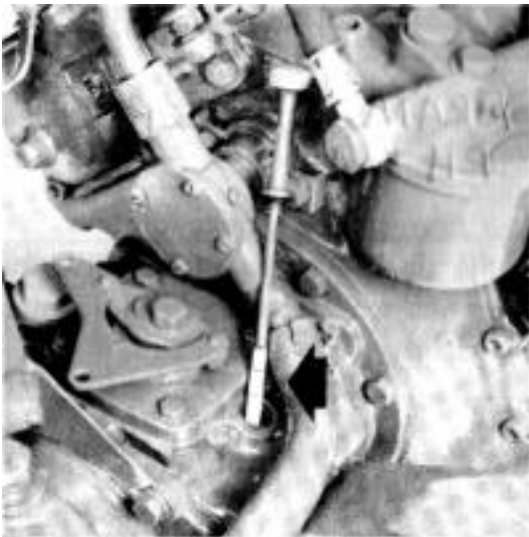

Screw up the dipstick, wipe it clean and insert it again without screwing it down. Pull up the dipstick and check the oil level which should be between the marks. If necessary top up with oil through the oil filler hole on the opposite side of the reverse gear. Do not top up above the MAX. mark.

Screw down the dipstick again. Note that there is a sealing washer on the dipstick. Concerning choice of oil, see under "Technical Data".

### ELECTROLYTE LEVEL IN BATTERY

The level should be between 5—10mm (3/16 – 3/8”) above the cell plates in the battery. If necessary top up with distilled water. **IMPORTANT.** Observe great care when doing this since the electrolyte is abrasive and the gas which is formed is explosive.

### BELT TENSIONING

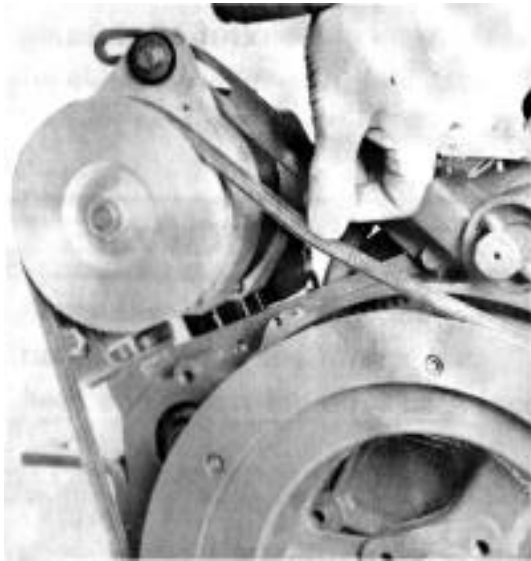

Correct belt tension is necessary for full alternator output. The belt should be so tensioned that it can be depressed 5 mm (3/16”) with the thumb midway between the pulleys.

To tension the belt, first slacken the alternator retaining points, stretch the belts and tighten up the points again.

A well worn or cracked belt should be replaced.

## SERVICE EVERY 50 HOURS OF OPERATION:

### CHANGE OIL IN ENGINE

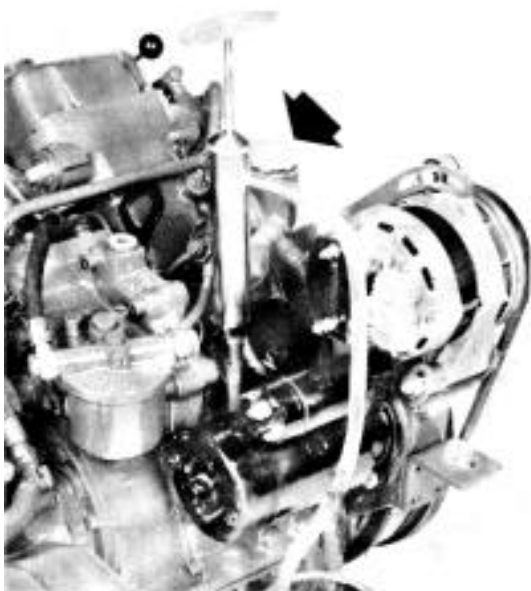

With a new or newly reconditioned engine, the oil should be changed for the first time after 20 hours of operation and after that after every 50 hours of operation.

Run the engine warm. Suck up the oil through the dipstick hole.

Fill with oil to the correct level. See under “Technical Data” concerning choice of oil.

**NOTE!** Change also the oil filter (Fram Filter PH3614) at every other oil change.



### CHANGE OIL IN REVERSE GEAR



The oil can be drained from the reverse gear by removing the plug under it or by sucking up the oil through the dipstick hole with the help of an oil scavenging pump.

Fill with oil through the filler hole to the correct level on the dipstick. NOTE. Do not fill above the 'MAX.' mark on the dipstick. Concerning choice of oil, see under "Technical Data"

### VALVE CLEARANCE



The valve clearance should be checked and adjusted by authorized personal. See under "Valves", in "Technical Data".

**SERVICE EVERY 100 HOURS OF OPERATION OR AT LEAST ONCE EACH SEASON**

### OIL FILTER

The oil filter should be replaced for the first time after 20 hours of operation during the running in period and subsequently at every other oil change. IMPORTANT. Before removing the filter, switch off the main switch. Screw off and scrap the oil filter. It may be necessary in certain cases to lift off the belt and tension out the alternator to permit free passage for the filter.



Coat the new filter rubber gasket with oil.

Check the area on the engine in contact with the filter and screw on the filter **by hand** until it just touches the engine. Then screw the filter a further **half turn, but not more.**

NOTE. Only use a genuine oil filter.

Start the engine, allow it to idle and immediately check that the oil pressure warning lamp is out.

Check the oil level and also for any leakage round the oil filter.

## CHECK THE BELT

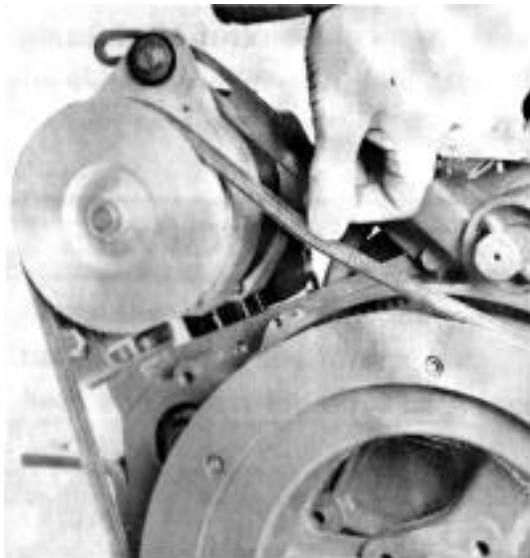

Check the belt thoroughly for wear and cracks. Replace it if there is any indication of such. To remove the belt, slacken the alternator retaining points in order to be able to slip the belt off. Wipe clean the belt groove on the pulleys before fitting the new belt. Tension the belt so that it can only be depressed 5 mm (3/16") with the thumb between the pulleys. After the engine has been run for an hour or so, re-check and if necessary adjust the belt tensioning.

## CHECK-TIGHTEN THE CYLINDER HEAD BOLTS

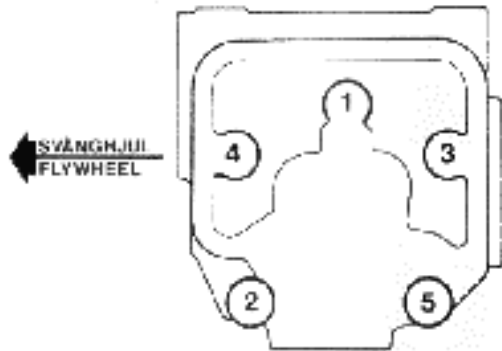

Authorized personal should check-tighten the bolts **with a torque wrench** before starting a new or newly reconditioned engine for the first time and again after it has been in operation for 20 hours.

Check the valve clearance after tightening up the bolts. The bolt-tightening sequence can be seen from the adjacent illustration.

Concerning the tightening torque, see under "Technical Data".

## CHECK THE COOLING SYSTEM

The cooling system is functioning normally when the "Temp" lamp is out and the siren is quiet. Excessive temperature ("Temp" goes on, the siren sounds) may be due to the following: clogged water intake, defective impeller or flange in the sea-water pump, faulty thermostat or temp. gauge sender. **Look out for water penetration** during all work on the cooling system.

### Check and replace the impeller



The impeller can be damaged due to, e.g., shortage of water. Remove the cover on the water pump. Pull out the shaft the length required in order to screw out the impeller lock bolt. Hold against the shaft and pull off the impeller. If the impeller is damaged, fit a new one. **NOTE!** If the shaft has been removed entirely from the pump housing, check when re-fitting it that the D-ring between the sealing rings in the housing gets onto the shaft.

Tighten up the impeller with the lock bolt.

If the impeller and shaft can be rotated then the flange is defective. A new flange can be fitted after the pump has been removed. Fit the cover with its gasket.

## ELECTRIC SYSTEM

## Alternator

The engine is equipped with an alternator. To ensure that the alternator with the built-on regulator functions without interruptions the following important points must be observed:

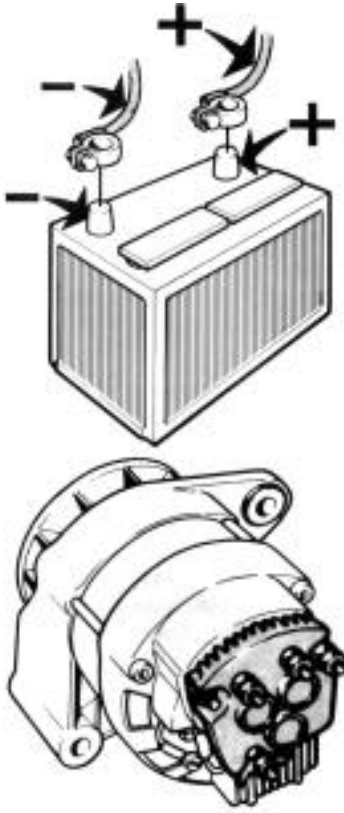

1. **Never switch off the main switch until the engine has been stopped.**

To do otherwise would be to ruin the charging regulator.

2. **Do not mix up the battery connection poles.** A plus sign and a minus sign are marked on the respective poles. The minus pole is connected up to the engine body. Cable shoes should be greased and well tightened.
3. **Re-wiring between the charging circuits may not be carried out while the engine is running.**

Fit a Volvo Penta charging distributor (accessory) on the alternator when more than one battery is connected up.

4. Observe the following in the event the engine is started with an auxiliary battery:

Let the ordinary battery remain connected up. Connect the auxiliary battery to the ordinary battery, plus to plus and minus to minus. When the engine has started, remove the auxiliary battery but **do not** break the ordinary battery's wiring circuit.

5. Do not use a rapid charging unit when the alternator is connected to the battery.
6. Before doing any work on the alternator equipment first disconnect both the battery cables.
7. In the event any electrical welding work is done on the engine or the installation components, disconnect the charging regulator cables at the alternator and insulate the cable ends.
8. Check regularly the belt tension and the cable connections.

## Change Fuse

A fusebox is mounted on the cylinder. A fuse breaks the electrical system when the system is overloaded. Re-connect the electrical system by transferring the cable connection to the next fuse contact.

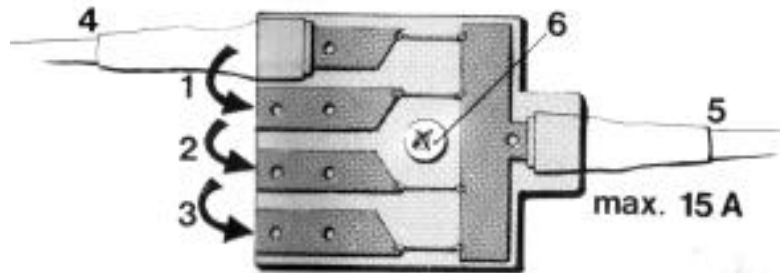

## Starter motor and alternator

All work connected with the starter motor and alternator should be done by an authorized service shop. Inspection and control should be carried out in connection with a general inspection of the engine.

## BATTERY

Checking the state of charge of the battery

The state of charge of the battery should be checked at least once each season. This is done by using a hydrometer which shows the specific gravity of the electrolyte, this varying with the state of charge. (See the Technical Data.)

## FUEL SYSTEM

Observe the greatest cleanliness when handling the fuel system.

**IMPORTANT:** Try to avoid fuel splash.

### Change fuel filter

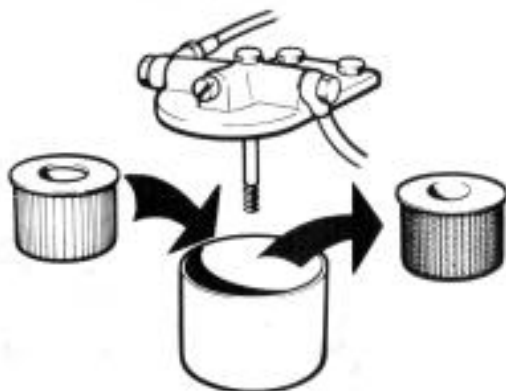

The filter element in the fuel filter should be changed at least once each season.

To do this remove the filter centre screw and lift off the filter. Clean the container and contact surfaces. Fit the new filter element and its gasket. Pump up the fuel with the hand primer. Vent the fuel system.

If the pumping effect is poor, turn over the engine a bit so that the drive cam alters its position.

### Extra fuel filter

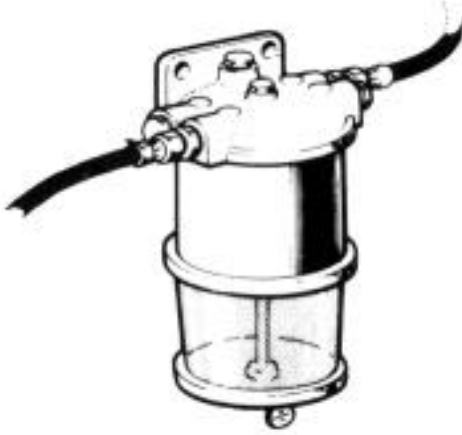

If an extra fuel filter is fitted together with a water separator, check the transparent bowl to see if there is any water in the fuel. If necessary, drain the filter via the cock in the bottom of the bowl.

Try to avoid fuel splash. Pump up the fuel with the hand primer and vent the system. The fuel filter element should be changed at least once a season.

### FUEL STRAINER



The fuel pump on the engine has a built-in strainer which is accessible after removing the cover. Clean the strainer at least once a season.

**Immediately after starting the engine, check for leakage.**

Always vent the fuel system. See under "Venting the fuel system".

### Injector

The injector should be removed once a season and handed in to a diesel shop for cleaning and checking the opening pressure, the spray pattern and for leakage. To remove the injector, unscrew the delivery pipe and the by-pass oil line. Fit protective caps over the openings.

Release both the nuts over the fork holding the injector to the cylinder head and lift up the injector. If the injector feels stiff to remove due to gumming, grip it with, e.g., polygrip pliers and carefully rotate it back and forth while levering it up at the same time (with a screwdriver, e.g., under the fork). Before fitting, check to make sure the contact surface on the injector and copper sleeve is clean. Connect up the delivery pipe and the return line but do not tighten the delivery pipe nut at the injector. Turn over the engine with the starter motor until fuel comes from the delivery pipe. Tighten up the delivery pipe nut and make sure the delivery pipe cone is fitted properly. Concerning tightening torque, see "Technical Data".

## Venting the fuel system

In order for the engine to be able to start, the fuel system must be vented on the following occasions:

- |  |  |
|--|--|
| When changing the fine filter.           | With leakage and work on the fuel lines.           |
| When draining through the drain hole.    | When the engine has not been used for a long time. |
| When cleaning the fuel pump strainer.    |  |
| After running the fuel tank empty.       |  |
| When installing the fuel injection pump. |  |

Venting is as follows:

1. Open the vent screw on the fuel filter.
2. Pump forward the fuel with the help of the hand primer until fuel free from air bubbles flows out. Close the vent screw. If the pumping effect is poor, turn over the engine a bit so that the pump drive cam alters its position.
3. If the fuel injection pump has been removed, or when starting an entirely new engine for the first time, the fuel injection pump must be vent. To do this open the vent screw on the pump. Pump with the hand primer until fuel free from air comes out. Slacken the injector delivery pipe nut and turn over the engine by means of the starter motor until fuel comes from the delivery pipe. Tighten up the delivery pipe nut and start the engine.

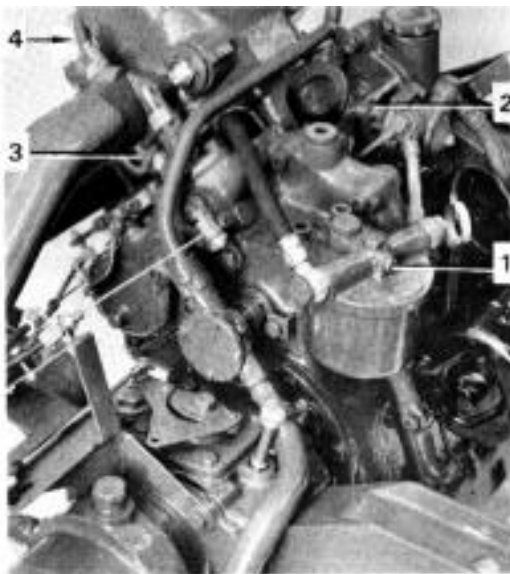

1. Vent screw, fuel filter
2. Hand primer
3. Vent screw, injection pump
4. Delivery pipe nut

## SERVICE IN CONNECTION WITH LAYING-UP AND LAUNCHING THE BOAT

### INHIBITING ENGINE AND REVERSE GEAR

#### IDLE ENGINE FOR BRIEF PERIODS WITH BOAT IN THE WATER

To prevent the engine from corrosion attacks, it must be run warm at least once every 14 days as long as the boat is in the water. If it is anticipated that the boat will not be used for more than a month, long-term inhibiting should be carried out.



#### INHIBITING FOR A LONG PERIOD

An authorized service shop should test the engine and equipment before inhibiting the engine for a long period acc. To Inhibiting Schemes I and II. A suitable procedure would be to test the compression.

### SERVICE INSTRUCTION

#### Inhibiting Scheme I

#### Carried out with the boat in the water

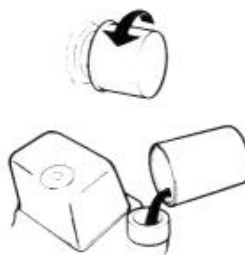

 <p>1</p>	<p>Run the engine warm.</p>
 <p>2</p>	<p>Pump out all the oil from the engine and reverse gear. Use an oil scavenging pump.</p>
 <p>3</p>	<p>Change the oil filter. Fill the engine and reverse gear to the correct level with Volvo Penta oil, which also has rustproofing properties, to the correct level. The lubricating system is thereafter ready for operation the next season.</p> <p>If rustproofing oil is used, it should be of the type Esso Rustban 623, Sheel Ensis Oil or corresponding.</p> <p>In this case, the oil filter should be replaced when launching.</p>



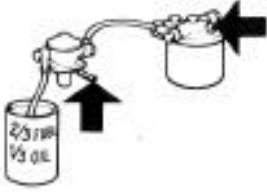



## LAYING-UP AND LAUNCHING

 <p>4</p>	<p>Drain the fuel filter.</p>
 <p>5</p>	<p>Disconnect the fuel pump flexible suction hose from the fuel system and insert the free end in a can filled with 1/3rd Volvo Penta oil or preservative oil and 2/3rds diesel fuel oil. Bleed the fuel system. Let the engine run at rapid idle for about 10 minutes.</p> <p>NOTE! If the fuel system has an electrically operated fuel pump, it must be switched off before the engine is started.</p>

### Inhibiting Scheme II Carried out with the boat on land



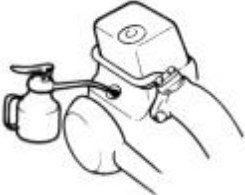

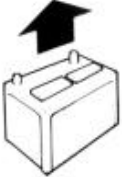
 <p>6</p>	<p>Drain the cooling water from the engine and reverse gear. Check to make sure that the water runs out since impurities can block the cock. Then close all cocks and re-fit the drain cock in the reverse gear.</p>
 <p>7</p>	<p>Disconnect the reverse gear suction line from the reverse gear. Connect a hose with inner diameter 1/2" and, insert the free hose end in a container with fresh water. Arrange to have water added to the container and run the engine at idle for about 5 - 10 minutes so that it is flushed throughout with fresh water. Make sure that there is no dirt near the exhaust outlet. Drain all water from the engine and reverse gear. Then close all drain points.</p>
 <p>8</p>	<p>Mix a rustproofing mixture consisting of 15 - 20 litres (13 Imp.qts. = 16 us qts. - 18 Imp.qts. = 21 US qts.) fresh water and 2 - 4 litres (1.8 Imp.qts. = 2.0 US qts. - 3.5 Imp.qts. = 5.3 US qts.) rustproofing oil.</p> <p>NOTE! Water first and then the oil.</p> <p>Use, e.g., Esso Cutwull 40, Shell Donax C or similar. As an alternative, a freeze-resistant 30 % glycol mixture can be used.</p>

## LAYING-UP AND LAUNCHING

 <p>9</p>	<p>Insert the hose into the rustproofing mixture. Start the engine and allow it to idle until the mixture is finished. NOTE! The water pump must never be allowed to run dry.</p>
 <p>10</p>	<p>Since the rustproofing mixture does not provide any protection against freezing, it must be drained from the engine and reverse gear. Remove the cover from the cooling water pump. Check to make sure the impeller is in good condition. NOTE! Do not pull out the impeller if it is in good condition.</p>
 <p>11</p>	<p>Remove the injector and hand it in to a diesel shop for cleaning and checking. Inject Volvo Penta oil into the cylinder. Turn over the engine several turns with the starter motor or the crank. NOTE! Prevent oil splash. Fit the checked injector but do not final-tighten it. It will be removed again before launching.</p>
 <p>12</p>	<p>Clean the outside of the engine and reverse gear. Touch up any bare patches on the paintwork with the same type of paint as the original. Spray the electrical system components and all the controls with anti-moisture spray.</p>
 <p>13</p>	<p>Remove the battery. It needs to be maintained to prevent it from being damaged.</p>

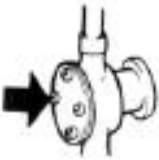
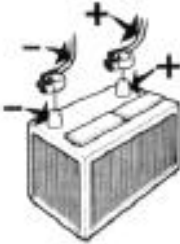
### Service in connection with launching

 <p>14</p>	<p>If Volvo Penta oil has been used, only the oil level in the engine and reverse gear needs to be checked. If another type of preservative oil has been used, both oil and filter must be replaced. See under "Service 14 after every 50 hours of operation".</p>
---	--

<p>15</p> 	<p>Screw tight the cover with its gasket on the cooling water pump. Connect the hose between the cooling water intake and the reverse gear. Check-tighten all the hose clamps. Close the drain cocks. Clean the outside of the engine and the reverse gear.</p>
<p>16</p> 	<p>Install the battery, which should be fully charged. Grease the cable shoes. Connect up the battery cables. <b>IMPORTANT!</b> Do not mix up the polarity. Tighten up the cable shoes well.</p>
<p>17</p> 	<p>Remove the injector. Take measures to avoid oil splash and run the engine several turns so that the oil on the piston crowns is blown out. Fit the injector. See under "Tightening torques", "Technical Data".</p>
<p>18</p> 	<p>Launch the boat. Change the fuel-filter cartridge. Pump forward the fuel and vent the system. See under "Venting the fuel system".</p>
<p>19</p> 	<p>Start the engine. See the instructions on page 5. Run the engine warm with the reverse gear engaged. Check to make sure there is no leakage of fuel, air, water or exhaust gases. Check that all the controls, etc., are functioning properly.</p>
<p>20</p> 	<p>If necessary, contact authorized Volvo Penta service shops and let them service the engine and reverse gear according to the instructions in the servicing scheme.</p>

## FAULT TRACING SCHEME

### TRACING FAULTS WITH INTERRUPTIONS IN OPERATION

The fault tracing scheme given below lists only the most usual reasons for faults that give rise to interruptions in operation. With the help of the instructions given in this handbook, the owner can generally remedy most of the reasons for the faults listed below. When in doubt always contact the nearest Volvo Penta service shop.

Engine does not start	Engine stops	Engine does not reach correct operating speed at full throttle	Engine runs unevenly or vibrates abnormally	Engine becomes abnormally hot	Reason	See
X					Main switch not switched on; flat battery, breakage in electric cables or blown fuse.	pp 5, 12, 16, 17, 27
X	X				Empty fuel tank, closed fuel cock, blocked fuel filter	pp 17, 18
X	X		X		Water, air or impurities in fuel	pp 17, 18, 19
X	X	X	X		Defective injector	pp 18, 26
	X		X		Idling speed not properly adjusted	p 25
		X			Boat overloaded	
		X			Marine growth on boat bottom	
			X		Damaged propellor	
				X	Blockage in cooling water intake, cooling jackets, defective impeller, or thermostat	p 15



# TECHNICAL DATA

## Reverse Gear

Oil quality/Viscosity	See under "Engine"
Oil capacity, litre (qt.)	0.55 (0.5)

## Cooling System

Thermostat, starts to open at °C (°F)	60°±2 (140±2)
fully open at °C (°F)	90° (195)

## Fuel System

Fuel injection pump, make & type	Bosch PFR1K
Feed pressure, MPa (kp/cm <sup>2</sup> = lbf/in <sup>2</sup> )	7.5 (0.75 = 11)
Injector, make Bosch, holder	KBAL 65
nozzle	DLLA 150
opening pressure, MPa (kp/cm <sup>2</sup> = lbf/in <sup>2</sup> )	1800 (180 = 2560)
Pre-injection angle, crankshaft degrees B.T.D.C.	25 - 28°
Fuel quality "Autodiesel"	Cet. rating minimum 45

## Electrical System

Battery voltage	12v
Battery capacity, standard	60 Ah
max	120 Ah
Starter motor	0.8 kW (1.1 h.p.)
Alternator	35A (420W)
Battery, electrolyte specific gravity:	
Charging carried out at g/cm <sup>3</sup>	1.230
Fully charged battery, g/cm <sup>3</sup>	1.275 - 1.285

## Tightening Torques

Cylinder head nuts, Nm (kpm = lb.ftf)	70 (7.0 = 50)
Connecting rod bolts, Nm (kpm = lb.ftf)	70 (7.0 = 50)
Crankshaft main bearings, Nm (kpm = lb.ftf)	70 (7.0 = 50)
Flywheel nut, Nm (kpm = lb.ftf)	500 (50.0 = 362)
Injector nuts, Nm (kpm = lb.ftf)	10 (1.0 = 7)

## Cable Colour Code

Marking	Colour	mm <sup>2</sup>	A.W.G.
A	White	6	9
B	Black	1.5	15
B'	Black	0.6	19
B''	Black	0.75	18
C	Red	6	9
C'	Red	35	1
C''	Red	0.6	19
F	Yellow	1.5	15
G	Brown	1.5	15
H'	Blue	35	1
I	Green/Red	1.5	15
I'	Green/Red	0.75	18
J	Green	1.5	15
J'	Green	0.6	19
J''	Green	0.75	18
K	Blue/Yellow	0.75	18
L	White/Red	0.75	18
M	Blue/Red	0.75	18

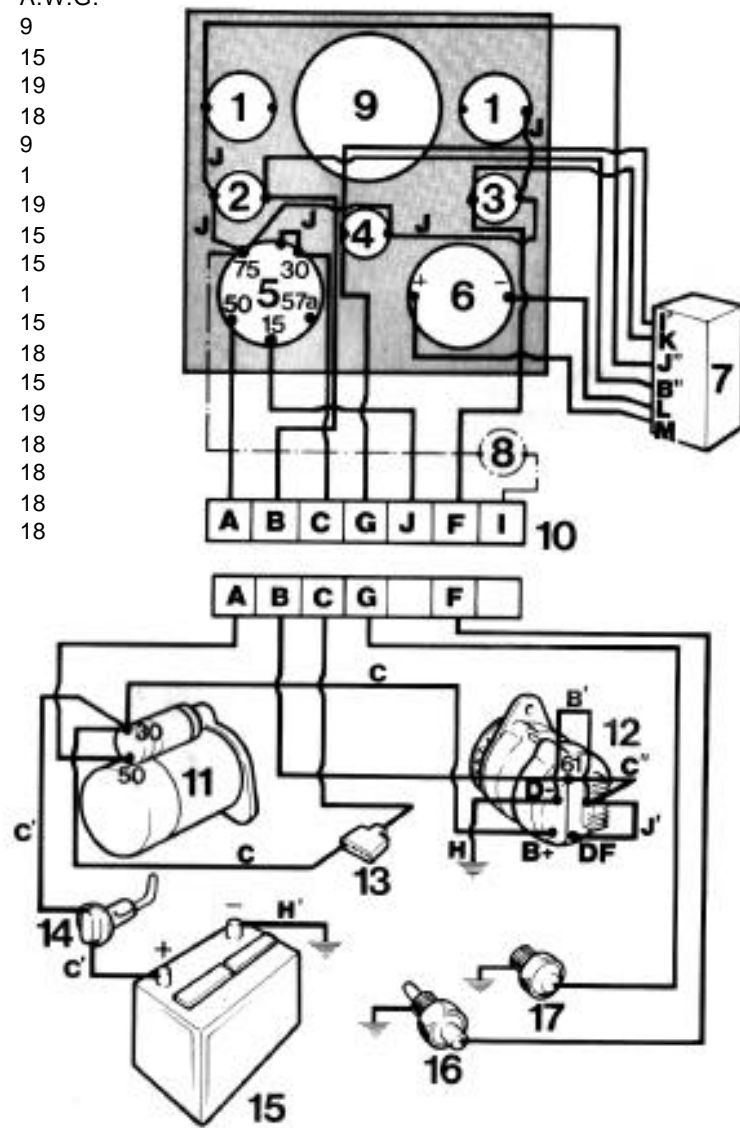

## List of Components

- |  |   |
|--|---|
| 1. Extra switch  | 9. Place for instruments, opt. equipment) |
| 2. Battery charging warning lamp                                       | 10. Rapid connector                       |
| 3. Excessive temp. warning lamp  | 11. Starter motor                         |
| 4. Low oil pressure warning lamp                                       | 12. Alternator                            |
| 5. Key switch  | 13. Fusebox                               |
| 6. Siren   | 14. Main switch                           |
| 7. Alarm unit  | 15. Battery                               |
| 8. Battery charging warning lamp (for battery circuit, opt. equipment) | 16. Temperature sender                    |
|  | 17. Oil pressure sender                   |

## ENGINE COMPONENT GUIDE

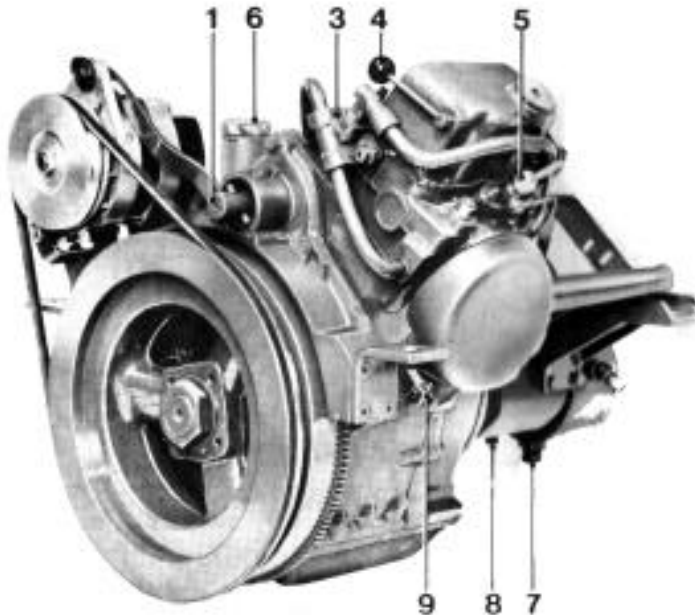

1. Connection for manual starting crank
2. Fusebox
3. Thermostat housing
4. Decompression handle
5. Injector
6. Oil filler cap, engine
7. Reverse gear water drainage
8. Reverse gear oil drainage
9. Engine water drainage

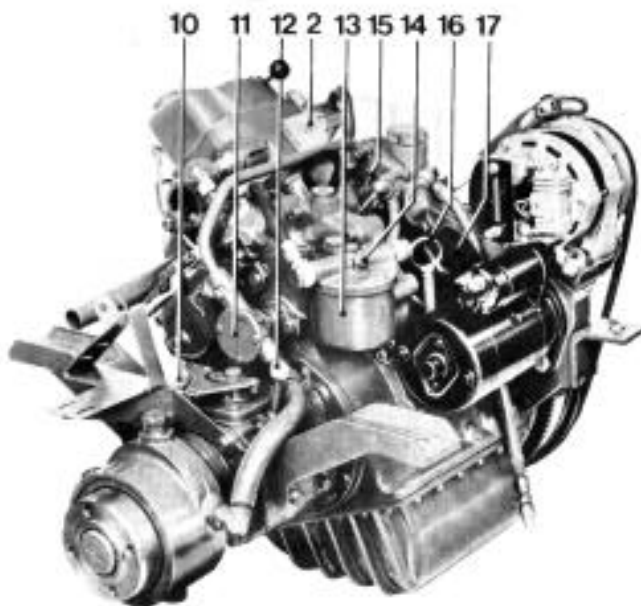

10. Reverse gear oil filler
11. Cooling water pump
12. Reverse gear oil dipstick
13. Fuel filter
14. Vent screw
15. Fuel hand primer
16. Engine oil dipstick
17. Oil filter

### **The tool kit supplied with the engine contains the following tools:**

US-spanner 10-12, UP-spanner 14-16 , screwdriver, Phillips screwdriver, flat end pliers, oil scavenging pump with hose and suction pipe as well as Allen spanners for the drive.



<b>Alternator</b>	7, 14, 16, 27	<b>Lubricating oil</b>	3, 25
<b>Battery</b>	12	<b>Main Switch</b>	5, 6
Belt tensioning	12, 14	<b>Oil change</b>	12, 13
<b>Charging regulator</b>	7, 16	Oil dipstick, engine	28
Controls	2, 6	Oil dipstick, reverse gear	28
Cooling system	8	Oil filter	14, 20, 28
Cylinder head bolts	15	Oil level check	11
<b>De-inhibiting</b>	22	<b>Preparations before starting</b>	4
Drain cocks	28	<b>Running</b>	6
<b>Electrical system</b>	16	<b>Safety equipment</b>	4
Engine assembly	7	Sea-water pump	8, 15, 28
<b>Fault tracing scheme</b>	24	Starter motor	17
Fuel	3	Starting	5
Fuel filters	17	<b>Technical data</b>	25, 26
Fuel pump	8	Thermostat	8, 26
Fusebox	7, 17	<b>Valve clearances</b>	13, 25
<b>Hand primer</b>	8, 17, 23, 28	Venting the fuel system	19
Hand starter	5, 28	<b>Wiring diagrams</b>	27
<b>Impeller</b>	15		
Inhibiting	20		
Injector	18, 23		
Instruments	2, 27		





**AB VOLVO PENTA**  
BOX 392 S-401 26 GÖTEBORG 1 SWEDEN