

**WaveRunner FX140**

**Four Stroke  
Waverunner FX140**

**Train The Trainer in Japan, December 2001**

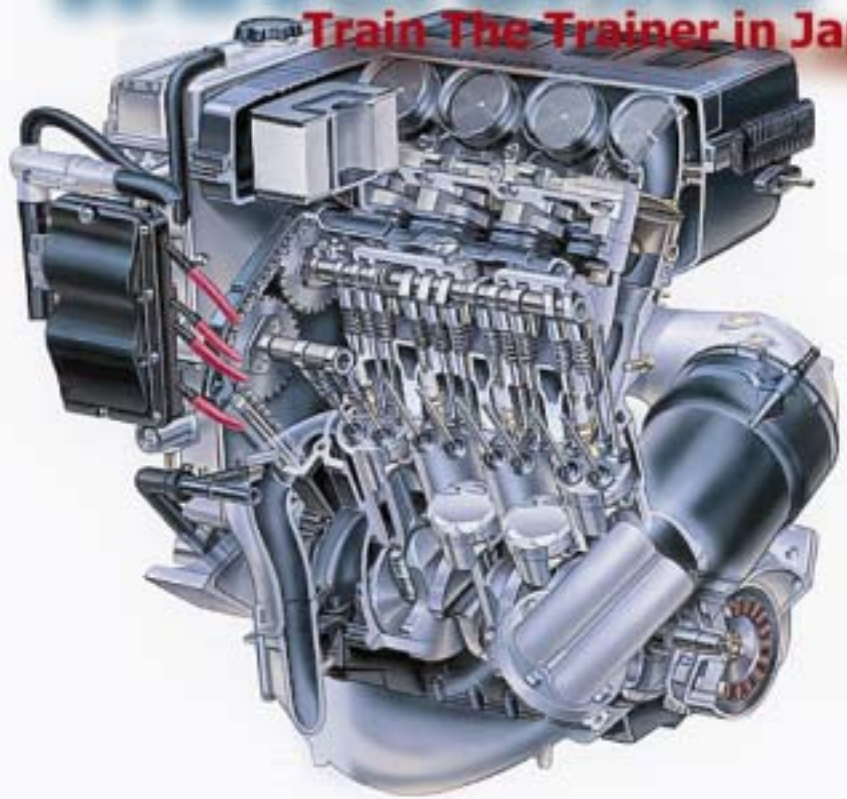

- ✧ Model Outline
- ✧ Performance
- ✧ Features & Benefits
- ✧ Technical Tips
- ✧ Service Tips
- ✧ Other Information



# Model Outline



~ INDUSTRIAL / YAMAHA FIRST 4 Stroke PWC ~

ALL NEW Body 3 Seater 2002 Model YMMC Production

ALL NEW 4 stroke 998cc 5 Valve 4 Cylinder Engine

- Concept and Target
- Model Positioning in YAMAHA
- Model Positioning in Market
- Model Positioning in Society
- Feature
- Product Plan
- Specifications



Power Outline

# Next Generation Three-Seater

Which harmonized  
environment and PWC fun character



# Model Positioning in Market

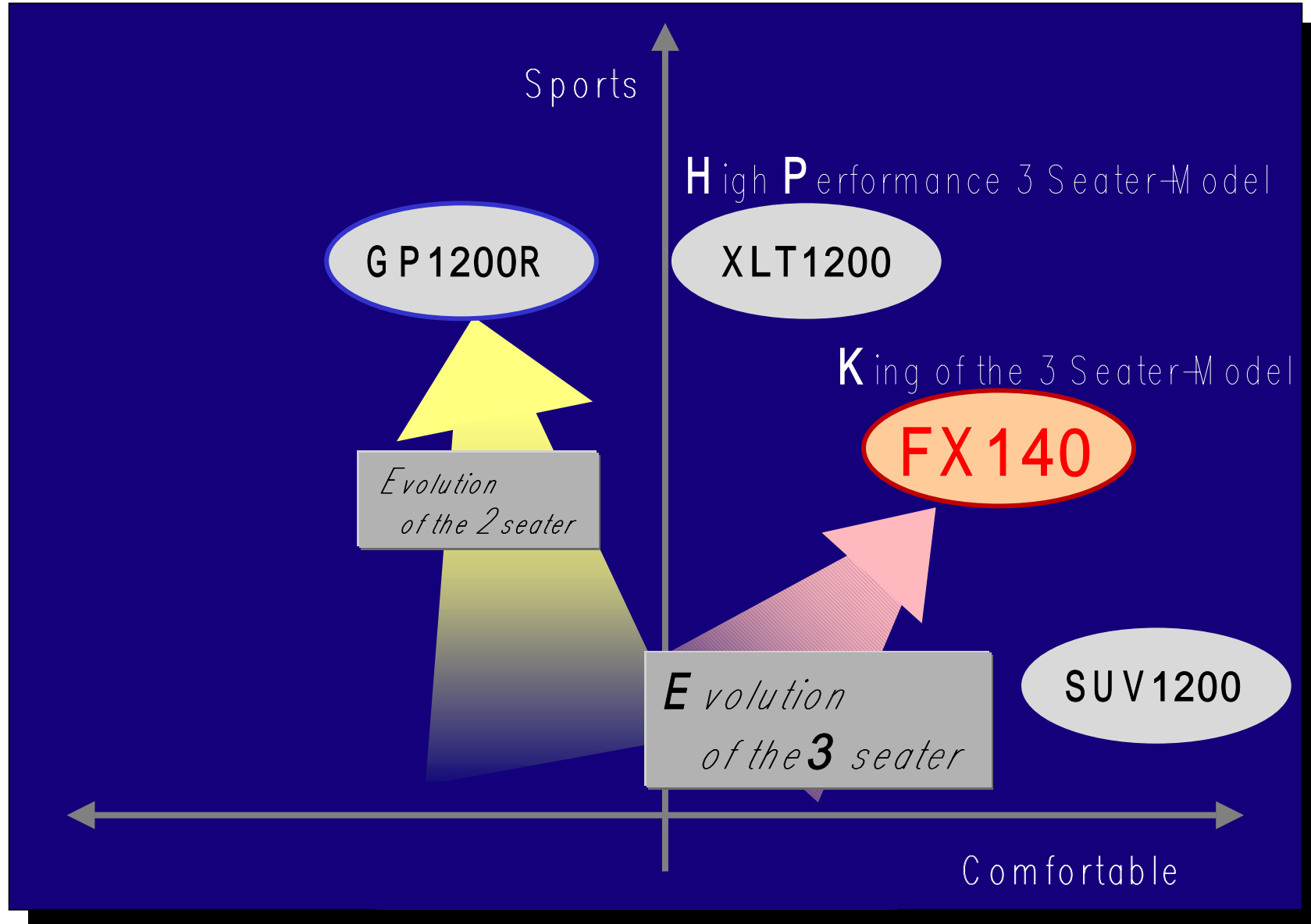

Active approach to gain the positive image of PWC

Take action to sweep negative image of PWC away by introducing YAMAHA FX140 as starting model

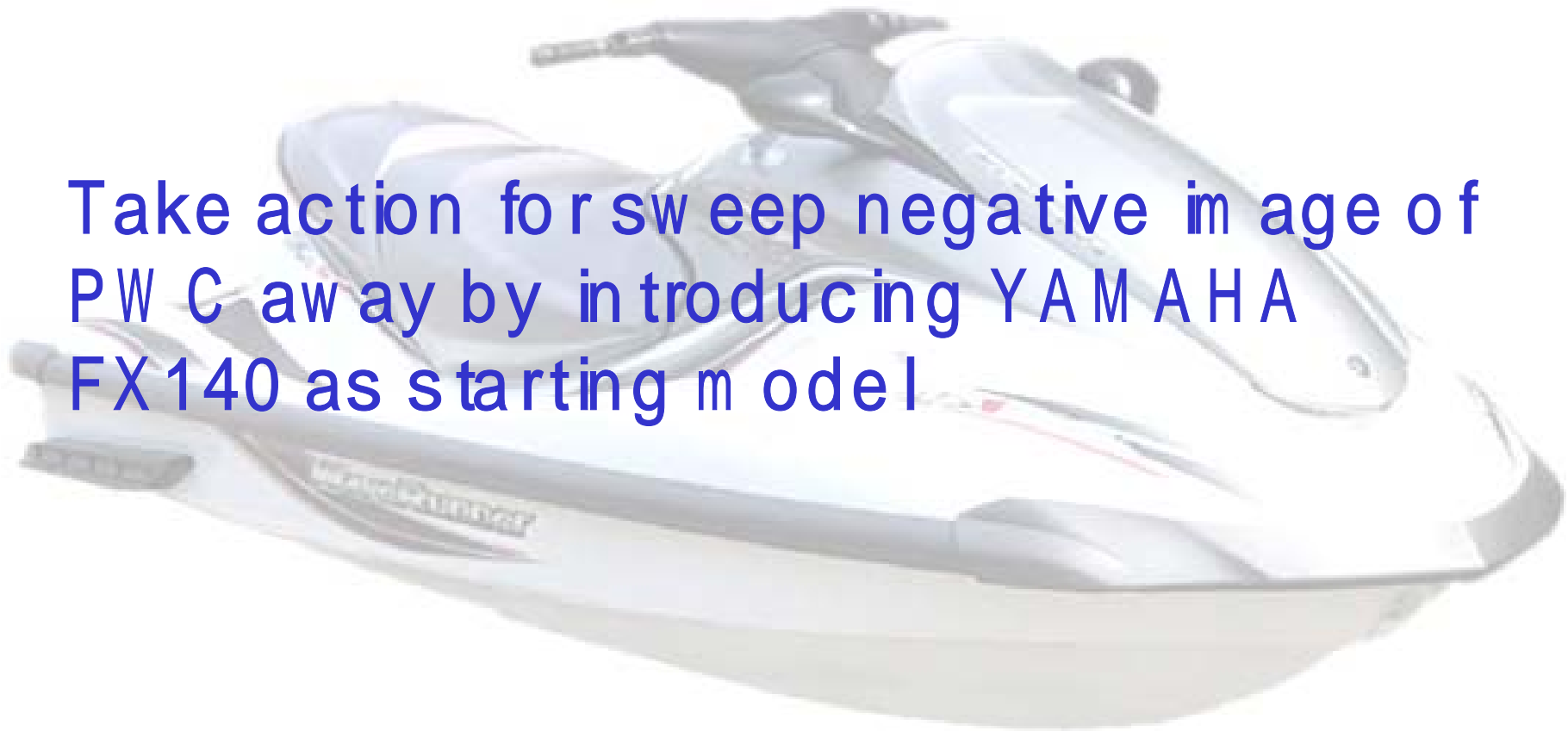

## Product Plan

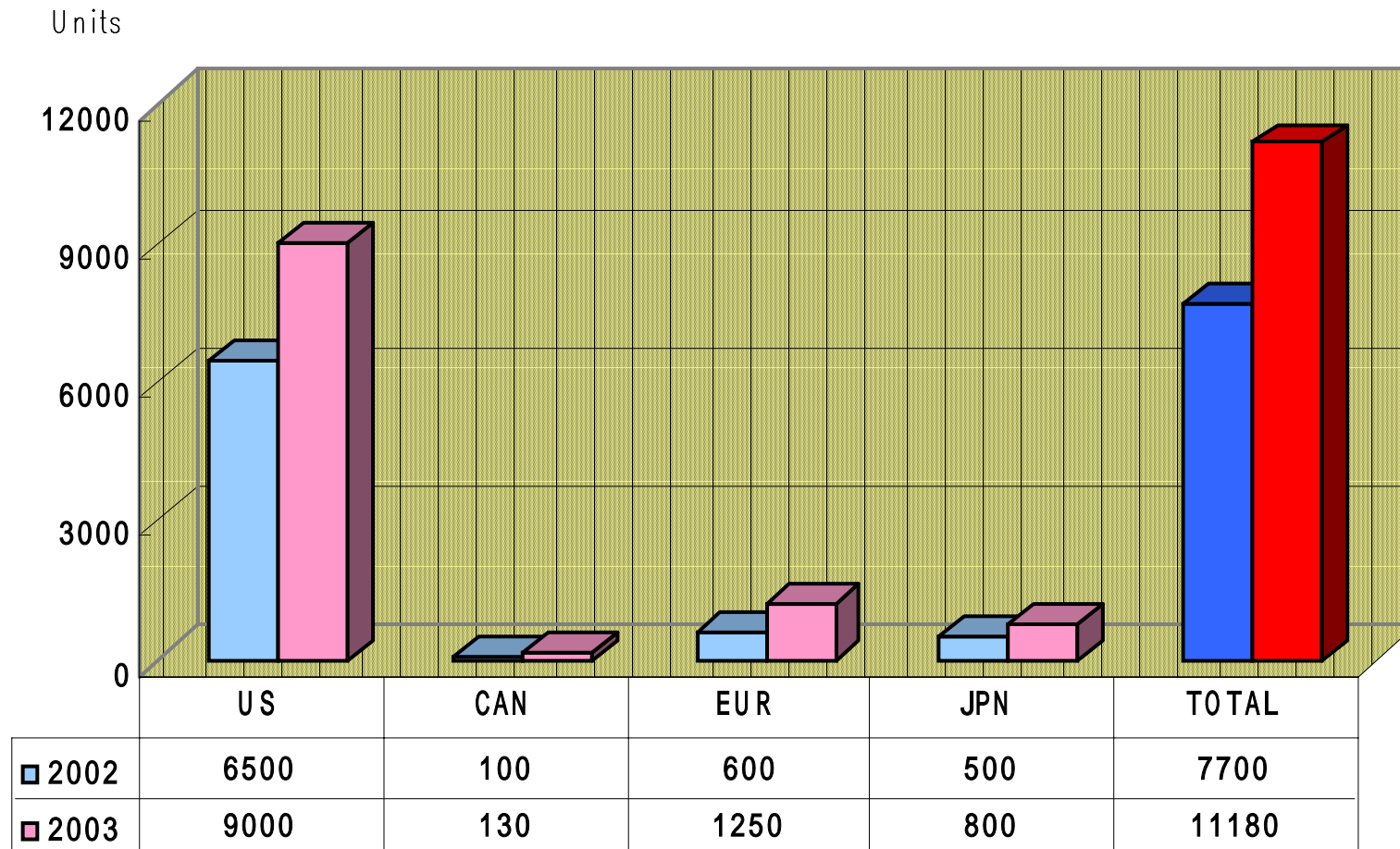

Boat		
Sales Name	WaveRunner FX140	
Model Name	FX1000	
Body Type	F1B	
Engine & Jet Type	F1B	
Length	m (In)	3.34 (131.5)
Width	m (In)	1.23 (48.4)
Height	m (In)	1.16 (45.7)
Dry Weight	Kg (Lbs)	362 (798)
Material	Hull: SMC	Deck: SMC
Capacity	3 person or MAX. Kg (Lbs)	240 (529)
Max. Output (Catalog)	kw (ps)/ rpm	103.0 (140) / 10,000
Max. Output (JCI/EPA)	kw (ps)/ rpm	95.6 (130) / 10,000
Max. Fuel Consumption	Liter/Hrs (Gal/Hrs)	44.0 (11.6)
Full Throttle Cruising Hour	Hrs	1.56

Engine		
Engine Type	4 Stroke L4	
Engine Weight	Kg (lbs)	105 (231.5)
Valve Type	DOHC 5 Valve	
Cooling System	Water-Cooled	
Displacement	cc (cubic in)	998 (60.9)
Starting System	Electric Starter	
Bore $\bar{\text{r}}$ Stroke	mm	74 $\bar{\text{r}}$ 58
Generation System	Flywheel Magneto	
Compression Ratio	11.4 :1	
Generator Output	12V - (A / rpm)	(15 $\bar{\text{r}}$ 6,000)
Fuel Supply System	EFI	
Ignition System	TCI	
Ignition Timing	$^{\circ}$ BTDC	31
Lubrication System	Dry Sump	
Total Oil Capacity	Liter (Gal)	5.0 (1.3)
Battery Capacity	V - AH	12 - 19
Exhaust System	Wet Exhaust	
Gear Ratio	19:28	



Drive Unit		
Propulsion System	Jet Pump	
Jet Pump Weight	Kg (lbs)	18 (39.9)
Jet Pump Type	Axial Flow Single Stage with Reverse	
Jet Pump Diameter	mm	55
Impeller Rotation	Counter Clockwise (Rear View)	
Impeller Blade/Pitch	3 blade 16.3 degree (68N)	
Transmission	Direct Drive from Engine	
Shift Operation	F - R	
Trim Adjust System	QSTS	
Trim Adjust Angle	5 Position (degree)	(-10, -5, 0, 5, 10)
Nozzle Trim Angle	degree	5
Nozzle Steering Angle	degree	24.0 ± 1
Fuel Oil		
Fuel	Unleaded Regular Gasoline	
Recommended Oil	SAE 10W -30	API SE, SF, SG, SH, SJ
Fuel Tank Capacity Incl. Reserve	Liter (Gal)	70.0 (18.5)
Other	Liter (Gal)	100 (26.4)

# Performance



- **Performance Curve**
- **Performance Chart**
- **Sound**

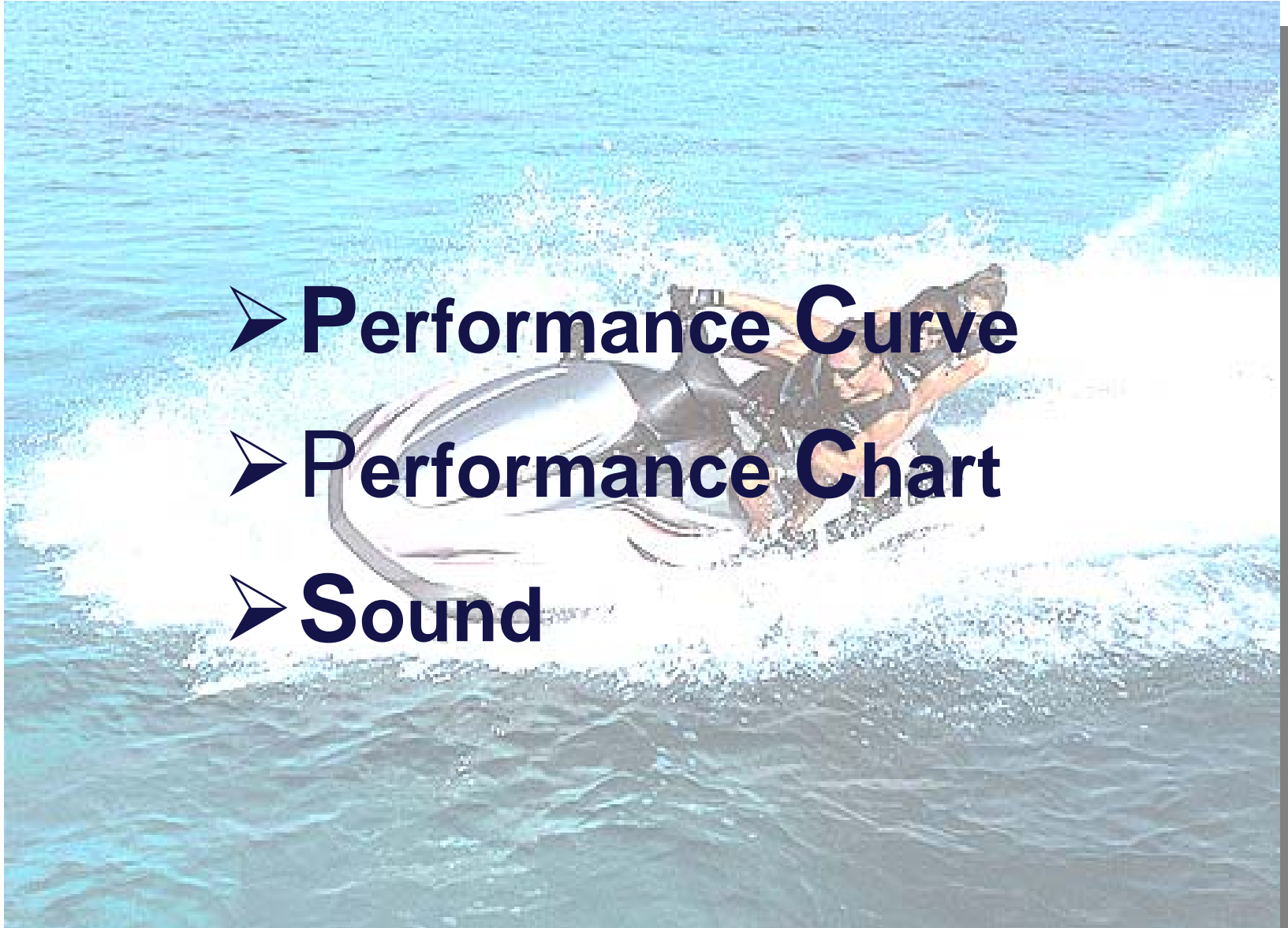

# Performance Chart

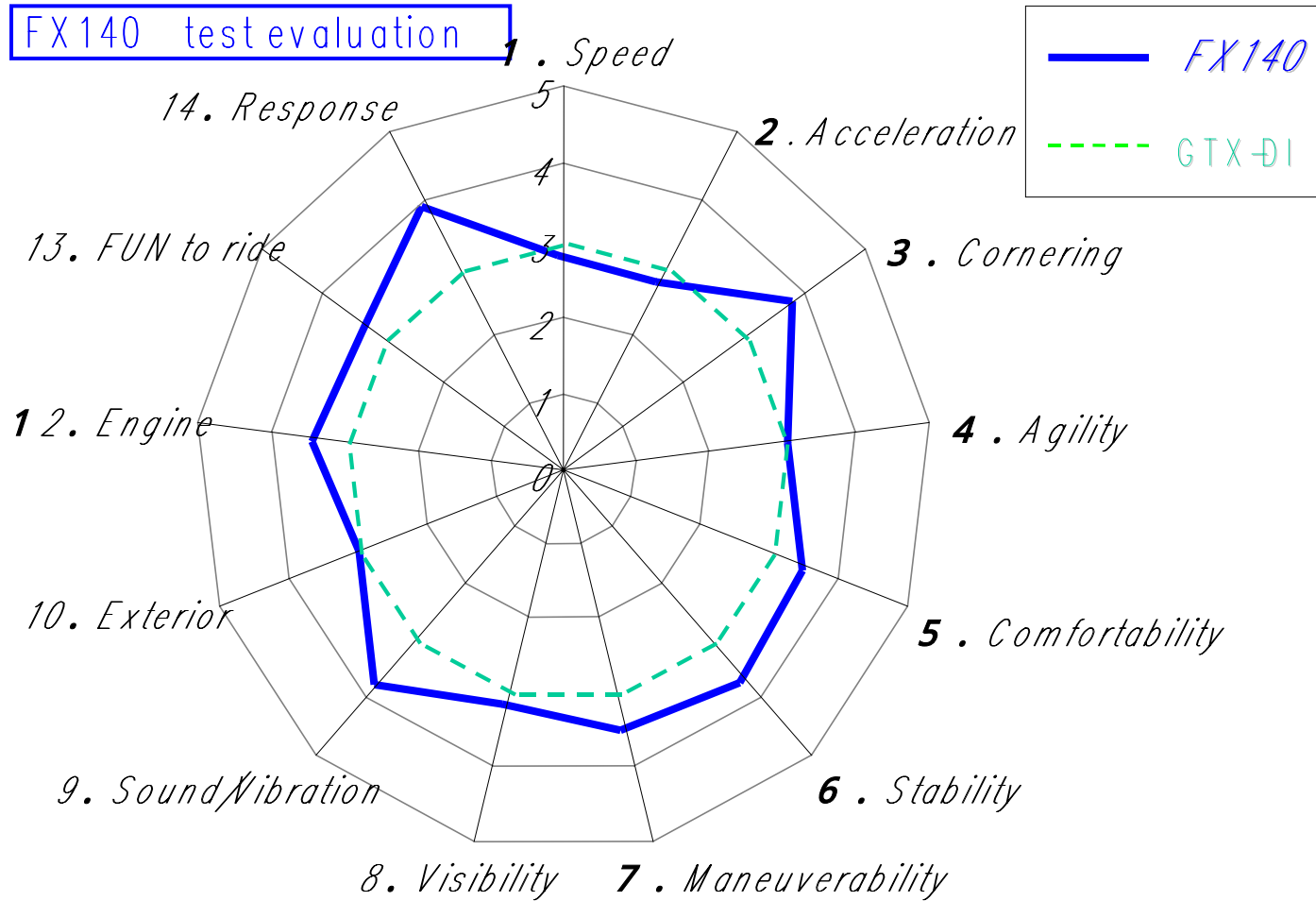

# Features & Benefits



## ➤ Features and Benefits

**Engine**

**Hull**

**Electrical**



# Features & Benefits



## Specifications

Length/Width/Height : 3.34m/1.23m/1.16m  
Capacity : 3 persons  
Dry Weight : 362kg

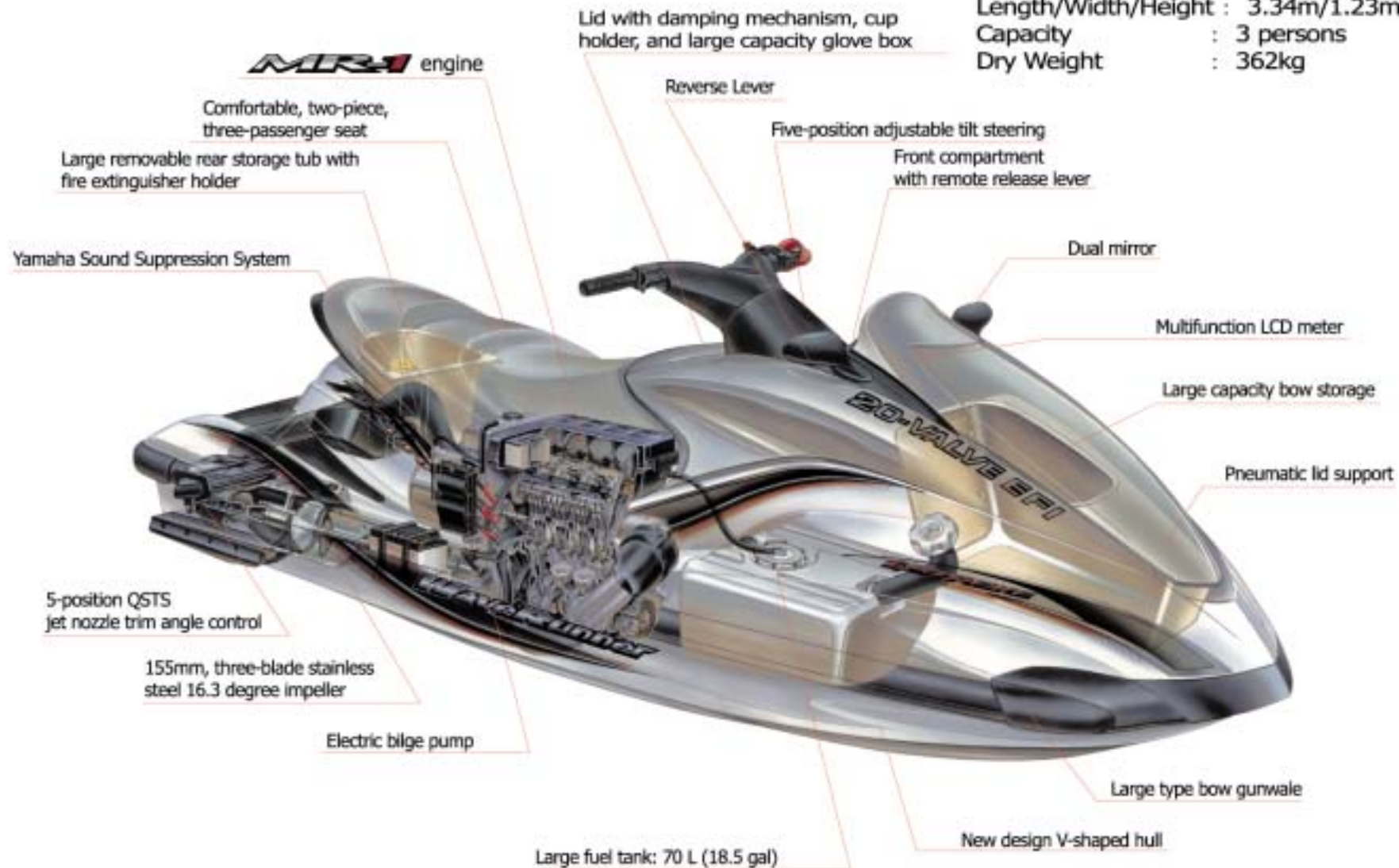

# Engine



**MR4**

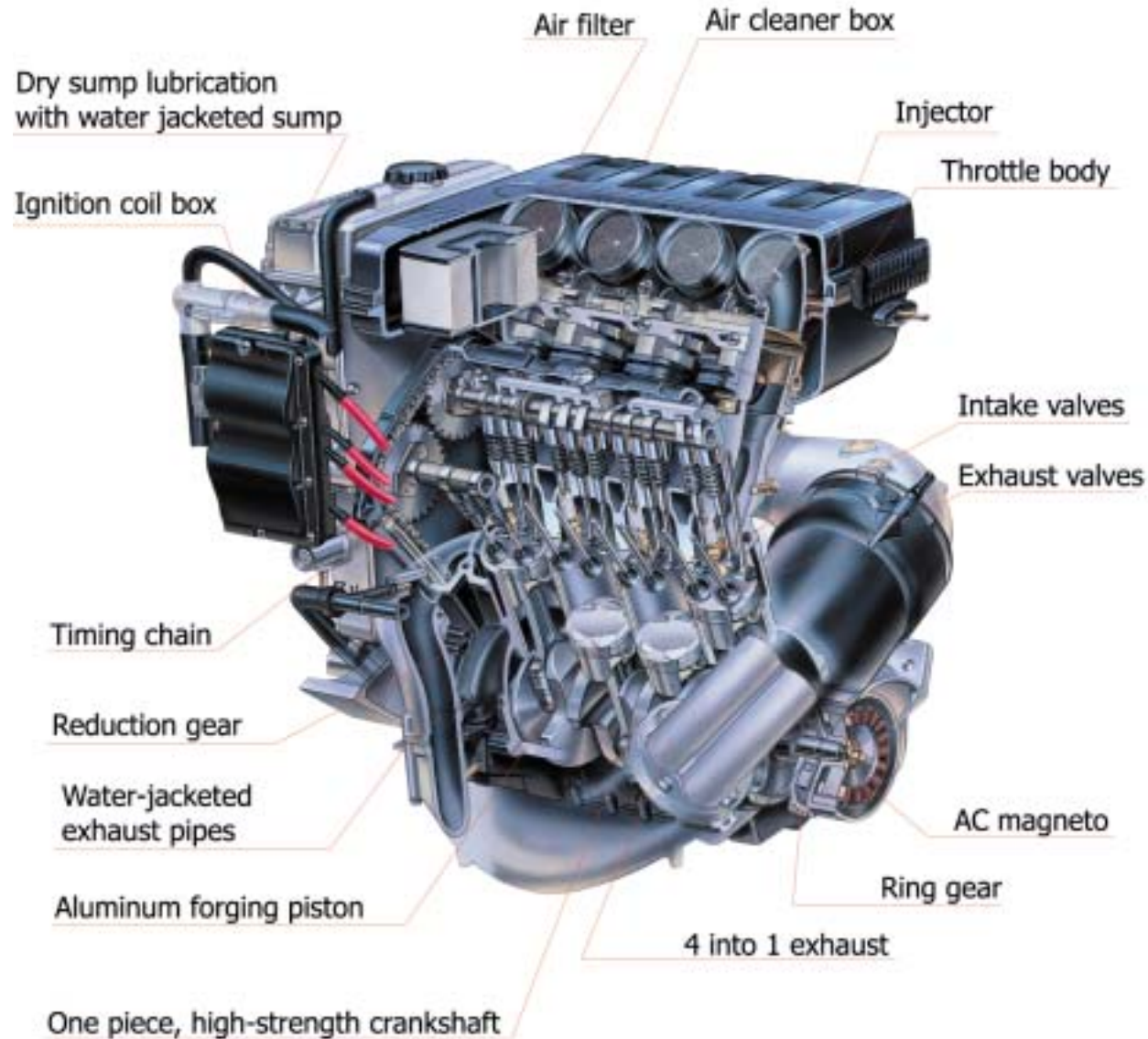

# Cylinder Head and Valve Train



- 3 intake valve and 2 exhaust valves
- Double overhead cam shafts
- Cam position sensor

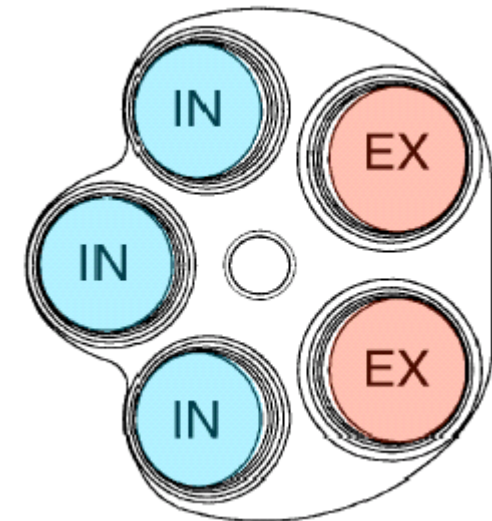
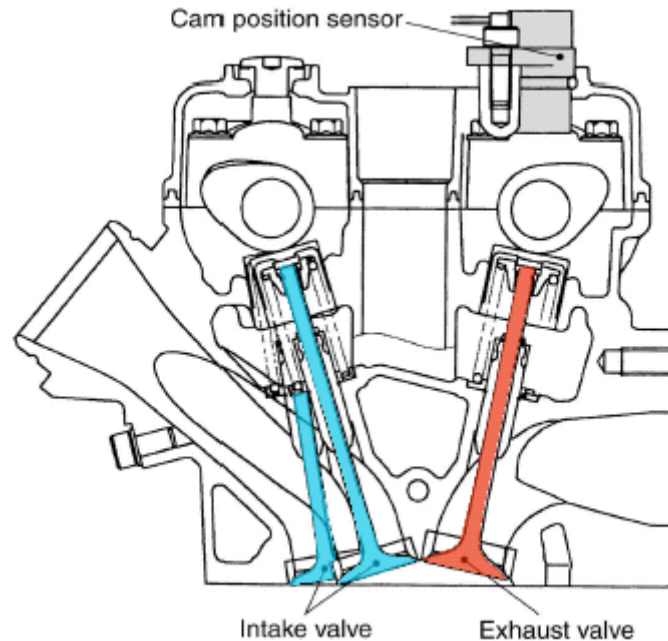
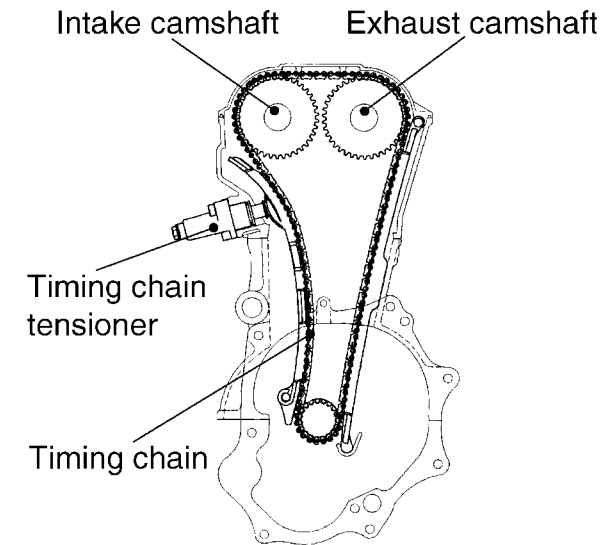

# Crankshaft and Pistons



- Lightweight piston, piston pin and connecting rod
- High compression ratio realized with piston head shape

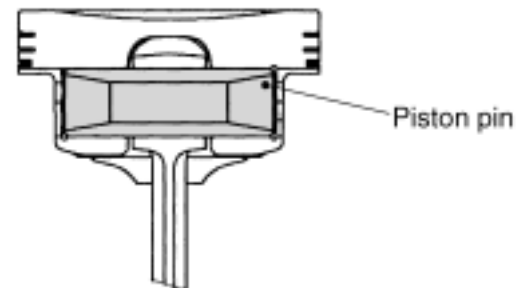
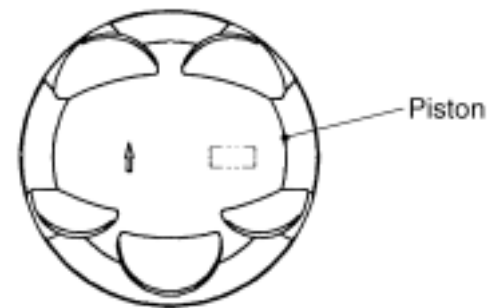
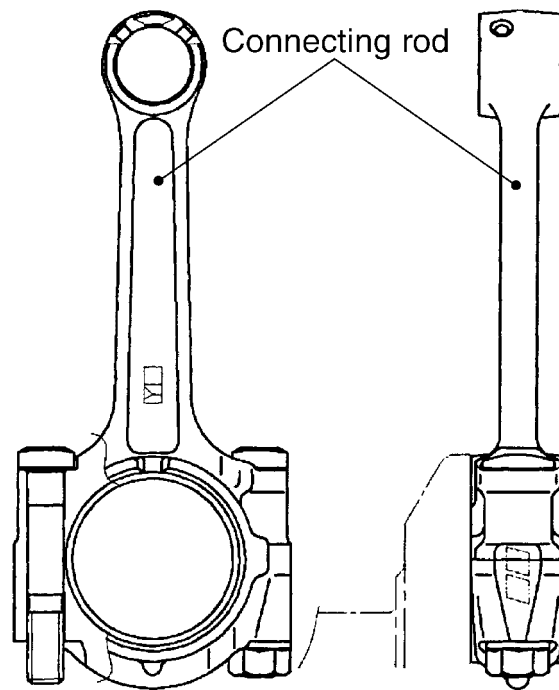
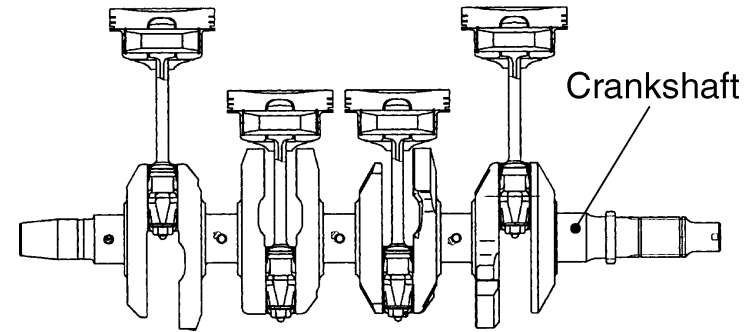



# Lubrication

- Dry sump engine oil system
- Engine oil tank capacity: 2.8 liter
- Liquid-cooled reservoir tank

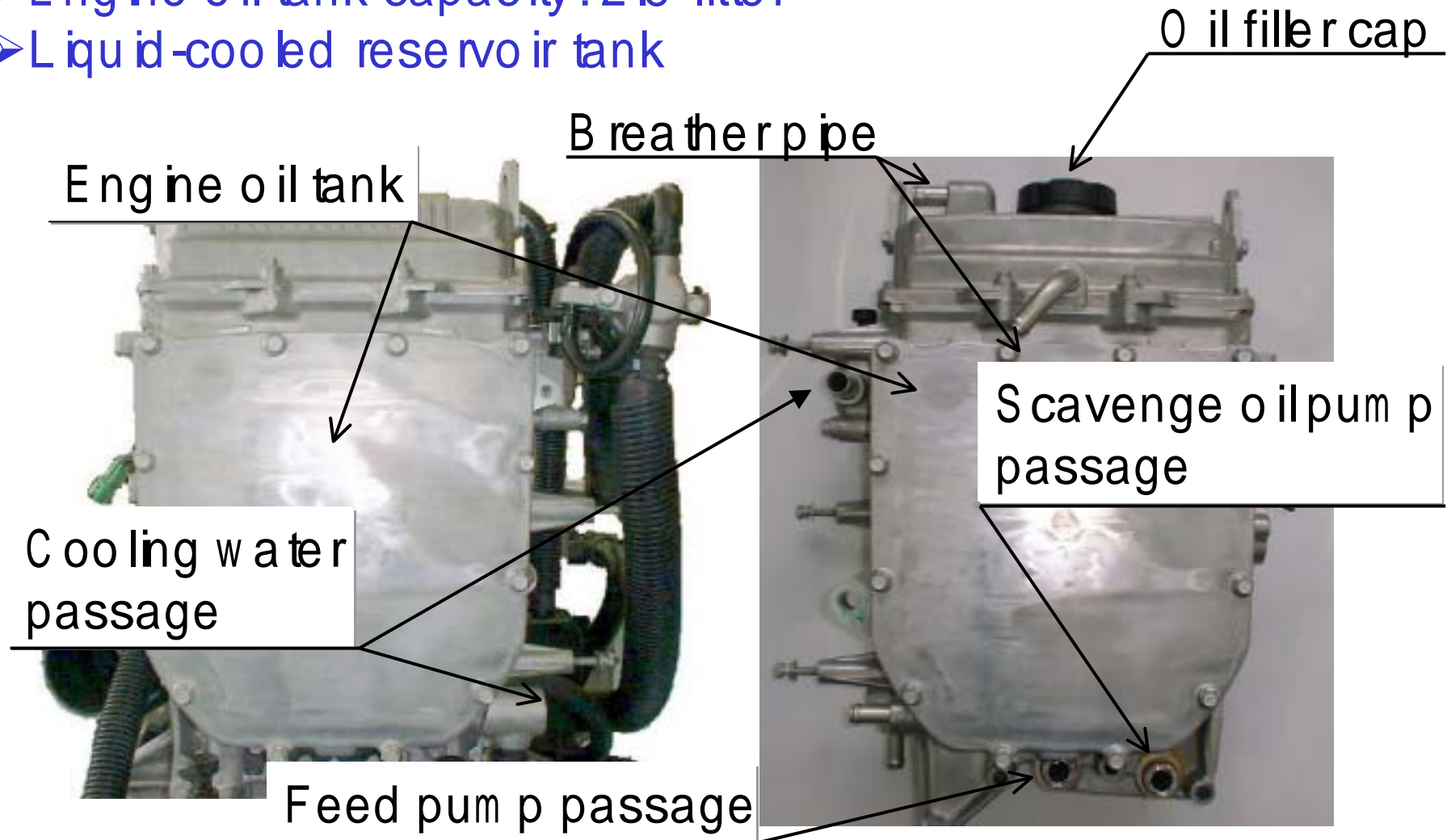

- The engine oil pump is driven by the same axle as the scavenge oil pump and feed oil pump.

Scavenge Oil pump

Feed Oil pump

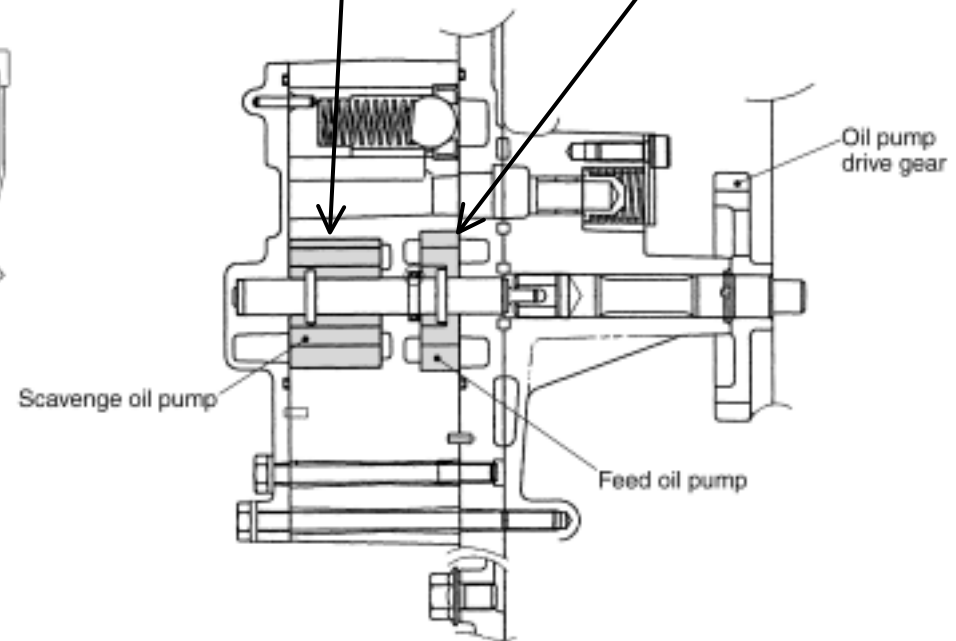
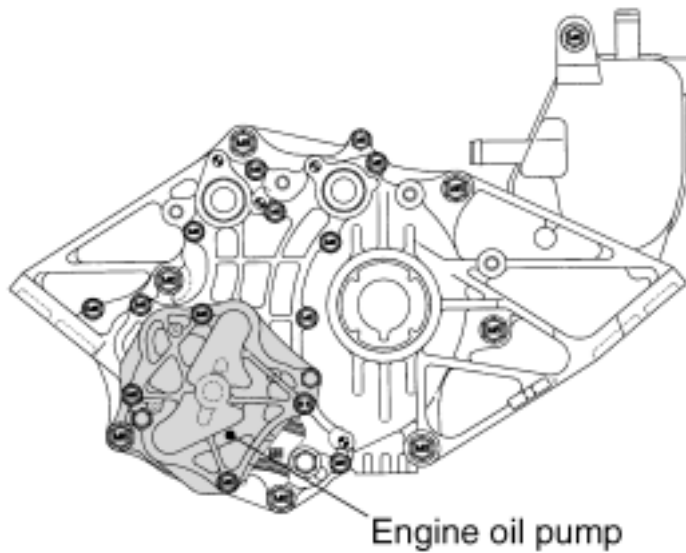

# Oil flow diagram

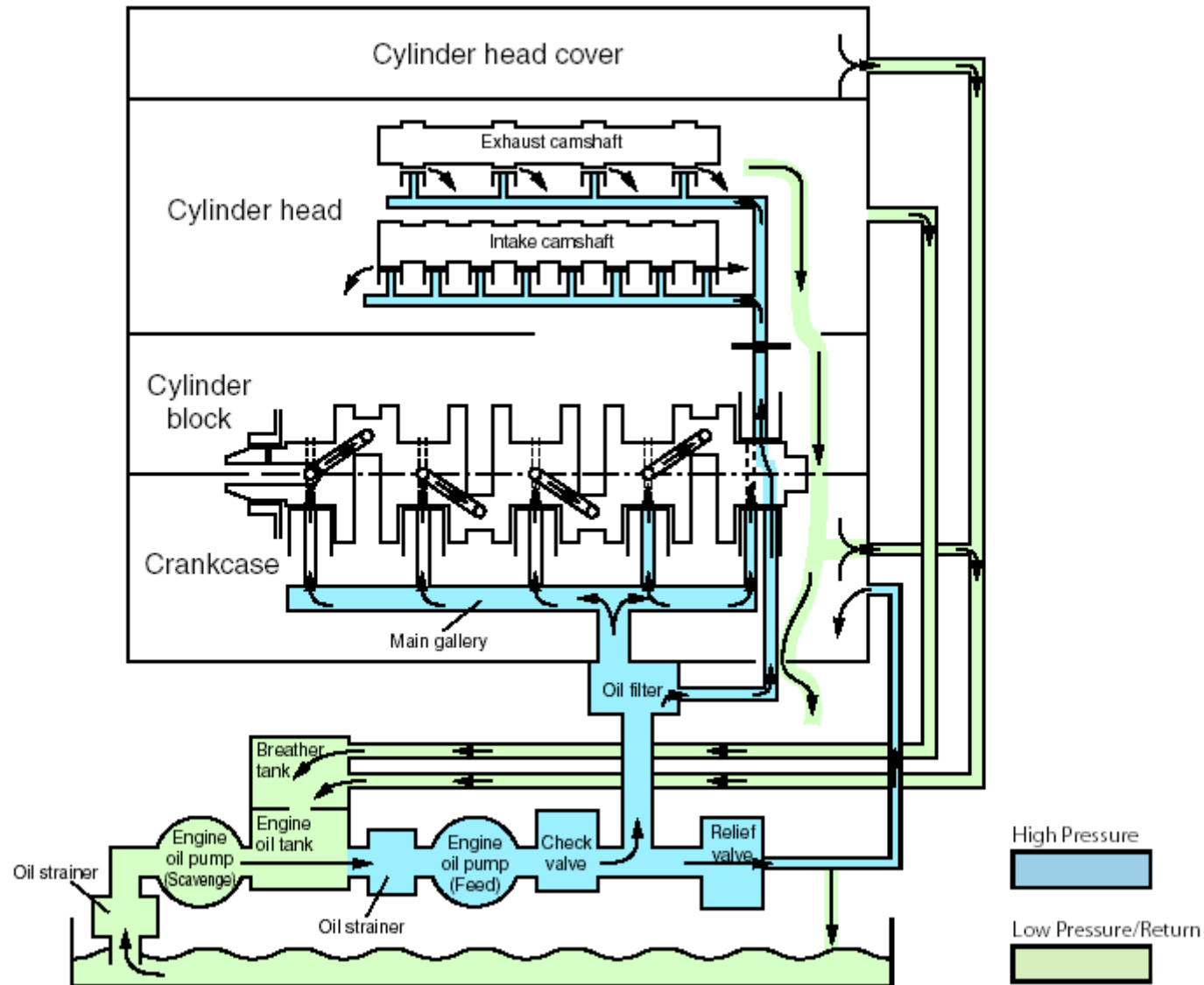

## Mechanism of Oil Overflow Problem

Standard Oil Level with 4.3 liter included volume inside cylinder block. (Normal Oil Temperature)

Oil Level after doing the instruction of pre-prod. (= **check point after 2 minutes' trolling from cold start**)

Oil Level after refill (Total amount is more than 6 L included volume inside C/B block at this situation)

Oil Level during operation (Hot Oil on Trolling just after WOT)

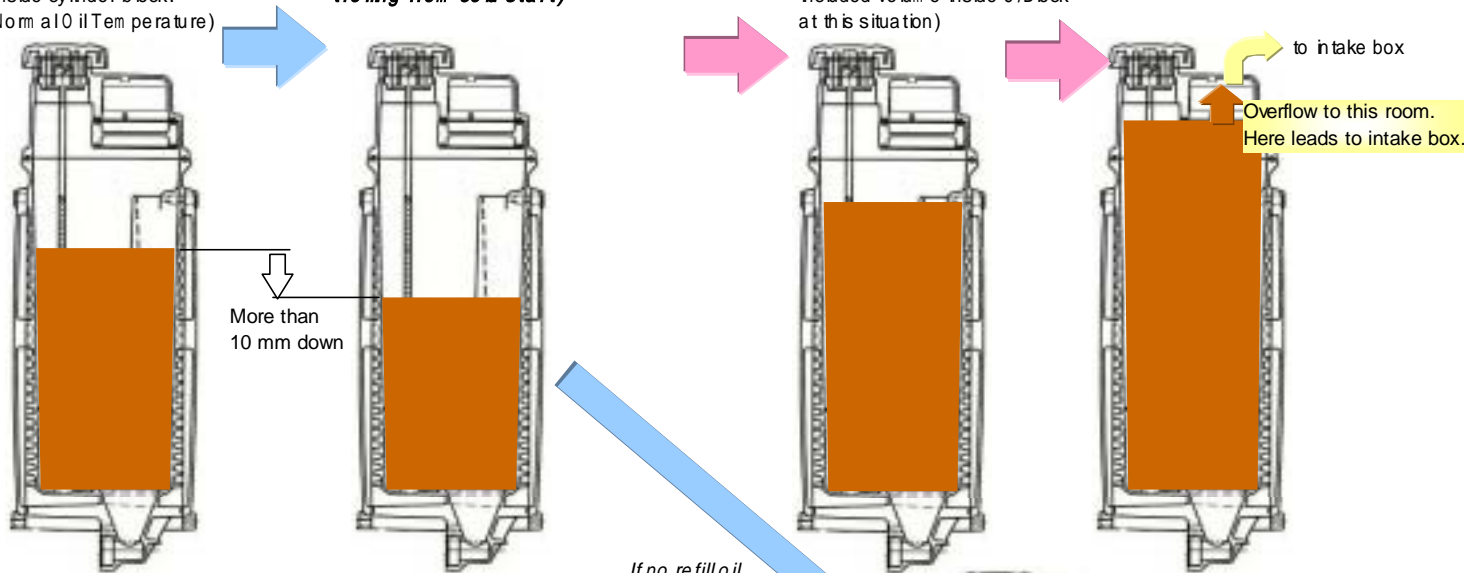

*If no refill oil  
No overflow happen.  
This means that  
instruction was not  
proper.*

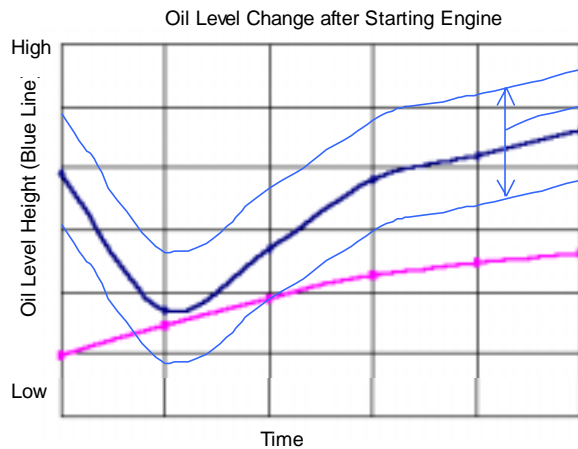

Height varies upon the volume of oil inside cylinder block. Plus, variation depends on how to stop engine due to dry sum p. (ex. Immediate stop after WOT, stop after racing, bng troll, and so on.)





# Cooling system

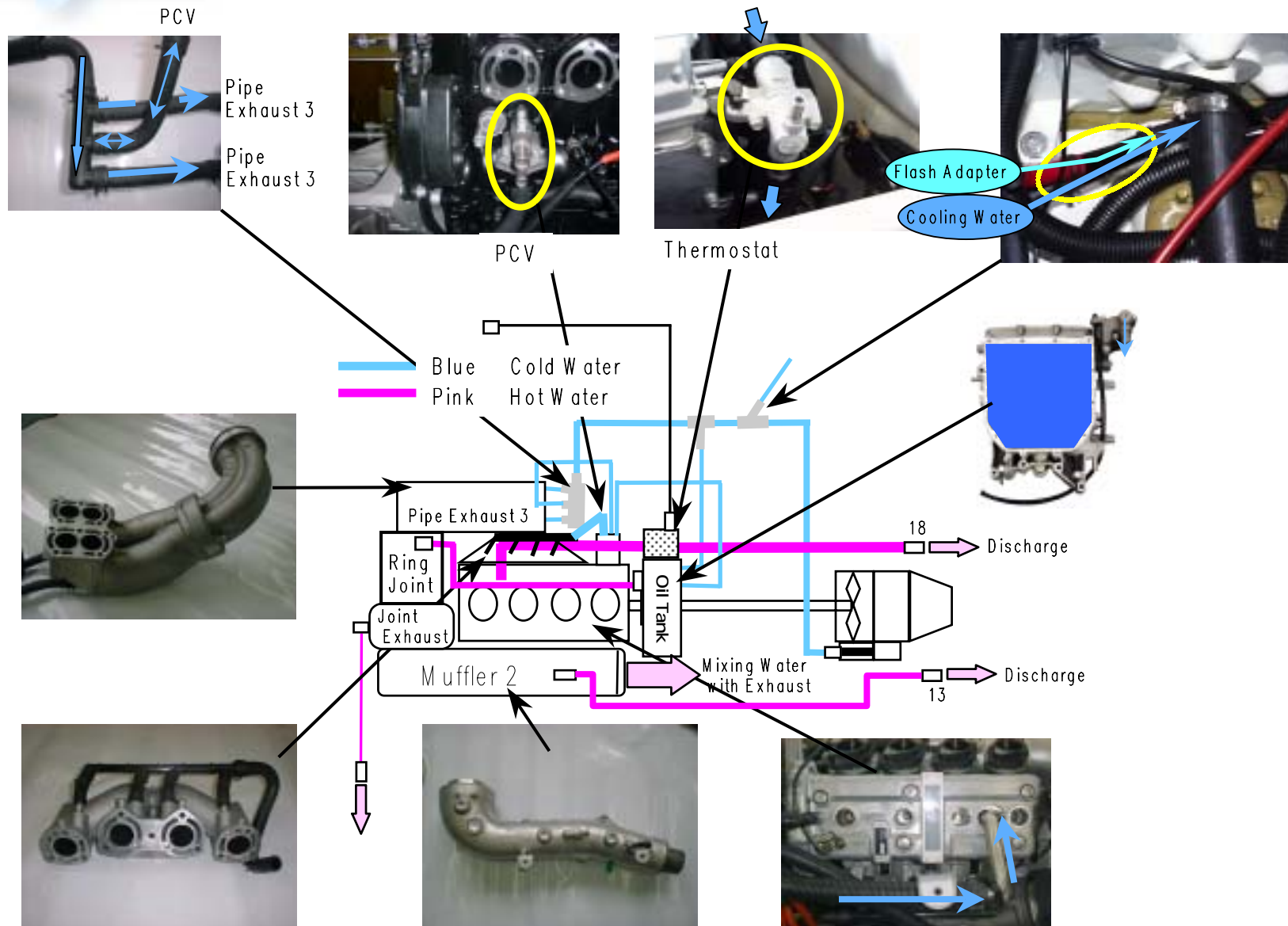

# Intake

- Electrical Fuel Injection
- 4 in-line, independent throttles
- Large air filter box

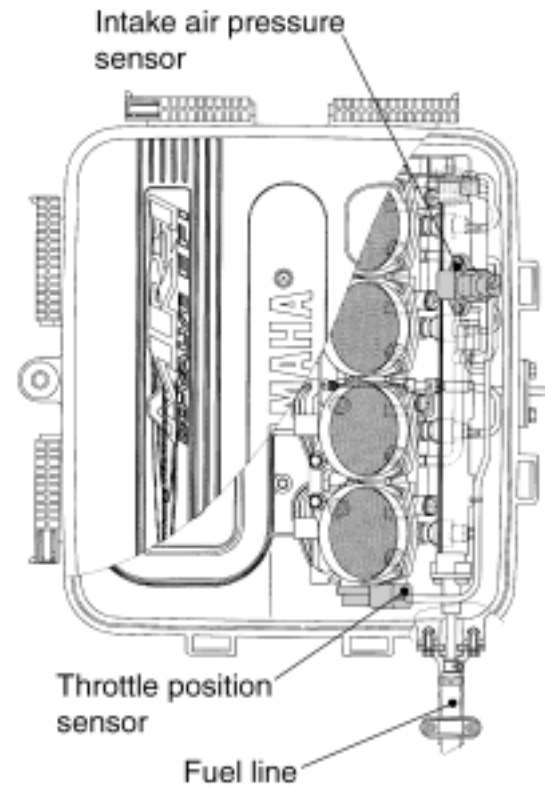
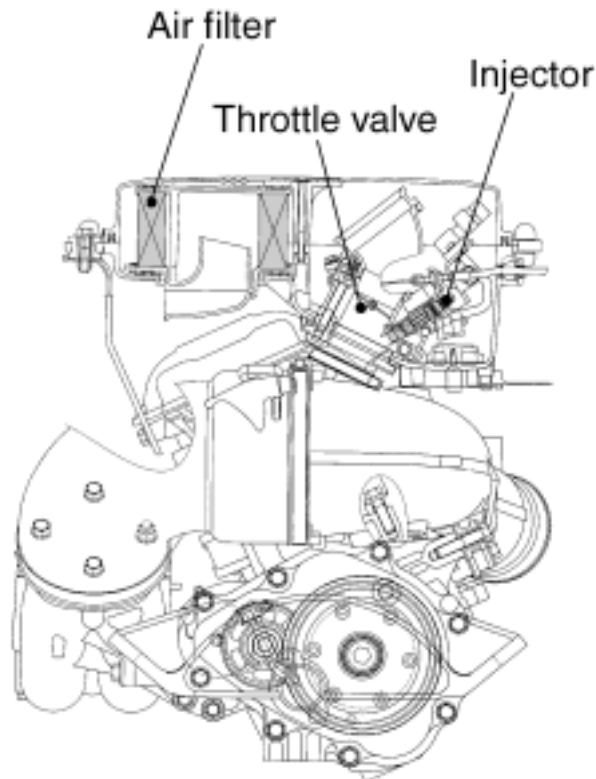
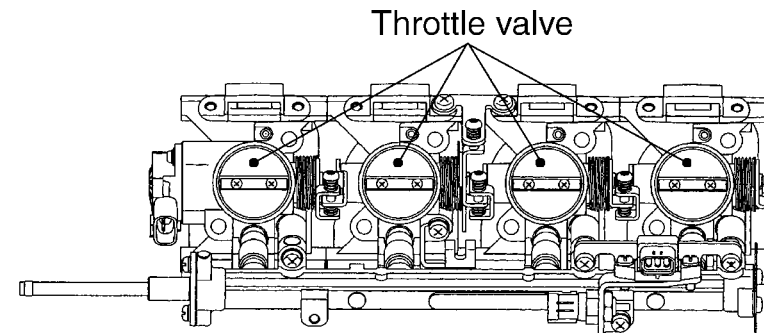

# Fuel Supply



- Installed in fuel tank
- Fuel sender
- No return from the delivery pipe

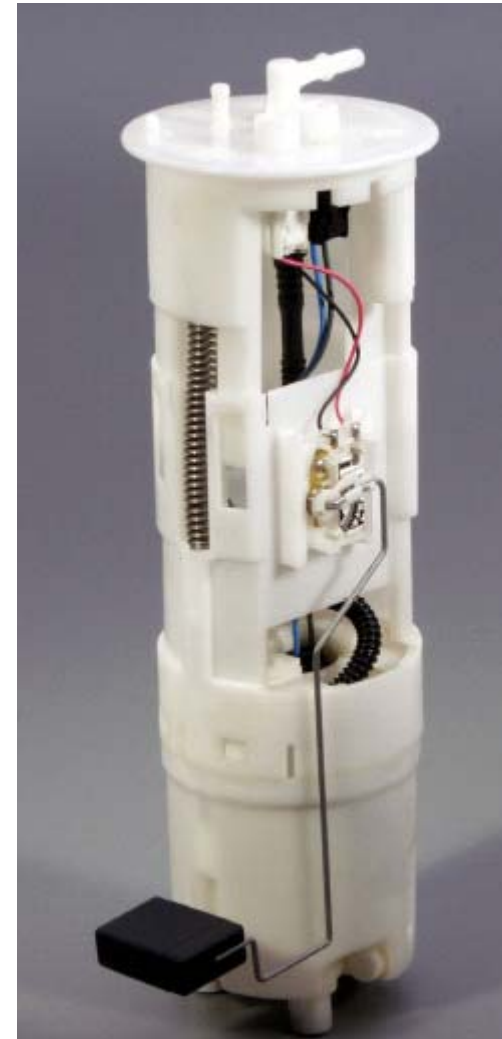
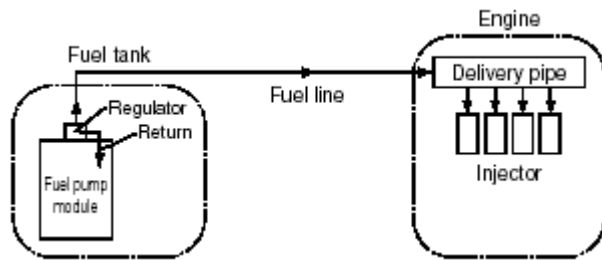
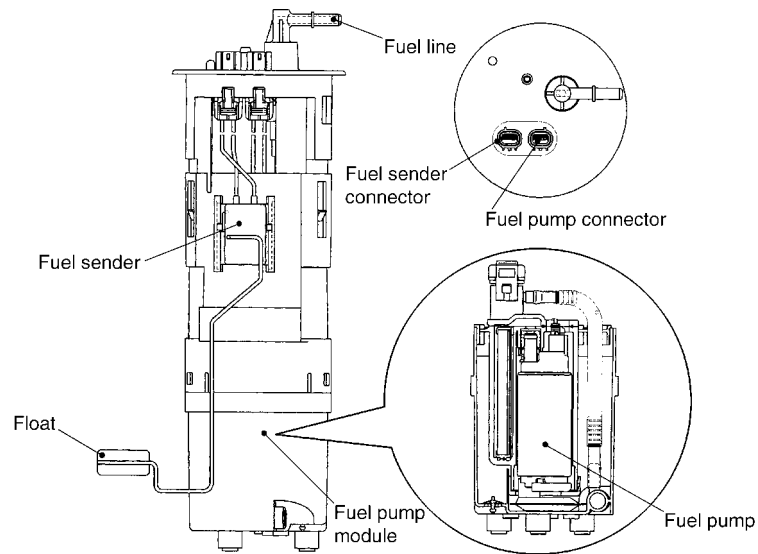



# Fuel Supply



- Installed in fuel tank
- Fuel sender
- No return from the delivery pipe

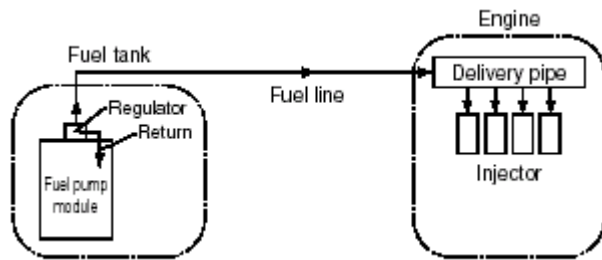
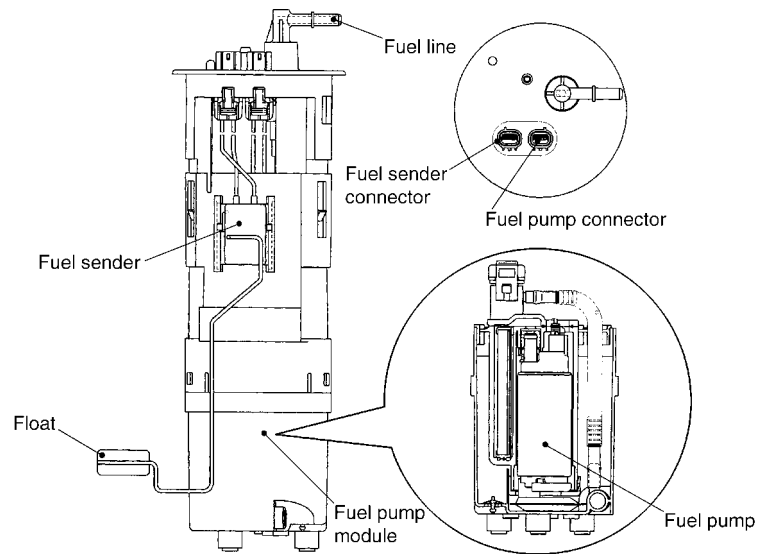

# Exhaust engine



- Each cylinder with equally lengthened exhaust pipes
- Dual pipe structure

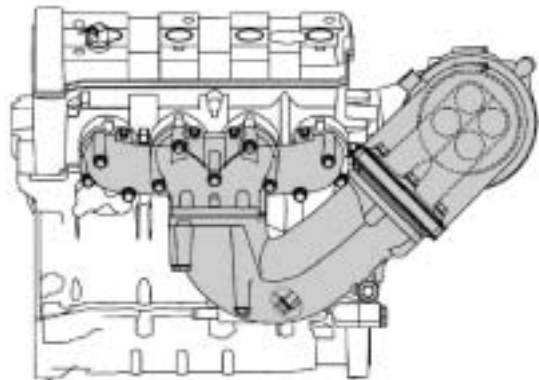

# Propulsion engine



➤ Reduction Gear ratio: 1.47:1



Drive gear



Driven gear

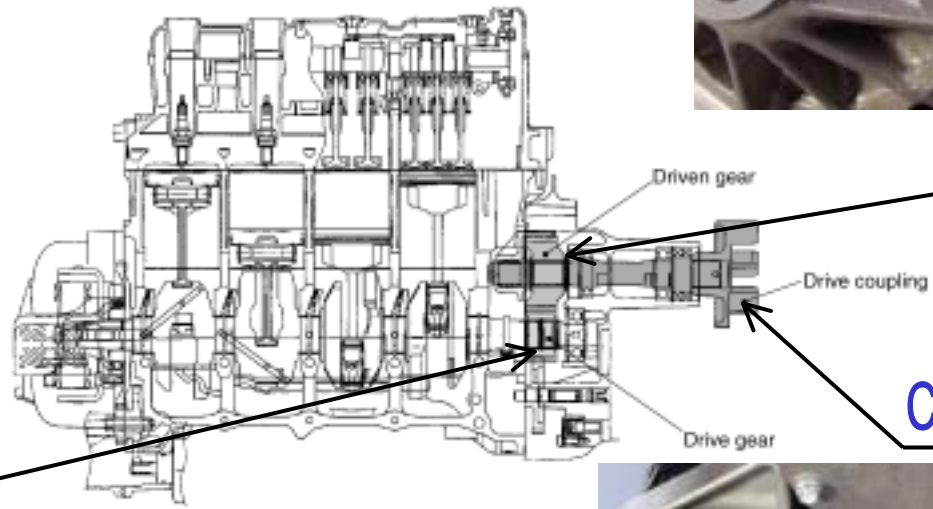

Coupler



# Propulsion



- Big jet pump with large, three-blade stainless steel, impeller with an outer diameter of 155mm
- Five-position QSTS

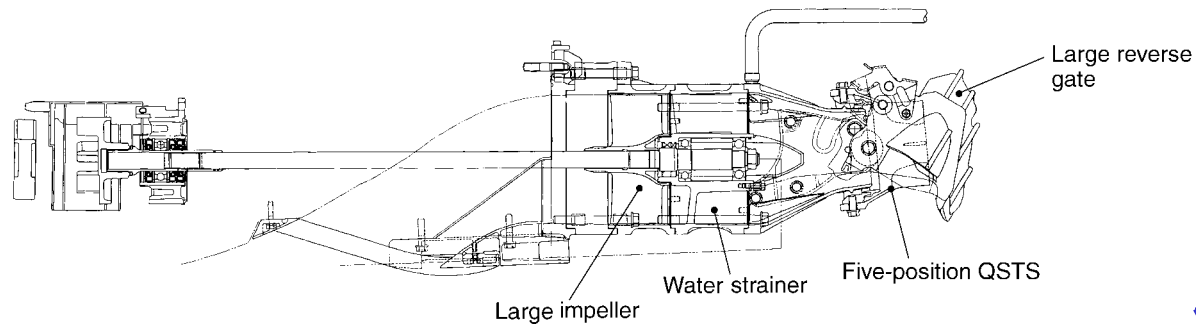

TDE:  
Thrust Directional Enhancer

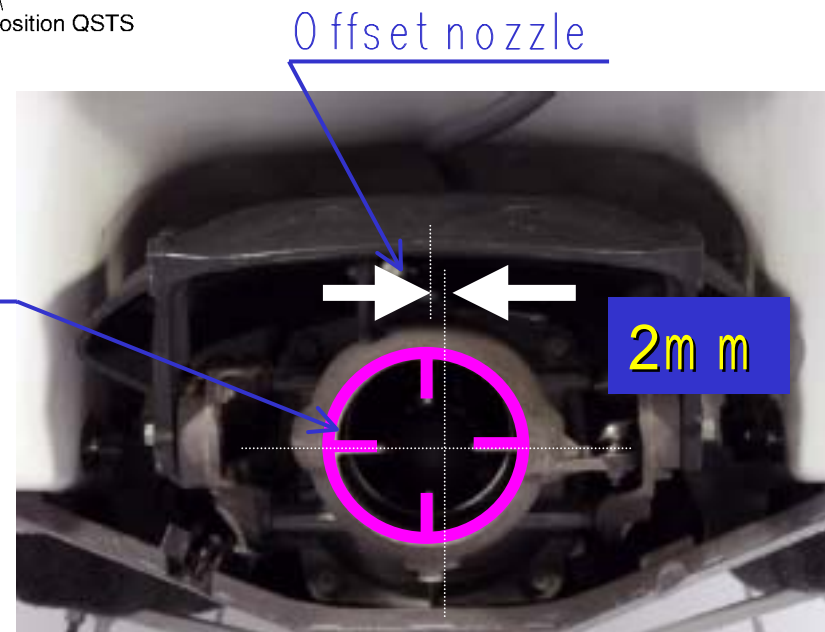

# Hull



- V-shaped hull
- Foam flotation in inner hull
- New sponson

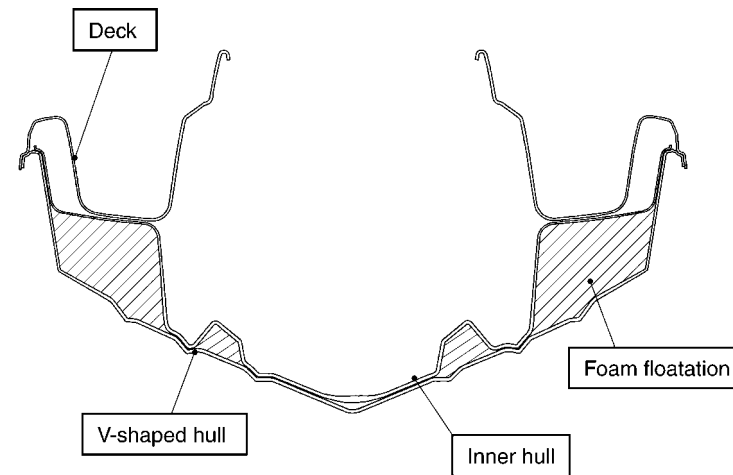
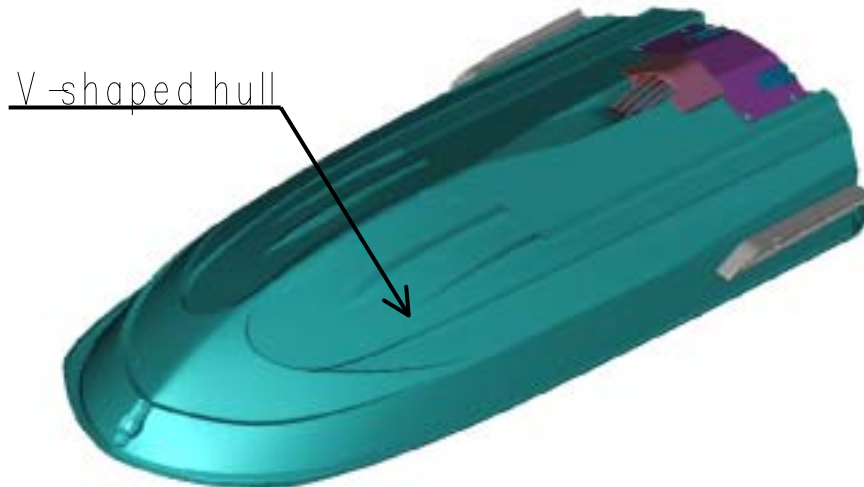

# Deck



Front compartment with remote release lever



Stylish big front bumper



Large glove box with drink holder



Pneumatic lid support



Tow hook



Two-piece, three-passenger seat



Large removable rear storage tub

# Controls



Five-position  
Adjustable tilt steering

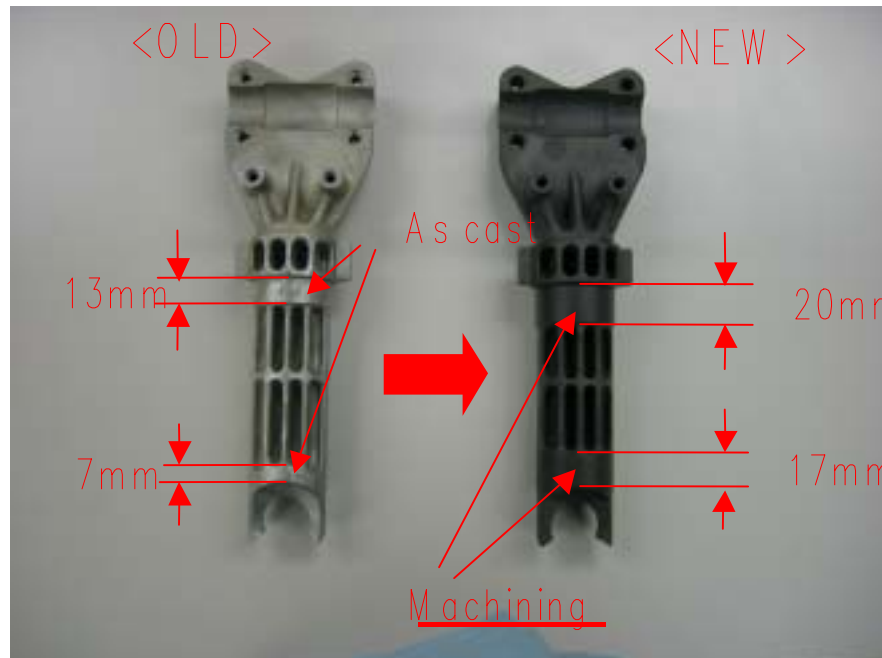
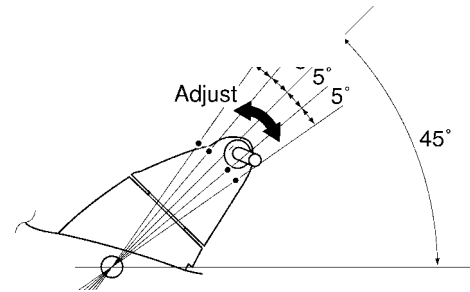

## Controls

- Q STS
- Reverse lever





# Electrical



- Multifunction LCD meter
- Electric bilge pump
- Y.D.I.S.
- Slant detection switch

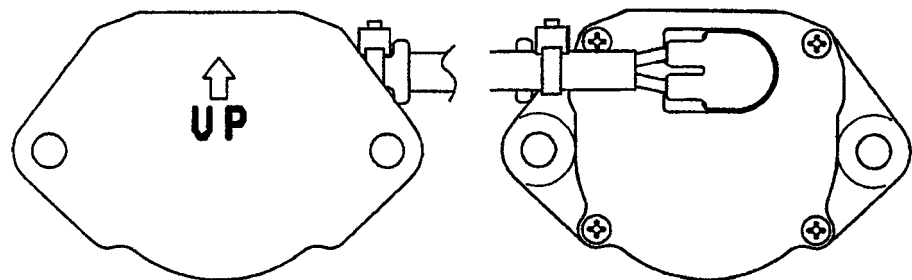
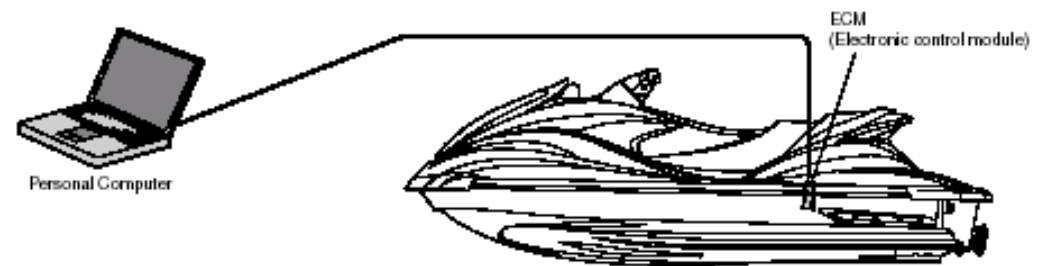

# Instruments



- Newly designed multifunction meter
- Meter panel with dual mode mile or kilometer
- Diagnostic code display

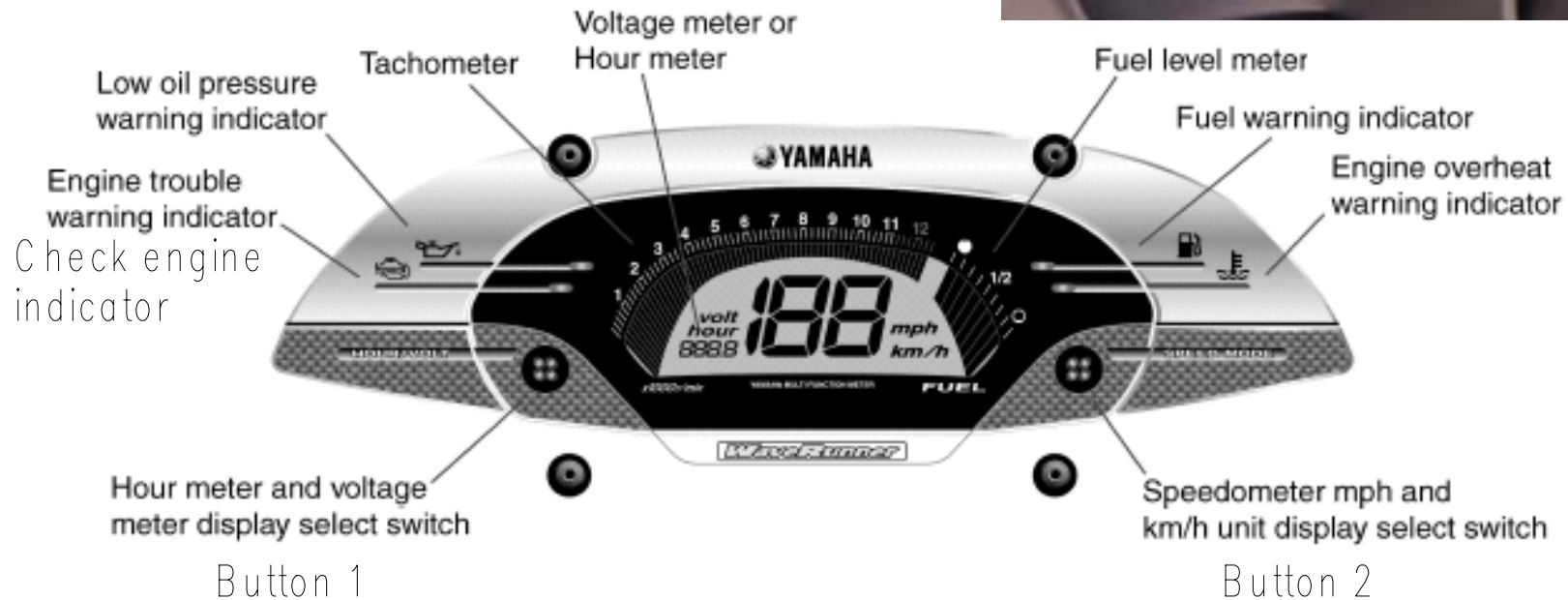



Diagnostic Code	
Display Code	Item
01	Normal
13	Pulser coil error
15	Thermal sensor
18	Throttle sensor
19	Battery voltage
23	Intake air sensor
24	Cam angle sensor
29	Intake air pressure sensor
33	Cooling control
39	Oil pressure
47	Rollover detection switch
48	Communication

# Electric Bilge Pump



Actual drain capacity : 19 Litter/minutes  
(at FX140)

Pump Catalogue Data



## (Reference data)

Rated Performance

- Rated Voltage : DC12V
- Fuse size : 2.5A
- Rated Pump Capacity : 31Litters/minutes

·Pump Capacity (Reference Data)/ Hose Height

Fixed Condition :DC14V ,Hose Length:0.5m

	Height:0.25m	Height:0.5m	Height:0.75m
Pump Capacity (Litter)	29.5	27.5	25.1
Current (A)	2.3	2.3	2.3

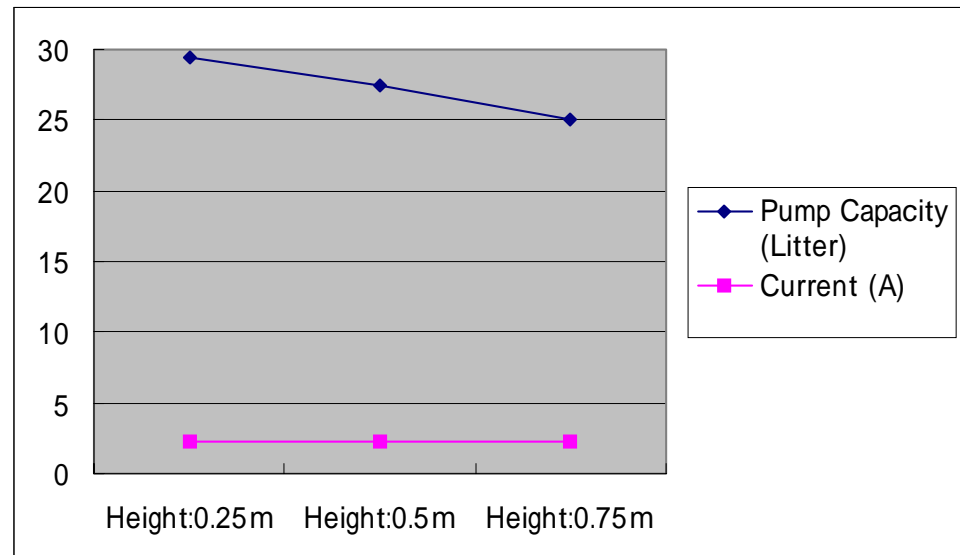

# Diagnostics

## YDS

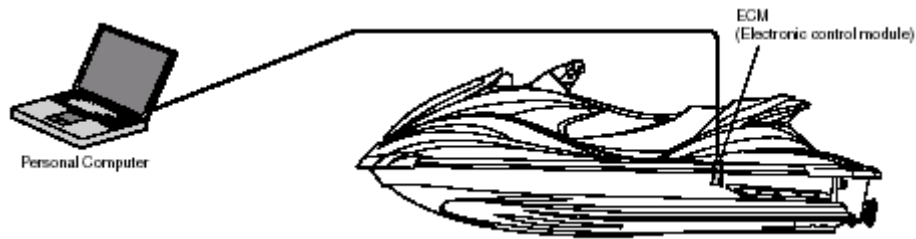

RS232C terminal



### YDS functions

Diagnosis	— To find malfunctioning parts and controls quickly
Diagnosis record	— To check the engine's record of malfunctions.
Engine monitor	— To find malfunctioning parts quickly. You can monitor rpm, ignition timing etc.
Stationary test	— Without engine run, without engine disassembling, you can check ignition coil, fuel injector, fuel pump functions.
Active test	— By stop ignition each cylinder, check which cylinder is malfunctioning.
Operation hours	— Indicate how many hours the engine run in each rpm range.
Data logger	— To check engine situation which is recorded and stored in ECU, after engine stopped or failed.
ECU Information	— ECU's parts number will be indicated.
Identification Watercraft and Outboards	— To identify which system is under operation, picture of OM or Watercraft will be indicated on up left corner of PC screen.

# Slant Detection Switch

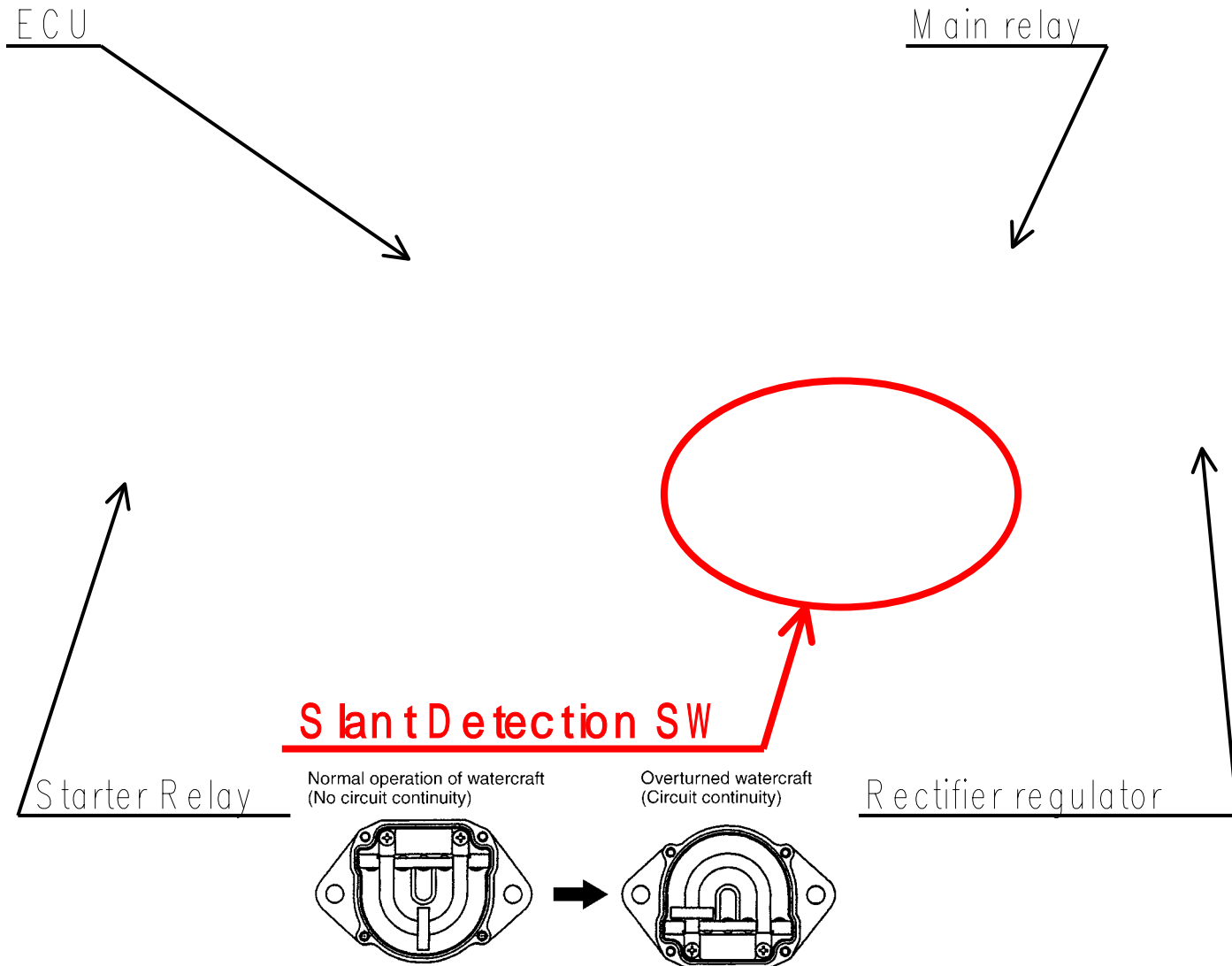

- 
- Sensor & Sw itches
  - ECM
  - Fuel Injection & Ign ition Tim ing
  - Overheat Mode
  - Oil Pressure mode

# Sensor & Swich

## Technical Tips

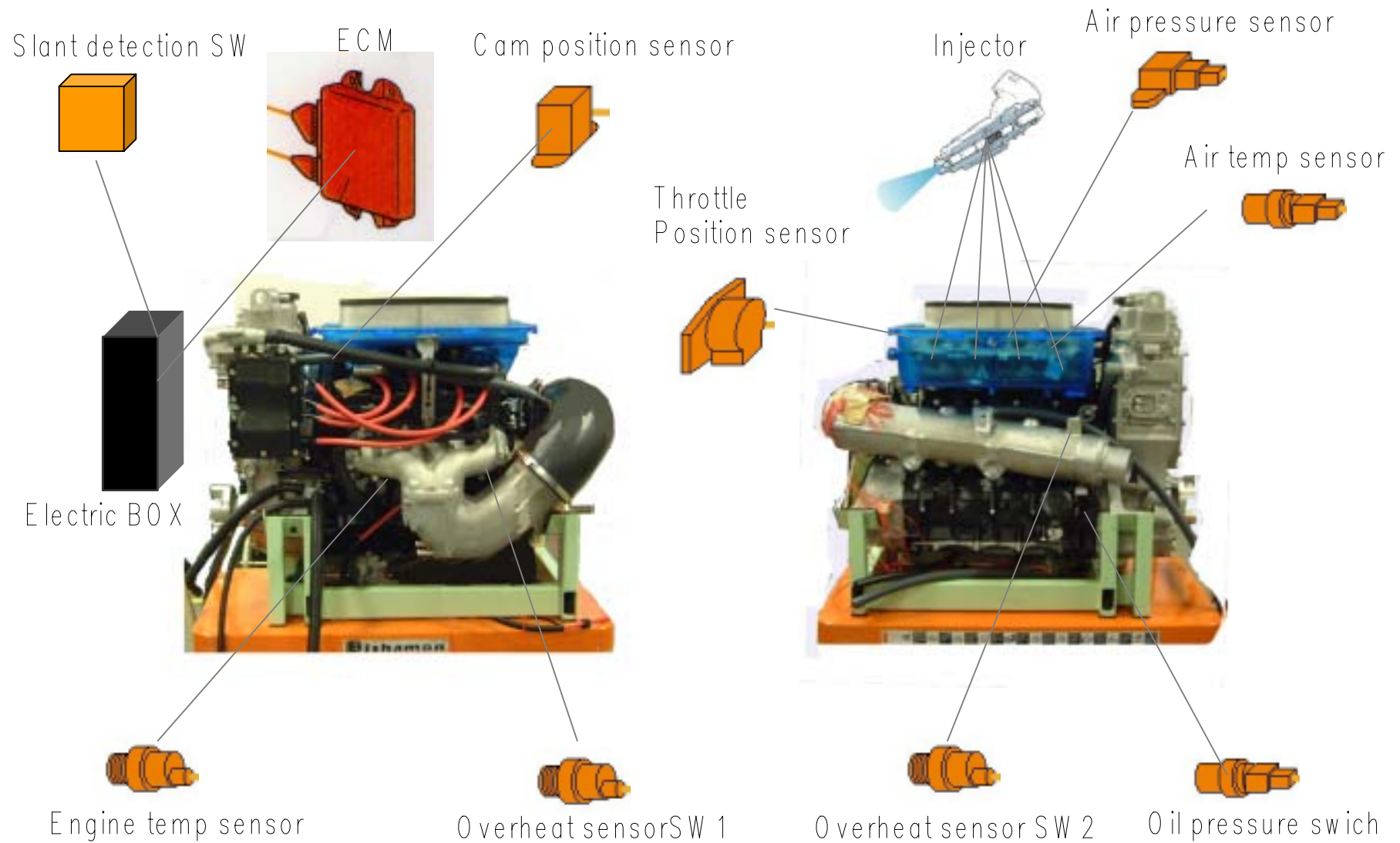





# Electronic Control Module (ECM)

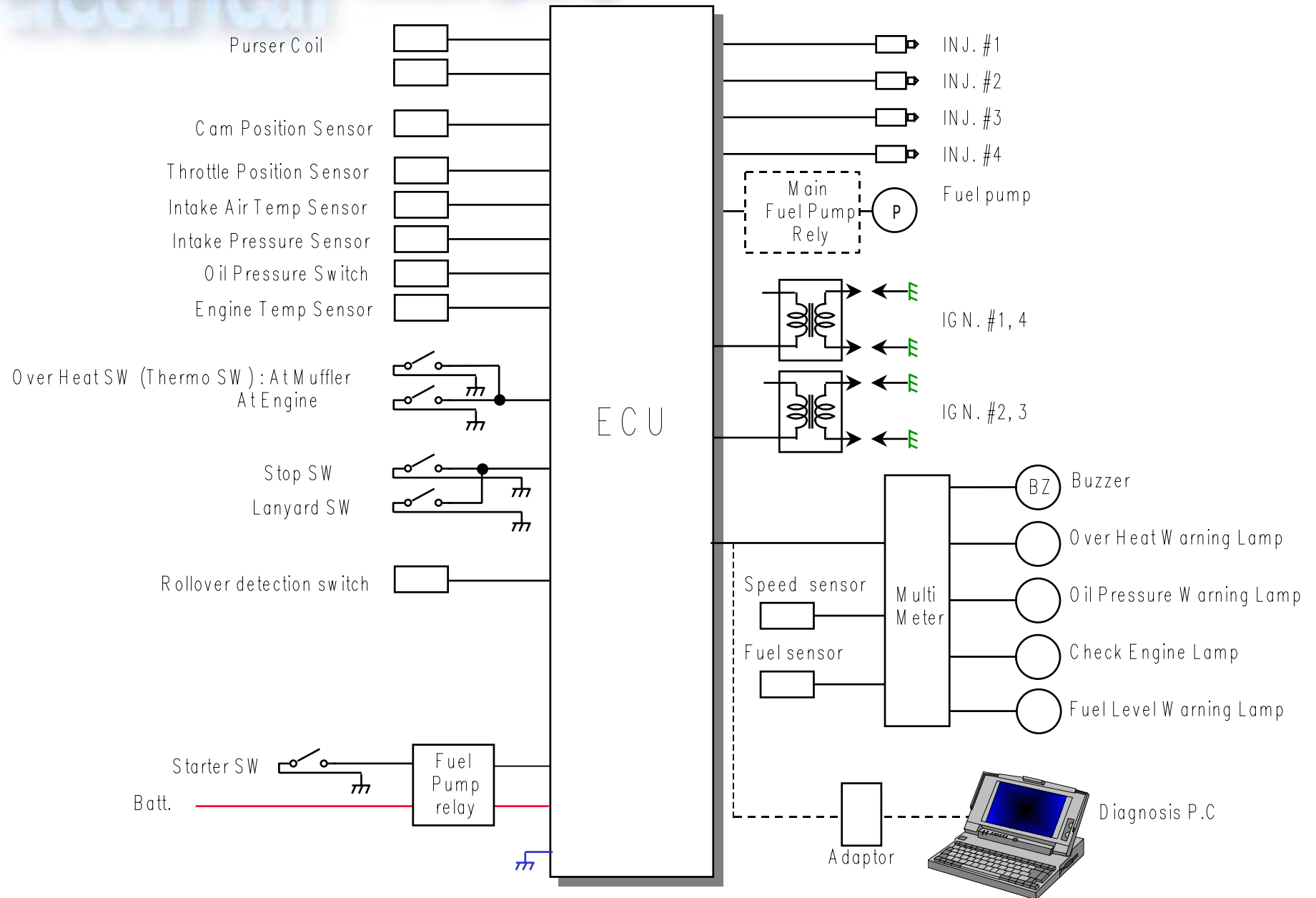

- INJECTION time(10000rpm)
- INJECTION time(1600rpm)
- EX VALVE timing
- SCAVENGING VALVE timing
- IGNITION TIMING

## • Sequential (NORMAL)

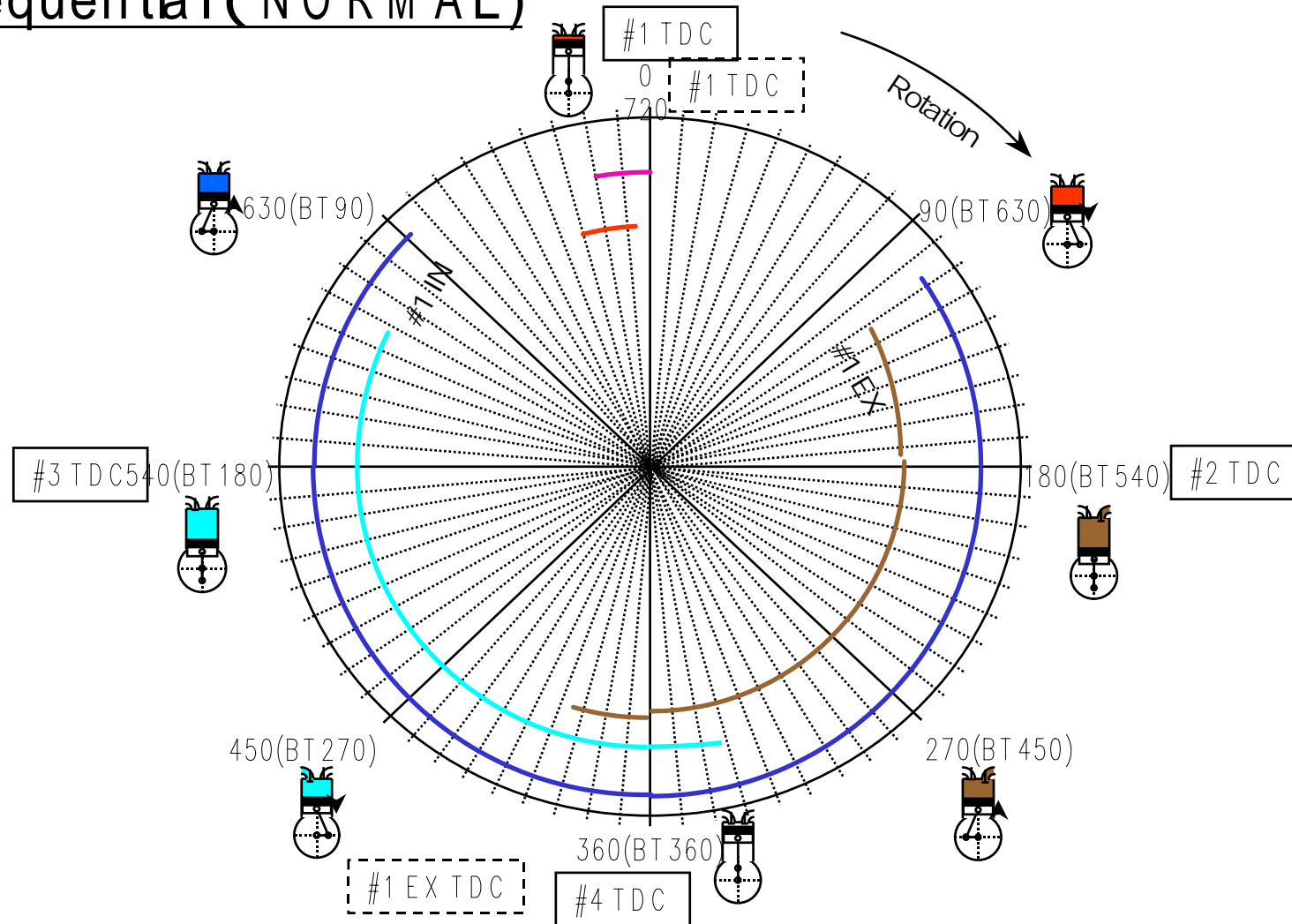

• Group ( STARTING )

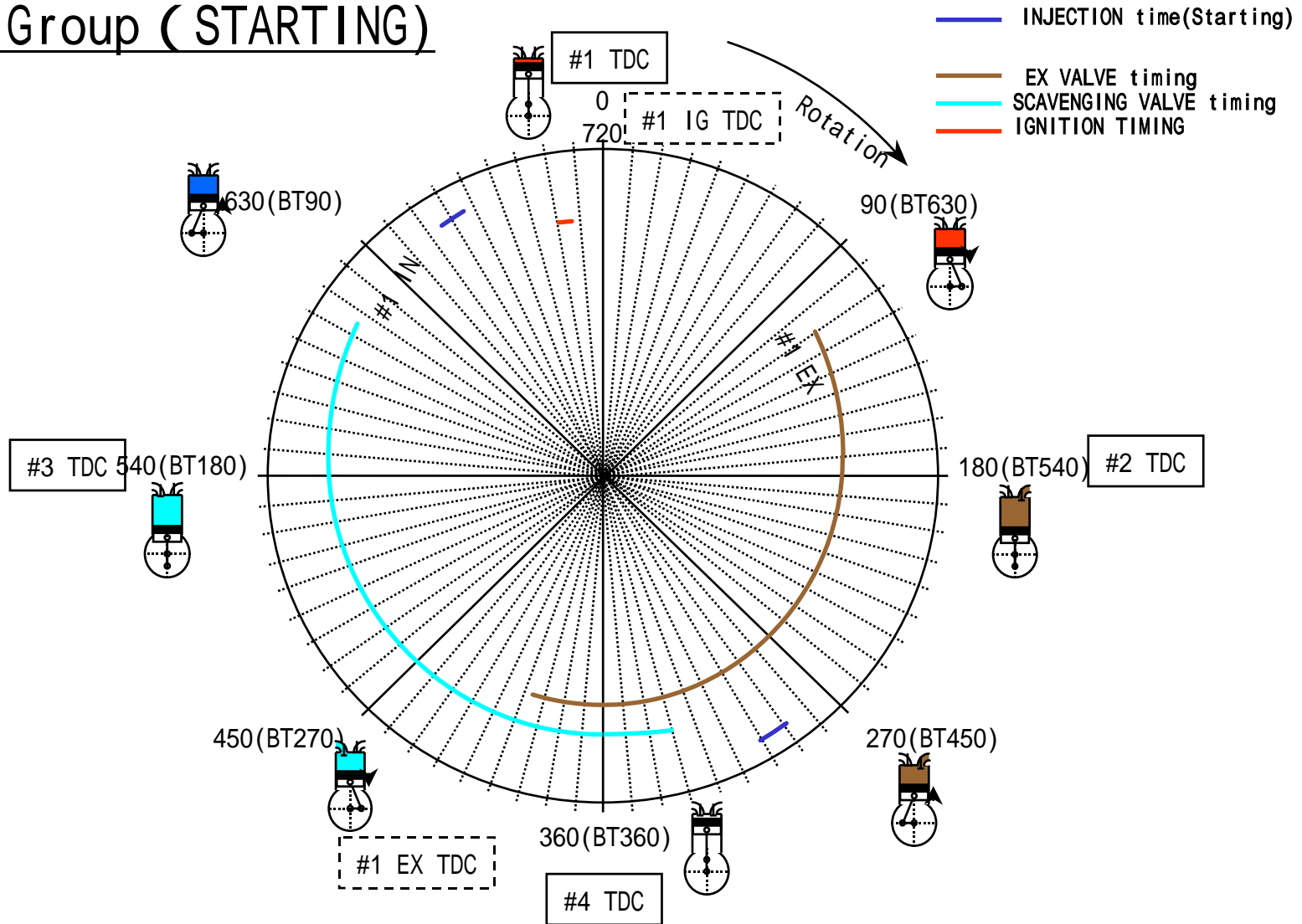

•Dead soak      Overheat SW : On.

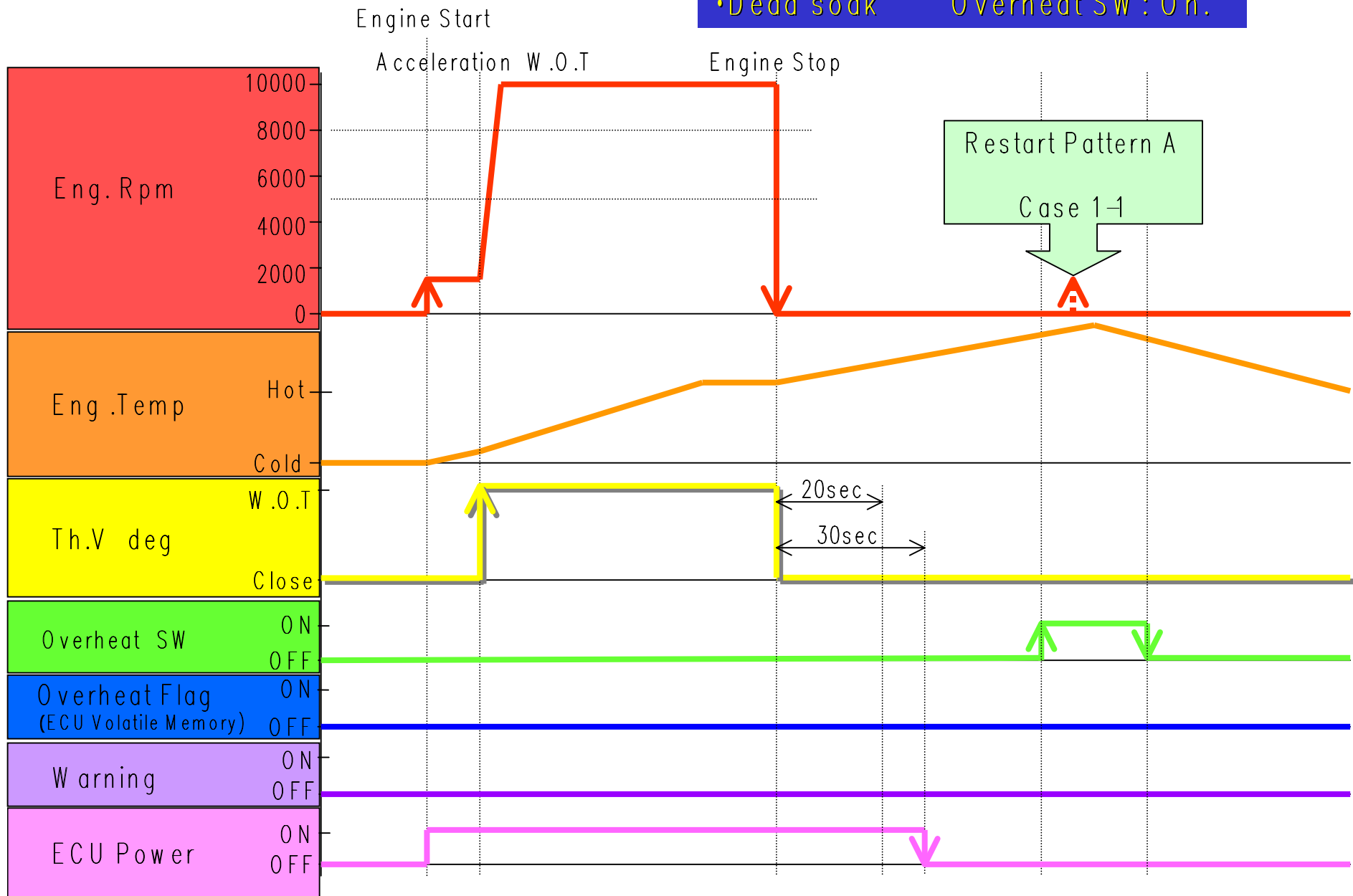

# Overheat Mode

## Technical Tips



•Dead soak      Overheat SW : On.

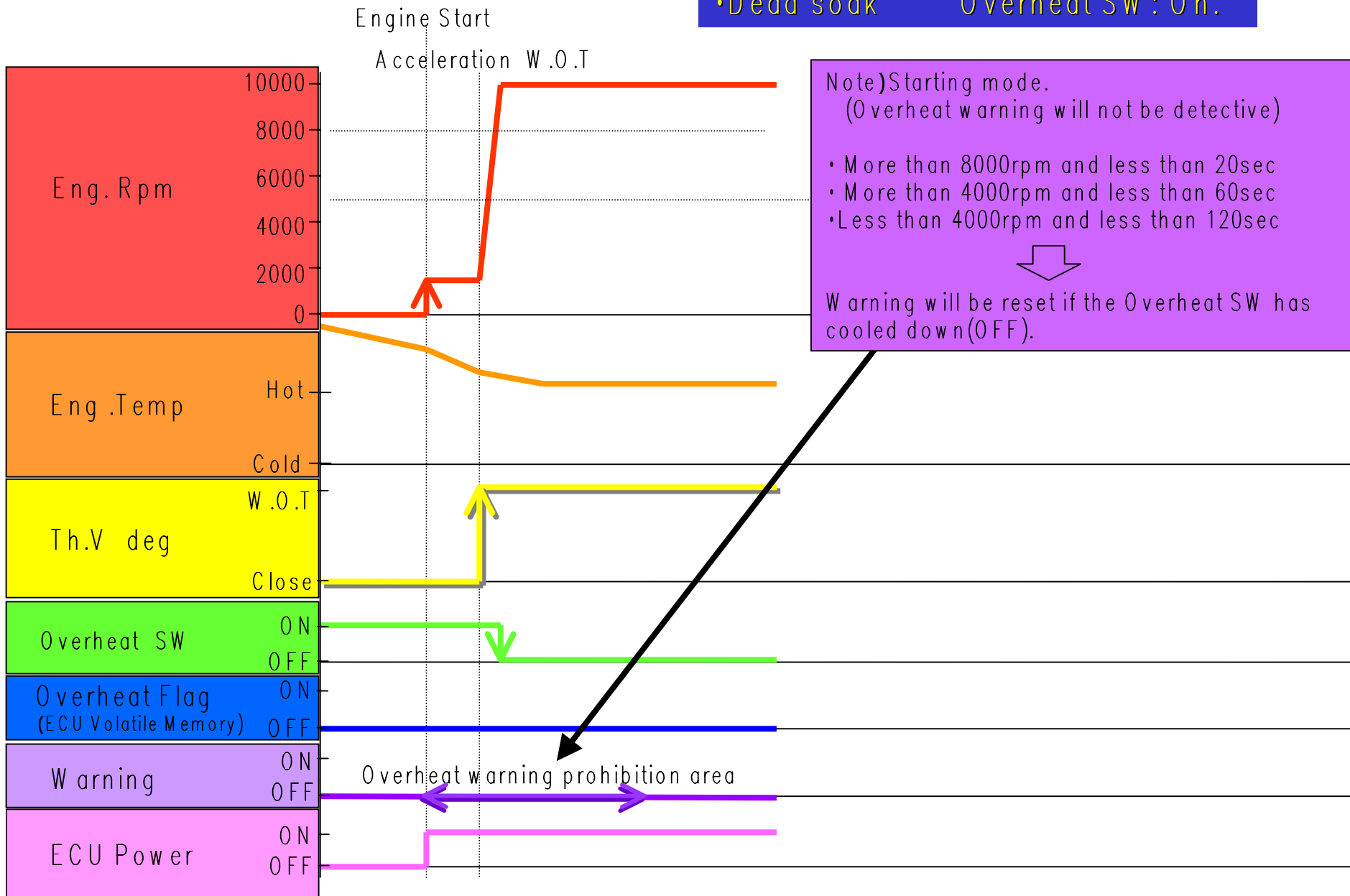

Note) Starting mode.  
(Overheat warning will not be detective)

- More than 8000rpm and less than 20sec
- More than 4000rpm and less than 60sec
- Less than 4000rpm and less than 120sec

Warning will be reset if the Overheat SW has cooled down(OFF).

•Intrusion of vinyl bag while running and then Overheat.

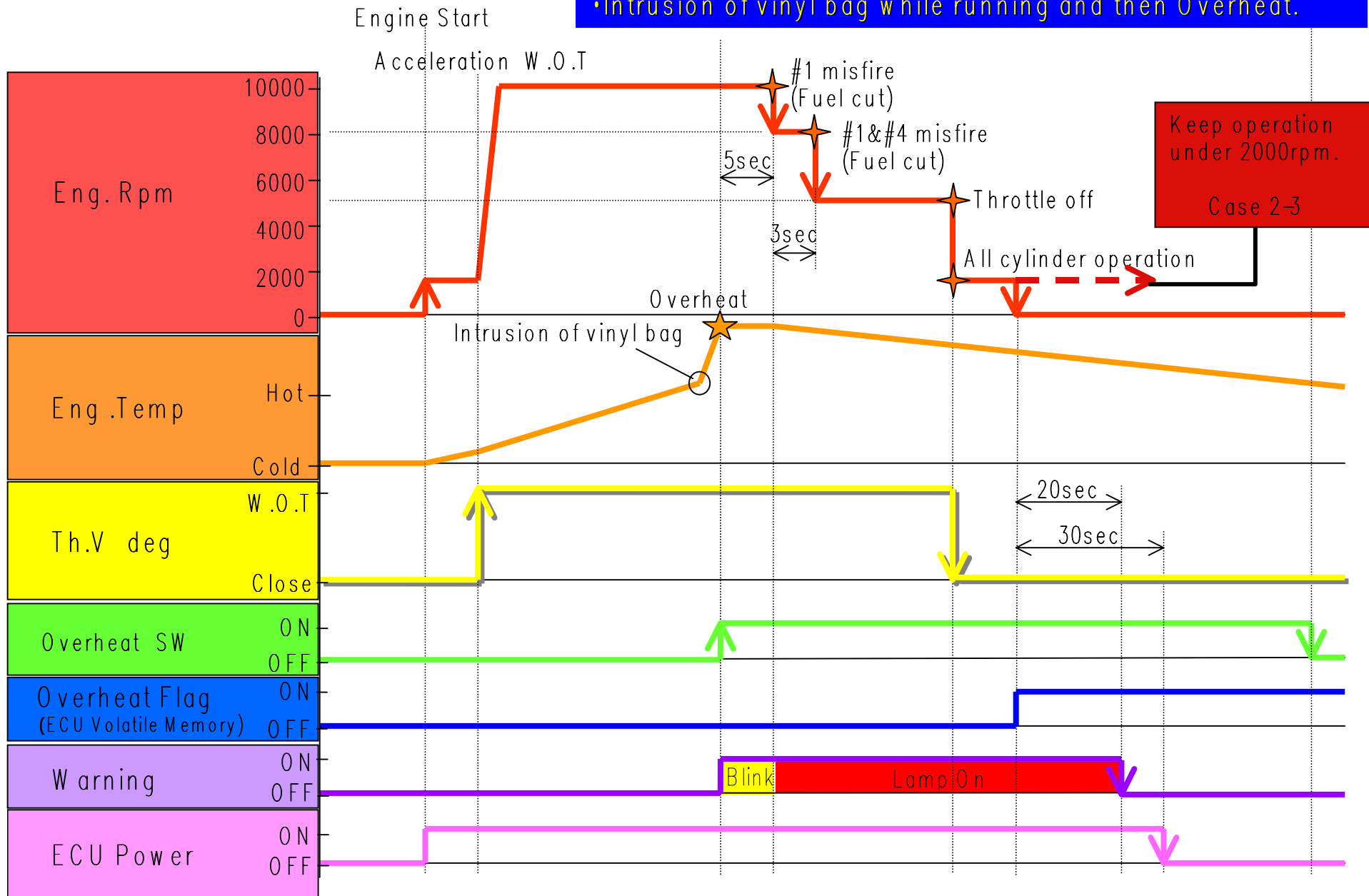

# Overheat Mode

## Technical Tips



• Engine re-start while engine temp is high and Overheat SW is ON.

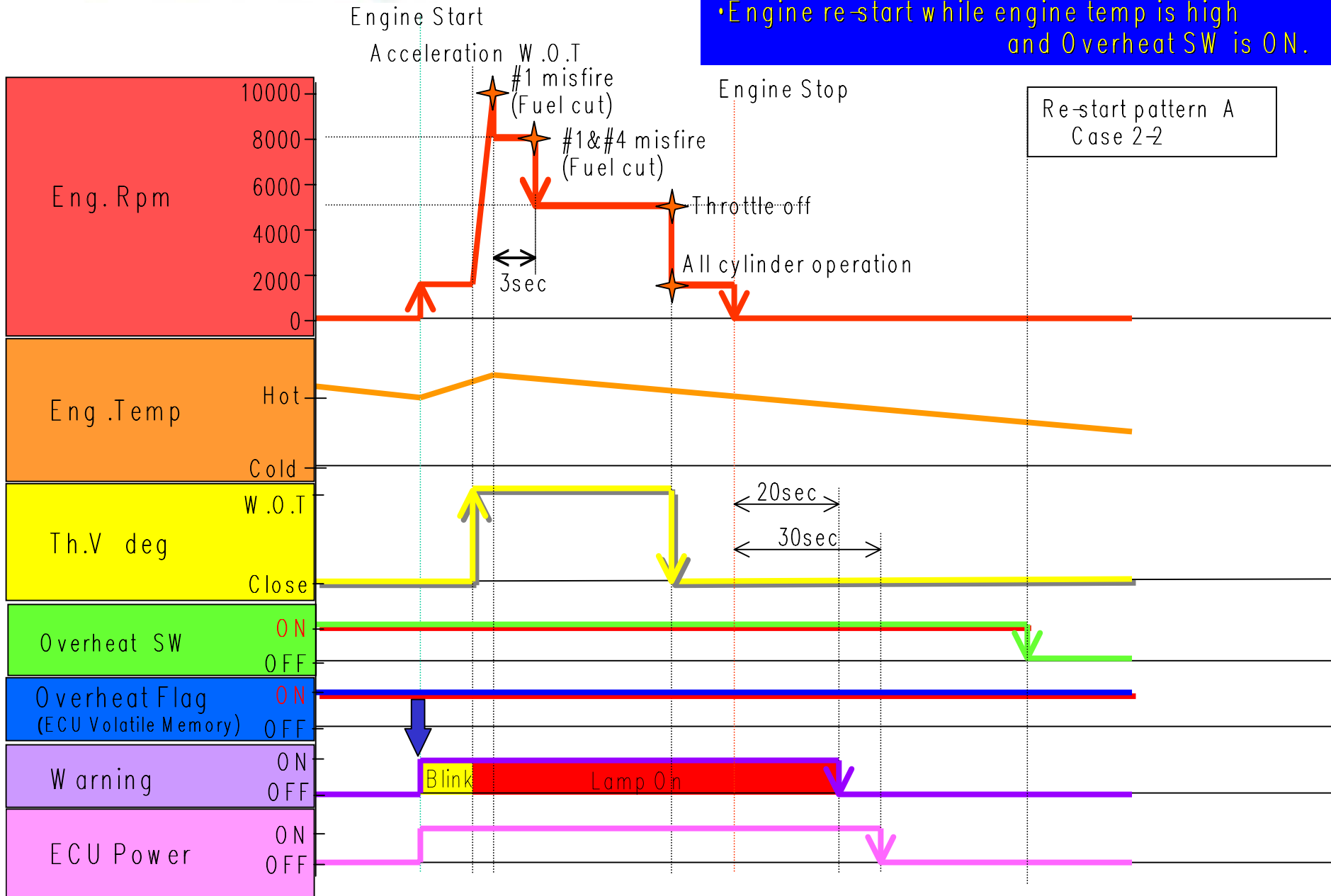



# Overheat Mode

## Technical Tips

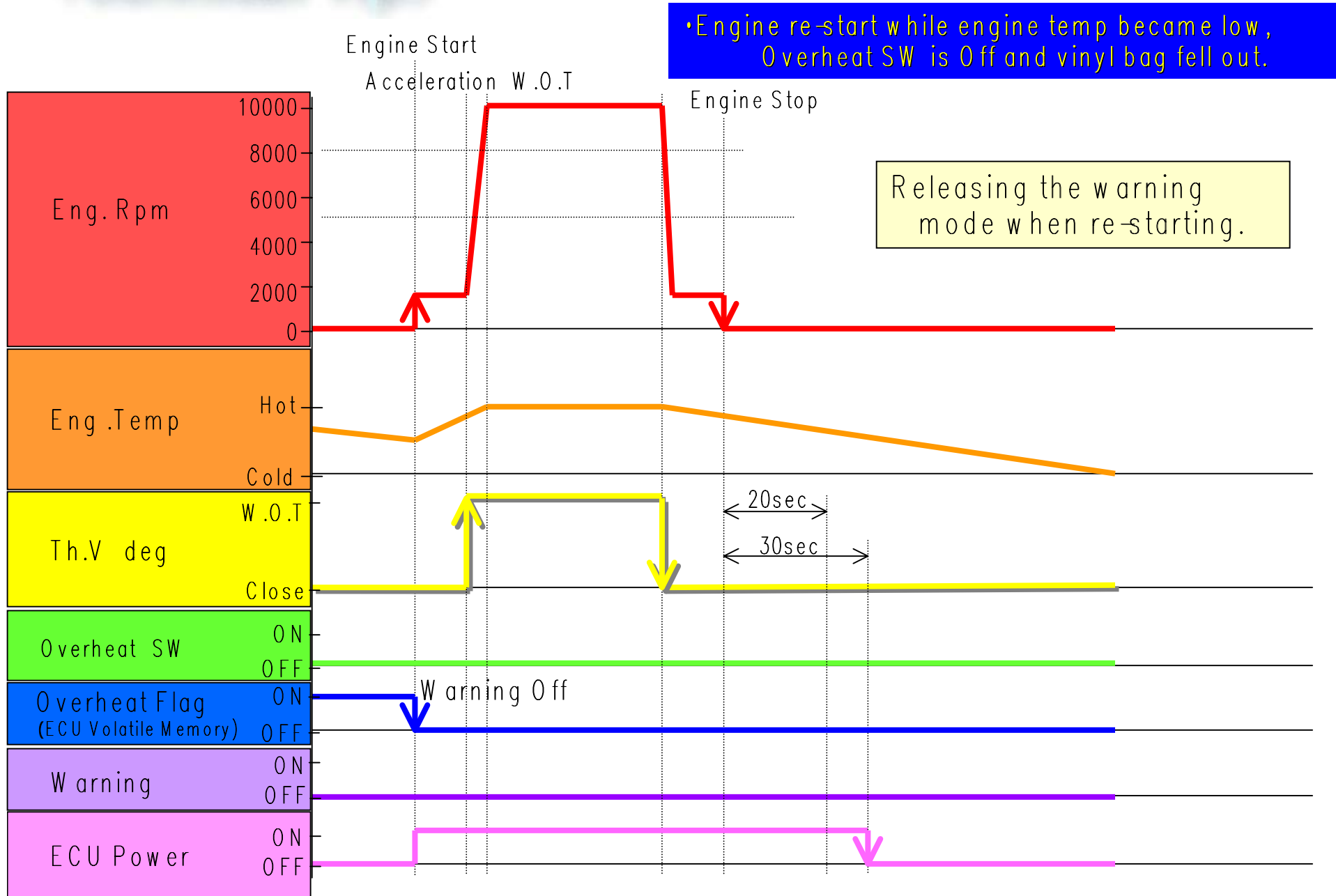

•Vinyl bag fell off when vehicle keeping operation with overheat condition.

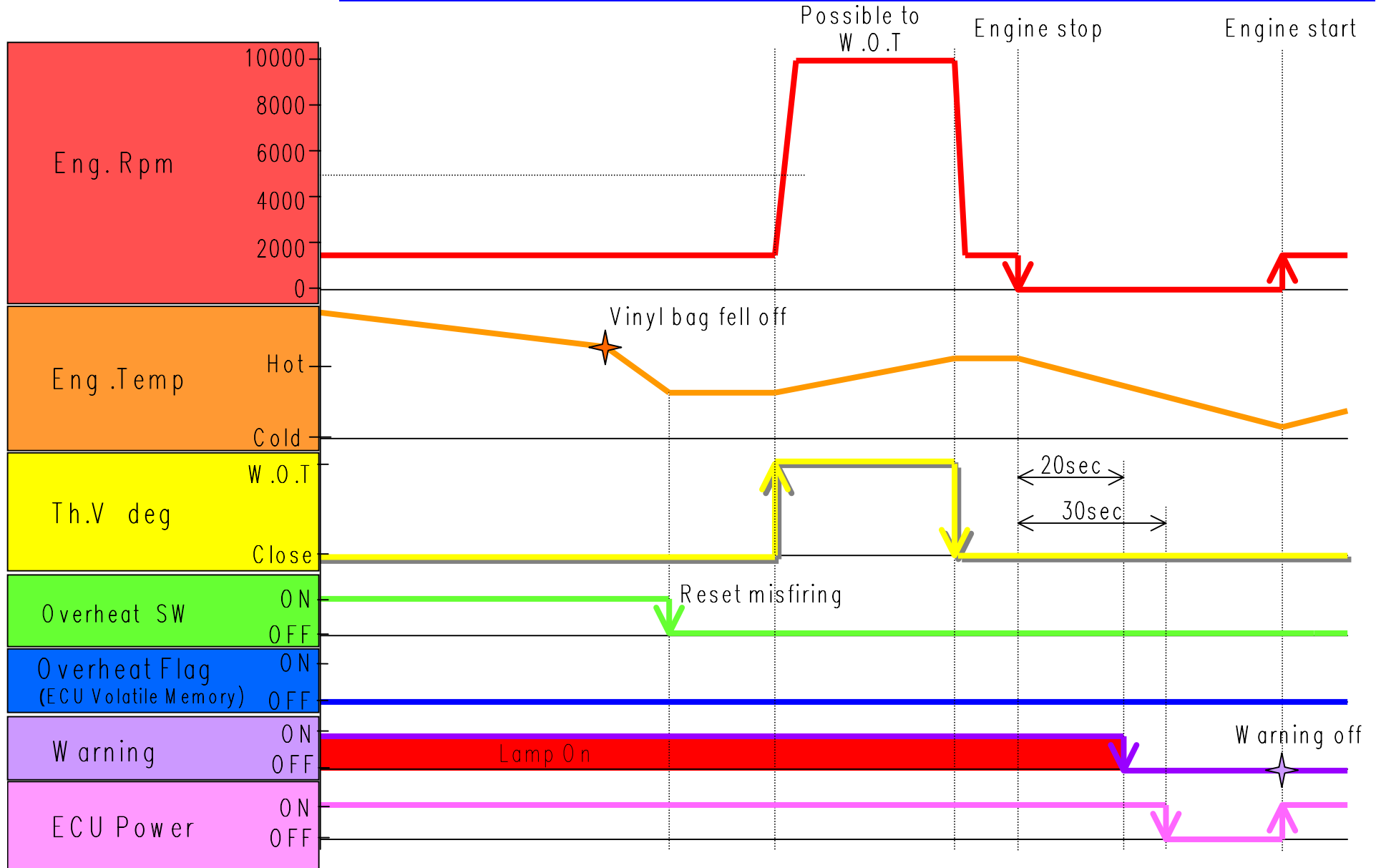

Lack of proper oil amount

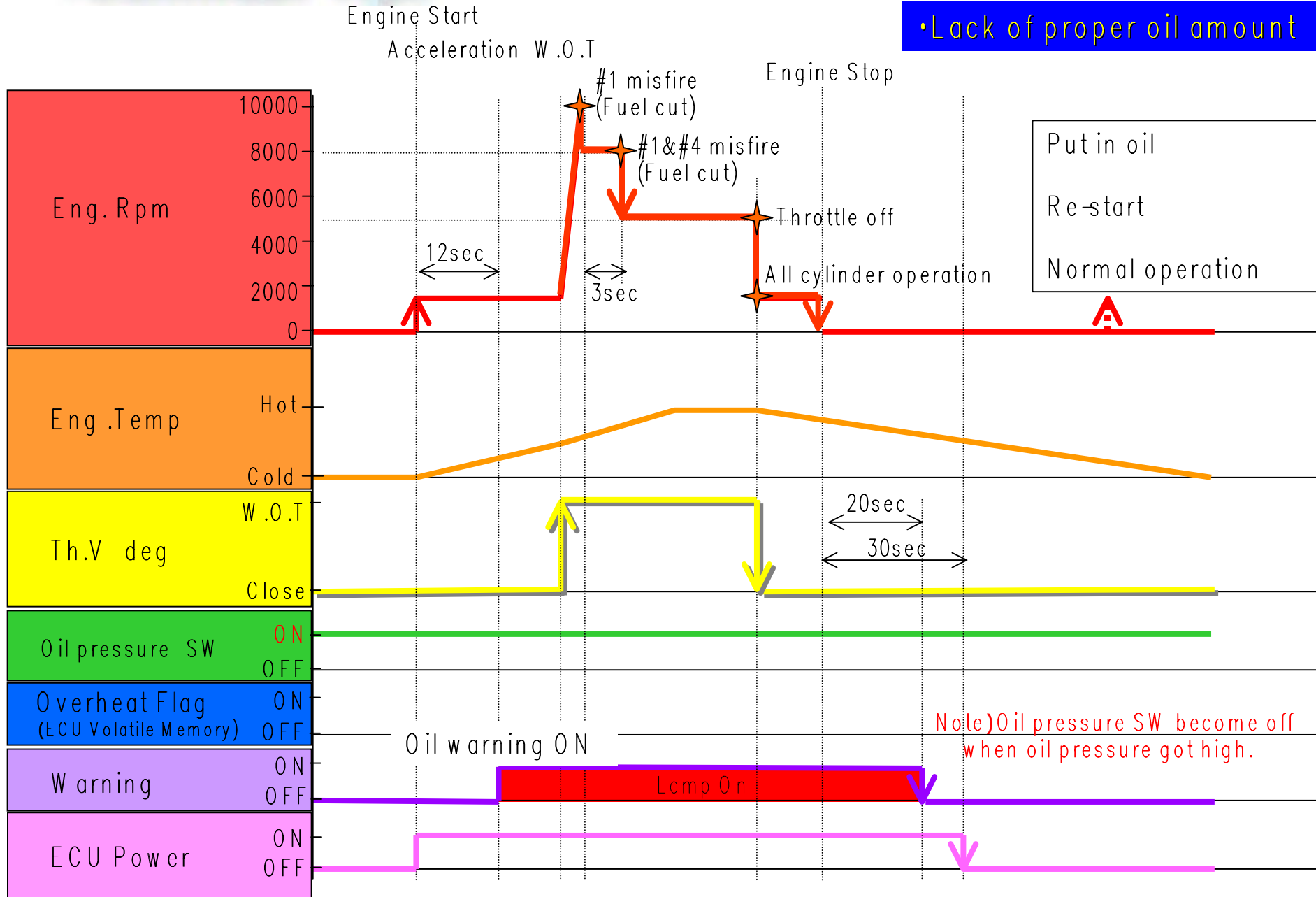

• Oil warning turn on cause of sucking air.

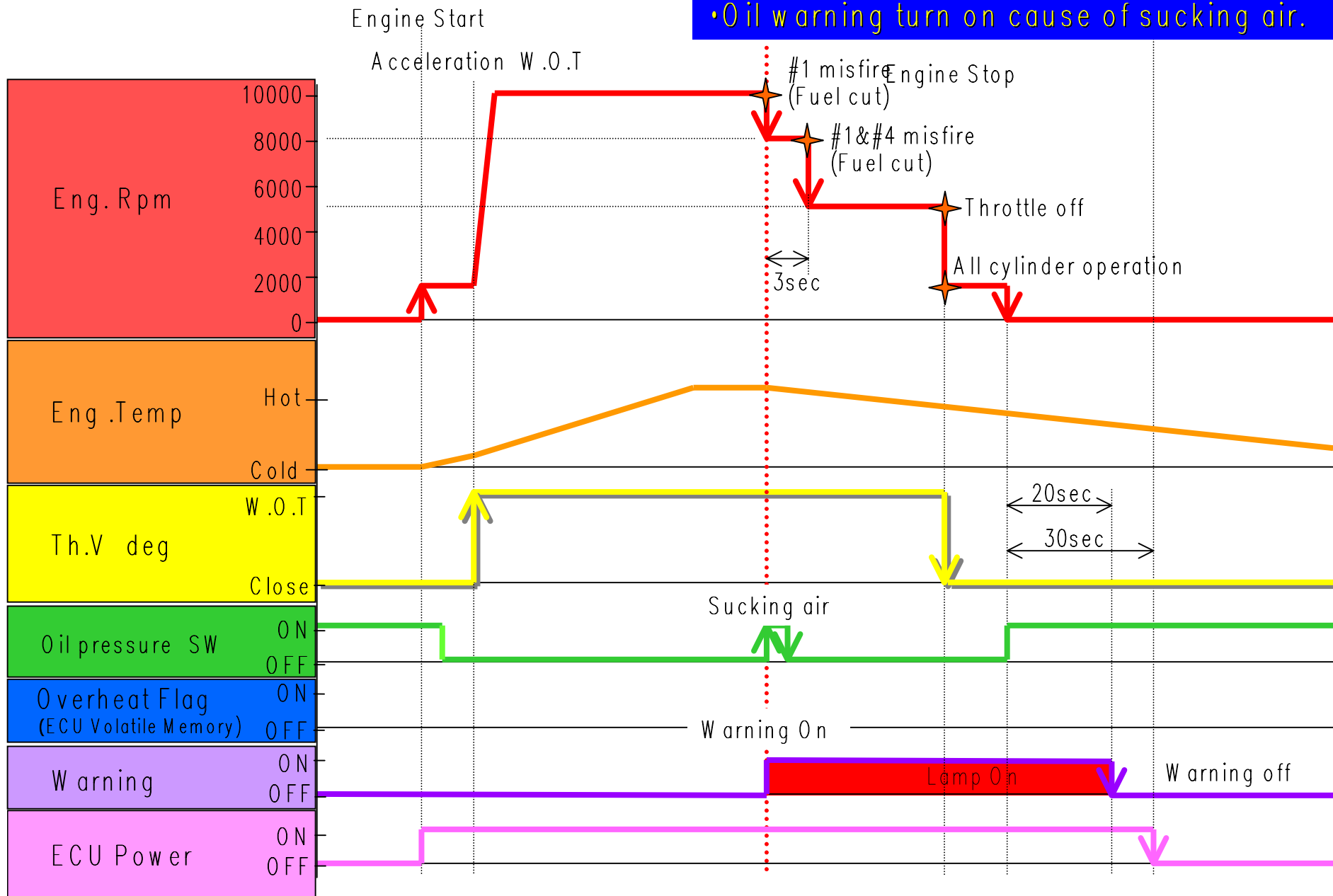

• Re-start after 30sec from oil warning.

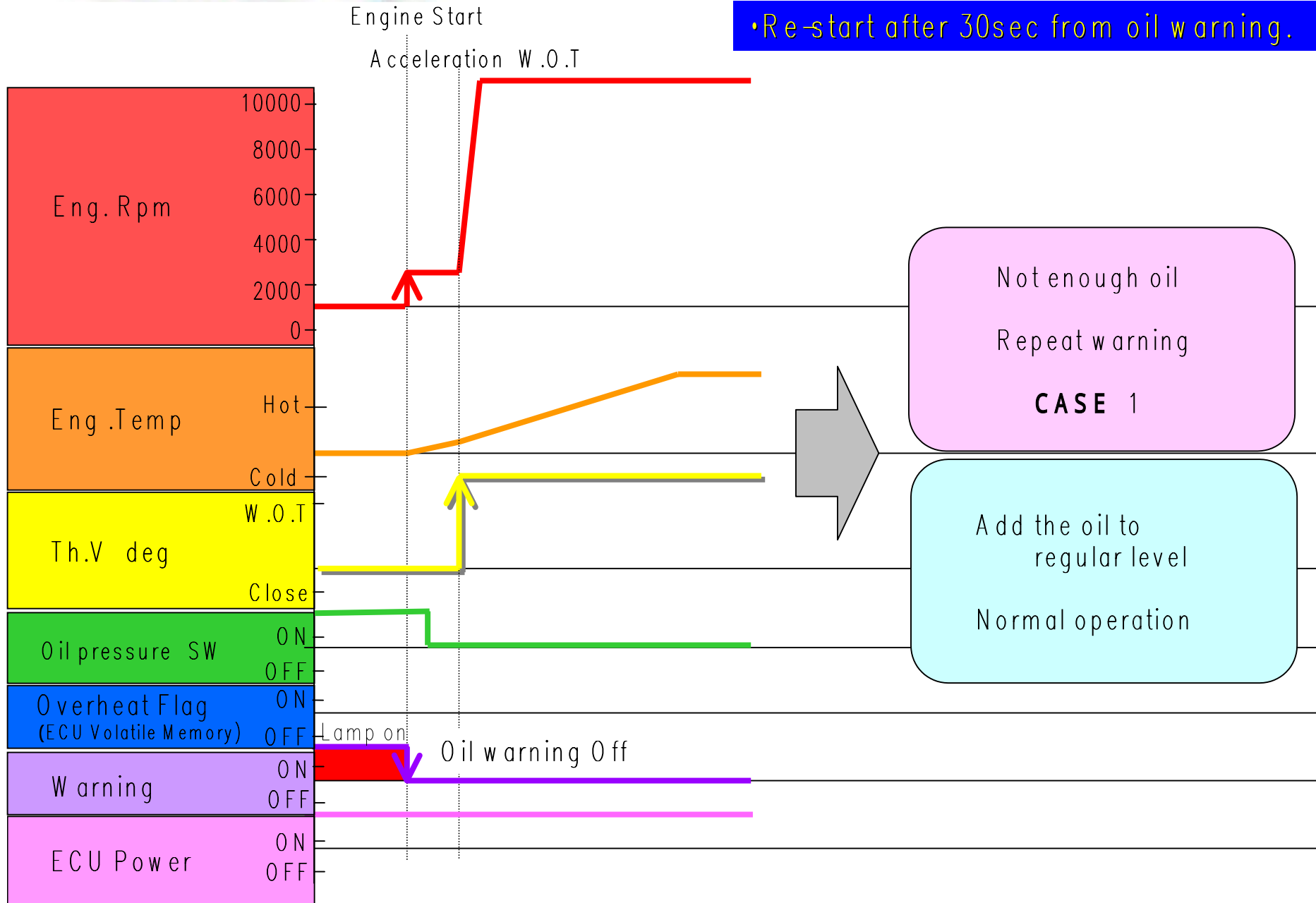

# Service Tips



- 
- A photograph of a Yamaha engine, likely a four-stroke engine, with various components like the carburetor, valves, and belts visible. The engine is set against a background of a bright, glowing light source, possibly a sun or a lamp, creating a lens flare effect. Overlaid on the left side of the engine is a list of service tips, each preceded by a right-pointing arrowhead.
- Periodic Inspection
  - Oil maintenance
  - Synchronization (Throttle Body)
  - Engine Removing
  - Valve Clearance
  - Bearing Selection
  - Other Information

# Periodic Inspection Chart



## PERIODIC INSPECTION CHART

: INDICATES THE CHECKUPS WHICH YOU MAY DO YOURSELF

: INDICATES WORK TO BE DONE BY YOUR WATER VEHICLE DEALER

ITEM		MAINTENANCE INTERVAL	INITIAL			THEREAFTER EVERY	
			10h	50h	100h	100h / 1year	200h / 2year
SPARKPLUG	INSPECT /CLEANING /ADJUSTMENT						
LUBRICATION POINT	GREASING						
INTERMEDIATE	GREASING		*1		*2	*2	
FUEL SYSTEM	INSPECT						
FUEL TANK	CLEANING						
FUEL FILTER	INSPECT , CLEAN						
TROLLING SPEED	ADJUSTMENT						
THROTTLE SHAFT	INSPECT						
COOLING SYSTEM	CLEANING / FLUSHING	(AFTER EVERY RIDE)					
WATER INLET STRAINER	INSPECT , CLEAN						
BILGE STRAINER	INSPECT						
ELECTRICAL BILGE PUMP STRAINER	INSPECT , CLEAN						
IMPELLER	INSPECT						
STEERING CABLE	INSPECT						
STEERING BOSS	INSPECT						
QSTS MECHANISM	INSPECT						
SHIFT SYSTEM	INSPECT /ADJUSTMENT						
THROTTLE CABLE	INSPECT /ADJUSTMENT						
DRAIN PLUG	INSPECT /REPLACEMENT						
BATTERY	INSPECT	(INSPECT FLUID LEVEL BEFORE EVERY RIDE)					
RUBBER COUPLING	INSPECT						
ENGINE MOUNT	INSPECT						
BOLT & NUT	INSPECT						
AIR FILTER ELEMENT	INSPECT						
ENGINE OIL	REPLACEMENT						
OIL FILTER	REPLACEMENT						
VALVE CLEARANCE	INSPECT /ADJUSTMENT						

\*1: GREASE = 33.0 ~ 35.0cc?

\*2: GREASE = 6.0 ~ 8.0cc?

# Oil Maintenance

## Service Tips



Engine Oil Amount for Each place		
ENGINE	1.3	
FILTER	0.2	
OILTANK	2.8	
TOTAL	4.3	(LITER)





# Oil Maintenance

## Service Tips



Engine Oil Amount for Each place		
ENGINE	1.3	
FILTER	0.2	
OILTANK	2.8	
TOTAL	4.3	(LITER)



# OIL LEVEL CHECK

Check oil level in cold engine situation before every operation.

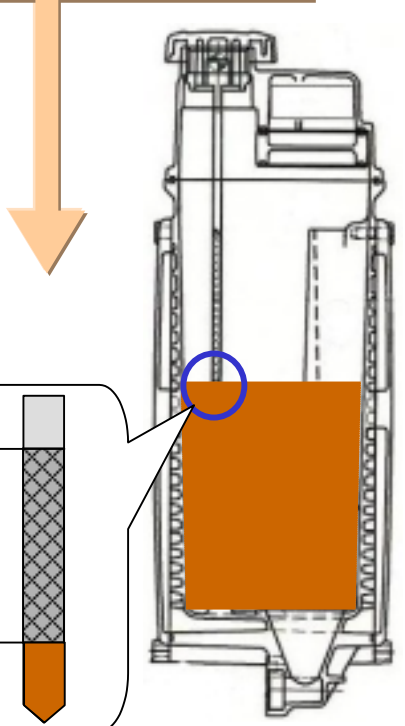

Cold engine

It is possible for 1 day to use, if there is more than .L. mark

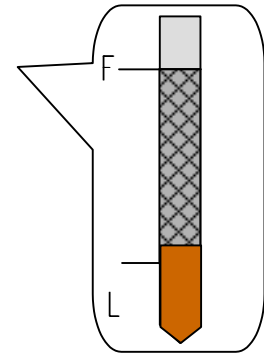

If oil level is under than .L. mark, Fill the oil around .L. mark on gauge.

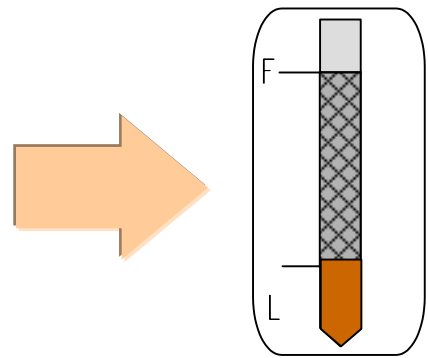
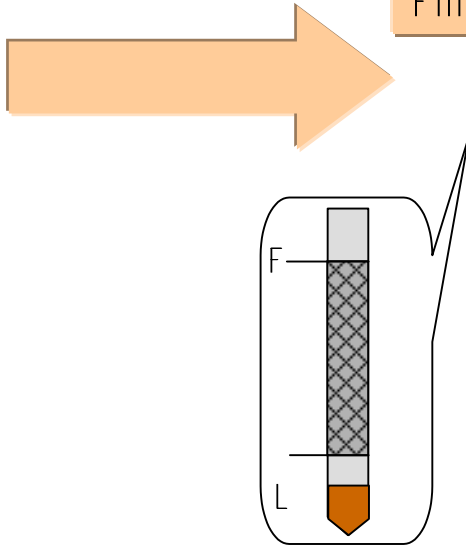

# OIL LEVEL ADJUSTMENT

Before oil level checking, fully warm up the engine, and then keep the trolling about 2min before engine stop.

Check oil level and fill the oil till .F. mark

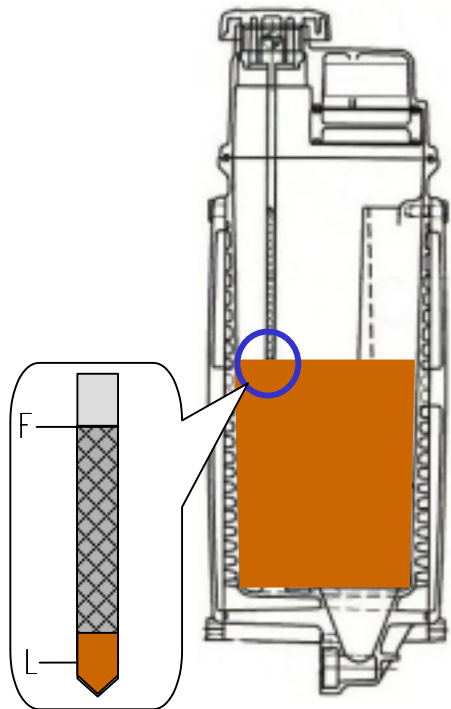

Cold engine

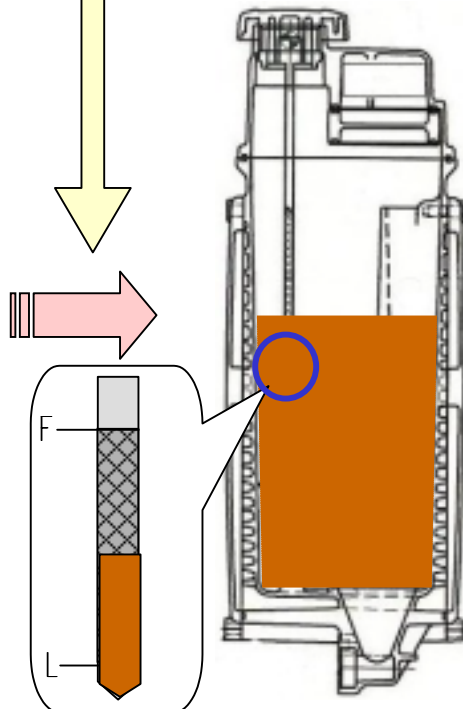

After warm up

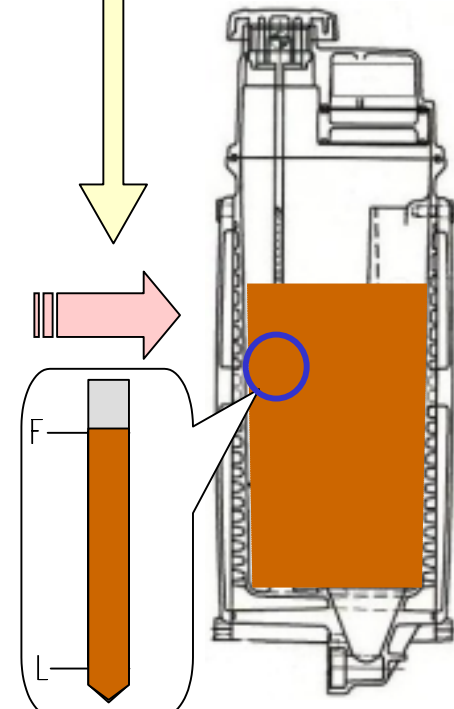

After warm up

➤ **Throttle Body**  
Synchronization Procedure

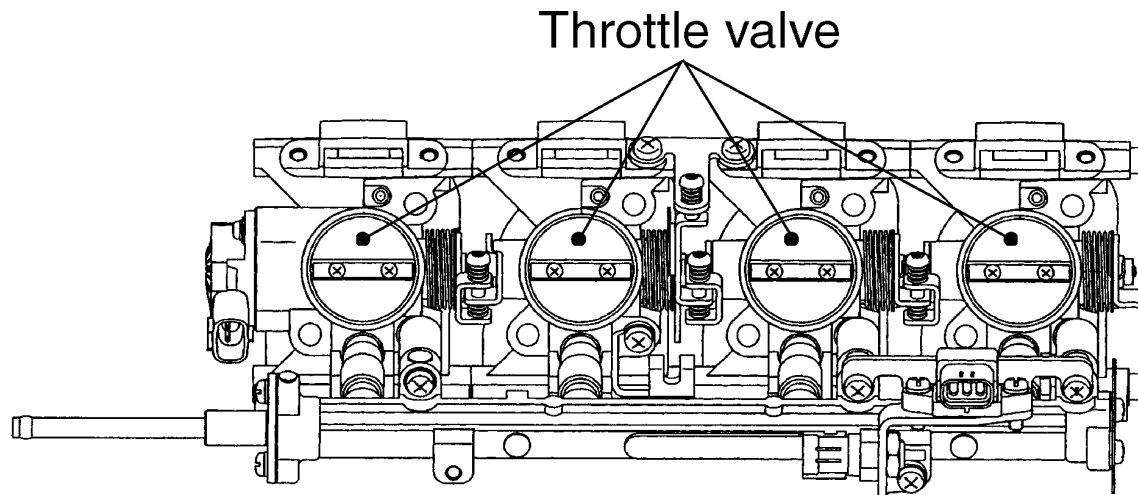

# Throttle Body Synchronization



## Name of Adjustment Screw

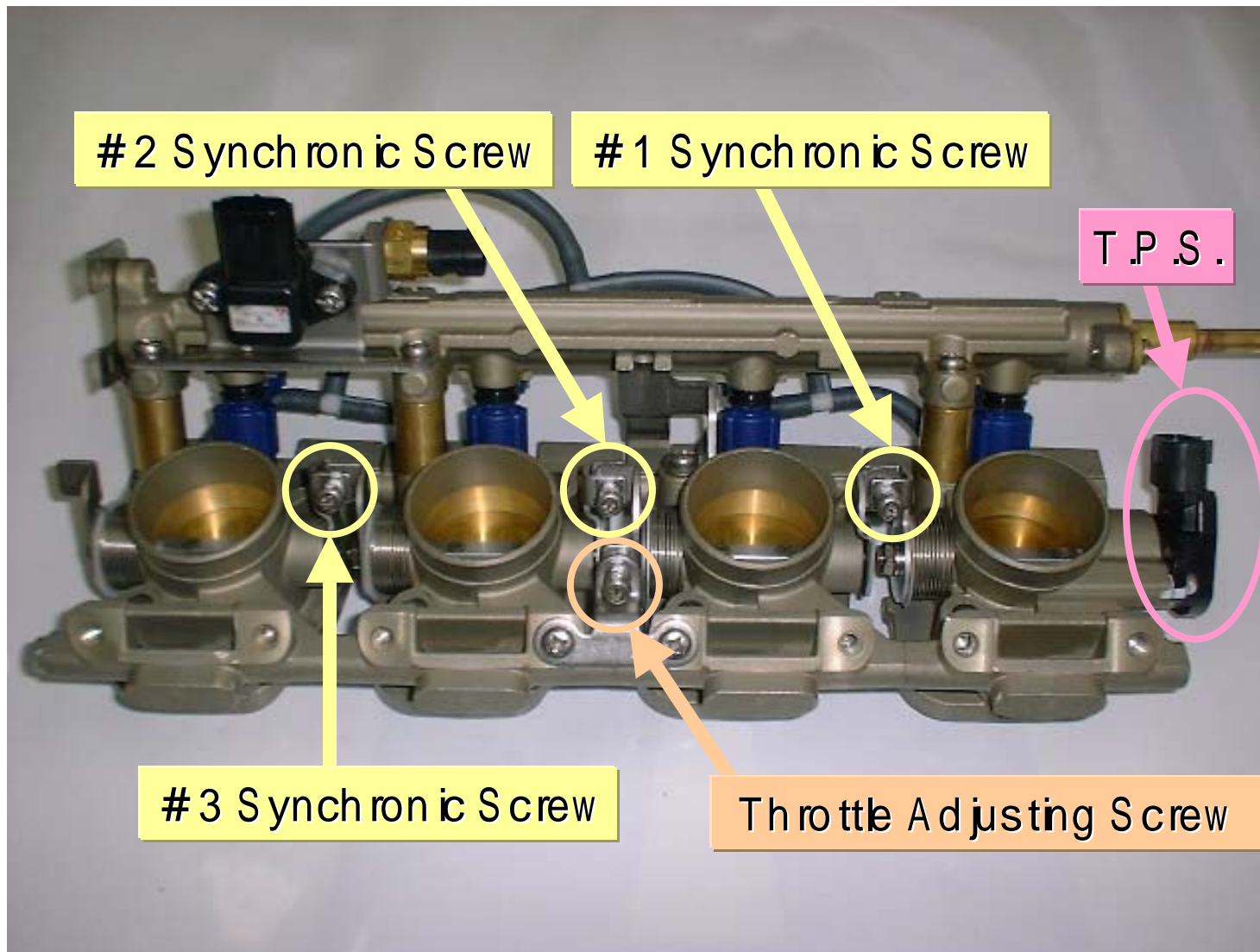

# Throttle Body Synchronization

SERVICE TIPS

## FRAME ARRESTER



# Throttle Body Synchronization

Service Tips

【 Z O O M 】

FRAME ARRESTER



# Throttle Body Synchronization

Service Tips

## FUEL HOSE DISASSEMBLING

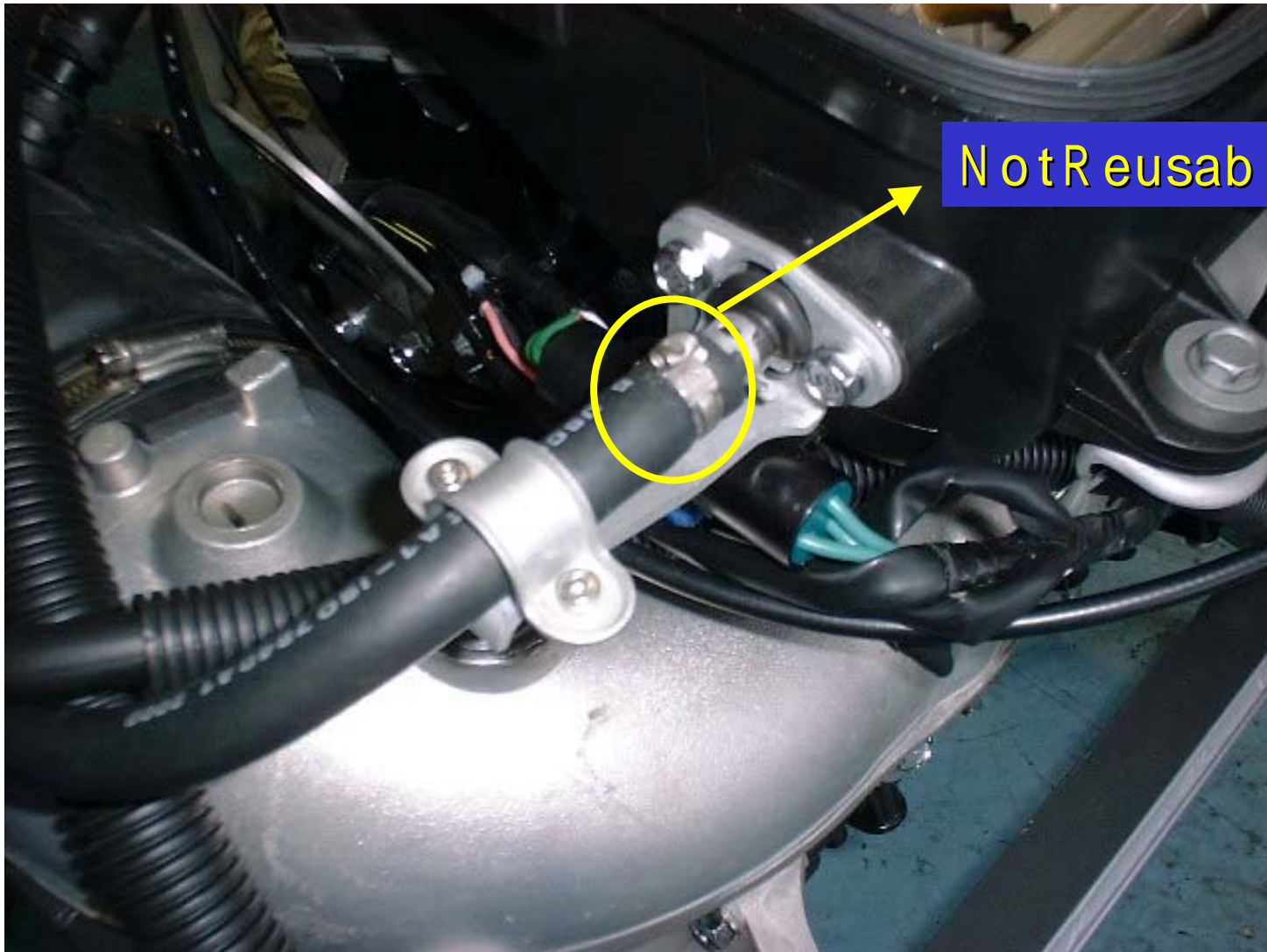



# Throttle Body Synchronization

SERVICE TIPS

## Th.BODY

HEX 5mm x 8



# Throttle Body Synchronization

SERVICE TIPS

## AIR CLEANER BOX ASSY



# Throttle Body Synchronization

SERVICE TIPS

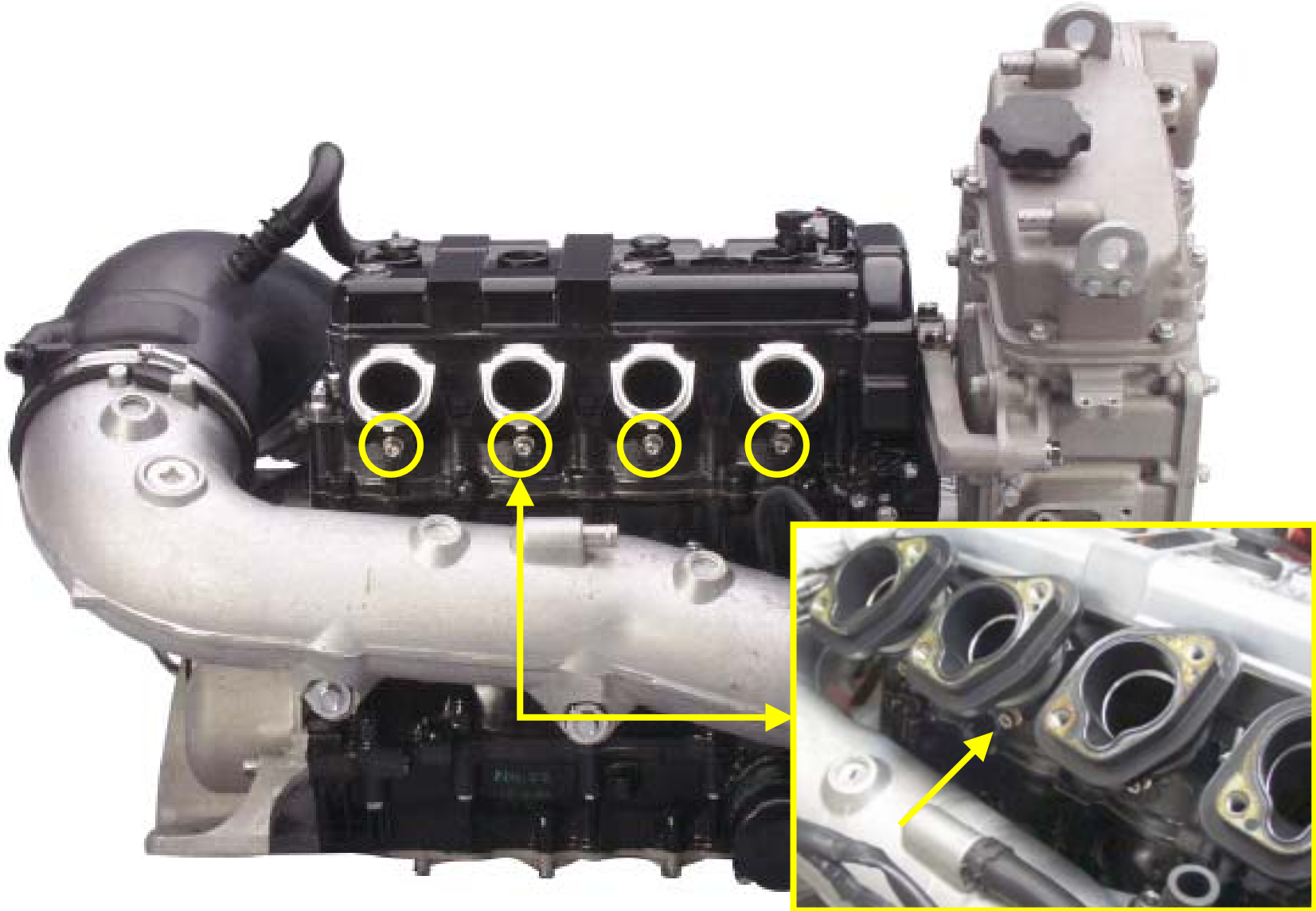

# Throttle Body Synchronization

SERVICE TIPS



# Throttle Body Synchronization



## Name of Adjustment Screw

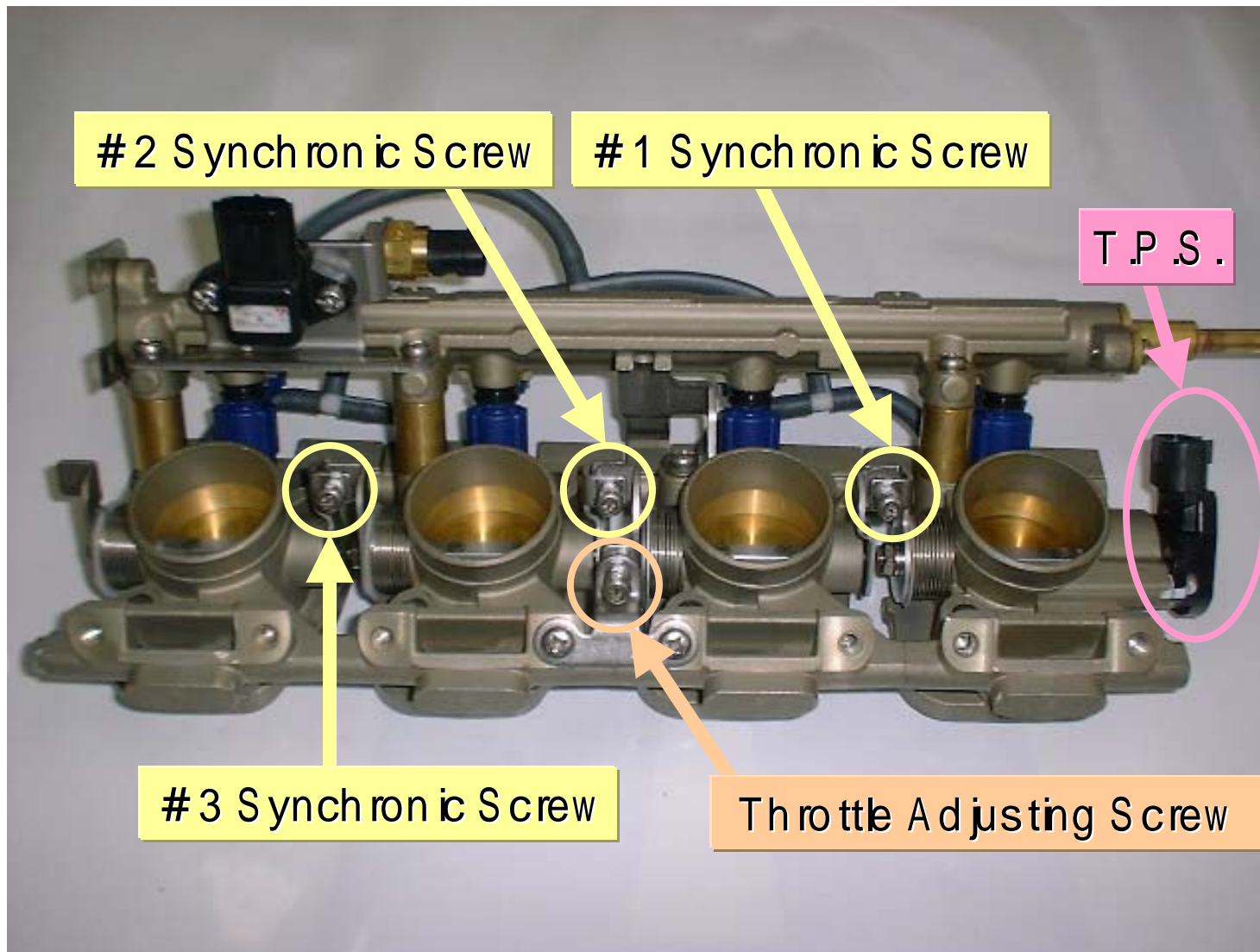

# Throttle Body Synchronization

SERVICE TIPS

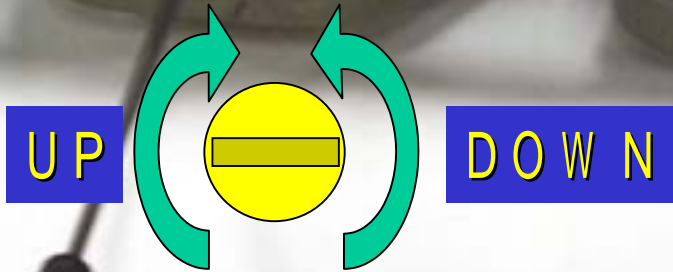
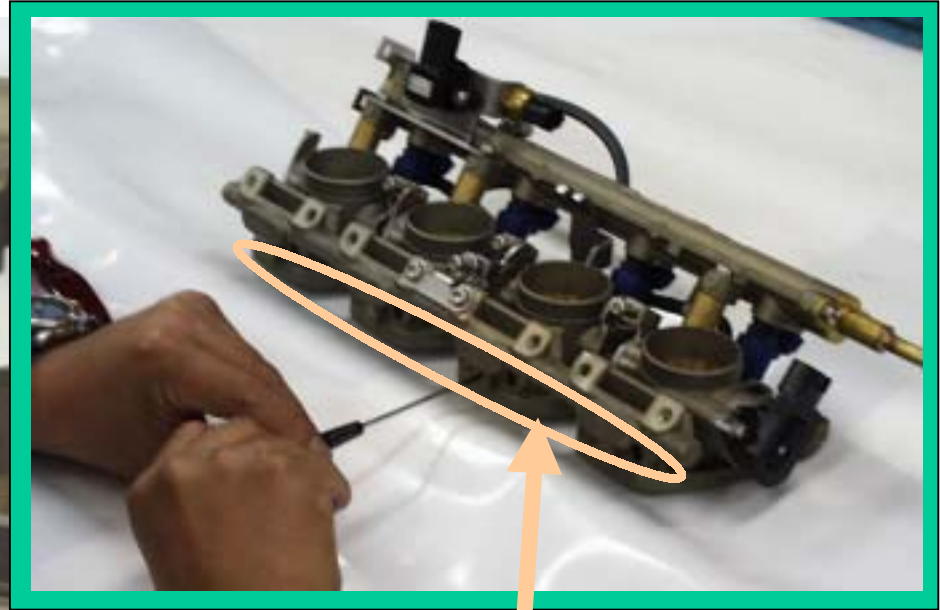
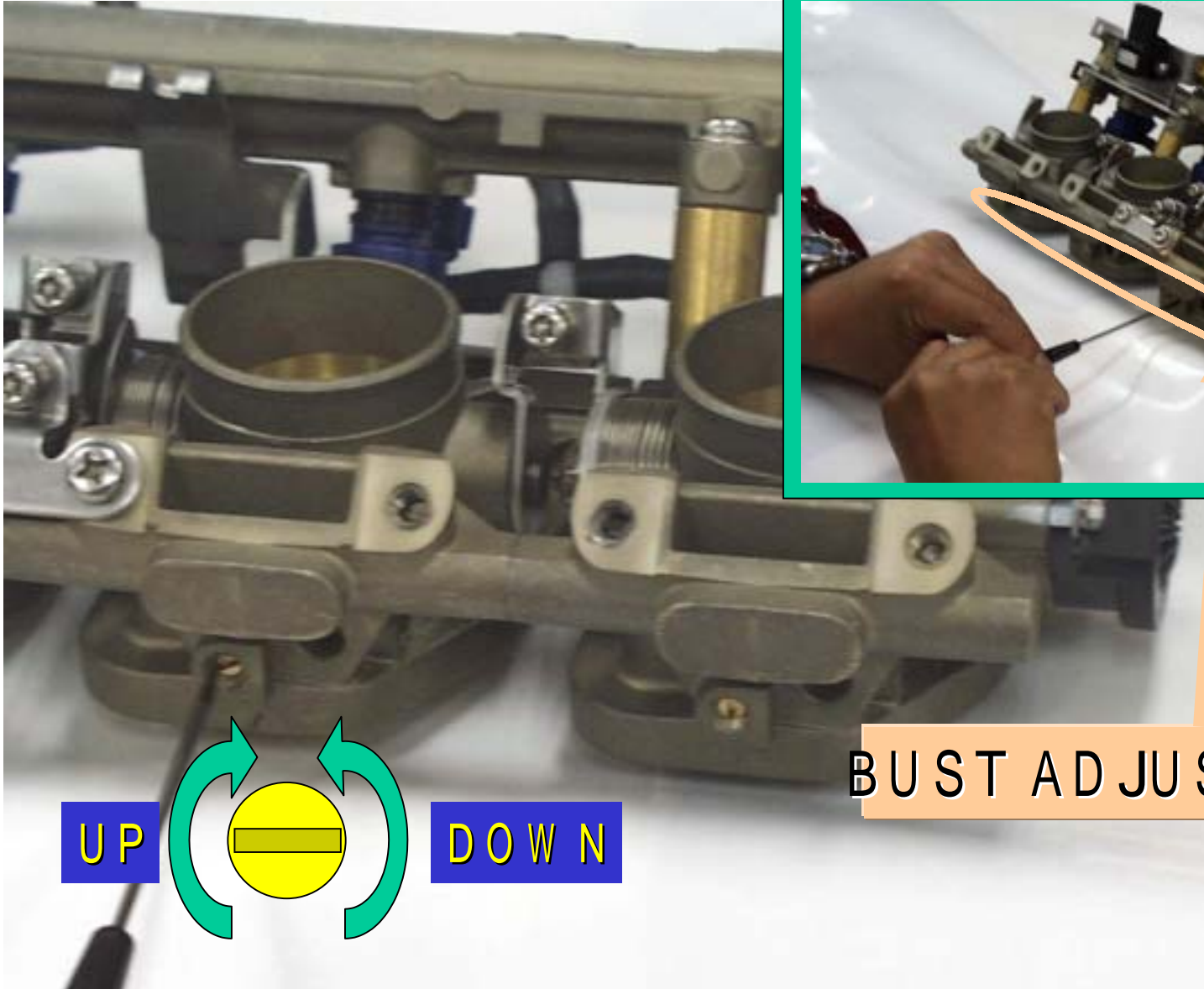

BUST ADJUST SCREW

# Throttle Body Synchronization

Service Tips



# Throttle Body Synchronization

SERVICE TIPS



**YAMAHA DIAGNOSTIC SYSTEM**

Engine Monitor

Monitor Item	Result	Unit
Engine speed	1871	r/min
Intake pressure	75.31	kPa
Intake pressure	22.06	inHg
Battery voltage (12-16)	14.85	V
TPS voltage (0.5-4.5)	0.654	V
Throttle valve opening (0-90)	-1.3	deg
Fuel injection duration	3.03	ms
Engine temperature (below 120)	54.0	°C
Intake temperature (below 70)	19.0	°C
Engine stop lanyard switch	OFF	

**Print [F1]** Use UP and DN arrow keys to scroll page.  
Use LH and RH arrow keys to move page up or down.  
Press F1 to print, F2 to save, F3 to display data.

**Save [F2]**

**Select [F3]**

**YAMAHA**

**Main Menu**

**Diagnosis** 1

**Diagnosis Record** 2

**Engine Monitor** 3

**Stationary Test** 4

**Active Test** 5

**Data Logger** 6

**ECM No.** 7

**Exit** 8



# Throttle Body Synchronization

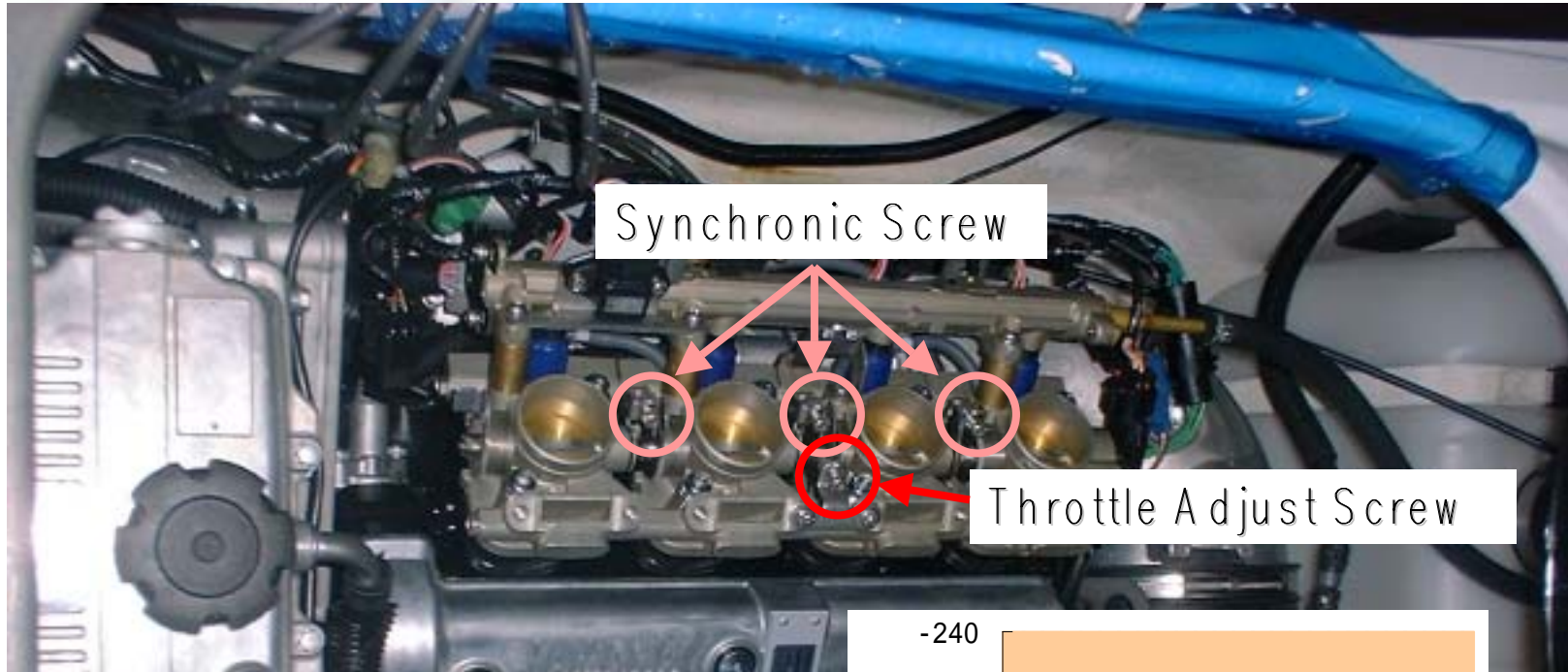

Synchronic Screw

Throttle Adjust Screw

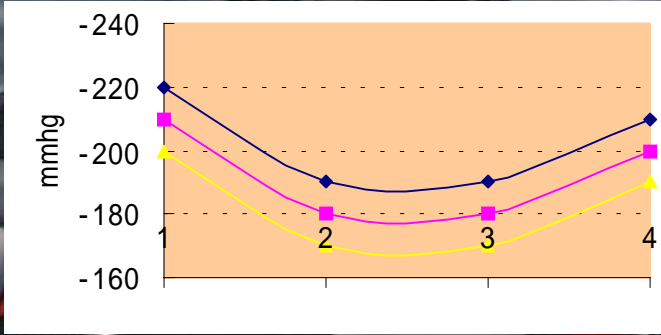
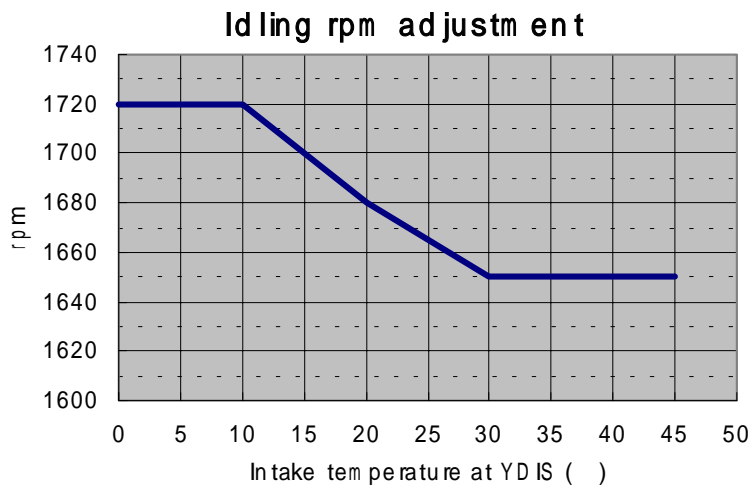

Vacuum specification		# 1	# 2	# 3	# 4
kpa		-3.997 1.33	0	07 1.33	-2.667 1.33
m m hg		-307 10	0	07 10	-207 10

Reference Point

# Throttle Body Synchronization

SERVICE TIPS

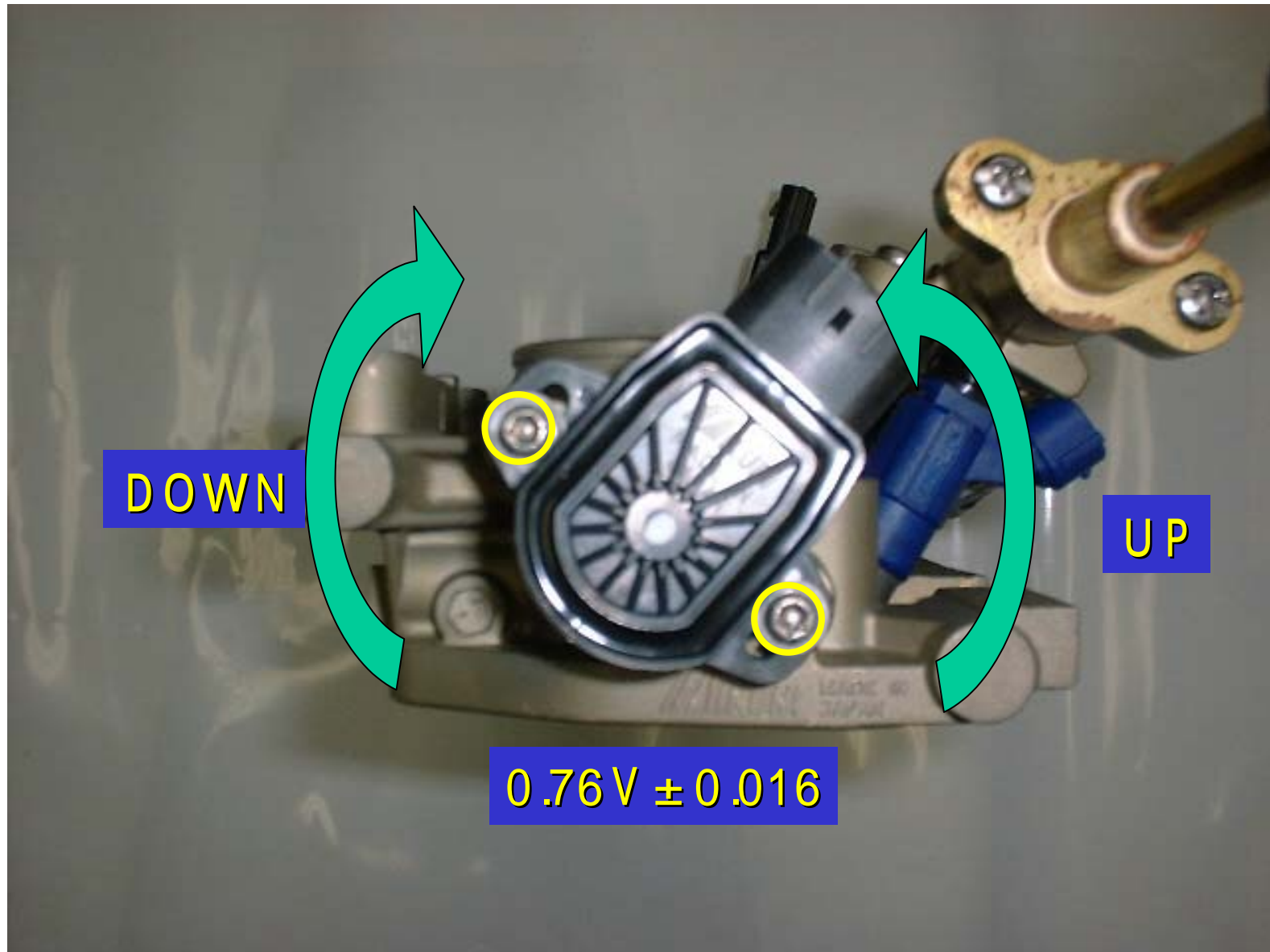

Service Tips

➤ Engine Removing

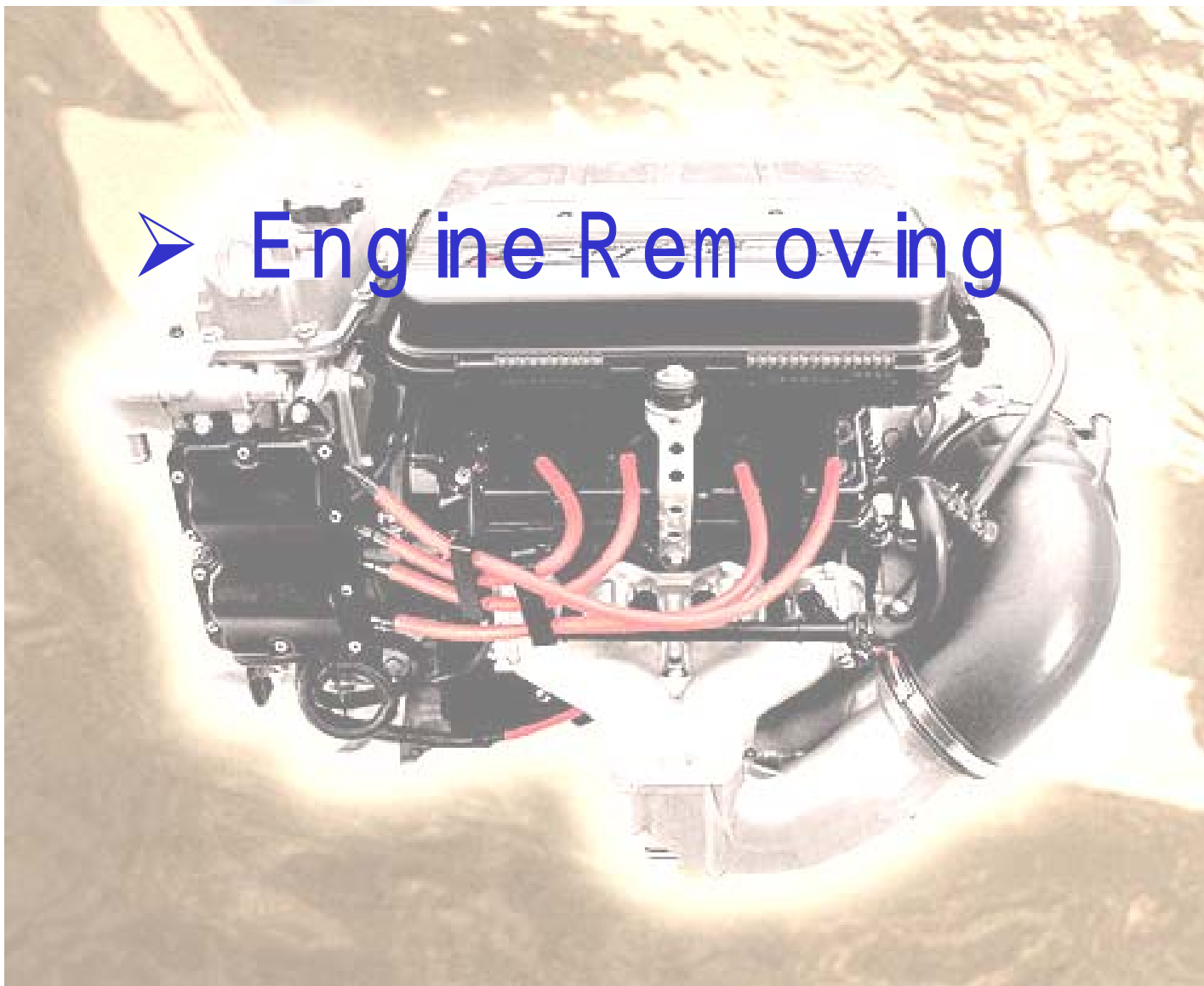

	Subjects	Notes
1.	Beam deck	
2.	Water lock assy	
3.	Exhaust pipe assy	Pullout for rear side from bak head
4.	Air cleaner case cover	
5.	Throttle cable (at the engine end)	Then re-assemble the air cleaner & case cover temporary to avoid any enter of foreign materials
6.	Fuel hose connector	Disconnect with cbth to avoid spread out of a fuel
7.	Piping for pilot water	
8.	Piping for cooling water	Pullout the hose from bak head
9.	Front inspection hatch	
10.	Each couplers on the wire harness (5 positions)	Fuel sender, speed sender, switches (start and stop), meter
11.	Coupling cover	
12.	Greasing hose for bearing housing	
13.	Oil filter	Oil will be flow out from the filter
14.	Bolt for engine mounting bolts (4 pcs)	
15.	Hang up bit the engine with front and rear hook on the engine	
16.	Remove the engine to forward for the coupling off	
17.	Hang up with only rear hook, (pull down the engine once)	Keep engine position vertically
18.	Removing up the engine to protect some parts	Exhaust pipe & oil filter installation area on port side, then exhaust manifold on starboard side
19.	Remove up a part of the engine mount front on port side	with bands on the engine front for starboard side, and rear side for port side

# Engine Removing

SERVICE TIPS

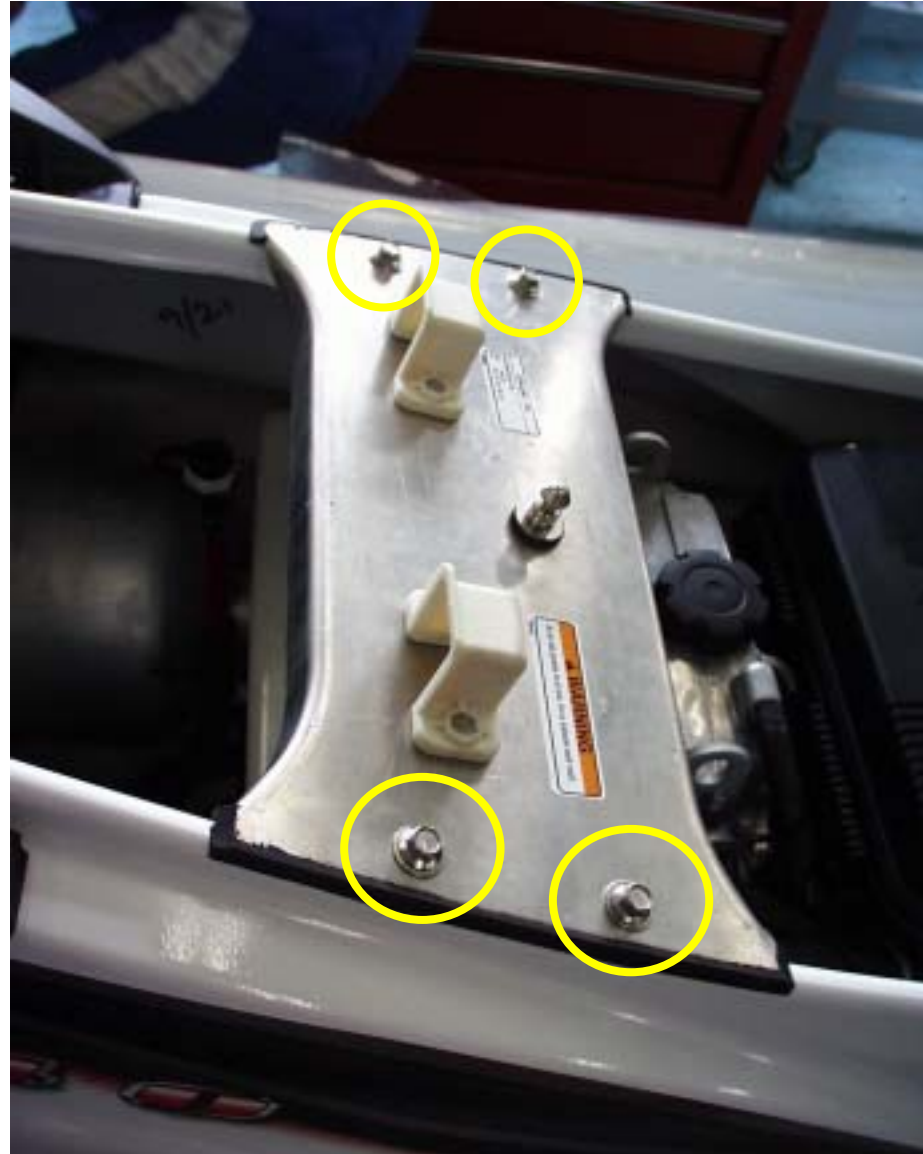

# Engine Removing

Service Tips

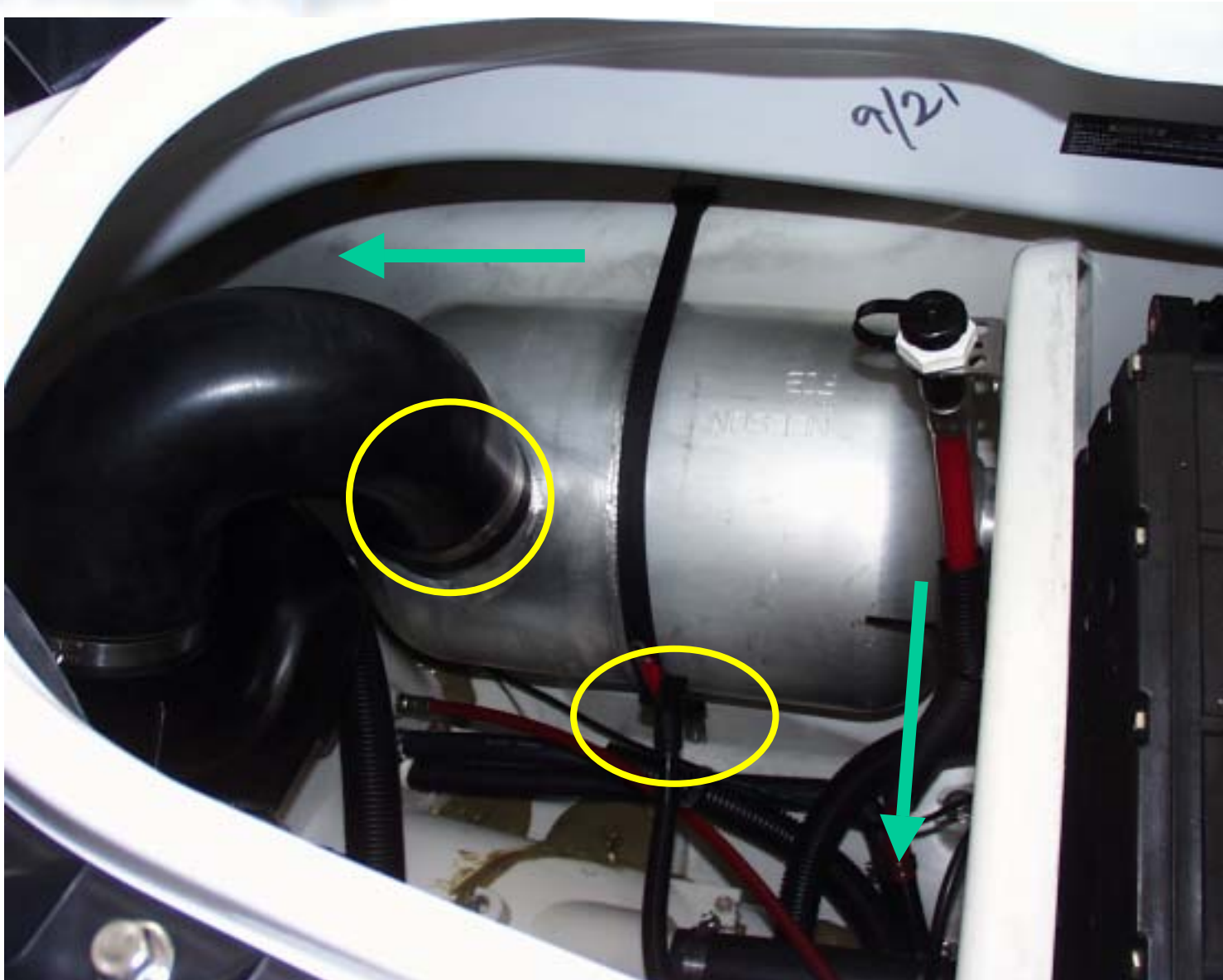

PULL OUT from BHD hole

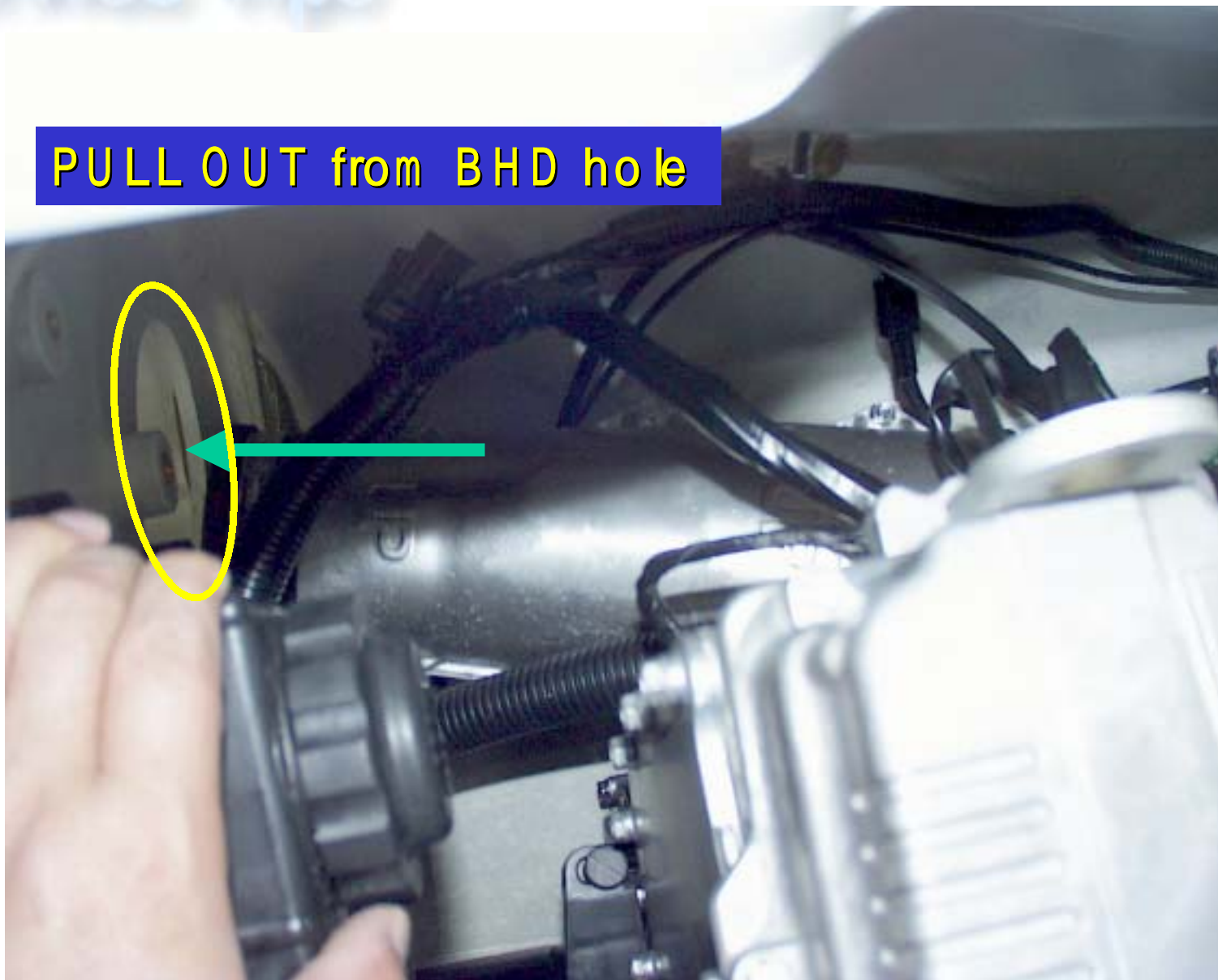



UP mark indicated



# Engine Removing

SERVICE TIPS



○ Screw x 2

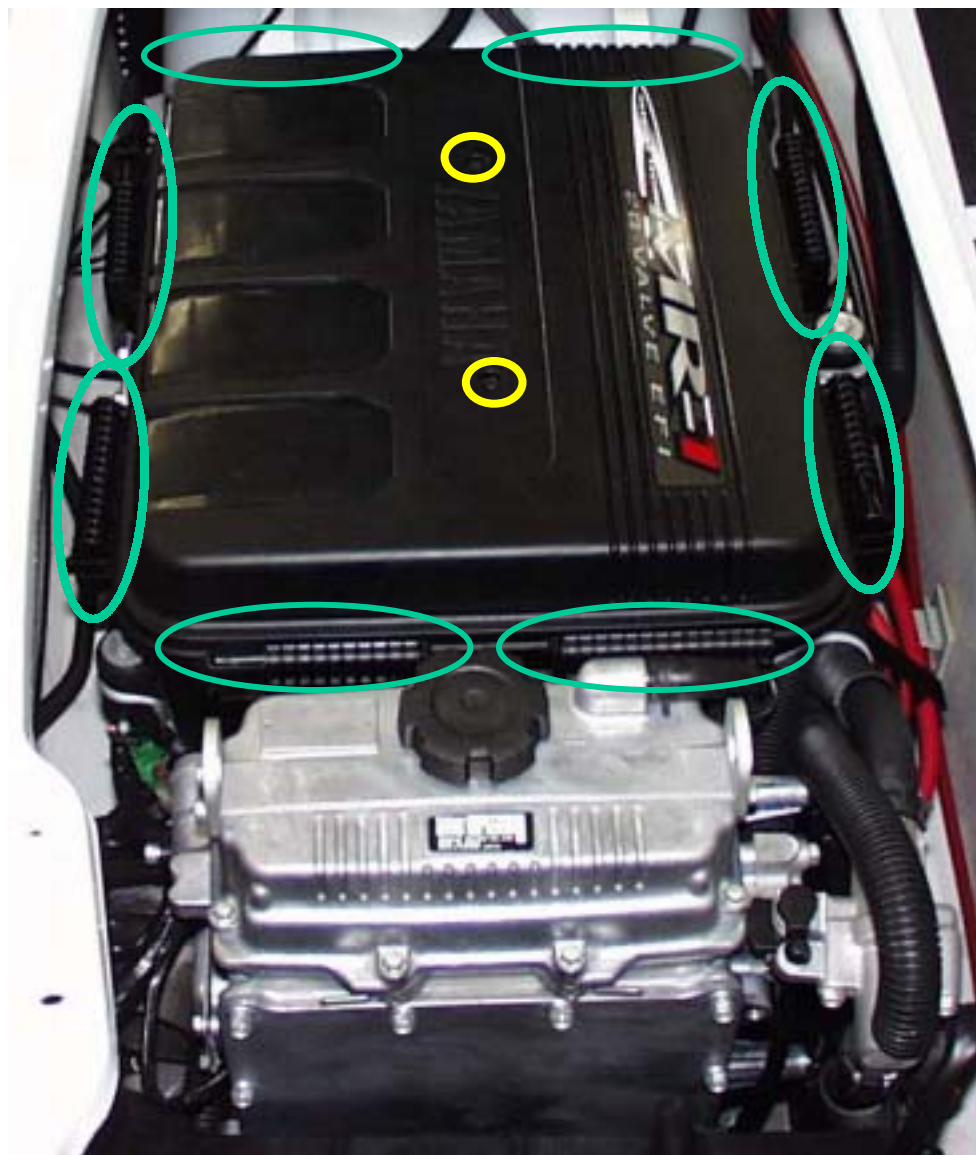

Engine Removing

Service Tips



# Engine Removing

Service Tips



# Engine Removing Service Tips

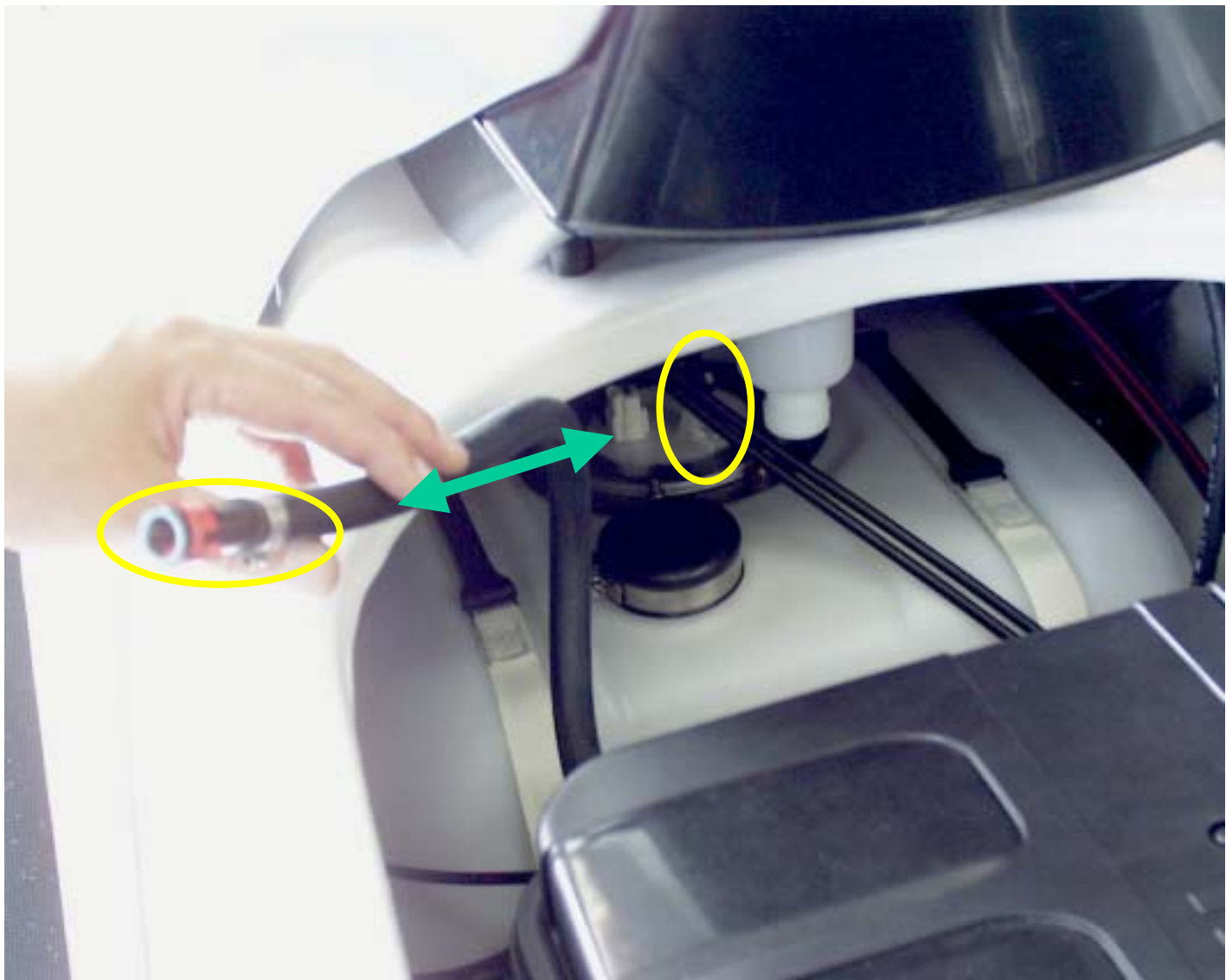

# Engine Removing SERVICE TIPS



**CAUTION!**  
Do not damage the plastic parts



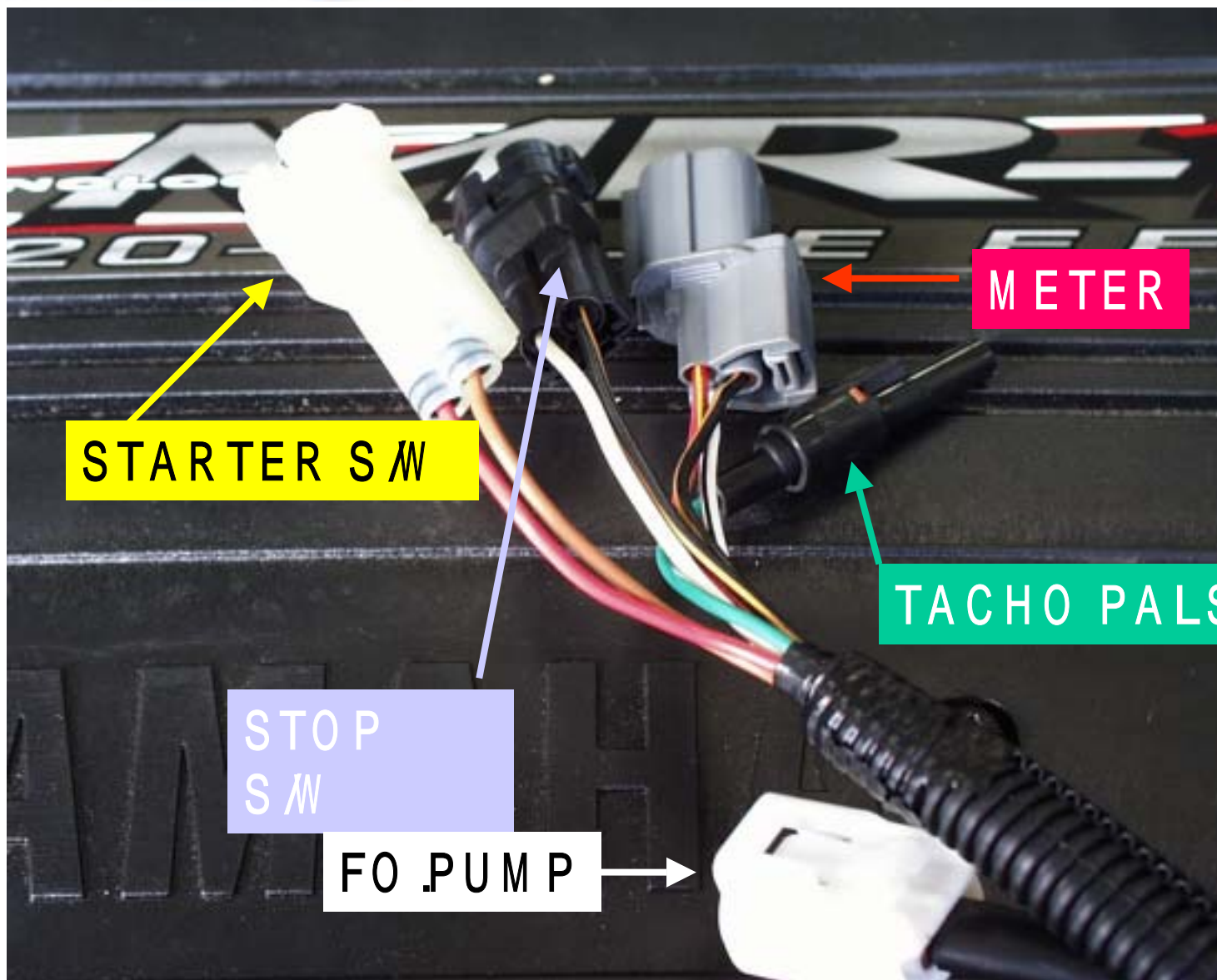

STARTER SW

STOP SW

FO .PUM P

TACHO PULSE

METER

# Engine Removing

Service Tips

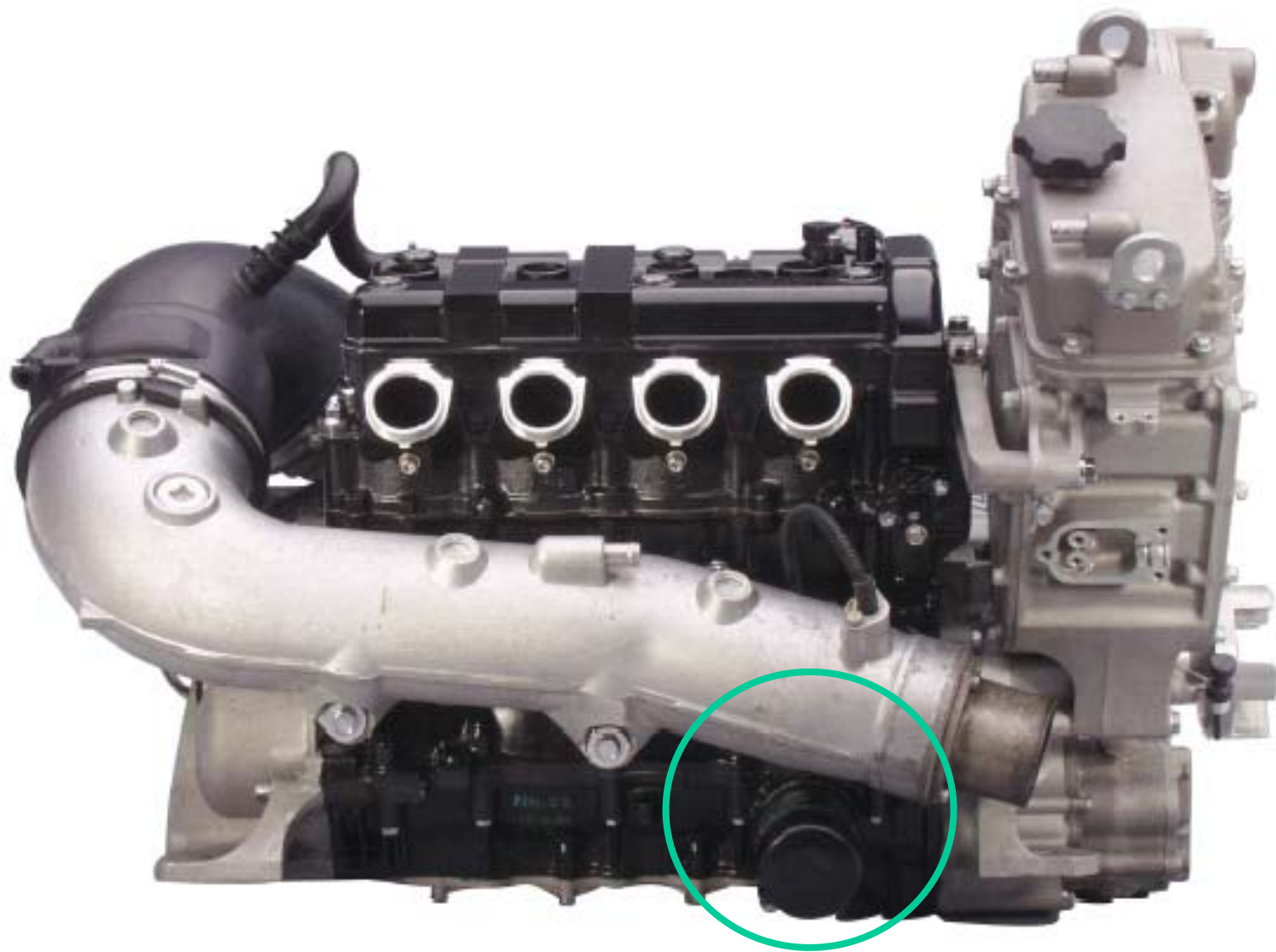

# Engine Removing

## SERVICE TIPS





# Engine Removing

Service Tips

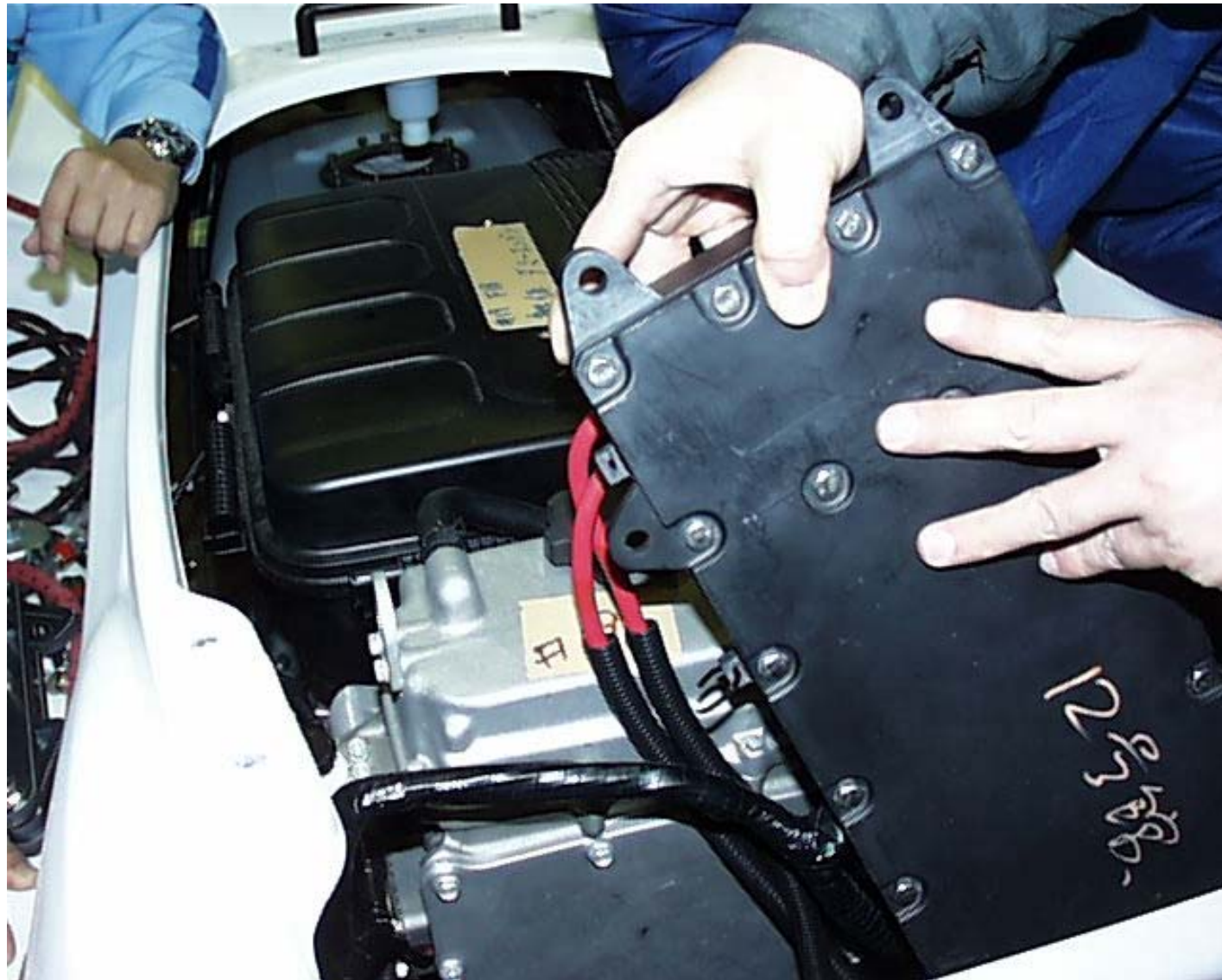

# Engine Removing

Service Tips



# Engine Removing

SERVICE TIPS



# Engine Removing

SERVICE TIPS

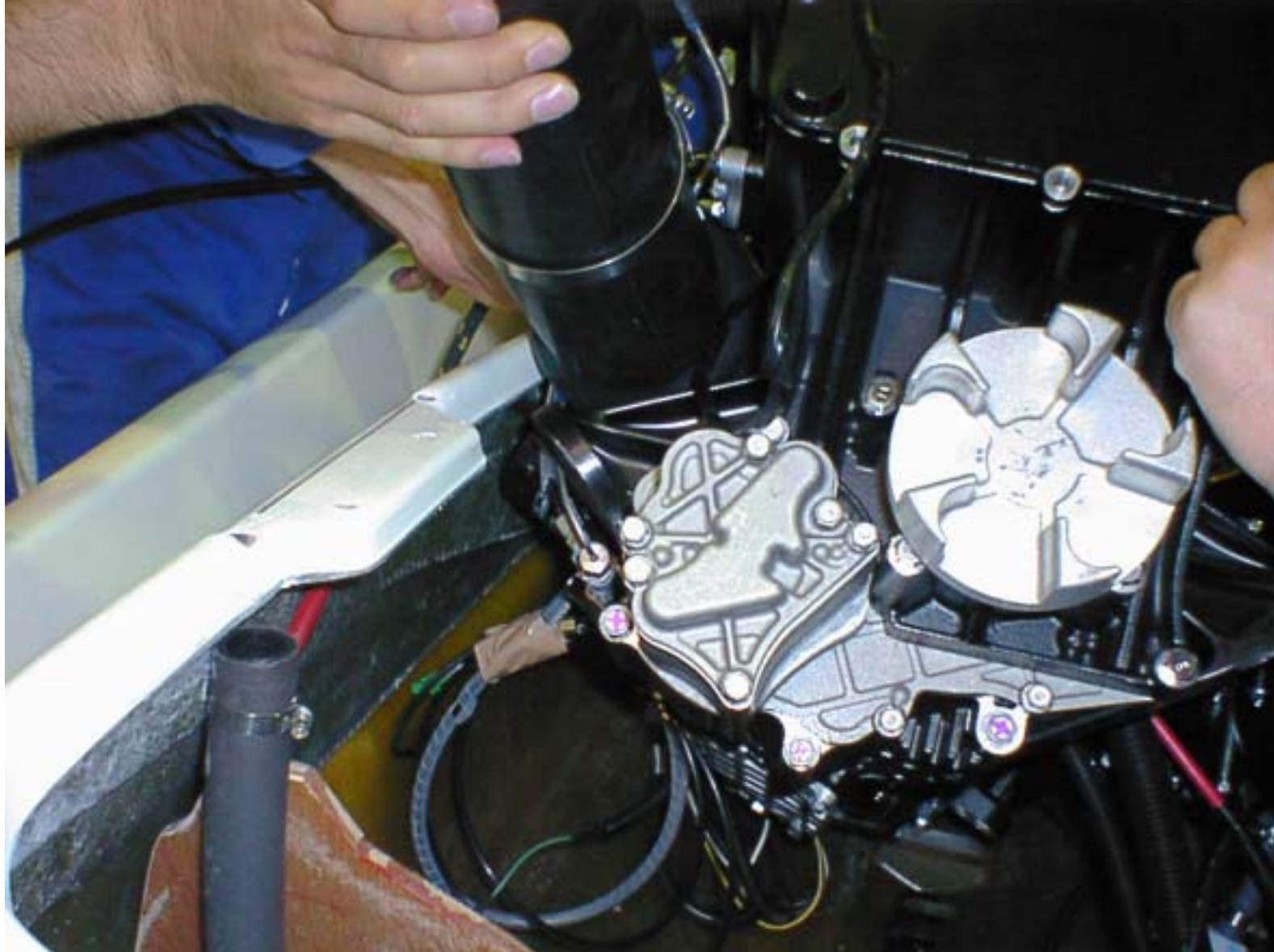

# Engine Removing

Service Tips

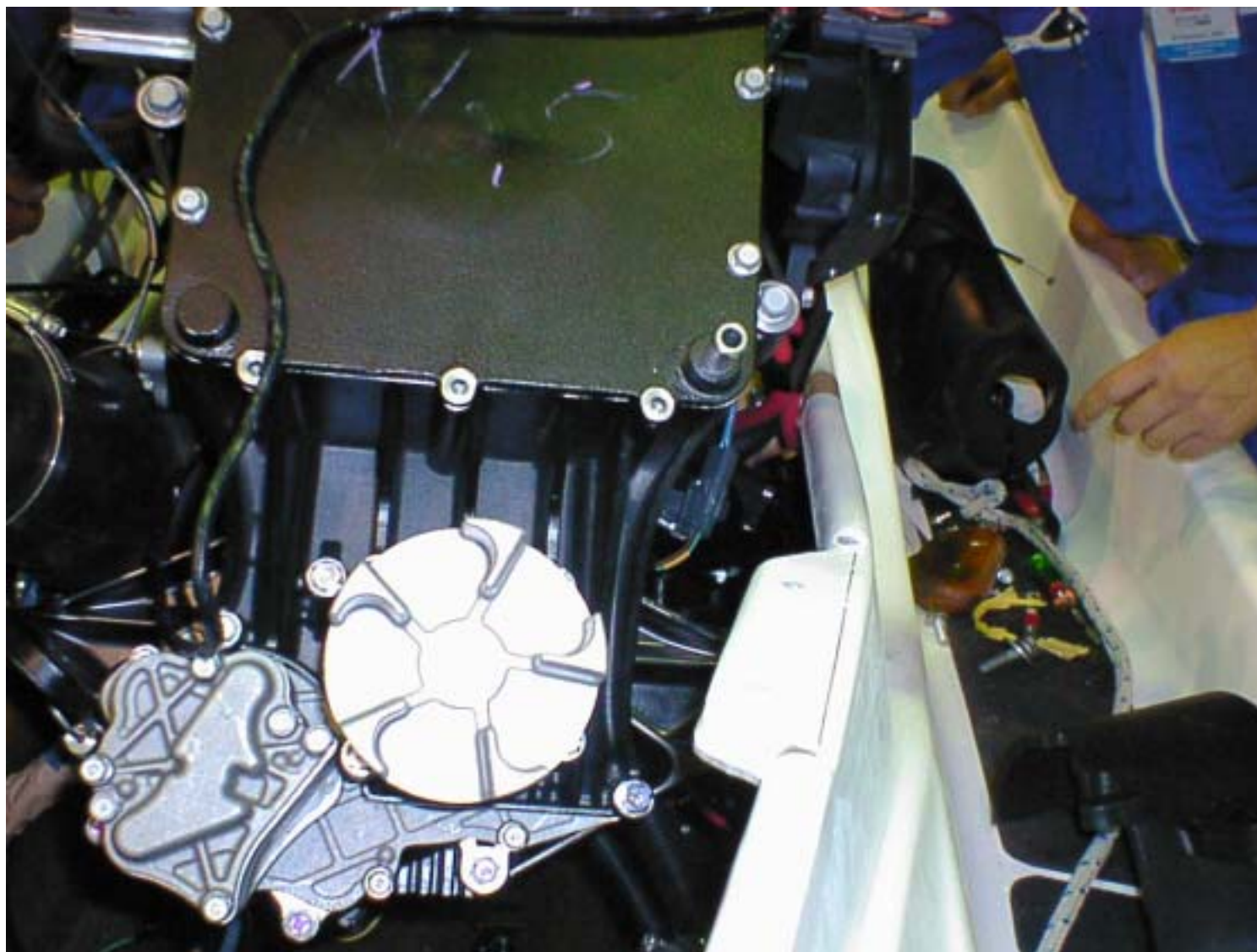

# Engine Removing

## SERVICE TIPS

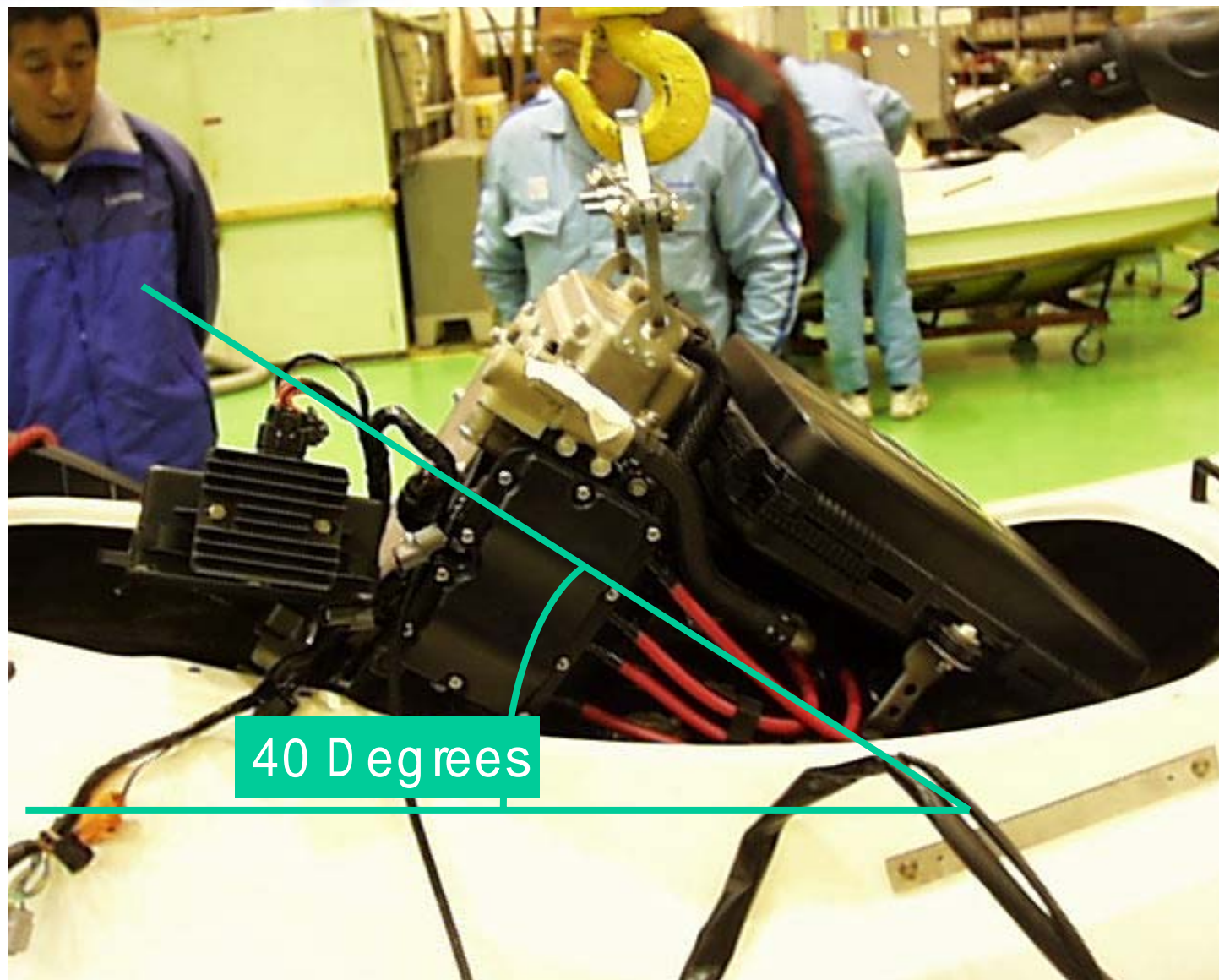

40 Degrees

# Engine Removing

Service Tips



# Engine Removing

Service Tips

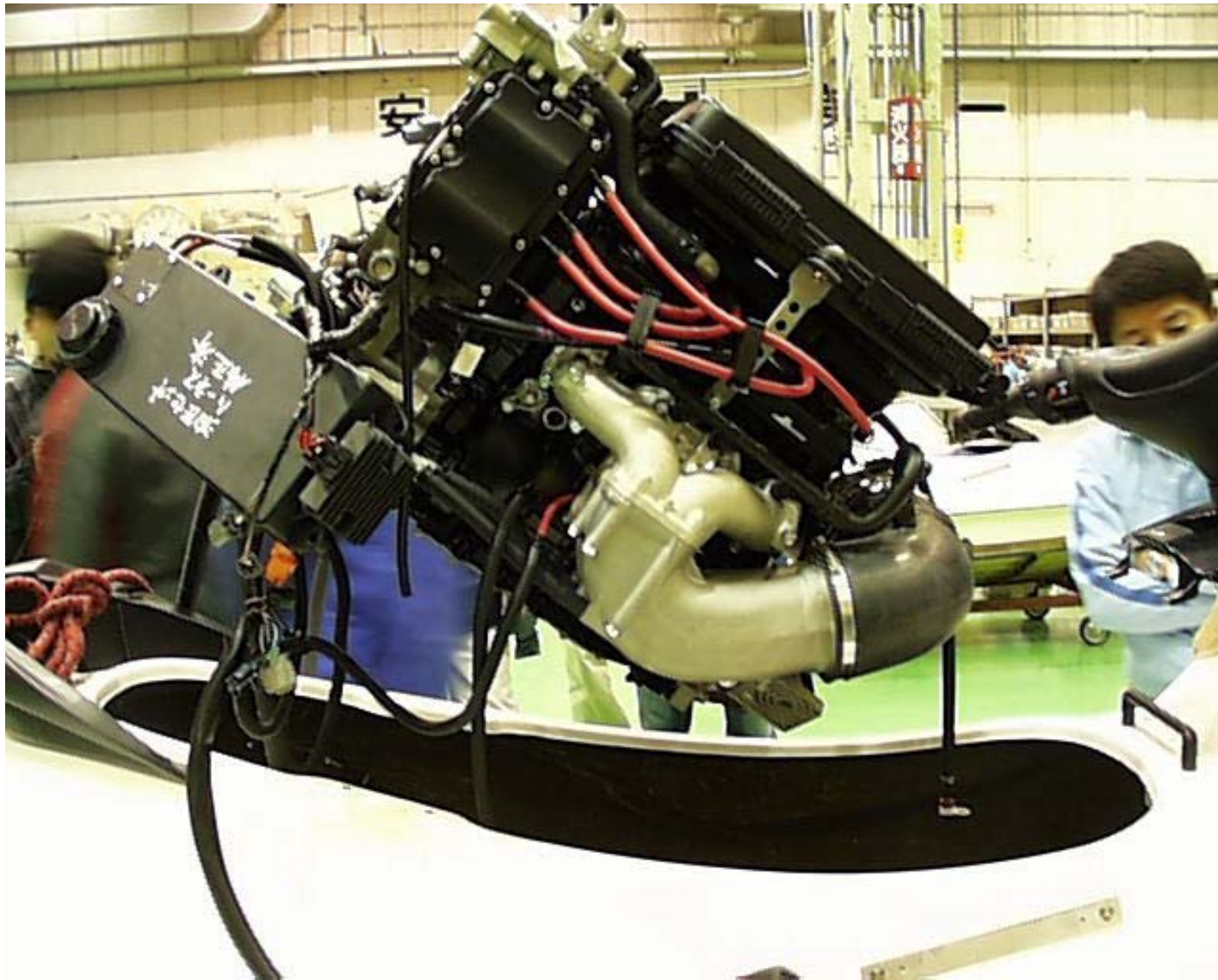



➤ Valve Clearance

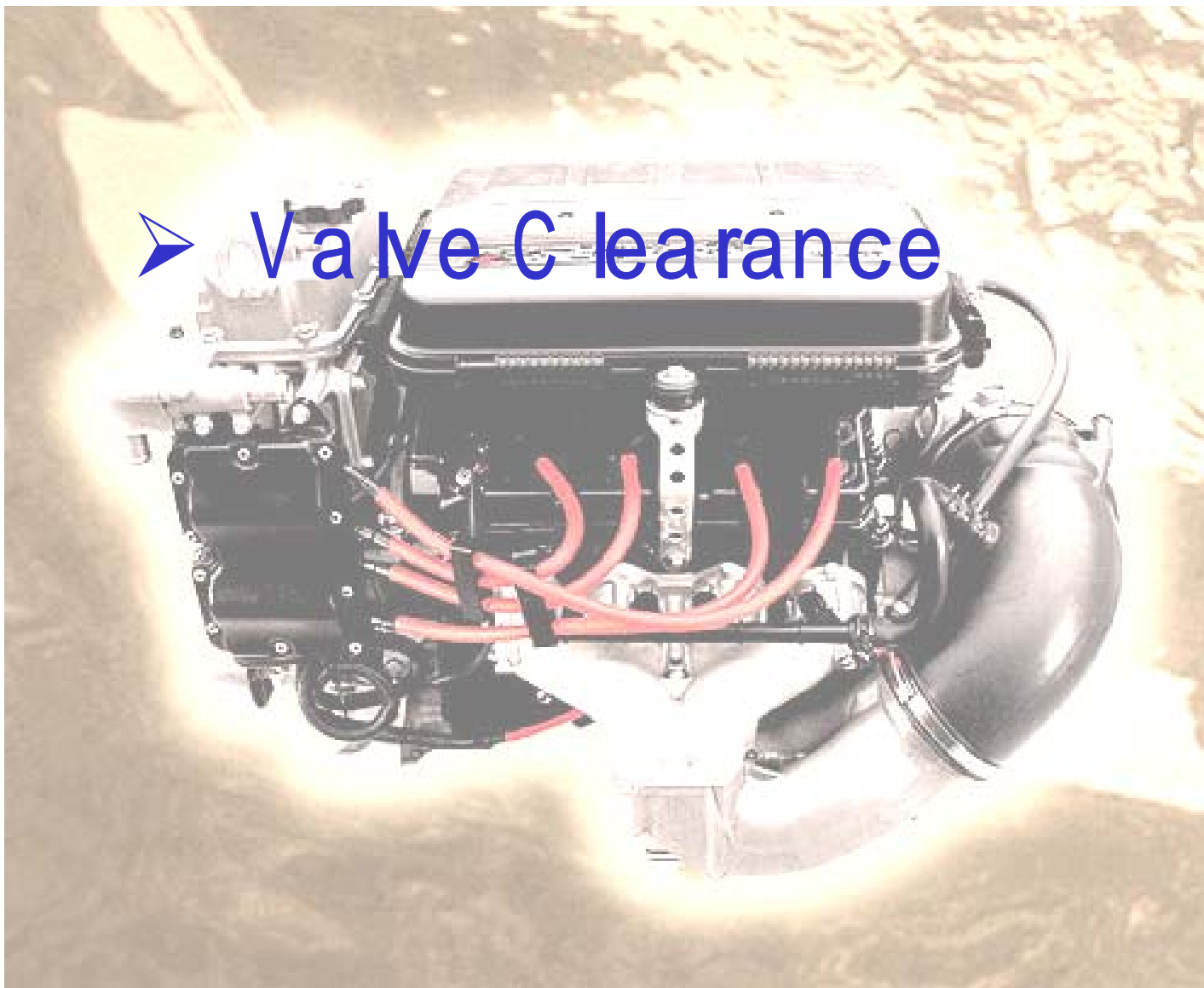

	Subjects	Notes
1.	Air cleaner case cover	
2.	Air filter	
3.	Frame arrester assy	
4.	Throttle cable (at the engine end)	
5.	Fuel hose connector	Disconnect with cbth to avoid spread out of a fuel
6.	Throttle body assy	
7.	Air cleaner case (bottom)	
8.	Head cover assy	
9.	Spark plugs	
10.	Align the mark on cam shaft (exhaust & intake) and cam shaft cover	by rotating the crankshaft (if you check without removing the complete engine from the unit, use SST for rotate by sprocket
11.	Check clearance for all valve from	Out of specification: Follow to next step
12.	Return to No.10 (Align cam shaft), then make a mark for both of the sprockets and	Mark on both exhaust & intake. This is for easy installation of a line to set the chain and sprockets
13.	Make a free the chain tensioner	Return the screw till end
14.	Cam shafts (exhaust, intake)	Do not make any damage the cam shafts
15.	Valve lifters	Control a position of all lifters (do not mix up)
16.	Pads	Do it to
17.	Calculate a correct pads size	
18.	Assemble to return till No.10 to the above	Set the cam shaft and the chain with aligning the marks on the above No.12. About the chain tensioner; tighten fully

# Valve Clearance

## Service Tips

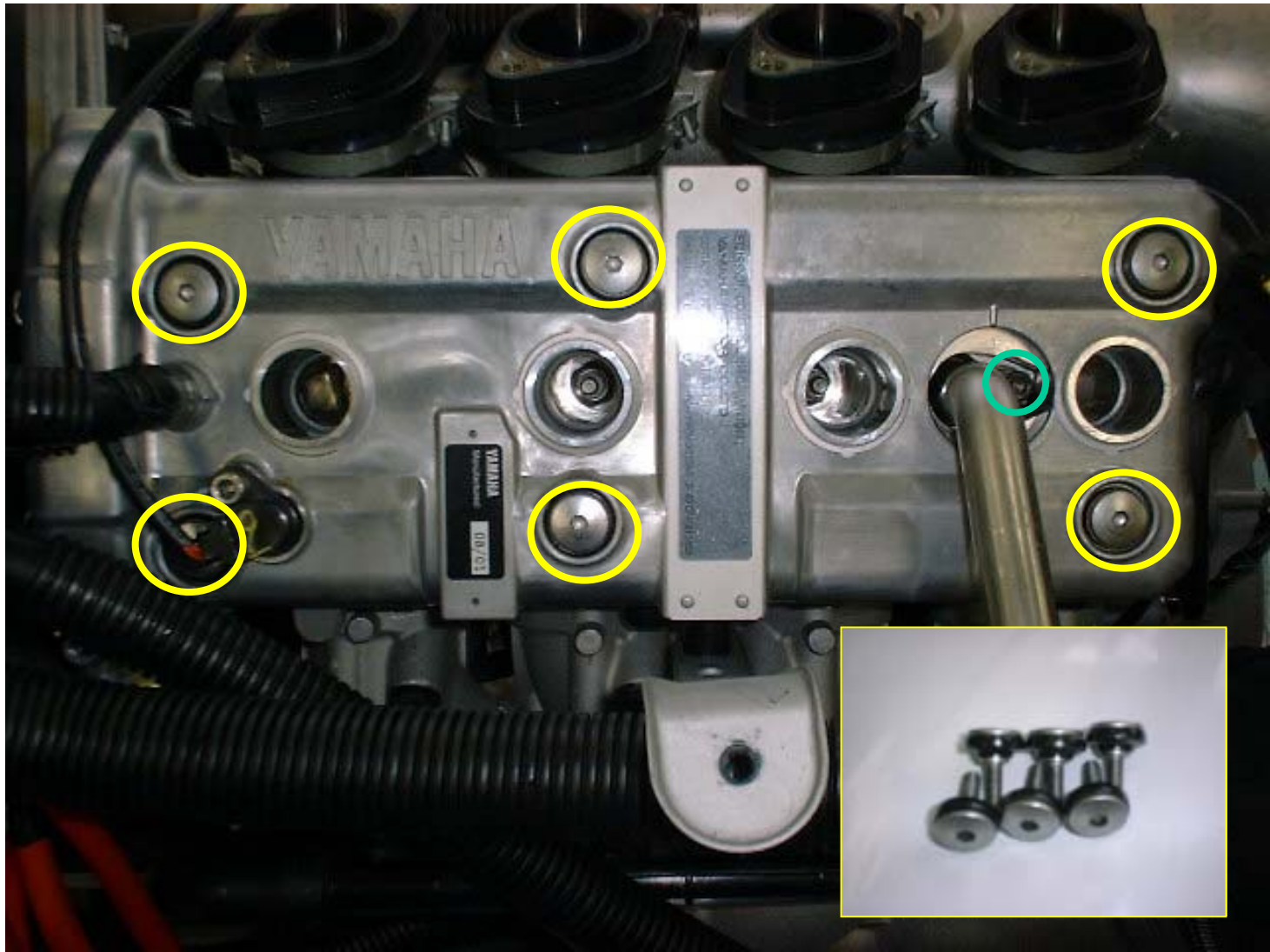

# Valve Clearance

## Service Tips



# Valve Clearance

Service Tips

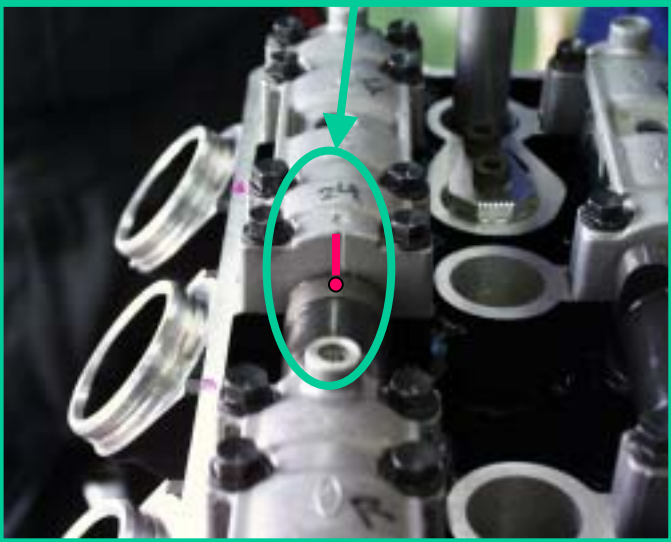
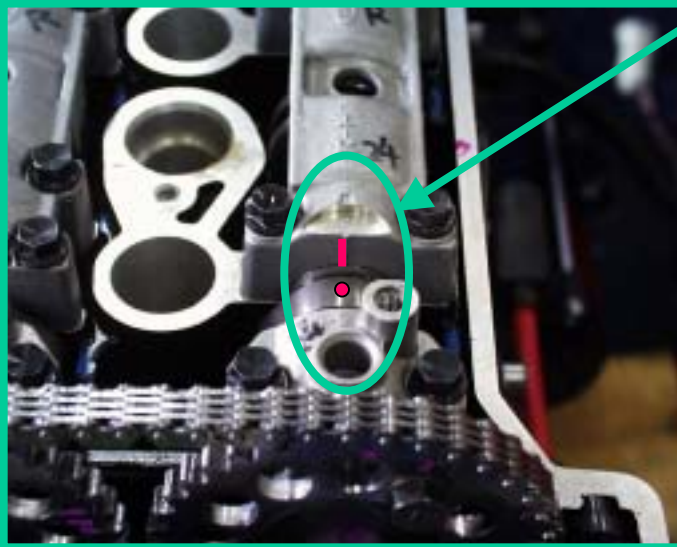
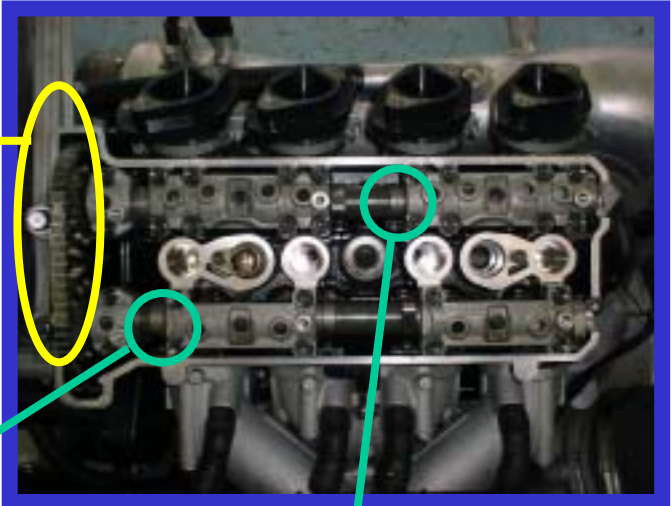
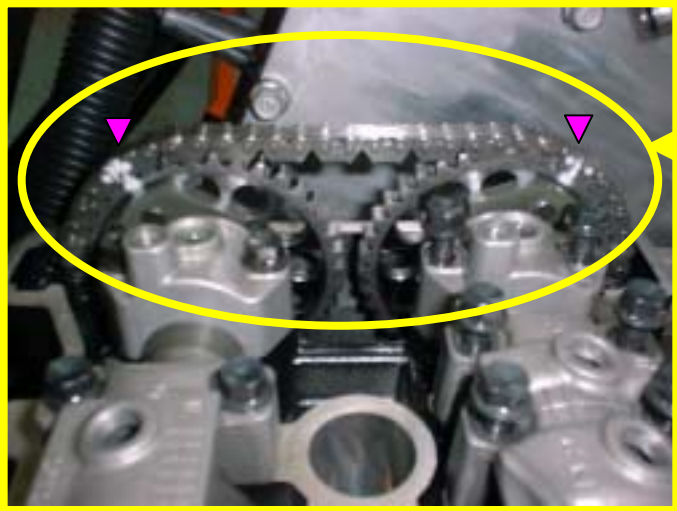

# Valve Clearance

## Service Tips

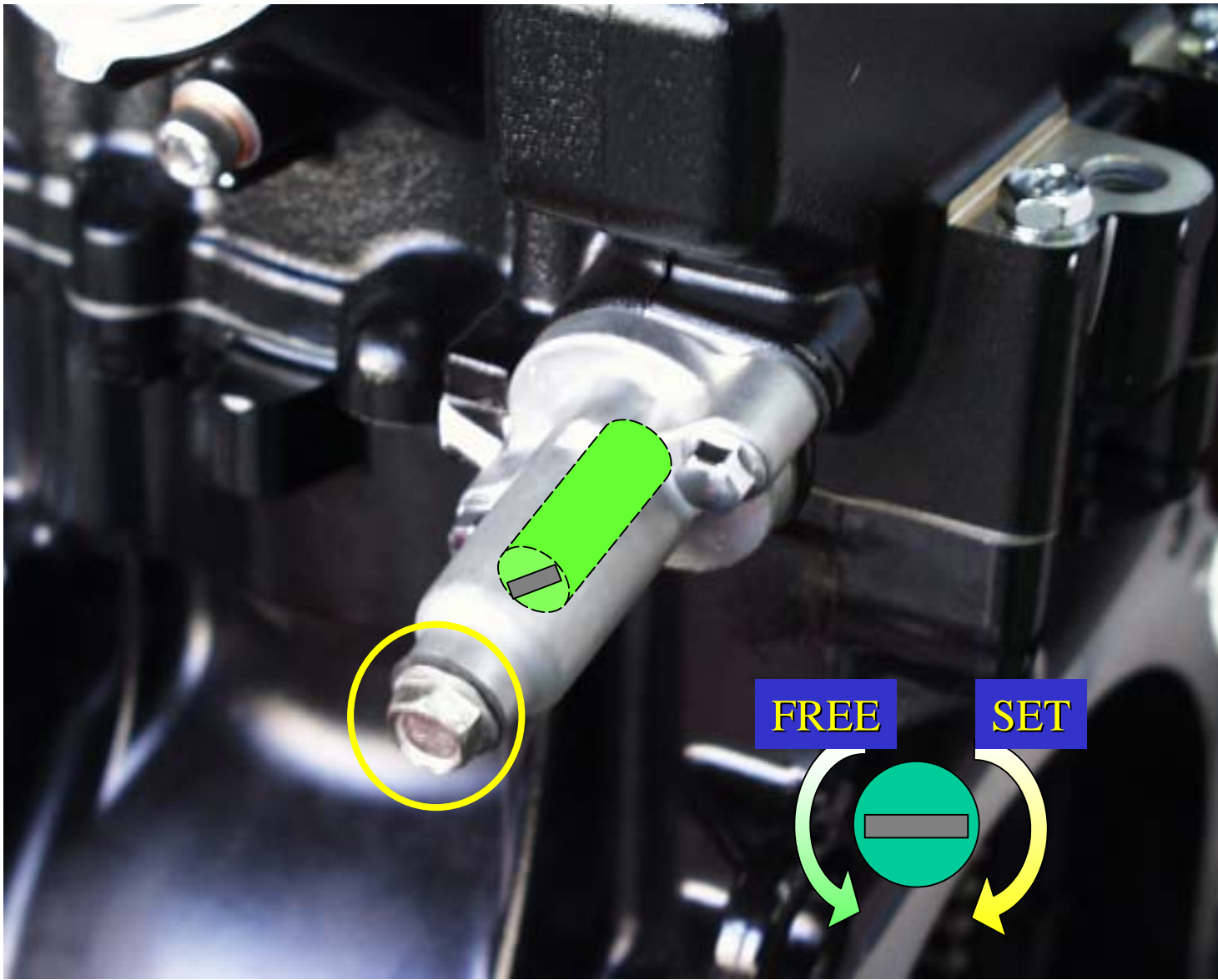

# Valve Clearance

## Service Tips

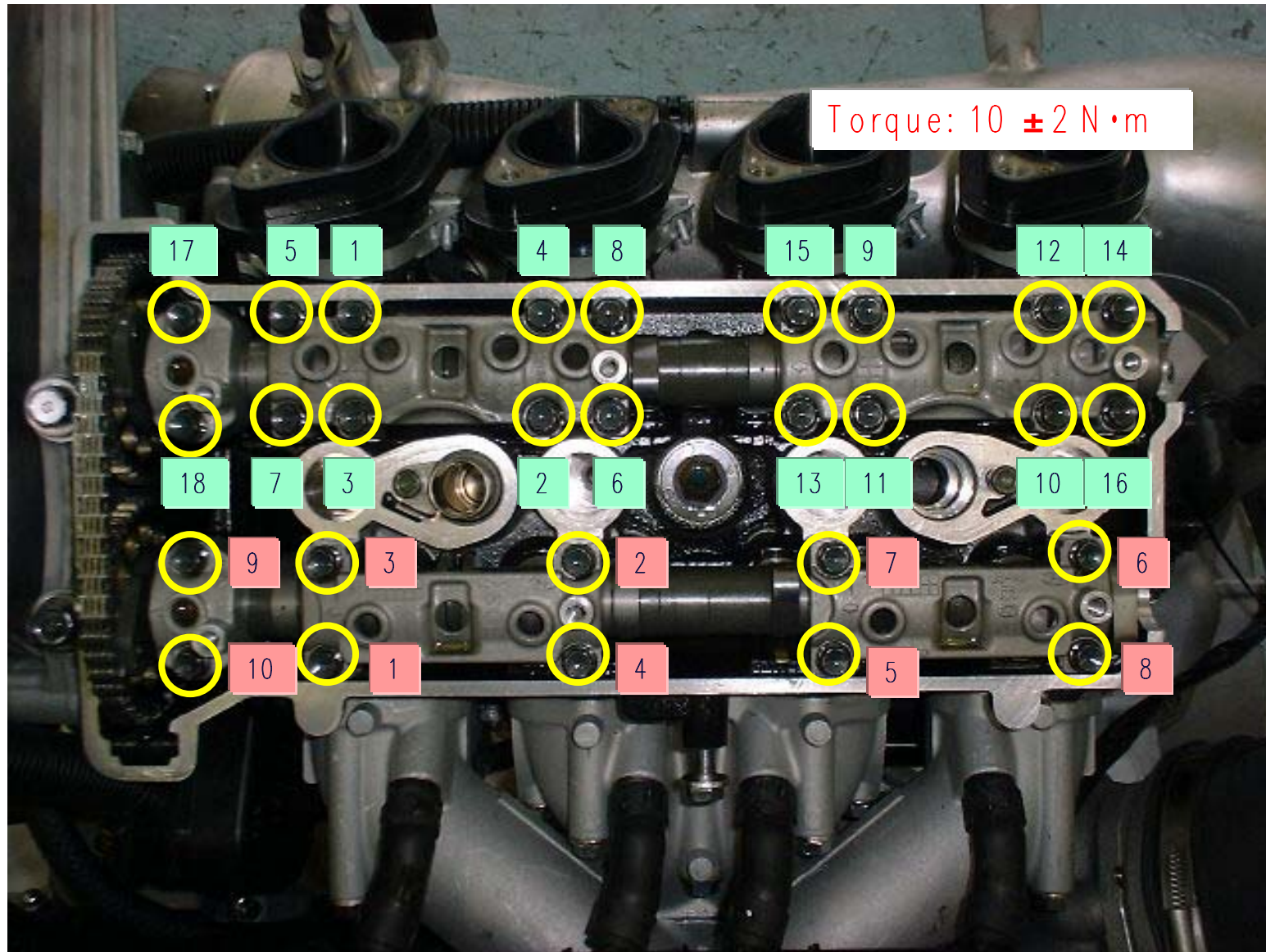

# Valve Clearance

## Service Tips

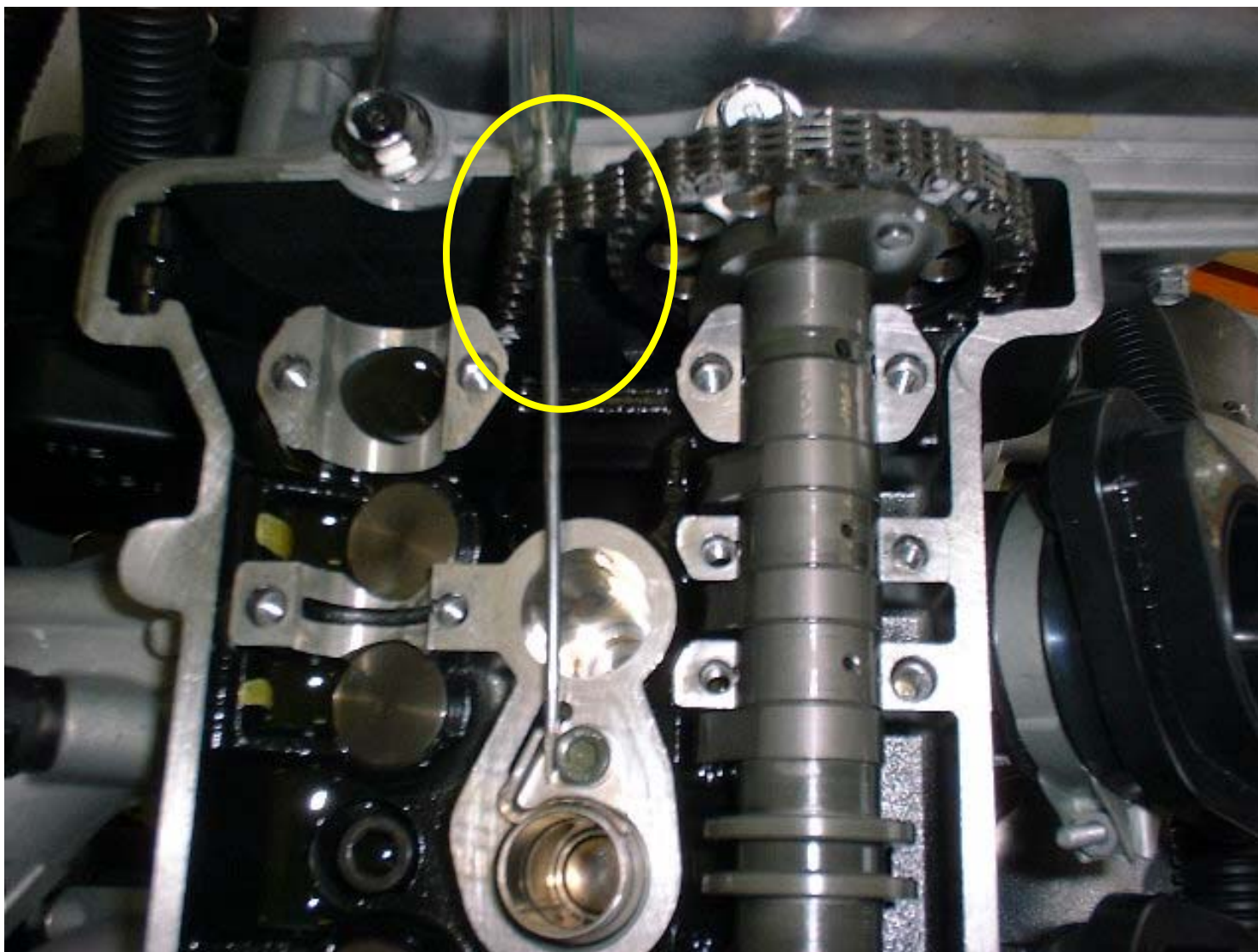



# Valve Clearance

Service Tips



**INTAKE**



**EXHAUST**



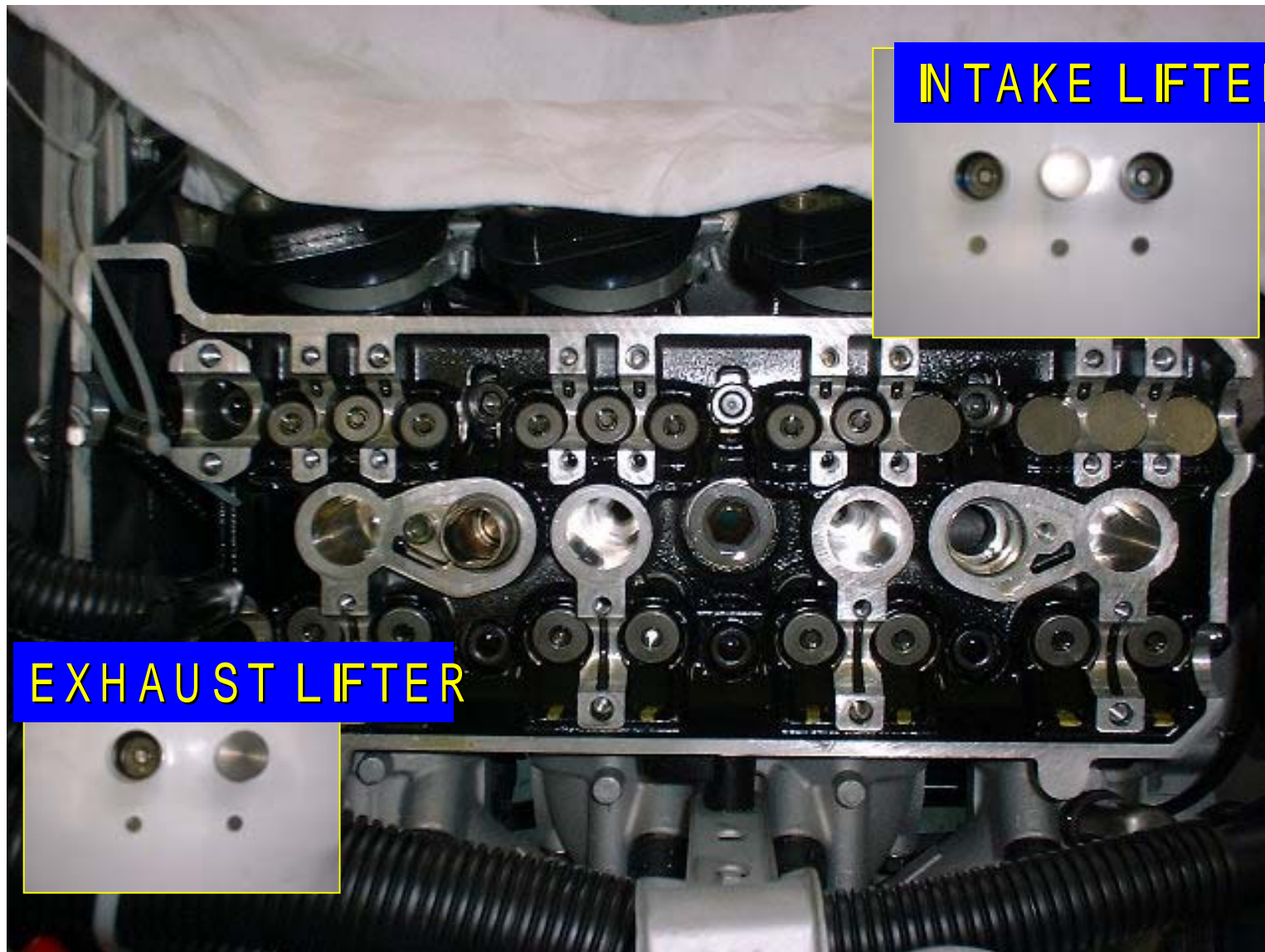

INTAKE LIFTER

EXHAUST LIFTER

# Valve Clearance

## Service Tips

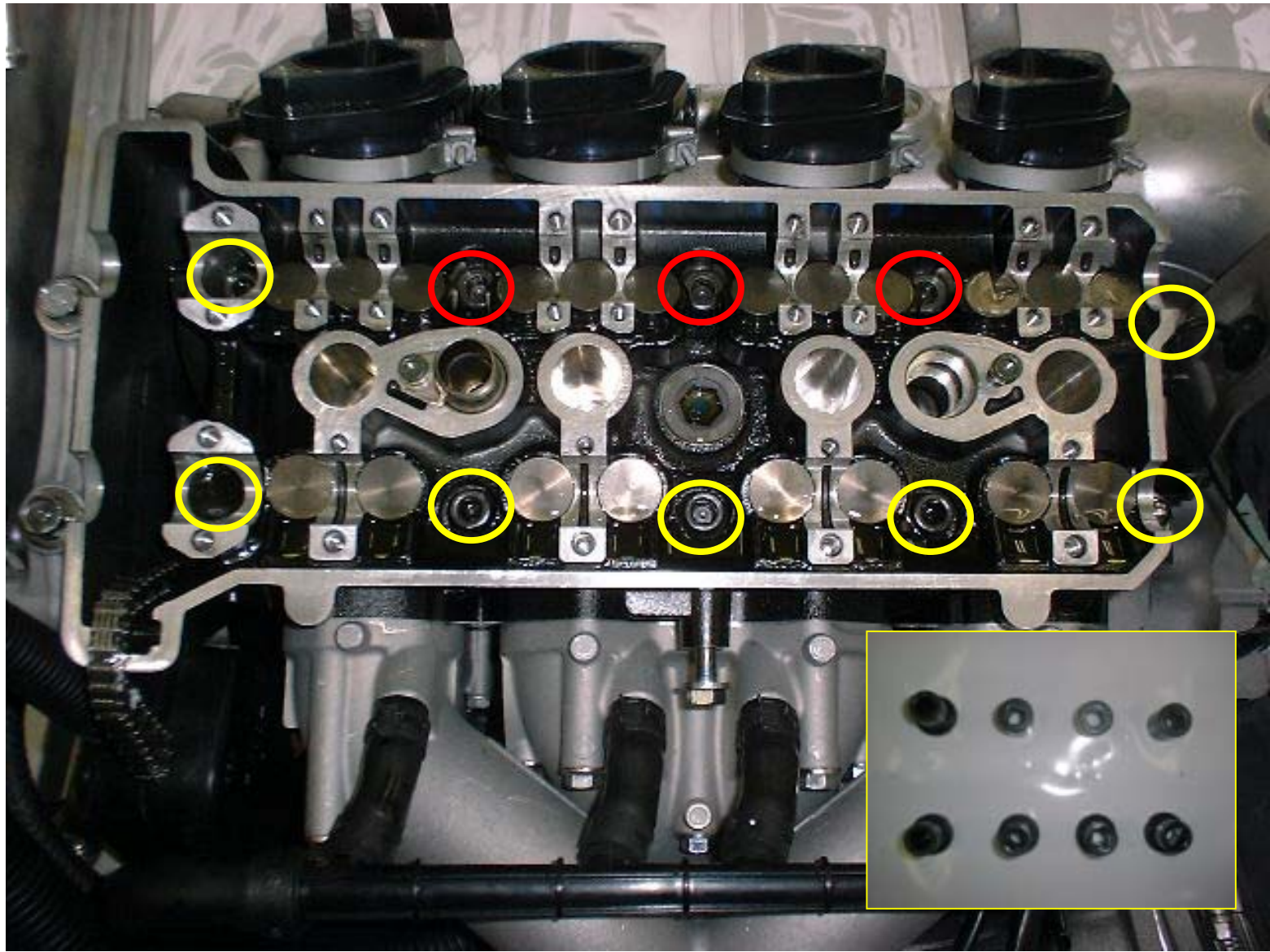

MEASURED CLEARANCE	ORIGINAL VALVE PAD NUMBER																											
	120	125	130	135	140	145	150	155	160	165	170	175	180	185	190	195	200	205	210	215	220	225	230	235	240			
0.00 - 0.02				120	125	130	135	140	145	150	155	160	165	170	175	180	185	190	195	200	205	210	215	220	225	230	235	240
0.03 - 0.07			120	125	130	135	140	145	150	155	160	165	170	175	180	185	190	195	200	205	210	215	220	225	230	235	240	
0.08 - 0.10		120	125	130	135	140	145	150	155	160	165	170	175	180	185	190	195	200	205	210	215	220	225	230	235	240		
0.11 - 0.20	STANDARD CLEARANCE																											
0.21 - 0.22	125	130	135	140	145	150	155	160	165	170	175	180	185	190	195	200	205	210	215	220	225	230	235	240				
0.23 - 0.27	130	135	140	145	150	155	160	165	170	175	180	185	190	195	200	205	210	215	220	225	230	235	240					
0.28 - 0.32	135	140	145	150	155	160	165	170	175	180	185	190	195	200	205	210	215	220	225	230	235	240						
0.33 - 0.37	140	145	150	155	160	165	170	175	180	185	190	195	200	205	210	215	220	225	230	235	240							
0.38 - 0.42	145	150	155	160	165	170	175	180	185	190	195	200	205	210	215	220	225	230	235	240								
0.43 - 0.47	150	155	160	165	170	175	180	185	190	195	200	205	210	215	220	225	230	235	240									
0.48 - 0.52	155	160	165	170	175	180	185	190	195	200	205	210	215	220	225	230	235	240										
0.53 - 0.57	160	165	170	175	180	185	190	195	200	205	210	215	220	225	230	235	240											
0.58 - 0.62	165	170	175	180	185	190	195	200	205	210	215	220	225	230	235	240												
0.63 - 0.67	170	175	180	185	190	195	200	205	210	215	220	225	230	235	240													
0.68 - 0.72	175	180	185	190	195	200	205	210	215	220	225	230	235	240														
0.73 - 0.77	180	185	190	195	200	205	210	215	220	225	230	235	240															
0.78 - 0.82	185	190	195	200	205	210	215	220	225	230	235	240																
0.83 - 0.87	190	195	200	205	210	215	220	225	230	235	240																	
0.88 - 0.92	195	200	205	210	215	220	225	230	235	240																		
0.93 - 0.97	200	205	210	215	220	225	230	235	240																			
0.98 - 1.02	205	210	215	220	225	230	235	240																				
1.03 - 1.07	210	215	220	225	230	235	240																					
1.08 - 1.12	215	220	225	230	235	240																						
1.13 - 1.17	220	225	230	235	240																							
1.18 - 1.22	225	230	235	240																								
1.23 - 1.27	230	235	240																									
1.28 - 1.32	235	240																										
1.33 - 1.37	240																											

**Example:**

**Intake Valve Clearance (cold)**

**0.11-0.20 mm**

**Rounded value 150**

**Measured valve clearance is 0.24 mm**

**Replace pad 150 with pad 160**

**Pad No. 150 = 1.50 mm**

**Pad No. 160 = 1.60 mm**

MEASURED CLEARANCE	ORIGINAL VALVE PAD NUMBER																								
	120	125	130	135	140	145	150	155	160	165	170	175	180	185	190	195	200	205	210	215	220	225	230	235	240
0.00 - 0.01							120	125	130	135	140	145	150	155	160	165	170	175	180	185	190	195	200	205	210
0.02 - 0.06						120	125	130	135	140	145	150	155	160	165	170	175	180	185	190	195	200	205	210	215
0.07 - 0.11					120	125	130	135	140	145	150	155	160	165	170	175	180	185	190	195	200	205	210	215	220
0.12 - 0.16				120	125	130	135	140	145	150	155	160	165	170	175	180	185	190	195	200	205	210	215	220	225
0.17 - 0.21			120	125	130	135	140	145	150	155	160	165	170	175	180	185	190	195	200	205	210	215	220	225	230
0.22 - 0.24		120	125	130	135	140	145	150	155	160	165	170	175	180	185	190	195	200	205	210	215	220	225	230	235
0.25 - 0.34	STANDARD CLEARANCE																								
0.35 - 0.37	125	130	135	140	145	150	155	160	165	170	175	180	185	190	195	200	205	210	215	220	225	230	235	240	
0.38 - 0.42	130	135	140	145	150	155	160	165	170	175	180	185	190	195	200	205	210	215	220	225	230	235	240		
0.43 - 0.47	135	140	145	150	155	160	165	170	175	180	185	190	195	200	205	210	215	220	225	230	235	240			
0.48 - 0.52	140	145	150	155	160	165	170	175	180	185	190	195	200	205	210	215	220	225	230	235	240				
0.53 - 0.57	145	150	155	160	165	170	175	180	185	190	195	200	205	210	215	220	225	230	235	240					
0.58 - 0.62	150	155	160	165	170	175	180	185	190	195	200	205	210	215	220	225	230	235	240						
0.63 - 0.67	155	160	165	170	175	180	185	190	195	200	205	210	215	220	225	230	235	240							
0.68 - 0.72	160	165	170	175	180	185	190	195	200	205	210	215	220	225	230	235	240								
0.73 - 0.77	165	170	175	180	185	190	195	200	205	210	215	220	225	230	235	240									
0.78 - 0.82	170	175	180	185	190	195	200	205	210	215	220	225	230	235	240										
0.83 - 0.87	175	180	185	190	195	200	205	210	215	220	225	230	235	240											
0.88 - 0.92	180	185	190	195	200	205	210	215	220	225	230	235	240												
0.93 - 0.97	185	190	195	200	205	210	215	220	225	230	235	240													
0.98 - 1.02	190	195	200	205	210	215	220	225	230	235	240														
1.03 - 1.07	195	200	205	210	215	220	225	230	235	240															
1.08 - 1.12	200	205	210	215	220	225	230	235	240																
1.13 - 1.17	205	210	215	220	225	230	235	240																	
1.18 - 1.22	210	215	220	225	230	235	240																		
1.23 - 1.27	215	220	225	230	235	240																			
1.28 - 1.32	220	225	230	235	240																				
1.33 - 1.37	225	230	235	240																					
1.38 - 1.42	230	235	240																						
1.43 - 1.47	235	240																							
1.48 - 1.52	240																								

**Example:**

**Exhaust Valve Clearance (cold)**

**0.25-0.34 mm**

**Rounded value 170**

**Measured valve clearance is 0.45 mm**

**Replace pad 170 with pad 185**

**Pad No. 170 = 1.70 mm**

**Pad No. 185 = 1.85 mm**

➤ **Bearing Selection**

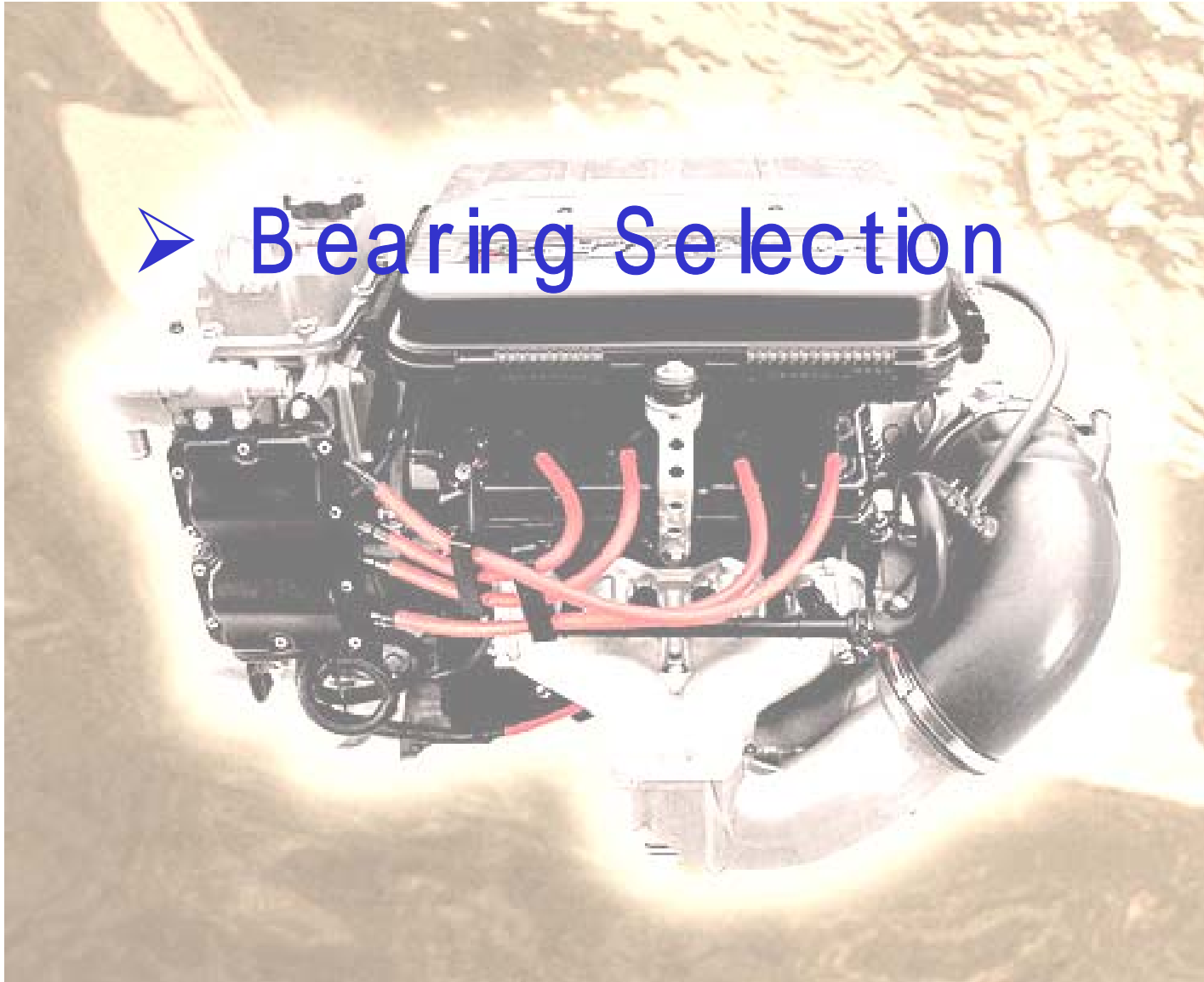

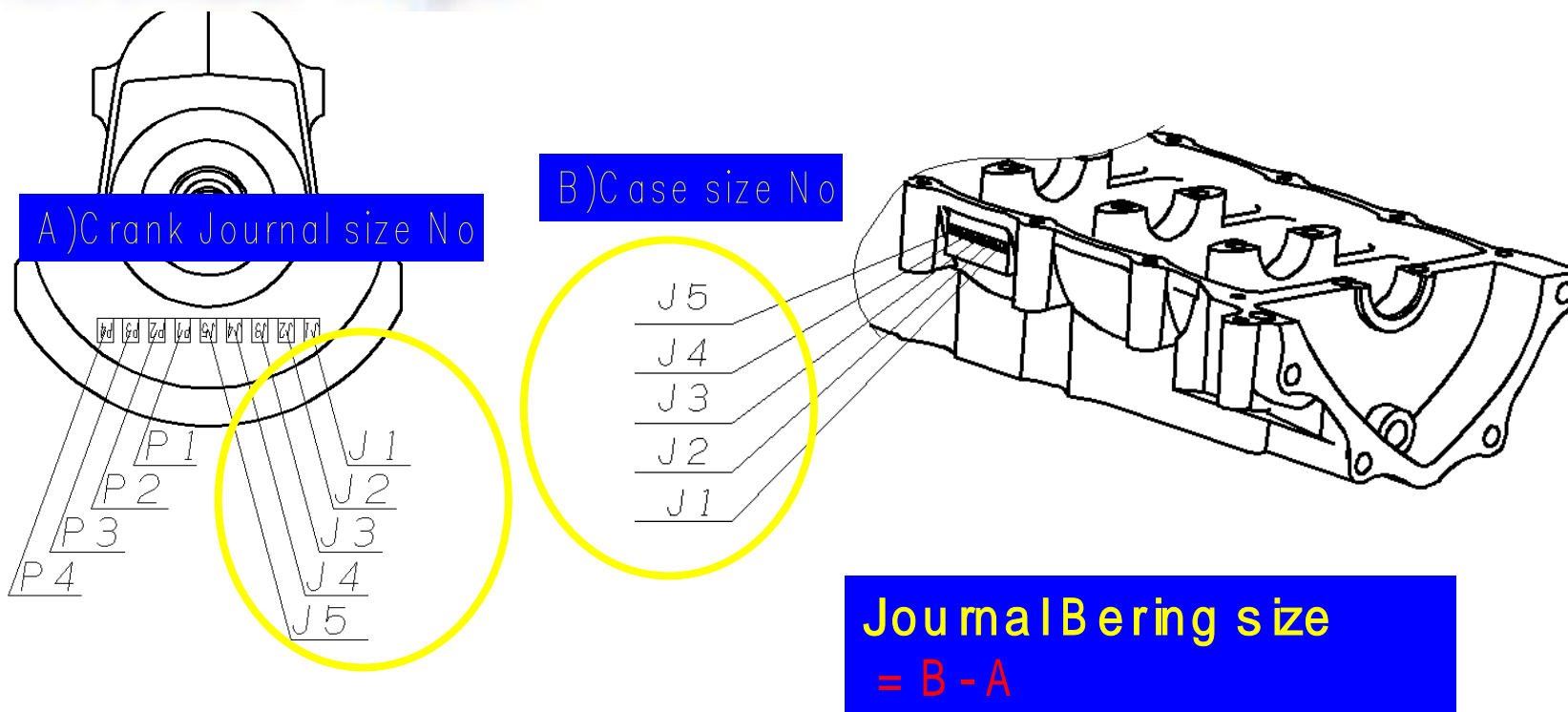

JOURNAL BEARING IDENTIFICATION				
BRG NO,	P.NO,	COLOR	THICKNESS	
1	60E-11416-00	BR	1.5	+0.010 ~ +0.014
2	60E-11416-10	B	1.5	+0.006 ~ +0.010
3	60E-11416-20	L	1.5	+0.002 ~ +0.006
4	60E-11416-30	G	1.5	-0.002 ~ +0.002
5	60E-11416-40	Y	1.5	-0.002 ~ -0.006

A) Crank pin size NO

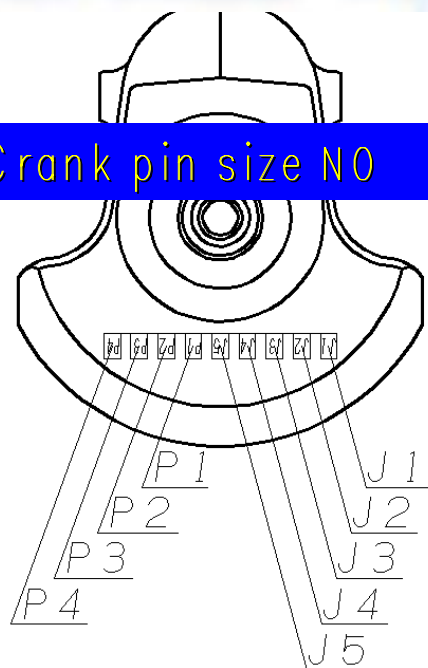

B) Con-rod big end size No

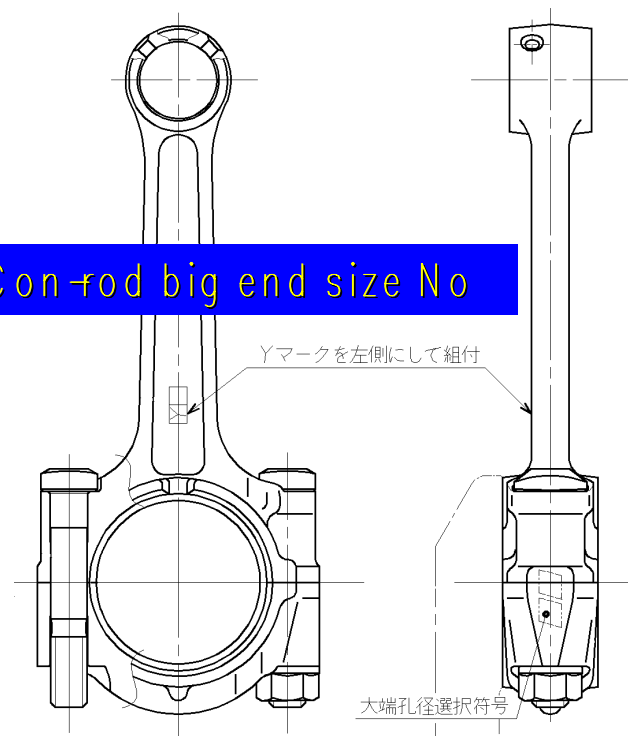

PIN BRG NO = B - A

CRANK PIN BEARING				
BRG NO,	P.NO,	Color	Thickness	
1	60E-11656-00	BR	1.5	0 ~ +0.004
2	60E-11656-10	B	1.5	-0.004 ~ 0
3	60E-11656-20	L	1.5	-0.004 ~ -0.008
4	60E-11656-30	G	1.5	-0.008 ~ +0.012



# Other Information



## ➤ Other Information

Oil system disassembly

Exhaust disassembly

Peak Voltage

Service material publication plan

Service Special Tools

Parts Information

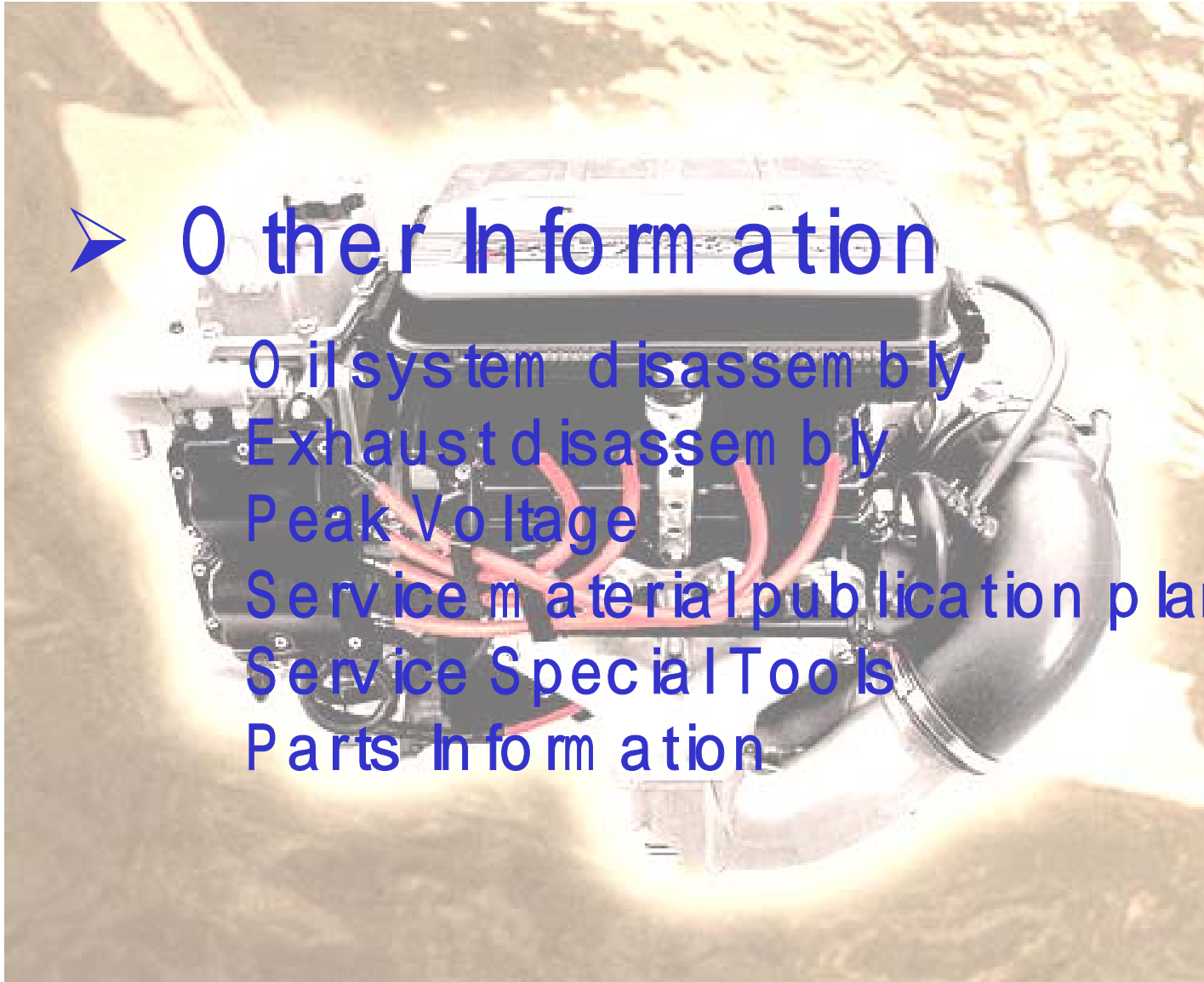

# Other Information



# Oil System Disassembly





TO FEED PUMP

FROM SCAVENGING PUMP

# Oil System Disassembly

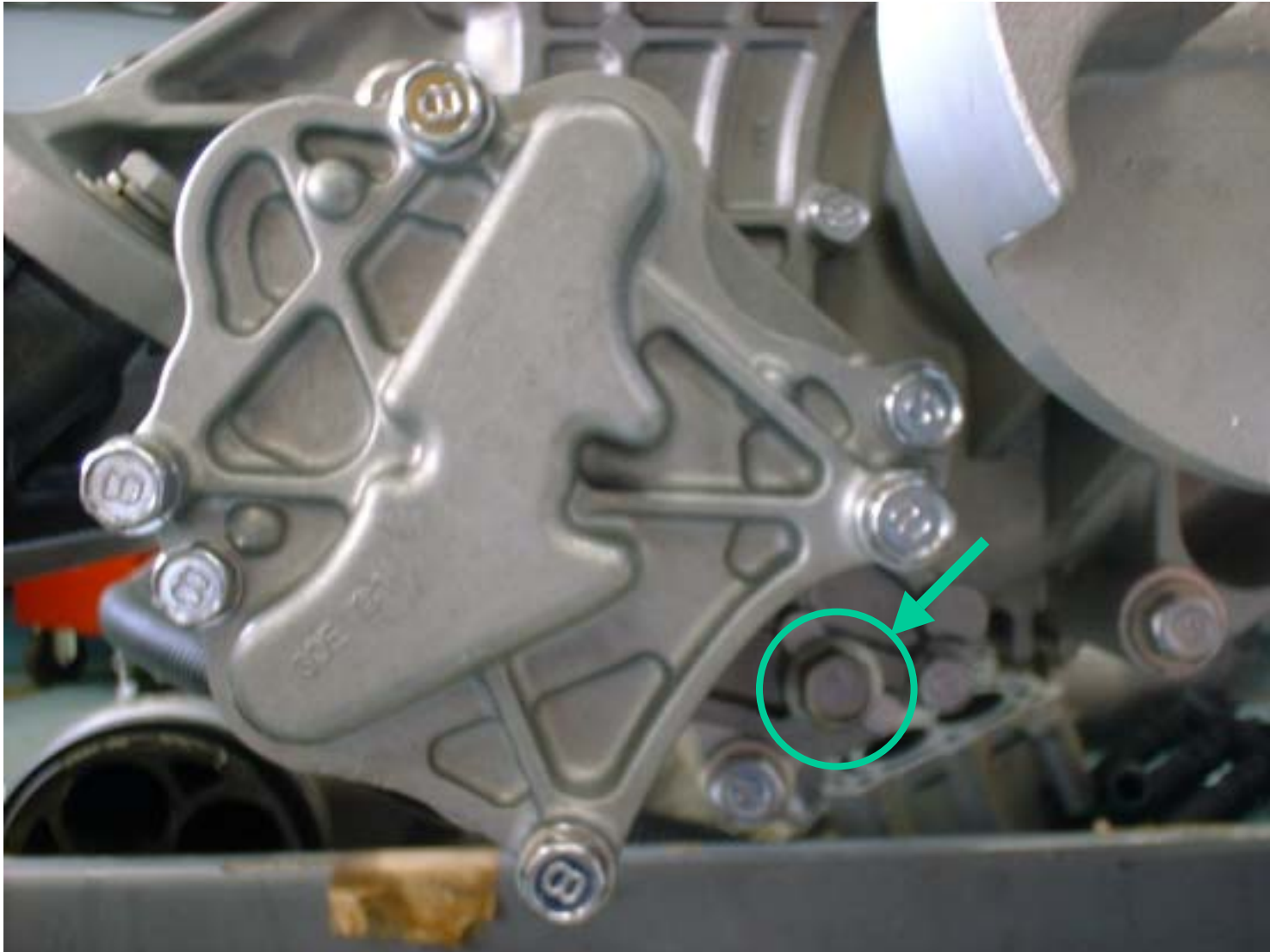

FEED PUMP ROUTE

SCAVENGING ROUTE

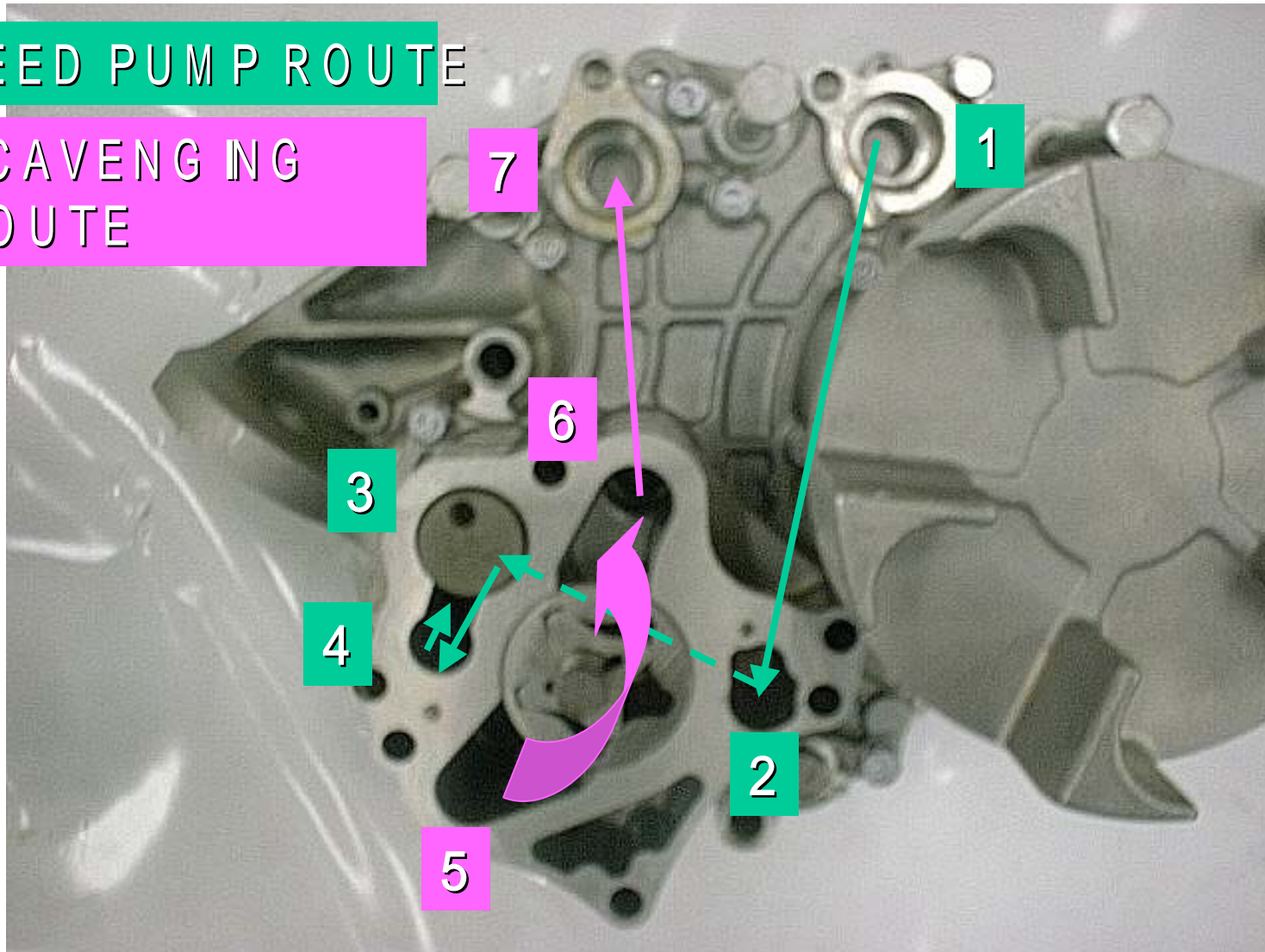

FEED PUMP ROUTE



SUPPLY OIL to ENGINE

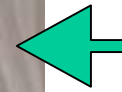

CORRECT OIL to OIL TANK

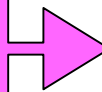

SCAVENGING ROUTE

# Oil System Disassembly



SCAV  
side



FEED  
side





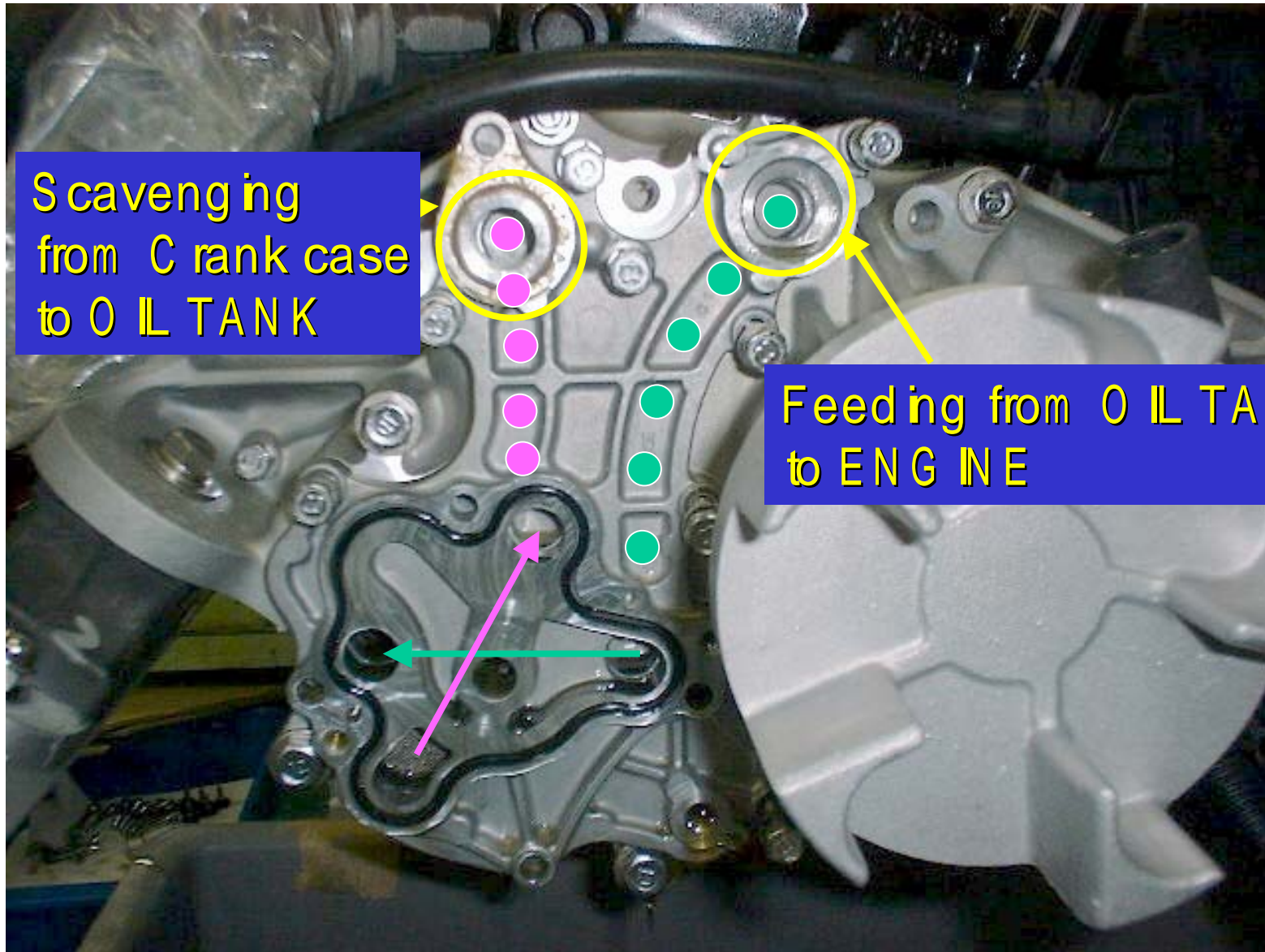

Scavenging  
from C rank case  
to O IL TANK

Feeding from O IL TANK  
to ENGINE

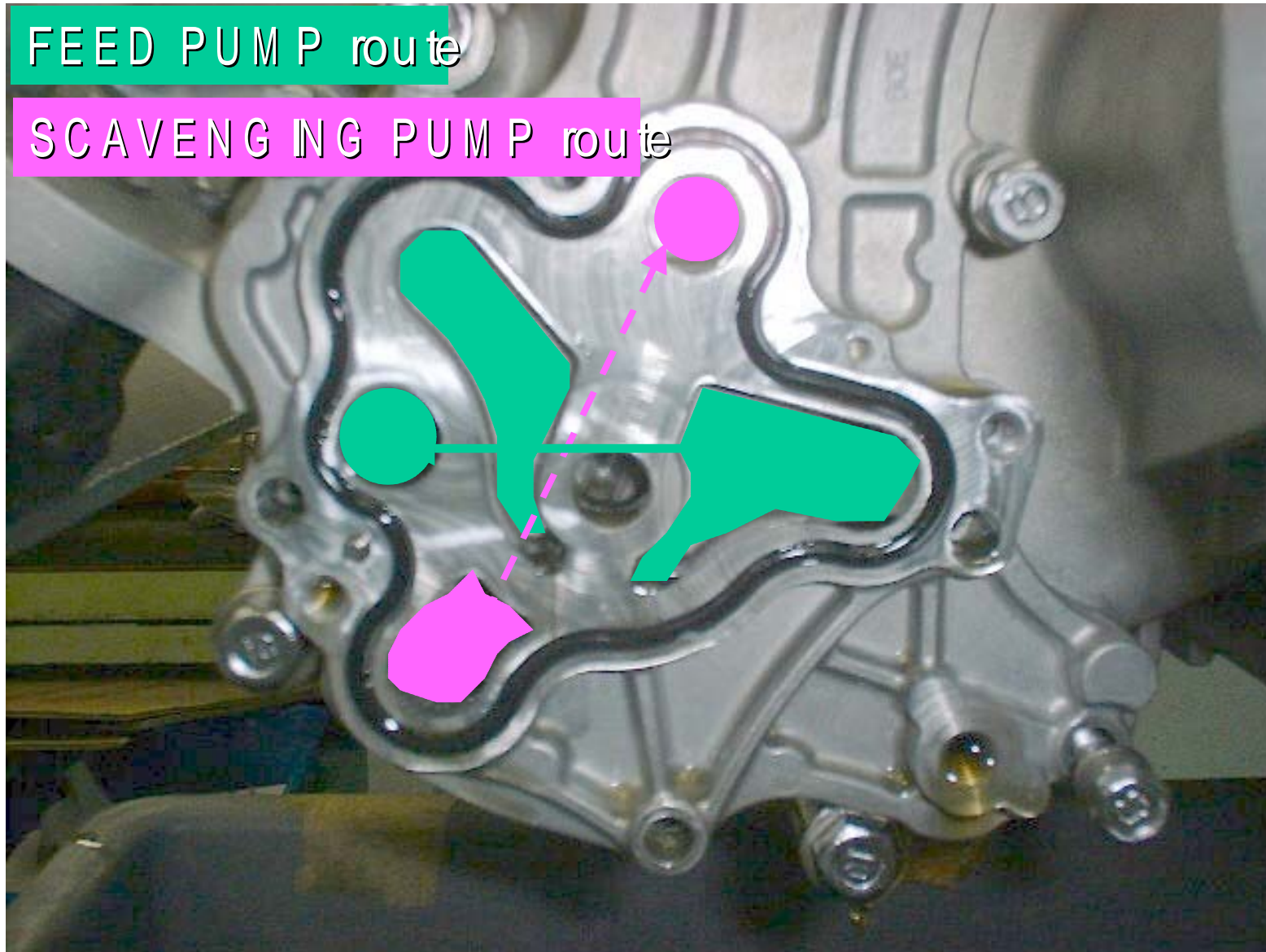

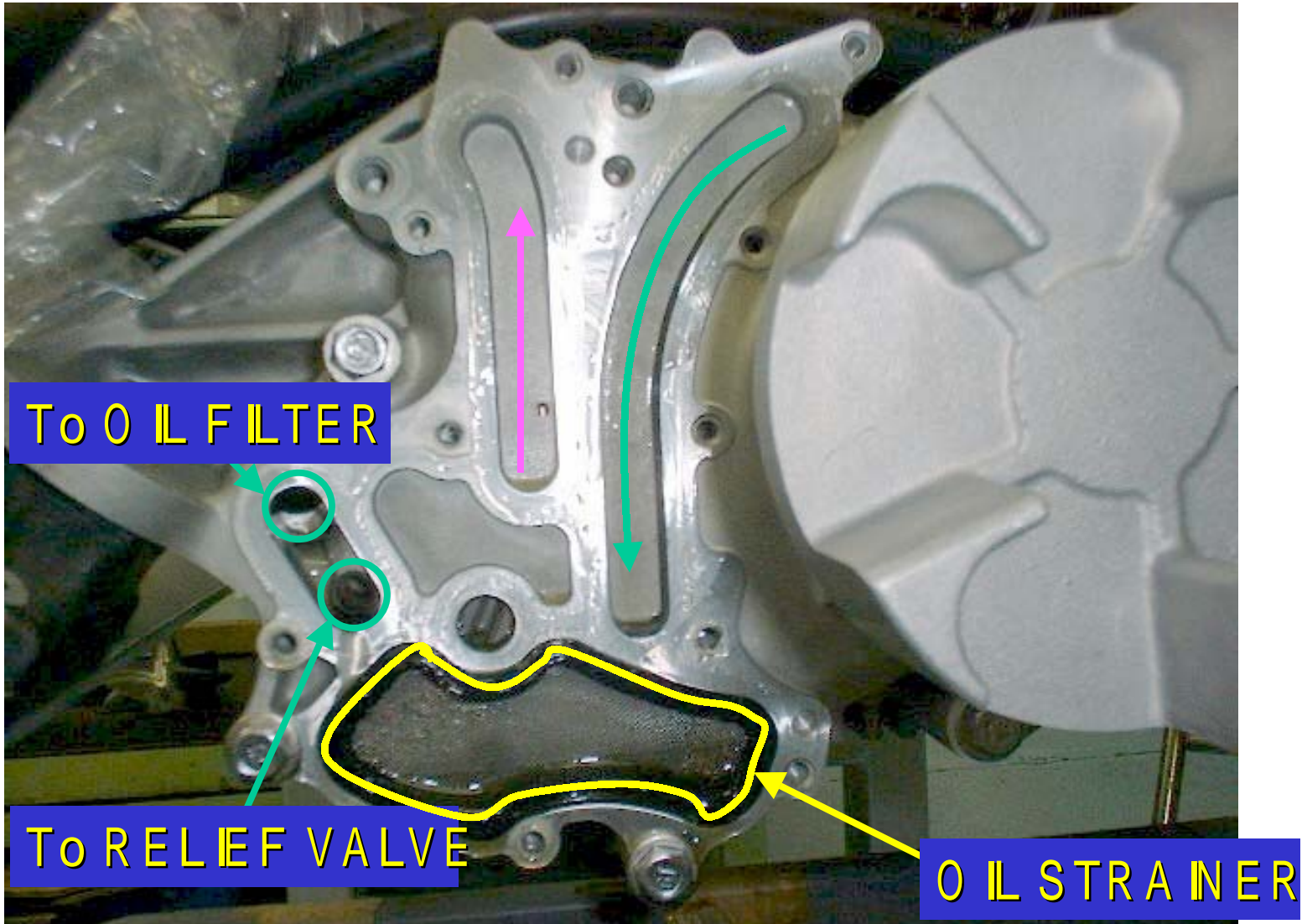

# Oil System Disassembly

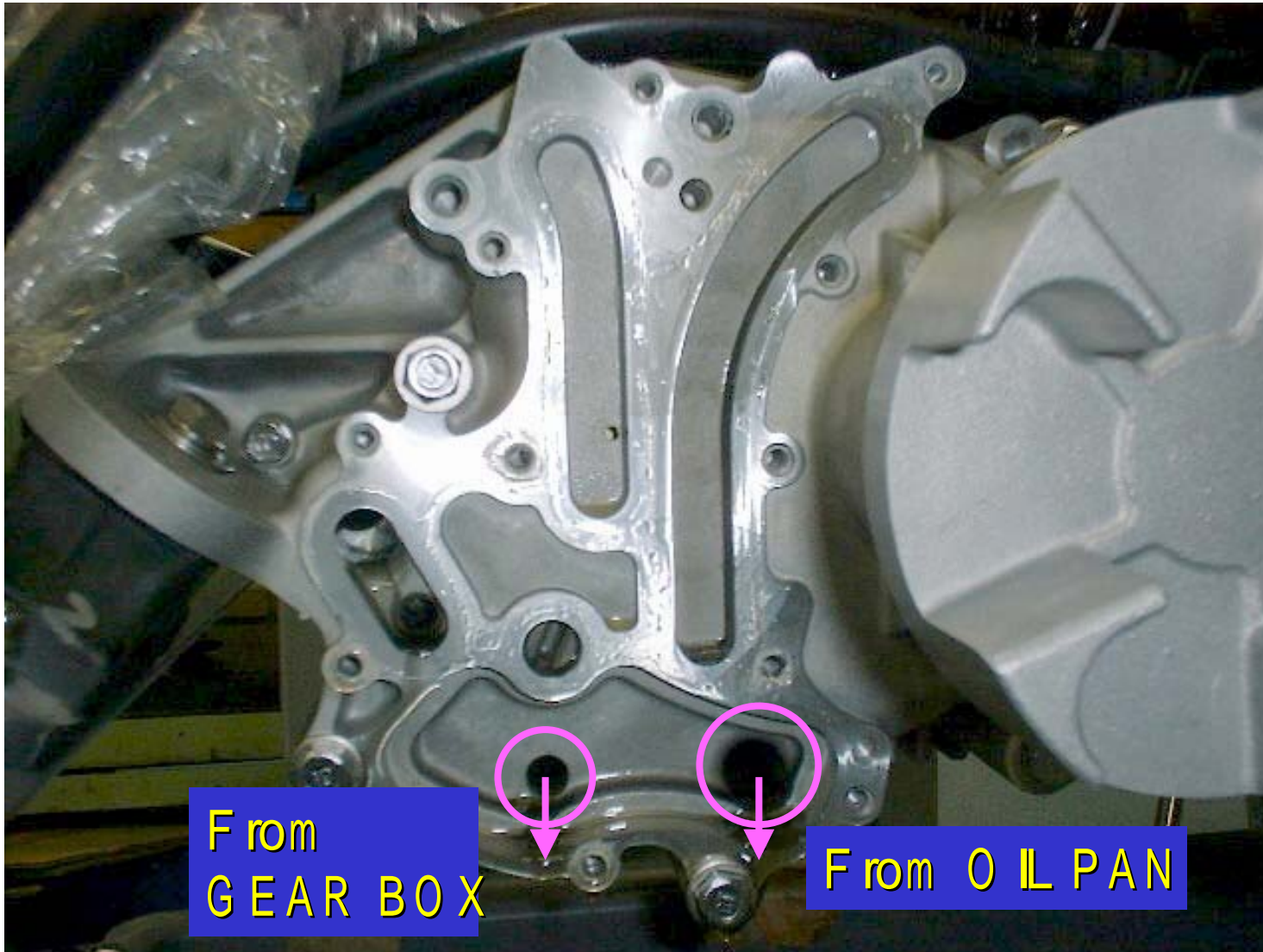

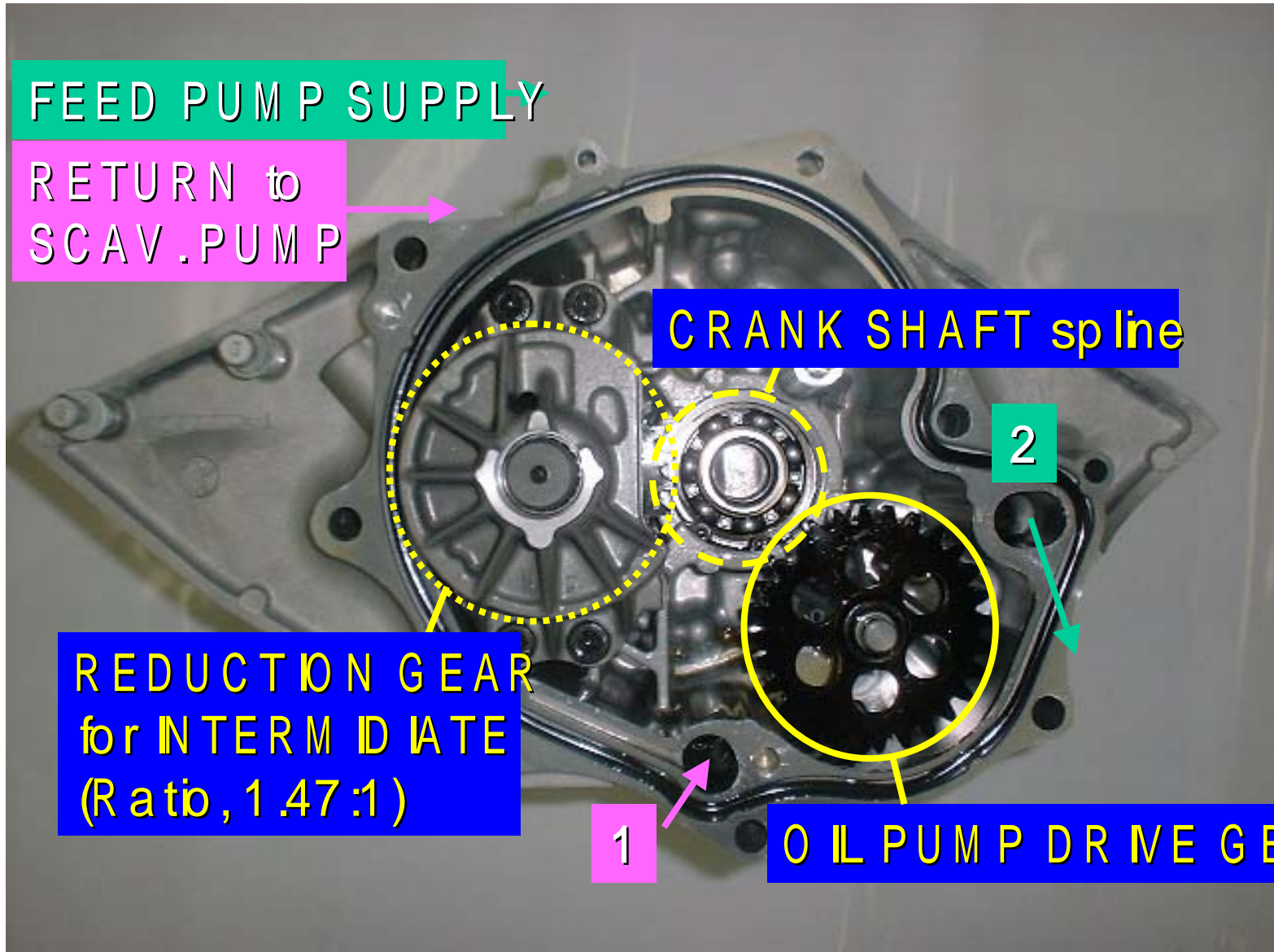

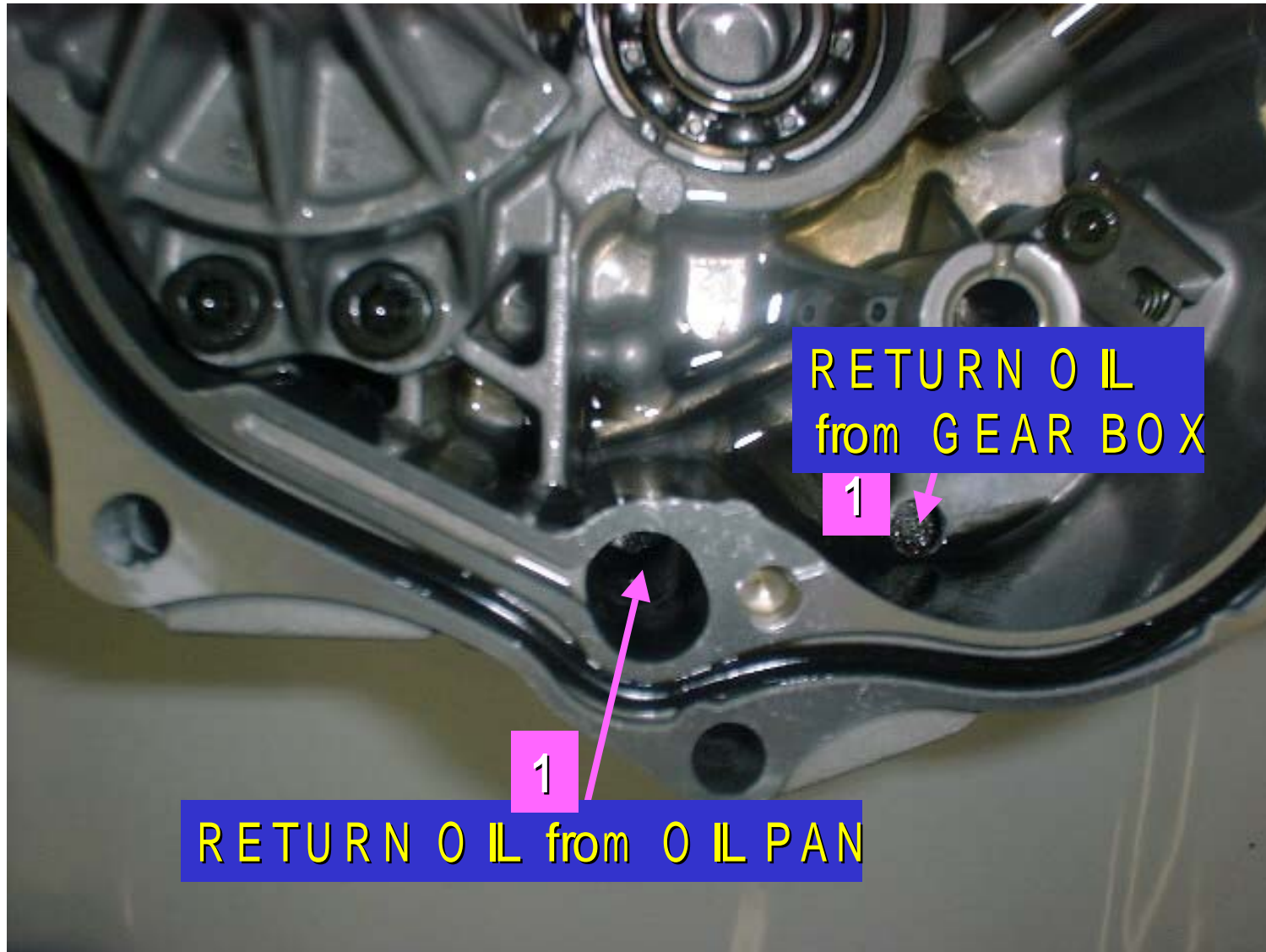

# Other Information



➤ Exhaust disassembly

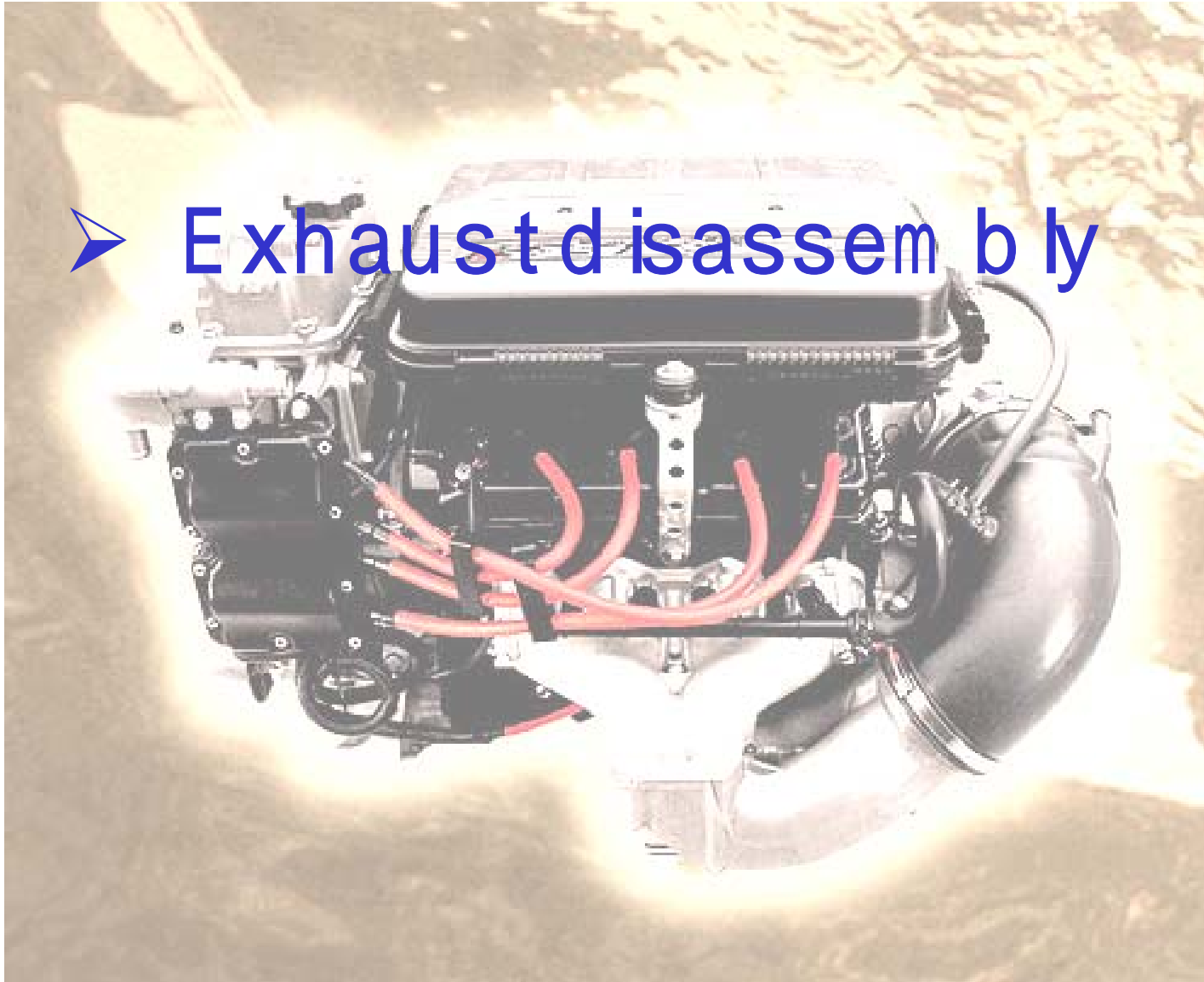

# Exhaust Disassembly

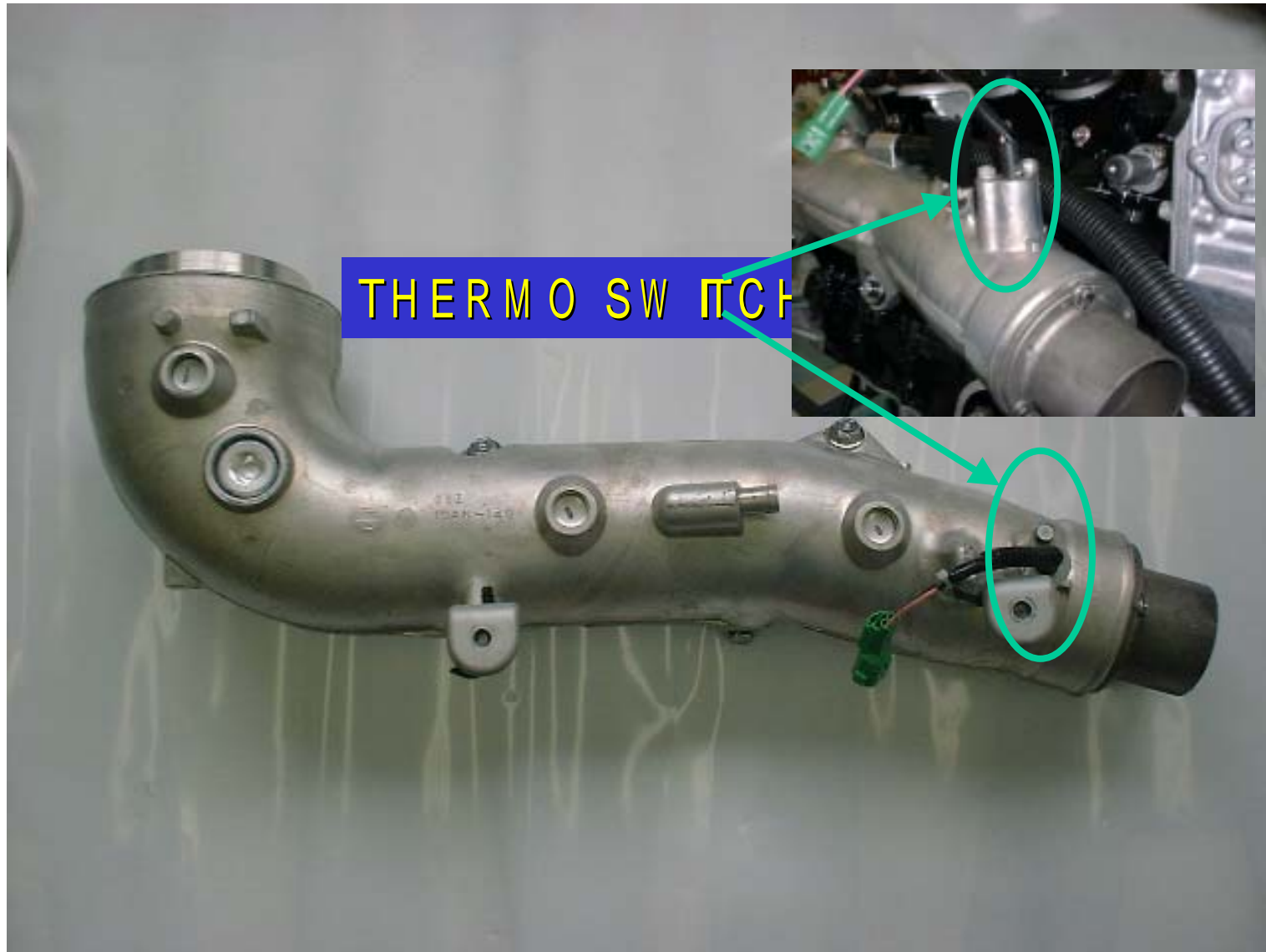



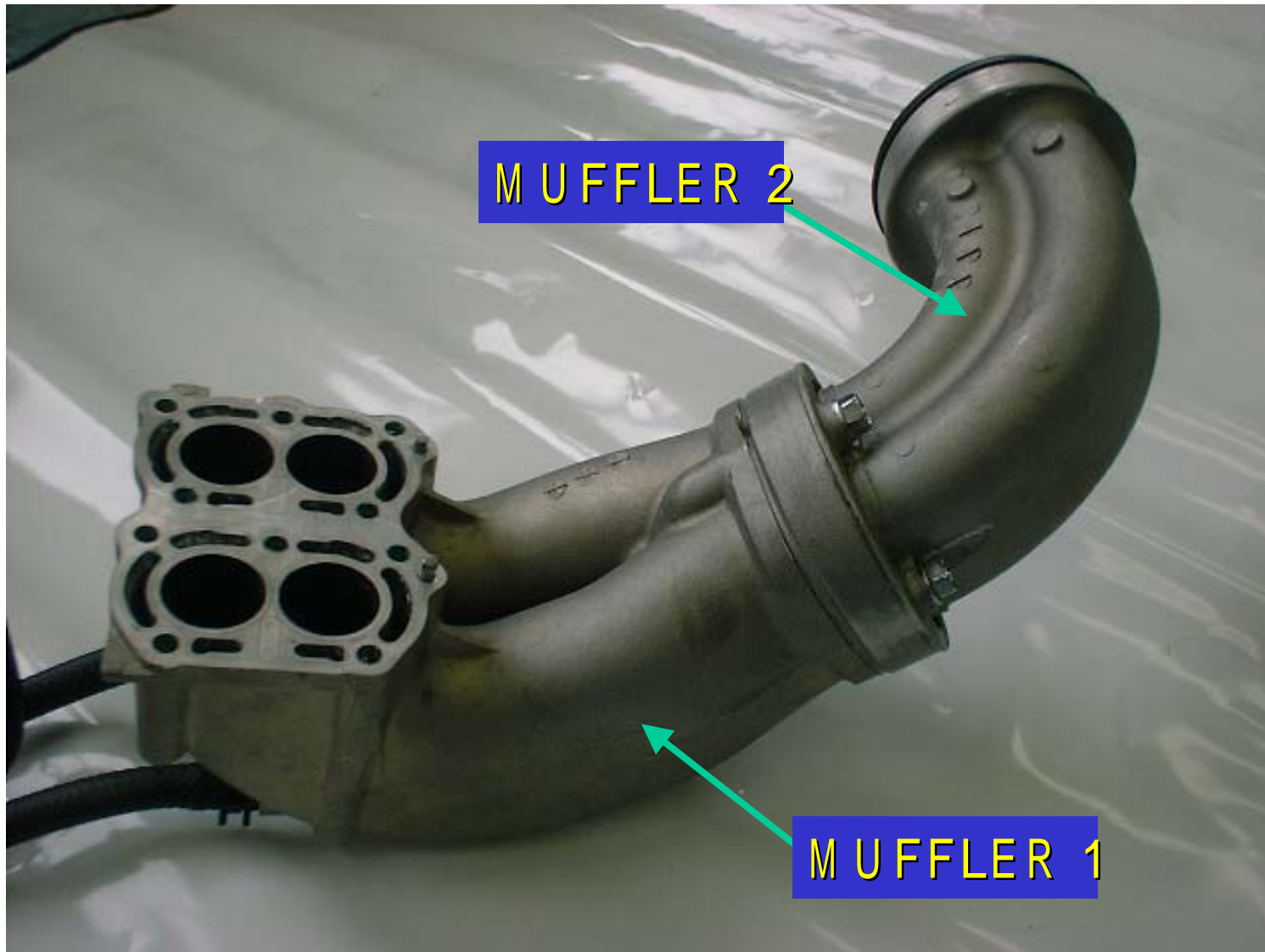

# Exhaust Disassembly

Information

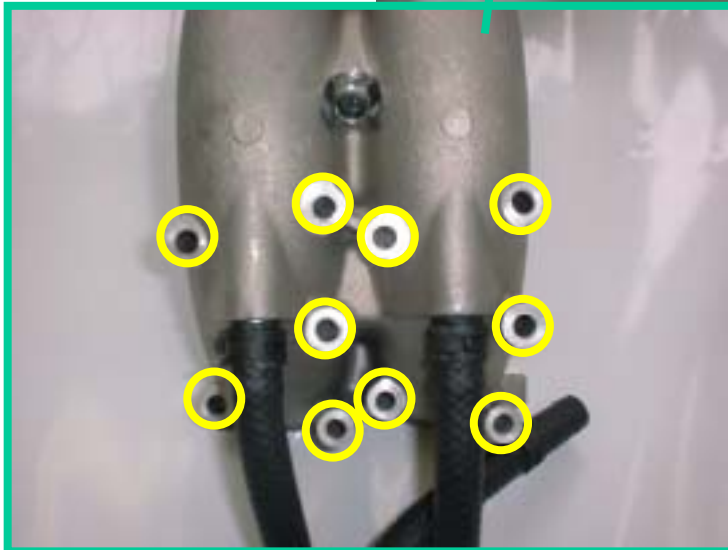
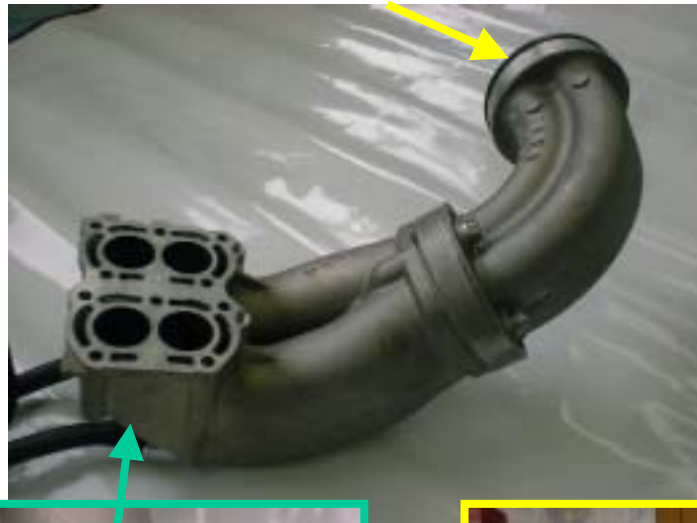

# Exhaust Disassembly

YAMAHA INFORMATION

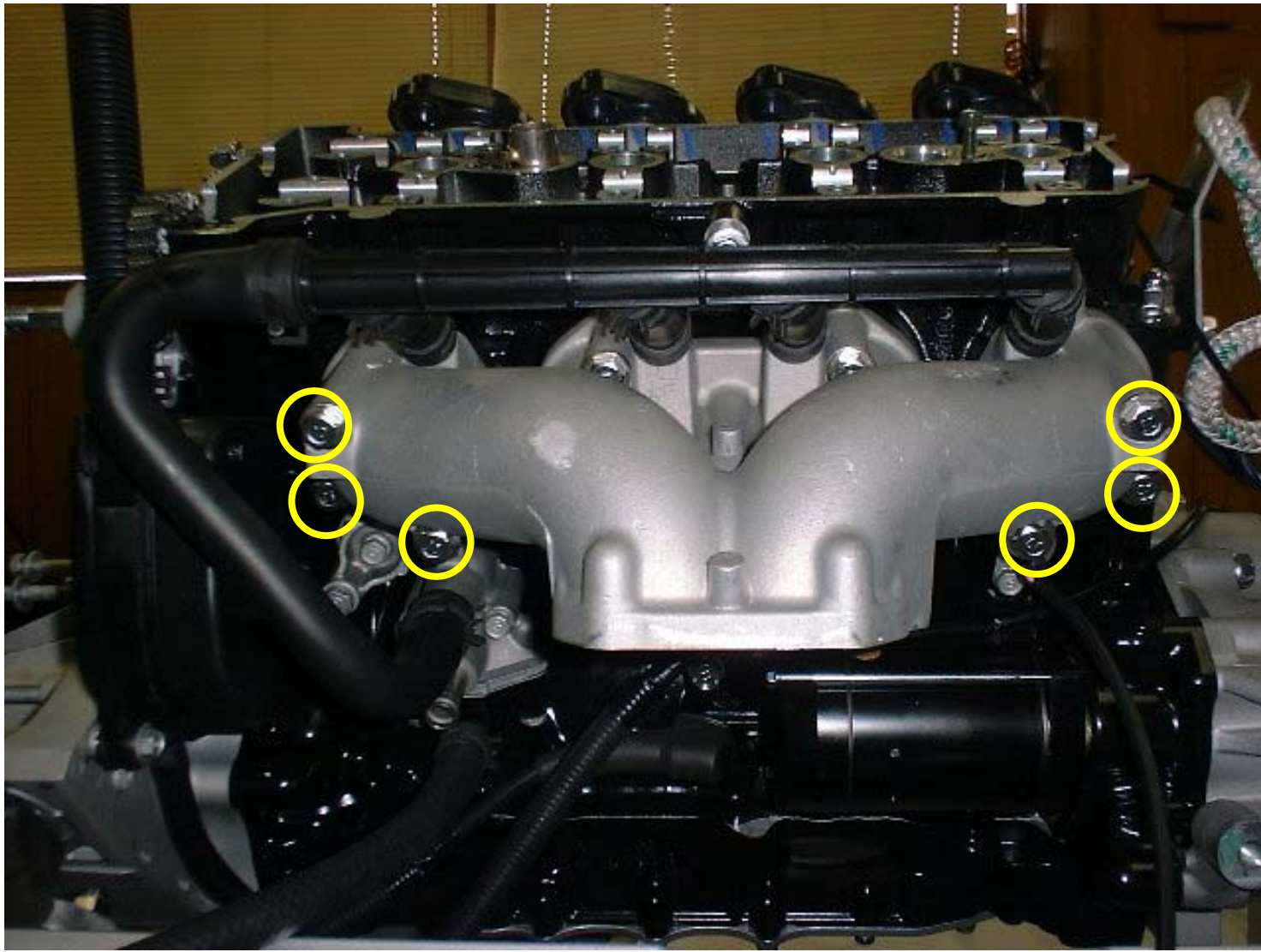

# Exhaust Disassembly

YAMAHA INFORMATION



# Other Information



➤ Peak Voltage

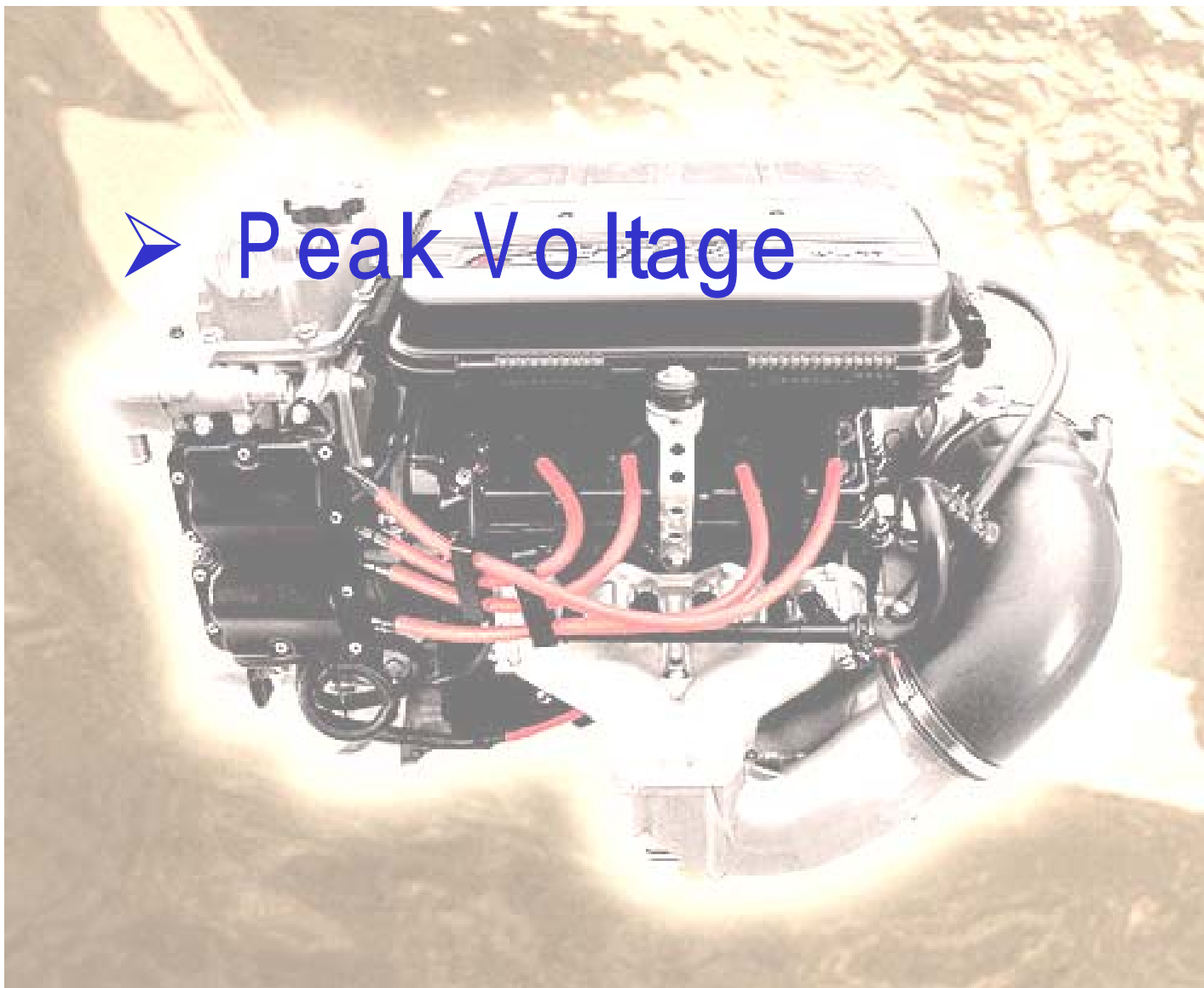

# Peak Voltage

## Other Information

	Connector Color	Test harness	Un loaded	Loaded		
			C r a n k i n g		2,000 rpm	3,500 rpm
ECM	# 1 / # 4 : B / R - R / Y	06792	-	7.0	258.0	258.0
	# 2 / # 3 : B / W - R / Y					
Pulser Coil	# 1 / # 4 : W / B - B / O	06791	4.0	4.0	23.0	38.0
	# 2 / # 3 : W / R - B / O					
Lighting Coil	G - G	06770	9.0	8.0	11.0	12.0
Rectifier/Regulator	R - B	06790	-	-	-	14.5

# Peak Voltage

## Other Information

### ECM

	Connector Color	Test harness	Un loaded	Loaded		
			Cranking	2,000 rpm	3,500 rpm	
ECM	# 1/# 4: B/R - R/Y	06792	-	7.0	258.0	258.0
	# 2/# 3: B/W - R/Y					



90890-06792

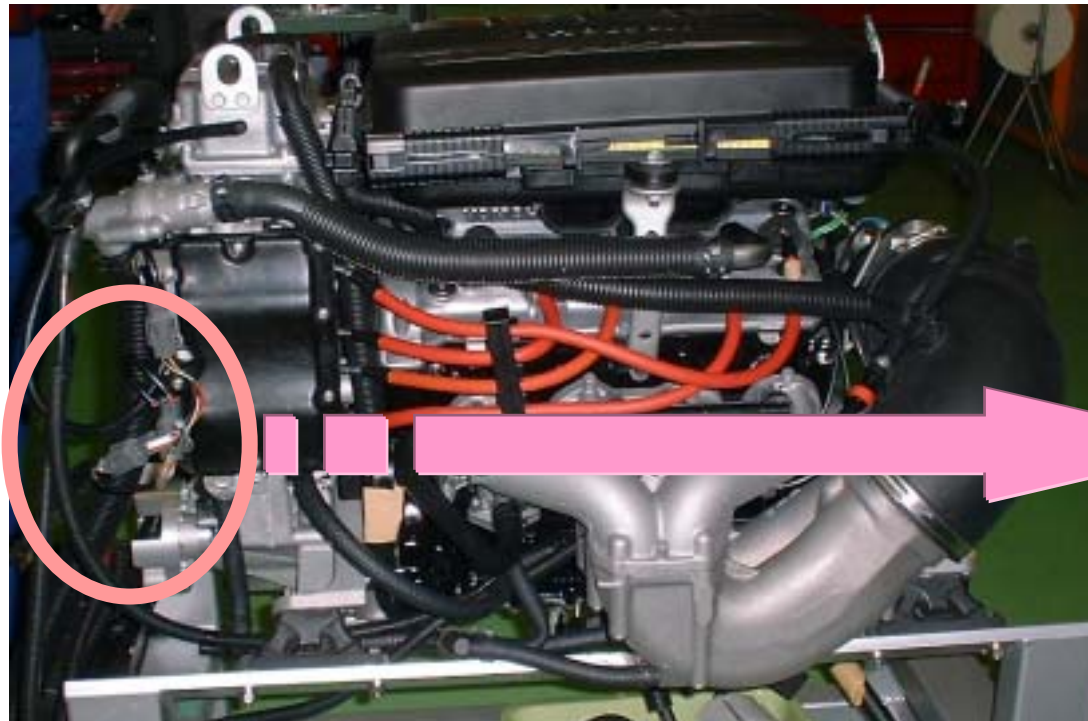

# Peak Voltage Other Information

## PULSER COIL

	Connector Color	Test harness	Unloaded	Loaded		
			Cranking	2,000 rpm	3,500 rpm	
Pulser Coil	# 1/# 4 : W / B - B / O	06791	4.0	4.0	23.0	38.0
	# 2/# 3 : W / R - B / O					



90890-06791





# Peak Voltage Other Information

## PULSER COIL

	Connector Color	Test harness	Unloaded	Loaded		
			Cranking	2,000 rpm	3,500 rpm	
Lighting Coil	G-G	06770	9.0	8.0	11.0	12.0



90890-06770

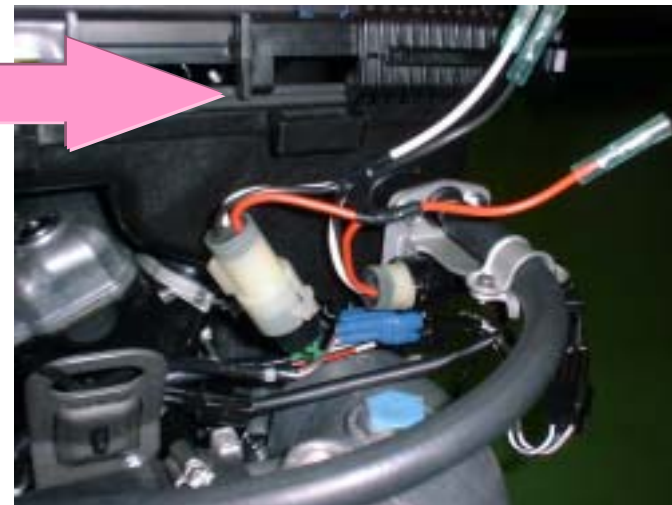

Peak Voltage

# RECTIFIER REGULATOR

	Connector Color	Test harness	Un loaded	Loaded		
			Cranking		2,000 rpm	3,500 rpm
Rectifier/Regulator	R - B	06790	-	-	-	14.5



90890-06790

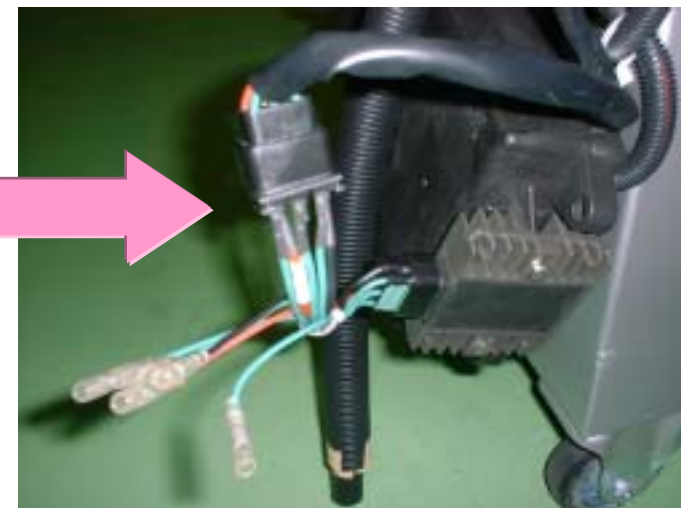

# Other Information



- Service material  
Publication Plan



# Service Material Publication Plan

## Service material publication plan

Service manual	Manual number	Publication
USA	F1B-28197-1E-11	End of February (PDF Data)
CAN	F1B-28197-2E-C1	End of March
W.W.	F1B-28197-ZE-C1	End of March
JPN	F1B-28197-0E-01	End of March

Service guide	Manual number	Publication
USA / CAN	90894-64630-60	End of January (PDF Data)
W.W.	90894-64630-61	End of February
JPN	90894-64630-63	End of February

Assembly manual	Manual number	Publication
USA	F1B-28107-1E-11	End of January (PDF Data)
CAN	F1B-28107-2E-C1	End of February
W.W.	F1B-28107-ZE-C1	End of February
JPN	F1B-28107-0E-01	End of March

Parts list	Manual number	Publication
USA	1AF1B-100E1	End of February (PDF Data)
CAN	1AF1B-100E1	End of February (PDF Data)
EUR	2AF1B-300E1	End of March (PDF Data)
JPN	1AF1B-010E1	End of March

# Other Information



➤ Service Special Tools



## Service Special Tools

Service Information

### New Tools

NO ,	PARTS NO ,	NAME	REMARK
	90890		
1	ㄣ 6582	Com presson Gauge extension M 10	
2	ㄣ 6583	D ialgauge stand M 10x173	
3	ㄣ 6584	D ialgauge needle 173	
4	ㄣ 6585	D ialgauge stand set	
5	ㄣ 6862	Test connecter FW Y -8	T P S
6	ㄣ 6842	Fue lP .gauge adapter	
7	ㄣ 6811	Va lve seat cutter holder 4.0	
8	ㄣ 6812	Va lve seat cutter holder 4.5	
9	ㄣ 6813	Va lve seat cutter 60deg-20	
10	ㄣ 6814	Va lve seat cutter 45deg-24	
11	ㄣ 6815	Va lve seat cutter 30deg-24	
12	60E-85300-01	YD IS KIT	
13	60E-W S853-00	YD IS CD-ROM	

## Service Special Tools

General Information

Same as Motorcycle's Tools

NO ,	PARTS NO ,	NAME	REMARK
	90890		
1	ㄣ 01080	Rotor puller	
2	ㄣ 04114	Valve spring compressor attachment	
3	ㄣ 04111	Valve guide reamer 4mm	
4	ㄣ 04112	Valve guide installer 4mm	
5	ㄣ 04113	Valve guide reamer 4mm	
6	ㄣ 01399	Special Thickness gauge	Width 6mm
7	ㄣ 04116	Valve guide reamer 4.5mm	
8	ㄣ 04117	Valve guide installer 4.5mm	
9	ㄣ 04118	Valve guide reamer 4.5mm	
10	ㄣ 04119	Cam shaft wrench	

## Service Special Tools

Other Information

### Existent Tools

NO ,	PARTS NO ,	NAME	REMARK
	90890		
1	ㄣ 01701	Sheave holder	
2	ㄣ 06551	Coupler wrench	
3	ㄣ 04019	Valve spring compressor	
4	ㄣ 04108	Valve spring compressor attachment	
5	ㄣ 01426	Oil filter wrench	
6	ㄣ 03094	Vacuum gauge	
7	03060	Vacuum gauge attachment	
8	ㄣ 03160	Compression gauge	
9	ㄣ 06754	Fuel pressure gauge	
10	ㄣ 03174	Digital circuit tester	
11	ㄣ 03172	Peak voltage adapter B	
12	ㄣ 06754	Spark gap tester	
13	ㄣ 06760	Digital tachometer	
14	ㄣ 06552	Crankshaft holder 20	
15	ㄣ 06519	Drive shaft holder 5	



# Service Special Tools

Other Information

## Existent Tools

NO ,	PARTS NO ,	NAME	REMARK
	90890		
16	ψ 06770	Testharness SM T 250-3	Lighting coil
17	ψ 06790	Testharness FSW -6	Rect./Regu.
18	ψ 06791	Testharness FW Y -3-L	Pulse coil
19	ψ 06792	Testharness SM HW 090-2	ECM unit
20	ψ 06793	Testharness SM HW 099-3	TPS
21	ψ 06315	Valve seat cutter 60deg-26	
22	ψ 06312	Valve seat cutter 45deg-27.5	
23	ψ 06328	Valve seat cutter 30deg-27	
24	ψ 05158	Piston ring compressor	
25	ψ 06769	Test harness EJ-2-2	Intake Air Pressure
26	ψ 06756	Vacuum /pressure pump gauge set	Intake Air Pressure
27	ψ 06777	Test harness HM 090-3	Cam position

# Other Information



➤ [Parts Information](#)

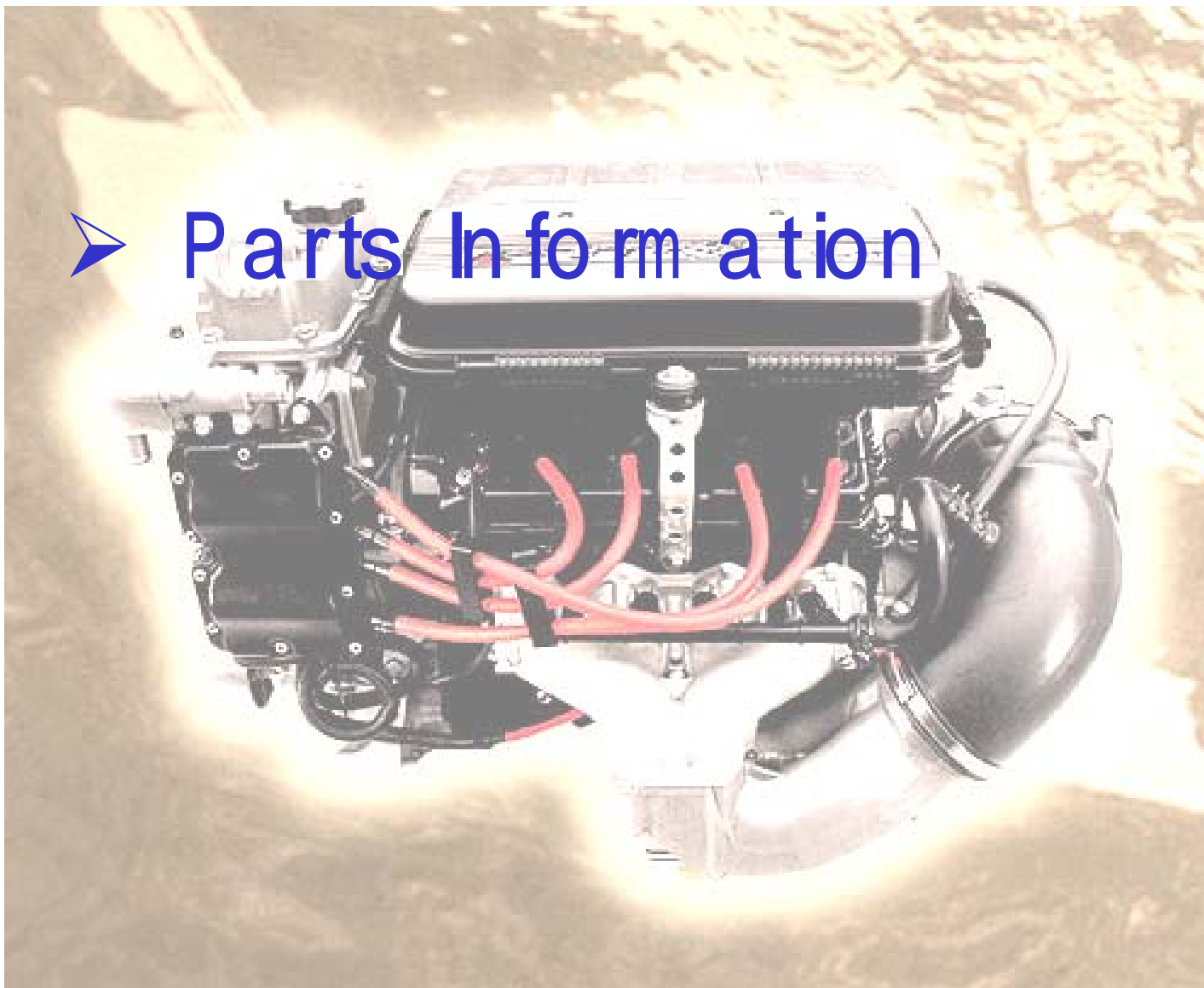

# Parts Information

【MC】

## COMMON PARTS

No.	PARTS NO ,	NAME
1	90201-10013	W ASHER ,PLAIN
2	90201-10019	W ASHER ,PLAIN
3	90179-10006	NUT
4	90179-10414	NUT
5	4KG -1111G -00	RUB .,M OUNT
6	4XV -15155-00	NOZZLE ,3
7	93210-04092	O -R ING
8	4XV -11633-00	PIN ,PISTON
9	90468-12069	CLIP
10	5PW -11650-00	CONN . ROD ASSY .,1
11	5JW -11654-10	BOLT ,CONNECTING ROD BIG END
12	90179-08327	NUT
13	4XV -12176-00	SPROCKET
14	90105-07342	BOLT ,FLG .
15	4XV -12111-00	VALVE ,1

# Parts Information

【MC】

## COMMON PARTS

No.	PARTS NO ,	NAME
16	4XV-12112-00	VALVE ,INT . 2
17	5LV-12121-00	VALVE ,2
18	1HX-12116-01	SEAT ,VALVE SPR ING
19	3GM -12126-00	SEAT ,VALVE SPRG . 2
20	4XV-12113-00	SPRG .,1
21	4XV-12114-00	SPRG .,2
22	1HX-12117-00	RET .,VALVE SPR ING
23	1W G -12117-00	RET .,VALVE SPR ING
24	1HX-12118-00	LOCK ,VALVE SPR ING RETAINER
25	1W G -12118-00	LOCK ,VALVE SPR ING RETAINER
26	4TV-12119-00	SEAL,VALVE STEM O IL
27	4SV-12119-00	SEAL,VALVE STEM O IL
28	1HX-12168-00	PAD ,AD JUSTING 2
29	3FV-12153-00	LIFTER ,VALVE
30	5BE-12241-00	GU IDE ,STOPPER 2

# Parts Information

【MC】

## COMMON PARTS

No.	PARTS NO ,	NAME
31	4FM -12213-00	GASKET ,TENSIONER CASE 1
32	4XV -12251 -00	DAMPER ,CHAIN 1
33	4XV -12252 -00	DAMPER ,CHAIN 2
34	3LD -13113-00	SEAT ,CHECK BALL
35	93505 -08030	BALL
36	90501 -105L2	SPRG .,COMPRESSION
37	1HX -13310 -10	ROTOR ASSY .,1
38	5GH -13440 -00	OIL CLEANER ASSY .
39	4W M -13484 -00	SPRG .
40	4XV -14275 -00	SPRG .
41	4W M -15590 -00	STARTER ONE -W AY ASSY .

# Parts Information

【W C / O M】

## COMMON PARTS

No.	PARTS NO ,	NAME
1	67F-11325-00	ANODE ,1
2	682-84385-01	CAP ,1
3	61L-5169A -00	GREASE ,N IPPLE
4	6E5-11325-00	ANODE ,1
5	68F-11119-00	HANGER ,ENG INE
6	6A0-82317-00	DAMPER ,IGN ITION CO IL
7	65L-85886-00	SENSOR ,AIR TEM PERATURE
8	69J-85885-00	THROTTLE SENSOR ASSY .
9	66V -13898-00	HOLDER
10	67X -12590-00	CONDUCTION ASSY .
11	67X -12590-20	CONDUCTION ASSY .
12	67X -44517-10	MOUNT ,RUBBER UPPER
13	66V -44532-00	STOPPER ,UPR . MOUNT RUB .
14	68F -85335-00	ADAPTER ,INTERFACE
15	68F -8533A -00	CABLE ,INTERFACE

# Parts Information

【W C / O M】

## COMMON PARTS

No.	PARTS NO ,	NAME
16	66V-8132W -00	CAP
17	66V-81844-00	PKG .
18	67F-2812A-00	PULLER ,FUSE
19	68V-81960-00	RECTIFIER REGULATOR ASSY .
20	6R7-83623-40	M ARK ,3
21	6A0-82317-00	DAMPER ,IGN ITION CO IL
22	68N-81940-00	STARTER RELAY ASSY .
23	66V-82119-00	COVER ,LEAD W IRE
24	66V-82119-00	COVER ,LEAD W IRE
25	67F-82154-10	CASE
26	67F-8215D -10	SEAL ,W IRE
27	67F-8215C -10	TERM INAL
28	67F-8215D -00	SEAL ,W IRE
29	67F-8215C -00	TERM INAL
30	68V-82504-00	SW .,O IL PRESSURE

No.	PARTS NO ,	NAME
1	60E -R 1311 -00	DUCT ,INTAKE
2	60E -R 1333 -00	SCREEN ,INTAKE
3	60E -G 5831 -00	PLATE ,TRANSOM
4	60E -51317 -00	HSG .,MPELLER 2
5	68Y -45511 -00	SHAFT,DRIVE 1
6	68N -R 1321 -00	IMPELLER
7	60E -51313 -00	NOZZLE ,DEFLECTOR
8	60E -51190 -00	RING ,TRIM



**WaveRunner** *FX* **140**

*Thank you  
for your kind attention.*

