

CURSOR SERIES

Industrial application

C10

C10 ENT

This publication describes the characteristics, data and correct methods for repair operations on each component of the vehicle.

If the instructions provided are followed and the specified equipment is used, correct repair operations in the programmed time will be ensured, safeguarding against possible accidents.

Before starting to perform whatever type of repair, ensure that all accident prevention equipment is available and efficient.

All protections specified by safety regulations, i.e.: goggles, helmet, gloves, boot, etc. must be checked and worn.

All machining, lifting and conveying equipment should be inspected before use.

The data contained in this publication was correct at the time of going to press but due to possible modifications made by the Manufacturer for reasons of a technical or commercial nature or for adaptation to the legal requirements of the different countries, some changes may have occurred.

No part of this publication, including the pictures, may be reproduced in any form or by any means.

Publication edited by
Iveco Motors
Iveco SpA
PowerTrain
Mkt. Advertising & Promotion
Viale dell'Industria, 15/17
20010 Pregnana Milanese
Milano (Italy)
Print **P2D32C001GB/W** - 1st Ed. 11.2004
C10 ENT Series

Produced by:









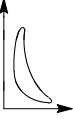
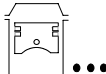
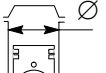
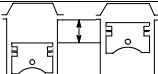
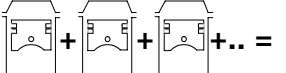
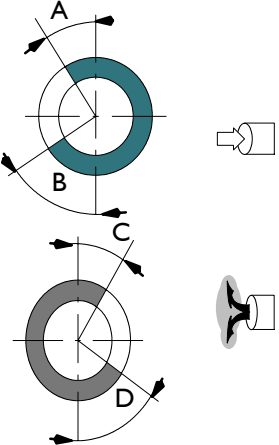
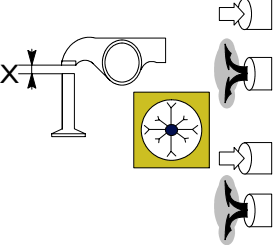

B.U. TECHNICAL PUBLISHING
Iveco Technical Publications
Lungo Stura Lazio, 15/19
10156 Turin - Italy

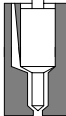
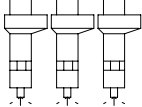
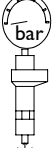
CORRESPONDENCE BETWEEN TECHNICAL CODE AND COMMERCIAL CODE

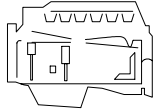
Technical Code	Commercial Code
F3AE0687A*...	C10 ENT

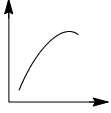
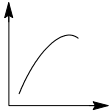
SPECIFICATIONS

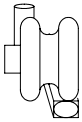
	Type	C10 ENT SERIES	
	Cycle	4-stroke Diesel engine	
	Fuel feed	Turbocharged	
	Injection	Direct	
	No. of cylinders	6 in line	
	Bore	mm	125
	Stroke	mm	140
	Total displacement	cm ³	10300
	VALVE TIMING		
	opens before T.D.C.	A	16°
	closes after B.D.C.	B	32°
	opens before B.D.C.	D	51°
	closes after T.D.C.	C	11°
	For timing check	X	mm
			mm
	Running	X	mm
			mm
	FEED	Through fuel pump - filters	
	Injection type: Bosch	With electronically regulated injectors PDE 31 pump injectors controlled by overhead camshaft MS6.2 ECU	
	Nozzle type	-	
	Injection order	1 - 4 - 2 - 6 - 3 - 5	
	Injection pressure	bar	1500
	Injector calibration	bar	290 ± 6







C10 ENT Series engines		TECHNICAL CODE	
	Type	F3AE0687A*....	
	Compression ratio	17.5 ± 1	
	Max. output	kW (HP) rpm	295 (401) 2100
	Max. torque	Nm (kgm) rpm	1719 (171) 1380
	Loadless engine idling	rpm	1300
	Loadless engine peak	rpm	2110
	Bore x stroke Displacement	mm cm ³	125 x 140 10300
	SUPERCHARGING Turbocharger type	Intercooler Direct injection HOLSET HX50W	
	LUBRICATION Oil pressure (warm engine) - idling - peak rpm	bar bar bar	Forced by gear pump, relief valve single action oil filter 4 5
	COOLING Water pump control Thermostat - start of opening	°C	Liquid Through belt 80

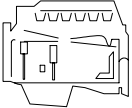
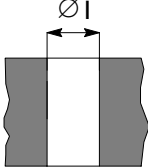
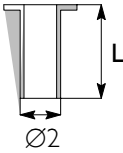

Data, features and performances are valid only if the technician fully complies with all the installation requirements provided by Iveco Motors.

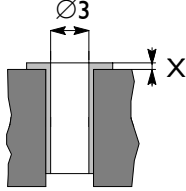
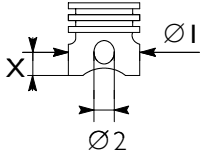

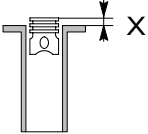
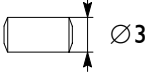





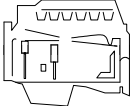
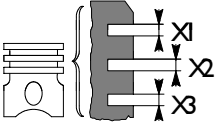
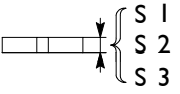

Furthermore, the use of the unit after overhaul should conform to the original specified power and engine rev/min for which the engine has been designed.

ASSEMBLY CLEARANCE DATA

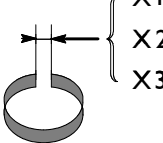
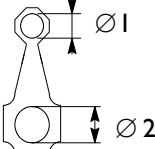
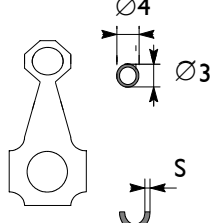





 Type	C10 ENT SERIES	
CYLINDER BLOCK AND CRANKMECHANISM COMPONENTS	mm	
 Bores for cylinder liners: upper $\varnothing 1$ lower	142.000 to 142.025 140.000 to 140.025	
 Cylinder liners: external diameter: upper $\varnothing 2$ lower length L	141.961 to 141.986 139.890 to 139.915 -	
 Cylinder liners - crankcase bores upper lower	0.014 to 0.064 0.085 to 0.135	
 External diameter $\varnothing 2$	-	
 Cylinder sleeve inside diameter $\varnothing 3A^*$ inside diameter $\varnothing 3B^*$ Protrusion X * Selection class	125.000 to 125.013 125.011 to 125.024 0.045 to 0.075	
 Pistons: measuring dimension X external diameter $\varnothing 1A^{\bullet}$ external diameter $\varnothing 1B^{\bullet\bullet}$ pin bore $\varnothing 2$	18 124.881 to 124.893 124.892 to 124.904 50.010 to 50.018	
 Piston - cylinder sleeve A* B* * Selection class	0.107 to 0.132 0.096 to 0.131	
 Piston diameter $\varnothing 1$	-	
 Pistons protrusion X	0.23 to 0.53	
 Gudgeon pin $\varnothing 3$	49.994 to 50.000	
 Gudgeon pin - pin housing	0.010 to 0.024	

● Class A pistons supplied as spares.

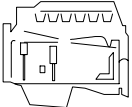
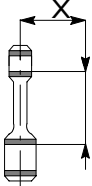
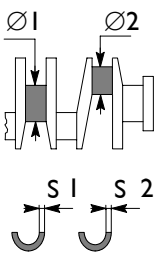
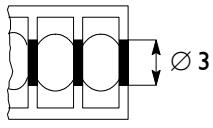



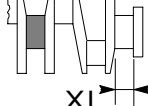
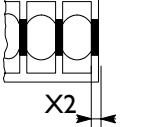
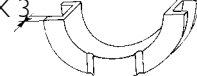

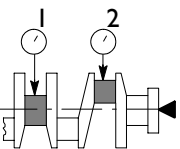



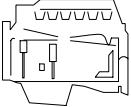
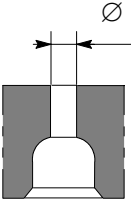
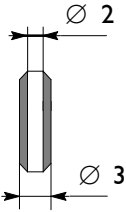



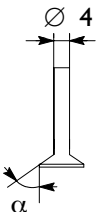

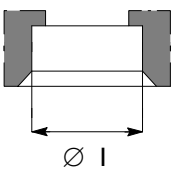

●● Class B pistons are fitted in production only and are not supplied as spares.

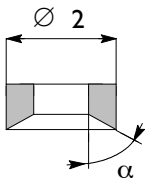

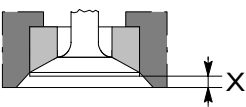



 Type	C10 ENT SERIES	
CYLINDER BLOCK AND CRANKMECHANISM COMPONENTS	mm	
 X1* X2 X3 * measured on Ø of 120 mm	X1* X2 X3	2.94 3.05 to 3.07 4.02 to 4.04
 S 1 S 2 S 3 * measured on Ø of 120 mm	S1* S2 S3	2.796 to 2.830 2.970 to 3.000 3.970 to 3.990
 Piston rings - grooves	1 2 3	0.110 to 0.144 0.050 to 0.100 0.030 to 0.070
	 >	-
 X1 X2 X3	X1 X2 X3	0.35 to 0.50 0.60 to 0.75 0.35 to 0.65
 Small end bush housing Big end bearing housing Selection classes	Ø1 Ø2 { 1 2 3	54.000 to 54.030 87.000 to 87.030 87.000 to 87.010 87.011 to 87.020 87.021 to 87.030
 Small end bush diameter outside inside Big end bearing shell Red Green Yellow ●	Ø4 Ø4 Ø3 S	54.085 to 54.110 50.019 to 50.035 1.970 to 1.980 1.981 to 1.990 1.991 to 2.000
 Small end bush - housing		0.055 to 0.110
 Piston pin - bush		0.019 to 0.041
	 >	0.127 - 0.254 - 0.508
 Connecting rod weight Connecting rod weight Class	A A B C	g. 3973 to 4003 g. 3973 to 4003 g. 4004 to 4034 g. 4035 to 4065



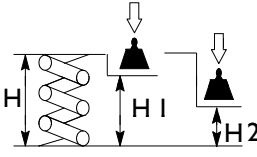
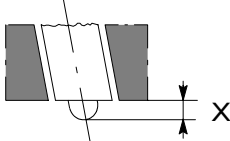
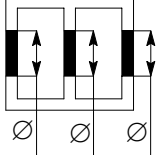
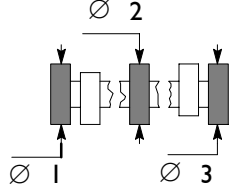
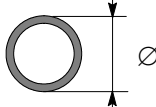



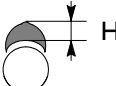

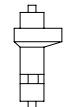
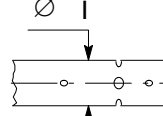

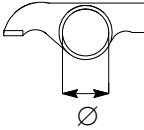

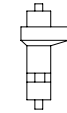
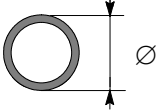



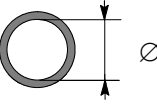

- Fitted in production only and not supplied as spares

 Type	C10 ENT SERIES	
CYLINDER BLOCK AND CRANKMECHANISM COMPONENTS	mm	
 Measuring dimension X Max. connecting rod axis misalignment tolerance =	 125 0.08	
 Main journals - nominal $\varnothing 1$ - class 1 - class 2 - class 3 Crankpins $\varnothing 2$ - nominal - class 1 - class 2 - class 3 Main bearing shells S1 Red Green Yellow* Big end bearing shells S2 Red Green Yellow*	 92.970 to 93.000 92.970 to 92.979 92.980 to 92.989 92.990 to 93.000 82.970 to 83.000 82.970 to 82.979 82.980 to 82.989 82.990 to 83.000 2.965 to 2.974 2.975 to 2.984 2.985 to 2.995 1.970 to 1.980 1.981 to 1.990 1.991 to 2.000	
 Main bearing housings $\varnothing 3$ - nominal - class 1 - class 2 - class 3	 99.000 to 99.030 99.000 to 99.009 99.010 to 99.019 99.020 to 99.030	
 Bearing shells - main journals	0.050 to 0.090	
 Bearing shells - big ends	0.040 to 0.080	
 Main bearing shells Big end bearing shells	 0.127 - 2.254 - 0.508 0.127 - 2.254 - 0.508	
 Main journal, thrust bearing X1	45.95 to 46.00	
 Main bearing housing, thrust bearing X2	38.94 to 38.99	
 Thrust washer halves X3	3.38 to 3.43	
 Crankshaft end float	0.10 to 0.30	
 Alignment } = 1 - 2 Ovalization } ○ 1 - 2 Taper } / 1 - 2	 ≤ 0.025 0.010 0.010	

* Fitted in production only and not supplied as spares

 Type	C10 ENT SERIES	
CYLINDER HEAD - VALVE TRAIN		
mm		
 Valve guide housings in cylinder head	Ø1	14.980 to 14.997
 Valve guide	 Ø2 Ø3	9.015 to 9.030 15.012 to 15.025
 Valve guides - housings in the cylinder heads		0.015 to 0.045
 Valve guide		0.2 - 0.4
 Valves:	 Ø4 α  Ø4 α	8.960 to 8.975 60° 30' ± 7' 30" 8.960 to 8.975 45° 30' ± 7' 30"
 Valve stem and its guide		0.040 to 0.070
 Valve seat in head	 Ø1  Ø1	44.185 to 44.220 42.985 to 43.020
 Outside diameter of valve seat; angle of valve seat in cylinder head:	 Ø2 α  Ø2 α	44.260 to 44.275 60° - 30' 43.060 to 43.075 45° - 30'
 Recessing of valve	X  X 	0.65 to 0.95 1.8 to 2.1
 Between valve seat and head	 	0.040 to 0.090

 Type	C10 ENT SERIES	
CYLINDER HEAD - VALVE TRAIN	mm	
 Valve spring height: free height H under a load of: N 500 ±25 H1 N 972 ±48 H2		75 61 47.8
 Injector protrusion X	X	0.14 to 1.4
 Camshaft bushing housing in the cylinder head: I ⇒ 7	∅	88.000 to 88.030
 Camshaft bearing journals: I ⇒ 7	∅	82.950 to 82.968
 Outer diameter of camshaft bushings:	∅	88.153 to 88.183
 Inner diameter of camshaft bushings:	∅	83.018 to 83.085
 Bushings and housings in the cylinder head		0.123 to 0.183
 Bushings and bearing journals		0.050 to 0.135
 Cam lift:   		9.30 9.45 11.21
 Rocker shaft	∅I	41.984 to 42.000

 Type	C10 ENT SERIES
CYLINDER HEAD - VALVE TRAIN	mm
Bushing housing in rocker arms    	45.000 to 45.016 59.000 to 59.019 46.000 to 46.016
Bushing outer diameter for rocker arms    	45.090 to 45.130 59.100 to 59.140 46.066 to 46.091
Bushing inner diameter for rocker arms    	42.025 to 42.041 56.030 to 56.049 42.015 to 42.071
Between bushings and housings    	0.074 to 0.130 0.081 to 0.140 0.050 to 0.091
Between bushings of rocker arms and shaft    	0.025 to 0.057 0.025 to 0.057 0.015 to 0.087
TURBOCHARGER Type End float Radial play	HOLSET HX 50 W - -

TOOLS

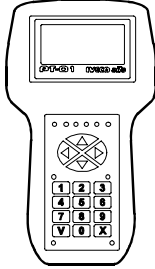
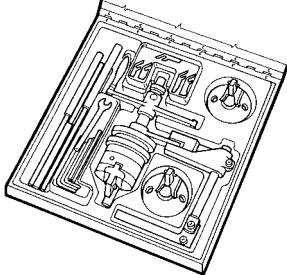
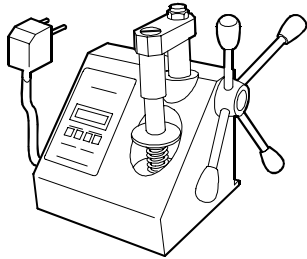
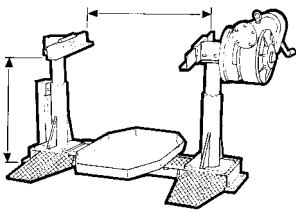
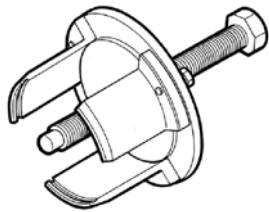
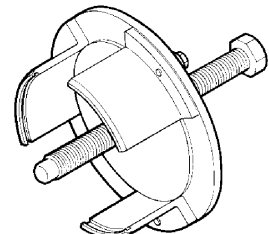
TOOL NO.	DESCRIPTION
8093731	Tester PT01
	
99305019	Full-optional tool-kit to rectify valve seat
	
99305047	Spring load tester
	
99322230	Rotary telescopic stand (range 2000 daN, torque 375 daNm)
	
99340053	Extractor for crankshaft front gasket
	
99340054	Extractor for crankshaft rear gasket
	

TOOLS

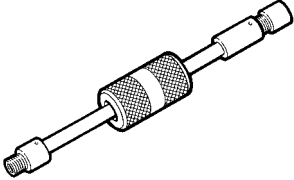
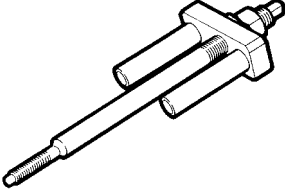
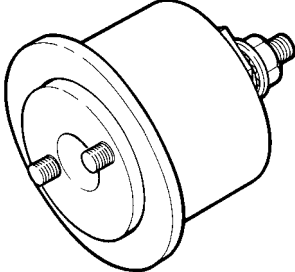
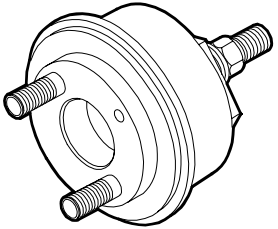
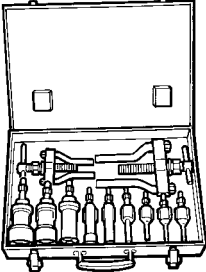
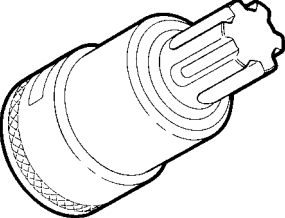
TOOL NO.	DESCRIPTION
99340205	Percussion extractor 
99342149	Extractor for injector-holder 
99346250	Tool to install the crankshaft front gasket 
99346251	Tool to install the crankshaft rear gasket 
99348004	Universal extractor for 5 to 70 mm internal components 
99350072	Box wrench for block junction bolts to the underblock 

TOOLS

TOOL NO.

DESCRIPTION

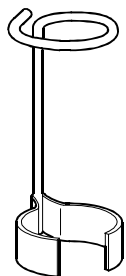
99360144

Tools (12 + 6) holding rocker adjustment screw blocks when removing/refitting the rocker shaft

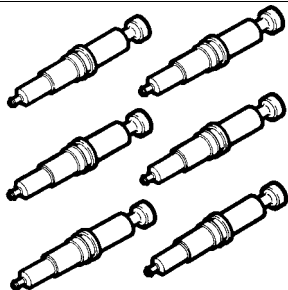
99360180

Injector housing protecting plugs (6)

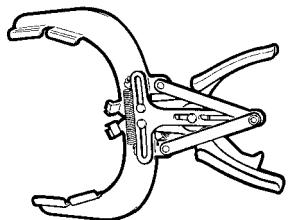
99360184

Pliers for assembling and disassembling piston split rings (105-106 mm)

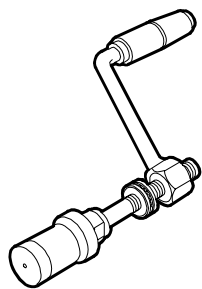
99360261

Tool to take down-fit engine valves (to be used with special plates)

99360262

Plate for take down-fit engine valves (to be used with 99360261)

99360295

Tool to fit back valve guide (to be used with 99360481)

TOOLS

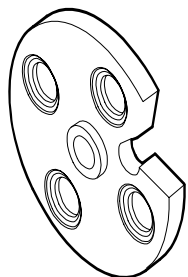
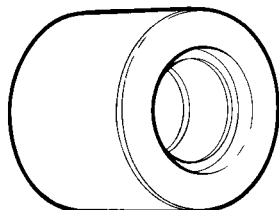
TOOL NO.

DESCRIPTION

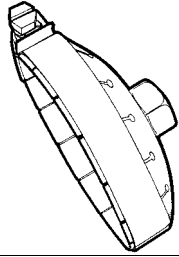
99360314

Tool to remove oil filter (engine)

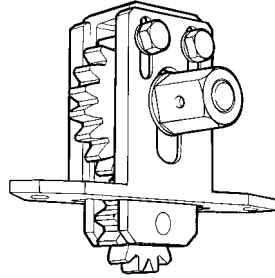
99360321

Tool to rotate engine flywheel (to be used with 99360325)

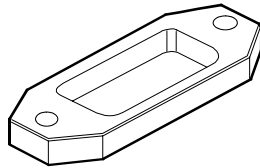
99360325

Spacer (to be used with 99360321)

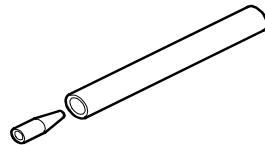
99360328

Tool to install gasket on valve guide

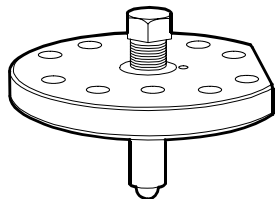
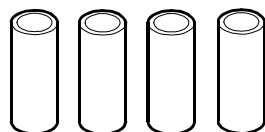
99360334Compression tool for checking the protrusion of cylinder liners
(to be used with 99370415-99395603 and special plates)**99360336**

Spacer (to be used with 99360334)

TOOLS

TOOL NO.

DESCRIPTION

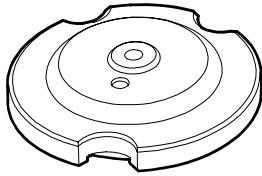
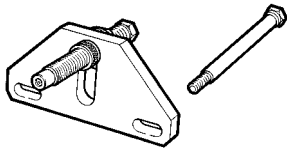
99360337Cylinder liner compression plate
(to be used with 99360334-99360336)**99360351**

Tool to stop engine flywheel

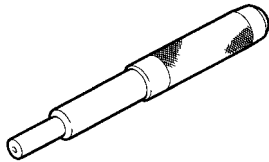
99360481

Tool to remove valve guide

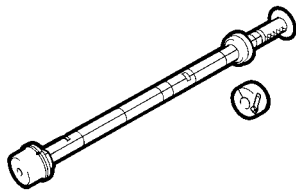
99360499

Tool to take down and fit back camshaft bushes

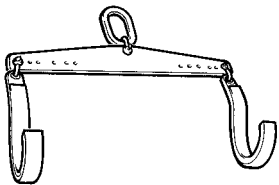
99360500

Tool to lift crankshaft

99360551

Bracket to take down and fit engine flywheel

TOOLS

TOOL NO.	DESCRIPTION
99360553	Tool for assembling and installing rocker arm shaft
99360585	Swing hoist for engine disassembly assembly
99360605	Belt to insert piston in cylinder liner (60 - 125 mm)
99360612	Tool for positioning engine P.M.S.
99360613	Tool for timing of phonic wheel on timing gear
99360703	Tool to stop cylinder liners

TOOLS

TOOL NO.	DESCRIPTION
99360706	Tool to extract cylinder liners (to be used with specific rings)

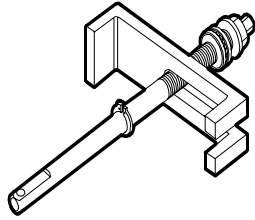
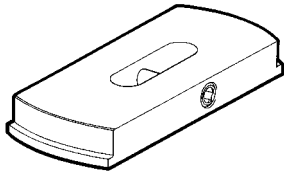
**99360726**

Ring (125 mm) (to be used with 99360706)

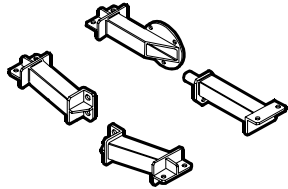
99361036

Brackets fixing the engine to rotary stand 99322230

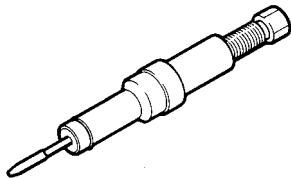
99365056

Tool for injector holder heading

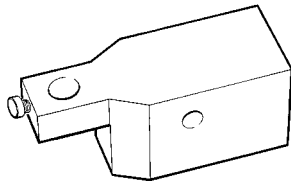
99370415

Base supporting the dial gauge for checking cylinder liner protrusion (to be used with 99395603)

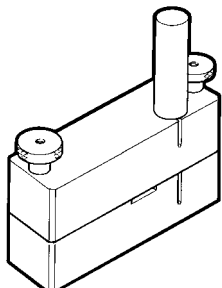
99378100

Tool for printing engine identification plates (to be used with special punches)

TOOLS

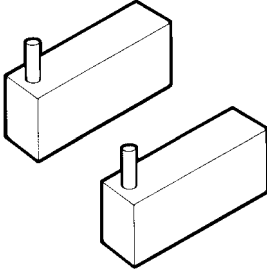
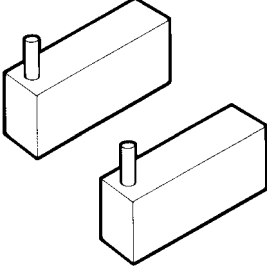
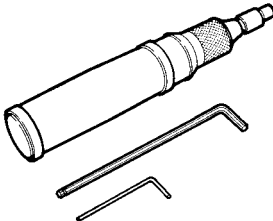
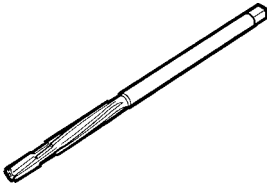
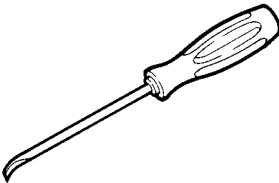
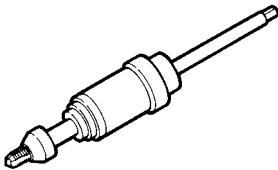
TOOL NO.	DESCRIPTION
99378102	 <p>Punches (B) for printing engine identification plates (to be used with 99378100)</p>
99378104	 <p>Punches (D) for printing engine identification plates (to be used with 99378100)</p>
99389834	 <p>Torque screwdriver for calibrating the injector solenoid valve connector check nut</p>
99390311	 <p>Valve guide sleeker</p>
99390772	 <p>Tool for removing injector holding case deposits</p>
99390804	 <p>Tool for threading injector holding cases to be extracted (to be used with 99390805)</p>

TOOLS

TOOL NO.

DESCRIPTION

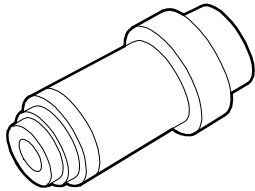
99390805

Guide bush (to be used with 99390804)

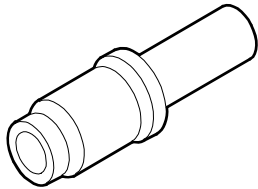
99394015

Guide bush (to be used with 99394041 or 99394043)

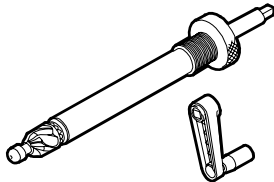
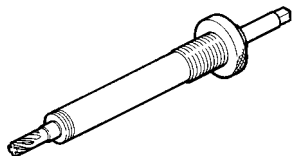
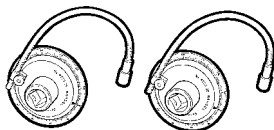
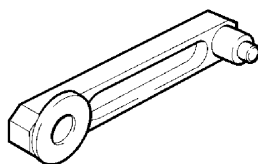
99394041Cutter to rectify injector holder housing
(to be used with 99394015)**99394043**Reamer to rectify injector holder lower side
(to be used with 99394015)**99395216**Measuring pair for angular tightening with 1/2"
and 3/4" square couplings**99395218**Gauge for defining the distance between the centres
of camshaft and transmission gear

TOOLS

TOOL NO.

DESCRIPTION

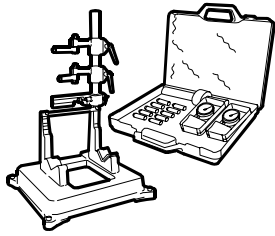
99395363

Complete square to check connecting rod squaring

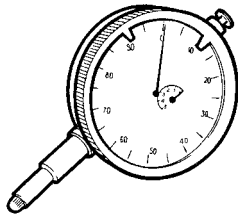
99395603

Dial gauge (0 - 5 mm)

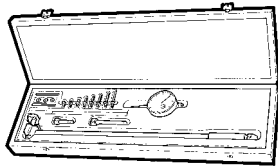
99395687

Reaming gauge (50 - 178 mm)

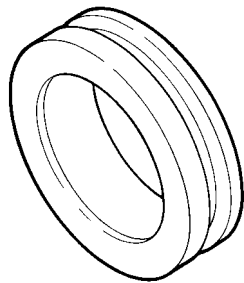
99396035

Centering ring of crankshaft front gasket cap

