

# 1994 Wildcat® Service Manual



# ARCTIC CAT® SNOWMOBILES

## FOREWORD

This manual contains service, maintenance, and troubleshooting information for the 1994 Wildcat EFI and Wildcat EFI Mountain Cat Snowmobiles. The manual is designed to aid service personnel in service-oriented applications and may be used as a textbook for service training.

This manual is divided into sections. Each section of the manual covers a specific snowmobile component or system and in addition to the standard service procedures, includes assembling, disassembling, and inspecting instructions. A troubleshooting section is also included in this manual.

The service technician should become familiar with the operation and construction of each component or system of the snowmobile by carefully studying this manual. This manual will assist the service technician in becoming more aware of and efficient with service procedures. Such efficiency not only helps build consumer confidence but also saves time and labor.

The procedures in this manual include the complete disassembly of the 1994 Wildcat EFI and Wildcat EFI Mountain Cat components. When servicing, the technician should use discretion as to how much disassembly is needed to correct any given condition.

All Arctco publications and snowmobile decals display the words Warning, Caution, and Note to emphasize important information. The symbol **⚠WARNING** identifies personal safety-related information. Be sure to follow the directive because it deals with the possibility of severe injury or even death. The symbol **⚠CAUTION** identifies unsafe practices which may result in snowmobile-related damage. Follow the directive because it deals with the possibility of damaging a part or parts of the snowmobile. The symbol **■NOTE:** identifies supplementary information worthy of particular attention.

At the time of publication, all information, photographs, and illustrations were technically correct. Because Arctco, Inc. constantly refines and improves its products, no retroactive obligation is incurred.

All materials and specifications are subject to change without notice.

Keep this manual accessible in the shop area for reference.

Service Department  
Arctco, Inc.

## TABLE OF CONTENTS

<b>Section</b>	<b>Page</b>	
<b>1. General Information</b>	<b>1-5</b>	<b>1</b>
<b>2. Engine</b>	<b>7-41</b>	<b>2</b>
<b>3. Fuel System</b>	<b>43-87</b>	<b>3</b>
<b>4. Drive System</b>	<b>89-118</b>	<b>4</b>
<b>5. Electrical System</b>	<b>119-136</b>	<b>5</b>
<b>6. Steering and Body</b>	<b>137-161</b>	<b>6</b>
<b>7. Track/Suspension</b>	<b>163-188</b>	<b>7</b>
<b>8. Recoil Starter</b>	<b>189-192</b>	<b>8</b>
<b>9. Aids for Maintenance</b>	<b>193-197</b>	<b>9</b>
<b>10. Troubleshooting</b>	<b>199-207</b>	<b>10</b>

# SECTION 1 - GENERAL INFORMATION

## TABLE OF CONTENTS

Specifications . . . . .	2
Break-In Procedure . . . . .	3
Recommended Gasoline . . . . .	3
Recommended Oil . . . . .	3
Genuine Parts . . . . .	3
Summer Storage . . . . .	3
Preparation After Storage . . . . .	4



# Specifications\*

ENGINE AND DRIVE			
Engine Model	AC70L4		
Displacement	cc (cu in.)	700 (42.71)	
Bore x Stroke	mm (in.)	81 x 68 (3.188 x 2.667)	
Compression Ratio	6.2:1		
Piston-Ring End Gap Range	mm (in.)	0.20-0.80 (0.008-0.031)	
Piston Skirt/Cylinder Clearance Range	mm (in.)	0.095-0.150 (0.0037-0.0059)	
Piston Pin Diameter Range	mm (in.)	19.995-20.000 (0.7872-0.7874)	
Piston-Pin Bore Diameter Range	mm (in.)	20.002-20.010 (0.7875-0.7878)	
Connecting-Rod Small End Diameter Range	mm (in.)	26.003-26.011 (1.0237-1.0241)	
Crankshaft End Play Range	mm (in.)	0.05-0.10 (0.002-0.004)	
Crankshaft Runout (max.) (Total Indicator Reading)	mm (in.)	0.05 (0.002)	
Cylinder Trueness (max.)	mm (in.)	0.10 (0.004)	
Drive Clutch/Driven Pulley Offset	mm (in.)	34.67 (1.365)	
Center-to-Center Distance	cm (in.)	28.9 (11.375)	
Engagement Speed (RPM)	3200-3600		
Peak RPM	8100-8300		
Cam Arm	Standard	p/n	0646-117 (53.0 g)
	4-10,000 ft	p/n	0646-102 (50.5 g)
	over 10,000 ft	p/n	0646-031 (48.5 g)
Spring	Standard	p/n	0646-083
		(color)	(Red)
	over 4000 ft	p/n	0146-526
		(color)	(Green/Yellow)
Chain Pitch	Standard	72	
	(over 4000 ft)	70	
Sprocket Ratio	Standard	23/40	
	(over 4000 ft)	20/39	
Lighting Coil Output @ 3000 RPM	12V/240W		
Ignition Type	CDI/NCI		
Spark Plug	NGK BR9ES		

ENGINE AND DRIVE (cont.)			
Spark-Plug Gap	mm (in.)	0.7 (0.028)	
Brake Type	Hydraulic Brake/ Double Piston/ Fixed Disc		
Track Width	cm (in.)	38 (15)	
Overall Track Length	cm (in.)	307 (121)	345.4** (136**)
Track Length on Ground	cm (in.)	88.9 (35)	104** (41**)
CHASSIS			
Length w/Skis	cm (in.)	282 (111)	299** (118**)
Height w/Windshield	cm (in.)	116.2 (45.75)	
Overall Width	cm (in.)	114.3 (45)	
Ski "Center-to-Center" Distance	cm (in.)	99 (39)	
MISCELLANY			
Curb Weight (approx.)	kg (lb)	277 (610)	288** (635**)
Dry Weight (approx.)	kg (lb)	235 (518)	246** (543**)
Gas Tank Capacity	l (U.S. Gal)	41.6 (11)	
Coolant Capacity	l (U.S. qt)	3.3 (3.5)	
Chain Case Fluid Level	ml (fl oz)	236 (8)	
Gasoline Octane (rating) Minimum	87		
Engine Oil	50:1 Injection Oil		
Chain Case Lubricant	Transmission Lube		
Grease	Low Temperature		
Taillight/Brakelight	p/n	0109-460	
Headlight	p/n	0609-171	
Drive Belt	p/n	0627-011	
Ignition Timing @ 4000 RPM	degree mm (in.)	30 5.670 (0.223)	
Gas/Oil Mixture	Oil Injection		

\* Specifications subject to change without notice.  
\*\* Wildcat EFI Mountain Cat.

## Break-In Procedure

New and overhauled EFI snowmobile engines require a short break-in period (1 tankful of fuel). During the break-in period, a maximum of 1/2 throttle is recommended. However, brief full throttle acceleration (only after the engine has reached operating temperature) and variations in driving speed contribute to good engine break-in.

Do not pre-mix the first tank of fuel with oil. Start the engine and allow to idle. Using a long stiff wire with a hook bent at one end, hook the actuator arm of the oil-injection pump. Raise the arm to the full-open position. With the engine running hold the arm in the full-open position for 3 to 4 minutes or until the oil lines to each cylinder are free of all air bubbles.

## Recommended Gasoline

The recommended gasoline to use in this snowmobile is 87 minimum octane regular unleaded. In many areas, oxygenates (either ethanol or MTBE) are added to the gasoline. Oxygenated gasolines containing up to 10% ethanol or up to 15% MTBE are acceptable gasolines.

When using ethanol blended gasoline, it is not necessary to add a fuel de-icer since ethanol will prevent the accumulation of moisture in the fuel system.

### CAUTION

Do not use white gas or gasolines containing methanol. Only Arctco approved gasoline additives may be used.

## Recommended Oil

The correct oil to use in the oil-injection system is Arctco 50:1 Injection Oil. This oil is specially formulated to be used as an injection oil and meets all of the lubrication requirements of the Arctic Cat Snowmobile engine.

### CAUTION

Any oil used in place of the recommended oil could cause serious engine damage.

## Genuine Parts

When replacement of parts is necessary, use only genuine Arctco Arctic Cat parts. They are precision-made to ensure high quality and correct fit. Refer to the Illustrated Parts Manual for the correct part number, quantity, and description.

## Summer Storage

Prior to storing a snowmobile for the summer, it must be properly serviced to prevent corrosion and component deterioration. If a customer requests you to prepare the snowmobile for storage, use the following procedure:

1. Clean the seat cushion with a damp cloth and Vinyl Protectant (p/n 0636-173).
2. Clean the snowmobile thoroughly by hosing dirt, oil, grass, and other foreign matter from the skid frame, tunnel, hood, and belly pan. Allow the snowmobile to dry thoroughly. DO NOT get water into any part of the engine.

1

3. Fill the gas tank to its rated capacity; then add the correct ratio of Arctic Cat Fuel Stabilizer (p/n 0638-165) to the gas tank. Tighten the gas cap securely.
4. Place the rear of the snowmobile up on a shielded safety stand. Remove the air intake silencer boots from the throttle body.
5. Start the engine and allow to idle until operating temperature is reached. With the engine idling, spray Arctco Engine Preserver (p/n 0636-177) into the throttle body until the engine exhaust starts to smoke heavily, or until the engine starts to drop in RPM. Turn the engine off.
6. Install the intake silencer boots.
7. Plug the exhaust system outlet with a clean cloth.
8. With the ignition switch key in the OFF position:
  - A. Disconnect the spark-plug caps from the spark plugs and remove the spark plugs.
  - B. Pour 29.5 ml (1 fl oz) of SAE #30 petroleum based oil into each spark-plug hole and pull the recoil handle slowly about 10 times.
  - C. Install the spark plugs and connect the spark-plug caps.
9. Every year or 1000 miles, drain the chain-case lubricant by removing the chain-case drain plug located on the backside of the chain case assembly. Remove the chain-case cover and inspect the chain, sprockets, chain tensioner, and rollers for wear. Check the chain for proper tension. Install the chain-case cover, O-ring seal, and drain plug; then pour 236 ml (8 fl oz) of Transmission Lube (p/n 0636-817) into the filler hole. On models with reverse, pour 354 ml (12 fl oz) of Transmission Lube into the filler hole.
10. Open the clutch shield; then remove the drive belt from the driven pulley and drive clutch. Lay the belt on a flat surface or slide it into a cardboard sleeve to prevent warping or distortion during storage. Secure the clutch shield.
11. Apply a light oil to the upper steering post bushing, pivot bushings of the ski frame, and plungers of the shock absorbers.
12. Lubricate the front and rear suspension, spindles, ball joints, and speedometer drive adapter with a low-temperature grease.
13. Tighten all nuts, bolts, and screws. Make sure all rivets holding the components together are tight. Replace all loose rivets. Care must be taken that all calibrated nuts and bolts are tightened to specifications.
14. Fill the cooling system to within 2.5 cm (1 in.) of the filler cap with properly mixed coolant.
15. Disconnect the battery cables from the battery; then clean the battery posts and cables. Fully charge the battery and store in a cool dry place off cement floors. Periodically charge the battery.
16. Lightly sand the bottom of the skis; then using black paint (p/n 0652-024), paint the entire bottom of the skis.
17. Clean and polish the hood, console, and chassis with Arctco Hood and Windshield Cleaner Polish (p/n 0636-174). **DO NOT USE SOLVENTS OR SPRAY CLEANERS. THE PROPPELLENT WILL DAMAGE THE FINISH.**
18. Store the snowmobile indoors. Raise the track off the floor by blocking up the rear of the snowmobile making sure the snowmobile is secure. Loosen the rear idler wheel adjusting bolts to decrease track tension. Cover with a machine cover to protect from dirt and dust. If the snowmobile must be stored outdoors, position the snowmobile out of direct sunlight; then block the entire snowmobile off the ground making sure it is secure. Loosen the rear idler wheel adjusting bolts to decrease track tension. Cover with a machine cover to protect from dirt, dust, and rain.

**⚠ CAUTION**

Avoid storing in direct sunlight and using a plastic cover as moisture may collect on the snowmobile causing corrosion.

## Preparation After Storage

Taking the snowmobile out of summer storage and correctly preparing it for another season will assure many miles and hours of trouble-free snowmobiling. Arctco recommends the following procedure to prepare the snowmobile.

1. Clean the snowmobile thoroughly. Polish the exterior of the snowmobile using Arctco Hood and Windshield Cleaner Polish (p/n 0636-174).
2. Remove the cloth from the exhaust system; then check the exhaust system and air silencer for obstructions.
3. Inspect all control wires and cables for signs of wear or fraying; replace if necessary. Use cable ties or tape to route wires and cables away from hot or rotating parts.
4. Inspect the drive belt for cracks and tears. Check belt specifications. Replace if damaged or worn. If the old belt is worn but still in good condition, keep it in the tool box as a spare in case of emergency. Install drive belt.
5. Examine fuel hoses and connections for deterioration, tightness, and cracks; replace as necessary.
6. Fill the oil-injection tank with Arctco 50:1 Injection Oil.
7. Check the coolant level and all coolant lines and connections for deterioration or cracks. Add properly mixed coolant as necessary.
8. Check brake lever travel, wear indicator clearance, all controls, headlight, tail light, brake light, ski alignment, ski wear-bars, wear-strips, and headlight aim. Adjust or replace if necessary.
9. Inspect throttle cable adjustment.
10. Tighten all nuts, bolts, and screws making sure all calibrated nuts and bolts are tightened to specifications.
11. Lubricate the front and rear suspension, spindles, ball joints, and speedometer drive adapter with a low-temperature grease.
12. Check the chain case fluid level. Inspect for leakage.
13. Check the spark plugs. Clean or replace as necessary.
14. Charge the battery and test. Install the battery and clean the connections. Attach the positive battery cable to the battery positive terminal; then the negative battery cable to the negative terminal.
15. Adjust the track to the proper tension and alignment.

**NOTE: Arctco recommends the replacement of all coolant lines every four years or 4000 miles.**



# SECTION 2 - ENGINE

## TABLE OF CONTENTS

Engine Specifications . . . . .	8
Removing Engine . . . . .	8
Disassembling Engine . . . . .	10
Cleaning and Inspecting Engine . . . . .	18
Cylinder Heads . . . . .	18
Cylinders . . . . .	19
Piston Assembly . . . . .	19
Crankcase . . . . .	20
Water Pump Assembly . . . . .	20
Crankshaft . . . . .	21
Removing Outer Crankshaft Bearings . . . . .	22
Installing Outer Crankshaft Bearings . . . . .	23
Pinion Drive . . . . .	23
Reed Valves . . . . .	24
Measuring Critical Components . . . . .	24
Cylinder Trueness . . . . .	24
Piston Skirt/Cylinder Clearance . . . . .	24
Piston-Ring End Gap . . . . .	25
Piston Pin and Piston-Pin Bore . . . . .	25
Connecting-Rod Small End . . . . .	26
Crankshaft Runout . . . . .	26
Assembling Engine . . . . .	26
Shimming Pinion Gear . . . . .	37
Pressure Testing Engine . . . . .	38
Installing Engine . . . . .	39
Liquid Cooling System . . . . .	40
Filling Cooling System . . . . .	41
Inspecting Thermostat . . . . .	41
Inspecting Coolant Hoses and Clamps . . . . .	41

## Engine Specifications

Engine Model		AC70L4
No. of Cylinders		2
Engine Lubrication		Oil Injection
Starter System		Recoil
Bore x Stroke	mm (in.)	81 x 68 (3.188 x 2.677)
Displacement	cc (cu in.)	700 (42.71)
Compression Ratio		6.2:1
Piston-Ring End Gap Range	mm (in.)	0.20-0.80 (0.008-0.031)
Piston Skirt/Cylinder Clearance Range	mm (in.)	0.095-0.150 (0.0037-0.0059)
Piston Pin Diameter Range	mm (in.)	19.995-20.000 (0.7872-0.7874)
Piston-Pin Bore Diameter Range	mm (in.)	20.002-20.010 (0.7875-0.7878)
Connecting-Rod Small End Diameter Range	mm (in.)	26.003-26.011 (1.0237-1.0241)
Crankshaft End Play Range	mm (in.)	0.05-0.10 (0.002-0.004)
Crankshaft Runout (max.) (Total Indicator Reading)	mm (in.)	0.05 (0.002)
Cylinder Trueness (max.)	mm (in.)	0.10 (0.004)
Reed Stopper Height	mm (in.)	8.8 ± 0.2 0.350 ± 0.008

## Removing Engine

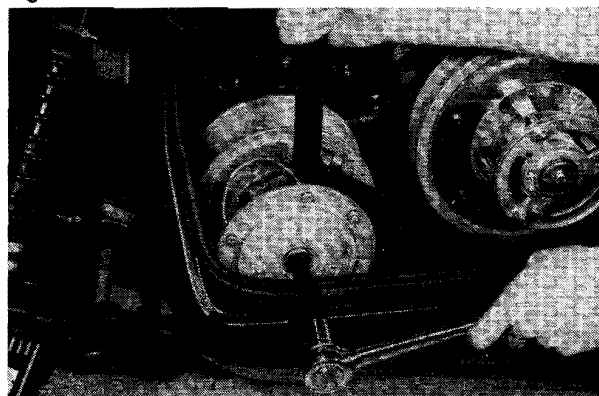
1. Disconnect the negative battery cable from the battery.
2. Disconnect the headlight harness. Remove the cap screw securing the hood cable to the engine; then remove the two hood hinge pins and remove the hood from the snowmobile.

3. Open and remove the clutch shield; then remove the drive belt. Remove the drive clutch retainer plug and washer.

**NOTE:** Before installing the clutch puller apply grease to the tip and oil to the threads.

4. Remove the retainer plug and washer. Bend the top edge of the belly pan inward and down; then using a 1/2 in. 12-point socket, remove the bolt and lock washer securing the drive clutch to the crankshaft. Next, using the Clutch Puller (p/n 0644-096) and an impact wrench (or a breaker bar and Drive Clutch Spanner Wrench (p/n 0644-136)), tighten the puller. If the drive clutch will not release, sharply strike the head of the puller. Repeat complete procedure until the clutch releases. Account for the two sleeves found in the clutch bore. Remove the driven pulley. Account for all washers and key.

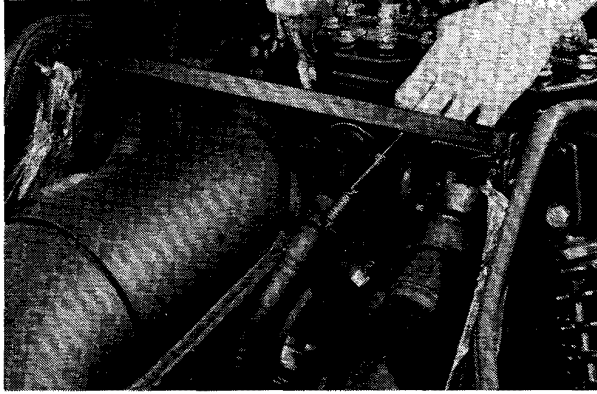
Fig. 2-1



AM055

5. Remove the four springs securing each expansion chamber to the header pipe; then remove the two springs securing each expansion chamber to the resonator. Remove the springs securing the expansion chambers to the front end and remove the expansion chambers.

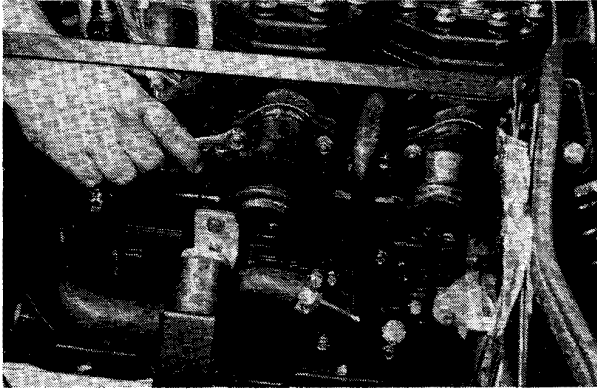
Fig. 2-2



AP001

6. Remove the nuts and lock washers securing the head pipes; then remove the head pipes. Discard the exhaust gaskets.

Fig. 2-3

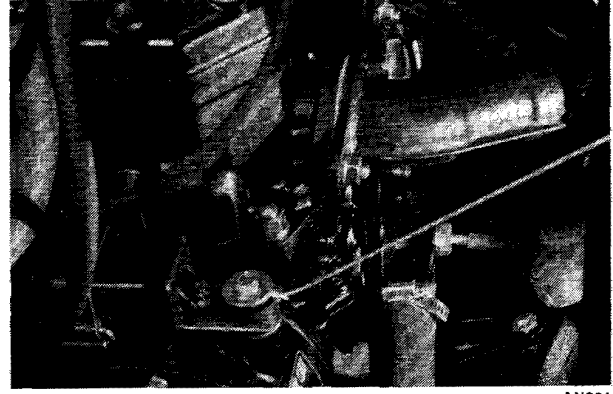


AP004

7. Attach a long piece of fuel line to the engine coolant drain (located on the exhaust side of the engine). Route the line outside the engine compartment and into a container. Open the drain and remove the filler cap. Once the coolant stops flowing, remove the hose and tighten the drain valve.

**NOTE:** The cooling system can be more completely drained if the rear of snowmobile is elevated on a jackstand and the filler cap is removed.

Fig. 2-4



AN001

8. Loosen the intake flange clamp securing the throttle body; then remove the throttle body from the flanges.
9. Disconnect the main wiring harness from the engine harness. Disconnect the spark-plug caps from the spark plugs and the CDI unit wiring harness. Remove the timing sensor, injector sensor, and ground wires from the magneto housing.
10. Remove the E-clip and washer securing the oil-injection cable; then disconnect the oil-injection cable from the injection pump. Disconnect the oil-supply hose from the pump and plug the hose to prevent oil drainage.

**NOTE:** To prevent oil drainage from the supply hose during removal from the pump, attach a vacuum pump (p/n 0644-131) to the oil tank vent hose and apply 2 to 3 in.-lb of vacuum to the oil tank. Plug the hose using a large bolt; then remove the vacuum pump.

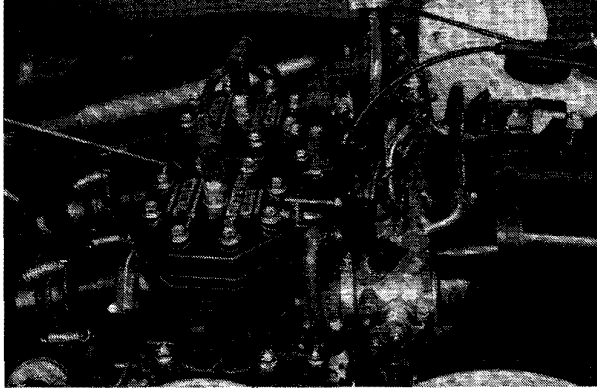
Fig. 2-5



AN009

11. Loosen the clamp securing the hose to the thermostat housing and pull the hose from the housing. Loosen the clamp securing the supply hose to the water pump housing and pull the hose from the water pump. Loosen the clamp securing the coolant hose to the PTO-side of the throttle body. Remove coolant hoses.

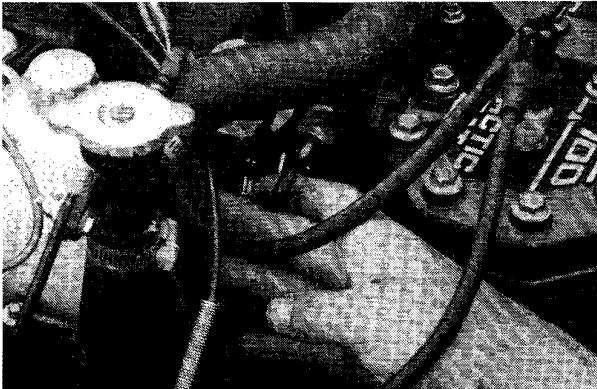
Fig. 2-6



AO065

12. Disconnect the wires from the temperature warning light sensor and the ECU coolant temperature sensor.

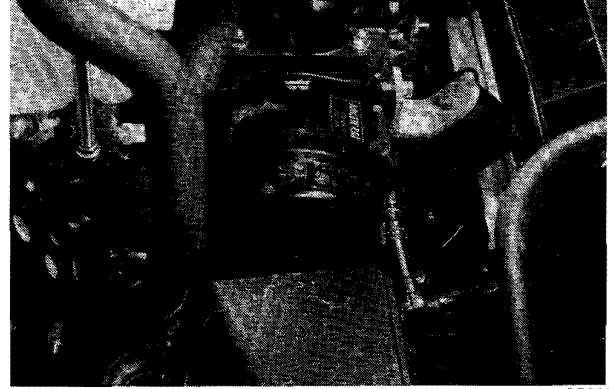
Fig. 2-7



AJ159

13. Remove the four cap screws and lock washers securing the recoil; then remove the recoil from the engine. Leave the recoil in the engine compartment.

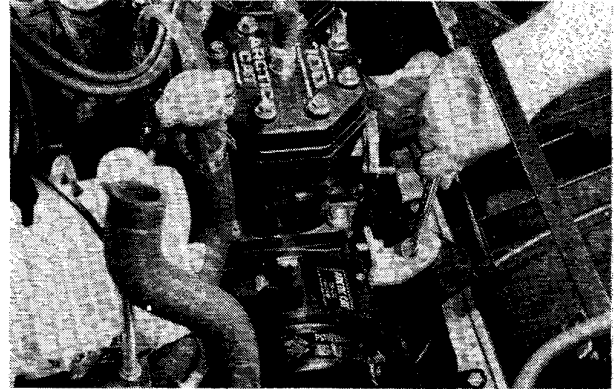
Fig. 2-8



AP011

14. Remove the four cap screws securing the engine to the front end. Note the position of the shims on the left rear mount. The rear right-side and front left-side cap screws will require using a 3/8 in. twelve-point socket for removal.

Fig. 2-9



AP009

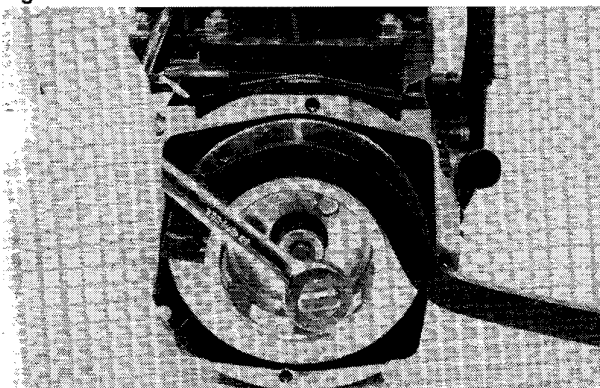
15. Slowly lift the engine and watch for any wires or hoses which may have been overlooked. Twist the engine to the side to clear the support brace as it is lifted from the engine compartment.
16. Remove the front and rear mounting brackets from the engine crankcase.

## Disassembling Engine

1. Using a spanner wrench to secure the flywheel, remove the flywheel nut, lock washer, and flat washer.



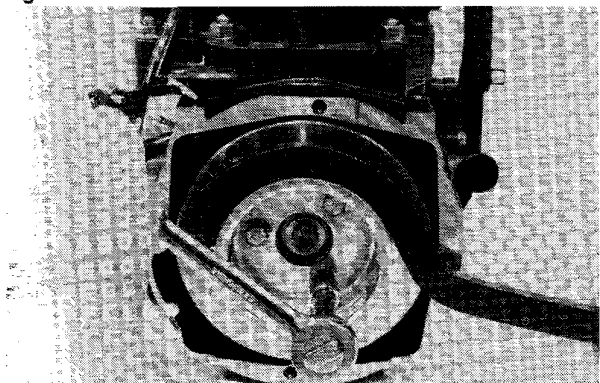
Fig. 2-10



AJ012

- Using a spanner wrench to secure the crankshaft, remove the three cap screws from the starter pulley. Remove the starter pulley.

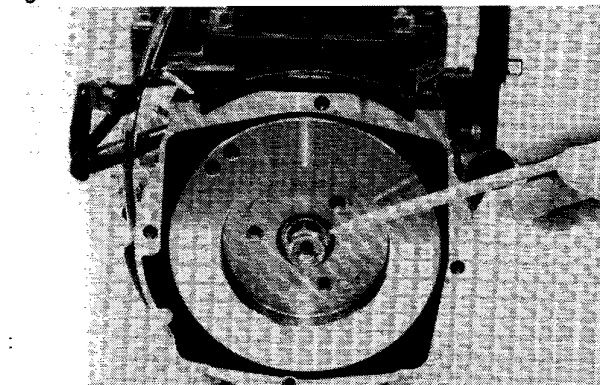
Fig. 2-11



AJ013

- Install a protective cap onto the end of the crankshaft.

Fig. 2-12



AJ014

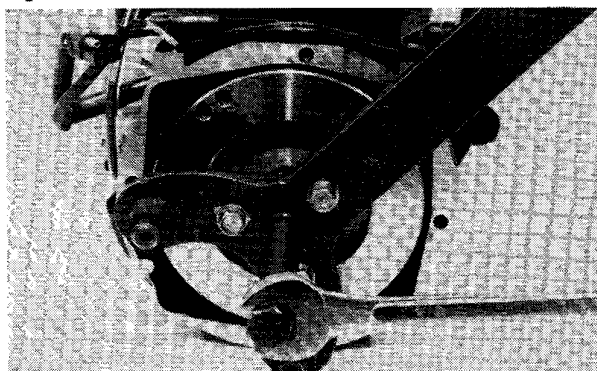
**NOTE:** A protective cap can be made by welding a 3 mm (1/8 in.) plate on one end of a spare flywheel nut.

**CAUTION**

To prevent damage to the crankshaft, thread a protective cap onto the crankshaft. The puller must bottom on the cap and not on the crankshaft. Also, do not thread puller bolts more than 12.7 mm (1/2 in.) into the flywheel. Damage to the coils may result.

- Using the Flywheel Puller (p/n 0144-310), remove the flywheel from the crankshaft by tightening the puller bolt, striking the head of the puller bolt with a brass hammer, and tightening again. Repeat procedure until the flywheel is free. Account for the key in the crankshaft keyway.

Fig. 2-13



AJ015

**CAUTION**

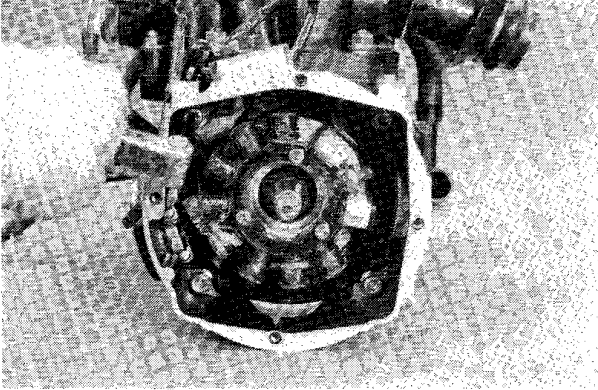
Before applying excessive pressure to the center flywheel puller bolt, check to make sure puller bolt is pulling straight. If it is pulling to one side, the crankshaft will be damaged. Square the puller using the three bolts that attach the puller to the flywheel.

**NOTE:** To ensure the cleanliness of the flywheel magnets, place the flywheel (with the magnets facing upward) on a clean bench.

- Using a 6 mm hex head wrench, remove the four cap screws securing the magneto housing to the crankcase; then remove the housing. Account for the two alignment pins.



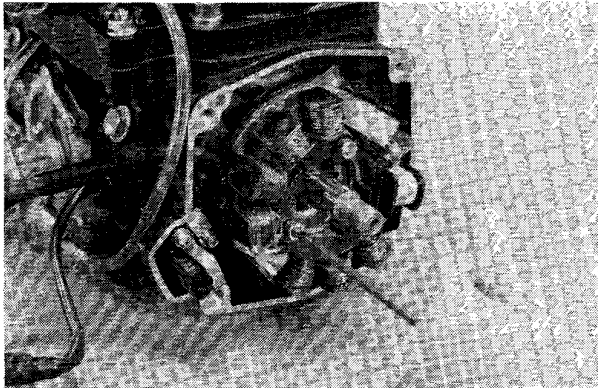
Fig. 2-14



AO008

6. Remove the three cap screws securing the coil ring to the backing plate using a 5 mm hex wrench. Slide the coil ring off the crankshaft and remove from the engine.

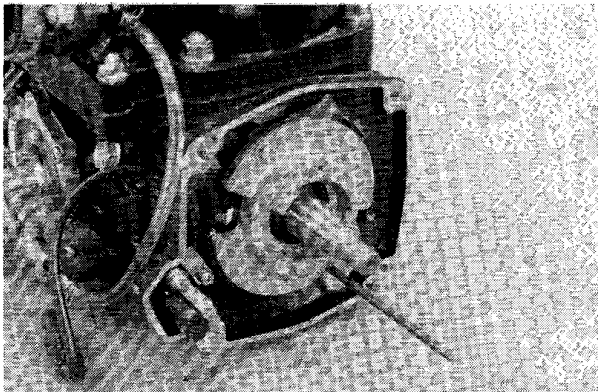
Fig. 2-15



AO002

7. Remove the two cap screws securing the backing plate to the crankcase; then remove the backing plate from the engine. You may wish to mark the backing plate for ease of assembly.

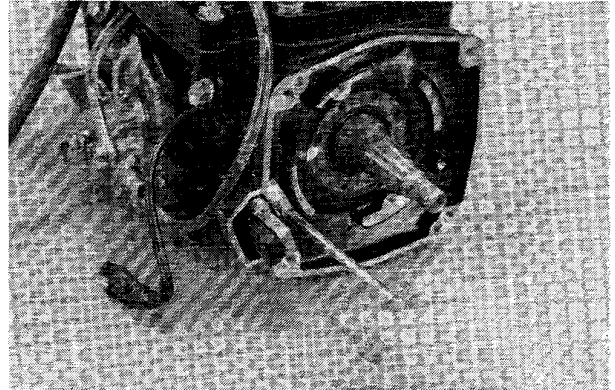
Fig. 2-16



AO004

8. Remove the two screws securing the RPM sensor; then loosen the screw securing the wiring harness clamp and remove the sensor from the engine.

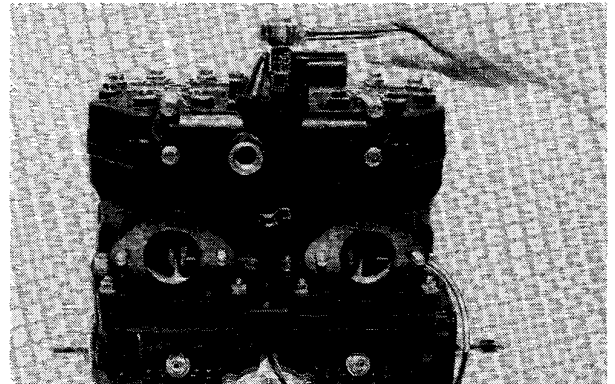
Fig. 2-17



AO005

9. Remove the four nuts and washers securing the intake flanges; then remove the flanges with balance hoses.
10. Compress and slide the clamp securing the bypass hose away from the end of the hose; then pull the hose from the thermostat housing.
11. Remove the three cap screws securing the thermostat cap; then remove the cap, rubber gasket, and thermostat.

Fig. 2-18

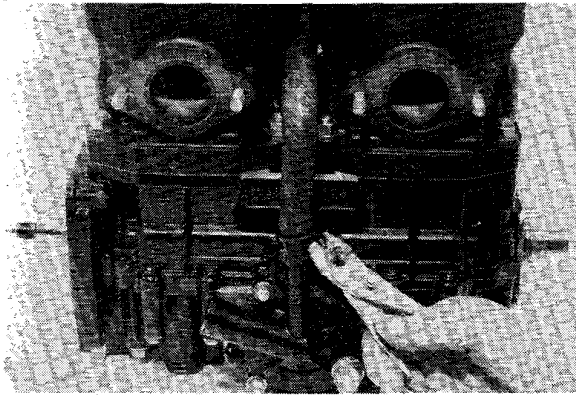


AJ020

12. Slip the hose clamp up from the end of the bypass hose at the water-pump cover and pull the hose free of the water-pump cover. Remove the hose from between the cylinders.



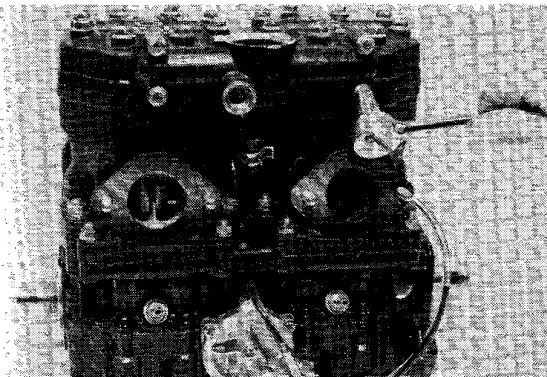
Fig. 2-19



AJ026

13. Remove the four cap screws securing the thermostat manifold to the cylinder heads. Remove the manifold and discard gaskets.

Fig. 2-20

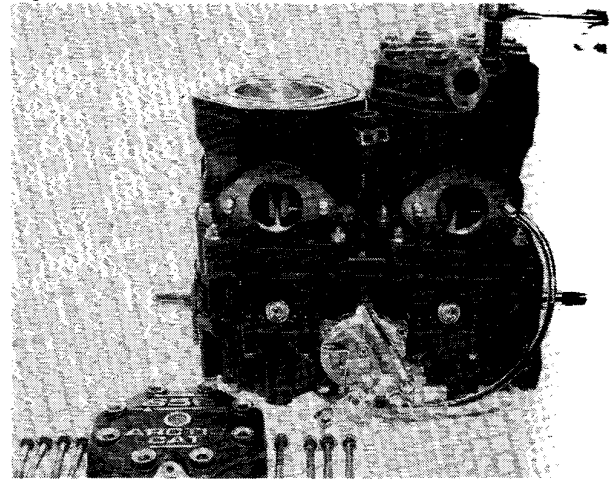


AJ022

14. Remove the spark plugs.
15. Remove the eight cap screws and O-rings securing each head; then separate each head from each cylinder. Account for two O-rings beneath each head.

**NOTE:** Mark each cylinder head, cylinder, and piston and keep together as an assembly. Mark the MAG cylinder #1 and PTO cylinder #2.

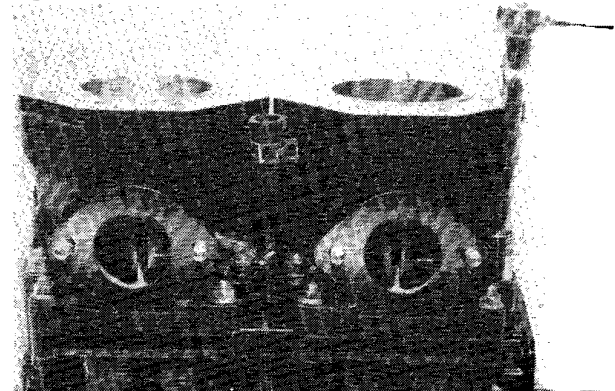
Fig. 2-21



AJ023

16. Remove the oil-injection line from each cylinder nozzle.
17. Remove the eight cylinder base nuts and four flange nuts securing the cylinders to the crankcase. Account for eight flat washers and lock washers. Using a rubber hammer, gently tap on the side of each cylinder to free it from the crankcase.

Fig. 2-22



AJ027

18. Slowly lift each cylinder straight up and free of the studs. Grasp the connecting rod and piston as the cylinder clears the piston to prevent the rod from dropping against the crankcase. Remove and save the cylinder base gaskets.

Fig. 2-23



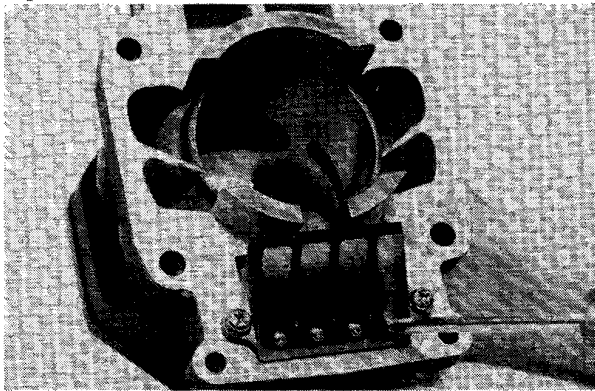
AJ028

**CAUTION**

As cylinders are removed, lay them on their side on the workbench. Never set cylinders upright on any hard surface. The reed stoppers will be damaged.

19. Remove the four screws securing each reed stopper to each reed seat. Remove stopper and reed valve assembly.

Fig. 2-24

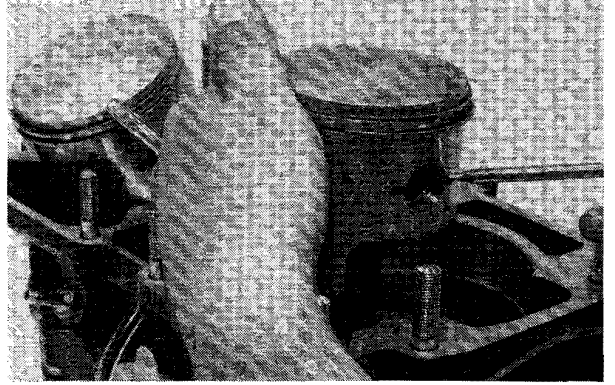


AJ058

**NOTE:** The reed seat can remain on the cylinder unless it requires service, in which case, remove the two screws securing the reed seat to the cylinders; then remove the reed seat and discard the gasket.

20. Remove the PTO-side piston-pin circlip from the PTO-side piston; remove the MAG-side piston-pin circlip from the MAG-side piston.

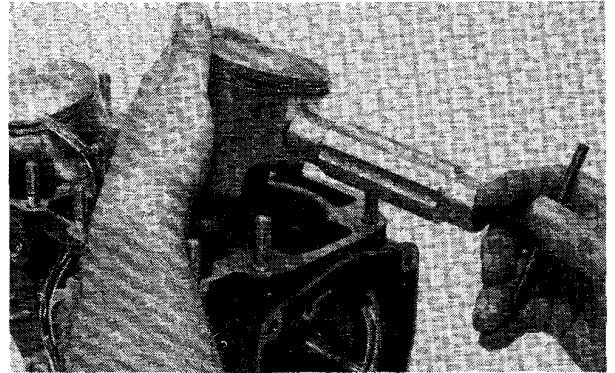
Fig. 2-25



AJ029

21. Using the Piston Pin Puller (p/n 0144-003), remove the piston pins from both pistons.

Fig. 2-26



AJ030

**NOTE:** For proper assembly, keep all MAG-side components and all PTO-side components separated. Assemble them on their proper sides.

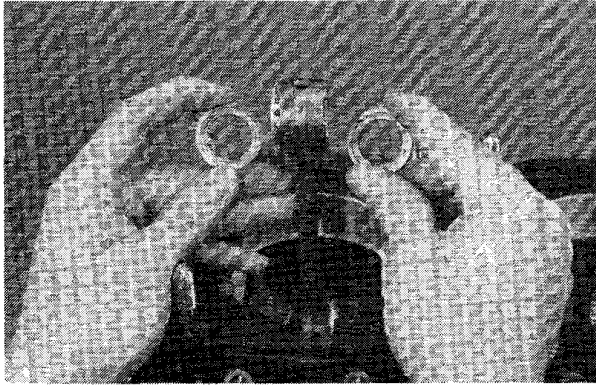
**CAUTION**

DO NOT use any type of punch to drive the pin free of the piston; damage may result. Use a piston-pin puller only.

22. Lift the pistons clear of the connecting rods and account for two washers. Remove the small-end connecting-rod bearings; then remove the piston rings. Keep each piston with its rings; keep each piston, pin, bearing, and washers together as a set.



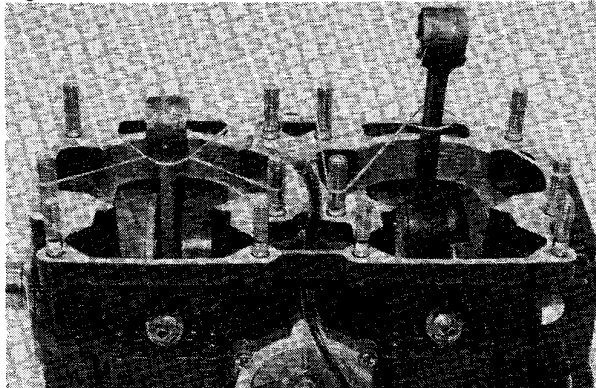
Fig. 2-27



AQ059

**NOTE:** Place rubber bands over the connecting rods and around the cylinder studs. This will keep the connecting rods from damaging the crankcase.

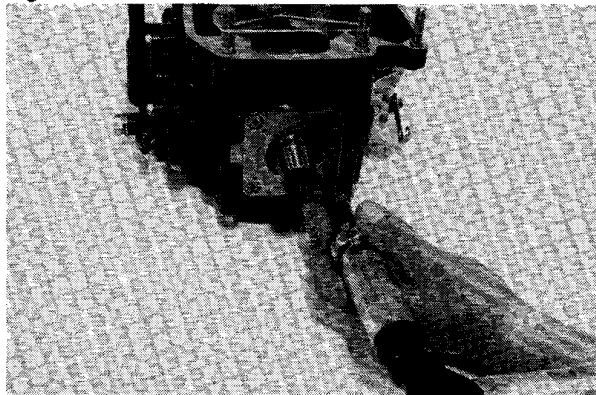
Fig. 2-28



AJ031

23. Using an impact driver, remove the four screws securing the PTO end plate to the crankcase; then remove the plate.

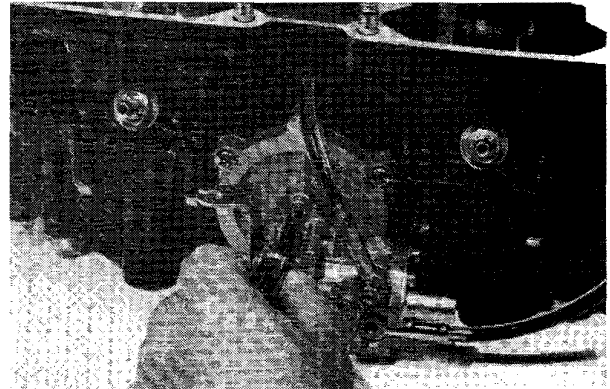
Fig. 2-29



AJ032

24. Remove the two screws and lock washers securing the oil-injection pump to the crankcase.

Fig. 2-30



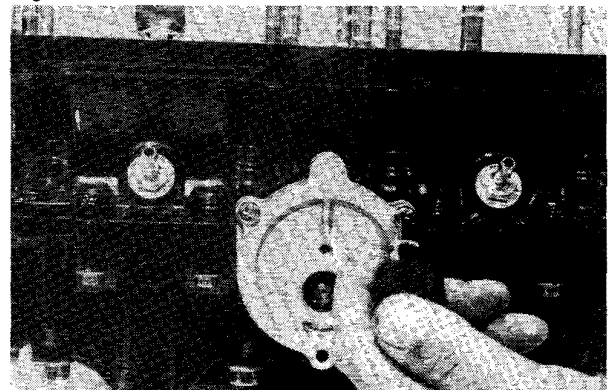
AJ035

**CAUTION**

Note that the shorter of the two screws securing the oil pump to the crankcase came from the top mounting hole of the oil-injection pump. It must be installed in the same location.

25. Remove the two screws securing the oil injection pump retainer to the crankcase. Gently tap on the retainer with a plastic hammer to free it from the crankcase. Pull the retainer straight back and free of the crankcase. Account for the O-ring found around the inner flange of the retainer sealing surface.

Fig. 2-31



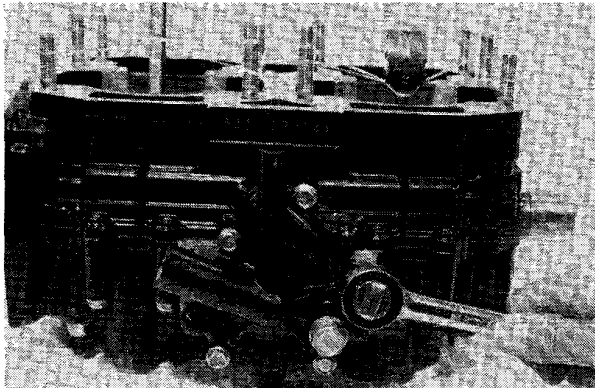
AJ036

**NOTE:** Account for the shim washer(s) found on the upper pinion driven shaft. If no shim(s) are found on the shaft, check the retainer just removed as they will sometimes stick to the bearing race. Remove shim(s) and place in a safe place where they won't be lost.



26. Remove the five cap screws securing the water-pump cover to the crankcase. Remove the cover and O-ring seal.

Fig. 2-32

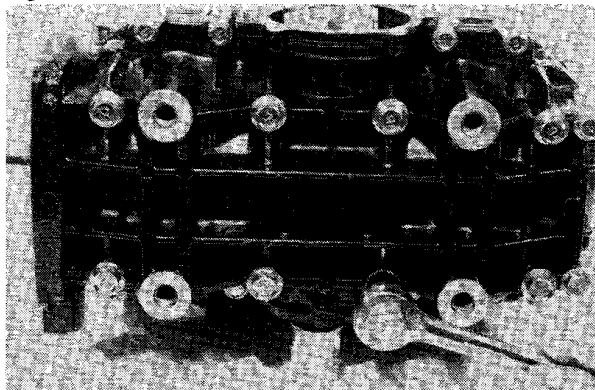


AJ033

**NOTE:** Do not remove the water pump impeller or the impeller shaft unless necessary. Only remove impeller and shaft if there are signs of coolant leakage from the small hole located in the bottom of the crankcase, directly behind the water pump housing.

27. Lay the engine on its side and remove the 18 cap screws securing the crankcase halves. Note the position of the different-sized cap screws.

Fig. 2-33



AJ038

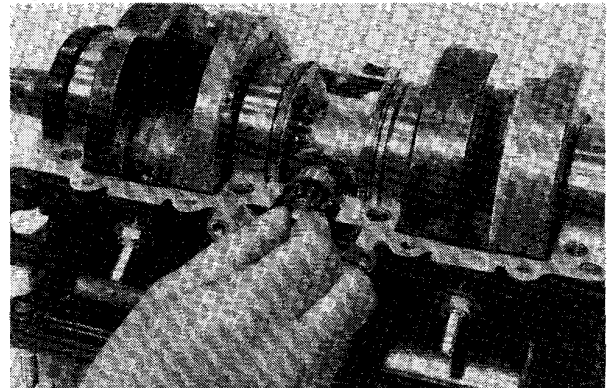
28. Separate the crankcase halves by installing two crankcase cap screws in opposite corners leaving the heads approximately 6 mm (1/4 in.) out. Using a plastic tipped hammer, tap on each cap screw head until the case halves separate; then remove the two cap screws. Remove the rubber bands and lift the top half of the crankcase off the bottom half. Grasp the connecting rods as the top half of the crankcase is removed. Do not allow them to drop onto the sealing surface of the bottom case half.

**CAUTION**

DO NOT drive any tool between halves to separate the crankcase. Damage to the sealing surfaces will result.

29. Remove the pinion gear from the crankcase account for the C-ring.

Fig. 2-34



AJ041

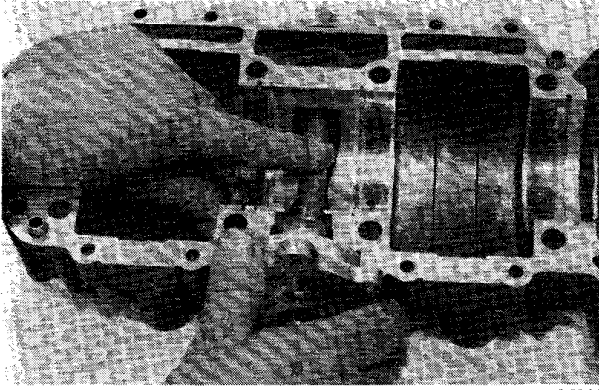
30. Lift the crankshaft free from the crankcase half and slide the crankshaft oil seals off the ends of the crankshaft. Account for the C-ring. Slide the bearing off the PTO end of crankshaft. Remove the bearing dowel pins from the crankcase.

**CAUTION**

DO NOT remove the water pump impeller or shaft unless necessary. The shaft and impeller should only be removed from the lower crankcase half when there is a coolant leakage problem or a rough inner bearing. To inspect for either condition, follow steps A through D.

- A. Remove the O-ring from the oil-injection pump retainer. Slide the retainer into position on the shaft in the lower half of the crankcase.
- B. While holding the retainer with one hand tight against the crankcase, rotate the shaft with your other hand. Bearing rotation must feel smooth.

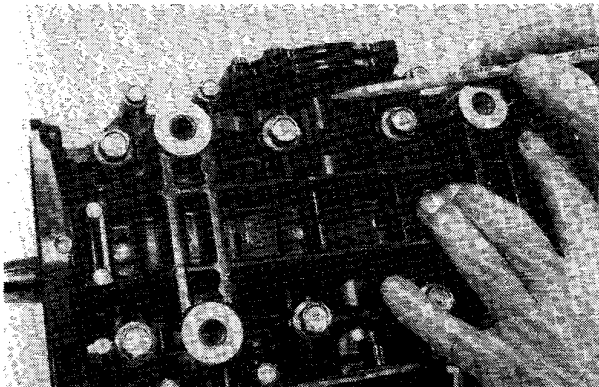
Fig. 2-35



AJ044

- C. If any roughness is felt, remove the retainer and inspect its bearing by turning it several revolutions. If it is smooth, the shaft must then be removed and the inner bearing inspected. Turn inner bearing by hand. If any roughness is felt, replace the inner bearing.
- D. Check the bottom of the water pump housing for any signs of coolant leakage. The small hole, located on the bottom of the crankcase directly behind the water pump housing, will show coolant stains if the seal has any leakage problems. If stains or any signs of leakage are present, remove impeller and shaft and replace seals.

Fig. 2-36

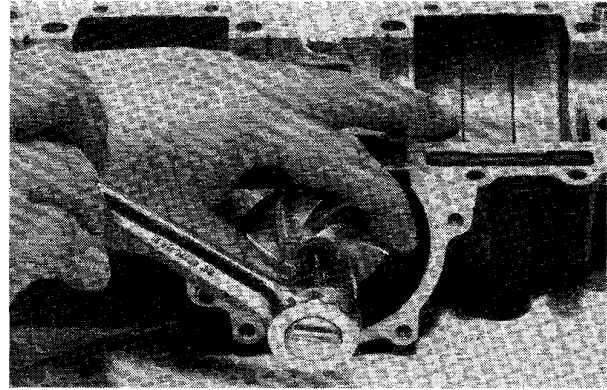


AJ045

**NOTE:** For instructions on bearing and seal replacement, see Assembling Engine section of this manual. Only complete steps 31-37 if there is a bad seal or shaft bearing.

- 31. Remove the cap screw securing the impeller to the shaft.

Fig. 2-37

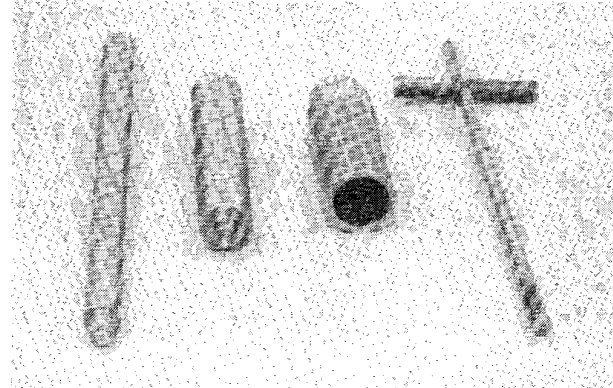


AJ046

- 32. Slowly pull the shaft from the lower half of the crankcase.

**NOTE:** Use the Water Pump Rebuilding & Bearing Kit (p/n 0644-084) to remove and replace the water pump bearing and seals.

Fig. 2-38

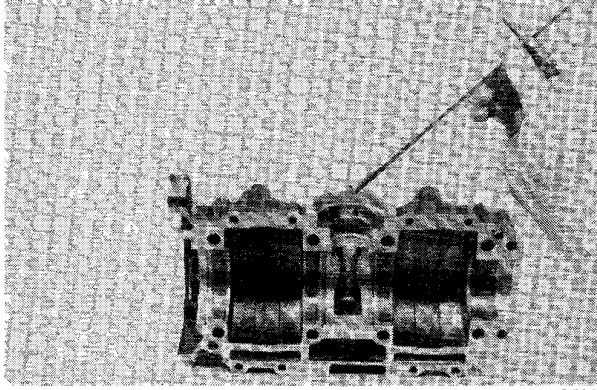


AJ142

- 33. Using the special tool, remove the water pump seal by inserting the tool rod down through the inner bearing and seal. Position the end of the tool up against the backside of the metal case of the outer water pump seal.



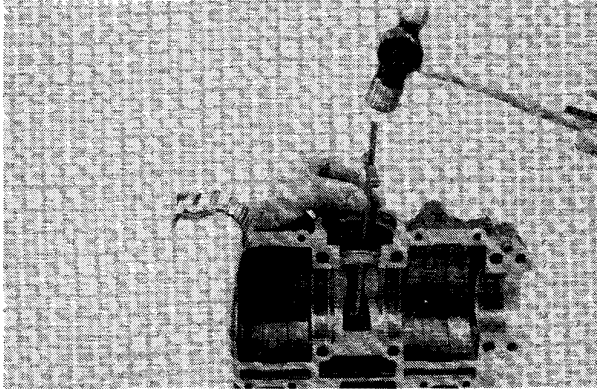
Fig. 2-39



AJ143

34. Using a hammer, gently tap on the rod while moving the end of the tool from side to side of the seal casing. Repeat until the seal is free of the crankcase.

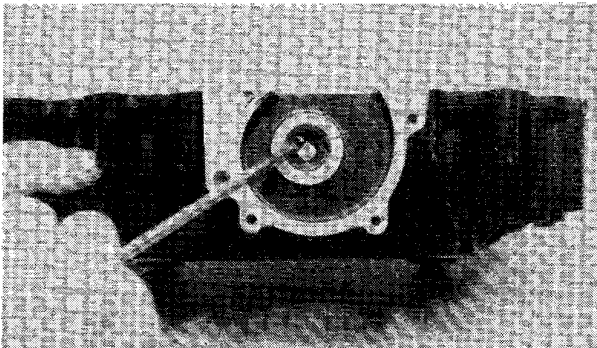
Fig. 2-40



AJ144

35. Using the hooked end of the tool, pull the inner seal free of the crankcase.

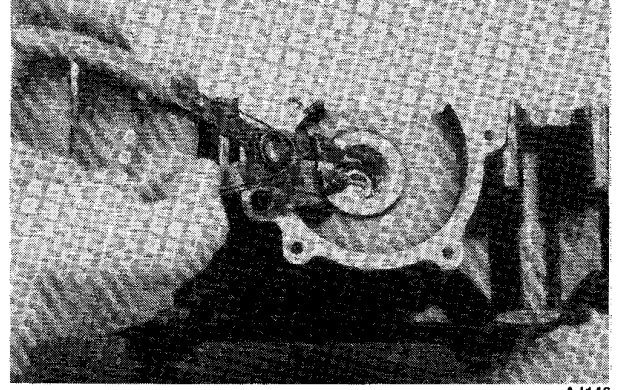
Fig. 2-41



AJ145

36. Using a pair of snap ring pliers, remove the snap ring located in front of the water pump bearing.

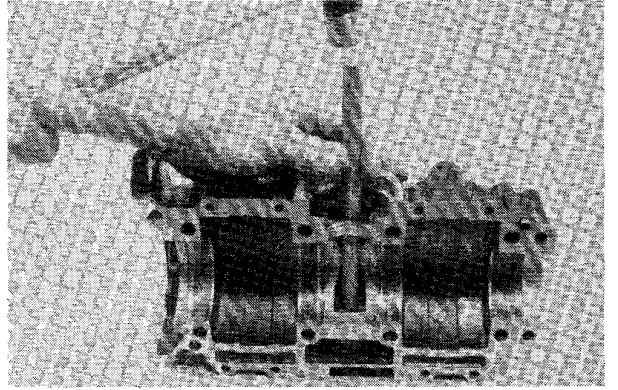
Fig. 2-42



AJ146

37. Using the bearing driver from the special tool kit, drive the water pump bearing from the crankcase.

Fig. 2-43



AJ147

## Cleaning and Inspecting Engine

**NOTE:** Whenever a part is worn excessively, cracked, defective, or damaged in any way, replacement is necessary.

### CYLINDER HEADS

1. Using a non-metallic carbon removal tool, remove any carbon buildup from the combustion chambers being careful not to nick, scrape, or damage the combustion chambers or the sealing surfaces.
2. Inspect the spark-plug holes for any damaged threads. Repair damaged threads using a "heli-coil" insert.



- Place each cylinder head on a surface plate covered with #400 grit wet-or-dry sandpaper. Using light pressure, move the cylinder head in a figure eight motion. Inspect the sealing surface for any indication of high spots. A high spot can be noted by a bright metallic finish. Correct any high spots before assembly by continuing to move the cylinder head in a figure eight motion until a uniform bright metallic finish is attained.

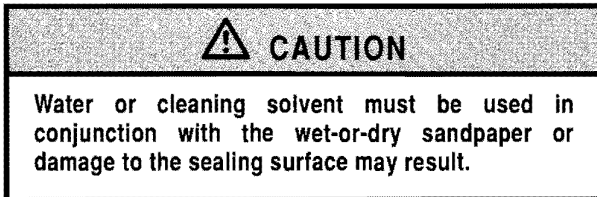


Fig. 2-44

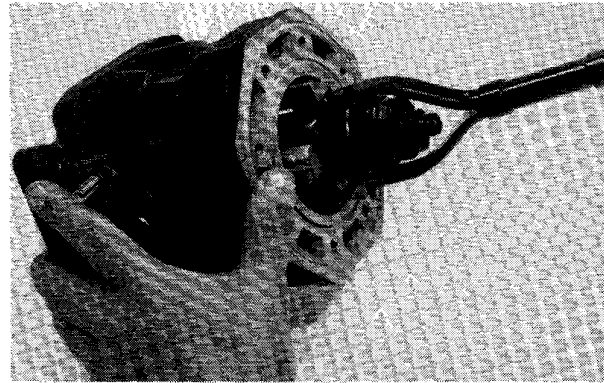


AJ160

## CYLINDERS

- Using a non-metallic carbon removal tool, remove carbon buildup from the exhaust ports.
- Wash the cylinders in cleaning solvent.
- Inspect the cylinders for pitting, scoring, scuffing, and corrosion. If marks are found, repair the surface with a surface hone using #500 grit stones and honing oil.

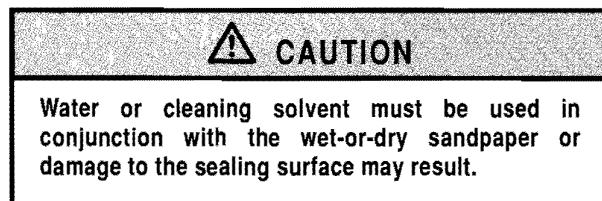
Fig. 2-45



AJ060

**NOTE:** To produce the proper 60° "cross-hatch" pattern, use a low RPM drill (600 RPM) at a rate of 30 strokes per minute. If honing oil is not available, use a lightweight, petroleum-based oil. Thoroughly clean cylinders after honing using detergent soap and hot water, and dry with compressed air; then immediately apply oil to the cylinder bores. If a bore is severely damaged or gouged, the cylinder will have to be replaced.

- Place the head surface of each cylinder on a surface plate (p/n 0644-016) covered with #400 grit wet-or-dry sandpaper. Using light pressure, move each cylinder in a figure eight motion. Inspect the surface for any indication of high spots. A high spot can be noted by a bright metallic finish. Correct any high spots before assembly by continuing to move the cylinder in a figure eight motion until a uniform bright metallic finish is attained.



## PISTON ASSEMBLY

- Using a non-metallic carbon removal tool, remove carbon buildup from the dome of each piston.
- Using an old piston ring as a tool, snap the ring in two pieces. Grind one end of the ring at a 45 degree angle and to a sharp edge. Clean carbon from the ring-groove using the ring. Be sure to position the ring with its tapered side up.

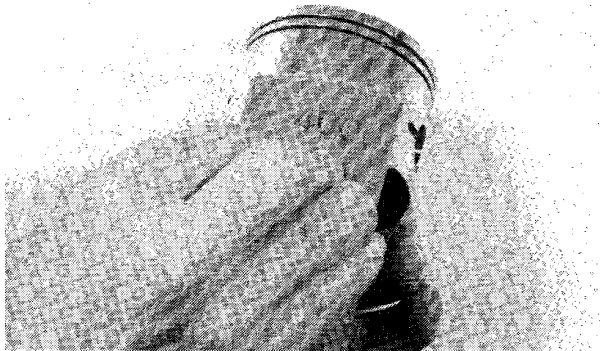
**2**

**⚠ CAUTION**

Improper cleaning of the ring grooves by using the wrong type of ring-groove cleaner will result in severe damage to the piston.

3. Inspect each piston for cracks in the piston pin and skirt areas.
4. Inspect each piston for seizure marks or scuffing. Repair with #400 grit wet-or-dry sandpaper and water or honing oil.

Fig. 2-46



AN135

**NOTE:** If scuffing or seizure marks are too deep to correct with the sandpaper, it will be necessary to replace the piston.

5. Inspect the perimeter of each piston for signs of excessive "blowby". Excessive "blowby" indicates either worn piston rings or an out-of-round cylinder.

### CRANKCASE

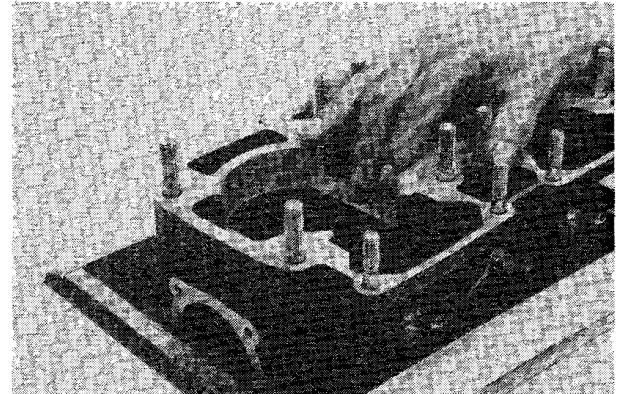
1. Wash the crankcase halves in cleaning solvent.

**NOTE:** Before washing the crankcase halves, make sure the four bearing-dowel pins have been removed and accounted for.

2. Inspect crankcase halves for scoring, pitting, scuffing, or any imperfections in the casting.
3. Inspect all threaded areas for damaged or stripped threads.
4. Inspect the bearing areas for cracks or excessive bearing movement. If evidence of excessive bearing movement is noted, repair by peening the bearing area using a center punch in a pinking (saw tooth) pattern.
5. Inspect the bearing dowel pins for wear.

6. Inspect the sealing surfaces of the crankcase halves for trueness by placing each crankcase half on a surface plate covered with #400 grit wet-or-dry sandpaper. Using light pressure, move each half in a figure eight motion. Inspect the sealing surface for any indication of high spots. A high spot can be noted by a bright metallic finish. Correct any high spots by continuing to move the half in a figure eight motion until a uniform bright metallic finish is attained.

Fig. 2-47



AJ056

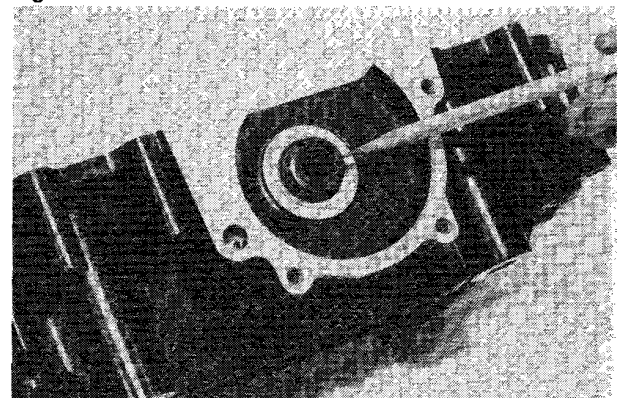
**⚠ CAUTION**

Water or cleaning solvent must be used in conjunction with the wet-or-dry sandpaper or damage to the sealing surface may result.

### WATER PUMP ASSEMBLY

1. If the water pump shaft was removed, inspect the water pump seal for any rough areas or scratches on its outer sealing surface. If either condition is found, replace the seal.

Fig. 2-48



AJ089

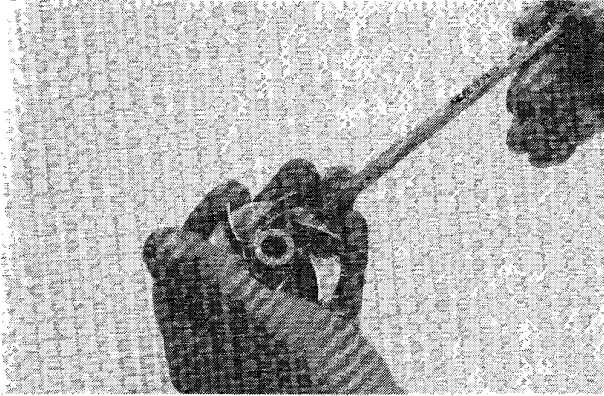


2. Inspect the water pump shaft bearing located in the crankcase. Turn the bearing by hand. If any roughness or binding is noted, replace the bearing.

**NOTE:** For seal or bearing replacement instructions, see **Assembling Engine** section of this manual.

3. Inspect the water pump impeller. Inspect impeller blades for any signs of cracking or chipping. If either condition exists, replace the impeller.

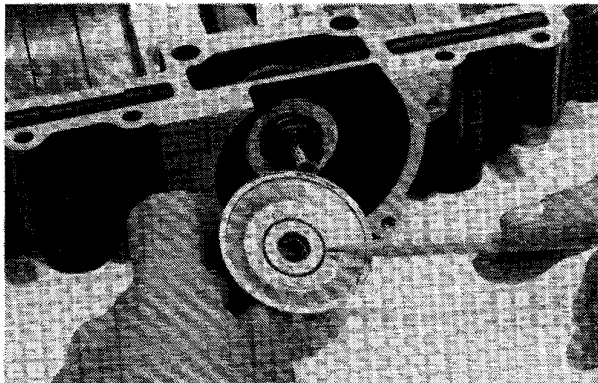
Fig. 2-49



AJ049

4. Inspect the impeller sealing surface (located on the backside of the impeller). The sealing surface must be smooth and free of any worn, scratched, or chipped areas. If any of these conditions exist, replace the impeller sealing ring. It can be removed by prying upward using a small screwdriver blade. To install the new sealing ring place the rubber cup washer into the impeller seal area. Next, place the seal (marked side down) into the rubber cup and press firmly into position using your thumbs.

Fig. 2-50



AJ048

5. Inspect the water pump driveshaft. Inspect the gear for any signs of chipping or gear tooth roughness. If either condition is found, replace the driveshaft.
6. Inspect the bearing and seal areas of the driveshaft. If roughness or discoloration is noted in these areas, replace the driveshaft.

Fig. 2-51



AJ088

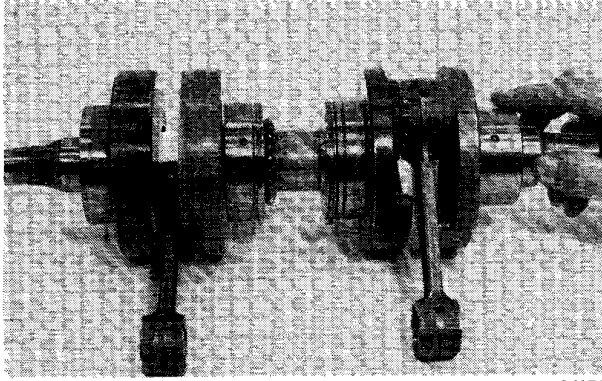
## CRANKSHAFT

1. Wash the crankshaft and bearings in cleaning solvent.
2. Inspect the bearings for wear, scoring, scuffing, damage, or discoloration. Rotate the bearings. Bearings must rotate freely and must not bind or feel rough. If any abnormal condition is noted, replace the bearing (see Removing Outer Crankshaft Bearings section).
3. Inspect crankshaft PTO-end bearing. Rotate bearing and check for roughness. If any roughness or binding is noted, replace the bearing. The bearing may be removed by simply sliding straight off the PTO end. Wash, oil, and check bearing again. If the bearing still feels rough, replace the bearing. Check PTO-end of the crankshaft. If the bearing-race area is rough, replace the PTO end of the crankshaft.

2



Fig. 2-52



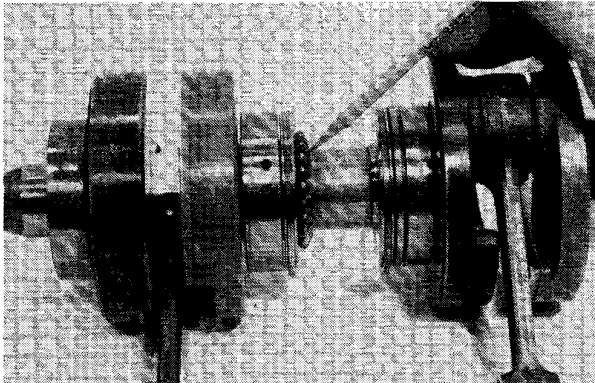
AJ074

4. Inspect the connecting-rod bearings by rotating them. Bearings must rotate freely and must not bind or feel rough. If a connecting-rod bearing must be replaced, the connecting rod and crank pin must also be replaced.

**NOTE:** Lubricate bearings thoroughly prior to assembly.

5. Inspect the crankshaft drive gear for wear or chipped teeth. If either condition is found, replace either the gear or the crankshaft assembly.

Fig. 2-53

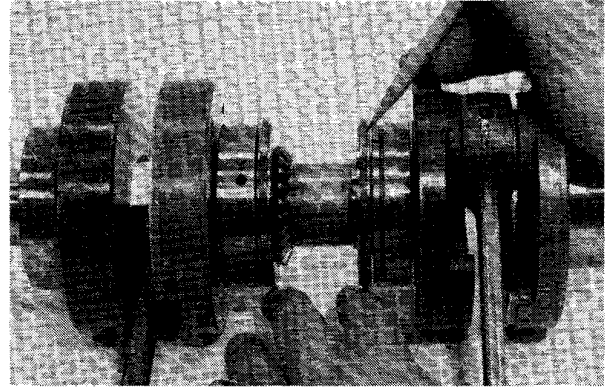


AJ070

**NOTE:** The gear is replaceable only by completely disassembling the crankshaft. To disassemble the crankshaft, special tools and skills are required. It is recommended that you contact an experienced crankshaft rebuilder or the Arctco Service Department if you decide to rebuild a crankshaft.

6. Visually inspect the two crankshaft sealing rings for wear or any signs of cracks. If either condition exists, replacement is required. See the preceding note concerning crankshaft gear replacement.

Fig. 2-54



AJ069

### Removing Outer Crankshaft Bearings

#### WARNING

A good pair of safety glasses must be worn when spreading bearings.

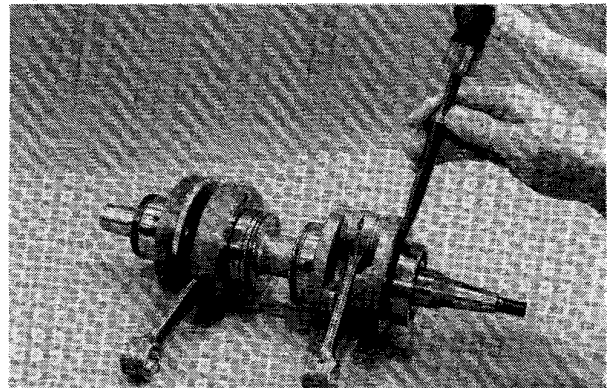
1. Place a bearing support (block of wood, etc.) beneath the bearing that is to be removed.

#### CAUTION

A bearing support must be positioned beneath the bearing that is to be removed to prevent crankshaft damage.

2. Drive a chisel or bearing splitter between the bearing race and counterweight until the bearing is spread far enough to install the jaws of the Crankshaft Bearing Remover.

Fig. 2-55

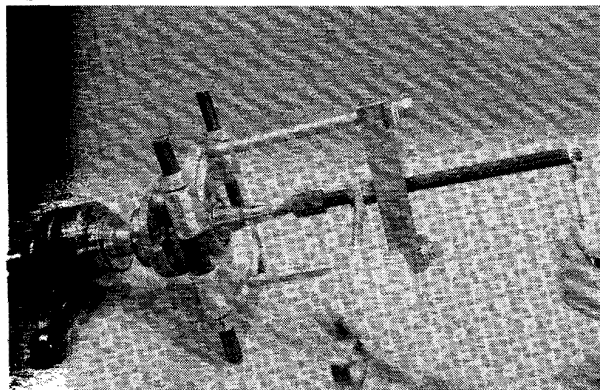


AO007



- Place a protective cap on the end of the crankshaft; then using the Crankshaft Bearing Remover (p/n 0144-302), pull the bearing off the end of the crankshaft. Account for any shim(s).

Fig. 2-56



AO006

**NOTE:** When removing a MAG-side bearing from the crankshaft, thread either a protective cap or the flywheel nut onto the crankshaft to prevent damage to the crankshaft threads. Also, make sure to note the position of the dowel-pin hole.

- The PTO-side bearing may be removed by simply sliding the bearing off the PTO end.
- Inspect the crankshaft bearing area for wear. If any wear is noted, replace the crankshaft end.

### Installing Outer Crankshaft Bearings

**NOTE:** Steps 1-3 are for installing the MAG-side bearing.

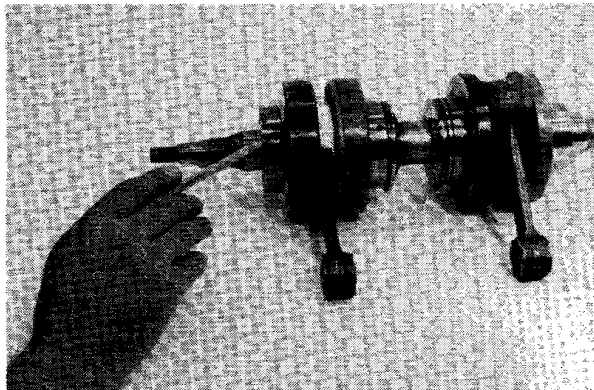
- Wrap a thick towel around the crankshaft; then secure the crankshaft vertically in a vise.
- Heat the bearing either by placing the entire bearing on a hot plate covered with oil or by squirting oil into the bearing and using a propane torch to heat the inner race of the bearing until a slight smoke is noted coming from the bearing.

**CAUTION**

DO NOT overheat the bearing.

- Place any shims removed during disassembly onto the crankshaft; then slide the bearing onto the crankshaft making sure the dowel-pin hole in the outer race is properly positioned and will align with its hole and pin in the crankcase.

Fig. 2-57



AJ072

- Lubricate the PTO-bearing rollers with a good snowmobile oil; then slide the bearing onto the PTO end of the crankshaft. Make sure the bearing dowel pin hole is positioned next to the crankshaft counterweight.

**NOTE:** There are two holes in the outer bearing race surface. The hole that is drilled through the bearing race is the bearing lubrication port and must be positioned outwards.

### PINION DRIVE

- Inspect the pinion gear teeth for wear, roughness, or chipping. Rotate the pinion bearing and check for roughness or binding. If either the pinion gear or bearing is defective, the pinion assembly must be replaced.

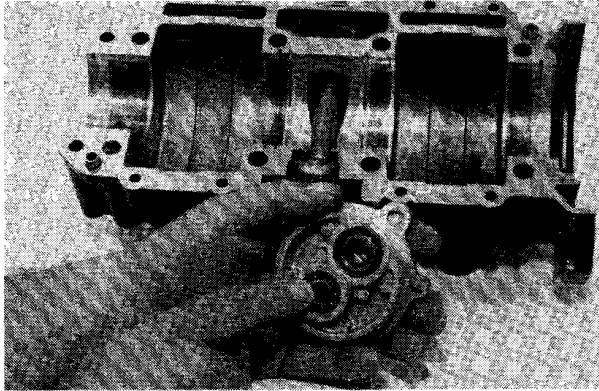
**CAUTION**

If either the pinion assembly or the crankshaft is ever replaced, the pinion and crankshaft gear must be re-shimmed for proper alignment and backlash. Failure to do so will cause extensive engine damage. For the proper shimming instructions, see the Assembling Engine section of this manual.

- Inspect the two bearings found in the oil injection pump retainer. Rotate each bearing by hand. If either bearing feels rough or is binding, replace the bearing. Remove the bearings from the retainer using an inside puller.

2

Fig. 2-58

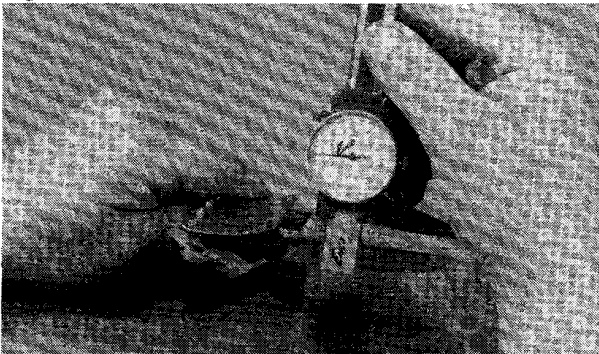


AJ050

### REED VALVES

1. Inspect the seats for cracks or wear.
2. Inspect the reeds for cracks.
3. Inspect the reed stopper height. Using a caliper, measure the distance from the seat to the bottom outer tip edge of the stopper. Measurement must not exceed specifications. If measurements are not within specifications, either bend or replace the reed stopper. See Assembling Engine section for instructions.

Fig. 2-59



AJ156

Reed Stopper Height	
mm	in.
8.8 ± 0.2	0.350 ± 0.008

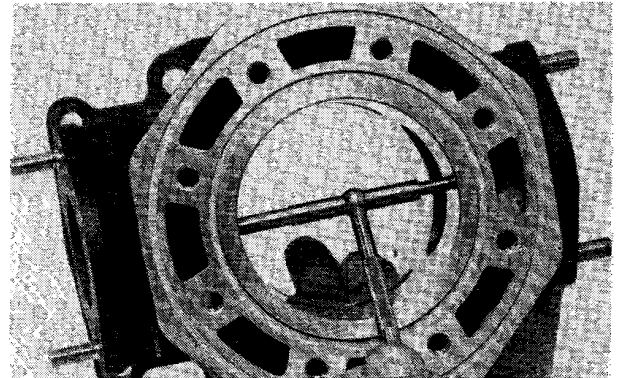
4. Inspect the reed-to-seat clearance. Using a feeler gauge, measure the clearance. Clearance must be less than 0.20 mm (0.008 in.). If clearance is not within specifications, replace the reed valve (see Assembling Engine section for instructions).

## Measuring Critical Components

### CYLINDER TRUENESS

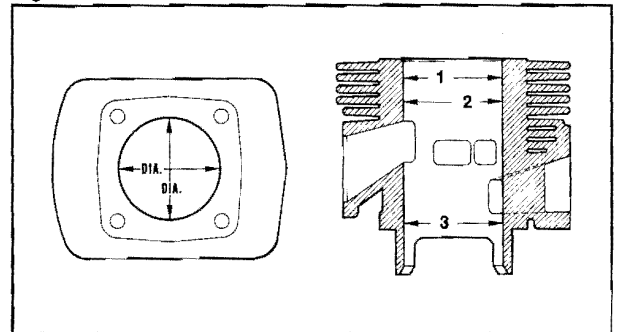
1. Measure each cylinder in the three locations shown from front to back and side to side for a total of six readings. The trueness (out-of-roundness) is the difference between the highest and lowest reading. Maximum trueness (out-of-roundness) must not exceed specifications listed.

Fig. 2-60



AJ061

Fig. 2-61



0727-863

CYLINDER TRUENESS LIMIT	
mm	in.
0.10	0.004

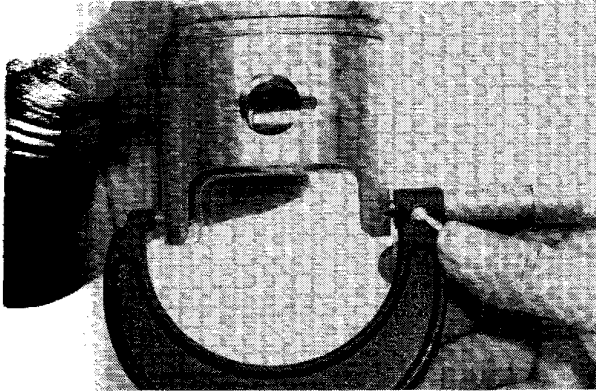
### PISTON SKIRT/CYLINDER CLEARANCE

1. Measure each cylinder front to back 2.5 cm (1 in.) from the bottom of each cylinder.



2. Measure the corresponding piston diameter at a point 1 cm (0.394) above the piston skirt at a right angle to the piston-pin bore. Subtract this measurement from the measurement in step 1. The difference (clearance) must be within specifications.

Fig. 2-62



AJ063

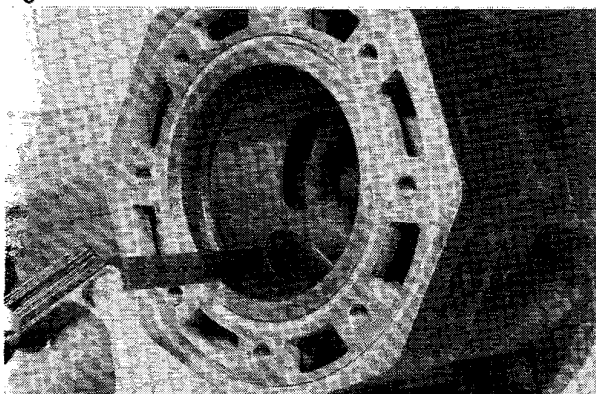
**PISTON SKIRT/CYLINDER CLEARANCE RANGE**

mm	in.
0.095-0.150	0.0037-0.0059

**PISTON-RING END GAP**

1. Place each piston ring in the wear portion above the exhaust port of its respective cylinder. Use the piston to position each ring squarely in each cylinder.
2. Using a feeler gauge, measure each piston-ring end gap. Acceptable ring end gap must fall within specifications.

Fig. 2-63



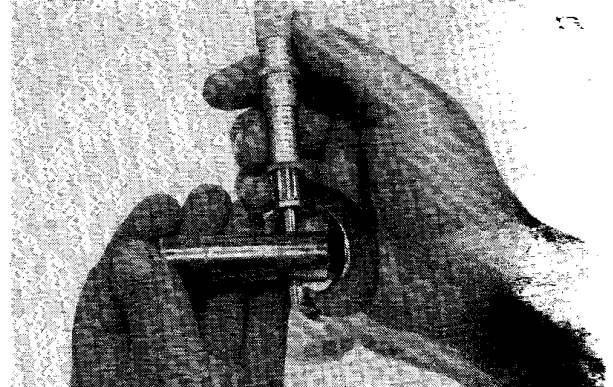
AJ068

PISTON-RING END GAP RANGE	
mm	in.
0.20-0.80	0.008-0.031

**PISTON PIN AND PISTON-PIN BORE**

1. Measure the piston pin diameter in several places. If any measurement varies by more than 0.02 mm (0.001 in.), the piston pin and bearing must be replaced as a set.

Fig. 2-64

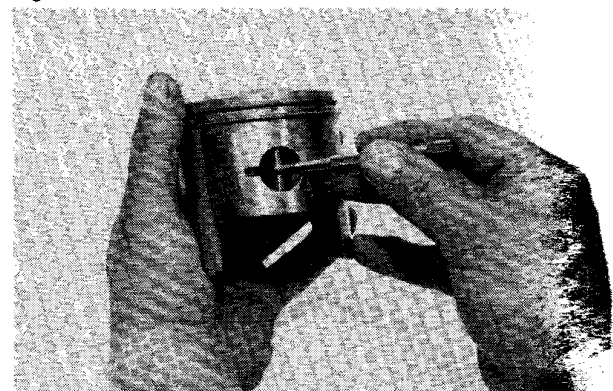


AJ065

PISTON PIN DIAMETER RANGE	
mm	in.
19.995-20.000	0.7872-0.7874

2. Insert a snap gauge into each piston-pin bore; then remove the gauge and measure it with a micrometer. Diameter must be within specifications. Take two measurements to ensure accuracy.

Fig. 2-65



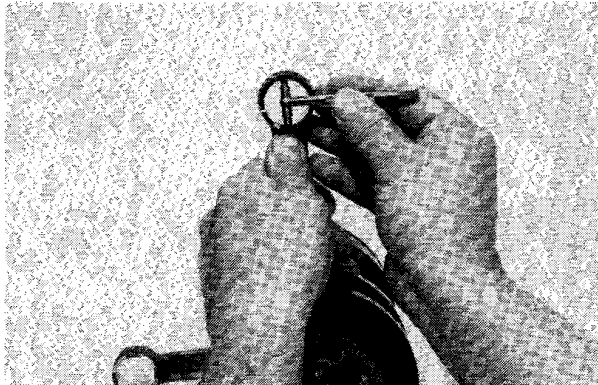
AJ064

PISTON-PIN BORE DIAMETER RANGE	
mm	in.
20.002-20.010	0.7875-0.7878

### CONNECTING-ROD SMALL END

1. Insert a snap gauge into each connecting-rod small end bore; then remove the gauge and measure it with a micrometer. Diameter must be within specifications.

Fig. 2-66



AJ076

CONNECTING-ROD SMALL END DIAMETER RANGE	
mm	in.
26.003-26.011	1.0237-1.0241

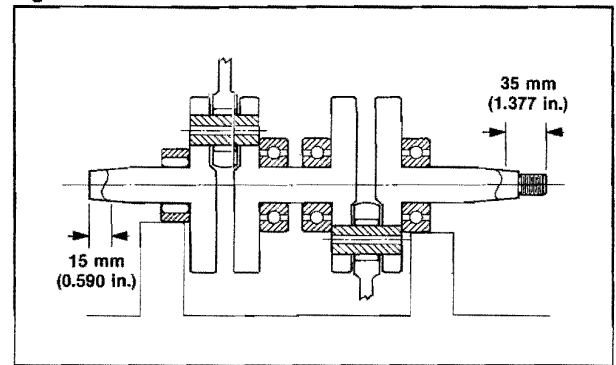
### CRANKSHAFT RUNOUT

1. Using a set of V-blocks, support the crankshaft on a surface plate.

**NOTE:** The V-blocks should support the crankshaft on a surface plate.

2. Mount a dial indicator having a magnetic base on the surface plate. Position the indicator contact point against the crankshaft 15.0 mm (0.590 in.) in from the PTO end of the crankshaft. Zero the indicator and rotate the crankshaft slowly. Note the amount of crankshaft runout (total indicator reading).
3. Position the indicator contact point against the crankshaft 35.0 mm (1.377 in.) in from the MAG end of the crankshaft. Zero the indicator and rotate the crankshaft slowly. Note the amount of crankshaft runout (total indicator reading).

Fig. 2-67



0728-144

CRANKSHAFT RUNOUT (Total Indicator Reading)		
	mm	in.
Maximum	0.05	0.002

4. Position the indicator contact point against either center bearing. Zero the indicator and rotate the crankshaft slowly. Note the amount of crankshaft runout (total indicator reading).
5. If runout exceeds specifications at either end or in the middle, the crankshaft must be either straightened or replaced.

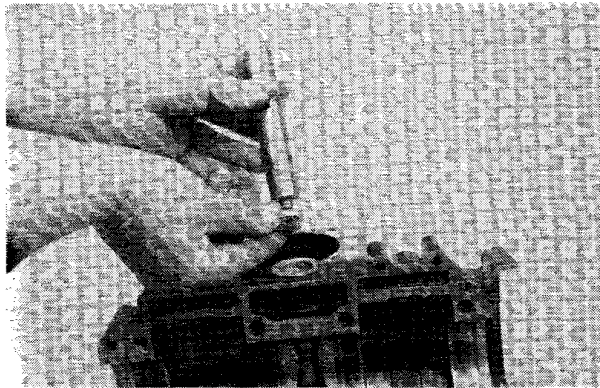
## Assembling Engine

**NOTE:** Complete steps 1-8 only if the water pump has been disassembled.

1. Using the bearing installation tool from the Water Pump Rebuilding & Bearing Kit and a hammer, place the water pump shaft bearing down into the bore and drive it into position. Seat the bearing against the rear shoulder of the bore.

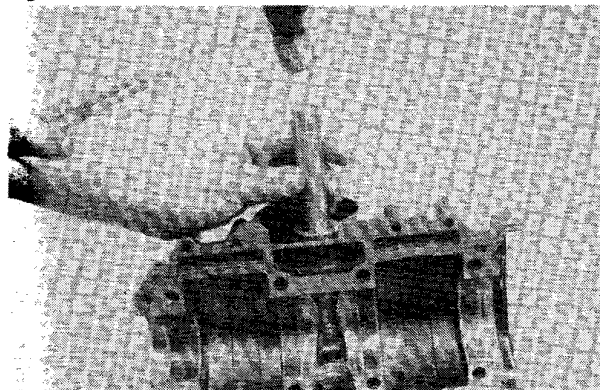


Fig. 2-68



AJ148

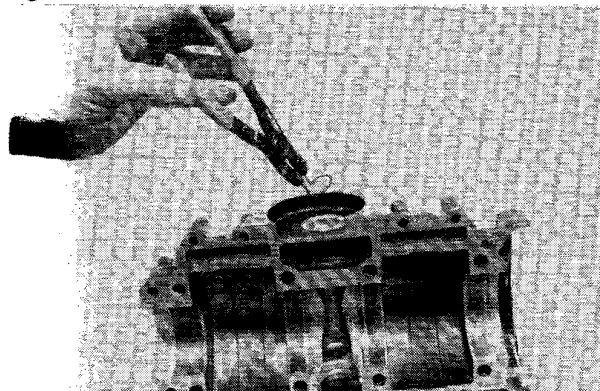
Fig. 2-69



AJ149

- Using a pair of snap ring pliers, install the snap ring which secures the water pump shaft bearing. Make sure the snap ring is seated firmly in the snap ring groove.

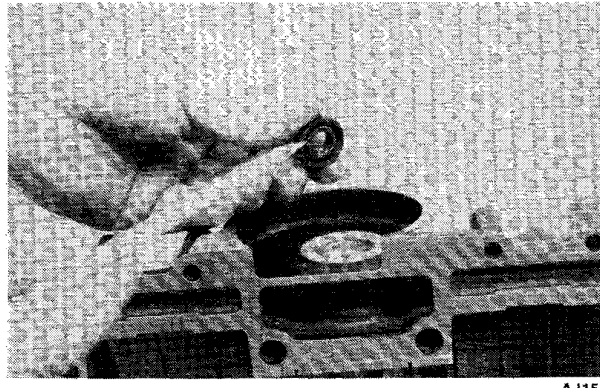
Fig. 2-70



AJ150

- Apply grease to the inner lips of the small water pump shaft seal. Position the seal on the seal driver with the spring side of the seal facing outward. Make sure the small spring located around the lip of the seal is properly positioned.

Fig. 2-71



AJ151

**CAUTION**

When positioning the seal on the driver, check to make sure the small spring is still in position around the lip of the seal.

- Using the seal driver, gently drive the seal down into position against the snap ring. Check the seal after the first couple of taps to make sure it is started straight.

Fig. 2-72



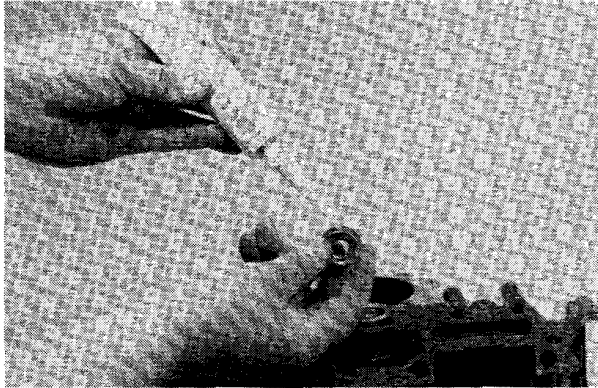
AJ152

- Apply a thin, even coat of silicone sealer (p/n 0636-069) to the outer metal case of the water pump seal.

2



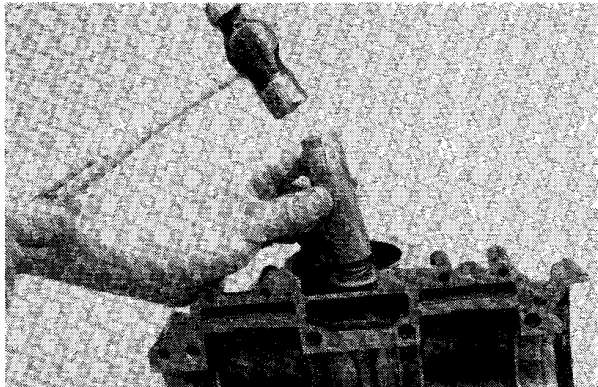
Fig. 2-73



AJ153

- Using the water pump seal driver, gently drive the seal into position in the crankcase bore. The seal is properly seated when its metal flange is tight against the crankcase. Wipe any excess sealer from the crankcase after the seal is properly seated.

Fig. 2-74

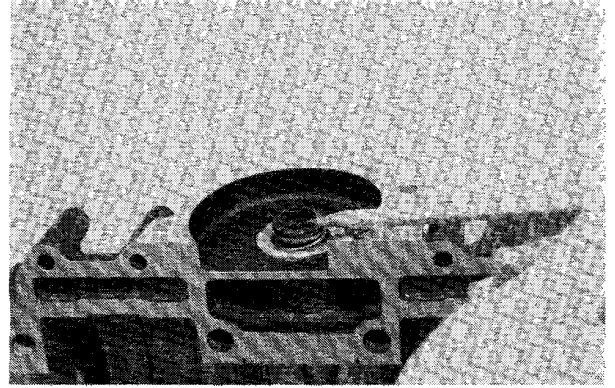


AJ154

**⚠ CAUTION**

After the seal has been installed, closely examine the seal surface to make sure it hasn't been damaged.

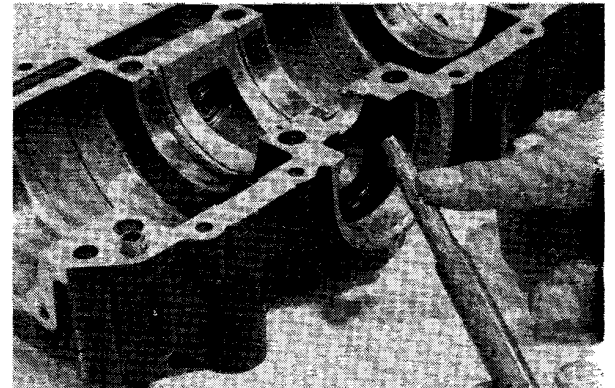
Fig. 2-75



AJ155

- Apply a light coat of grease to the smooth, machined portion of the water pump shaft; then while slowly rotating the shaft as it enters the bearing and seal area, gently push the shaft into position.

Fig. 2-76



AJ090

**⚠ CAUTION**

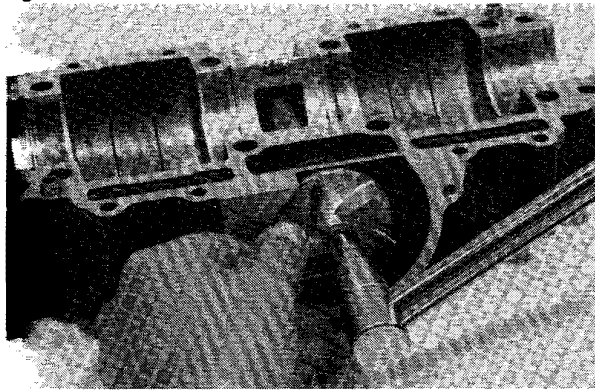
Care must be used when installing the water pump shaft or the small spring could be forced out of its position on the inner seal. Slowly push the well-greased shaft through the inner seal, slowly rotating the shaft clockwise as it enters the seal.

- Apply a coat of grease to the impeller sealing area on the backside of the impeller; then install the water pump impeller onto the shaft. Apply Red LOCTITE to the impeller bolt threads and torque to 0.8-1.0 kg-m (6-7 ft-lb).

**NOTE:** When installing the washer on the impeller bolt, the rubber side must face the impeller. If installed incorrectly, coolant will leak from the crankcase bleed hole.



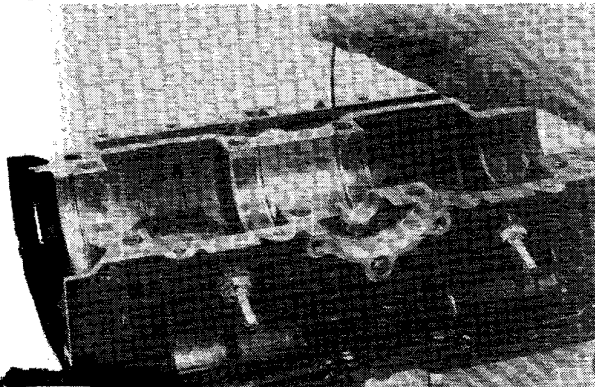
Fig. 2-77



AJ091

9. Set the top half of the crankcase upside down on the work bench with a 4 in. block of wood under each end.
10. Install the two C-rings (one for located the pinion bearing and the other to locate the crankshaft assembly) in the upper crankcase half. Install the four crankshaft bearing locating pins in the crankcase bearing areas.

Fig. 2-78



AJ095

- Using Arctco 50:1 Injection Oil, lubricate the PTO bearing and slide onto the crankshaft.

**CAUTION**

The bearing oil hole must be positioned toward the outer end of the crankcase.

12. Lubricate the inner lips of the crankshaft oil seals with grease; then slide the seals onto the crankshaft making sure the spring side of each seal faces the center of the crankcase.

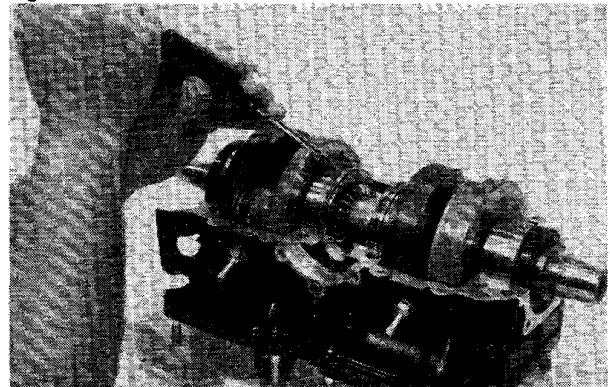
**NOTE:** There is a MAG-side seal and a PTO-side seal.

13. Apply Arctco 50:1 Injection Oil to all of the crankshaft bearings; then install the crankshaft into the upper crankcase half. Be sure the alignment hole in each bearing is positioned over its respective dowel pin in the crankcase.

**CAUTION**

Check all bearings by trying to rotate them to make sure they are being held in position by the dowel pin. Each bearing must drop onto the dowel pin. If the bearings are not properly seated during assembly, the crankcase halves will not seal tightly and engine damage will result.

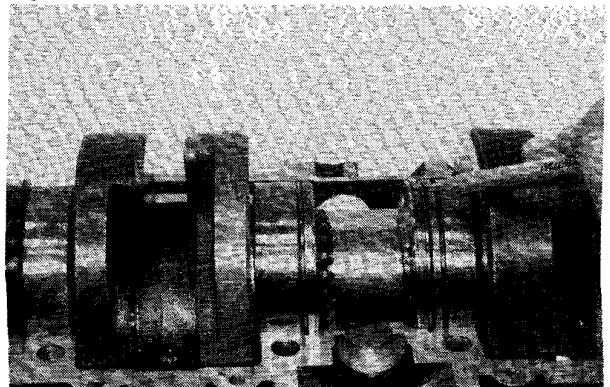
Fig. 2-79



AJ097

14. Rotate the crankshaft center-seal rings so the end-gaps of the two large rings are 180° apart, one end-gap being positioned downward and the other upward. Seat the crankshaft.

Fig. 2-80



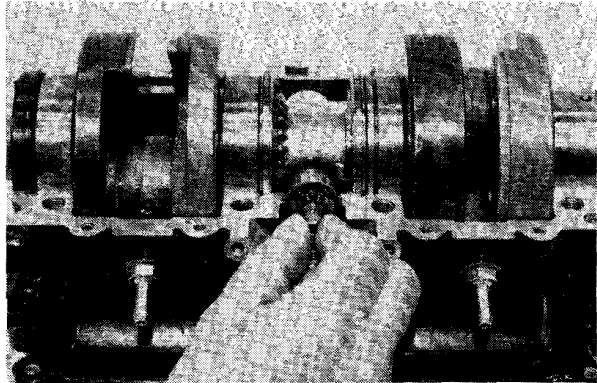
AJ098

**NOTE:** If a new pinion gear or crankshaft was installed, see the Shimming Pinion Gear section of this manual. Otherwise proceed to step 15.



15. Install the shim washer(s) on the pinion shaft and set the pinion assembly into position in the top half of the crankcase. Be sure the pinion bearing is seated over its C-ring. Lubricate both the pinion and crankshaft gears using a generous amount of Arctco 50:1 Injection Oil.

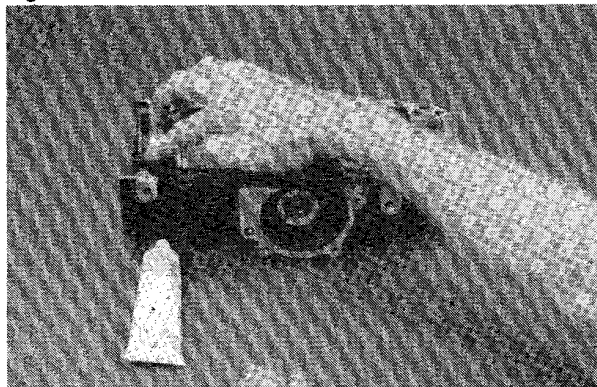
Fig. 2-81



AJ099

16. Apply a thin coat of High Temperature Silicone Sealant (p/n 0636-069) to the lower crankcase sealing surfaces.

Fig. 2-82



AQ126

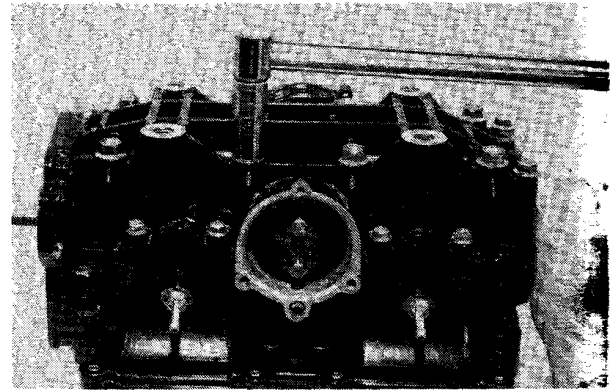
**CAUTION**

Check to make sure the two crankcase half locating dowel pins are in position at opposite corners of the lower case half.

17. Assemble the crankcase halves, making sure that the pinion gear and water pump gear mesh properly.

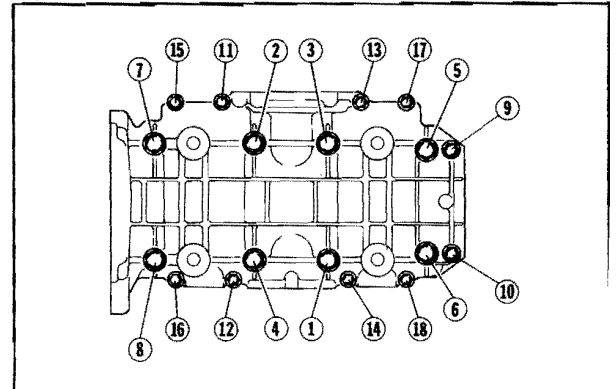
18. Install the 18 crankcase cap screws securing the crankcase halves. Make sure the cap screws are in the proper holes. Tighten the cap screws in three steps using the pattern shown: tighten the 10 mm cap screws to 4.0-6.0 kg-m (29-43 ft-lb), the 8 mm cap screws to 1.8-2.8 kg-m (13-20 ft-lb), and the 6 mm cap screws to 0.8-1.2 kg-m (6-9 ft-lb).

Fig. 2-83



AJ101

Fig. 2-84

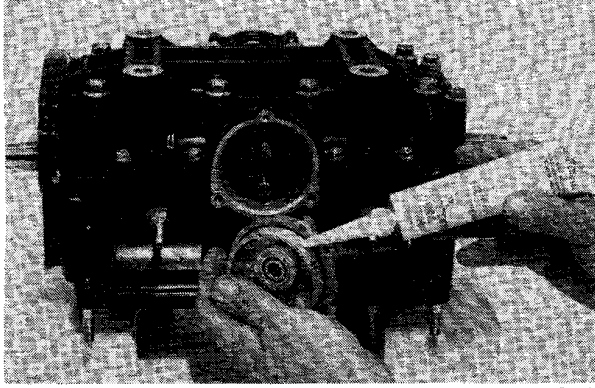


0727-09

**NOTE: Secure the connecting rods with rubber bands to the cylinder studs.**

19. Install the O-ring on the oil-injection pump retainer. Apply a thin coat of silicone sealer (p/n 0636-069) over the top of the O-ring. Apply a small amount of Arctco 50:1 Injection Oil to each of the bearings in the retainer and rotate them by hand to spread the oil.

Fig. 2-85

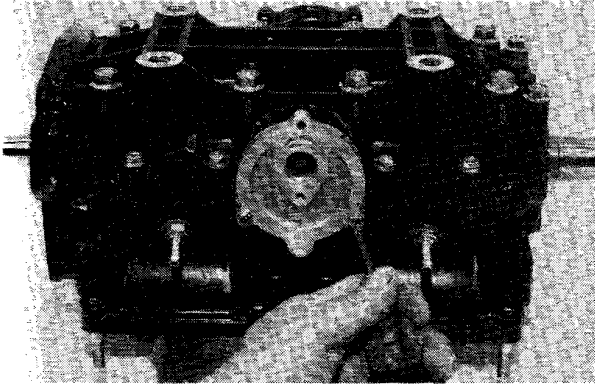


AJ105

**NOTE:** Before installing the oil-injection pump retainer, check the pinion gear backlash (see Shimming Pinion Gear section).

20. Install the oil-injection pump retainer being careful to align the pinion and water pump shafts with their respective bearings. Press the retainer onto its dowel pin located in the top half of the crankcase. Install the two screws and torque to 0.8-1.2 kg-m (6-9 ft-lb). Tighten the two screws evenly.

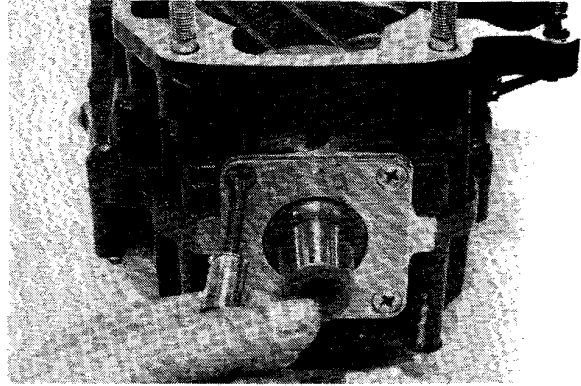
Fig. 2-86



AJ106

21. Place the end plate into position on the crankcase; then apply LOCTITE LOCK N' SEAL to the four screws and tighten securely.

Fig. 2-87



AJ103

**CAUTION**

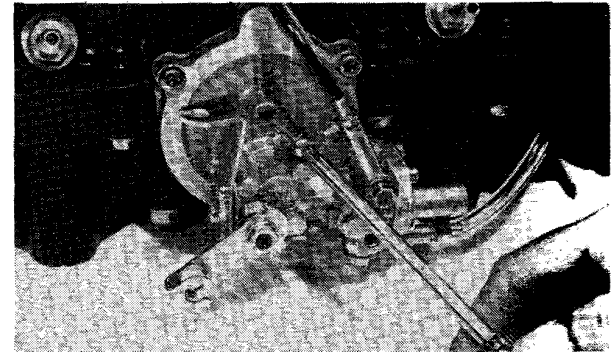
Make sure the slot of the oil-injection pump shaft is aligned with the shaft in the crankcase before installing the two oil pump mounting screws. If not aligned, the oil pump mounting flange will crack when the screws are tightened.

22. Apply a thin coat of silicone sealer (p/n 0636-069) to both sides of the oil pump gasket. Install the gasket and oil-injection pump. Secure with two screws and washers. Tighten the two screws to 0.7 kg-m (5 ft-lb).

**CAUTION**

The shorter screw must be installed in the top mounting hole or bearing damage will result.

Fig. 2-88



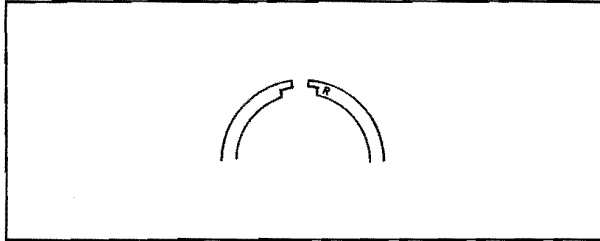
AJ107

23. Install the piston rings on each piston so the letter on the top or inclined surface of each ring faces the dome of the piston.

2



Fig. 2-89



0726-306

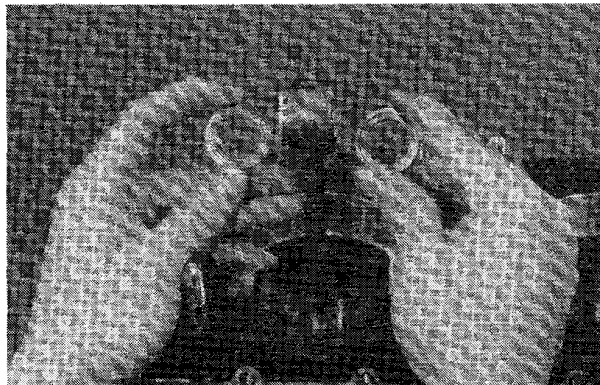
**⚠ CAUTION**

Incorrect installation of the piston rings will result in engine damage.

24. Apply oil to the connecting-rod small end bearings; then install the small-end bearings and thrust washers.

**NOTE:** The indented side of the thrust washer must face the bearing.

Fig. 2-90



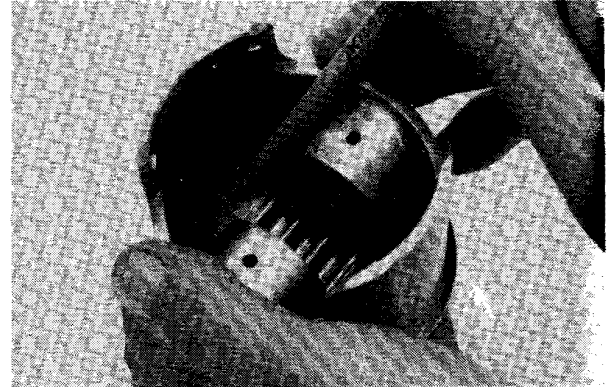
AQ059

25. Place each piston over the connecting rod so the arrow on each piston will point toward the exhaust port; then secure with a piston pin.

**⚠ CAUTION**

The arrow on each piston must face toward the cylinder exhaust port or both the cylinder and piston will be severely damaged.

Fig. 2-91

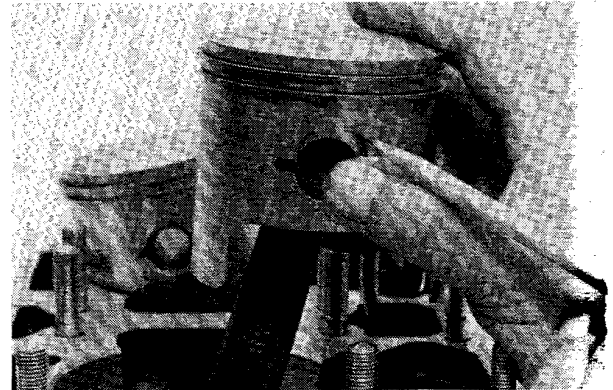


AJ109

**NOTE:** The arrow is found up inside the piston or on the piston dome.

26. Install the circlips so the open end is directed either down or up. Remove the rubber bands from the connecting rods.

Fig. 2-92



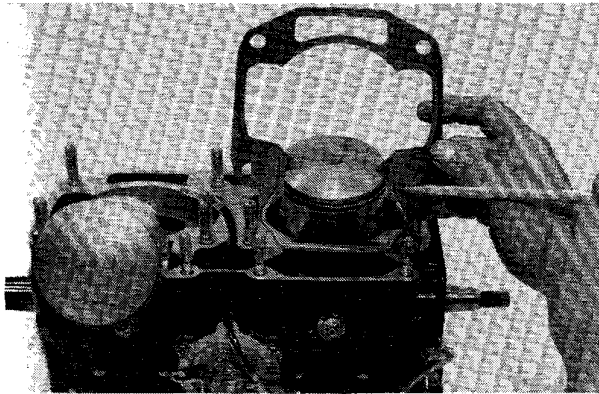
AJ110

**⚠ CAUTION**

Make sure circlips are firmly seated and the open end is directed either down or up before continuing with assembly.

27. If the gaskets are being reused, apply a thin coat of Copper Coat Gasket Sealant (p/n 0636-092) to both sides of each cylinder-base gasket. If using new gaskets, it isn't necessary to apply copper coat. Install the gasket with the raised portion of the gasket positioned upward.

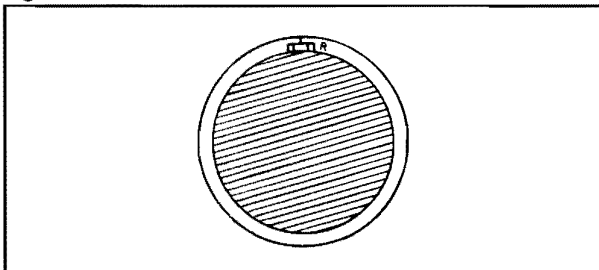
Fig. 2-93



AJ111

28. Rotate each piston ring until the ring ends are properly positioned on either side of the ring keeper; then apply oil to the piston assemblies and cylinder bores.

Fig. 2-94

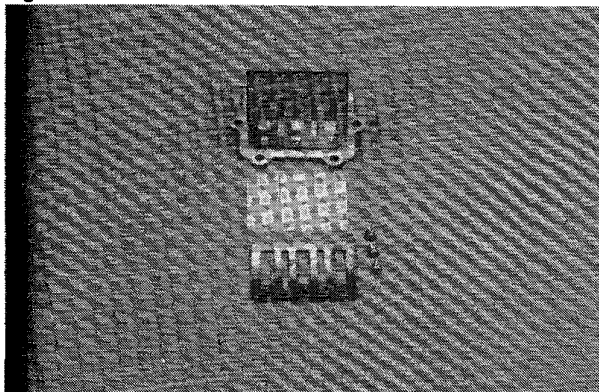


0726-306

**NOTE:** If the reed seats were removed, place each seat with new gasket into position on the cylinder, apply **LOCTITE LOCK N' SEAL** to the screws and tighten securely.

29. Place the reed valve (with the beveled corner positioned toward the lower right-hand corner) and stopper into position on the seat; then apply **LOCTITE LOCK N' SEAL** to the screws and tighten securely.

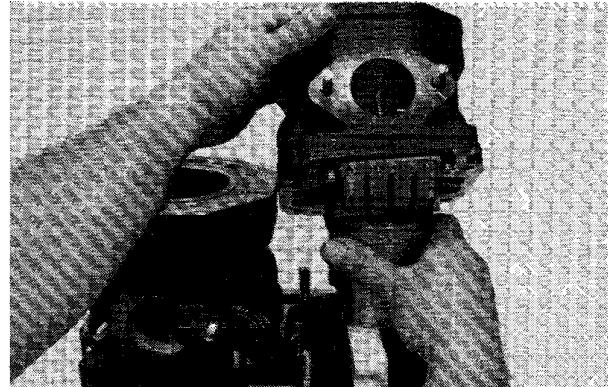
Fig. 2-95



AQ087

30. In turn on each cylinder, place a piston holder (or suitable substitute) beneath the piston skirt and square the piston with respect to the crankcase; then using a ring compressor or the fingers, compress the rings and slide the cylinder over the piston. Remove the piston holder and seat the cylinder firmly onto the crankcase.

Fig. 2-96



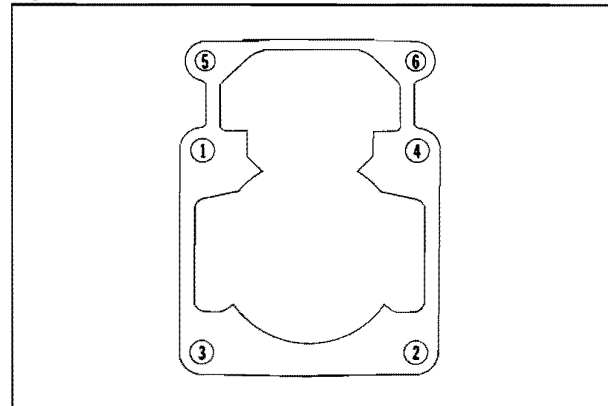
AJ112

**CAUTION**

When installing the cylinders, care must be taken not to bend or damage the reed stopper.

31. Secure each cylinder by installing the six nuts, four washers, and lock washers. Torque the 8 mm cylinder base nuts to 1.8-2.8 kg-m (13-20 ft-lb) and the 10 mm nuts to 4.0-6.0 kg-m (29-43.5 ft-lb). Torque all the nuts in three steps using the pattern shown.

Fig. 2-97

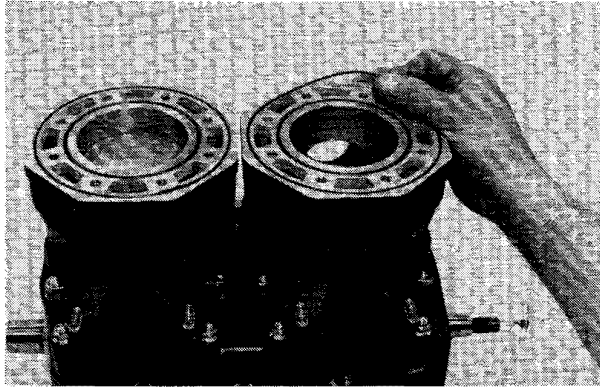


0727-551

32. Place the O-rings into position on the top of each cylinder.



Fig. 2-98

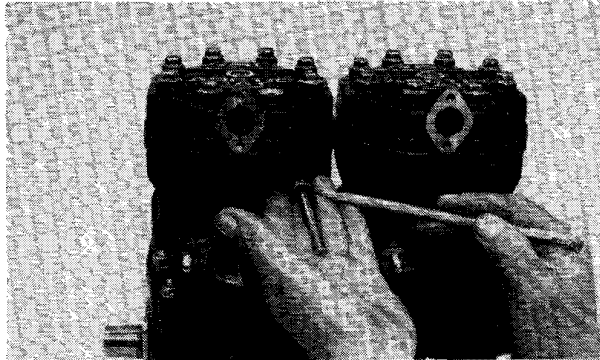


AJ118

**NOTE:** If reusing O-rings and they are slightly stretched, shrink them by cooling (in a refrigerator or in the snow) for a short period of time.

33. Set the cylinder heads in position. Check sealing surface first to make sure the surface is clean. Slide an O-ring onto each of the 16 cap screws and start all the head cap screws. **DO NOT TIGHTEN AT THIS TIME.**

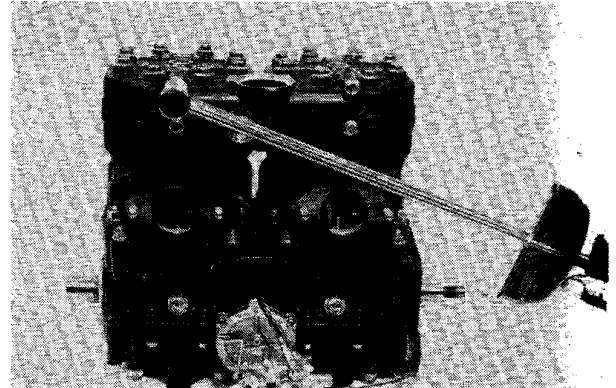
Fig. 2-99



AJ119

34. Apply a thin coat of silicone sealer (p/n 0636-069) to the two thermostat manifold gaskets. Place the gaskets and housing into position and secure with four cap screws and washers. Torque the four cap screws in a crisscross pattern to 0.7-1.0 kg-m (5-7 ft-lb).

Fig. 2-100

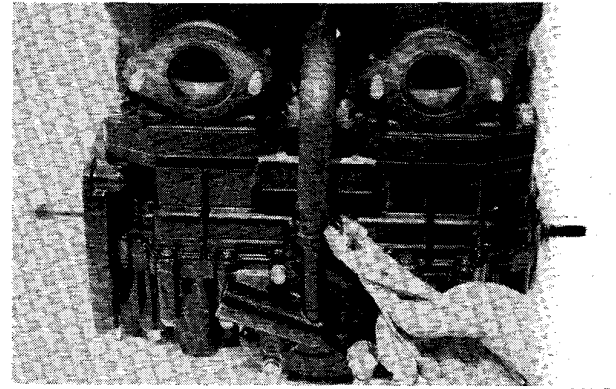


AJ120

**NOTE:** The thermostat manifold cap screws must be torqued before tightening the head cap screws. This will allow the gasket surfaces of the head to align with the housing and prevent any coolant leakage.

35. Slide the bypass hose between the cylinders and onto the water-pump cover. Secure with clamp.

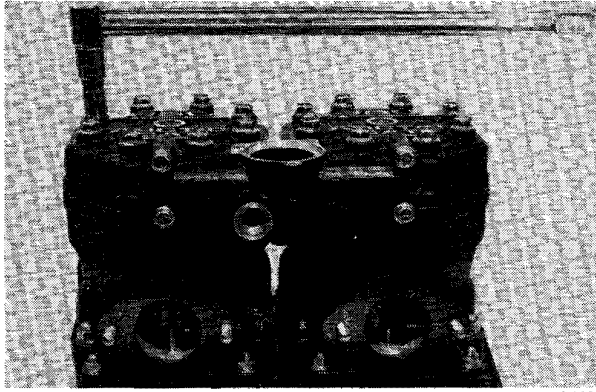
Fig. 2-101



AJ117

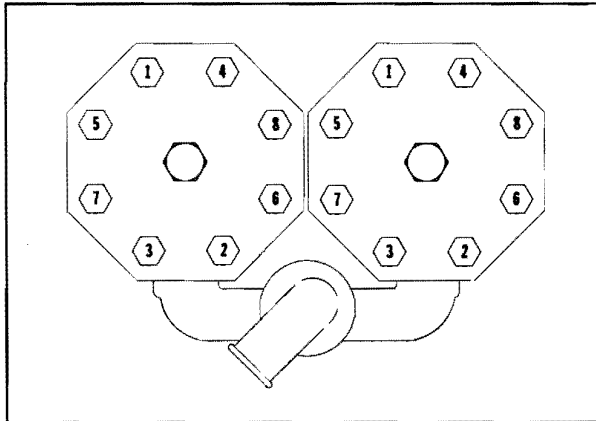
36. Torque the head cap screws in three steps to 1.8-2.8 kg-m (13-20 ft-lb) using the pattern shown.

Fig. 2-102



AJ121

Fig. 2-103



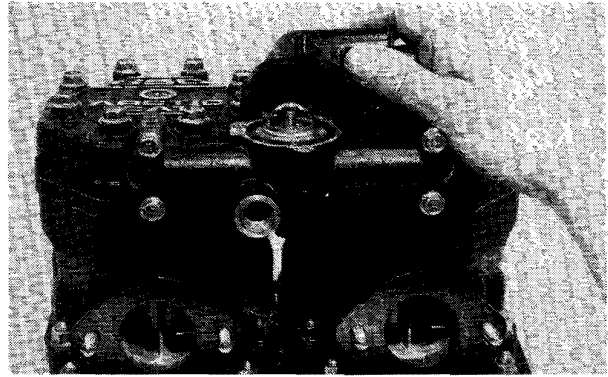
0727-158

37. Install the two intake flanges and balance tubes. Secure with washers and nuts. Install the oil-injection hose on each cylinder nozzle and secure with a hose clamp.

Test the engine for air leaks (see Pressure Testing Engine section).

39. Place the thermostat with gasket and cap into position. Secure with three cap screws. Torque to 0.7-1.0 kg-m (5-7 ft-lb).

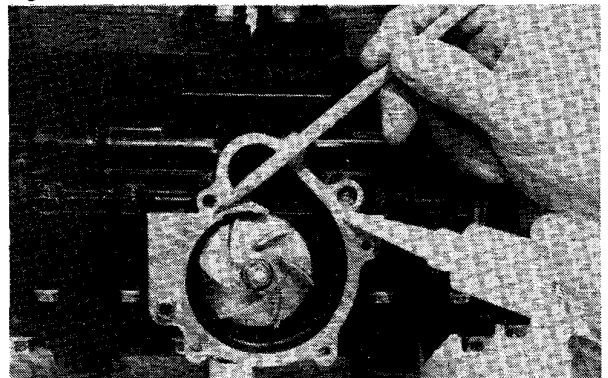
Fig. 2-104



AJ123

40. Apply a thin coat of silicone sealer to the crankcase water pump housing sealing surface.

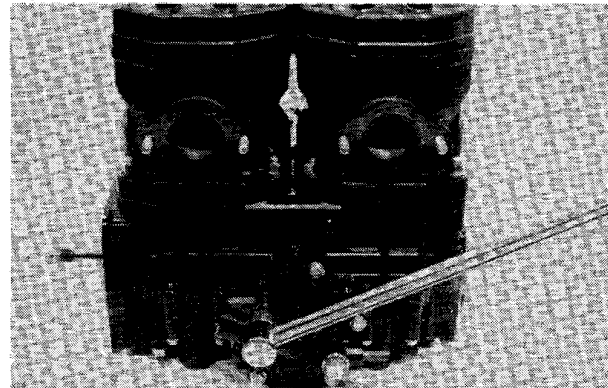
Fig. 2-105



AJ115

41. Apply a thin coat of silicone sealer (p/n 0636-069) to the water-pump cover seal and position the O-ring into the cover. Carefully place the cover over the impeller and onto the crankcase. Secure with five cap screws. Tighten cap screws evenly and torque to 0.7-1.0 kg-m (5-7 ft-lb).

Fig. 2-106

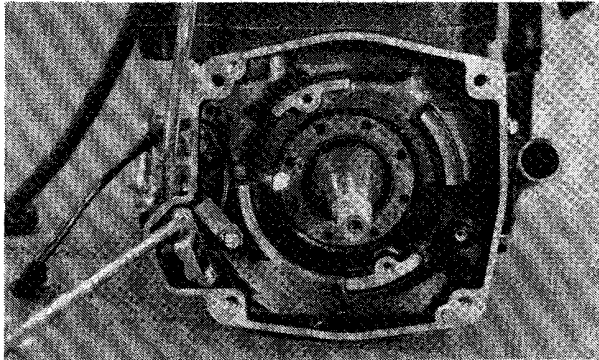


AJ116



42. Install the intake flanges with balance hoses. Secure with four washers and nuts. Torque to 1.8-2.2 kg-m (13-16 ft-lb).
43. Route the RPM-sensor wire through the magneto backing plate; then secure the sensor and its bracket using two cap screws. Position the sensor wire under the clamp and tighten the clamp screw.

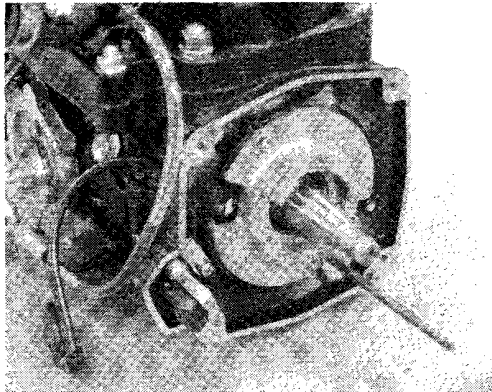
Fig. 2-107



AO001

44. Place the stator backing plate into position and secure with two screws coated with LOCTITE LOCK N' SEAL.

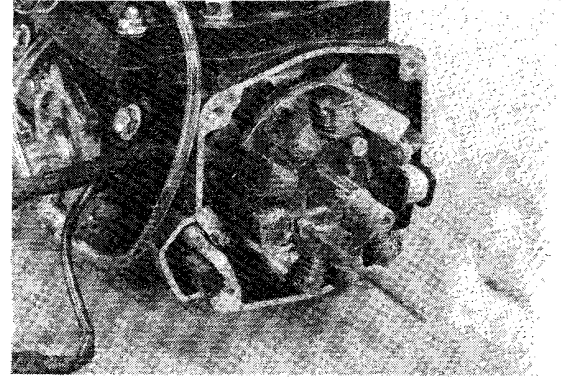
Fig. 2-108



AO004

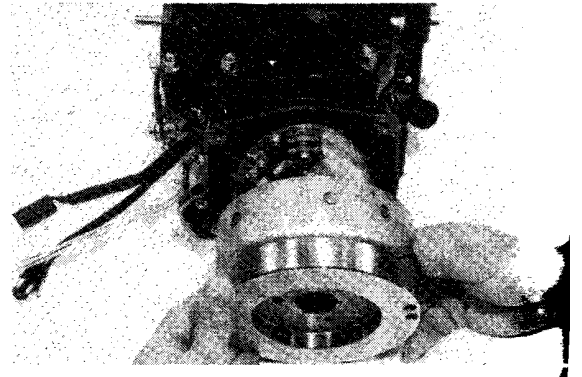
45. Route the coil ring wiring harness through the magneto backing plate and install the rubber grommet around the harness. Place the coil ring into position and secure with three screws coated with LOCTITE LOCK N' SEAL.

Fig. 2-109



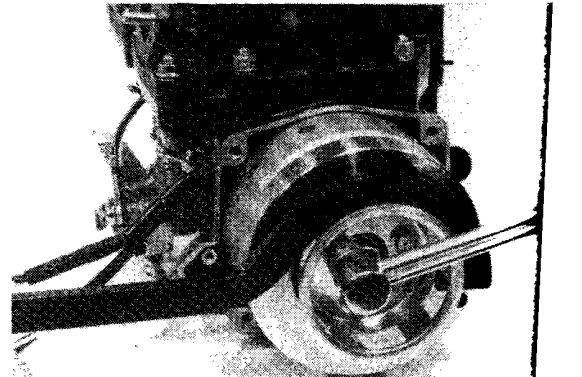
46. Install the key in the crankshaft and slide flywheel onto the crankshaft making sure keyways align.

Fig. 2-110



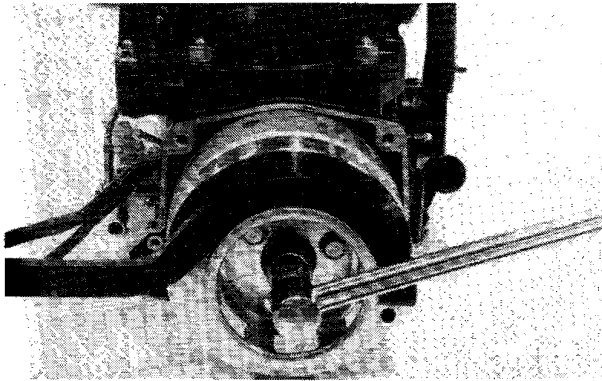
47. Apply LOCTITE LOCK N' SEAL to the crankshaft threads; then install the flat washer, washer, and nut securing the flywheel. Tighten nut finger-tight only.
48. Place the starter pulley into position on the flywheel and secure with three cap screws coated with LOCTITE LOCK N' SEAL. Torque the cap screws evenly to 1.8-2.2 kg-m (13-16 ft-lb).

Fig. 2-111



49. Using a spanner wrench and a torque wrench, torque the flywheel nut to 7.0-9.0 kg-m (50-65 ft-lb).

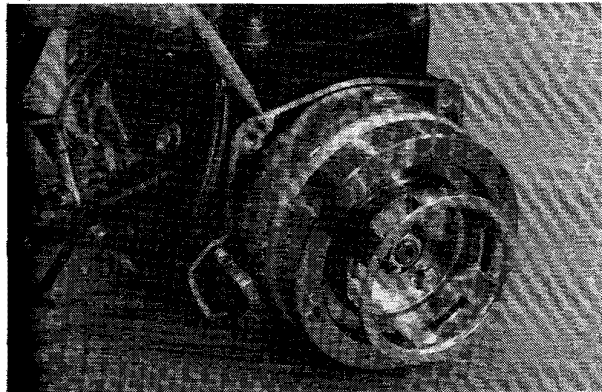
Fig. 2-112



AJ131

50. Place the two alignment dowl pins into position.

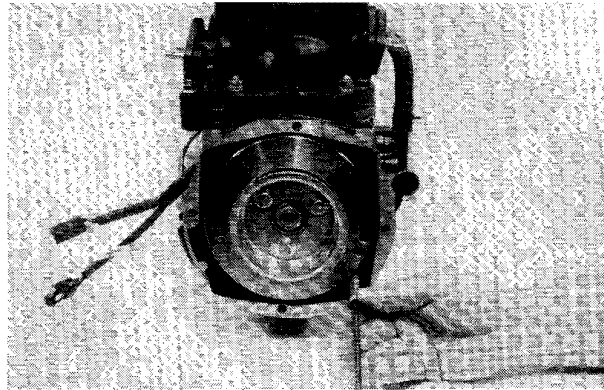
Fig. 2-113



A0016

51. Rotate the flywheel so one of its outer magnets is positioned in line with the RPM sensor coil; then place the magneto-case cover into position and secure with four bolts coated with LOCTITE LOCK N' SEAL. Torque to 1.8-2.2 kg-m (13-16 ft-lb).
52. Place the magneto-case cover into position and secure with four socket-head cap screws coated with LOCTITE LOCK N' SEAL. Torque to 1.8-2.2 kg-m (13-16 ft-lb).

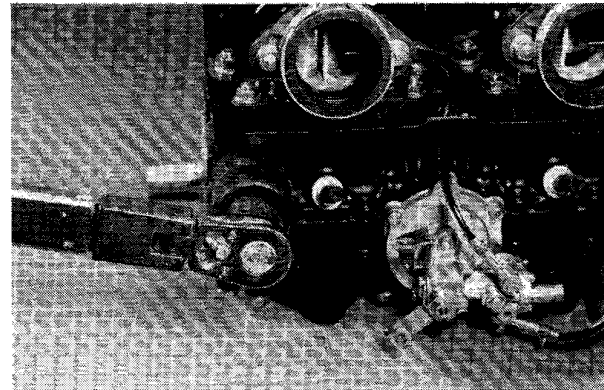
Fig. 2-114



AJ132

53. Place the front and right rear mounting brackets into position on the crankcase. Secure with cap screws coated with LOCTITE LOCK N' SEAL; then torque the cap screws to 2.4 kg-m (17 ft-lb).
54. Secure the rear PTO-side motor mount to the crankcase. Torque to 1.4 kg-m (10 ft-lb).

Fig. 2-115



AN134

## SHIMMING PINION GEAR

### CAUTION

If either the crankshaft or pinion gear assembly has been replaced, pinion gear backlash must be checked.

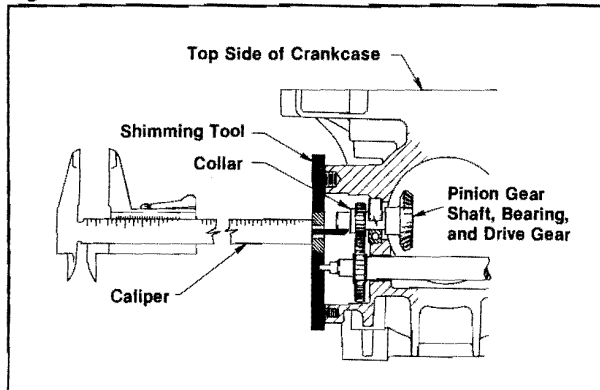
**NOTE:** In order to check pinion gear backlash, a caliper and the Pinion Shimming Tool (p/n 0644-055) must be used.

1. Place the Pinion shimming Tool against the Oil-injection pump retainer sealing surface. The center hole of the tool must be positioned just to one side of the pinion shaft.



2. Insert the measuring beam of the caliper through the hole of the tool and up against the shoulder of the pinion gear.

Fig. 2-116



0727-556

3. While holding the tool tight against the crankcase, take a reading from the caliper. Compare the reading to the following chart and select the appropriate shim or shims as required.

**NOTE:** If the required shim thickness is between 2.0 and 3.0 mm, use two of the shims to obtain the correct shimming thickness.

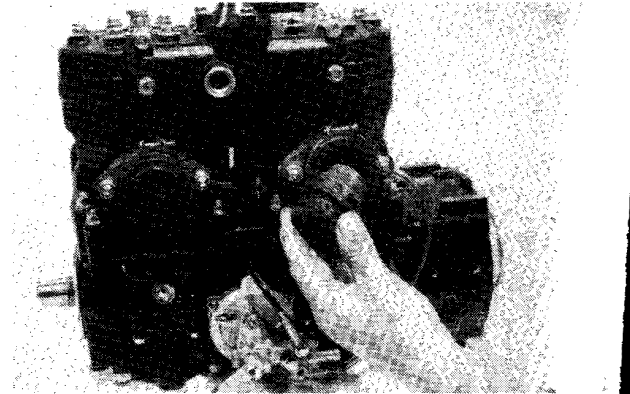
CALIPER READING	SHIM THICKNESS	CALIPER READING	SHIM THICKNESS
21.51 - 21.6	1.0	22.61 - 22.7	2.1
21.61 - 21.7	1.1	22.71 - 22.8	2.2
21.71 - 21.8	1.2	22.81 - 22.9	2.3
21.81 - 21.9	1.3	22.91 - 23.0	2.4
21.91 - 22.0	1.4	23.01 - 23.1	2.5
22.01 - 22.1	1.5	23.11 - 23.2	2.6
22.11 - 22.2	1.6	23.21 - 23.3	2.7
22.21 - 22.3	1.7	23.31 - 23.4	2.8
22.31 - 22.4	1.8	23.41 - 23.5	2.9
22.41 - 22.5	1.9	23.51 - 23.6	3.0
22.51 - 22.6	2.0		

## Pressure Testing Engine

1. Test the engine for air leaks using the following procedure and an Arctco Pressure Testing Kit (p/n 0144-127):

- a. Install two intake-flange port plugs and tighten the flange clamps securely.

Fig. 2-117



- b. Place a rubber plug and cover on each exhaust port and secure.
- c. Remove one of the plugs in the crankcase and install an impulse fitting. Connect the pressure tester to the impulse fitting. Pressurize the crankcase to 8 psi and close the valve.

### CAUTION

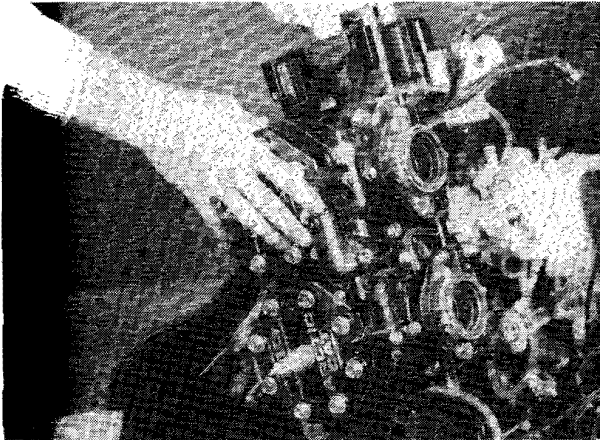
**DO NOT** exceed 8 psi pressure or damage to the seals will result.

- d. Monitor the pressure gauge. Pressure must not drop at a rate of more than 1 psi per minute.
- e. If the pressure drops faster than specified, inspect for an air leak with soapy water. Completely submerge the pressurized engine in clean fresh water. Repair as needed.
- f. Remove the impulse fitting. Apply **LOCTITE** to the threads of the plug and install. Tighten securely.

## Installing Engine

1. Place the engine assembly into position in the engine compartment and secure the engine to the front end assembly. Torque the mounting cap screws to 4.2 kg-m (30 ft-lb). Be sure to position the shims on the left rear mount in the same order as noted when removing engine.

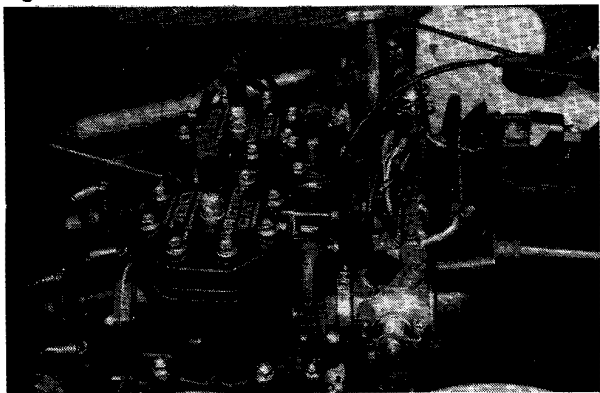
Fig. 2-118



AJ017

2. Connect the oil-supply hose to the oil-injection pump and secure with the clamp. Connect the oil-injection cable to the injection pump arm; then secure with a plastic washer and E-clip. Bleed the oil-injection system (see Bleeding Oil-Injection System section).
3. Place the hose into position on the water pump and secure with the clamp.
4. Place the coolant hose into position on the thermostat housing and secure with the clamp.

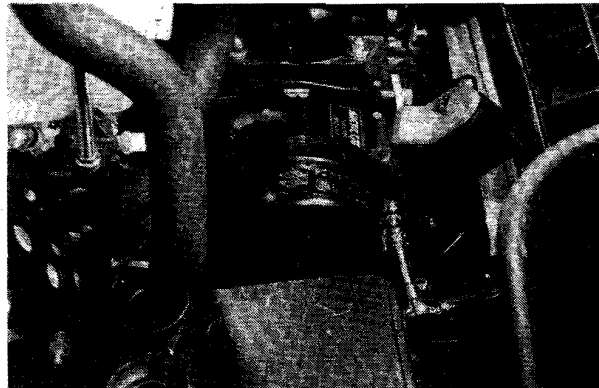
Fig. 2-119



AO065

5. If removed, apply teflon tape to the threads of the heat gauge sensor; then thread the heat gauge sensor into the thermostat manifold. Tighten securely. Connect the wire of the temperature warning light to the sensor.
6. Place the throttle body into position and secure with the flange clamps. Be sure each boot is properly positioned and not folded into the throttle body. Synchronize the oil-injection pump (see Synchronizing Oil-injection Pump section).
7. Connect the main wiring harness, ECU temperature sensor wire, temperature warning light sensor, CDI unit, and the spark-plug caps. Attach the timing sensor and ground wires to the magneto housing.
8. Attach the coolant hoses to the thermostat manifold and PTO-side throttle body. Secure with clamps.
9. Place the recoil into position and secure with four cap screws and lock washers. Tighten cap screws to 0.7 kg-m (5 ft-lb).

Fig. 2-120



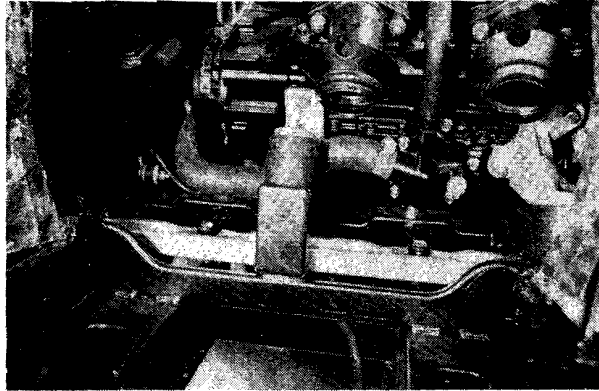
AP011

**NOTE:** The PTO header pipe is angled inward; please note before installing on cylinders.

10. Apply a thin coat of high temperature sealant (p/n 0636-069) to the gaskets; then place an exhaust gasket on each cylinder with the metal side facing the cylinder. Install the header pipes and secure with four nuts and lock washers. Torque the four nuts to 1.8-2.2 kg-m (13-16 ft-lb).



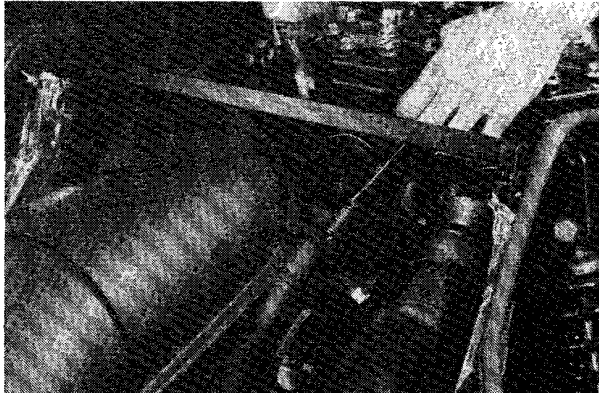
Fig. 2-121



AP014

11. Place the expansion chambers into position and secure to the header pipes and resonator with ten springs. Secure each expansion chamber to the front end with a spring.

Fig. 2-122



AJ161

12. Place the drive clutch into position (making sure the sleeves are properly positioned) on the crankshaft and secure with the cap screw and lock washer. Tighten to 6.9-7.6 kg-m (50-55 ft-lb).
13. Install the driven pulley, washers and key. Secure with large flat washer and cap screw. Torque the cap screw to 2.6-3.3 kg-m (19-24 ft-lb).

**NOTE:** Before installing the driven pulley, apply a small amount of Anti-Seize or a good low-temperature grease to the shaft to aid in future removal of the driven pulley.

14. Check drive clutch/driven pulley alignment.
15. Install the drive belt (so the part number can be read); then check drive belt deflection.
16. Install the clutch shield and secure with two cap screws and lock nuts.

17. Fill the cooling system (see Filling Cooling System).

### CAUTION

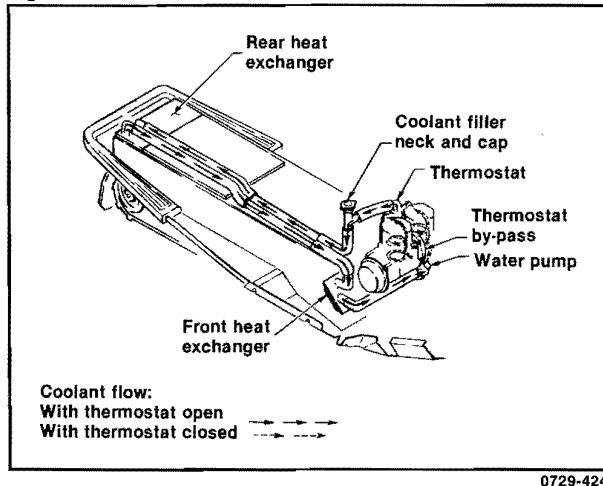
If the engine had a major overhaul or if any major part was replaced, proper engine break-in procedures must be followed. If proper engine break-in procedures are not followed, severe engine damage may result.

18. Install the hood and secure with the two hood hinge pins. Attach the hood cable to the engine and connect the headlight wiring harness.
19. Attach the negative battery cable to the negative terminal on the battery.
20. Check ignition timing.
21. Test drive the snowmobile for five minutes at 1/4 throttle. Stop the snowmobile and check the coolant level. Check for any coolant, gas, or oil leakage. Torque the drive clutch to 6.9-7.6 kg-m (50-55 ft-lb). Apply Red LOCTITE to the retainer plug; then install the retainer plug and washer. Torque to 6.9-7.6 kg-m (50-55 ft-lb).

## Liquid Cooling System

The liquid cooling system consists of a water pump, thermostat, thermostat by-pass, and two heat exchangers. The system should be inspected for leaks or damage whenever an overheating problem is experienced.

Fig. 2-123



### FILLING COOLING SYSTEM

#### CAUTION

When filling the cooling system, be sure to take extra time to eliminate any trapped air.

1. Elevate the front of the snowmobile 15-20 cm (6-8 in.).
2. Remove the three cap screws from the thermostat housing; then remove the thermostat.
3. Remove the filler cap to vent the system.
4. Pour properly-mixed coolant into the system through the thermostat manifold. Keep filling the system until coolant reaches the thermostat opening.
5. Install the thermostat and thermostat cap; tighten securely.

6. Finish filling the cooling system by pouring coolant in the filler spout. The system is full when coolant reaches the top of the filler neck. The cooling system holds 3.3 l (3.5 U.S. qt).
7. Remove the green cap from the coolant holding tank and fill the tank 3/4 full of coolant.
8. Test ride the snowmobile 5 to 6 minutes and recheck the coolant level.

### INSPECTING THERMOSTAT

1. Inspect the thermostat for corrosion, wear, or spring damage.
2. Using the following procedure, inspect the thermostat for proper operation.
  - a. Suspend the thermostat in a container filled with water.
  - b. Heat the water and monitor the temperature with a thermometer.
  - c. The thermostat should start to open at 50°C (122°F). Once the thermostat starts to open, IMMEDIATELY remove the thermostat as it will lock in the open position if allowed to open fully.

**NOTE:** The thermostat is of the lock-open type. If the thermostat is ever allowed to fully open, it will remain open and replacement of the thermostat will be necessary.

### INSPECTING COOLANT HOSES AND CLAMPS

All coolant hoses and connections should be checked annually for deterioration, cracks, and wear.

All coolant hoses and clamps should be replaced every four years or 4000 miles.



# SECTION 3 - FUEL SYSTEM

## TABLE OF CONTENTS

Introduction . . . . .	44
Individual EFI Components . . . . .	46
ECU Unit . . . . .	46
EPROM (chip) . . . . .	46
Air Temperature Sensor . . . . .	47
Water Temperature Sensor . . . . .	47
Throttle Position Sensor . . . . .	48
Crankshaft Position Sensor . . . . .	48
Timing/Injector Sensor . . . . .	49
Barometric Pressure Sensor . . . . .	49
Injectors . . . . .	49
Fuel Pressure Regulator . . . . .	50
Fuel Pump Circuit . . . . .	50
Self-Diagnostic EFI System . . . . .	50
Trouble Codes . . . . .	51
Troubleshooting Individual Components . . . . .	51
ECU . . . . .	52
Testing Individual Components . . . . .	54
Throttle Position Sensor . . . . .	54
Injectors . . . . .	56
Crankshaft Position Sensor . . . . .	57
Ignition Timing Sensor . . . . .	58
Fuse Link . . . . .	59
Electric Fuel Pump . . . . .	60
Fuel Pressure Regulator . . . . .	63
EFI Relay - Fuel Pump Relay - Dropping Resistor . . . . .	63
Fuel Pump Relay . . . . .	64
EFI Relay . . . . .	65
Dropping Resistor . . . . .	66
Water Temperature Sensor . . . . .	67
Air Temperature Sensor . . . . .	68
Arctco EFI Analyzer . . . . .	69
Recommended EFI Troubleshooting Sequence . . . . .	70
Testing Individual EFI Components . . . . .	71
TPS (Throttle Position Sensor) Replacement Procedure . . . . .	79
Throttle Body Flange . . . . .	80
Throttle Body . . . . .	81
Throttle Cable . . . . .	82
Removing Oil-Injection Pump . . . . .	82
Installing Oil-Injection Pump . . . . .	83
Synchronizing Oil-Injection Pump . . . . .	84
Bleeding Oil-Injection System . . . . .	84
Testing Oil-Injection Pump . . . . .	85
Testing Oil-Injection Check Valves . . . . .	85
Basic EFI System Information . . . . .	86
EFI Component Resistance/Voltage Temperature Chart . . . . .	87

## Introduction

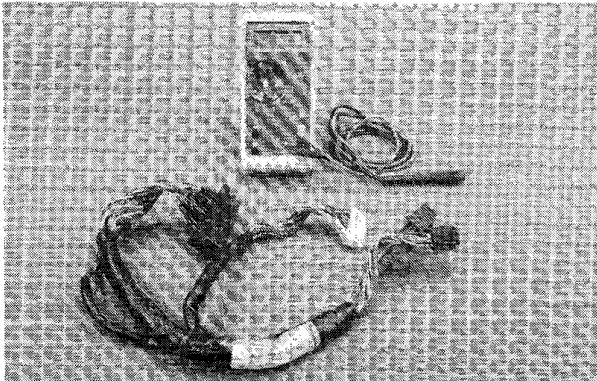
The electronic fuel injection (EFI) system used in Arctic Cat Snowmobiles is especially designed to meet the high standards of the consumer.

The EFI system is lightweight in design and is made up of a number of components which are explained in the following pages. This system will provide the operator with maximum performance and fuel efficiency in all areas of operation. The EFI system eliminates the need to change main jets to compensate for altitude and temperature changes and provides quick, easy starting under all conditions.

The electrical control unit (ECU) has a self-diagnosis mode built into the unit. It is a very valuable tool in troubleshooting. Once you determine the problem area from the trouble code flashed by the light emitting diode (LED) located on the ECU, follow the troubleshooting procedures in this manual.

Troubleshooting information is included for EFI maintenance. The special tools required are the EFI Diagnostic Test Harness (p/n 0644-181) and a digital volt/ohmmeter. Arctco recommends the Fluke Model 73 Multimeter (p/n 0644-191).

Fig. 3-1



AR001

### EFI FEATURES

1. Automatic compensation for temperature.
2. Automatic compensation for altitude.
3. Very good throttle response through high pressure injection.
4. Quick starting in every condition.

5. Improved fuel efficiency with maximum mileage in every condition.
6. Engine RPM is more stable in every area.

### PRECAUTIONS

#### WARNING

Always disconnect the negative battery cable from the battery before performing service work or testing resistance on any EFI component.

#### CAUTION

Never operate at a high speed when the battery light indicates the charging system is not working. Repair the snowmobile as soon as possible.

#### WARNING

Whenever working on the fuel system, if a fuel hose is removed from any component, slowly bleed the pressure from the hose into an absorbent towel before removing the hose from the component.

#### CAUTION

Never remove a battery cable while the engine is running.

#### CAUTION

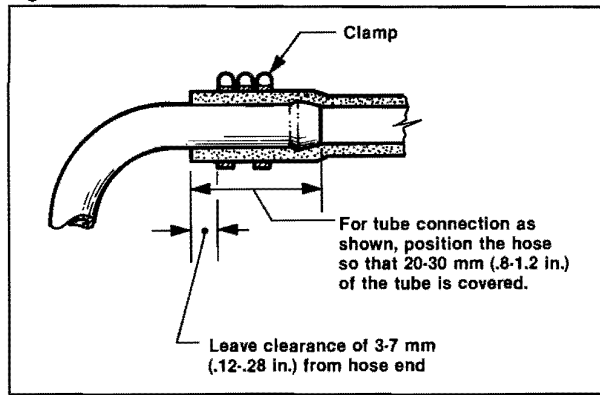
Always disconnect the battery cables from the battery, before connecting the battery charger to the battery.

#### WARNING

Always tighten fuel hose clamps securely.



Fig. 3-2



0729-325

**CAUTION**

Always use resistor-type spark plugs and spark plug caps. Non-resistor components will cause the ECU to malfunction.

## STARTING

1. To start an engine for the first time or after performing service work on the fuel system, place all safety switches in the ON position; then turn the ignition switch to the ON position. Listen for the fuel pump to start and stop. When the fuel pump stops, turn the switch to the OFF position and then to the ON position until the fuel pump completes this cycle. Repeat this procedure 4-5 times until the fuel pump has a chance to fill the system. Visually check all hose connections for any sign of leakage. Repair as necessary.
2. Start the engine without depressing the throttle. When the engine starts for the first time, do not touch the throttle. It will idle slowly and may stop. Repeat this procedure until the engine starts and builds RPM on its own. This may require 3-4 restarts. Once the engine has been started and run, the next cold start should occur in 2-3 pulls of the recoil.

## FLOODED ENGINE

If the engine should become flooded, set the parking brake, squeeze the throttle lever to the full-open position, and crank the engine over until it starts and clears itself. Release the parking brake.

## FUEL SYSTEM

The EFI fuel system consists of the following components.

- A. Fuel tank

- B. Electric fuel pump  
C. Two pick-up valves with micron screens  
D. High pressure fuel hose  
E. Fuel rail  
F. Fuel pressure regulator  
G. Throttle bodies  
H. Injectors  
I. Fuel return hose  
J. Blue fuel pump relay  
K. Green fuse link wire  
L. Dropping resistor

These components are grouped into the fuel handling system. They work together along with six electrical sensors and the ECU to provide the engine with a precise fuel mixture for combustion. The six sensors are:

1. Ignition Timing Sensor
2. Injector Timing Sensor
3. Air Temperature Sensor
4. Water Temperature Sensor
5. Throttle Position Sensor
6. Barometric Pressure Sensor

For the fuel system to function, fuel is first drawn into the electric fuel pump through two pick-up valves and hoses. The fuel is then routed through a high pressure fuel hose to the fuel rail.

The fuel pressure is maintained at 36.2 psi in the fuel rail by the fuel regulator. If pressure exceeds this amount, the regulator opens and returns excess fuel back to the fuel tank through the fuel return hose.

With the fuel pressure maintained at a constant 36.2 psi, the ECU evaluates the information it receives from the six electrical sensors and opens the injectors for precise periods of time (pulse widths) to meet engine demands.

**NOTE: The entire EFI system depends on a properly charged battery for operation.**

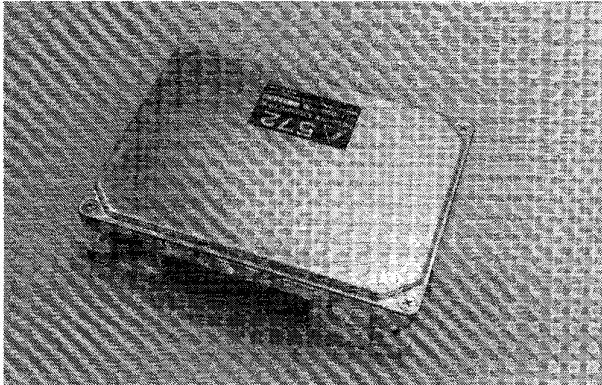
3

# Individual EFI Components

## ECU UNIT

The ECU is the brain of the EFI system. It uses six sensor inputs to determine the correct fuel/air ratio for the engine given the existing conditions of altitude and temperature.

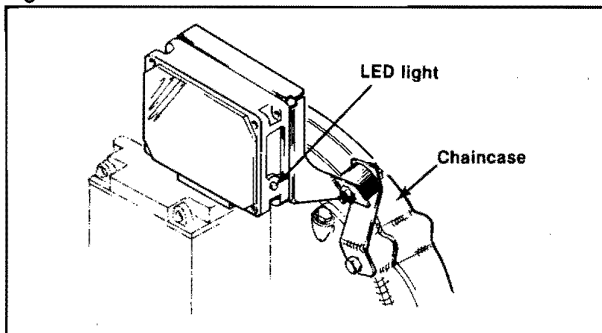
Fig. 3-3



If any of the sensors should fail while the engine is running, the ECU will sense a problem and go into a "limp home" mode. This is an over-rich condition and will greatly reduce performance. However, the engine will be protected from a possible lean condition and engine damage.

The ECU is equipped with a light emitting diode (LED) which will flash or blink a series of long and short pulses when a problem exists with any of the sensors. By observing the code, the technician can determine the problem sensor by comparing the code flashed with the trouble code chart.

Fig. 3-4



Each time the key is turned on, the LED will provide one quick flash, which indicates the system is working correctly.

There are no repairs that can be made to the ECU other than replacement of the EPROM (chip).

The ECU circuit is protected by the brown fusible link wire located next to the battery and the brown EFI relay located on the backside of the ECU mounting bracket. If the ECU is not receiving current, both these components must be tested.

Fig. 3-5

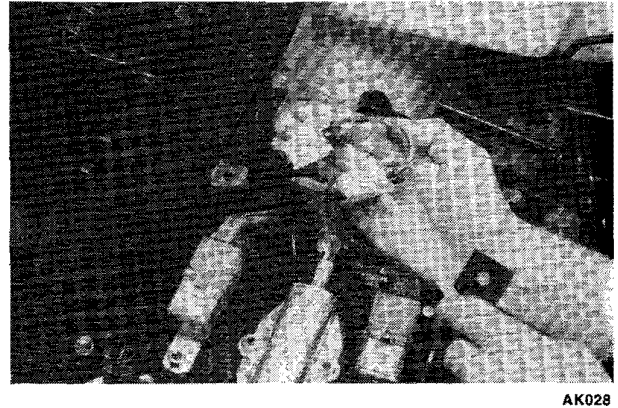
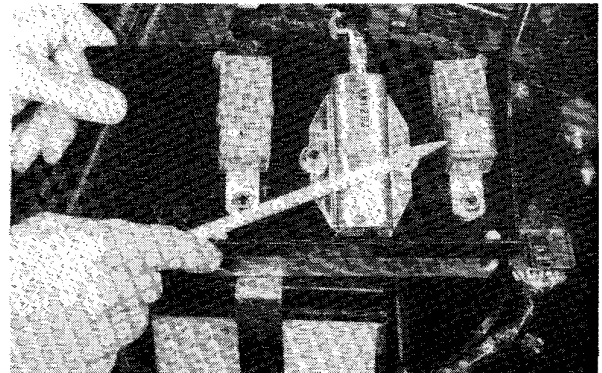


Fig. 3-6



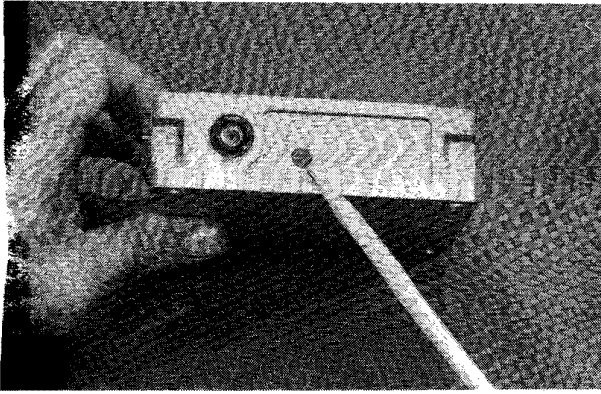
To test these components see Testing Fuse Link and EFI Relay Test sections.

## EPROM (chip)

The EPROM (chip) is located inside the ECU. When replacing the chip you must replace the chip with the same color dot (red-yellow-blue) as found on the ECU.

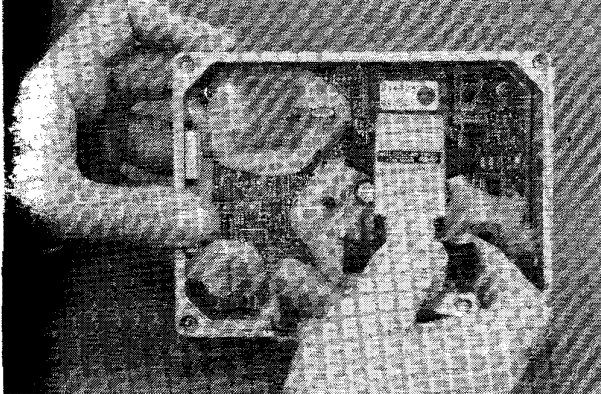


Fig. 3-7



AR024

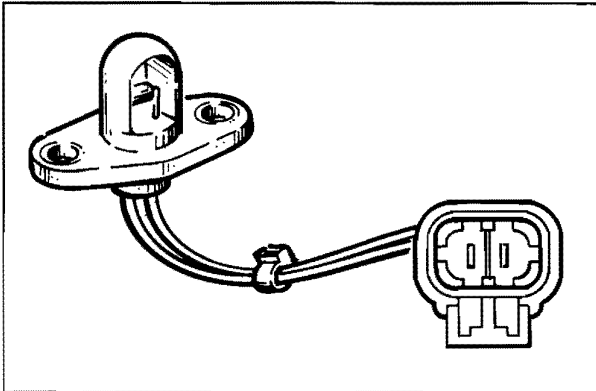
Fig. 3-8



AR027

### AIR TEMPERATURE SENSOR

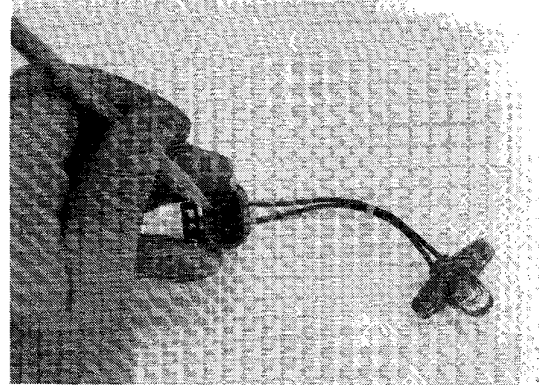
Fig. 3-9



0728-721

The air temperature sensor is mounted on the front of the air intake silencer. Its purpose is to sense the temperature of the air entering the air silencer and engine. The ECU sends current to this sensor and depending on the temperature, the sensor will pass a certain amount of current through the sensor to ground. The ECU can measure how much current passes through the sensor to ground. From this measurement the ECU determines the air temperature and calculates the fuel/air mixture ratio.

Fig. 3-10

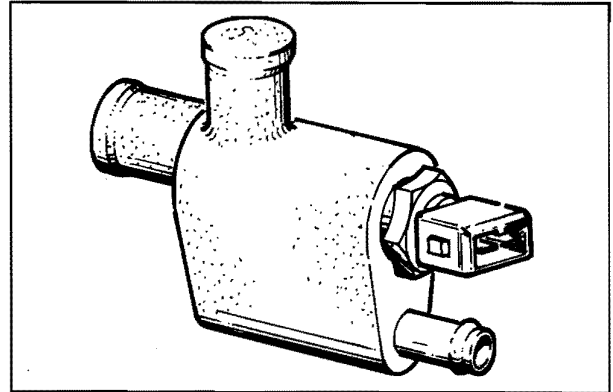


AO101

This sensor is very sensitive to temperature change. Resistance will drop as the temperature rises.

### WATER TEMPERATURE SENSOR

Fig. 3-11

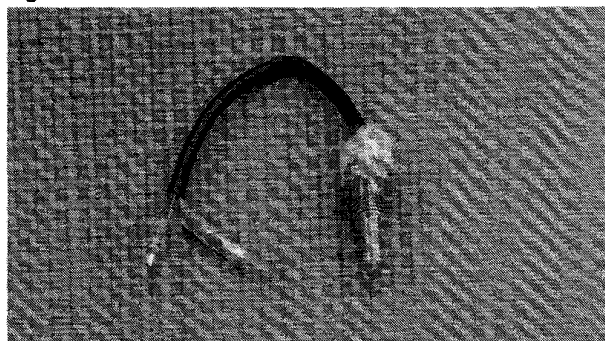


0728-726

The water temperature sensor is located under the throttle body. This sensor is very sensitive to temperature change. The ECU measures the current flow through the sensor to ground. From this measurement the ECU determines the engine temperature and calculates the fuel/air mixture ratio.

3

Fig. 3-12

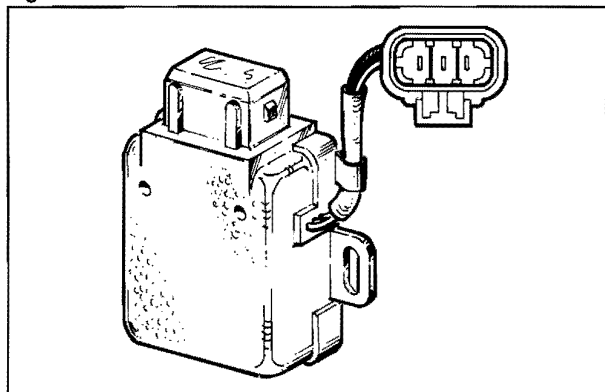


A0069

If the coolant temperature rises above 100°C (212°F), the ECU will go into a rich condition to protect the engine from over-heating.

### THROTTLE POSITION SENSOR

Fig. 3-13



0728-720

The throttle position sensor located at the end of the throttle shaft is a potentiometer, an instrument for measuring electromotive forces. This sensor transforms the throttle valve position into output voltage to the ECU. In addition, the throttle sensor detects the opening or closing speed of the throttle valve and feeds that rate of voltage change to the ECU.

Fig. 3-14

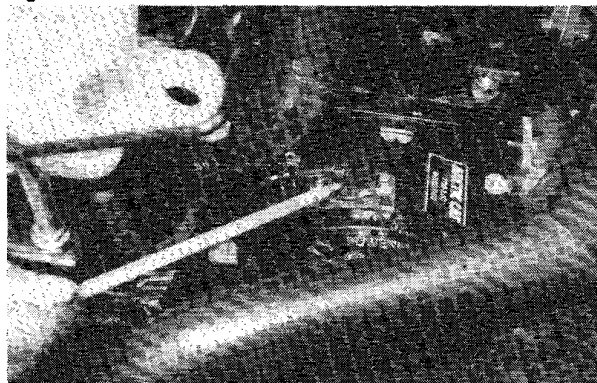


A0100

The input from the throttle position sensor is one of the main inputs for the ECU calculation of fuel/air mixture ratio.

### CRANKSHAFT POSITION SENSOR

Fig. 3-15



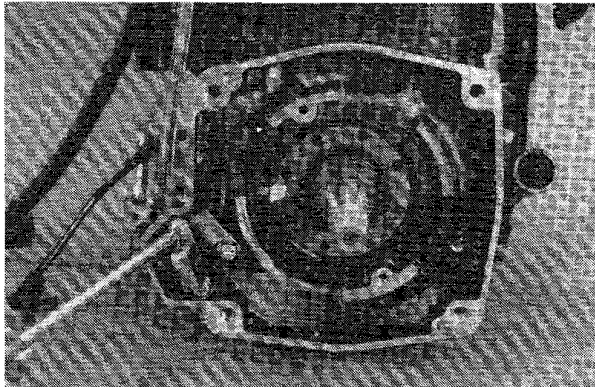
AK022

The crankshaft position sensor is located on the top of the magneto case. It is triggered by a small metal disc precisely mounted to the flywheel flange. Each time the metal disc rotates past the sensor, a signal is sent to the ECU. From this signal the ECU determines engine crankshaft position in relationship to top-dead center.



## TIMING/INJECTOR SENSOR

Fig. 3-16

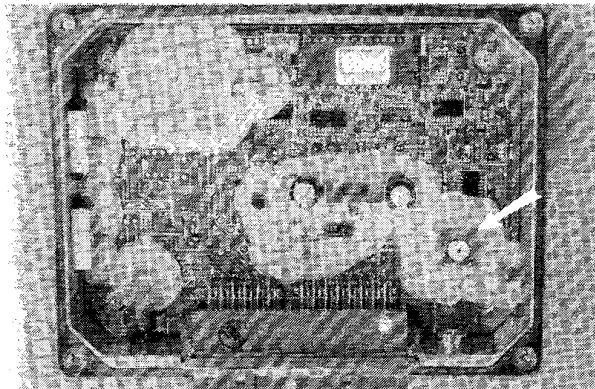


AO001

The timing/injector sensor is located inside the magneto case next to the flywheel. It is triggered by a small metal disc precisely mounted to the flywheel flange. Each time the metal disc rotates past the sensor, a signal is sent to the ECU. From this signal along with the signal from the position sensor, the ECU triggers both the ignition timing and injectors precisely at the correct time.

## BAROMETRIC PRESSURE SENSOR

Fig. 3-17



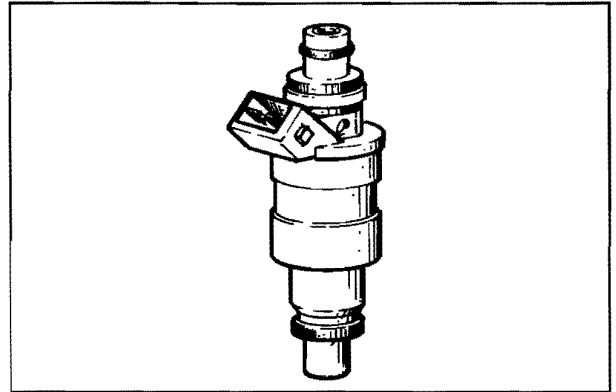
AO084

This sensor is located inside the ECU and is part of the ECU unit. Its purpose is to sense atmospheric pressure. From this information, the ECU determines the correct fuel/air mixture ratio.

This sensor is not replaceable. If it should fail, the ECU must be replaced.

## INJECTORS

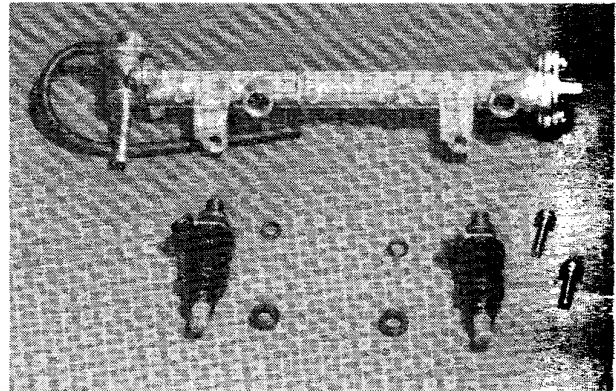
Fig. 3-18



0728-718

The injectors are positioned in the top of each throttle body. O-rings seal the top and bottom of each injector and they are held in position by the fuel rail.

Fig. 3-19



AK038

The injector is an electromagnet injection valve controlled by a signal supplied by the ECU. The coil used in the injector is a high pressure resistance type. The ECU determines the optimum fuel injection time and duration based on signals from the six sensors.

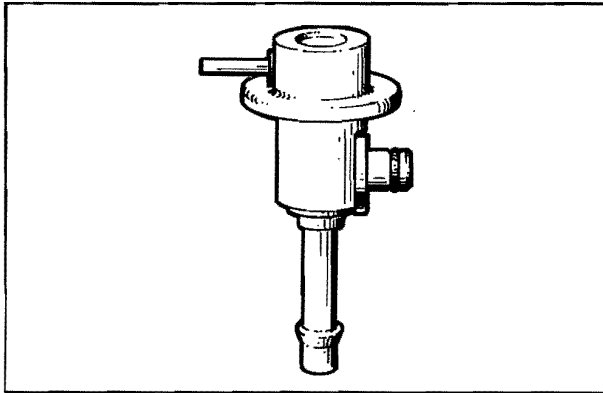
When voltage is sent to the fuel injector, it energizes the coil and opens the needle valve, thereby injecting fuel. Because the fuel pressure (pressure differential between fuel line and manifold) is kept constant, the amount of fuel injected is determined by the duration of time the valve is open.

The injectors are color coded with a yellow, red, or blue dot. When replacement of an injector is necessary, the injector must be replaced with an injector of the same color code.

It is very important that you use the correct injector as it has been matched with the EPROM (chip) used in the ECU.

## FUEL PRESSURE REGULATOR

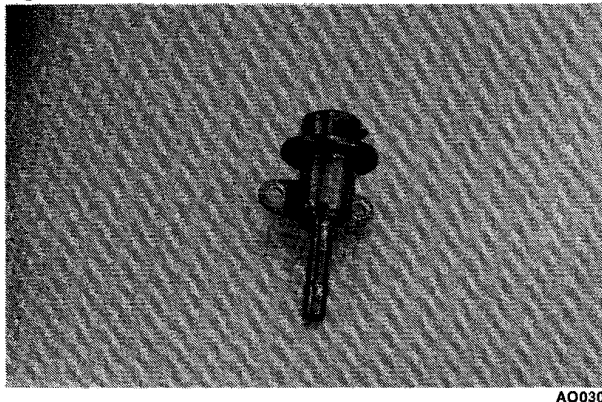
Fig. 3-20



The fuel pressure regulator is attached to the end of the fuel rail. The fuel pressure regulator maintains the fuel pressure at a constant level of 36.2 psi (2.55 kg/cm<sup>2</sup>).

When fuel pressure exceeds 36.2 psi (2.55 kg/m<sup>2</sup>), the spring-loaded diaphragm in the regulator releases allowing fuel to flow through the return hose back to the fuel tank.

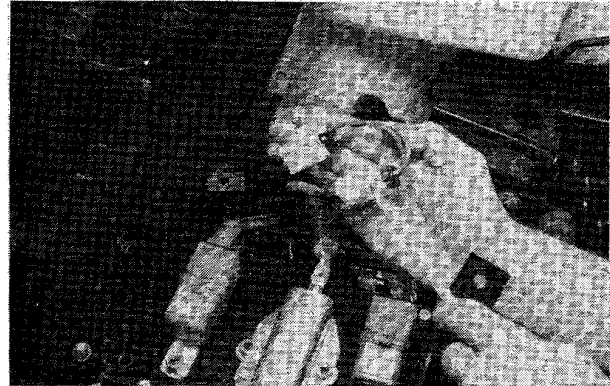
Fig. 3-21



## FUEL PUMP CIRCUIT

The fuel pump and its circuit is protected by a green fuse link wire located by the battery and secured to the backside of the footrest.

Fig. 3-22



For this circuit to function correctly, five components must be in good working order. With all switches turned ON, the fuel pump should run for a period of five seconds, then stop. This indicates normal operation.

If you do not hear the fuel pump cycle for the five second period, check the following components before considering the fuel pump assembly to be defective.

- A. Battery Condition - test battery.
- B. All switches must be ON and in good working order.
- C. Fuse link (green wire) condition - see fuse link test.
- D. Fuel pump relay (blue) - see fuel pump relay test procedure.
- E. Wiring harness and connectors - clean connectors and test harness.

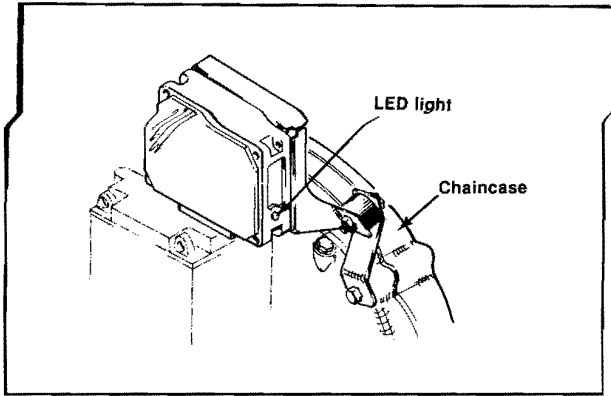
## Self-Diagnostic EFI System

### INTRODUCTION

The Electronic Control Unit (ECU) contains a built-in, self-diagnostic system, which detects trouble within the engine signal network and then flashes a code on the LED signal light, located on the left end of the unit.



Fig. 3-23



The fuel system and the ignition system remain two separate systems. In a no-start situation, you must determine if the problem is caused by lack of ignition or a fuel problem. With all switches in the ON position, you should see a single red flash on the LED of the ECU. This indicates that power is getting to the ECU and that it is working.

If you do not see a single flash, the problem may be low battery voltage, a defective ignition switch, a defective throttle sensor, a defective brown fuse link, a defective brown EFI relay, or a defective wiring harness. Proceed to individual component test procedures covered throughout this section.

The code flashed on the LED signal light will first be a long flash, followed by a series of short flashes. Count the number of long and short flashes and refer to the Trouble Codes. The code repeats itself with approximately a 2 second delay between each series of problem code flashes.

**NOTE:** When reading the LED, have paper and pencil available to write down the codes being flashed. You may see more than one code being flashed. Do NOT break the connection until you have read and recorded all codes being flashed.

Once you have determined the problem area, check the components involved using a test harness (p/n 0644-181) and the Fluke Multimeter (p/n 0644-191).

## Trouble Codes

Fig. 3-24

CODE		TROUBLE
1.		Open or short circuit in throttle position sensor.
2.		Open or short circuit in intake air temperature sensor.
3.		Open or short circuit in water temperature sensor.
4.		Open or short circuit in atmospheric pressure sensor - Located in ECU.
5.		Failure in #1 injector control circuit in ECU, or open or short circuit in #1 injector or its lead wire. Magneto side.
6.		Failure in #2 injector control circuit in ECU, or open or short circuit in #2 injector or its lead wire. P.T.O. side.
7.		Open or short circuit in the injection sensor.

0729-624

### TROUBLESHOOTING INDIVIDUAL COMPONENTS

**NOTE:** The first step in troubleshooting is to check the battery voltage. Battery voltage must be between 12.6-12.8 DC volts. If voltage is low, charge the battery.

#### CAUTION

The battery ground cable must be disconnected before charging the battery or ECU damage may result.

Once you have determined that battery voltage is sufficient, the battery charge light should be checked to make sure it is illuminated with all switches ON.

If the light is not illuminated, the problem must be located before proceeding further. This light must illuminate with all switches in the ON position before starting the engine. Once the engine starts, the light must go out. This indicates the charging system is working correctly. If the light remains illuminated after the engine is started, the charging system is not working properly (see Battery Charging System section).

If the light does not illuminate when all switches are in the ON position, this may indicate that either one of the switches (Ignition, Emergency Shut-off, Tether, Throttle Sensor) is not working properly or that the light is burnt out.

To locate the problem use the following procedure:

1. Turn all switches ON (Ignition Switch, Emergency Stop Switch, and Tether Cord). If the light does not illuminate proceed to step 2.
2. Squeeze the throttle lever. If the light illuminates, adjust the throttle cable tension. If the light does not illuminate proceed to step 3.
3. Check the brown fuse link wire. If the fuse link tests good and the light does not illuminate proceed to step 4.
4. Check the brown EFI relay. If the relay tests good and the light does not illuminate proceed to step 5.
5. Check the wire connections at the key switch, emergency shut-off switch, and tether switch to ensure they are tight and clean. If the light does not illuminate proceed to step 6.
6. Check the bulb. Disconnect and test with 12 volts DC. The bulb is part of the lamp assembly and is not replaceable.
7. Once again, check battery voltage. Voltage must be 12 volts or higher.

With the battery charge light illuminated, and all switches in the ON position, check the LED signal light for a single flash. This indicates current is reaching the ECU and all EFI components are working properly.

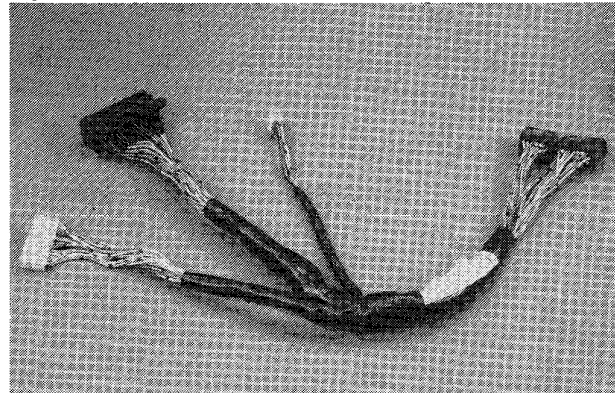
## ECU

### ACTIVATING THE ECU MEMORY

The ECU has a memory mode that enables you to determine if any of the six sensors have intermittently failed. To activate the memory system follow these steps:

1. Turn the ignition switch to the OFF position; then install the test harness (p/n 0644-181).

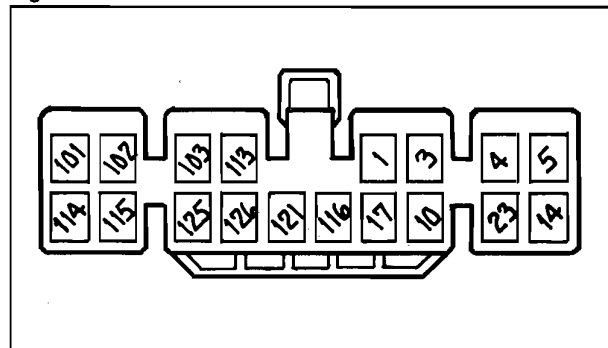
Fig. 3-25



AE113

2. Using a jumper wire, ground pin number 14 to the ECU.

Fig. 3-26



0729-602

3. While grounding pin 14, turn the ignition switch to the ON position. Check the LED for any possible failure codes being flashed.



**NOTE:** When reading the LED, have paper and pencil available to write down the codes being flashed. You may see more than one code being flashed. Do not break the ground connection until you have read and recorded all codes being flashed.

- Once the problem area has been determined, check the component for clean and tight connections. If the connections are good, proceed to testing individual components section.

To erase the memory of the ECU, turn the key to the ON position. Ground pin number 14 and break the ground 3 to 4 times with a second or two between each contact while the fuel pump is cycling. Reground pin 14 and check the LED to ensure the code has been erased.

**NOTE:** There isn't a test for the ECU. If a problem is suspected in this area, try the ECU on another snowmobile if possible. Authorized Arctco Arctic Cat dealers may send the ECU to the Arctco Service Department for testing. Please contact the Service Department before sending.

### REMOVING

<b>⚠ CAUTION</b>
To avoid damage to electrical components, all switches must be in the OFF position and the battery disconnected before servicing any EFI electrical component.

- Disconnect the battery; then disconnect the two main wire harness connectors from the ECU.

Fig. 3-27



AR025

- Remove the cap screw and three nuts securing the ECU mounting bracket.

- Tip the ECU forward.
- From the underside of the ECU remove the four screws securing the ECU to the mounting bracket.
- Remove the ECU from the bracket.

### INSTALLING

- Using four screws, secure the ECU to the mounting bracket.
- Place the ECU mounting bracket into position and secure with one cap screw and three nuts.
- Connect the two main wiring harness connectors to the ECU.

**NOTE:** Use care not to damage the connector O-ring seals.

- Connect the battery.

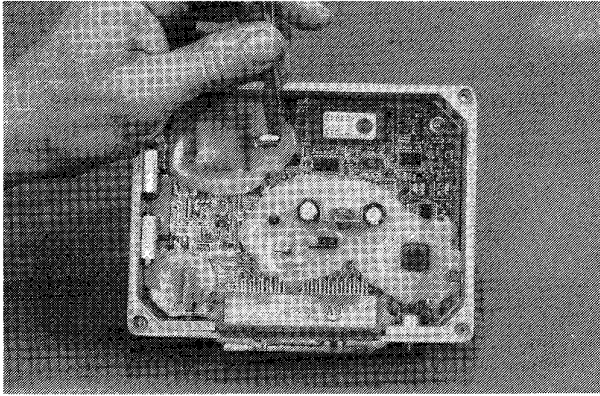
<b>⚠ CAUTION</b>
The positive cable must be connected first.

### EPROM (chip)

#### Removing

- Disconnect the negative battery cable from the battery; then turn the ignition switch to the OFF position.
- Remove the four screws securing the ECU cover.
- Before touching the EPROM (chip), use a screwdriver to discharge all static electricity from your body by grounding yourself to the metal post and the ECU frame.

Fig. 3-28



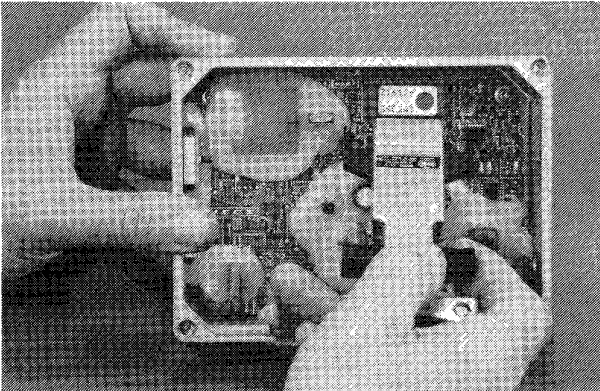
AR026

**⚠ CAUTION**

Failing to discharge static electricity from your body before handling the EPROM (chip) may ruin the chip being removed or the new chip being installed.

- Using the Chip Puller (p/n 0644-188), pull the chip straight up out of its mounting sockets.

Fig. 3-29



AR027

**Installing**

**NOTE:** Before touching the EPROM (chip), use a screwdriver to discharge all static electricity from your body by grounding yourself to the metal post and the ECU frame.

**NOTE:** Both the EPROM (chip) and its mounting plate are notched. When installing the chip the notched end must align with the notch in the mounting plate.

- Insert the back row of pins into the mounting sockets. Be careful to assure each pin is started into its socket.
- Carefully lower the front pins into their sockets. Once all pins are in their sockets, press the chip down firmly.
- Install the ECU gasket and cover; then apply a bead of silicone to the edge of the cover in the area of the plastic connection receptacle.

Fig. 3-30

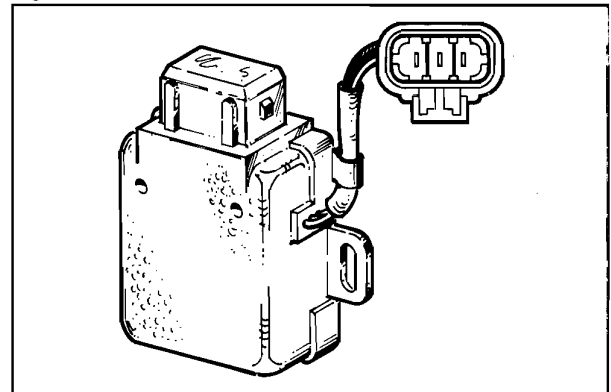


AK025

**Testing Individual Components**

**THROTTLE POSITION SENSOR**

Fig. 3-31



0728-728



## Testing Resistance

1. Place the multimeter selector in the ohms position. Test between the red and black leads in the throttle sensor connector. Test specification is 5000 ohms  $\pm$  15 percent.
2. Test between the throttle sensor's black and white leads, with the throttle in the idle position. Test specification is 850 ohms  $\pm$  15 percent.
3. Place the throttle in the wide-open-throttle position. Test between the white and black leads. Test specification is 5000 ohms  $\pm$  15 percent.
4. Attach the multimeter to the throttle sensor black and white leads; then compress and release the throttle lever. The resistance should change as the throttle lever is compressed and released. If the resistance does not change, the sensor is not operating correctly.

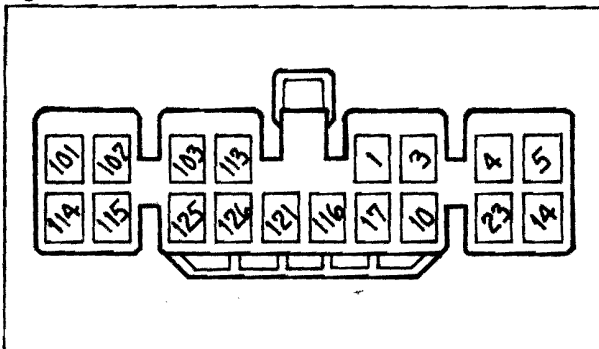
**NOTE:** See page 79 for replacement.

## Testing Throttle Valve Sensor Line Voltage

**NOTE:** Before testing any EFI component check the connection to ensure it is clean and tight.

1. Turn the ignition switch to the OFF position. Install the test harness (p/n 0644-181) by disconnecting the main harness from the ECU and inserting the test harness connectors into the ECU. Insert the main harness connectors into the large black connector of the test harness.
2. Turn the ignition switch ON.
3. Using the multimeter set on the DC voltage scale, test the throttle valve main line voltage between pins 1 and 17. Voltage must measure between 5.22 volts maximum and 5.02 volts minimum.

Fig. 3-32



0729-602

4. If no voltage is found, check the following components:
  - A. Battery Voltage - must measure 12.6-12.8 volts. Charge battery if low.
  - B. Check to ensure all switches are ON and that the throttle monitor low speed switch is activated. The battery light on the console should be ON at this time.
  - C. Check the brown fuse link wire for voltage at its output end. *Battery voltage must be indicated. If not replace the brown fuse link.*
  - D. Check the brown EFI relay.
5. If low voltage is indicated, disconnect the throttle sensor from the main harness. If the voltage now reads within specifications, the throttle sensor is faulty and must be replaced.

## Testing Voltage

1. Turn the ignition switch OFF.
2. Disconnect the main harness from the ECU and install the EFI test harness.
3. Turn the ignition switch ON.
4. Using a multimeter set on the DC scale, test between pins 3 and 17.
5. With the throttle in the full-closed position, voltage must measure between 0.77 volts minimum and 0.87 volts maximum.

**NOTE:** The throttle shaft must be in the full-closed position for the above test. If the throttle cable is not allowing the throttle shaft to fully close, the reading will measure too high.

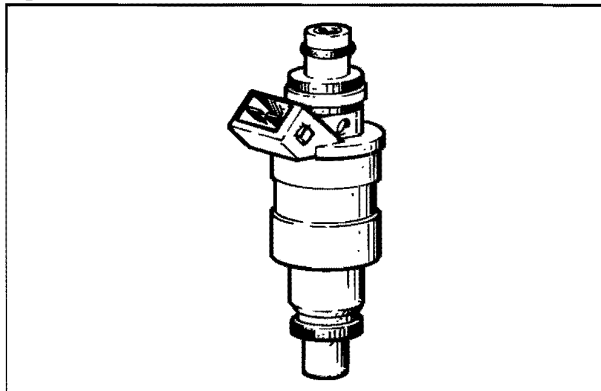
6. Compress the throttle lever to the wide-open-throttle position. Measure the voltage between pins 3 and 17. Voltage must measure between 3.8 volts minimum and 4.2 volts maximum.

**NOTE:** The throttle cable must pull the throttle lever to the full-open position for an accurate test. If your reading is low, pull on the throttle cable with your free hand to make sure the throttle is in the full-open position. If your reading is now within specifications, adjust the throttle cable.

7. If the voltage tests are not within specifications at the closed position, adjust or replace the throttle valve sensor.

## INJECTORS

Fig. 3-33



0728-718

### Testing Resistance

1. Disconnect the injector wire harness.
2. Use the multimeter set on the ohms scale.
3. Check the resistance between the two injector terminals. Test specifications are 1.8 ohms  $\pm$  15%.
4. Replace the injector if not within specifications.

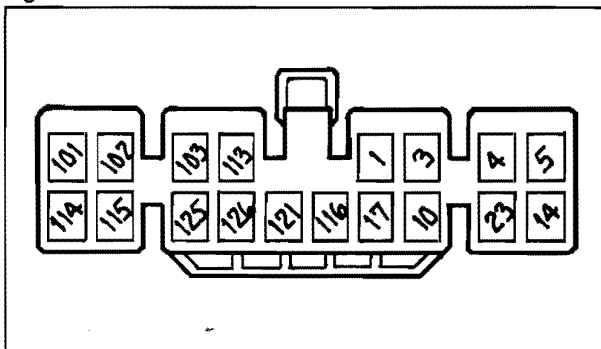
### Testing Voltage

1. Turn the ignition switch to the OFF position; then install the EFI test harness (p/n 0644-181).

**NOTE: The ignition must remain in the OFF position for this test.**

2. Using the multimeter set on DC voltage, test between pins 101 and 121. Battery voltage should be noted. This indicates that line voltage for the number 1 injector (MAG-side) is satisfactory.

Fig. 3-34



0729-602

3. Test between 102 and 121. Battery voltage should be noted. This indicates that line voltage for the number 2 injector (PTO-side) is satisfactory.
4. If no voltage is found, check the battery condition and connections, the brown fusible link, the brown EFI relay, and the wire connections at the ECU.

**NOTE: The injector should "click" when operating under power.**

### Removing

#### CAUTION

To avoid damage to EFI electrical components, all switches must be in the OFF position and the battery disconnected before servicing. The negative cable must be disconnected first.

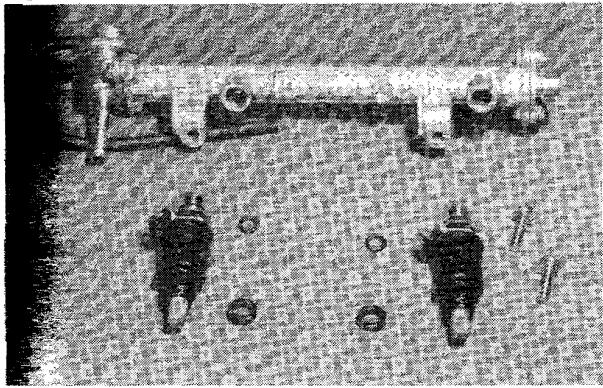
#### CAUTION

The fuel supply hose may be under pressure. Place an absorbent towel around the connection to absorb fuel; then remove the hose slowly to release the pressure.

1. Loosen the clamp securing the fuel supply hose to the fuel rail; then remove the hose from the fuel rail.
2. Disconnect the wiring harness from each injector.
3. Remove the two screws securing the fuel rail to the throttle bodies; then remove the fuel rail from the injectors. Account for one O-ring in each injector.
4. Remove the injectors from the throttle bodies; then remove an O-ring from the top and bottom of each injector.



Fig. 3-35



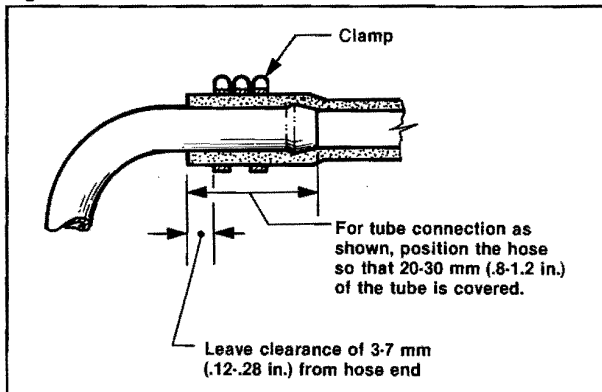
AK030

### Installing

1. Apply a light coat of oil to all O-rings; then install the upper and lower O-rings onto each injector.
2. Install the injectors into the throttle bodies.
3. Place the fuel rail into position on the injectors and secure with two screws.
4. Attach the fuel delivery hose to the fuel rail and secure with a clamp.

**NOTE:** When securing the fuel delivery hose, position the clamp as shown below.

Fig. 3-36



0729-325

5. Connect the wiring harness to the injectors making sure the number 1 harness is connected to the MAG-side injector.
6. Connect the battery cables. Install the positive cable first; then connect the negative cable.

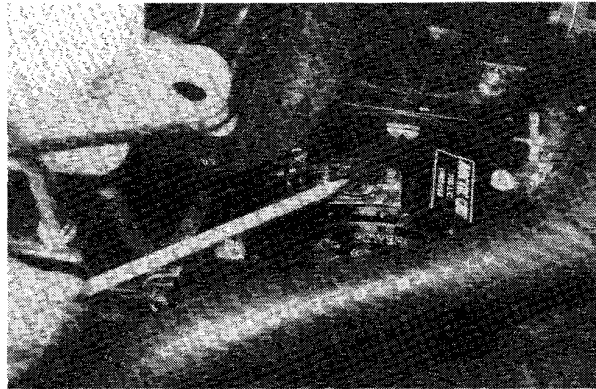
## ⚠ CAUTION

The positive cable must be connected first.

### CRANKSHAFT POSITION SENSOR

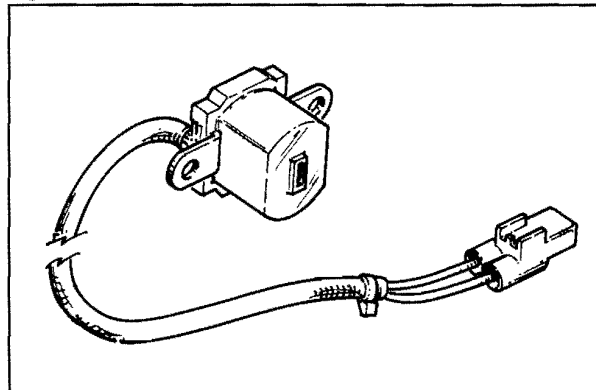
**NOTE:** The crankshaft position sensor is located on top of the magneto housing MAG-side.

Fig. 3-37



AK022

Fig. 3-38



0729-627

### Testing Resistance

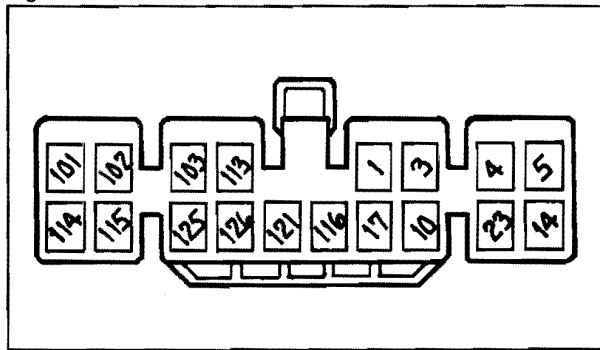
1. Use the multimeter set to the ohms position.
2. Test between the two leads coming from the injector sensor. Test specification is 190 ohms  $\pm$  20%.

### Testing Voltage

1. Turn the ignition switch to the OFF position; then install the EFI test harness.

- Using a multimeter set on the AC scale, test between pins 23 and 17. Crank the engine over hard and observe the voltmeter. Reading should be 0.1 to 0.3 volts.

Fig. 3-39



0729-602

- If low voltage or no voltage is indicated, check the crankshaft position sensor harness connector for being clean and tight. Retest to confirm results. If the reading is still low, replace the sensor.

### Removing

#### CAUTION

To avoid damage to EFI electrical components, all switches must be in the OFF position and the battery disconnected before servicing. The negative cable must be disconnected first.

- Open the rubber boot that protects the main wiring harness connections; then disconnect the crankshaft position sensor from the main wiring harness.
- Remove the two screws securing the crankshaft position sensor to the magneto housing.
- Remove the sensor from the engine compartment.

### Installing

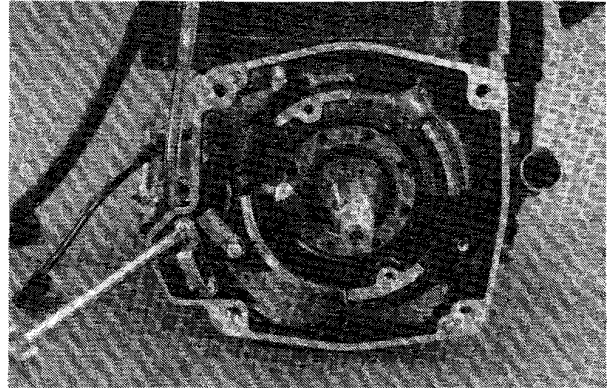
- Using two screws coated with LOCTITE 242, secure the crankshaft position sensor to the magneto housing.
- Connect the crankshaft sensor to the main wiring harness; then close the rubber boot.
- Secure loose wires with cable ties.
- Connect the battery.

#### CAUTION

The positive cable must be connected first.

### IGNITION TIMING SENSOR

Fig. 3-40



A0001

**NOTE:** The timing sensor is behind the recoil in the magneto housing.

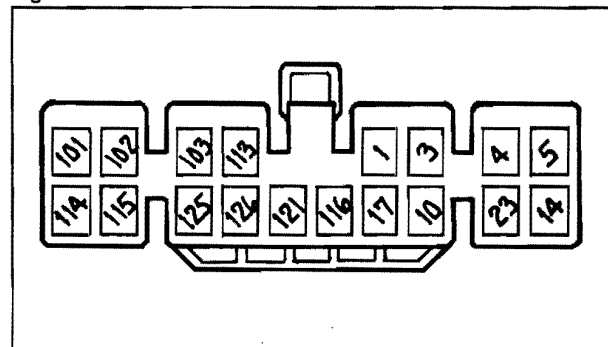
### Testing Resistance

- Disconnect the two leads from the timing sensor to the main harness.
- Use the multimeter set on the ohms scale.
- Test between the red/white and green/white leads from the sensor. Test specification is 101 ohms  $\pm$  20%.

### Testing Voltage

- Turn the ignition switch to the OFF position; then install the EFI test harness.
- Using the multimeter set on the AC scale, test between pins 10 and 17.

Fig. 3-41




0729-602



3. Crank the engine over hard. Reading should be between 0.1-0.3 volts.
4. If the reading is low, check the timing sensor connector for being clean and tight. Retest to confirm results. If the reading remains low, replace the sensor.


### Removing

 <b>CAUTION</b>
<p>To avoid damage to EFI electrical components, all switches must be in the OFF position and the battery disconnected before servicing. The negative cable must be disconnected first.</p>

1. Remove the recoil and flywheel (see Engine section).
2. Remove the two screws securing the ignition timing sensor to the magneto housing. Remove the screw securing the wire harness keeper.
3. Open the rubber boot that protects the main wiring harness connections; then disconnect the ignition timing sensor from the main wiring harness.
4. Remove the sensor from the engine compartment.

### Installing

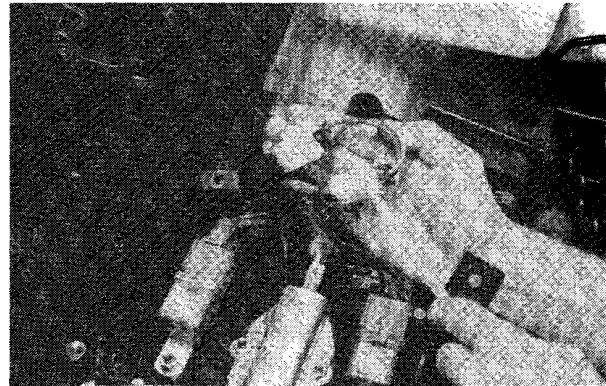
1. Route the timing sensor wiring harness through the magneto housing. Connect the timing sensor to the main wiring harness; then close the rubber boot.
2. Using two screws coated with LOCTITE 242, secure the injector sensor to the magneto housing.
3. Secure loose wires with cable ties.
4. Install the flywheel and recoil (see Engine section).
5. Connect the battery.

 <b>CAUTION</b>
<p>The positive cable must be connected first.</p>

### FUSE LINK

**NOTE:** The green and brown leads located by the battery are known as the fuse link wires.

Fig. 3-42



AK028

**3**

### Testing Resistance

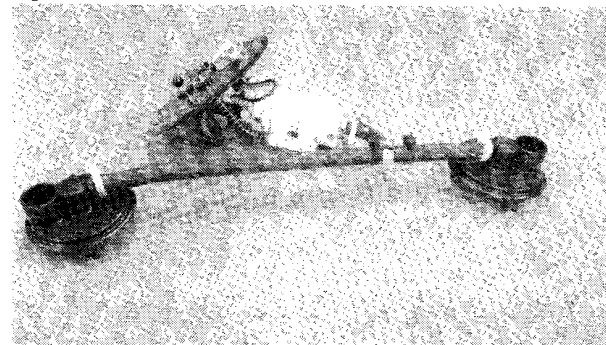
1. Remove the fuse link from the system.
2. Using the multimeter set to the ohms position, test the green and brown fuse link wires. Test specification for the green lead is 0.2 ohms  $\pm$  15%, and the test specifications for the brown lead is 0.2 ohms  $\pm$  15%.

### Testing Voltage

1. Disconnect the output end of the fuse link from the main harness.
2. Using the multimeter set on the DC volt position, test the voltage at the end of the fuse link wire.
3. Voltage must equal battery voltage on both wires.

### ELECTRIC FUEL PUMP

Fig. 3-43



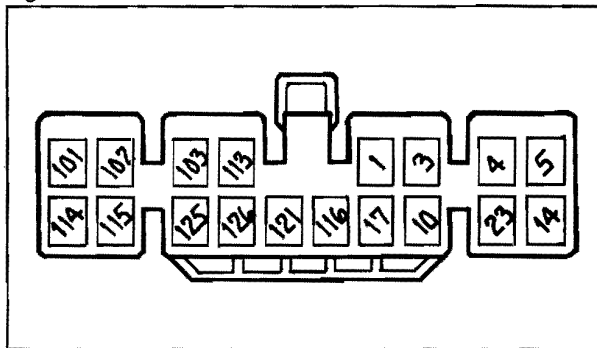
A0074

If the fuel pump fails to operate, perform the following:

1. Check the battery voltage. It must be above 12.6 volts.
2. Check voltage at the output end of the green fuse link wire. It must be equal to the battery voltage. If there is no voltage, replace the fuse link.
3. Turn the ignition switch to the OFF position; then install the EFI test harness.
4. Using the multimeter set on the DC volt scale, test between pins 113 and 121. Battery voltage must be indicated.

**Battery voltage must be indicated when the pump is not running. No voltage will be indicated when the fuel pump is operating.**

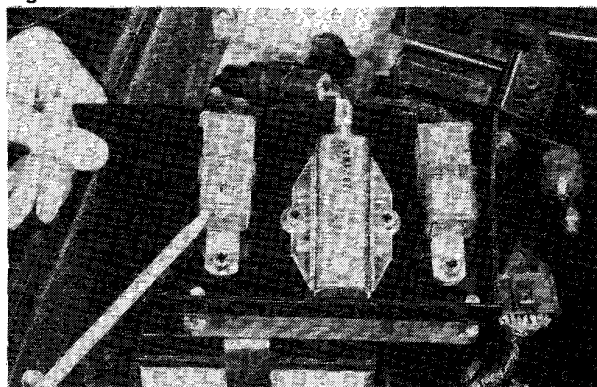
Fig. 3-44



0729-602

5. If voltage is not indicated and both the battery and fuse link wires are in good condition, the fuel pump relay may be faulty. Check the blue fuel pump relay resistance.

Fig. 3-45



AK023

6. Turn the ignition switch to the ON position. Test between pins 113 and 121. The meter should indicate no voltage while the fuel pump is running and show battery voltage as soon as the fuel pump stops. Cycle the fuel pump (turn the ignition switch ON and OFF) two times to confirm the reading.
7. If correct voltage is indicated and the fuel pump fails to operate, check the fuel pump connector and fuel pump continuity. Remove the main harness connector from the fuel pump and test for voltage at the connector. Battery voltage should be found with all switches in the ON position (after switch has been ON for five seconds). If battery voltage is present, test the fuel pump continuity.
8. If voltage is not indicated, test the blue fuel pump relay (see Fuel Pump Relay section).

### Testing Continuity

1. Disconnect the wiring harness from the fuel pump.
2. Set the multimeter to the ohms scale.
3. Check continuity between the center two fuel pump pin connectors.
4. Meter should show continuity.

If the fuel pump harness shows the proper voltage (battery voltage) and the fuel pump fails to operate replace the fuel pump.

### CAUTION

The fuel pump should never be run dry for a long period of time or damage will result.

### Testing Fuel Pressure

### WARNING

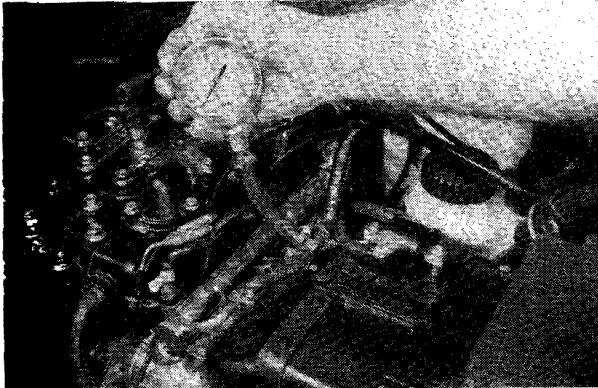
If the fuel pump or hose is to be removed from the system, slowly release the fuel line pressure by loosening the inlet hose clamp and covering the connection with an absorbent towel.

1. Fuel pressure can be checked by installing a pressure gauge between the fuel supply hose and fuel rail.



- Position hose clamps back 3 mm (0.120 in.) from the end of the fuel hose and tighten clamps securely.

Fig. 3-46



A0011

- Start the engine and observe the fuel pressure. If fuel pressure exceeds or falls below 36.2 lbs., the fuel pressure regulator may be defective (see Fuel Pressure Regulator section) or the fuel return hose may be obstructed (remove obstruction).

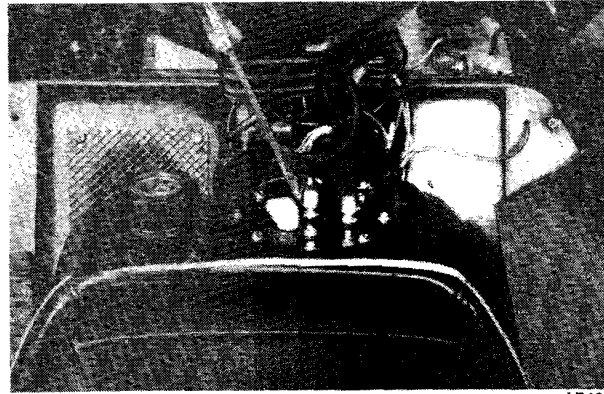
### Removing

- Disconnect the negative battery cable from the battery.
- Remove the console (see Removing Console section); then remove the gas cap and spill seal.
- Disconnect the fuel pump wiring harness from the fuel pump.
- Label the fuel lines "supply" and "return"; then loosen the clamps and remove the fuel hoses.

### WARNING

The fuel supply hose may be under pressure. Cover with an absorbent towel while removing to collect any fuel.

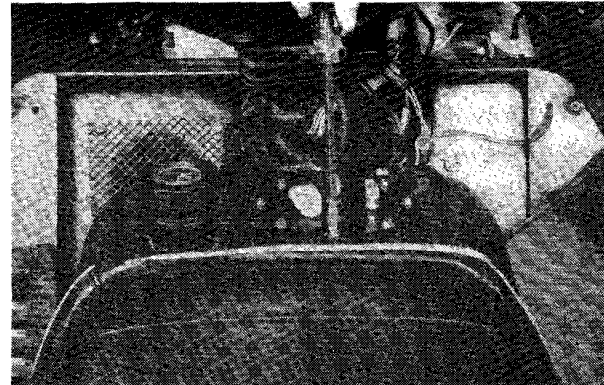
Fig. 3-47



AR109

- Remove the eight screws and nylon washers securing the cover plate; then remove the fuel pump assembly. Account for a gasket.

Fig. 3-48



AR110

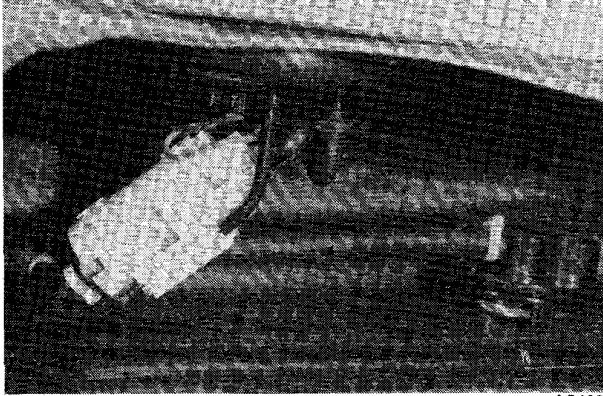
### Installing

- Install the gasket on the tank; then install the fuel pump assembly with the screens on the two fuel pick-up valves facing down and the long pick-up positioned to the rear of the tank.

**NOTE:** The screens on the two fuel pick-up valves must face down in the fuel tank.

3

Fig. 3-49



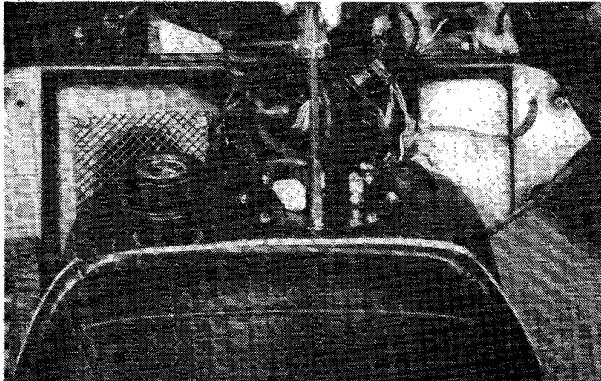
AO102

- Secure the fuel pump with eight screws and washers. Torque to 0.1 kg-m (12 in.-lb).

**⚠ WARNING**

Do not overtighten the screws securing the cover plate to the fuel tank. The cover plate will be deformed and leakage will result.

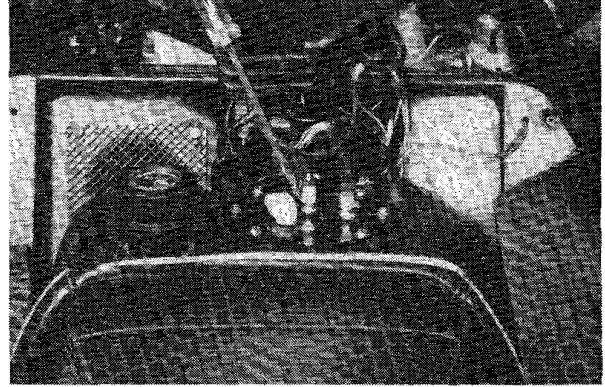
Fig. 3-50



AR110

- Connect the fuel pump wiring harness to the fuel pump.
- Attach the fuel supply and return hoses to their respective fittings and secure with clamps.

Fig. 3-51

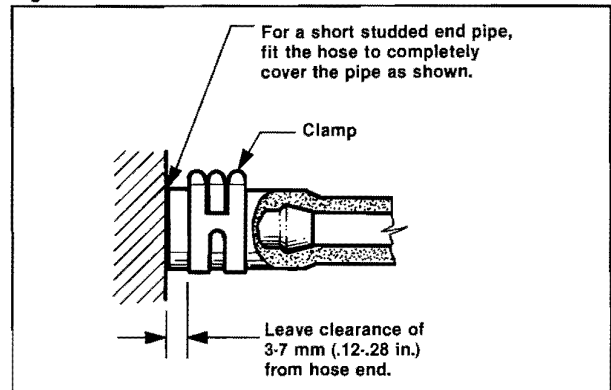


AR109

**⚠ CAUTION**

Check fuel line connections to ensure they are tight and properly connected.

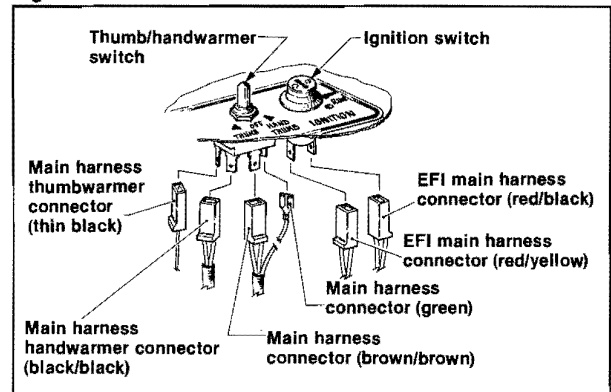
Fig. 3-52



0729-324

- Place the console into position. Attach all wires to their respective switches.

Fig. 3-53



0729-570



6. Install the spill seal and gas cap; then install the console (see Installing Console section).
7. Attach the negative battery cable to the battery.

## FUEL PRESSURE REGULATOR

### Removing

#### CAUTION

To avoid damage to EFI electrical components, all switches must be in the OFF position and the battery disconnected before servicing. The negative cable must be disconnected first.

1. Loosen the clamp securing the fuel return hose to the fuel regulator; then remove the hose.
2. Remove the two screws securing the fuel pressure regulator to the fuel rail; then slowly remove the regulator. Account for the O-ring.

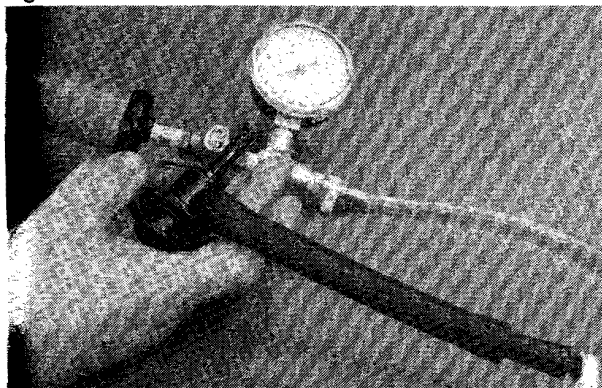
#### CAUTION

Since the fuel regulator may be under pressure, remove it slowly to release the pressure. Place an absorbent towel around the connection to absorb fuel.

### Testing Fuel Pressure Regulator

1. Attach the Pressure Tester (p/n 0144-127) to the pressure regulator fuel inlet.

Fig. 3-54



A0053

**NOTE:** You will need to use a short piece of 3/8 in. I.D. hose to make the above connections.

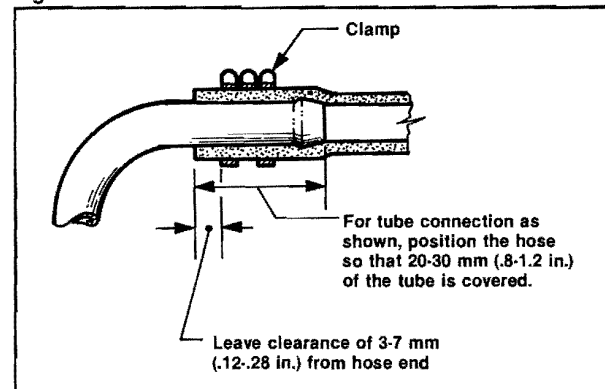
2. Pressurize the regulator to 2.0-2.2 kg/cm<sup>2</sup> (28-31.3 psi). Turn the pressure tester shut-off valve to the OFF position. Observe the gauge for several minutes and note if there is any loss of pressure. If pressure begins to drop, the cause may be a ruptured diaphragm, worn spring, or leaking valve. If the regulator fails to build or maintain pressure, replace the fuel regulator.

**NOTE:** If there is a drop in pressure, check the hose connections to ensure there are no leaks.

### Installing

1. Position the O-ring on the fuel pressure regulator; then place the fuel pressure regulator into position on the fuel rail. Secure with two screws.
2. Connect the fuel return hose to the fuel pressure regulator; then secure with a clamp.

Fig. 3-55



0729-325

3. Connect the battery.

#### CAUTION

The positive cable must be connected first.

### EFI RELAY - FUEL PUMP RELAY - DROPPING RESISTOR

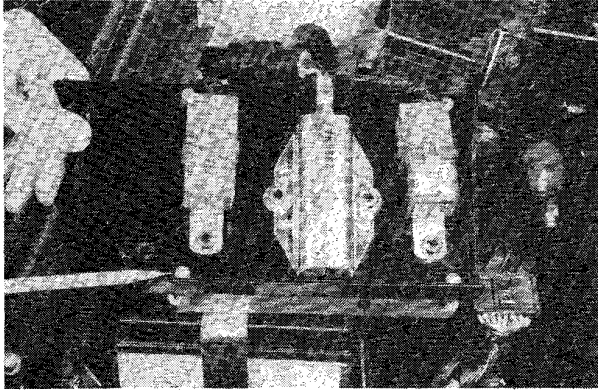
#### CAUTION

To avoid damage to EFI electrical components, all switches must be in the OFF position and the battery disconnected before servicing. The negative cable must be disconnected first.

## Location

The EFI Relay, Fuel Pump Relay, and the Dropping Resistor are all mounted on the back side of the ECU mounting bracket.

Fig. 3-56



AK026

## Removing

1. Disconnect the negative battery cable from the battery.
2. Remove the two cap screws and nuts securing the ECU mounting bracket; then carefully tip the ECU and bracket forward.
3. Remove the lock nut(s) securing the component to be tested to the ECU mounting bracket.
4. Disconnect the wiring harness from the component.

## Installing

**NOTE:** Before installing any EFI component, inspect all wiring harness connectors to ensure they are corrosion-free.

1. Attach the wiring harness connector to the component being installed.
2. Using lock nut(s), secure the component to the ECU mounting bracket.
3. Position the ECU and mounting bracket into position and secure with two cap screws and nuts.

## CAUTION

To avoid damage to EFI electrical components, all switches must be in the OFF position and the battery disconnected before servicing. The negative cable must be disconnected first.

4. Connect the battery.

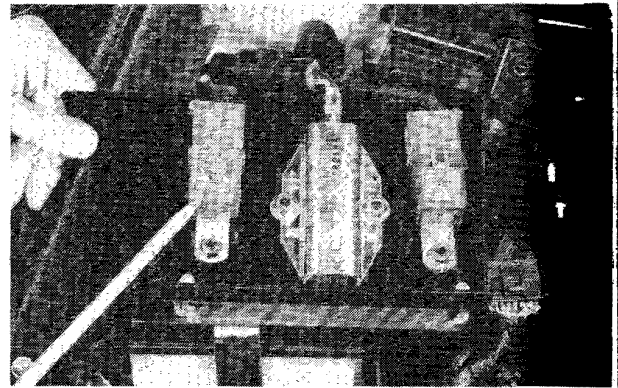
## CAUTION

The positive cable must be connected first.

## FUEL PUMP RELAY

**NOTE:** The fuel pump relay is located behind the ECU bracket and is blue color (see EFI Relay-Fuel Pump Relay-Dropping Resistor section).

Fig. 3-57



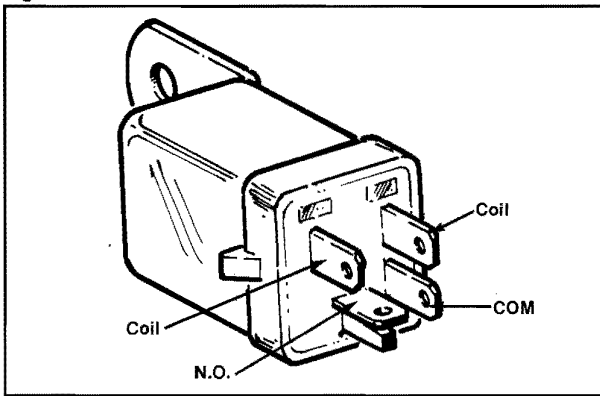
AK026

## Testing Resistance

1. Disconnect the fuel pump relay from its connector; then remove the relay.



Fig. 3-58

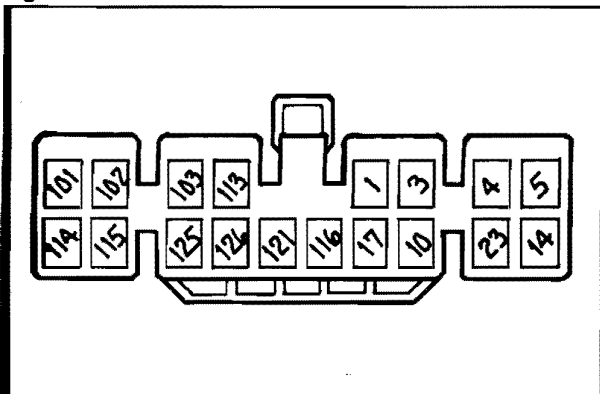


2. Set the multimeter to the ohms scale.
3. Test between the two terminals marked "Coil". Test specification is 68 ohms  $\pm$  15%.
4. Connect the multimeter test leads to terminals marked "COM" and "N.O." (normally open). There should be no resistance.
5. Using a 12-volt power source, connect the power source to terminals marked "Coil". Be very careful not to make contact with any of the other terminals. With the power source connected, test resistance between terminals marked "COM" and "N.O.". Maximum resistance specification is 2.5 ohms.

### Testing Voltage

1. Turn the ignition switch to the OFF position; then install the EFI test harness.
2. Using the multimeter set to the volt position, test between pins 113 and 121. The reading indicates, battery voltage.

Fig. 3-59

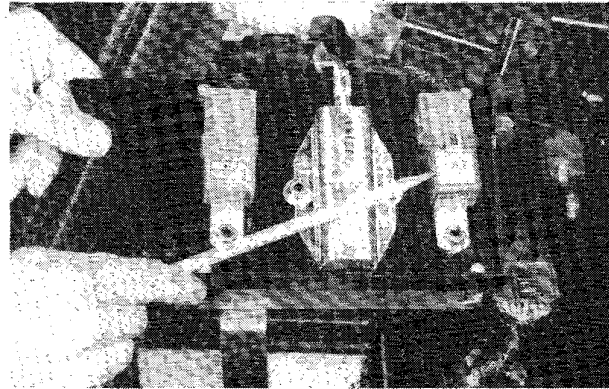


3. Turn the ignition switch to the ON position. While the fuel pump is cycling there will be no voltage reading. When the fuel pump stops, battery voltage will once again be indicated and the fuel pump relay is working properly.

### EFI RELAY

**NOTE:** The ignition relay is located behind the ECU bracket and is brown in color (see EFI Relay-Fuel Pump Relay-Dropping Resistor Section).

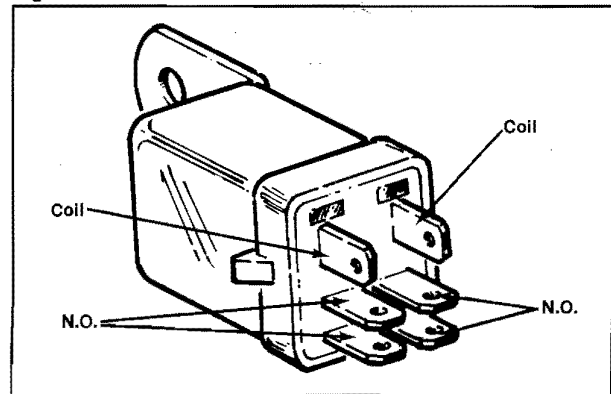
Fig. 3-60



### Testing Resistance

1. Remove the EFI relay from the ECU bracket; then disconnect the relay from the wiring harness.

Fig. 3-61



2. Set the multimeter to the ohms scale.
3. Test between the two terminals marked "Coil". Test specification is 68 ohms  $\pm$  15%.
4. Connect the multimeter test leads to each set of terminals marked "N.O." (normally open). There should be no resistance.

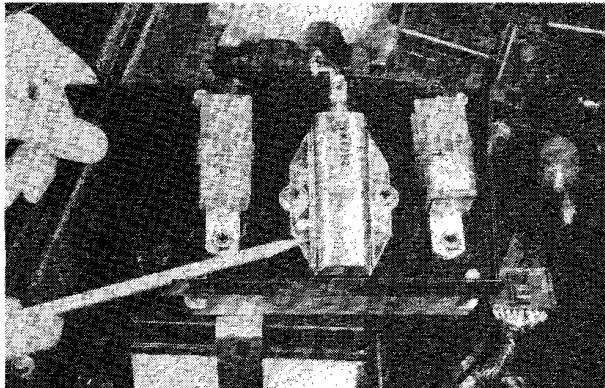
**NOTE:** There are two terminals marked "N.O." and each has a terminal indicated with an arrow. Test separately as "sets".

- Using a 12 volt power source, connect the negative lead to one coil terminal and connect the positive lead to the other coil terminal. Be very careful not to make contact with any of the other terminals. With the power source connected, test resistance between each set of terminals marked "N.O.". Maximum resistance specification is 2.5 ohms.

### DROPPING RESISTOR

**NOTE:** The dropping resistor is located behind the ECU bracket (see EFI Relay-Fuel Pump Relay-Dropping Resistor section).

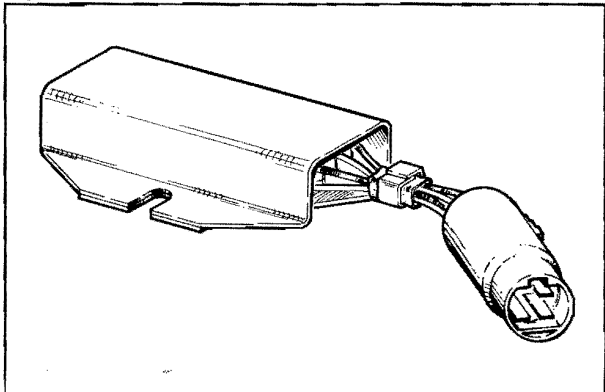
Fig. 3-62



### Testing Resistance

- Remove the dropping resistor from the ECU bracket; then disconnect from the wiring harness.

Fig. 3-63



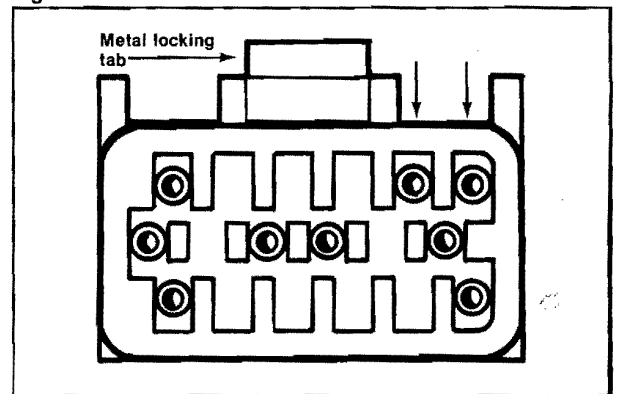
- Using the multimeter, test between the black lead and white lead of the resistor. Test specifications are 6.1 ohms  $\pm$  15%.

### Testing Injector Ground Circuit

**NOTE:** If a problem exists where one or both injectors fail to operate, complete the following test to determine if the problem lies in the main harness, dropping resistor, fuse link, injector lead, or the injector(s).

- Turn the ignition switch to the OFF position.
- Disconnect the smaller of the two harness connectors from the ECU.
- With the metal locking tab positioned on top, look into the connector and note the two pin connectors in the top row, right corner.

Fig. 3-64



- Using a jumper wire, short each pin connector (2 pins located in the upper right corner) to ground separately. As this is done, you should hear one of the injectors "click". This indicates the dropping resistor, wiring harness, fuse link and injector are working properly.
- If the injector fails to operate after completing the above test, the problem lies in either battery voltage, the brown fuse link, the dropping resistor, the wiring harness, the ECU connection, or the ECU. If both injectors click as the two pins are shorted to ground but fail to operate when trying to start the engine, the injector timing sensor or ECU may be defective. First test the ignition timing sensor (see Testing Ignition Timing Sensor section).
- Clean all pin connectors in the harness and connect to the ECU. Push all wires into the back of the connector to ensure good contact is being made. Retest to see if injectors now operate.



## WATER TEMPERATURE SENSOR

### Testing Resistance

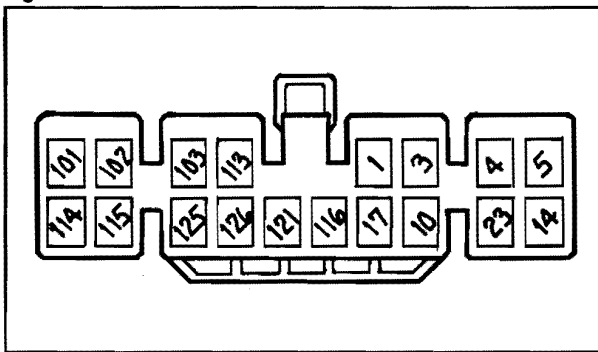
**NOTE:** The water temperature sensor is very sensitive to temperature change. Before the resistance test is conducted, it is important to know the coolant temperature. If the engine has been operated recently and the coolant is warm, the resistance will measure lower than if the coolant was at room temperature or colder. For accurate test results, check the coolant temperature in the filler neck using a thermometer.

1. Disconnect the water temperature sensor wiring harness from the main harness.
2. Using the multimeter, test the resistance between the two leads from the sensor.
3. Compare the resistance reading to the Resistance/Voltage Temperature Chart on page 87. If resistance is not within the specification, replace the sensor.

### Testing Voltage

**NOTE:** Knowing the temperature of the coolant in the engine is very important to determine the correct specification. If the engine has been operated and the coolant is still warm, allow to cool completely in the shop area. For accurate results, place a thermometer in the coolant at the filler neck and check the coolant temperature. Refer to the Resistance/Voltage Temperature Chart on page 87 for the correct voltage specification in relationship to the coolant temperature.

Fig. 3-65



0729-602

1. Turn the ignition switch to the OFF position; then install the EFI test harness.
2. Turn the ignition switch to the ON position.

3. Perform the test between pins 4 and 17 using a the multimeter set on the DC voltage scale.
4. Compare the reading to the Resistance/Voltage Temperature chart.
5. If the reading is not within specifications, check all connections to make sure they are clean and tight. Recheck to confirm results. If the voltage still is not within specifications, replace the sensor.

### Removing

#### CAUTION

To avoid damage to electrical components, all switches must be in the OFF position and the battery disconnected before servicing any EFI electrical component. The negative cable must be disconnected first.

1. Drain the cooling system.
2. Remove the throttle body (see Removing Throttle Body section).
3. Disconnect the wiring harness from the water temperature sensor.
4. Remove the sensor from the water temperature case.

### Installing

1. Apply teflon tape to the threads of the temperature sensor; then install the sensor.
2. Connect the wiring harness to the sensor.
3. Install the throttle body (see Installing Throttle Body section).

#### CAUTION

The positive cable must be connected first.

4. Connect the battery.
5. Fill the cooling system (see Liquid Cooling System section).

3

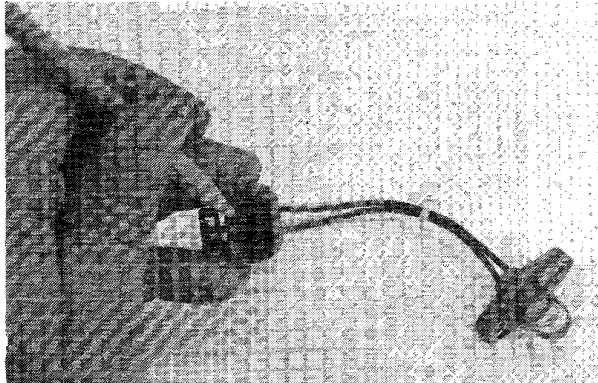
## AIR TEMPERATURE SENSOR

### Testing Resistance

**NOTE:** It is very important to know the component temperature before conducting this test. Allow the snowmobile to reach room temperature.

1. Disconnect the wiring harness from the sensor.

Fig. 3-66



A0101

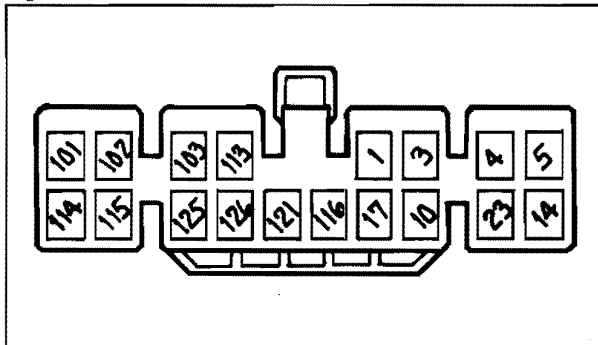
2. Using the multimeter, test the two leads located in the sensor connector. Compare with the Resistance/Voltage Temperature Chart.

**NOTE:** The air temperature sensor employs a thermistor, which is very sensitive to temperature change. Resistance will drop as temperature rises.

### Testing Voltage

**NOTE:** It is very important to know the component temperature before conducting this test. Allow the snowmobile to reach room temperature.

Fig. 3-67



0729-602

1. Turn the ignition switch to the OFF position; then install the EFI test harness.

### CAUTION

When using the test harness, be very careful not to touch the two voltmeter test probes together when in contact with the two test harness pins. Damage to the ECU may result.

2. Turn the ignition switch to the ON position. Using the multimeter set on the DC volt scale perform the voltage test between pins 5 and 17.
3. Compare the reading to the Resistance/Voltage Temperature Chart.
4. If test results are not within specifications, check all connections and temperature of the component area. Recheck the sensor. If not within specifications, replace the sensor.

### Removing

### CAUTION

To avoid damage to electrical components, all switches must be in the OFF position and the battery disconnected before servicing any EFI electrical component. The negative cable must be disconnected first.

1. Disconnect the wiring harness from the air temperature sensor.
2. Using a standard screwdriver, pry the sensor from end to end from the air-intake silencer. Account for two push pins.

### Installing

1. Push the sensor into the hole in the air-intake silencer and secure with push pins.
2. Connect the wiring harness to the air intake sensor.
3. Connect the battery.

### CAUTION

The positive cable must be connected first.



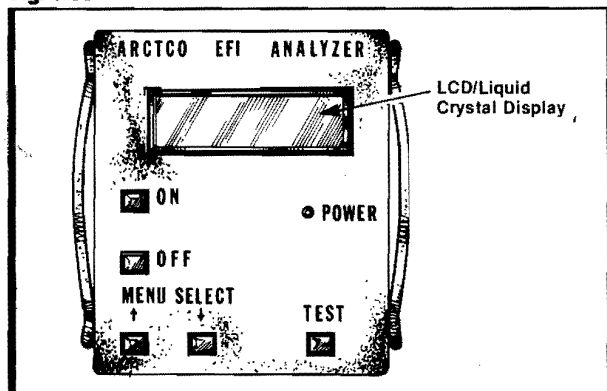
# Arctco EFI Analyzer

## GENERAL INFORMATION

This is an introduction to the Arctco EFI Analyzer (p/n 0644-202). The basic design of the analyzer makes it possible for all technicians to easily perform EFI system troubleshooting in a small amount of time.

## Analyzer Nomenclature

Fig. 3-68



0730-222

1. LCD - Liquid Crystal Display
2. Power-Light illuminates when the analyzer is properly connected to the snowmobile analysis test plug.
3. On/Off Switches
4. Menu Select (up/down) - Enables operator to select a test function quickly.
5. Test Button - Once the test function is selected, push the test button to complete the test. The test button also cancels the current test so the next test function can be selected.

## Analyzer Test Function

The Arctco EFI Analyzer has the capability to perform several EFI component and engine tests. The test functions are organized in the analyzer as shown below. Each time the analyzer is turned to the OFF position, the test function on the display will automatically start over at the top of the list.

To select any one of the test functions, push either of the MENU SELECT buttons until the desired test function title appears on the display. To perform the test of the function selected, push the TEST button.

Once the test has been completed, push the TEST button again to cancel the test and allow you to select a different test from the menu list.

## Menu List Organization:

1. Battery voltage
2. Engine RPM
3. Ignition timing
4. Throttle valve angle in degrees
5. Throttle valve angle in volts
6. Intake air temperature in Celsius
7. Intake air temperature in Fahrenheit
8. Water temperature in Celsius
9. Water temperature in Fahrenheit
10. Barometric pressure
11. Existing problem diagnosis test No. 1
12. Existing problem diagnosis test No. 2
13. Memory problem diagnosis test No. 1
14. Memory problem diagnosis test No. 2
15. Diagnosis memory clear

To test the EFI system using the Arctco EFI Analyzer, follow all instructions carefully and completely.

## Analyzer Set-up

Before connecting the analyzer to the snowmobile, always check to make sure it is in the OFF position. Next, connect the analyzer harness to the EFI analysis test plug located next to the ECU.

With the analyzer connected to the snowmobile wiring harness, turn ON all snowmobile switches (ignition, on/off, tether); then press the ON button of the analyzer. At this point, the power indicator light of the analyzer must be illuminated. If the power light fails to illuminate, check the following:

1. Switches - Snowmobile and Analyzer - All switches must be in the ON position.

2. Analyzer test harness connection.
3. Snowmobile battery condition - Check battery condition. Voltage must measure at least 12.4 volts.
4. Fuse link - Using a voltmeter, check the brown fuse link wire for voltage.

Any one or more of the above items could cause the power light not to illuminate. Locate and correct the problem before attempting the testing procedure. The power light must be illuminated in order for the analyzer to test the EFI system.

When troubleshooting the EFI system with the Arctco EFI Analyzer, there are EFI components the analyzer will NOT diagnose. These components must be tested using a good digital volt/ohmmeter or a fuel pressure gauge using the procedure in the "Introduction to EFI" section of this manual.

#### EFI Components Not Tested by Analyzer:

1. Fuse Link - Protects EFI components in case of short circuit.
2. Brown Relay - Main system relay.
3. Blue Relay - Fuel pump relay.
4. Fuel Pressure Regulator - Maintains fuel pressure at 36.2 PSI.
5. Electric Fuel Pump - Located in the fuel tank. Supplies fuel under pressure to fuel injectors.
6. Main Harness - Supplies all systems with current.

## Recommended EFI Troubleshooting Sequence

When troubleshooting the EFI system, use the following troubleshooting sequence to locate problems quickly and efficiently.

### Battery Test

If no power is indicated at the snowmobile battery charge light or analyzer power light, first check to make sure all switches are in the ON position; then check to make sure the analyzer has a good connection to the analysis test plug. If all switches are ON and the analyzer/test plug is properly connected, test the following components using a good digital volt/ohmmeter.

- a. Battery condition and all cable connections.
- b. Fuse link.
- c. Brown relay.
- d. Wiring harness and its ground connections.
- e. Switches - ignition / throttle monitor / tether.

Remember that the analyzer will not work without receiving power from the snowmobile battery through the analysis test plug. When the power light on the analyzer illuminates, the above components are working properly.

### Existing Problem Diagnosis Test No. 1

The "Existing Problem Diagnosis Test No. 1" should be the second test made (after the battery test). In this mode, the analyzer tests the following components all at once:

- a. Throttle position sensor
- b. Intake air temperature sensor
- c. Water temperature sensor
- d. Barometric pressure sensor
- e. Number 1 injector
- f. Number 2 injector

After pushing the TEST button on the analyzer, the display will indicate either "sensors okay" or which of the sensors are defective. You can then check these components individually using the procedures covered in the "Individual Component Testing" section.

### Existing Problem Diagnosis Test No. 2

In this mode, the analyzer tests the two sensors the EFI system not tested by the "Existing Problem Diagnosis Test No. 1". The sensors tested in this test are:

- a. Injection timing sensor



b. Ignition timing sensor

When performing this test, both sensors are tested at the same time. If the display indicates either sensor is defective, replace the defective sensor.

### Memory Problem Diagnosis Test No. 1

This should be the fourth test made and will reveal any problems in the sensor area which might have occurred intermittently as the snowmobile was being operated.

If there were any such intermittent problems, the problem area will be shown on the display. You can then check the indicated area for a wire connection problem or loose or corroded connections.

### Memory Problem Diagnosis Test No. 2

This should be the fifth test made and will reveal any problem areas in the ignition timing or injection timing sensor areas that might have been intermittent and therefore stored in the ECU memory.

Check that the timing sensors wire connections are both clean and tight. Make necessary repairs and clear the memory following the procedures provided in this section.

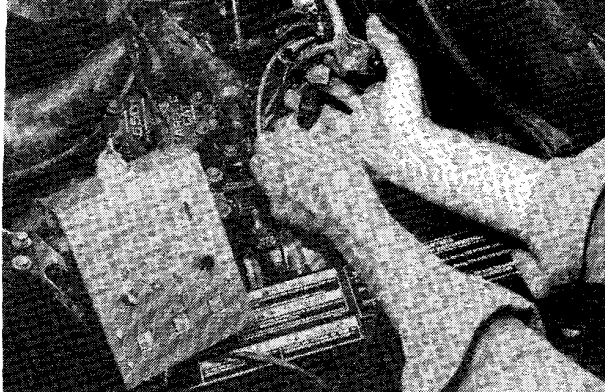
Next, proceed to testing individual EFI components.

## Testing Individual EFI Components

### Battery Condition and Charge System Test

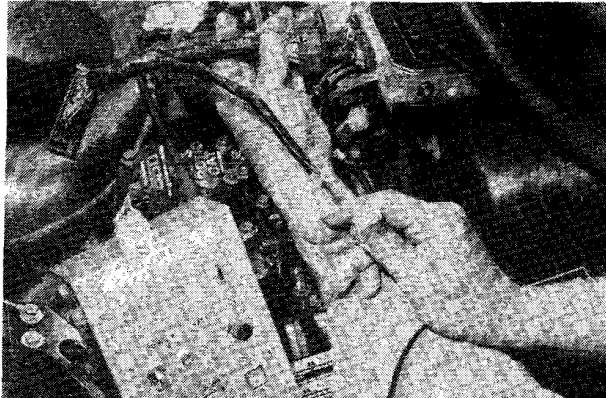
1. With the analyzer in the OFF position, connect the analyzer test plug to the snowmobile EFI analysis test plug.

Fig. 3-69



AR208

Fig. 3-70

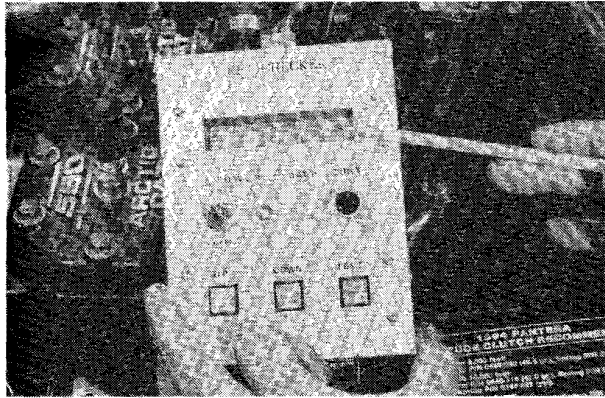


AR207

2. Turn ON all the snowmobile switches. The "red" charge indicator light on the snowmobile tachometer should be illuminated. Next, turn ON the analyzer. The analyzer "red" power light should now also be illuminated. If either the snowmobile charge indicator light or the analyzer power light fails to illuminate at this point, you must find the problem before proceeding.
3. With both the snowmobile charge indicator light and the analyzer power light illuminated, check the LCD (liquid crystal display) for the indicated test function. "Battery voltage" should be on the display. If "battery voltage" isn't displayed, press the MENU SELECT button repeatedly until it appears.

3

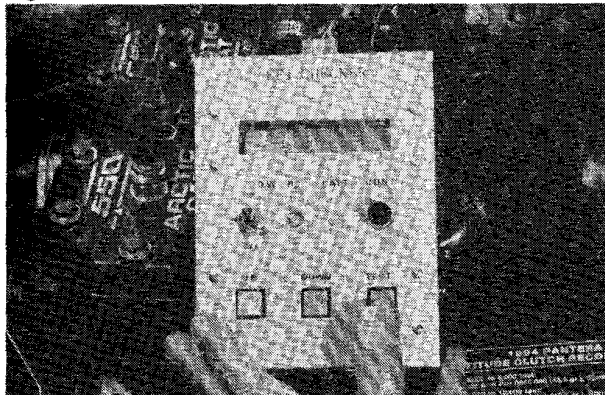
Fig. 3-71



AR228

4. With "battery voltage" indicated on the display, press the TEST button. The display will indicate the actual battery voltage. After observing the indicated voltage, start the engine. The voltage will increase if the charging system is working properly.

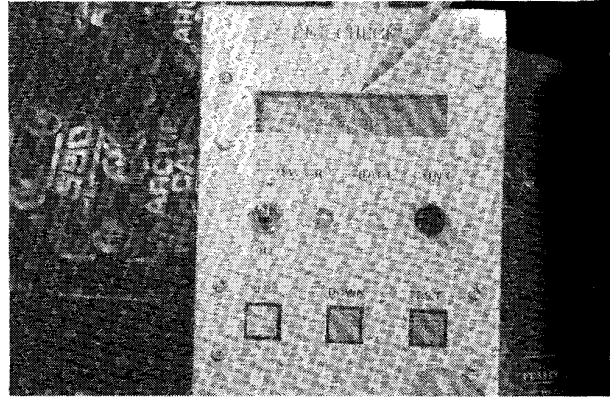
Fig. 3-72



AR212

**NOTE:** With the rear of the snowmobile on a safety stand and the engine running at 3000 to 4000 RPM, you may observe that the voltage will go as high as 14.5 to 15 volts if the battery condition test was low.

Fig. 3-73



AR228

5. If the battery condition test is low and voltage doesn't increase after starting the engine, test the charging system following instructions provided in this Service Manual.

**NOTE:** The minimum battery voltage that the EFI system will safely operate on is 9.0 volts.

6. If the battery voltage is low and the voltage does come up after starting the engine, this could indicate one of the following:
  - a. A voltage draw on the battery when the engine isn't running.
  - b. A weak or shorted battery cell.

### Voltage Draw Test

1. To check for a voltage draw condition, place an ammeter in series with the positive battery lead.
2. Start the engine. The ammeter should indicate the amount of current flow to the battery. Turn off the engine. The ammeter should indicate "0". If a minus amperage appears, there is a short circuit in the system that must be found. If no short circuit problem is indicated, remove the battery from the snowmobile and check its fluid level; then place the battery on a charger for several hours and again check its condition using a battery tester.

### Engine RPM Function



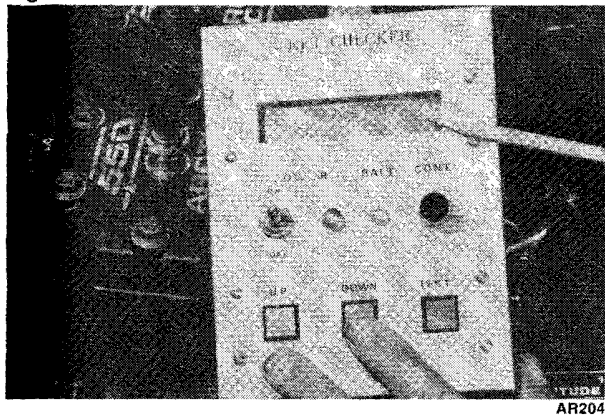
Place the rear of the snowmobile on a good safety stand.



The engine RPM test can be used to verify the snowmobile tachometer or can be used when checking several of the EFI components. When checking the RPM, use the following procedure:

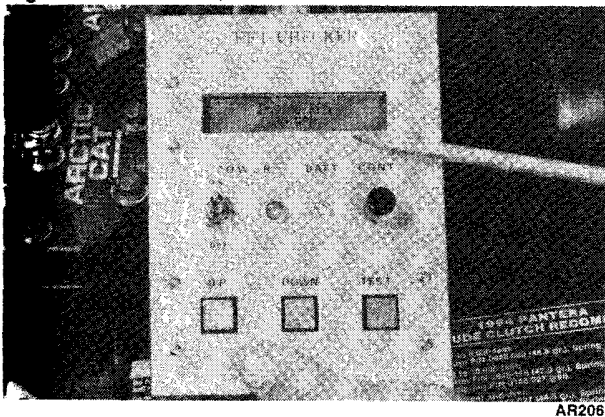
1. Connect the analyzer (in the OFF position) to the snowmobile analysis test plug.
2. Turn ON all snowmobile switches; then turn ON the analyzer. Both the snowmobile charge indicator light and the analyzer power light must illuminate. If not, find the problem using the procedures covered earlier in this section.
3. With the analyzer power light illuminated, press the MENU SELECT buttons repeatedly until "engine RPM" appears on the display.

Fig. 3-74



4. Start the engine; then press the TEST button. Actual engine RPM should now be indicated. Slowly squeeze the throttle lever and the display should indicate the increased engine RPM.

Fig. 3-75

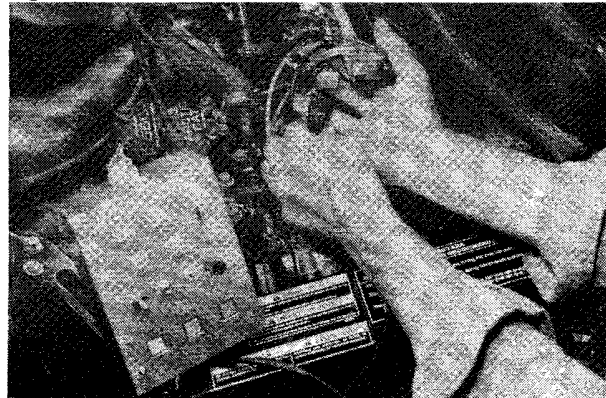


**NOTE:** If you are now going to proceed to another test, you must first press the Test button once again to cancel the present test. To select a different test function, use the MENU SELECT buttons.

## Ignition Timing Test (Snowmobile Running)

1. Place the rear of the snowmobile on a good safety stand.
2. Connect the analyzer harness (in the OFF position) to the snowmobile EFI analysis plug.

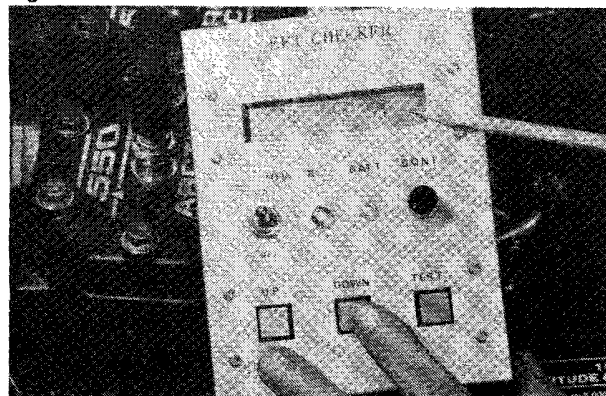
Fig. 3-76



AR208

3. Turn ON all snowmobile switches and the analyzer switch. Check to see that both the snowmobile charge indicator light on the tachometer and the analyzer power light are illuminated. If not, find the problem before proceeding.
4. With the analyzer ON, press the MENU SELECT buttons repeatedly until the words "ignition timing" appear on the display.

Fig. 3-77

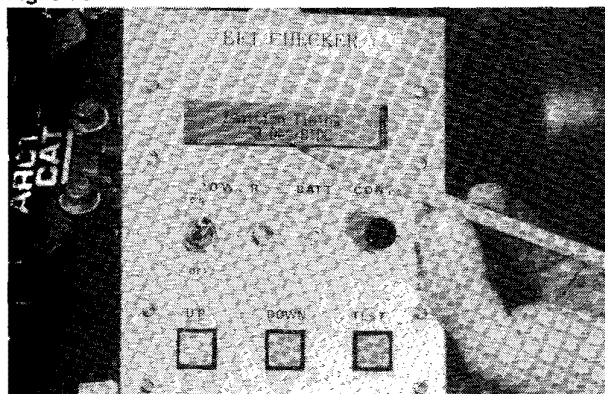


AR203

5. Start the engine and press the TEST button; then increase the engine RPM to 4000 RPM. Actual engine timing in degrees will now appear on the display.

Timing Specifications	
Degrees	@ RPM
30 ± 2	4000

Fig. 3-78



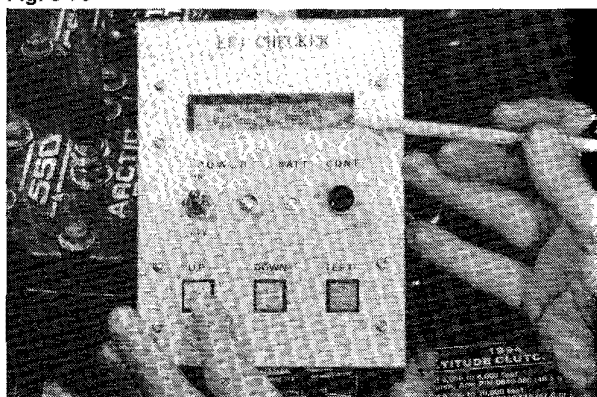
AR205

**NOTE:** Ignition timing remains the same on either a hot or cold EFI engine. Timing is not adjustable. If timing is off by more than 2 degrees, the problem may be either the timing sensor or the CDI unit.

#### Existing Problem Diagnosis Test No. 1 (Tests All Sensors Except Ignition and Timing)

1. With the analyzer in the OFF position, connect its harness to the snowmobile analysis test plug.
2. Turn ON all snowmobile switches (ignition, throttle-monitor, tether) and the analyzer switch. The power light on the analyzer and the snowmobile charge indicator light must now be illuminated.
3. Push the analyzer MENU SELECT button repeatedly until the words "Diagnosis Test 1" appear on the display.

Fig. 3-79



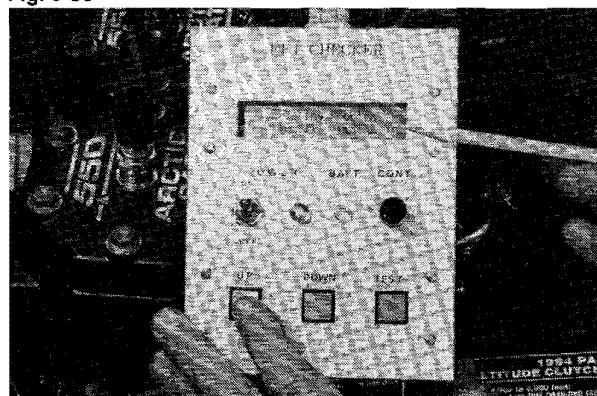
AR213

4. Push the TEST button. If all sensors are good, "sensors ok" will appear on the display. If any of the sensors listed under Existing Problem Diagnosis Test No. 1 are defective, that sensor will be indicated on the display. Proceed then to checking the defective sensor individually as covered in this section. Proceed to Existing Problem Diagnosis Test No. 2.

#### Existing Problem Diagnosis Test No. 2 (Tests Ignition and Timing Sensors)

1. With the analyzer in the OFF position, connect its harness to the snowmobile analysis test plug.
2. Turn on all snowmobile switches (ignition, throttle-monitor, tether) and the analyzer switch. Both the snowmobile charge indicator light and the analyzer power light must both be illuminated.
3. Push the analyzer MENU SELECT button repeatedly until "Diagnosis Test 2" appears on the display.

Fig. 3-80



AR210

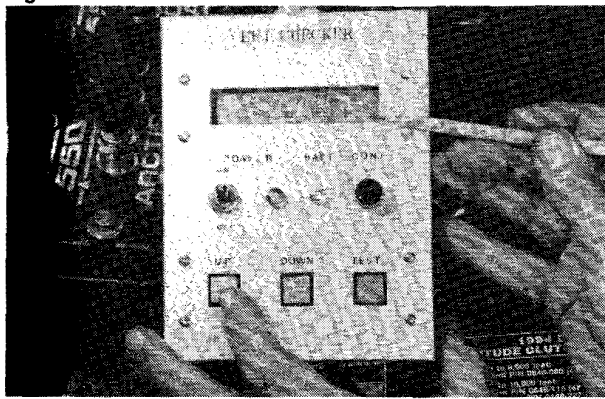


4. Push the analyzer TEST button. Next, start or crank the engine. If the sensors are good, "sensor okay" will appear on the display. If either sensor is defective, that sensor will appear on the display as not good (NG). Make necessary repairs and test again. If all sensors test good, proceed to checking Memory Problem Diagnosis Test No. 1 and 2.

### Memory Problem Diagnosis Test No. 1 and 2

1. With the analyzer in the OFF position, connect its wiring harness to the snowmobile analysis test plug.
2. Turn on the snowmobile switches (ignition, throttle monitor, tether) and the analyzer switch. The snowmobile charge indicator light and the analyzer power light must both be illuminated.
3. Push the analyzer MENU SELECT button repeatedly until "Memory Diagnosis Test 1 or 2" appears on the display.

Fig. 3-81



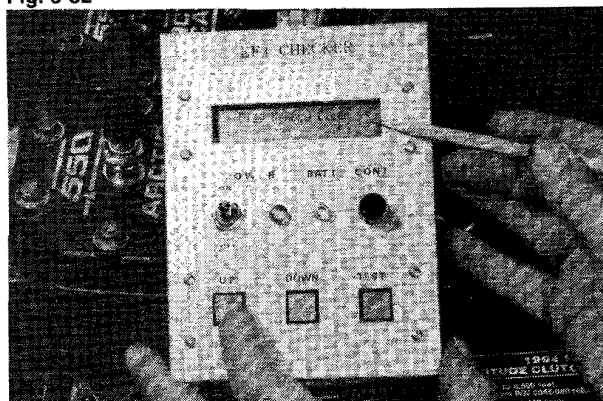
AR211

4. Push the analyzer TEST button. If there has been an intermittent problem in the sensors, that sensor will be indicated on the display. Make necessary repairs. If all sensors test good, proceed to the remaining "Memory Problem Diagnosis Test".

### Clearing Memory

1. With the analyzer attached to the analysis test plug, push the MENU SELECT button until "Diagnosis Memory Clear" appears on the display.

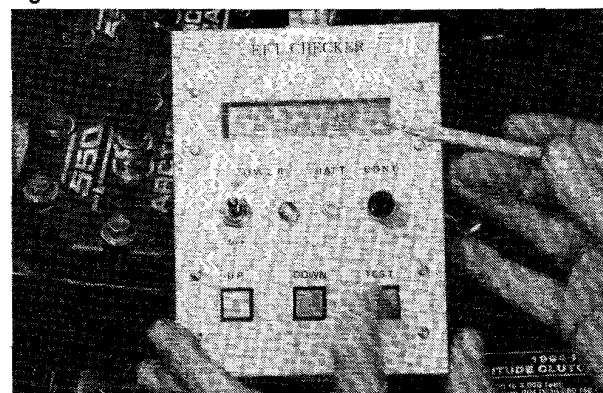
Fig. 3-82



AR209

2. Press the analyzer TEST button and the words "Please Key Off" should appear on the LCD; then turn OFF the ignition key. Turn the key back ON and the memory should now be clear.

Fig. 3-83



AR226

**NOTE:** To check if the memory is clear, perform "Memory Diagnosis Test 1 and 2" to see if all sensors test good. If a problem still remains on either memory, repeat "clearing memory" procedure.

### Throttle Valve Angle Test (Degrees)

The correct throttle valve angle is extremely important for proper engine operation. If the throttle valve angle isn't correct in the idle position, the engine may be very difficult to start "cold". If the throttle valve angle isn't correct in any of the off-idle positions, engine damage or poor performance may result because of an incorrect mixture.

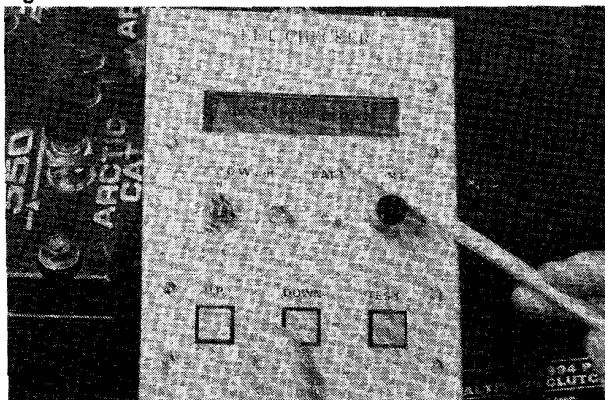
To test the throttle position sensor, use the following procedure:

**NOTE:** The engine should not be running for the first portion of the throttle valve test.

3

1. Connect the analyzer harness to the snowmobile analysis plug. Make sure the analyzer is in the OFF position.
2. Turn ON all snowmobile switches and then the analyzer switch. Both the snowmobile charge indicator light and the analyzer power light must now be illuminated. Locate the problem if either light isn't illuminated.
3. Push the MENU SELECT button on the analyzer repeatedly until "throttle valve angle (degrees)" appears on the LCD.

Fig. 3-84

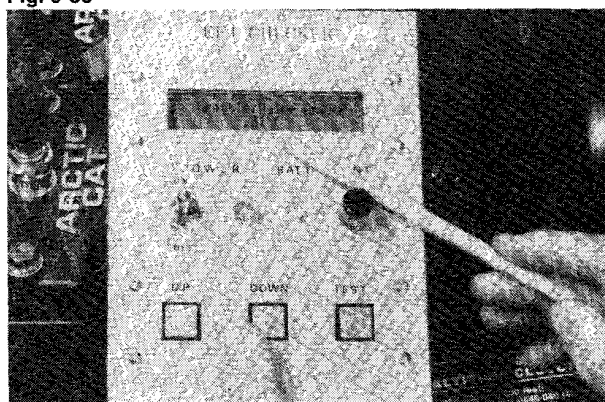


AR222

**NOTE:** When performing the Throttle Valve Angle Test, test both the idle and wide open throttle positions. Specifications are given for both positions in degrees, by model.

4. With the throttle in the "full closed" position (engine not running), push the analyzer "test" button. The throttle angle in degrees should now appear on the display.

Fig. 3-85



AR218

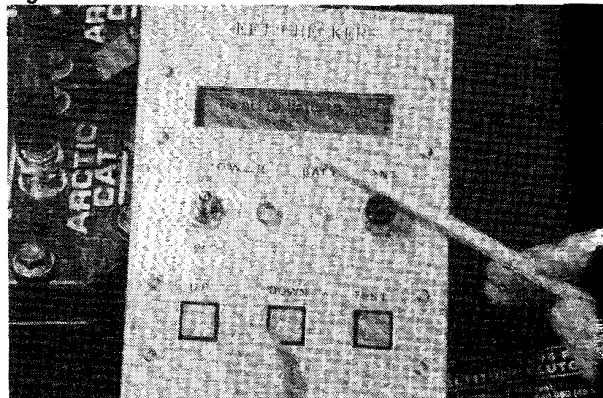
Throttle Valve Angle (Degree)	
Full Closed	Full Open
5.06° to 5.62°	75.37° to 84.93°

5. If the "full closed" throttle valve angle isn't within specifications, push down on the throttle shaft to make sure it is fully closed. If the test specification is now within tolerance, loosen the throttle cable.

**NOTE:** The Wildcat EFI models require a 0.030 in. slack in the throttle cable at the throttle lever. A tight throttle cable will cause a loss of ignition.

6. If the "full closed" test specification remains out of tolerance, adjust the idle screw. If the throttle angle cannot be corrected by either an idle screw or cable adjustment, the Throttle Position Sensor must be replaced.
7. Squeeze the throttle lever to the "full open" position. The test specification must be within the tolerance shown below Fig. 3-85. If the test specification is out of tolerance, grasp the throttle cable next to the throttle shaft and pull on the cable. If the test specification is now within tolerance, adjust the throttle cable. If the throttle angle remains out of tolerance, replace the Throttle Position Sensor.

Fig. 3-86



AR217

8. Place the rear of the snowmobile on a safety stand. Start the engine and run at the RPM indicated in the chart below. If the specifications listed below are observed during the test, the throttle sensor has failed and must be replace.



Throttle Valve Angle - Degrees	
Degrees	RPM Range
1.97	Idle to 3000 RPM
19.97	3000 to 5000 RPM
75.00	over 5000 RPM

**NOTE:** If the throttle sensor should fail, the ECU will go into the "limp home mode" and indicate the above readings at the specified RPM.

### Throttle Valve Angle (Voltage) Test

1. With the analyzer in the OFF position, connect the analyzer harness to the snowmobile analysis plug.
2. Push the analyzer MENU SELECT button repeatedly until "throttle valve angle (voltage)" appears on the display.
3. Push the TEST button and the analyzer should indicate the voltage specifications shown below. Test both the "full closed" and "full open" throttle positions.

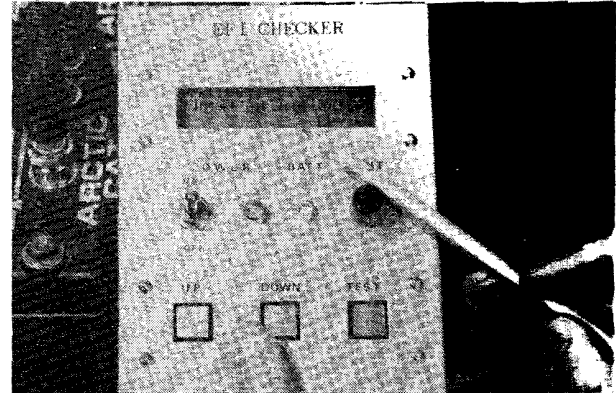
Throttle Valve Angle - Voltage	
Fully Closed (Volts)	Fully Open (Volts)
0.69 - 0.77	3.81 - 4.23

4. If either the "full-closed" or "full-open" test specifications are out of tolerance, double check to make sure the throttle is in the "full-closed" or "full-open" position by pushing or pulling on the throttle shaft. If test specifications remain out of tolerance, the throttle sensor is bad and must be replaced.

### Intake Air Temperature Sensor (Engine OFF)

1. With the analyzer in the OFF position, connect its harness to the snowmobile analysis plug.
2. Turn ON all snowmobile switches and then the analyzer switch. Both the snowmobile charge indicator light and the analyzer power light must both be illuminated.
3. Press the analyzer MENU SELECT button repeatedly until "intake air temperature in C or F" appears on the display.

Fig. 3-87



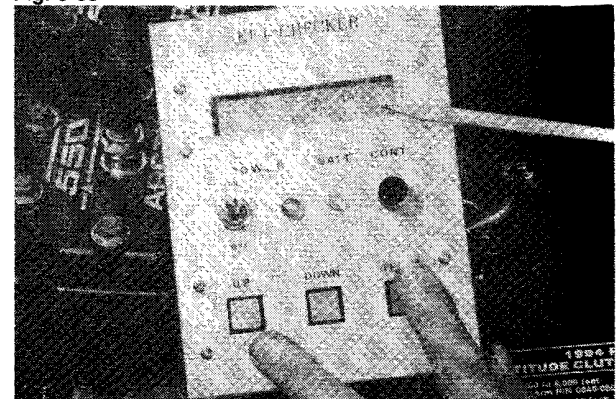
AR223

**NOTE:** You can check air temperature in either Celsius or Fahrenheit.

4. Press the analyzer TEST button and the intake air temperature will be indicated on the display in either Celsius or Fahrenheit.

3

Fig. 3-88



AR216

**NOTE:** The temperature indicated should be close to room temperature if the snowmobile hasn't recently been run. Consider what temperature the snowmobile is actually at.

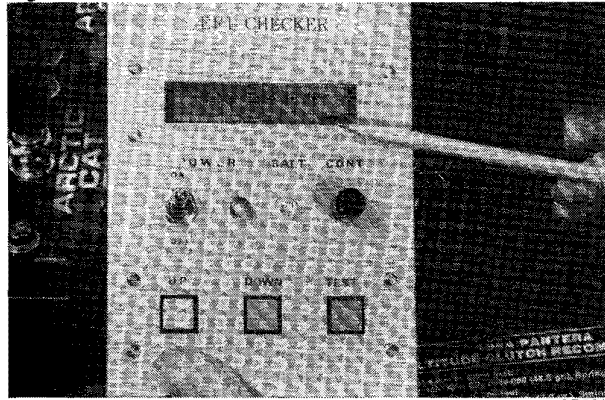
5. If when testing the air temperature sensor, you get an indicated temperature of  $-40^{\circ}\text{C}$  or  $^{\circ}\text{F}$ , and the actual snowmobile temperature isn't close to this temperature, replace the sensor. The ECU will automatically go to  $-40^{\circ}\text{C}$  or  $^{\circ}\text{F}$  when the air temperature sensor fails. See the Service Manual for replacement instructions.

### Water Temperature Sensor Test (Engine Running)

**NOTE:** Conduct the first part of the water temperature test with the engine not running.

1. Place the rear of the snowmobile on a good safety stand.
2. Attach the analyzer harness (in the OFF position) to the snowmobile analysis plug.
3. Turn ON all snowmobile switches first; then turn the analyzer switch on. Both the power indicator light on the analyzer and the snowmobile charge indicator light must now be illuminated.
4. Press the analyzer MENU SELECT button repeatedly until "water temperature in °C or °F" appears on the display.

Fig. 3-89

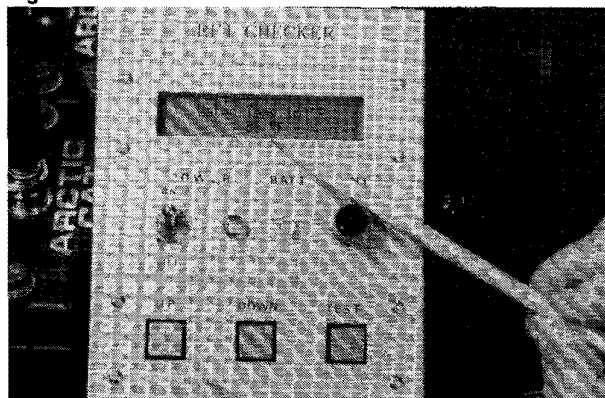


AR220

**NOTE:** The water temperature sensor can be checked in either Celsius or Fahrenheit. Perform this test on a engine that has not been run in several hours and has coolant at room temperature.

5. Press the TEST button and the display will indicate coolant temperature. If the temperature displayed doesn't seem close to the coolant temperature, the sensor should be replaced.

Fig. 3-90



AR229

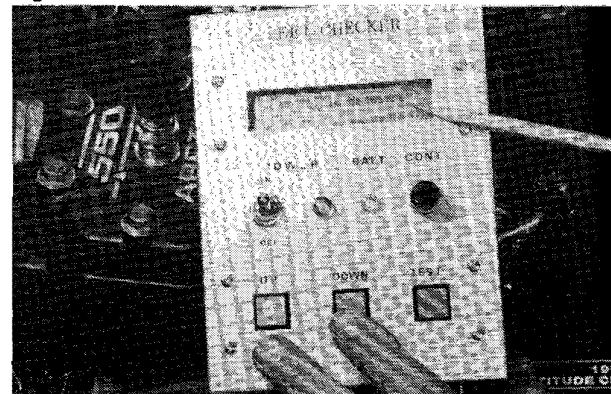
If the water temperature sensor has failed, the ECU will automatically indicate the specifications shown below for each RPM. If these specifications are indicated at the RPM shown, replace the water temperature sensor.

Celsius	Fahrenheit	RPM
0°	32°	Idle to 3000
30°	86°	3000 to 5000
60°	140°	5000 and over

### Barometric Pressure Test (Engine OFF)

1. With the analyzer in the OFF position, attach its harness to the analysis test plug (or Diagnostic Test Harness).
2. Turn ON all snowmobile switches and then the analyzer switch. The analyzer power light and snowmobile charge indicator light must both be illuminated.
3. Press the analyzer MENU SELECT button repeatedly until "barometric pressure" appears on the display.

Fig. 3-91

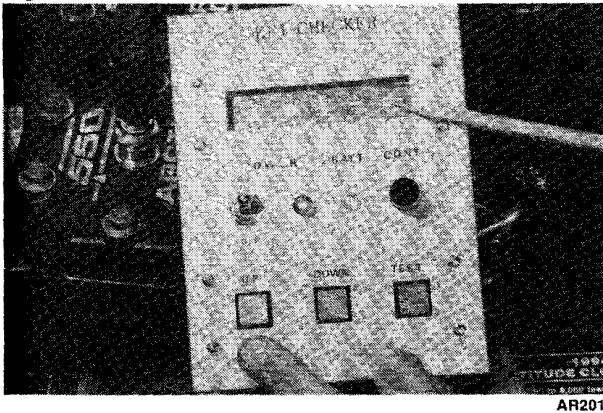


AR202

4. Press the analyzer TEST button and the display should indicate actual area barometric pressure. If you do not know what the barometric pressure is, call the local airport.



Fig. 3-92



**NOTE:** If the barometric sensor has failed, the ECU will automatically go to the barometric pressure shown below for each model. If these readings appear, replace the ECU.

Model	Barometric Pressure
1994 700 EFI	880 mmHg (34.65 in. of Hg)

## TPS (Throttle Position Sensor) Replacement Procedure

To replace the Throttle Position Sensor on the 1994 700 EFI models, follow the procedure below.

In order to complete the procedure, you will need EFI test harness (p/n 0644-181) and a good digital multimeter (p/n 0644-191).

### TPS Removal

**NOTE:** It is important that the throttle shaft is completely closed for this procedure.

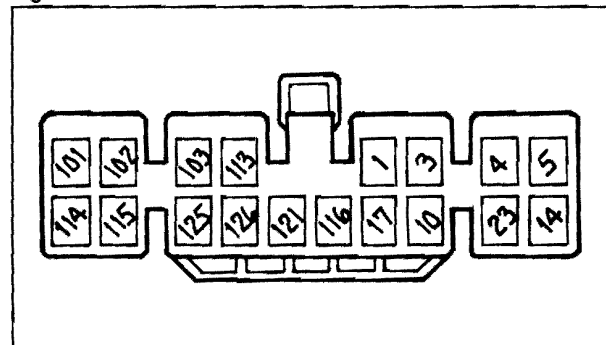
1. Disconnect the throttle cable from the throttle shaft.
2. Rotate the idle screw counterclockwise until it no longer contacts the throttle shaft stop. The throttle shaft should now be completely closed. Open the throttle shaft by hand and release it, allowing the shaft to snap closed several times.

3. Disconnect the TPS wiring harness from the main harness; then remove the two screws securing the TPS to the throttle body housing and remove the sensor.

### TPS Installation

1. Apply a light coat of silicone grease to the area around the outside of the TPS flange.
2. Install the new TPS onto the throttle shaft by aligning its "flat" with the throttle shaft "flat".
3. Install the two screws, flat washers, and lock washers securing the sensor to the throttle body. Do not tighten at this time.
4. With all switches in the OFF position, disconnect the main harness from the ECU and insert the EFI Test Harness (p/n 0644-181) between the ECU and main harness.
5. Connect the TPS wiring harness to the main harness.
6. Set the digital voltmeter on the DC voltage scale; then touch its leads to pins 3 and 17 and turn on the snowmobile switches.

Fig. 3-93



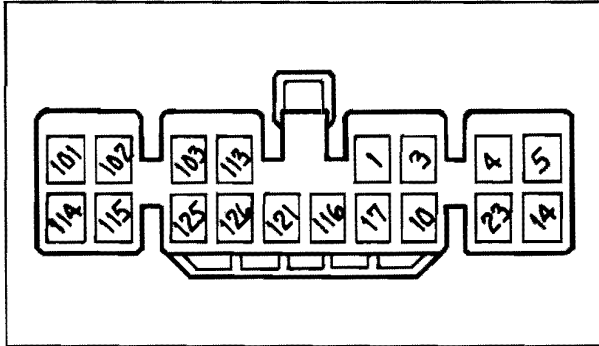
0729-602

7. While observing the digital voltmeter, slowly rotate the sensor until .538 volts is observed on the LCD (Liquid Crystal Display) of the multimeter. While holding the sensor in this position, tighten the two screws securely, which secure the sensor to the throttle body.
8. Gently snap the throttle open and closed several times to check the TPS voltage. If it has changed from the .538 specification, loosen the two screws which secure the sensor and make necessary adjustments.
9. Connect the throttle cable to the throttle shaft.

3

- Rotate the idle screw clockwise until it contacts the throttle shaft stop. Using the digital multimeter and test harness, test between pins 3 and 17. While making contact with these two pins, continue to rotate the idle screw inward until the correct specification for the model being worked on is observed.

Fig. 3-94



0729-602

#### Closed Position

700 EFI	0.69 to 0.74 volts
---------	--------------------

- With the idle position set to the above specification, squeeze the throttle lever to the wide open position. The following specification should be observed. Gently snap the throttle lever open and closed several times and note if the reading remains within the specifications.

#### Wide Open Position

700 EFI	3.81 to 4.23 volts
---------	--------------------

If there are any questions concerning the above procedure, please contact the Service Department.

**NOTE:** If, after adjusting the Throttle Position Sensor to the "CLOSED POSITION" specification, you find that the "WIDE OPEN POSITION" is less than 3.81 volts, recheck your "CLOSED POSITION" setting. If the "CLOSED POSITION" setting is correct, replace the sensor.

## Throttle Body Flange

### REMOVING

#### CAUTION

To avoid damage to electrical components, all switches must be in the OFF position and the battery disconnected before servicing any EFI electrical component. The negative cable must be disconnected first.

- Loosen the clamps securing the throttle body assembly to the throttle body flanges.
- Remove the throttle body from the flanges.
- Disconnect clamp securing the balance hose to the flange and remove the hose from the flange(s).
- In turn on each flange, remove the two nuts, lock washers, and flat washers securing the intake flange to the cylinder; then remove the flange.

### INSTALLING

- Apply a thin coat of high temperature silicone to the cylinder side of each intake flange; then attach each intake flange to a cylinder and secure each with two flat washers, lock washers, and nuts. Torque to 1.5-1.9 kg-m (11-14 ft-lb).
- Secure the balance hose to the flange(s) using clamp(s).
- Install the flange clamps on the flanges; then place the throttle body into the flanges and secure with the clamps.
- Secure all wires and hoses with cable ties.
- Connect the battery.

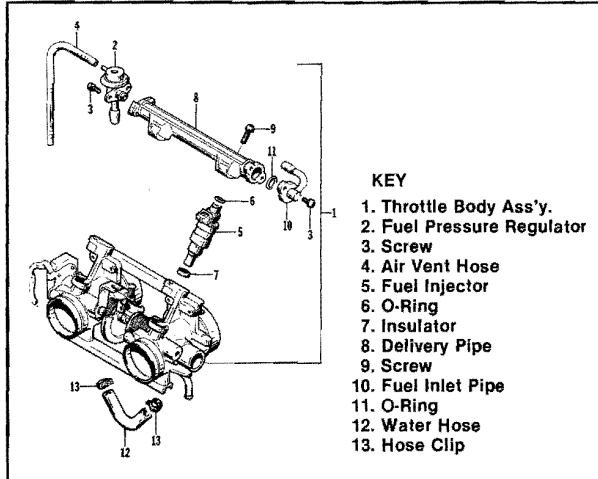
#### CAUTION

The positive cable must be connected first.



# Throttle Body

Fig. 3-95



0729-759

## REMOVING

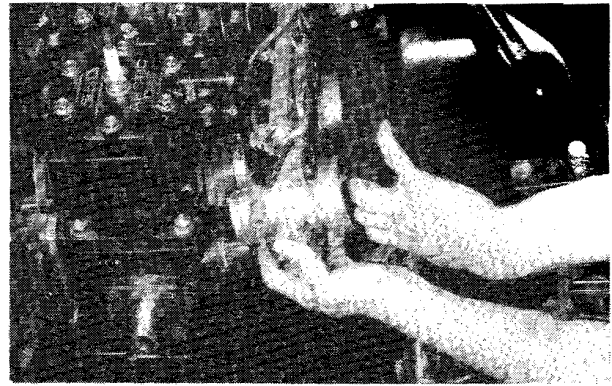
1. Disconnect the negative battery cable from the battery.
2. Remove the driven pulley.
3. Disconnect the wiring harness from each injector, the throttle valve sensor, and throttle body temperature sending unit.
4. Remove the coolant hose from the PTO-side of the throttle body and plug.
5. Remove the fuel return and supply hoses from the fuel pressure regulator and fuel rail. Label for assembly.

### **CAUTION**

Since the fuel supply hose may be under pressure, remove it slowly to release the pressure. Place an absorbent towel around the connection to absorb fuel.

6. Loosen the flange clamps
7. Slide the throttle body out of the flanges; then loosen the jam nut securing the throttle cable and remove.
8. Remove the throttle body.

Fig. 3-96



AR113

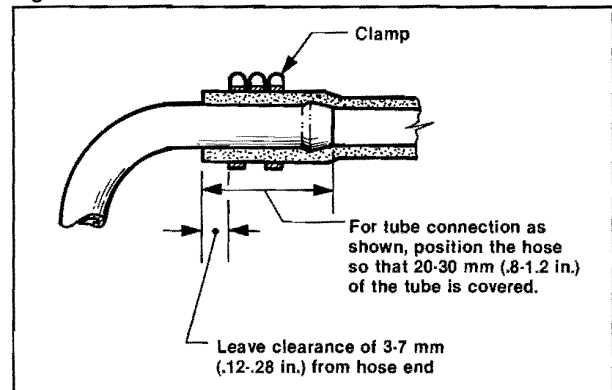
## INSTALLING

1. Attach the throttle cable to the throttle body. Secure with jam nut.
2. Place the throttle body into position. Make sure the flanges and boots are positioned properly. Secure with flange clamps.
3. Secure the fuel supply and return hoses to the fuel rail and regulator.

### **CAUTION**

These hoses must be connected to the correct fittings.

Fig. 3-97



0729-325

4. Secure the coolant hose to throttle body.
5. Connect the wiring harness to each injector, the throttle valve sensor, and throttle body temperature sending unit.
6. Connect the negative battery cable to the battery.

3

7. Install the driven pulley.
8. Place the rear of the snowmobile on a shielded safety stand. Turn the key to the ON position and listen for the fuel pump. It will run for approximately five seconds and then stop. Turn the key OFF then ON again. Repeat this procedure five or six times to fill the system with fuel.
9. With the key in the ON position start the engine without touching the throttle. It may idle slowly and stop. Restart using the same procedure until the engine starts and builds RPM's on its own.

 **WARNING**

**Check all hose connections for leakage. Repair as necessary.**

10. Check the cooling system.
11. Adjust the throttle cable, as necessary.

## Throttle Cable

### REMOVING

1. Open the clutch shield and remove the belt.
2. Remove the driven pulley (see Removing Driven Pulley section).
3. Remove the E-clip securing the oil-injection cable to the control arm. Account for a washer.
4. Loosen the oil-injection cable jam nuts.
5. Loosen the throttle cable jam nuts.
6. Remove the throttle cable from the throttle body assembly.
7. Remove the handlebar pad.
8. Remove the cable ties securing the throttle cable.
9. Remove the throttle cable end from the throttle lever.

10. Remove the retaining ring securing the cable to the throttle switch assembly; then remove the cable from the throttle switch assembly.

### INSTALLING

1. Install the throttle cable into the throttle switch assembly. Secure with a retaining ring.
2. Install the throttle cable end on the throttle lever.
3. Route the throttle cable from the throttle switch assembly to the throttle body assembly and oil pump; avoid any sharp bends or moving parts.
4. Attach the throttle cable to the throttle body.
5. Install the oil-injection adjustment cable on the oil pump; secure with the jam nuts.
6. Install the oil-injection cable on the control arm; secure with a washer and E-clip.
7. Secure the throttle cable to the steering post with cable ties.
8. Install the handlebar pad.
9. Adjust the throttle cable by turning the jam nuts in the appropriate direction until there is 0.030 (the width of a credit card) free play in the throttle lever and the butterfly completely opens and closes. Tighten the jam nuts securely.

 **CAUTION**

**Compress the throttle control lever to ensure free movement. If the throttle cable sticks or binds, correct the problem before starting the snowmobile.**

10. Synchronize the oil-injection pump (see Synchronizing Oil-Injection Pump section).
11. Install the driven pulley (see Installing Driven Pulley section).
12. Install the belt and close the clutch shield.

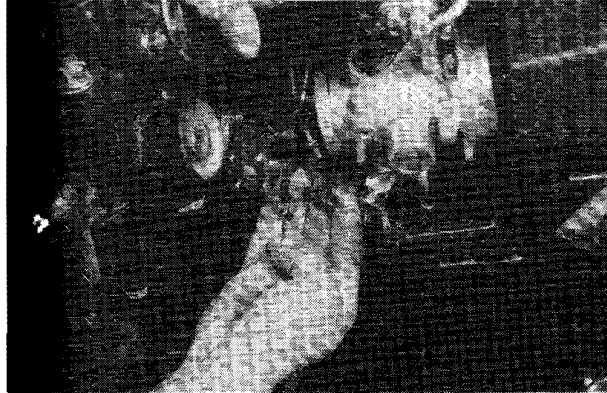
## Removing Oil-Injection Pump

1. Remove the driven pulley (see Removing Driven Pulley section).



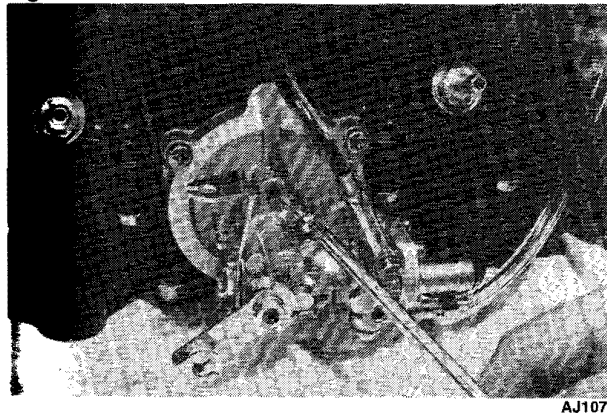
2. Remove the throttle body (see Removing Throttle Body section).
3. Remove the E-clip and washer securing the oil-injection cable to the actuator arm; then loosen the jam nuts securing the cable adjuster to the oil-injection pump.

Fig. 3-98



4. Disconnect the oil-supply hose from the pump and plug to prevent oil drainage.
5. Remove the two screws, lock washers, and washers securing the oil-injection pump and retainer to the crankcase.

Fig. 3-99



6. Remove the two oil-injection hoses.
7. Remove the oil-injection pump and account for a gasket.

## Installing Oil-Injection Pump

1. Place the O-ring and oil-injection pump into position making sure the oil-injection pump gear is correctly aligned with the oil-injection pump drive gear.

### ⚠ CAUTION

Be sure the gear is properly aligned with the slot of the oil-injection pump shaft.

2. Secure the pump with two screws, lock washers, and washers. Tighten screws to 0.7 kg-m (5 ft-lb).

### ⚠ CAUTION

The short mounting bolt must be installed in the upper oil pump mounting hole or bearing damage will result.

3. Connect the oil-injection cable to the oil-injection pump actuator arm and secure with the washer and E-clip.
4. Connect the two hoses to the oil-injection pump fittings. Secure with clamps.
5. Connect the oil-supply hose to the oil-injection pump inlet fitting. Secure with the clamp.
6. Bleed the oil-injection system (see Bleeding Oil-Injection System section).
7. Check the oil-injection system synchronization (see Synchronizing Oil-Injection Pump section). Tighten the jam nuts securely.
8. Install the throttle body (see Installing Throttle Body section).
9. Install the driven pulley (see Installing Driven Pulley section).
10. Install the belt and secure the clutch shield.

3

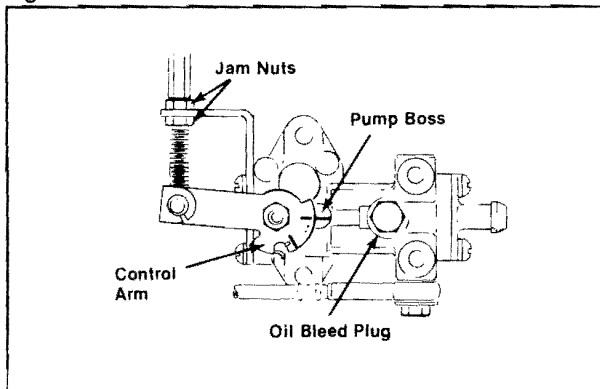
## Synchronizing Oil-Injection Pump

### CHECKING

To check the oil-injection system synchronization, use the following procedure:

1. With the ignition switch key in the OFF position, move the throttle lever to the wide-open-throttle position.
2. Check the alignment of the mark on the pump housing and the mark on the control arm. If the marks align, the oil-injection system is synchronized with the throttle body and no adjustment is necessary. If the marks do not align, adjust synchronization.

Fig. 3-100

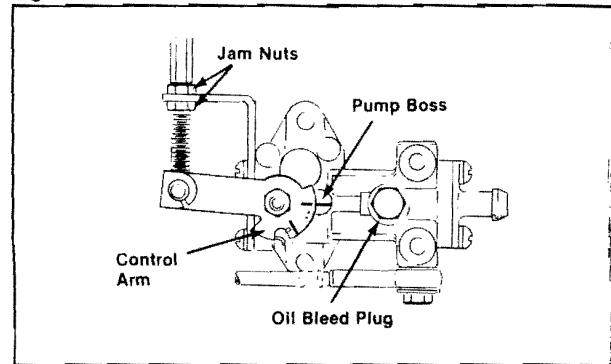


### ADJUSTING

To adjust the oil-injection system synchronization, use the following procedure:

1. Loosen the jam nuts securing the oil-injection cable.
2. Move the throttle lever to the wide-open-throttle position.
3. Rotate the jam nuts in the proper direction until alignment is achieved.
4. Lock the jam nuts to secure adjustment.

Fig. 3-101



## Bleeding Oil-Injection System

1. Fill the oil reservoir with Arctco 50:1 Injection Oil.
2. Place an absorbent towel below the oil-injection pump bleed screw; then remove the bleed screw from the pump. Allow the oil to flow through the oil-supply hose until the hose is filled with oil and free of air; then install the bleed screw. Tighten securely.

**NOTE:** To aid in bleeding the system, blow into the vent line to force the oil toward the pump. The oil tank cap must be on for this procedure.

3. Using a shielded safety stand, raise the rear of the snowmobile off the floor. Secure the parking brake. Start the engine and allow it to idle.
4. Using a stiff wire with a hooked end, pull the control arm upward to the wide-open position.

### WARNING

Keep hands and clothing away from all moving or rotating parts.

5. Idle the engine until the oil flows to the top of the oil delivery hoses free of air bubbles.
6. When the oil flows free of all air bubbles, shut the engine off.
7. Release the parking brake and check for leakage.



## Testing Oil-Injection Pump

In the event there is an engine failure due to lack of lubrication, the oil-injection pump should be tested using the Oil-Injection Usage Tool (p/n 0644-007) to ensure the oil-injection pump is operating properly.

### WARNING

Always wear safety glasses when performing this test.

1. Tighten the oil cap on the oil tank securely. Attach the Vacuum/Pressure Test Pump (p/n 0644-131) to the oil tank vent line; then create vacuum in the tank.
2. Place an absorbent towel under the oil tank supply hose fitting; then remove the oil supply hose from the oil tank. Plug the fitting with the red plug.
3. Fill the Oil Injection Tool (p/n 0644-007) with Arctco 50:1 Injection Oil to the "0" line.
4. Wipe the tip of the oil injection tool to remove excess oil; then attach the tool to the oil supply hose and remove the bulb.
5. Secure the tool to the oil tank by twisting the rubber strap one half turn and placing the rubber strap around the injection tool and the oil tank filler neck.

### WARNING

Keep hands and clothing away from all moving parts.

6. Start the engine. Run the engine at 3000 RPM for 3 minutes with the control arm in the full-closed position. Check the amount of oil used with the specifications on the chart.
7. Using a stiff wire pull the oil-injection control arm to the full-open position. Run the engine at 3000 RPM for 2 minutes. Check the amount of oil used with the specifications on the chart.

### OIL CONSUMPTION

FULL-CLOSED @ 3 Minutes	FULL-OPEN @ 2 Minutes
2.0-5.3 cc	12.1-17.7 cc

8. If the oil-injection pump does not meet the specifications, see Testing Oil-Injection Check Valve section.
9. Disconnect the oil usage tool, remove the plug, attach the oil supply hose to the oil tank and secure with a clamp. Remove the vacuum pump.
10. If any air bubbles are present in the oil supply hose, bleed the oil-injection system (see Bleeding Oil-Injection System section).

## Testing Oil-Injection Check Valves

In the event there is an engine failure due to lack of lubrication, the oil-injection pump check valves should be checked using a vacuum pump to make sure the valves are operating properly.

When testing the check valves, you must remove them from the oil-injection pump body and follow this test procedure:

1. Remove the check valves from the oil-injection pump.
2. Attach the Vacuum Pump Hose (p/n 0644-131) to the check valve.
3. Squeeze the vacuum pump handle and keep a close watch on the pump gauge. The check valve should release at 4.5-5 lb and again set itself at 3.5-4 lb. If not within specifications, replace the check valve.
4. Write down the readings and perform the same test on the remaining check valves. Both the release and hold readings must be within 1.5 lb of each other. If not within specifications, replace the check valves.
5. If the check valves are within specifications; replace the oil pump (see Removing Oil-Injection Pump section).
6. Bleed the oil-injection system; then retest oil-injection pump.

3

## Basic EFI System Information

Item		Description	
Basic system	Fuel supply system	Electronically controlled multi-point injection	
	Ignition system	(CDI system) Digital	
Air/fuel flow meter	System	O/N (throttle opening/engine revolution) system & atmospheric pressure compensation	
	Component parts	Throttle opening sensor Atmospheric pressure sensor	
Injection system		One time simultaneous injection per revolution (synchronized ignition)	
Fuel system	Fuel pressure	Regulated high pressure 36.2 psi (2.55 kg/cm <sup>2</sup> )	
	Fuel return	Pressure regulated by pressure regulator. There are fuel returns.	
Throttle system	System	1 stage x duplex (1 bore/cylinder)	
	Diameter of the bore	46 x 2 (Effective area equivalent to 40)	
	Type of valve	Butterfly type	
	Operating angle	80° (full closed angle 10°)	
	Radius of drum	R25 (at wire center)	
Adjusting system for idle revolution		Throttle adjusting screw type	
Component parts and specifications	Control unit		Fuel injection control
	Fuel system	Fuel pump	Gear type
		Injector	Top feed type
		Pressure regulator	Diaphragm type
		Fuel filter	Fine screens on pick-up hose
		Fuel piping	High pressure specification 36.2 psi (2.55 kg/cm <sup>2</sup> )
	Throttle body		1 bore/cylinder x duplex
	Sensor, ect.	Throttle sensor	Revolution scrubbing type potentiometer
		Pressure sensor	Semiconductor type
		Water temperature sensor	Thermistor type
		Intake air temperature sensor	Thermistor type
	Cable harness		Equivalent to current harness
	Other		Dropping resistor



## EFI Component Resistance/Voltage Temperature Chart

TEMP/C	VOLTAGE	TEMP/F	OHMS
100	0.812	212	190
98	0.847	208	201
96	0.883	205	213
94	0.921	201	224
92	0.960	198	236
90	1.002	194	247
88	1.045	190	263
86	1.090	187	278
84	1.137	183	294
82	1.187	180	309
80	1.239	176	325
78	1.293	172	347
76	1.350	169	368
74	1.409	165	390
72	1.471	162	411
70	1.535	158	433
68	1.601	154	466
66	1.669	151	500
64	1.739	147	533
62	1.811	144	567
60	1.886	140	600
58	1.962	136	648
56	2.039	133	696
54	2.118	129	744
52	2.199	126	792
50	2.280	122	840
48	2.363	118	908
46	2.446	115	976
44	2.531	111	1044
42	2.615	108	1112
40	2.700	104	1180
38	2.785	100	1284
36	2.870	97	1388
34	2.955	93	1492
32	3.039	90	1596
30	3.123	86	1700

TEMP/C	VOLTAGE	TEMP/F	OHMS
28	3.206	82	1933
26	3.288	79	2065
24	3.368	75	2206
22	3.448	72	2359
20	3.526	68	2524
18	3.602	64	2706
16	3.676	61	2906
14	3.749	57	3128
12	3.819	54	3376
10	3.887	50	3653
8	3.952	46	3965
6	4.016	43	4316
4	4.076	39	4712
2	4.134	36	5159
0	4.190	32	5664
-2	4.242	28	6234
-4	4.292	25	6877
-6	4.339	21	7601
-8	4.383	18	8416
-10	4.425	14	9330
-12	4.464	10	10355
-14	4.450	7	11502
-16	4.533	3	12782
-18	4.565	-0.4	14207
-20	4.593	-4	15795
-22	4.620	-8	17554
-24	4.645	-11	19502
-26	4.668	-15	21655
-28	4.689	-18	24029
-30	4.709	-22	26642
-32	4.728	-26	29513
-34	4.747	-29	32660
-36	4.765	-32	36104
-38	4.783	-36	39867
-40	4.802	-40	43971

# SECTION 4 - DRIVE SYSTEM

## TABLE OF CONTENTS

Drive Belt . . . . .	90
Specifications . . . . .	90
Drive Clutch . . . . .	90
Specifications . . . . .	90
Changing Cam Arms . . . . .	90
Removing . . . . .	91
Disassembling . . . . .	91
Cleaning . . . . .	93
Inspecting . . . . .	93
Assembling . . . . .	95
Installing . . . . .	96
Driven Pulley . . . . .	97
Specifications . . . . .	97
Removing . . . . .	97
Disassembling . . . . .	98
Cleaning . . . . .	99
Inspecting . . . . .	99
Bearings . . . . .	100
Removing . . . . .	100
Installing . . . . .	101
Installing . . . . .	103
Drive Clutch/Driven Pulley . . . . .	103
Checking Parallelism/Offset . . . . .	103
Correcting Offset . . . . .	104
Adjusting Center-To-Center Distance . . . . .	104
Drive Belt Deflection . . . . .	104
Drive Train . . . . .	105
Disassembling . . . . .	105
Cleaning and Inspecting . . . . .	107
Assembling . . . . .	108
Hydraulic Brake . . . . .	112
Checking Brake Lever Travel . . . . .	112
Brake Fluid . . . . .	112
Checking and Adding Brake Fluid . . . . .	112
Changing Brake Fluid . . . . .	112
Bleeding Brake System . . . . .	113
Checking and Changing Brake Pads . . . . .	114
Caliper . . . . .	115
Removing . . . . .	115
Disassembling . . . . .	116
Cleaning and Inspecting . . . . .	116
Assembling . . . . .	117
Installing . . . . .	117



## Drive Belt

The belt dimensions and construction are two factors that influence the performance of the drive system. The two belt dimensions that are important to the performance of the snowmobile are the outside circumference and the width. Both of these dimensions will influence shifting characteristics.

If the drive belt is longer than specified, the drive clutch and driven pulley will not have the full shift ratio. Also, a too-long drive belt will cause poor acceleration and a decrease in top speed.

If the drive belt is shorter than specified, the drive clutch and driven pulley will have a different shift pattern because they are in different ratios than those for which they were originally matched. A too-short drive belt will cause a loss in performance and a bog on engagement.

### CAUTION

Because of the new drive belt construction, a newly installed drive belt (p/n 0627-008) must be broke-in for 15 to 20 miles. During the break-in period, do not use full throttle. Vary the throttle position, but do not use full throttle until you have a minimum of 15 miles on the new belt.

**NOTE:** A drive belt that is worn thin may produce the same effect as one that is too long.

Drive belt construction has an influence on the way the drive clutch and driven pulley will shift, and on the amount of power that will be transmitted through the system. ONLY ARCTCO ARCTIC CAT DRIVE BELTS SHOULD BE USED. Different brands of belts may not have the same construction causing either more friction or more slippage when the belt is wedged between the sheaves and, thus, a loss of efficiency.

**NOTE:** A stiff belt causes a HP loss to the track. As a belt warms up, it gets more flexible and transmits power with less HP loss.

## SPECIFICATIONS

p/n		0627-011
Outside Circumference (Range)	cm (in.)	115.7-116.6 (45 9/16-45 15/16)
Width (Range)	mm (in.)	34-36 (1 11/32-1 13/32)

## Drive Clutch

## SPECIFICATIONS

Clutch p/n		0725-121
Cam Arm	0-4000 ft 4000-10,000 ft over 10,000 ft	0646-117 (53.0 g) 0646-102 (50.5 g) 0646-031 (48.5 g)
Spring	(0-4000 ft) Color p/n (over 4000 ft) Color p/n	Red 0646-083 Yellow/Green 0146-526
Engagement RPM		3200-3600
Peak RPM		8100-8300
Offset Measurement	mm (in.)	34.7 (1.365)
Center-to-Center Distance	cm (in.)	28.9 (11.375)

**NOTE:** Operating the Wildcat EFI - Wildcat Mountain Cat EFI above 4000 feet requires installing a 20T sprocket (p/n 0602-456) and a 39 tooth lower sprocket (p/n 0602-451) along with a 70P chain (p/n 0602-449). For drive clutch changes on either model, refer to the above chart.

## CHANGING CAM ARMS

The cam arms on the Comet clutch can be changed without disassembling the clutch. To change the cam arms, use the Comet Compressor Kit (p/n 0644-123) and the following procedure:

1. Open the clutch shield and remove the drive belt.
2. Insert the clutch compressor lever into the clutch (between the movable sheave and spider) and down to the stationary sheave shaft.

3. Push the lever forward; then lock the clutch in the engaged position with the retainer. Be sure to push the retainer fully onto the sheaves; then remove the lever.

### ⚠ WARNING

Never reuse the lock nuts on the cam arm pins. Also, when installing new lock nuts, always use Red LOCTITE STUD N' BEARING MOUNT on the nut threads.

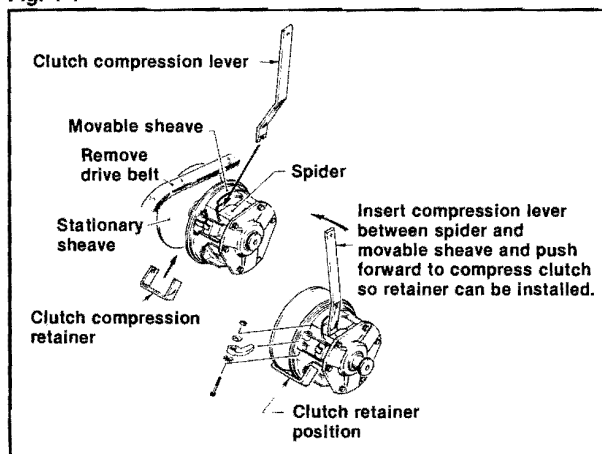
4. Change the cam arms and secure with new lock nuts making sure the head of each bolt is positioned toward the direction of rotation.
5. Insert the lever back into the clutch, compress the clutch, and remove the retainer.

### ⚠ WARNING

Do not run the engine with the drive belt removed or the retainer on the clutch.

6. Install the drive belt and secure the clutch shield.

Fig. 4-1



0728-853

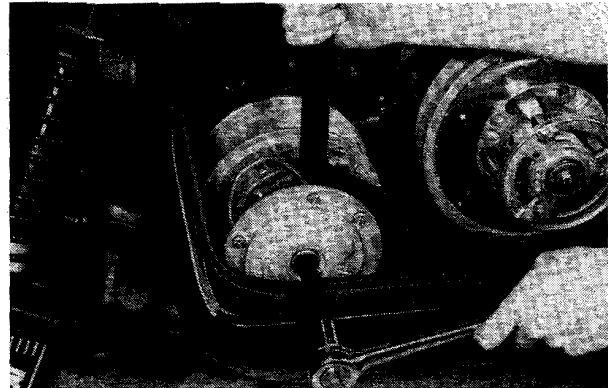
## REMOVING

1. Open the clutch shield and remove the drive belt.
2. Remove the retainer plug and washer; then using a 1/2 in. 12-point socket, remove the clutch bolt and lock washer.

**NOTE:** To install the socket, bend the side of the belly pan inward and down until the end of the drive clutch shaft is exposed.

3. Using the Comet Drive Clutch Puller (p/n 0644-096) and an impact wrench (or a breaker bar and Comet Spanner Wrench (p/n 0644-136)), tighten the puller. If the drive clutch will not release, sharply strike the head of the puller. Repeat step until clutch releases.

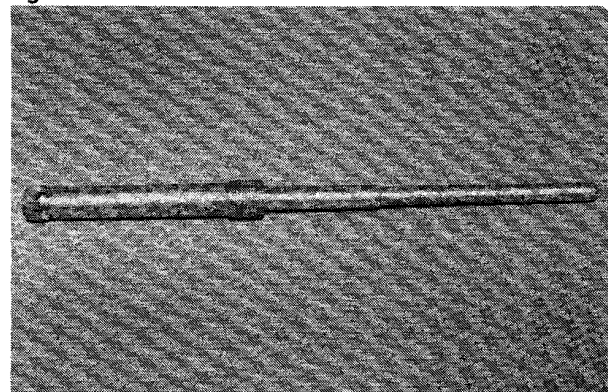
Fig. 4-2



AM055

**NOTE:** Before installing the clutch puller, apply oil to the threads of the puller and a small amount of grease to the tip of the puller.

Fig. 4-3



AE084

4. Remove the clutch from the engine compartment. Account for two sleeves found in the drive clutch mounting bore.

## DISASSEMBLING

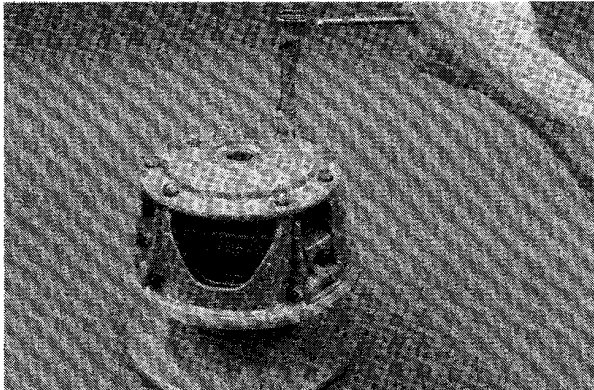
1. Scribe a line across all components.

**NOTE:** Using a marking pen, mark the location of the cover plate, spider and movable sheave for assembly purposes. These components must be assembled in the same location for proper balance.



- Loosen the six cap screws securing the cover plate. Remove every other cap screw and lock washer from the cover plate; then while firmly holding the cover plate, remove the three remaining cap screws and lock washers equally.

Fig. 4-4

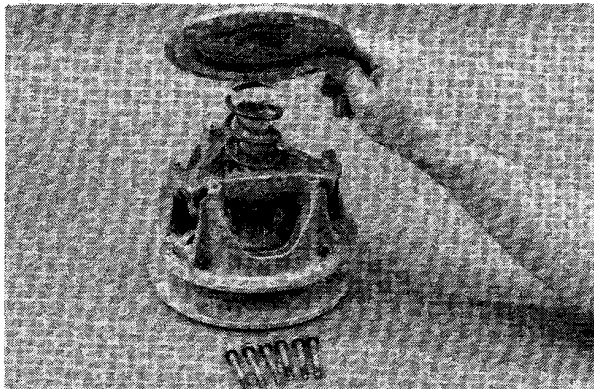


AM043

**NOTE:** If the original drive clutch cover plate is going to be replaced with a new cover plate, the new cover plate must be installed in the exact position as the original cover plate in relationship to the movable sheave. Before removing the original cover plate, note which button tower of the movable sheave the words ARCTIC CAT on the cover plate are nearest to. Mark the tower with a marking pen for assembly purposes.

- Remove the cover plate and spring.

Fig. 4-5



AM044

- Position the drive clutch over the Comet Clutch Holder (p/n 0644-058).

**NOTE:** The holder should be secured either in a vise or bolted to a sturdy work bench.

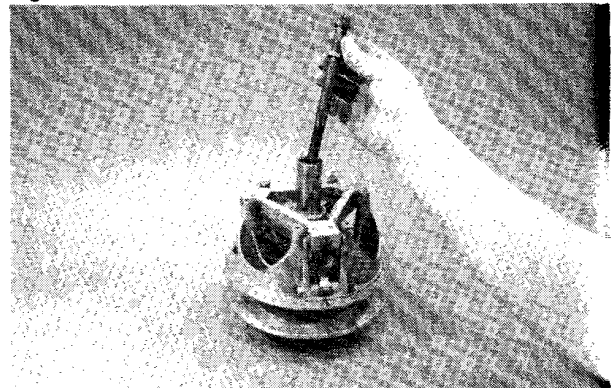
Fig. 4-6



AM001

- Secure the drive clutch to the holder using the clutch bolt and washer.

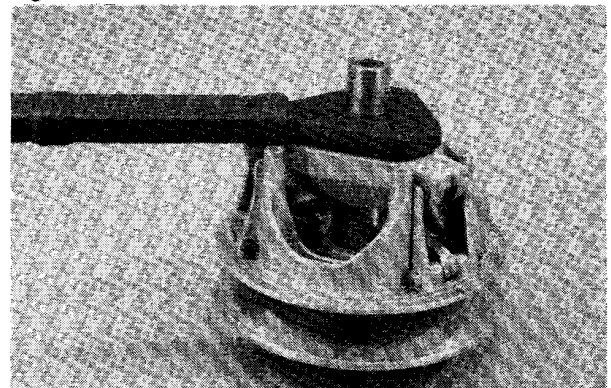
Fig. 4-7



AM101

- Using a small torch, heat the threaded area of the aluminum spider. Place the breaker over the heated spider and break spider loose by turning it counterclockwise.

Fig. 4-8



AM013

**NOTE:** Applying heat to the clutch threaded area will aid in clutch disassembly. The heat will loosen the LOCTITE used during assembly.



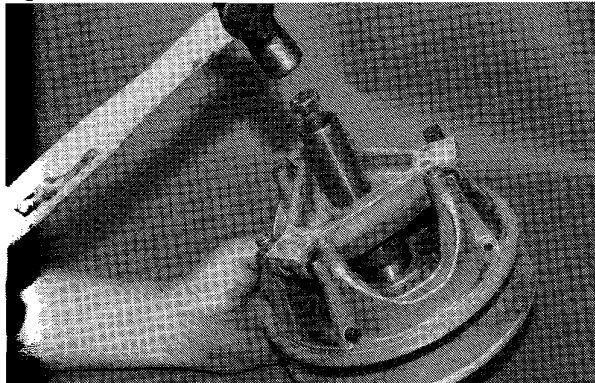
**⚠ WARNING**

Care must be taken when handling clutch components after they have been heated.

7. Remove the drive clutch from the clutch holder using the Comet Clutch Puller and the same procedure for pulling the drive clutch from the engine.

**NOTE:** If you have mounted the holder in a vise, the clutch may be removed from the holder by loosening the puller bolt 1/8 to 1/4 in., and while holding the drive clutch up off the bench, strike the end of the bolt sharply with a hammer. Repeat this procedure until the holder drops free of the taper.

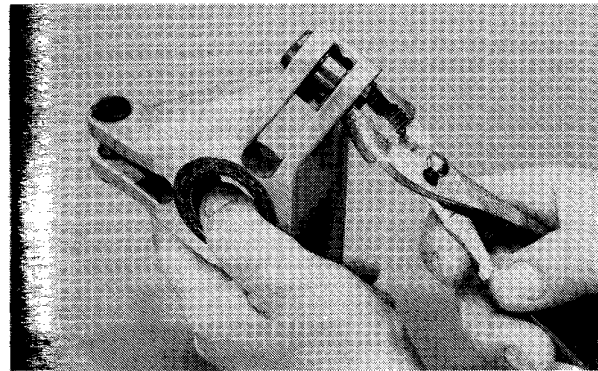
Fig. 4-9



AM042

8. Remove the spider, spacer rings, and movable sheave.
9. Using a pair of pliers, remove the six guide buttons.

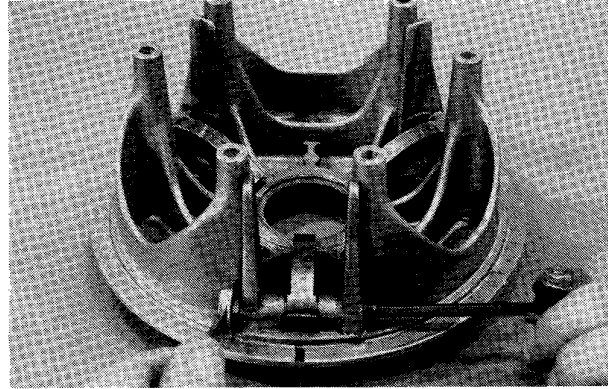
Fig. 4-10



AM027

10. Using a punch, push each pin from the roller. Account for two thrust washers (one on either side of each roller).
11. Remove the three arm pins and nuts securing the cam arms to the movable sheave; then remove the cam arms with washers.

Fig. 4-11



AM034

## CLEANING

1. Using parts-cleaning solvent, wash grease, dirt, and foreign matter off all parts; dry with compressed air.
2. Remove any drive belt dust accumulation from the stationary sheave, movable sheave, and bushing using parts-cleaning solvent only.

**⚠ CAUTION**

Do not use steel wool or a wire brush to clean components having a bushing; damage will result.

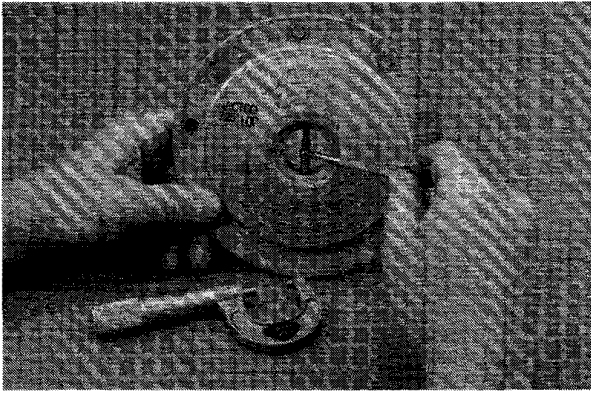
## INSPECTING

**NOTE:** Whenever a part is worn excessively, cracked, defective, or damaged in any way, replacement is necessary.

1. Inspect stationary sheave, movable sheave, spider, and cover plate for cracks or imperfections in the casting.
2. Inspect the arm pins for wear or bends.
3. Inspect the bushing in the cover plate for wear, damage, or cracks. Measure the inside diameter of the bushing and the outside diameter of the stationary sheave hub. The difference (clearance) must be less than 0.76 mm (0.030 in.). If the cover plate bushing is not within specifications, replace the plate.

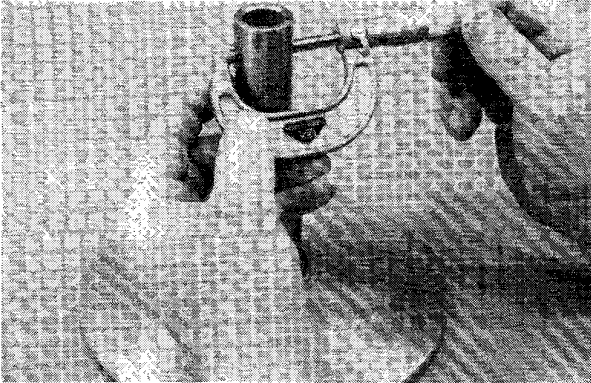


Fig. 4-12



AM047

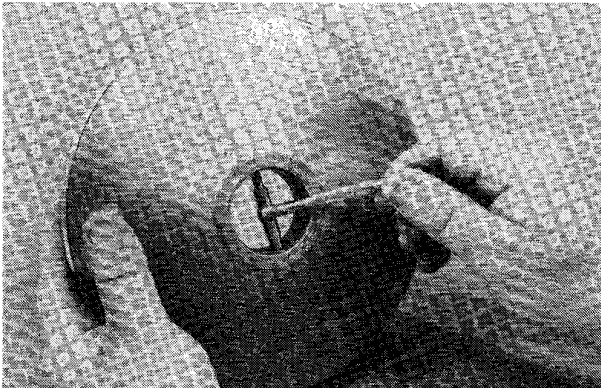
Fig. 4-13



AM022

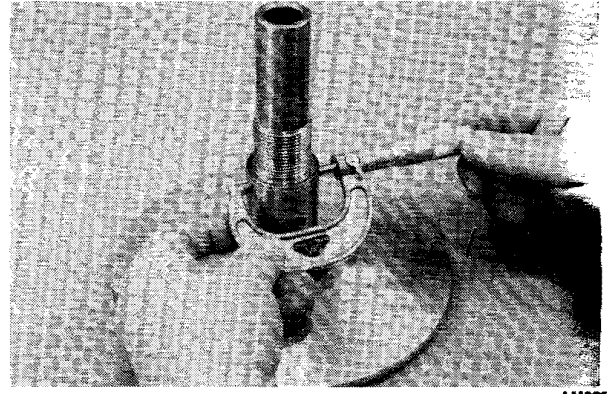
4. Inspect the bushing in the movable sheave for wear, damage, or cracks. Measure the inside diameter of the bushing and the outside diameter of the stationary sheave hub. The difference (clearance) must be less than 0.76 mm (0.030 in.).

Fig. 4-14



AM023

Fig. 4-15



AM025

5. Inspect the spring for proper compression qualities (see Spring Chart below).

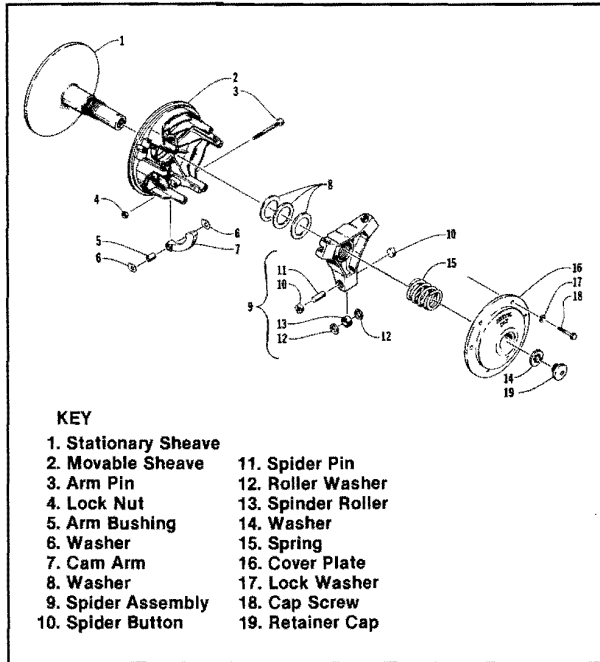
SPRING - COMET DRIVE			
p/n	Color	Rate @ 2 3/8 in.	Rate @ 1 3/8 in.
0646-154	Purple	136	254
0146-526	Yellow/Green	134	264
0646-083	Red	92	222
0646-097	Blue/Red	68	197
0646-084	White	78	178
0646-096	Silver	85	169

6. Inspect the cam arms for any uneven wear pattern or damage to the bushings.
7. Inspect all threaded areas for any cracked or stripped threads.
8. Inspect rollers for damage or wear.
9. Inspect the bushings for damage or fraying.
10. Inspect the stationary sheave hub for damage or wear.



# ASSEMBLING

Fig. 4-16



0729-588

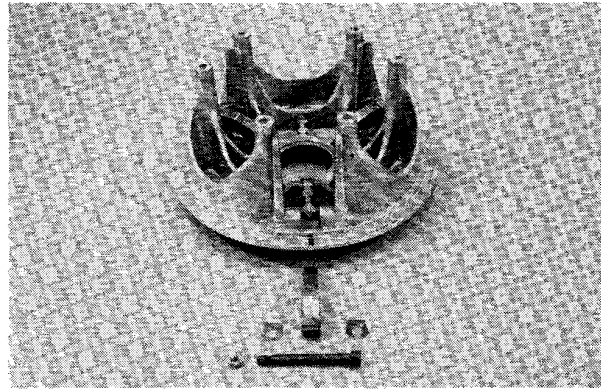
## WARNING

Never reuse the lock nuts on the cam arm pins. Also, when installing new lock nuts, always use Red LOCTITE STUD N' BEARING MOUNT on the nut threads.

- Place a cam arm and washers (one on either side of the cam arm) into position on the movable sheave; then secure with the arm pin and nut coated with LOCTITE STUD N' BEARING MOUNT. Carefully tighten the lock nut to a point just ensuring free cam arm movement. Repeat procedure on the other two cam arms making sure the head of each arm pin is positioned toward the direction of rotation.

**NOTE:** The clutch rotates counterclockwise.

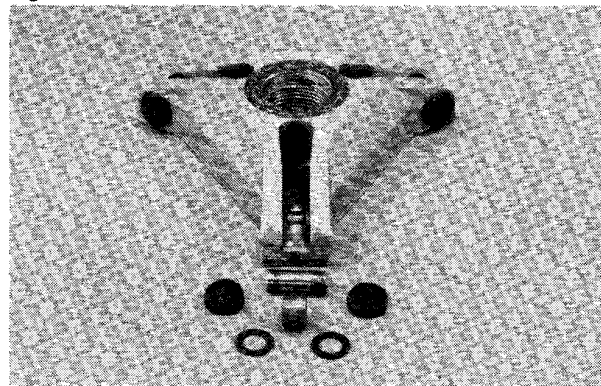
Fig. 4-17



AM036

- Place a roller and thrust washers (one on each side of the roller) into position on the spider; then install the pin. Repeat procedure on the other two rollers.

Fig. 4-18

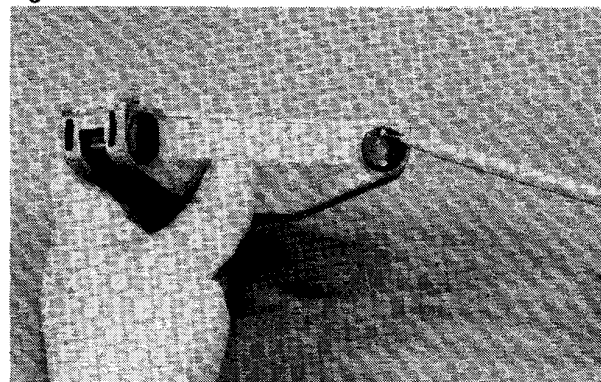


AM030

- Place the guide buttons into position making sure the two dots are positioned vertically; then tap into position until seated.

**NOTE:** If a guide button does not fit tightly, it must be replaced.

Fig. 4-19



AM031

4

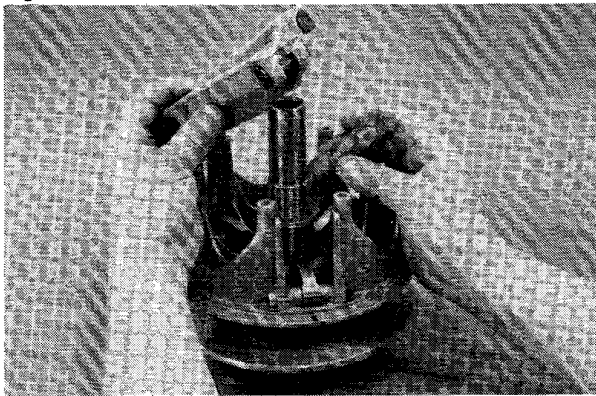


**CAUTION**

The two dots must be positioned vertically. If the two dots are not vertical, the movable sheave may bind on the spider.

4. Place the movable sheave, spacer rings, and spider into position on the stationary sheave hub. Make sure all threads are clean and free of oily residue. apply LOCTITE STUD N' BEARING MOUNT to the entire threaded area of the hub and thread the spider onto the hub. Tighten the spider using the Spider Removal Tool to 34.5 kg-m (250 ft-lb). ALLOW THE LOCTITE TO CURE AT ROOM TEMPERATURE FOR 24 HOURS.

Fig. 4-20



AM039

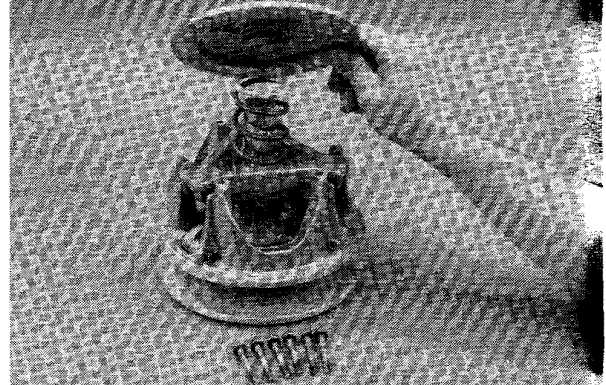
**CAUTION**

Make sure the line made on the spider and movable sheave during disassembly is properly aligned.

**NOTE:** Before installing the spring, position the cover over the shaft and slide it up and down. If any binding is felt, the shaft is out of round and must be filed in the out-of-round area until the cover slides freely. Secondly, grasp the movable sheave and lift it upward; then release it. It must move freely and not bind at any point. If any binding is noted, one or more of the cam arm pins may be too tight. Check the cam arms to be sure they move freely and do not bind. Correct this condition by backing off the lock nut.

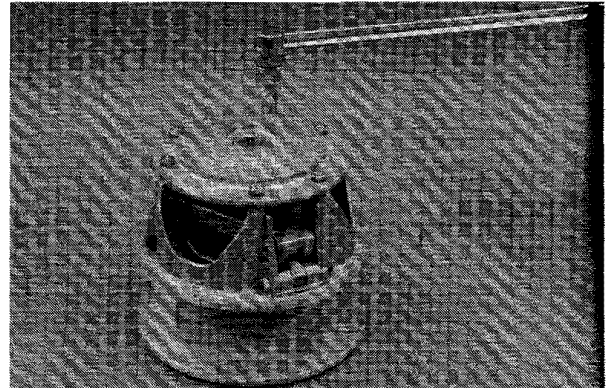
5. Place the spring and cover plate into position making sure the line on the cover plate is properly aligned; then compress the spring and install the six cap screws coated with LOCTITE LOCK N' SEAL and lock washers. Tighten the six cap screws evenly to 1.0 kg-m (7.0 ft-lb).

Fig. 4-21



AM044

Fig. 4-22



AM053

**CAUTION**

Care must be taken when installing the cover plate not to damage the bushing.

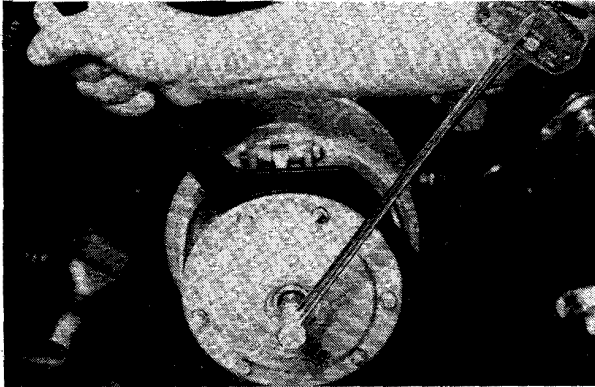
**INSTALLING**

1. Place the urethane sleeve into the clutch taper bore and push into position.
2. Insert the clutch bolt and lock washer.
3. Slide the aluminum sleeve onto the clutch bolt (on top of the urethane sleeve).
4. Place the clutch into position on the crankshaft.
5. Using a 1/2 in. 12-point socket, torque the clutch bolt to 6.9-7.6 kg-m (50-55 ft-lb).

**CAUTION**

When installing the drive clutch, do not tighten the clutch bolt with any kind of impact tool. Torque clutch bolt using a hand torque wrench only. Failure to do so could result in stationary sheave damage.

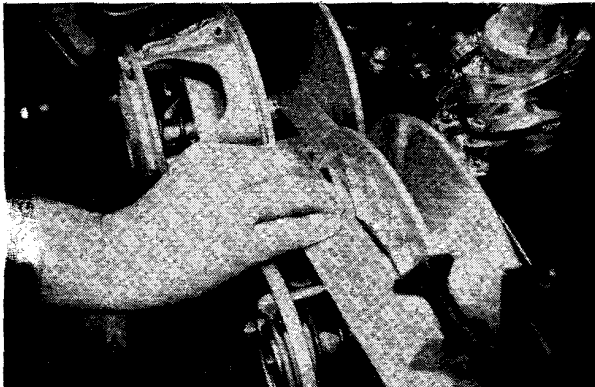
Fig. 4-23



AF119

6. Check alignment between the drive clutch and driven pulley (see Checking Parallelism/Offset).

Fig. 4-24



AF121

7. Install the drive belt and check the drive belt deflection. Secure the clutch shield.

**WARNING**

Never operate the engine without the clutch shield secured in place.

8. Either test drive the snowmobile or run the engine for five minutes; then torque the drive clutch bolt to 6.9-7.6 kg-m (50-55 ft-lb).

9. Apply Red LOCTITE to the threads of the retainer plug. Install plug and washer. Torque to 6.9-7.6 kg-m (50-55 ft-lb).

## Driven Pulley

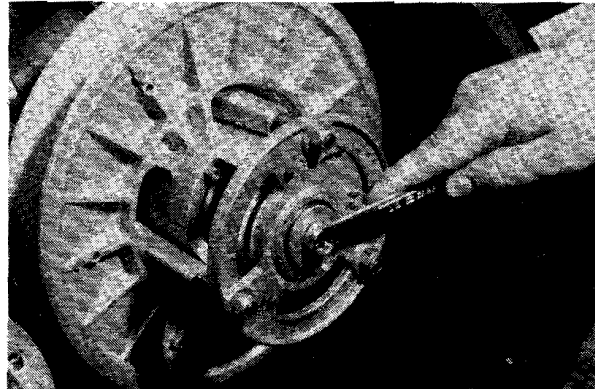
### SPECIFICATIONS

Driven Pulley	p/n	0726-530
Cam Angle		53°
Spring Color		Yellow
Adjustment Hole Position		3rd

### REMOVING

1. Open the hood; then open the clutch shield.
2. Remove the drive belt.
3. Remove the cap-lock screw and washer; then account for and note the position of any alignment washers.

Fig. 4-25



AN004

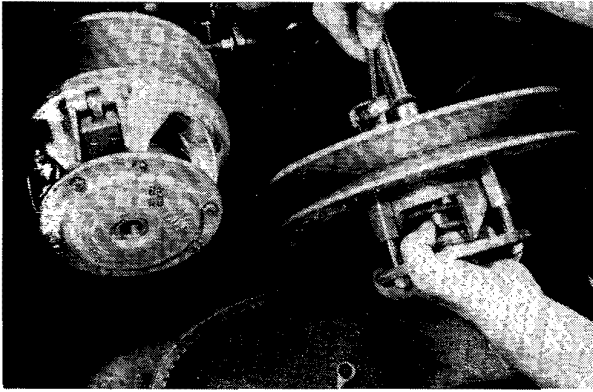
4. Slide the driven pulley off the driven shaft; then remove pulley from the engine compartment. Account for a key.

**NOTE:** If the driven pulley is tight on the shaft, pull the driven pulley off using the Driven Pulley Puller (p/n 0644-110).

4



Fig. 4-26



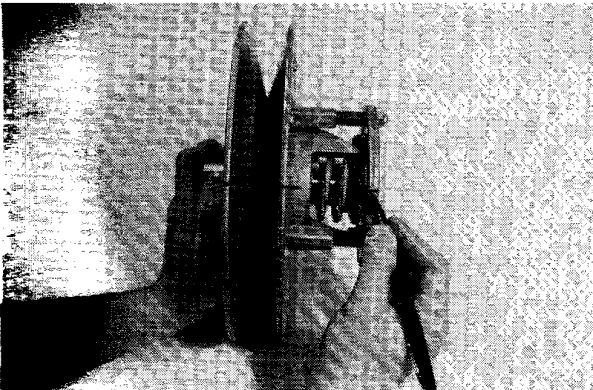
AF120

5. Remove the key, alignment washers, and stub shaft from the driven shaft.

### DISASSEMBLING

1. Scribe a line across all driven pulley components to ensure correct assembly and pulley balance.

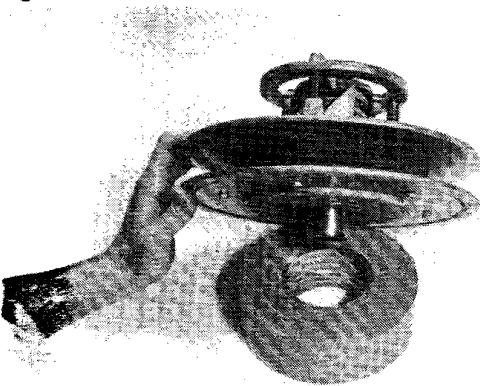
Fig. 4-27



B454

2. Place the driven pulley on a work fixture so the retainer bracket is directed upward.

Fig. 4-28

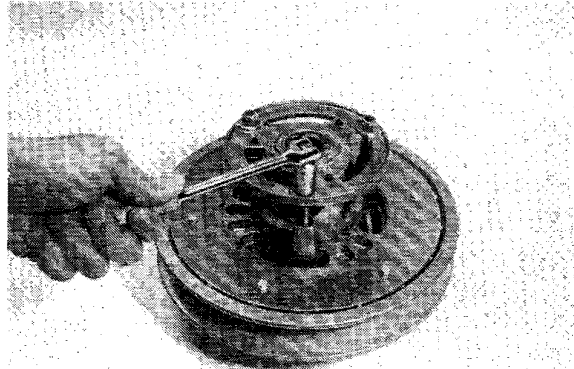


B455

**NOTE:** To aid in driven pulley servicing, use a roll of duct tape as a work fixture. The work fixture will increase stability of the pulley and decrease the spring tension during the repair procedure.

3. Remove the three lock nuts securing the retainer bracket; then carefully slide the retainer bracket off the stationary shaft allowing the spring to release tension.

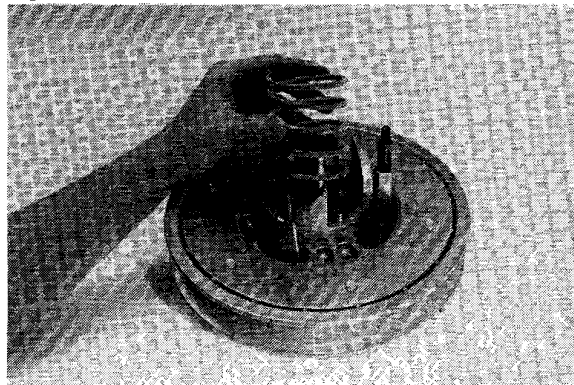
Fig. 4-29



B456

4. Remove the spring.

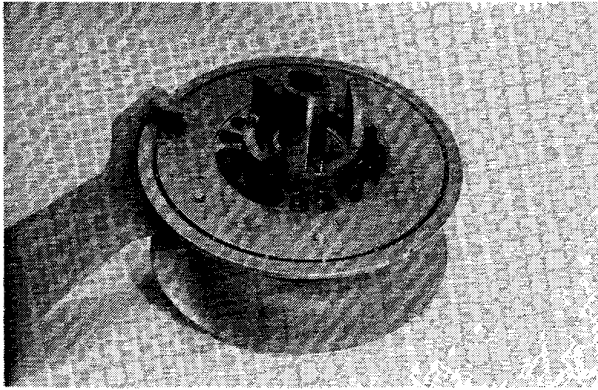
Fig. 4-30



B458

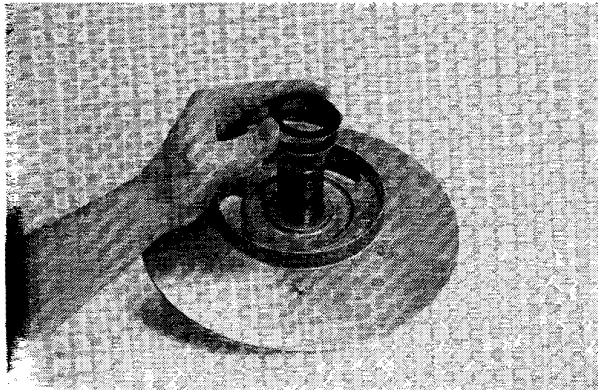
5. Slide the movable sheave off the stationary shaft; then remove the washers located between the sheaves.

Fig. 4-31



B459

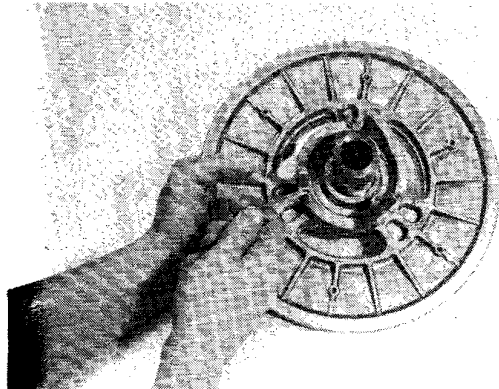
Fig. 4-32



B460

6. Remove the three cap-socket screws and lock washers securing the torque bracket to the stationary sheave; then remove torque bracket.

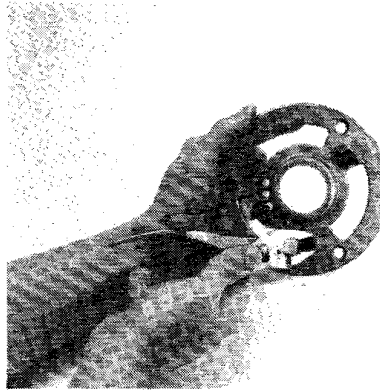
Fig. 4-33



B463

7. Using a pair of pliers, remove the buttons from the retainer bracket.

Fig. 4-34



B464

## CLEANING

1. Using parts-cleaning solvent, wash grease, drive belt dust, and foreign matter off all parts.

 <b>CAUTION</b>
--

<p>Do not use steel wool or a wire brush to clean driven pulley components. A wire brush or steel wool will cause the sheaves to be gouged (thus, the drive belt may not slide properly between sheaves). Decreased performance and possible accelerated drive belt wear will result.</p>
---

4

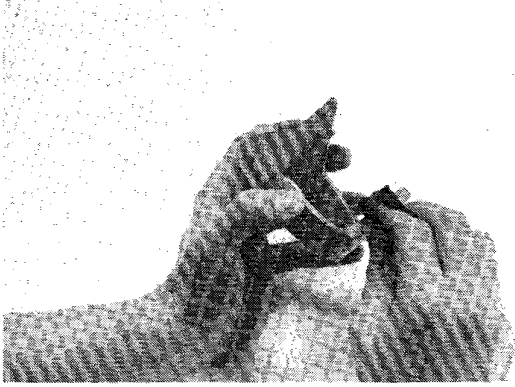
## INSPECTING

**NOTE:** Whenever a part is worn excessively, cracked, defective, or damaged in any way, replacement is necessary.

1. Inspect the buttons for damage, cracks or wear.
2. Inspect the sheaves for any gouges, cracks, or other damage. Also, inspect threaded areas of sheaves for damaged or stripped threads.
3. Inspect the torque bracket for cracks or damage. The ramp portions of the bracket must be free of gouges and damage. Minor scratches may be repaired using #320 grit wet-or-dry sandpaper.



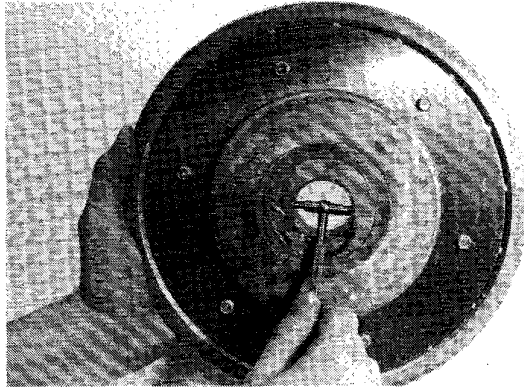
Fig. 4-35



B465

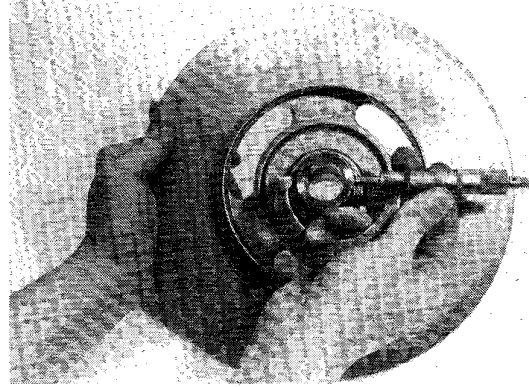
4. Inspect spring for distortion, crystallization, or breaks.
5. Inspect the retainer bracket and spring mounting holes for cracks, damage, or wear.
6. Inspect the retainer bracket and movable sheave bearings for wear. For each respective bearing, measure the outside diameter of the sheave shaft and the inside diameter of the sheave bearings. Compare the readings. Clearance between the shaft and the respective bearing must not exceed 0.5 mm (0.020 in.). If the clearance exceeds the specification, the bearing must be replaced.

Fig. 4-36



B466

Fig. 4-37



B467

## BEARINGS

### Removing

To remove driven pulley bearings, use the Bearing Driver (p/n 0644-167) and the following procedure:

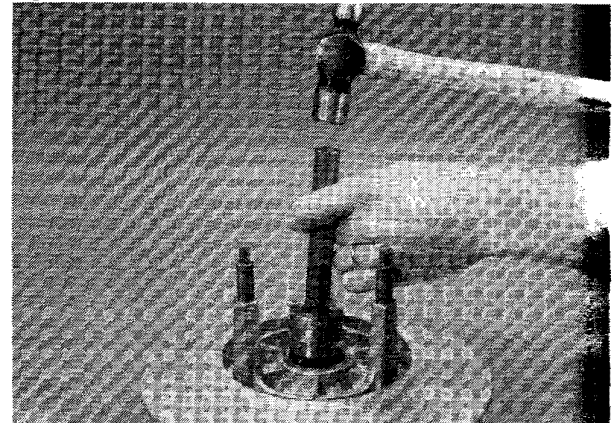
### WARNING

Always wear safety glasses when using the bearing driver.

**NOTE:** To remove the movable sheave bearing, heat must be applied around the bearing.

1. Place the movable sheave or retainer bracket flat on a press.
2. Using the Bearing Driver (p/n 0644-167), press the bearing out.

Fig. 4-38



AF154

## Installing

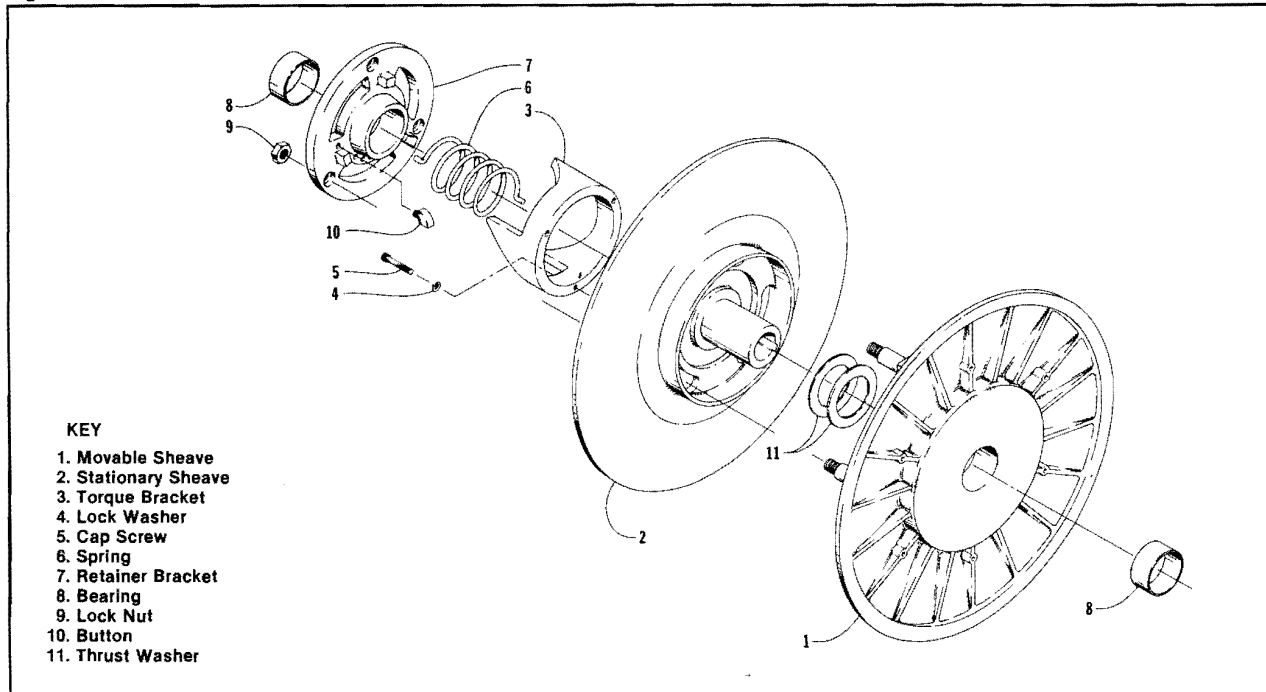
**NOTE:** Before installing the bearing, apply **LOCTITE STUD N' BEARING MOUNT** to the outside face of the bearing.

1. Place the movable sheave or retainer bracket flat on a press.

2. Using the Bearing Driver (p/n 0644-167), press the bearing into position. The bearing must be flush with the outsides of the movable sheave bearing boss.

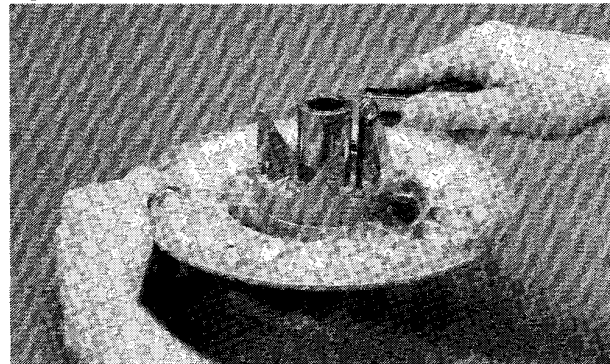
3. Wipe off excess LOCTITE. Allow to cure for 24 hours at room temperature.

Fig. 4-39



1. Install the buttons in the retainer bracket.
2. Place the torque bracket into position on the stationary sheave making sure the degree number on the torque bracket aligns with the part number on the stationary sheave. Install the three cap-socket screws and lock washers. **DO NOT** tighten at this time.

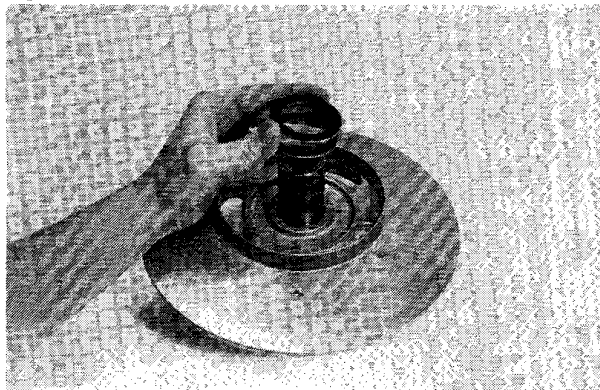
Fig. 4-40



3. Place the washers(s) on the stationary sheave shaft.



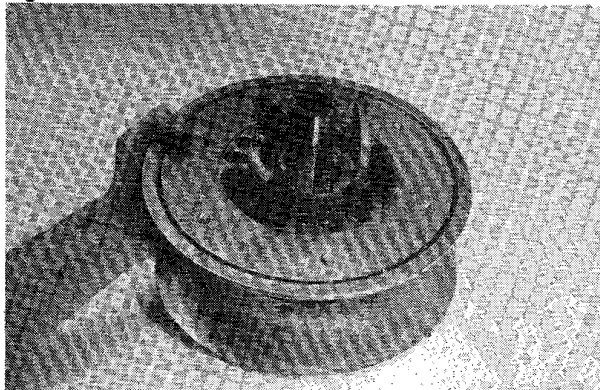
Fig. 4-41



B460

4. Align the scribed line made during disassembly; then slide the movable sheave onto the stationary sheave shaft.

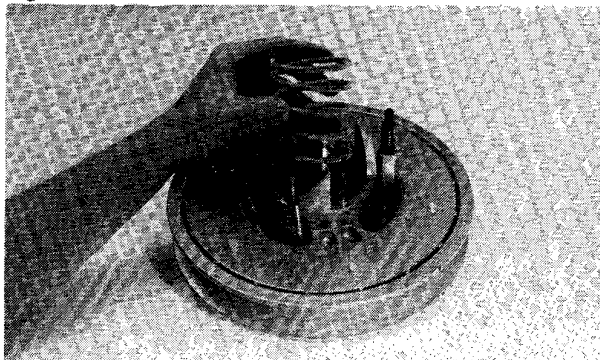
Fig. 4-42



B459

5. Place the sheaves on a work fixture (roll of duct tape, etc.).
6. Place the spring over the stationary sheave hub and hook the turned down end of the spring into the hole in the casting of the stationary sheave.

Fig. 4-43

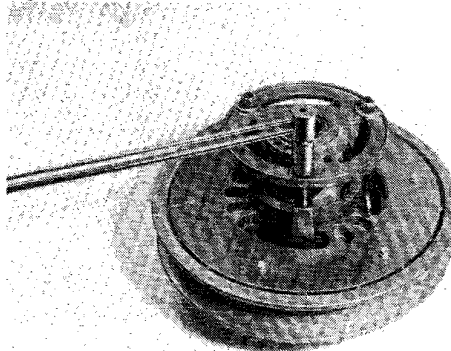


B458

7. Place the retainer bracket over the spring and hook the turned-up end of the spring in the 3rd hole (standard spring tension) of the bracket.
8. While holding the sheaves to prevent them from rotating, grasp the retainer bracket and rotate it approximately 120° clockwise until the mounting holes align; then push retainer bracket into position and install the three lock nuts. Tighten the lock nuts to 1.5-1.8 kg-m (11-13 ft-lb).

**NOTE: The line made during disassembly should be aligned.**

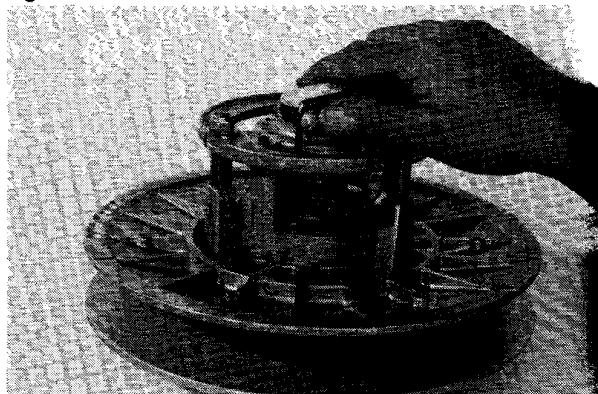
Fig. 4-44



B457

9. Rotate the movable sheave to ensure movement without binding.
10. Rotate the torque bracket until it is tight against the three buttons; then using a long hex wrench, tighten the three socket-head cap screws securing the torque bracket.

Fig. 4-45



A1003

## INSTALLING

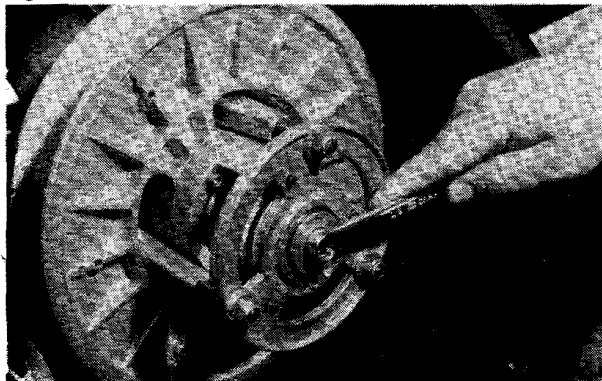
1. Slide the alignment washers onto the end of the driven shaft.

2. Install the key in the driven shaft keyway; then place the stub shaft into the driven pulley. Place the driven pulley on the shaft. Align its keyway with the driven shaft keyway.

**NOTE: A small amount of LOCTITE ANTI-SEIZE COMPOUND applied to the driven shaft will aid in future driven pulley removal.**

3. Secure the driven pulley by installing the washer(s) and cap screw. Tighten the cap screw to 2.6-3.3 kg-m (19-24 ft-lb).

Fig. 4-46



AN004

4. Check drive clutch/driven pulley alignment, adjust as necessary.
5. Install the drive belt and check drive belt deflection. Secure the clutch shield and side pod.

## Drive Clutch/ Driven Pulley

### CHECKING PARALLELISM/OFFSET

If premature drive belt failure is experienced or if the drive belt turns over, parallelism/offset must be checked. Also, parallelism/offset must be checked whenever either the drive clutch or driven pulley is serviced. To check the parallelism/offset, use the following procedure:

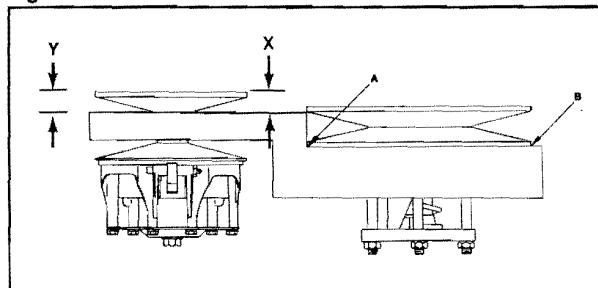
1. Open the clutch shield and remove the drive belt.
2. Install the Clutch Alignment Bar between the drive clutch sheaves and against the outside edge of the driven pulley stationary sheave.

3. Allow the alignment bar to rest on the drive clutch shaft.

**NOTE: The alignment bar must extend beyond the front edge of the drive clutch.**

4. With the bar against the outside edge of the driven pulley stationary sheave at points A and B, the bar should just clear the inside edge of the stationary sheave of the drive clutch and rest on the stationary shaft. If the bar will not clear the inside edge or is more than 1.5 mm (0.060 in.) from the inside edge, the offset needs to be adjusted.

Fig. 4-47



0727-172

5. Check parallelism of the drive clutch/driven pulley using the alignment bar and reference points X and Y with the alignment bar against the driven pulley at points A and B. Using a caliper or a machinist's scale, measure X and Y from the back side of the alignment bar. Measurement X and Y must be equal or measurement Y must be more than measurement X but must not exceed measurement X by more than 1.6 mm (0.062 in.).

Fig. 4-48



AF041

**NOTE: The offset must be correct before checking parallelism.**

6. If the offset is other than specified, proceed to Correcting Offset.



## CORRECTING OFFSET

1. To correct offset, the driven pulley must be moved laterally on the driven shaft. Remove the cap-lock screw and washers securing the driven pulley; then remove the driven pulley.
2. To move the driven pulley inward on the shaft, remove washer(s) as required.
3. To move the driven pulley outward on the shaft, add additional alignment washer(s) behind the driven pulley.

**NOTE:** When the correct offset is attained, use the large and small alignment washers to correctly position the driven pulley on the driven shaft. Arrange washers to allow the least amount of "float" on the driven shaft. A maximum of one washer thickness "float" is allowable. Apply a light coat of grease to the shaft.

4. Install the driven pulley and secure with a cap-lock screw and washers. Tighten the screw to 2.6-3.3 kg-m (19-24 ft-lb).
5. Install the drive belt and secure the clutch shield.

**NOTE:** After you have checked and adjusted the offset, you must check for proper drive belt deflection. This is very critical for optimum performance (see Drive Belt Deflection section).

## ADJUSTING CENTER-TO-CENTER DISTANCE

To adjust the center-to-center distance, there are three shim plates provided on the rear PTO-side motor mount bolt. To adjust use the following procedure:

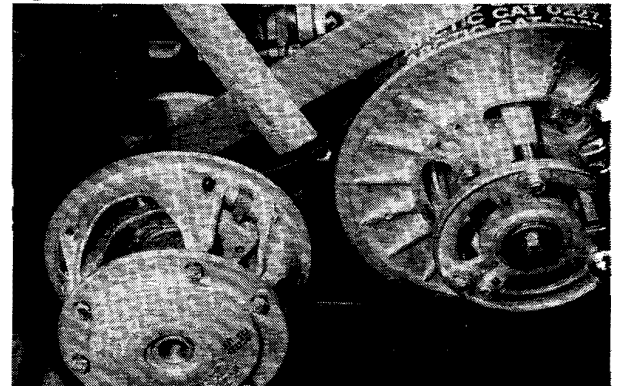
1. Remove the driven clutch.
2. Using a 3/8 in. Allen-head wrench, loosen the rear PTO-side motor mount bolt.
3. Move the required number of shim plates forward to achieve the 28.9 cm (11.375 in.) center-to-center distance between the drive clutch and driven pulley.
4. Using a 3/8 in. Allen-head wrench, tighten the rear PTO-side motor mount bolt. Torque to 4.2 kg-m (30 ft-lb).

## DRIVE BELT DEFLECTION

Drive belt length, condition, and deflection are all important for peak performance. To check and adjust drive belt deflection, use the following procedure.

1. Turn the engine OFF; then open the clutch shield.
2. Make sure the drive belt is sitting at the top of the driven pulley sheaves.
3. Place a straightedge on top of the drive belt. The straightedge should reach from the drive clutch to the top of the driven pulley.
4. Using a stiff ruler centered between the clutches, push down on the drive belt just enough to remove all slack. Note the amount of deflection on the ruler at the bottom of the straightedge. The deflection should be within the range of 25.4-31.8 mm (1-1 1/4 in.).

Fig. 4-49



**NOTE:** Only push down on the belt with the ruler until you see the bottom of the belt flex upward; then read the amount of deflection.

5. To correct drive belt deflection, washers can be removed or added between the stationary and movable sheave of the driven pulley.

**NOTE:** If the drive belt deflection is above specifications, the snowmobile will bog and lack power at clutch engagement. For good performance, proper belt deflection is a must.

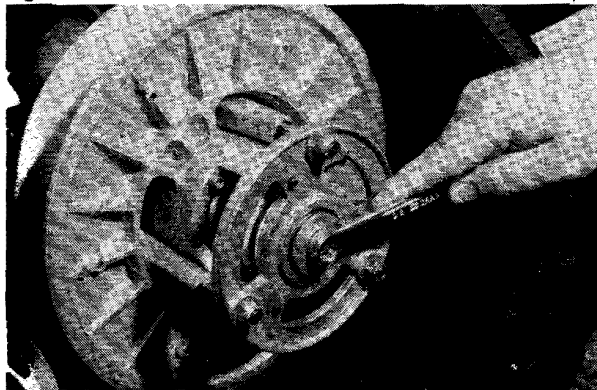
6. Secure the clutch shield.

## Drive Train

### DISASSEMBLING

1. Disconnect the negative battery cable and then the positive cable from the battery. Remove the two nuts and three cap screws securing the battery box. Account for four washers. Remove the battery box with battery.
2. Open the clutch shield and remove the drive belt.
3. Remove the cap-lock screw and washer securing the driven pulley; then account for and note the position of the alignment washers.

Fig. 4-50

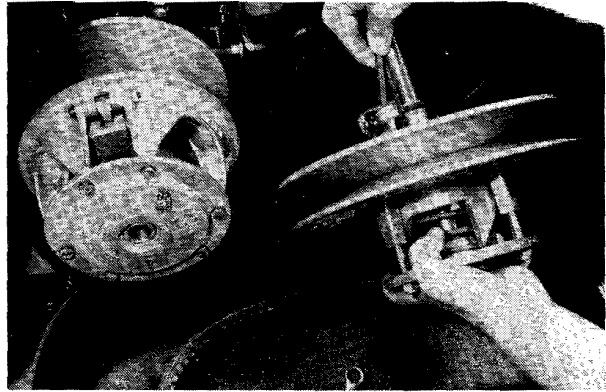


AN004

4. Slide the driven pulley off the driven shaft; then remove the driven pulley from the engine compartment. Remove the key, alignment washers, and stub shaft from the driven shaft.

**NOTE:** If the driven pulley is tight on the driven shaft, pull the driven pulley off using the Driven Pulley Puller (p/n 0644-110).

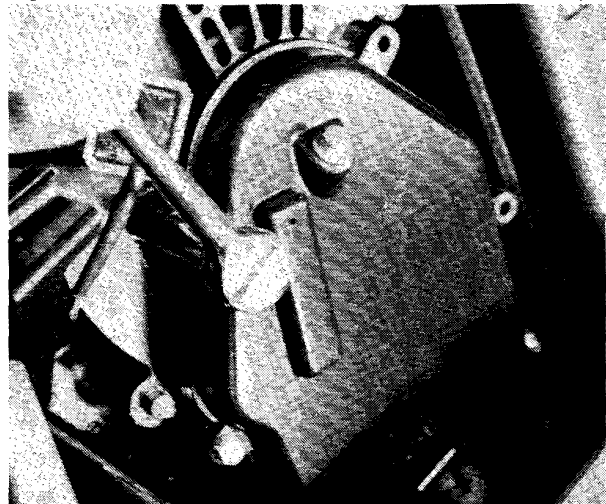
Fig. 4-51



AF120

5. Remove the chain-case drain plug and drain the chain-case lubricate; then remove the six cap screws and lock washers securing the chain-case cover and remove the cover.

Fig. 4-52

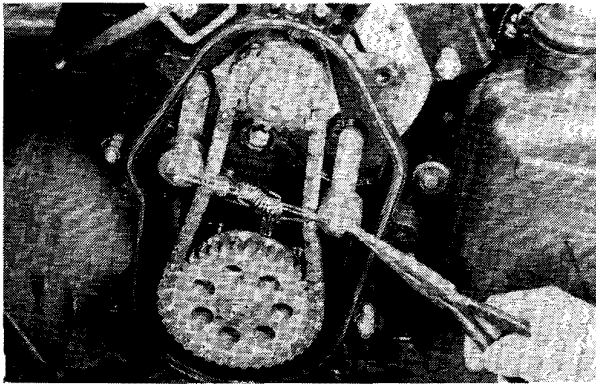


AF111

6. Remove cotter pins and washers securing the tensioner spring to the link pins; then remove the spring, rollers, and washers.



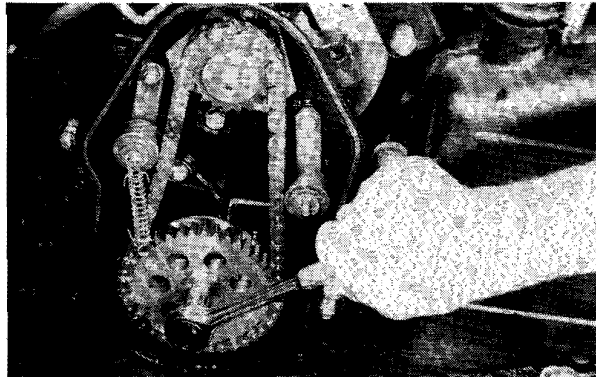
Fig. 4-53



AF113

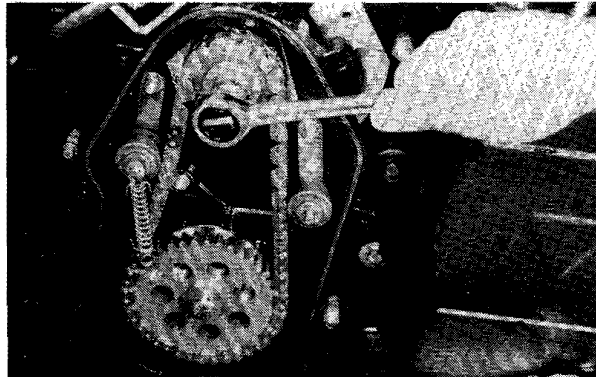
7. Remove the cap-lock screw and washer securing the bottom sprocket. Remove the lock nut and washer securing the top sprocket.

Fig. 4-54



AF115

Fig. 4-55



AF114

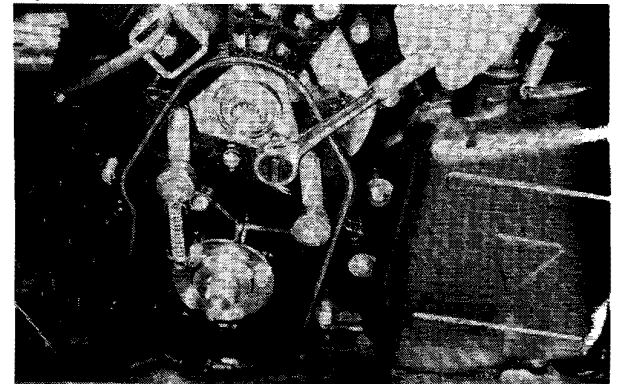
8. Slide both sprockets with chain off the shafts. Account for washer(s) behind the upper sprocket.

**NOTE:** If a sprocket will not slide off a shaft, thread the cap-lock screw or lock nut back onto the lower or upper shaft and use a puller to loosen the sprocket. The nut or cap-lock screw will prevent damage to shaft threads.

9. Remove the six lock nuts securing the upper and lower MAG-side flange plates. Remove flange plates, seals, and upper bearing.

**NOTE:** It may be necessary to use heat to loosen the LOCTITE securing the bearing to the driven shaft. If heat is used, examine the bearing seal for any damage before installation.

Fig. 4-56



AF116

10. Loosen the set screw on the PTO-side drive-shaft collar. Drive the collar clockwise (opposite shaft rotation) until it is free.

**NOTE:** A fine file should be used to remove any burrs left by the collar set screw.

11. Remove the two lock nuts and cap screws securing the PTO-side driven-shaft flange plate.

**NOTE:** It will be necessary to remove the air intake silencer for this procedure.

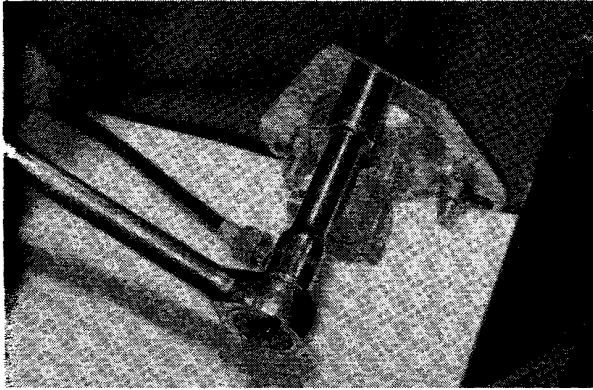
12. Force the driven shaft toward the PTO side (rotating the shaft to prevent the brake disc from binding on the shaft) until the brake disc is free. Account for the key.

13. Continue to slide the driven shaft until it is out of the PTO side. Account for a bearing flange plate, and the PTO-side driven-shaft collar.

14. Remove the skid frame from the tunnel (see Track/Suspension—Removing Skid Frame section).

- Remove the three PTO-side lock nuts and carriage bolts securing the driveshaft-bearing flange plates and drive adapter. Remove the drive adapter and cable.

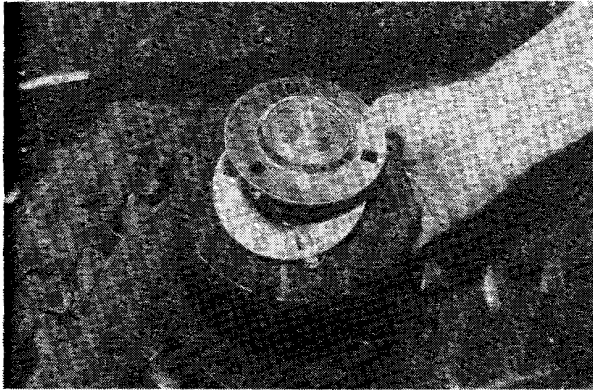
Fig. 4-57



AF053

- Tap the driveshaft toward the chain case to unseat the MAG-side bearing. Remove the bearing.
- Slide the driveshaft toward the MAG side until the PTO end of the driveshaft is out of its mounting hole. Tilt the end of the driveshaft away from the tunnel and slide the driveshaft free of the tunnel. Remove the track.

Fig. 4-58



AF055

- Scribe a line on the driveshaft along the edge of each sprocket to aid in assembly. Loosen the set screw on the collar, drive the collar clockwise until free, and remove the bearing and flange plates from the driveshaft.
- Press the sprockets off the driveshaft.
- Remove the six socket-head cap screws and lock nuts securing the brake disc to the hub; then separate disc and hub.

Fig. 4-59



AF110

## CLEANING AND INSPECTING

**NOTE:** Whenever a part is worn excessively, cracked, defective, or damaged in any way, replacement is necessary.

- Thoroughly wash all metallic components in parts-cleaning solvent. Dry using compressed air.
- Wash all non-metallic components with soap and water.
- Inspect the driveshaft and driven shaft for damaged splines or stripped threads.
- Inspect the bearings for any roughness or damage.
- Inspect the seals for any breaks or damage.
- Inspect the track for cuts, gouges, or wear.
- Inspect the keyways in the driven shaft and the brake hub for wear or damage.
- Inspect the brake disc for wear or cracks.
- Inspect chain, sprockets, and chain tensioner components for wear or damage.
- Inspect the track drive sprockets for wear or damage.

4



## ASSEMBLING

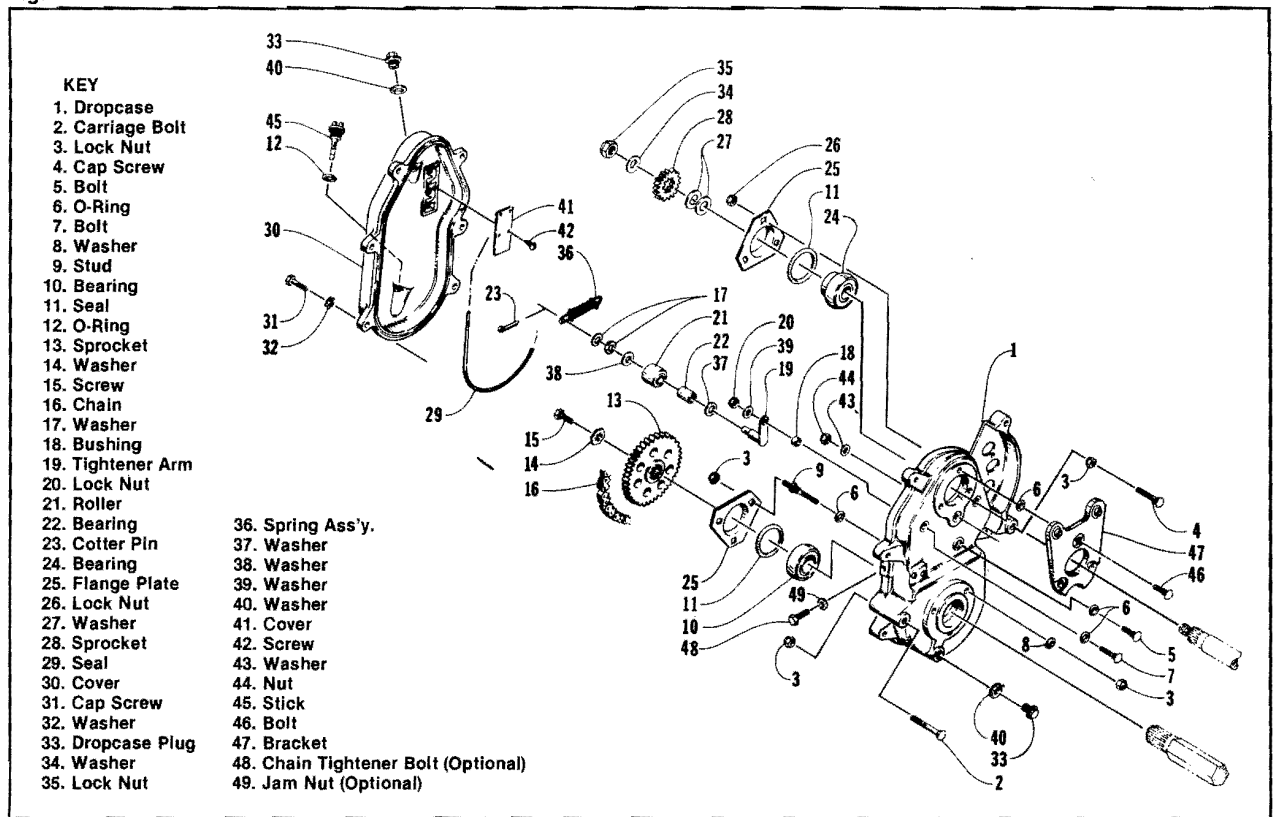
1. Secure the hub to the brake disc with the six socket-head cap screws and lock nuts. Tighten lock nuts to 0.4 kg-m (36 in.-lb).

Fig. 4-60



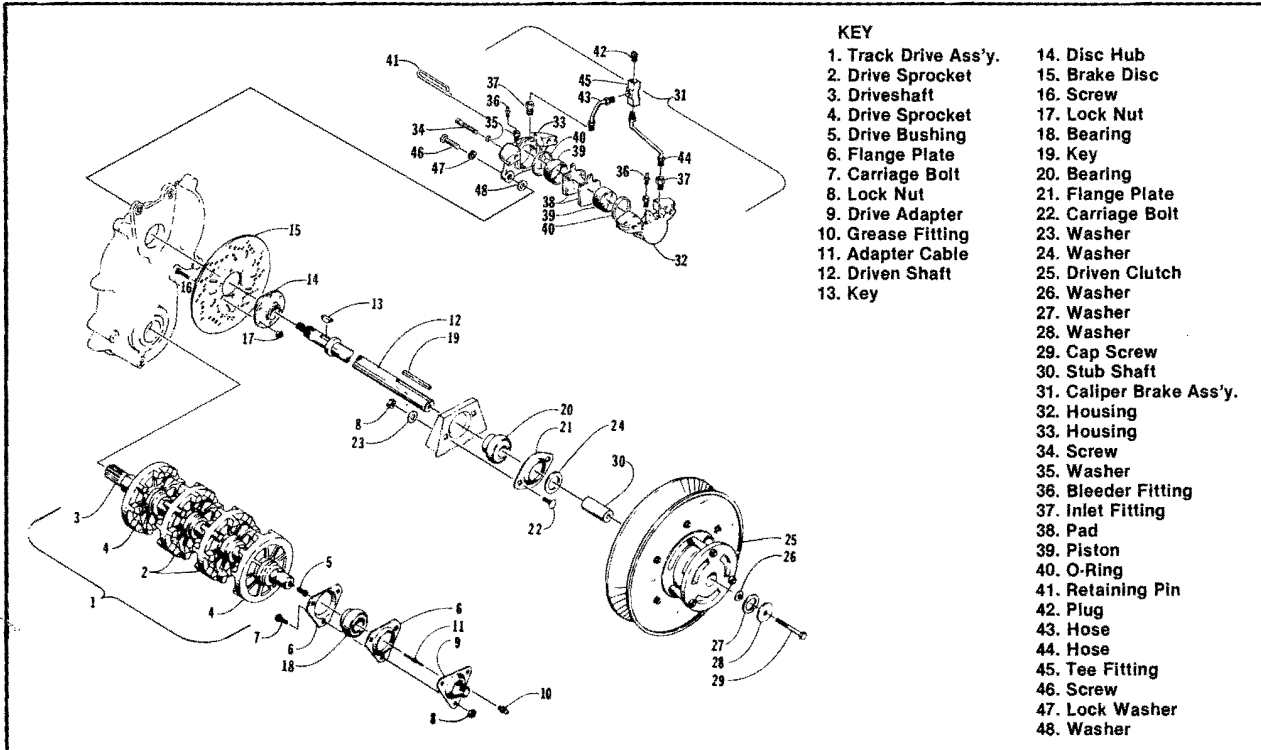
AF110

Fig. 4-61



0730-147

Fig. 4-62



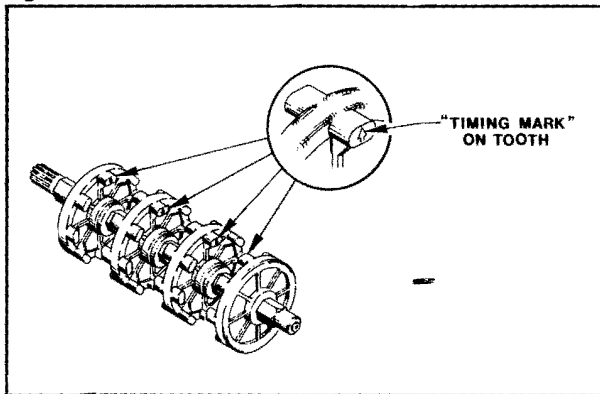
- KEY**
- 1. Track Drive Ass'y.
  - 2. Drive Sprocket
  - 3. Driveshaft
  - 4. Drive Lock Sprocket
  - 5. Drive Bushing
  - 6. Flange Plate
  - 7. Carriage Bolt
  - 8. Lock Nut
  - 9. Drive Adapter
  - 10. Grease Fitting
  - 11. Adapter Cable
  - 12. Driven Shaft
  - 13. Key
  - 14. Disc Hub
  - 15. Brake Disc
  - 16. Screw
  - 17. Lock Nut
  - 18. Bearing
  - 19. Key
  - 20. Bearing
  - 21. Flange Plate
  - 22. Carriage Bolt
  - 23. Washer
  - 24. Washer
  - 25. Driven Clutch
  - 26. Washer
  - 27. Washer
  - 28. Washer
  - 29. Cap Screw
  - 30. Stub Shaft
  - 31. Caliper Brake Ass'y.
  - 32. Housing
  - 33. Housing
  - 34. Screw
  - 35. Washer
  - 36. Bleeder Fitting
  - 37. Inlet Fitting
  - 38. Pad
  - 39. Piston
  - 40. O-Ring
  - 41. Retaining Pin
  - 42. Plug
  - 43. Hose
  - 44. Hose
  - 45. Tee Fitting
  - 46. Screw
  - 47. Lock Washer
  - 48. Washer

0730-150

2. Press the sprockets on the driveshaft noting the scribed marks on the shaft and the timing mark found on one tooth of each sprocket. The timing mark is the letter "T" molded into the outer surface of one drive tooth. All the "T" markings must be in alignment.

3. Assemble driveshaft components on the PTO end of the driveshaft. Install bearing lock collar, flange plate, bearing (with flange towards sprocket), and the remaining flange plate.
4. Position front of track up into the tunnel. Install the driveshaft with the splined end through its mounting hole in the chain case.

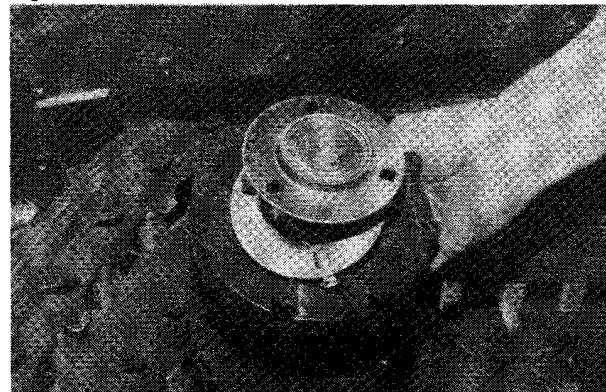
Fig. 4-63



0727-829

**NOTE:** Make sure the sprockets are installed correctly ensuring correct timing of the sprockets.

Fig. 4-64



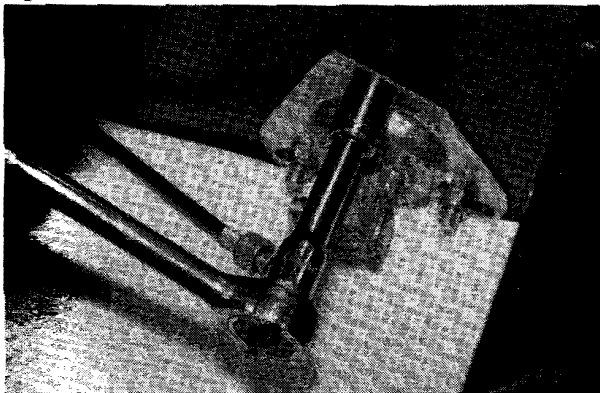
AF055

5. Place the PTO end of the driveshaft into position; then align the holes in the flange plates with the holes in tunnel. Place the cable and drive adapter into position.



6. Insert three carriage bolts from the inside of the tunnel through the flange plates, tunnel, and drive adapter. Secure with three lock nuts. Tighten to 2.2-2.5 kg-m (16-18 ft-lb).

Fig. 4-65



AF053

7. Slide the MAG-side bearing onto the driveshaft (inner race flange must be positioned toward drive chain); then install seal and flange plate. Secure with three lock nuts. Tighten to 2.2-2.5 kg-m (16-18 ft-lb).
8. Install the brake hub key into the driven shaft keyway.
9. Install the PTO-side bearing with collar and flange plate on the driven shaft; do not tighten the collar at this time. Place the driven shaft into position making sure the brake disc and flange plate are properly positioned. Secure with PTO-side bearing and flange plate with two carriage bolts and lock nuts. Torque to 2.2-2.5 kg-m (16-18 ft-lb).

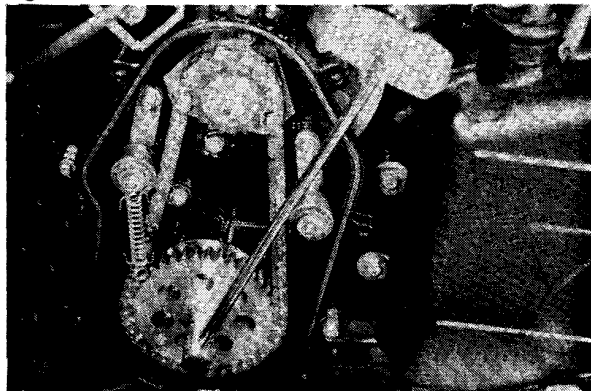
**NOTE: Install the air intake silencer.**

10. On the MAG side of the driven shaft, apply SCOTCH BOND ADHESIVE 4174 to the bearing seating area adjacent to the shaft splines. Install the bearing, seal, and flange plate and secure with three lock nuts. Tighten to 2.2-2.5 kg-m (16-18 ft-lb).

**NOTE: If washers were removed from behind the upper sprocket, install them at this time.**

11. Loop the chain around the upper and lower sprockets. Slide the upper and lower sprockets into position together on the splined shafts. Secure the upper sprocket with a spring washer and lock nut. Tighten the lock nut to 3.3 kg-m (24 ft-lb). Secure the lower sprocket with a cap screw and washer. Torque the cap screw to 2.6-3.3 kg-m (19-24 ft-lb).

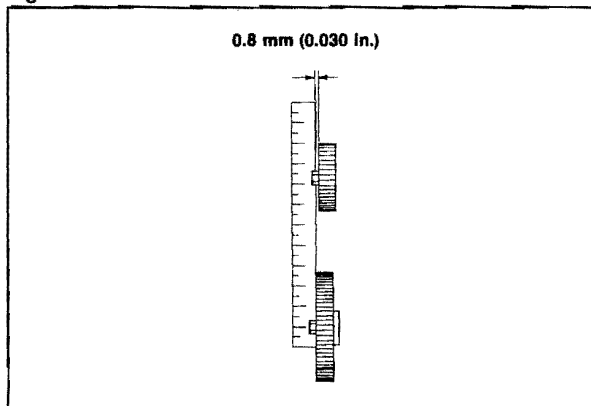
Fig. 4-66



AF117

12. Check the alignment of the sprockets using the following procedure:
  - a. Place a straightedge against the faces of the sprockets.
  - b. Using a feeler gauge, check for clearance along the faces of both sprockets. If clearance exceeds 0.8 mm (0.03 in.), shimming is necessary.

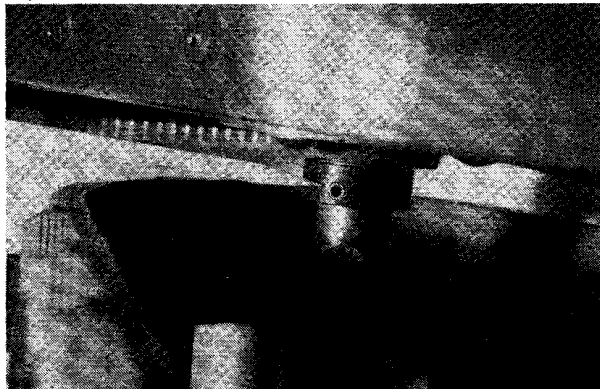
Fig. 4-67



0727-171

13. On the PTO side of the track driveshaft, slide the lock collar against the bearing, drive the collar in the direction of rotation until tight, and tighten the collar set screw.

Fig. 4-68

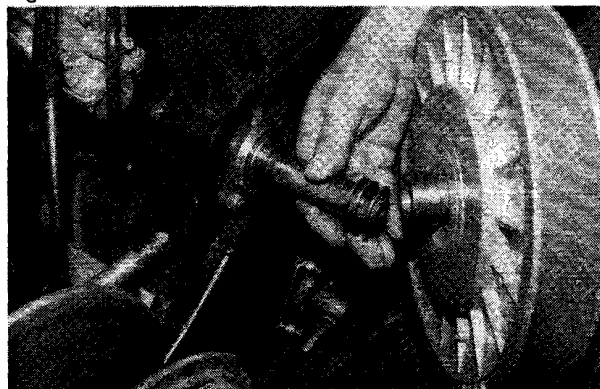


AF058

14. Install the skid frame (see Track/Suspension—Installing Skid Frame section).
15. Apply a light coat of grease or LOCTITE ANT-SEIZE COMPOUND to the driven shaft; then install the driven shaft alignment washers (as required) and key. Install the driven pulley with stub shaft, alignment washers (as required), washer, and cap-lock screw. Tighten cap-lock screw to 2.6-3.3 kg-m (19-24 ft-lb).

**NOTE:** Make sure keyways match when installing driven pulley. Arrange washers to allow the least amount of "float" on the driven shaft. A maximum of 1.5 mm (0.060 in.) "float" is allowable.

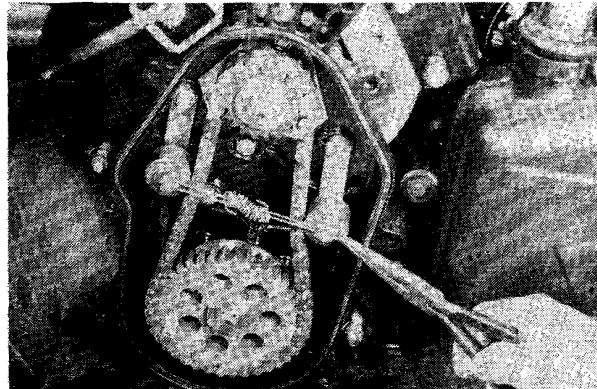
Fig. 4-69



AF057

16. Check the alignment of the drive clutch/driven pulley.
17. Tip the snowmobile onto the PTO side using cardboard to prevent scratching the belly pan; then install the rollers and spring and secure with two washers and cotter pins.

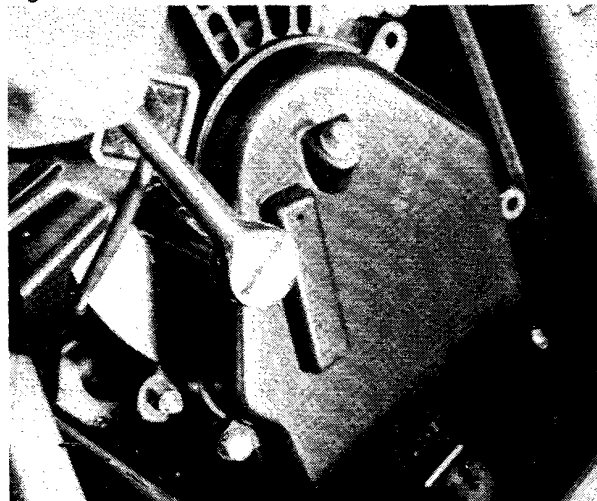
Fig. 4-70



AF113

18. Install the drain plug; then pour 236 ml (8 fl oz) of Transmission Lube into the chain case.
19. Place the chain-case cover O-ring seal and chain-case cover into position and secure with six cap screws and lock washers.

Fig. 4-71



AF111

20. Install the drive belt and check drive belt deflection. Secure the clutch shield.
21. Install the battery box and battery securing with two lock nuts, washers, and three cap screws.
22. Attach the positive battery cable; then attach the negative cable to the battery.

**⚠ WARNING**

The positive cable must be connected first.

4



## Hydraulic Brake

### ⚠ WARNING

Use only Arctco approved brake fluid (p/n 0638-315). Never substitute or mix different types or grades of brake fluid. Brake loss may occur. Brake loss can result in severe injury or even death.

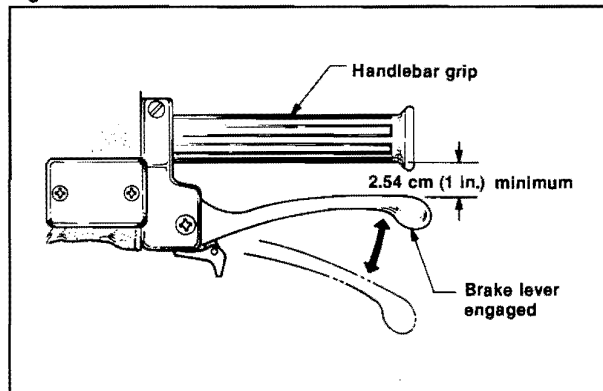
### CHECKING BRAKE LEVER TRAVEL

1. Compress the brake lever fully.

**NOTE:** Do not pump the brake lever as it will produce an inaccurate reading.

2. Measure the distance between the brake lever and the handlebar. The distance must be greater than 2.54 cm (1 in.).

Fig. 4-72



0729-875

3. If the resultant distance is less than specified, check the brake fluid level (see Brake Fluid section), inspect for leakage, and check the brake pads (see Checking and Changing Brake Pads section).

### ⚠ WARNING

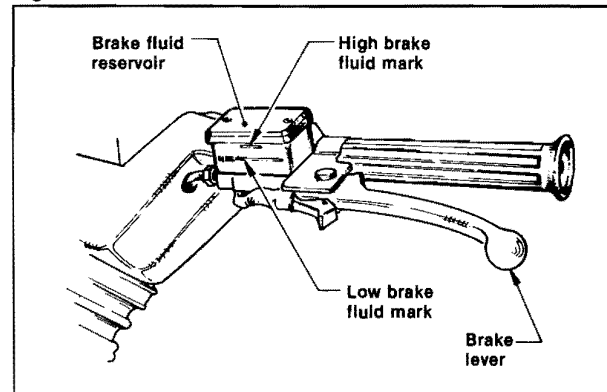
Do not operate the snowmobile if the compressed distance between the brake lever and handlebar is less than 2.54 cm (1 in.). Brake loss may occur. Brake loss can result in severe personal injury.

## BRAKE FLUID

### Checking and Adding Brake Fluid

1. With the master cylinder level, look into the master cylinder reservoir. The brake fluid level must be just below the high mark.

Fig. 4-73



0729-872

2. If the brake fluid level is below the low mark, remove the reservoir cover and add only Arctco approved brake fluid (p/n 0638-315) until the fluid level is just below the high mark. Install and secure the reservoir cover. DO NOT allow moisture to contaminate the brake system.

### ⚠ CAUTION

Brake fluid is highly corrosive. Do not spill brake fluid on any surface of the snowmobile.

### ⚠ WARNING

Do not overfill the master cylinder reservoir. Overfilling the reservoir may cause the brake system to hydraulically lock. Use only Arctco approved brake fluid (p/n 0638-315). Never substitute or mix different types or grades of brake fluid. Brake loss may occur. Brake loss can result in severe injury or even death.

### CHANGING BRAKE FLUID

The brake fluid must be changed on a regular basis and whenever the brake fluid has been overheated or contaminated. The brake fluid should be changed every 1,000 miles or at the end of the snowmobiling season, whichever occurs first.

Arctco recommends the removal and disassembly of the brake caliper assembly when changing the brake fluid (see Caliper section).

**CAUTION**

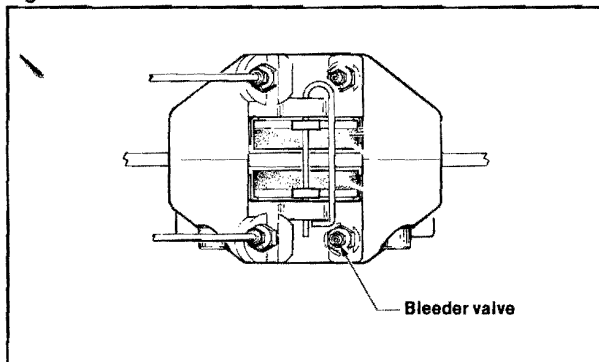
Brake fluid is highly corrosive. Do not spill brake fluid on any surface of the snowmobile.

**WARNING**

Use only Arctco approved brake fluid (p/n 0638-315). Any substitute may result in a loss of brakes.

- Slide a piece of flexible tubing over the ball of the bleeder valve and direct the other end into a container.

Fig. 4-74



0730-482

- Slowly squeeze the brake lever and hold. Open the bleeder valve to release the fluid and air. When the fluid flows free of air bubbles, close the bleeder valve; then release the brake lever.
- Add new Arctco approved brake fluid (p/n 0638-315) to the reservoir and repeat step 2 until the brake fluid flows free of air bubbles and appears clean.

**WARNING**

Do not use brake fluid from a container that has been opened for a long period of time. Unsealed brake fluid containers will absorb moisture and can contaminate the fluid inside.

**NOTE:** It may be necessary to refill the reservoir several times to eliminate all contaminated brake fluid.

- When the brake fluid is free of all air and contamination, and the brake lever feels firm when compressed, fill the reservoir to a level just below the high mark; then install and secure the cover. Remove the tube from the bleeder valve.

### BLEEDING BRAKE SYSTEM

If the brake lever feels "spongy" when applied, the brake system may need to be bled. To bleed the brake system use the following procedure:

- Remove the master cylinder reservoir cover and fill the reservoir to the upper mark with Arctco approved brake fluid.

**CAUTION**

Brake fluid is highly corrosive. Do not spill brake fluid on any surface of the snowmobile.

**WARNING**

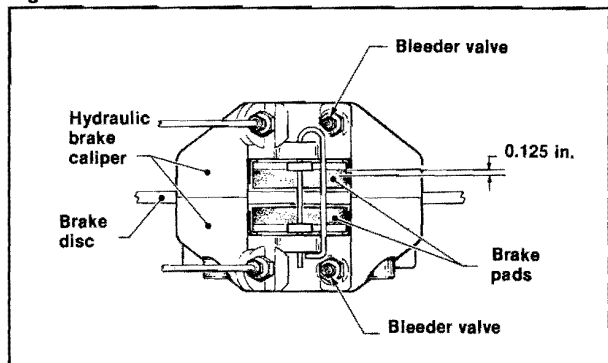
Use only Arctco approved brake fluid (p/n 0638-315). Any substitute may result in a loss of brakes.

**WARNING**

Do not use brake fluid from a container that has been opened for a long period of time. Unsealed brake fluid containers will absorb moisture and can contaminate the fluid inside.

- Slide a piece of flexible tubing over the ball of the bleeder valve and direct the other end into a container.

Fig. 4-75



0730-482

4



3. Slowly squeeze the brake lever and hold. Open the bleeder valve to release the fluid and air. When the fluid stops flowing, close the bleeder valve; then release the brake lever.
4. Repeat step 3 until the brake fluid flows free of air bubbles.

**NOTE:** It may be necessary to refill the reservoir during the bleeding process.

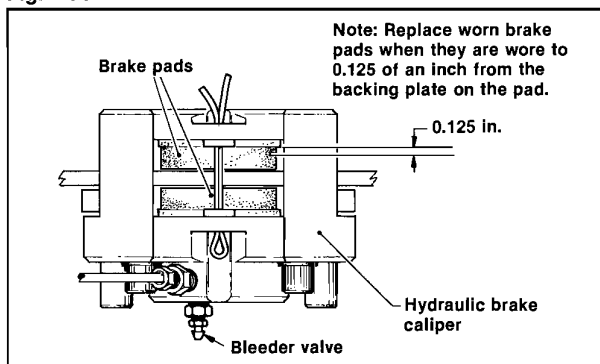
5. When the brake fluid is free of all air and the brake lever feels firm when compressed, fill the reservoir to a level just below the high mark; then install and secure the cover. Remove the tube from the bleeder valve.

### CHECKING AND CHANGING BRAKE PADS

To check and change the brake pads, use the following procedure.

1. Measure the width of both brake pads. The brake pad width must be greater than 3.8 mm (0.125 in.). If the brake pad width is less than specified, replacement of both pads is necessary. Follow steps 2-6 to replace the brake pads.

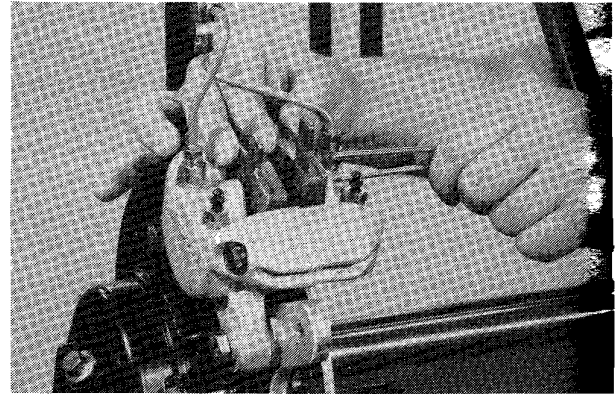
Fig. 4-76



0729-871

2. Remove the safety pin securing the brake pads to the caliper assembly.

Fig. 4-77

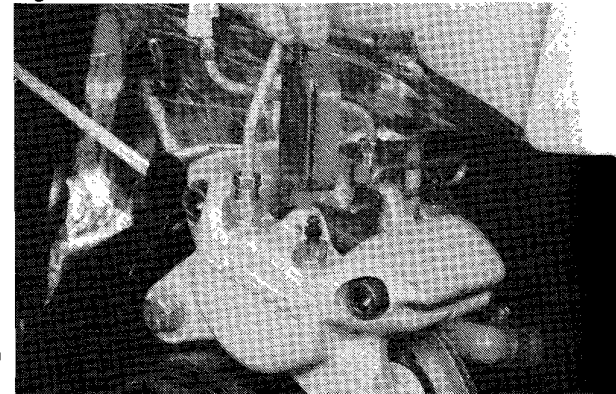


AF246

3. Pull both brake pads out of the caliper assembly.
4. Using a large screwdriver, slowly push both brake pistons into the caliper.
5. Position the new brake pads into the caliper and secure with a safety pin.

**NOTE:** When installing new brake pads, you must always install them as a set. Never install just one pad or use brake pads which have been used in another machine.

Fig. 4-78



AF253

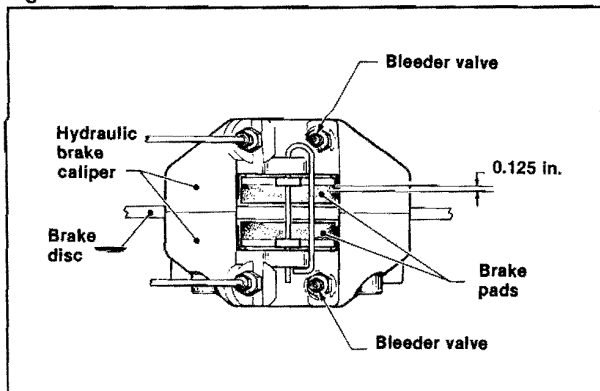
6. Pump the brake lever to ensure correct positioning of the brake pads; then release.
7. When new brake pads are installed, a "bedding-in" process is required. Drive the snowmobile slowly and compress the brake lever several times until the pads just start to heat up; then allow them to cool down. This process stabilizes the pad material and extends the life of the pads.

# Caliper

## REMOVING

1. Slide a piece of flexible tubing over the ball of the bleeder valve and direct the other end into a container.

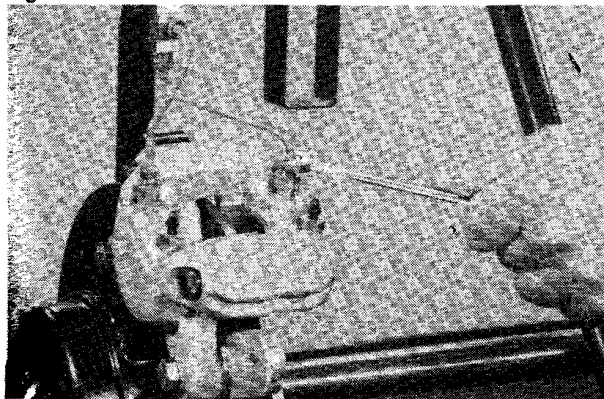
Fig. 4-79



0730-482

2. Open the bleed valve and compress the brake lever several times to drain the reservoir of fluid.
3. Remove the brake hose from the caliper. Use an absorbent towel to collect any remaining brake fluid.

Fig. 4-80



AF244

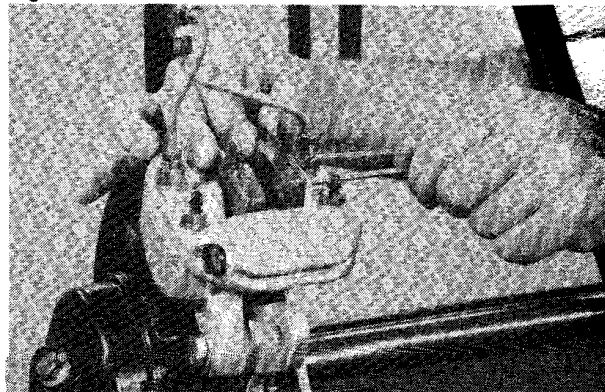


### CAUTION

Brake fluid is highly corrosive. Do not spill brake fluid on any surface of the snowmobile.

4. Remove the safety pin securing the brake pads to the caliper assembly; then remove the brake pads.

Fig. 4-81



AF246

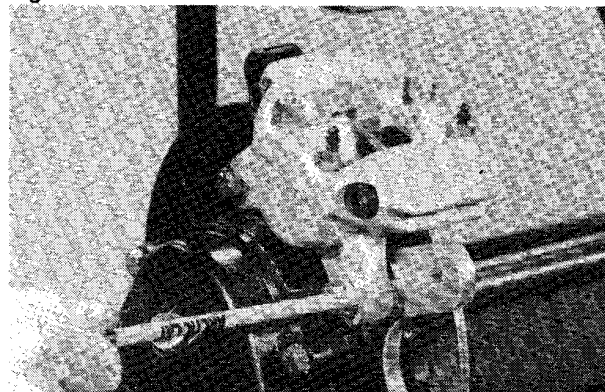
5. Loosen the upper socket-head cap screws which secure the caliper halves; then remove the two cap screws securing the brake caliper to the chain case. Account for two spacer washers.

Fig. 4-82



AF235

Fig. 4-83



AF243



- Remove the caliper assembly from the snowmobile.

### DISASSEMBLING

- Remove the two socket-head cap screws securing the caliper halves.
- Position a piece of wood between the pistons. Using low pressure compressed air, blow into the caliper brake hose fitting to remove the brake piston.

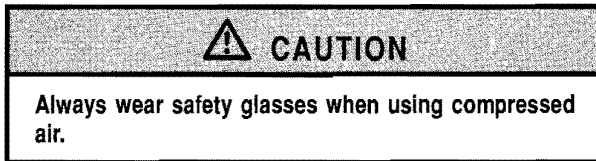
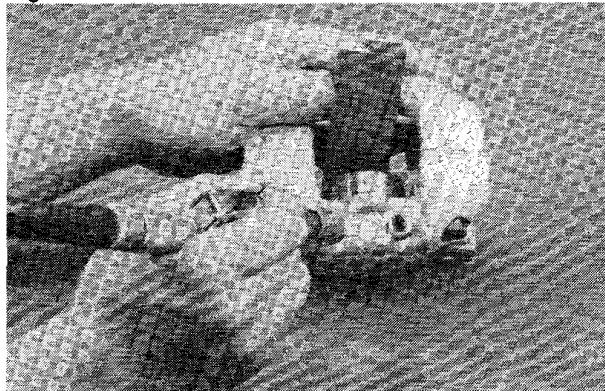


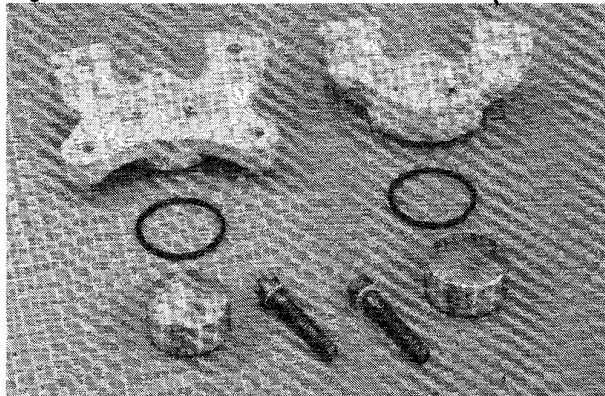
Fig. 4-84



AF248

- Remove the piston O-ring and discard.

Fig. 4-85



AF229

### CLEANING AND INSPECTING

**NOTE:** Whenever a part is worn, cracked, defective, or damaged in any way, replacement is necessary.

- Inspect the brake piston for gouges, cracks, pitting, scuffing, or corrosion. If any of these conditions exist replace the piston.
- To clean the piston outer surface, use a Scotch-Brite pad and clean brake fluid as a cleaner.

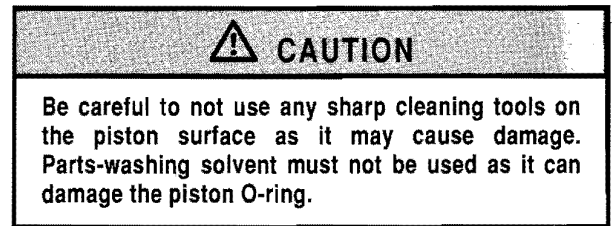
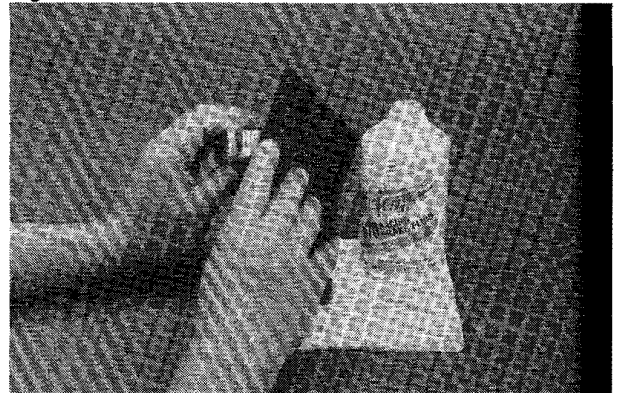


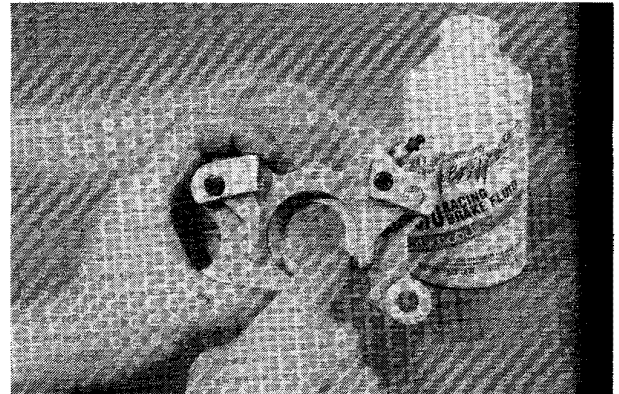
Fig. 4-86



AF230

- Inspect the brake caliper for gouges, cracks, pitting, scuffing, or corrosion. If any of these conditions exist, replace the caliper.
- Clean the caliper inner wall surface using a soft Scotch-Brite pad and clean brake fluid. Wipe caliper wall clean after using the Scotch-Brite with a clean rag and brake fluid.

Fig. 4-87



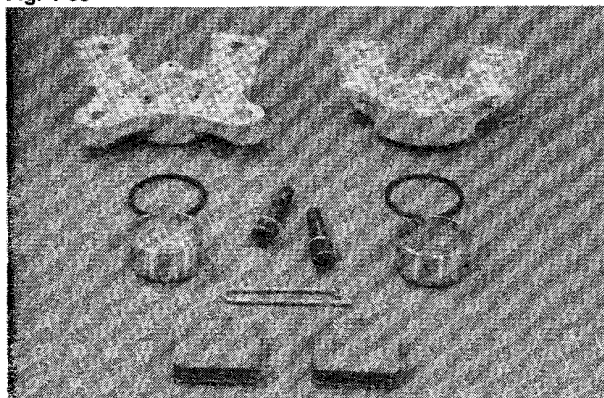
AF267



5. Inspect the condition of the brake pads. Replace if damaged or worn. The brake pad width must be greater than 3.8 mm (0.150 in.). If the brake pad width is less than specified, replacement of both pads is necessary.
6. Inspect the brake hose for cracks, deterioration, and the condition of the threaded connectors.

## ASSEMBLING

Fig. 4-88



AF227

1. Apply Arctco approved brake fluid to the new O-ring; then install the O-ring into the groove of the caliper.

Fig. 4-89



AF231

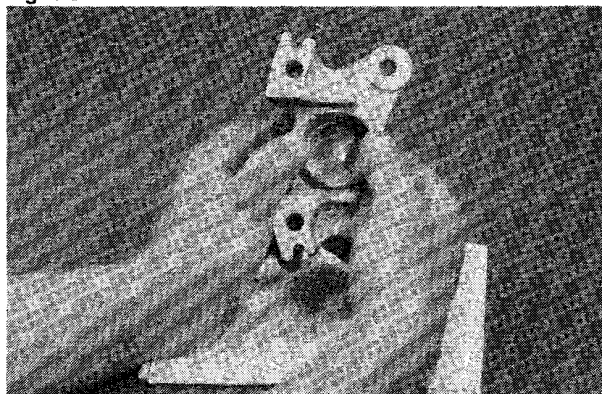
2. In each caliper half, apply Arctco approved brake fluid to the brake piston; then while twisting, install the piston with the open side facing out.

Fig. 4-90



AF232

Fig. 4-91



AF233

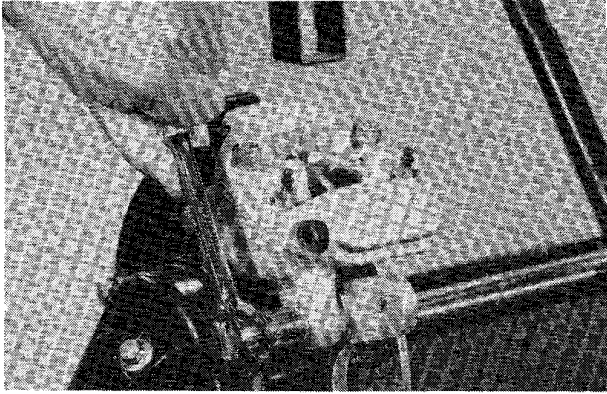
3. Assemble the two caliper halves. Secure with the two socket-head cap screws. Do not tighten at this time.

## INSTALLING

1. Install the caliper assembly on the chain case. Position the two spacer washers between the caliper assembly and chain case; then secure the caliper assembly using two cap screws and washers. Torque the cap screws to 3.5 kg-m (25 ft-lb).



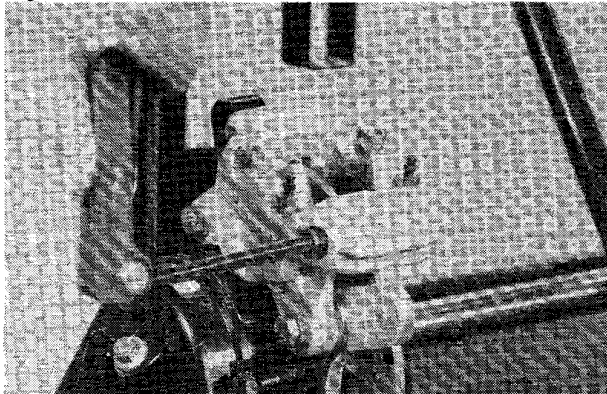
Fig. 4-92



AF249

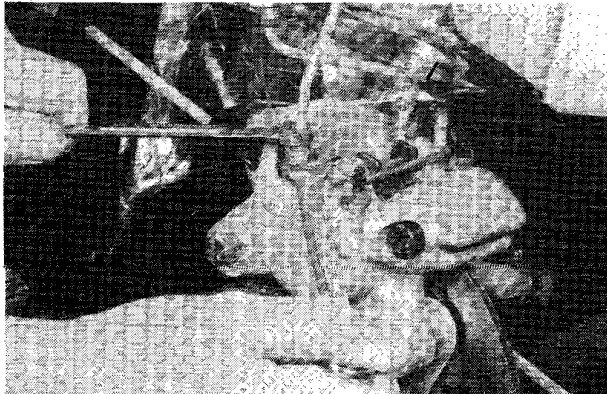
2. Torque the two socket-head screws securing the caliper halves 3.5 kg-m (25 ft-lb).

Fig. 4-93



AF250

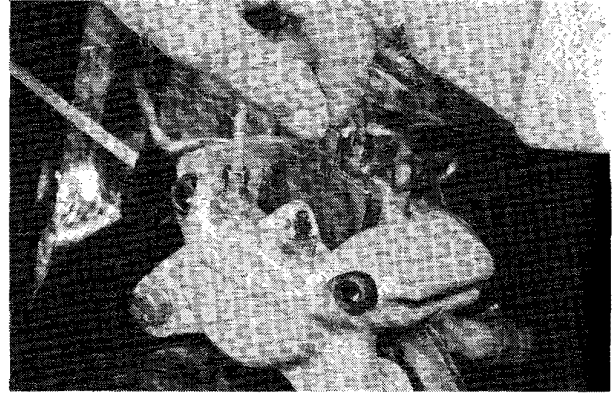
Fig. 4-94



AF263

3. Install the brake pads. Secure with the safety pin.

Fig. 4-95



AF258

4. Bleed the brake system (see Bleeding Brake System section).

**⚠ CAUTION**

If new brake pads were installed, a "bedding-in" process is required. Drive the snowmobile slowly and compress the brake lever several times until the pads just start to heat up; then allow them to cool down. This process stabilizes the pad material and extends the life of the pads.

# SECTION 5 - ELECTRICAL SYSTEM

## TABLE OF CONTENTS

Electrical Specifications . . . . .	120
Testing Ignition System . . . . .	121
Testing Main Wiring and Safety Switches . . . . .	122
Testing Brakelight . . . . .	122
Testing Headlight Dimmer Switch . . . . .	122
Removing Dimmer Switch . . . . .	123
Installing Dimmer Switch . . . . .	123
Testing <i>Ignition Coil Output</i> . . . . .	123
Testing CDI Unit Output . . . . .	124
Testing Charge Coil (1) Output . . . . .	124
Testing Charge Coil (2) Output . . . . .	124
Testing RPM Sensor Output . . . . .	124
Testing Injector Timing Sensor Output . . . . .	125
Testing Lighting Coil Output (Battery Charging Circuit) . . . . .	125
Testing Lighting Coil Output (Lighting System) . . . . .	125
Testing Electrical Resistances . . . . .	125
Ignition Coil (Primary) . . . . .	125
Ignition Coil (Secondary) . . . . .	126
Charge Coil (1) . . . . .	126
Charge Coil (2) . . . . .	126
Lighting Coil . . . . .	126
Spark-Plug Cap . . . . .	127
Ignition Timing Sensor . . . . .	127
Crankshaft Position Sensor . . . . .	127
Battery Charge Coil . . . . .	127
Checking Ignition Timing . . . . .	127
Testing Voltage Regulator . . . . .	128
Testing Warning Light Posistor . . . . .	128
Testing Low-Oil Light Sending Unit . . . . .	128
Testing High Temperature Sensor . . . . .	129
Testing High Temperature Warning Light . . . . .	129
Testing Key Switch . . . . .	129
Testing Handlebar Heater Elements . . . . .	129
Testing Thumb Warmer Element . . . . .	130
Testing Heater Switch . . . . .	130
Battery Charging System . . . . .	131
AC/DC Voltage Rectifier/Regulator . . . . .	132
Wire Color Code and Function Description . . . . .	132
Wiring Diagram (EFI System) . . . . .	134
Wiring Diagram (Hood/Main Harness) . . . . .	135
Wiring Diagram (EFI System Harness) . . . . .	136



## Electrical Specifications

Description	Resistance Test	Test Connections	
	Test Value	+	-
Ignition Coil Primary Secondary	0.30 ohm $\pm$ 15% 6300 ohms $\pm$ 20%	white high tension lead	black high tension lead
Charge Coil (1)	450 ohms $\pm$ 20%	green/red	black/red
Charge Coil (2)	45 ohms $\pm$ 20%	green/red	brown/white
Crankshaft Position Sensor	190 ohms $\pm$ 20%	white/black	brown
Ignition Timing Sensor	101 ohms $\pm$ 20%	green/white	brown
Battery Charge Coil (90 watt)	0.20 ohms $\pm$ 20%	yellow/red	yellow/red
Lighting Coil (150 watt)	0.14 ohms $\pm$ 20%	yellow	brown
Spark-Plug Cap	5000 ohms $\pm$ 20%	cap	cap

Description	Output Test	Test Connections	
	(Model 1L Tester)	+	-
Ignition Coil	75 HIGH	high tension lead	high tension lead
CDI Unit	85 HIGH	black/white	white/blue
Charge Coil	40 HIGH	green/red	black/red
Charge Coil Trigger	75 HIGH	green/red	brown/white
Ignition Timing Sensor	45 LOW	green/white	brown
Crankshaft Position Sensor	40 LOW	white/black	brown
Lighting Coil	80 LOW	yellow	brown
Battery Charge Coil	85 LOW	yellow/red	yellow/red

Description	
Lighting Coil Output	12V/240W
Spark Plug	NGK BR9ES
Spark-Plug Gap	0.7 mm (0.028 in.)
Ignition Timing (Non-adjustable)	30° BTDC @ 4000 RPM 5.671 mm (0.223 in.)

## Testing Ignition System

The ignition system used on this model (KOKUSAN DENKI CDI) is of the "closed" type. The "closed" ignition system offers a safety advantage to the consumer in that the ignition is dependent on a complete circuit for its ground. If the circuit is broken (connection should lose contact or a connector should become pulled apart), ignition is lost and the engine will instantly stop.

The troubleshooting procedure for the "non-closed" ignition system cannot be used when troubleshooting the "closed" ignition system. Instead, use the following procedure.

1. Remove the spark plugs and visually check their condition. Replace any fouled plugs. Attach the spark plugs to the high tension leads and ground them on the cylinder head(s).

### CAUTION

Never crank the engine over without grounding the spark plugs. Damage to coils and/or CDI unit may result.

### WARNING

Before performing step 2, leave switches in the OFF position and crank the engine over to clear engine of fuel in the event it is flooded. Clean area of any fuel that comes out the spark-plug holes with a clean cloth. While performing step 2, hold the throttle lever in the full-open position to prevent fuel from being injected into the engine.

**NOTE:** Make sure all switches are in the ON position and the tether-switch cap is installed.

2. Crank the engine over quickly and check for spark. If no spark is present, proceed to step 3.
3. Below are some causes that can create a no-spark situation. If no-spark situation occurs, refer to the causes below for assistance in locating the problem.
  - a. Fouled Spark Plugs - Inspect spark plug condition and replace if necessary.

- b. Discharged Battery - Inspect battery condition, remove battery and recharge if necessary.
- c. Bad Brown Fuse Link Wire - Test fuse link wire according to procedure found in EFI Fuel System section of this manual.
- d. EFI Relay - Check EFI relay according to procedure found in EFI Fuel System section of this manual.
- e. Throttle Cable Tension Too Tight - Loosen cable to obtain 0.030 free play in throttle lever.
- f. Defective Ignition Switch - Test switch for proper operation.
- g. Defective Tether Switch - Test tether switch for proper operation.
- h. Defective Safety Switches in Throttle Control Handle - Test switches following procedures in this section.
- i. Defective Ignition Coils (charge coils - external coil) - Perform resistance test according to procedures in this section.
- j. Defective Timing Sensor - Test sensor according to procedure in this section.
- k. Defective ECU or bad connection in wiring harness.
- l. Corroded or loose wire connection at the throttle-control wiring harness connector, ignition switch, tether switch, or main wiring harness.

Check all these possible causes following the test procedures given in the EFI Fuel System and Electrical sections of this manual. Starting with cause "a", work your way down through "l" until the problem is found.



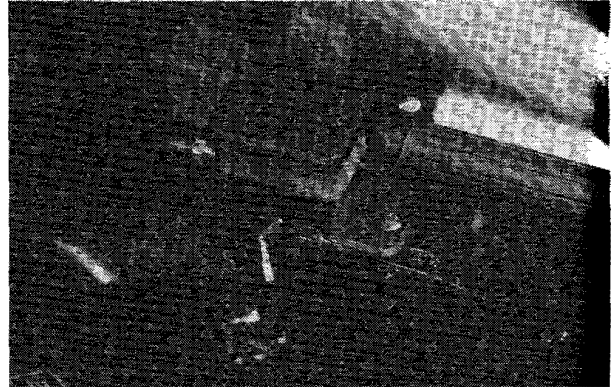
## Testing Main Wiring and Safety Switches

1. Check wire connections at ignition switch and at the throttle-control wiring harness for tightness and cleanliness. If connections appear dirty or corroded, clean with fine sandpaper and compressed air; then connect all wires and squeeze connections with a pliers for added tightness.
2. Disconnect the ignition switch and connect the ohmmeter leads to each of the probes on the back of the switch. If the meter reads OPEN (with switch in ON position), replace the switch. If the meter reads CLOSED, proceed to step 3.
3. Disconnect the two connectors from the tether switch. Connect one ohmmeter lead to each of the leads from the switch. With the cap correctly installed, the meter must read CLOSED. If the meter reads OPEN, replace the tether switch. If the meter reads CLOSED, proceed to step 4.
4. Disconnect the two-prong connector located under the rubber boot on the front side of the steering post. Using an ohmmeter, connect the meter leads to the two black wires from the throttle switch assembly. With the emergency stop switch in the ON (pulled up) position and the throttle lever in the closed position, the meter must read CLOSED. If the meter reads OPEN, push the throttle lever full-closed against the throttle housing. If the meter now reads CLOSED, tension the throttle cable. If the meter remains OPEN, replace the throttle assembly.
5. With the ohmmeter leads still connected, compress the throttle lever to full-open position. The meter must remain CLOSED. If the meter reads OPEN with the throttle lever compressed, replace the throttle control.
6. With the ohmmeter leads still connected, alternately release and compress the throttle lever; then move the emergency stop switch down and up. The meter must read OPEN with the emergency stop switch in the down position.

## Testing Brakelight

1. Disconnect the wiring harness from the brake light switch located on the back side of the brake light assembly.

Fig. 5-1



AF201

2. To test the brakelight switch, connect one ohmmeter lead to each spade connector on the brakelight switch.
3. With the brake lever compressed, the meter must read CLOSED. With the brake lever released, the meter must read OPEN. If the meter does not read as specified, the brakelight switch is defective and must be replaced.
4. To replace the brakelight switch, turn the switch counterclockwise out of the brake lever assembly. Install a new switch and attach the wiring harness.

## Testing Headlight Dimmer Switch

1. Disconnect the headlight dimmer switch three-prong plug (located behind the console).
2. To test the headlight dimmer switch, use the tester connections indicated in the following chart. If the meter does not read as specified, the headlight dimmer switch is defective and must be replaced.

Position	Lead to Terminal (Wire Color)	Lead to Terminal (Wire Color)	Meter Reading
High Beam	1 (Yellow)	2 (Blue)	CLOSED
High Beam	1 (Yellow)	3 (White)	OPEN
Low Beam	1 (Yellow)	2 (Blue)	OPEN
Low Beam	1 (Yellow)	3 (White)	CLOSED

## Removing Dimmer Switch

1. Remove the two screws from the cover plate securing the dimmer switch. Remove the plate and lift the switch free of the brake control.
2. Remove the handlebar pad; then cut the cable ties securing the switch harness to the handlebar and remove the harness.

## Installing Dimmer Switch

1. Place the dimmer switch into position in the brake control and secure with the cover plate and two screws.
2. Connect the switch harness to the main wiring harness. Position the wires so they will not be either pinched or come in contact with any moving parts. Install the handlebar pad. Start the engine and check the switches for proper operation. Position cable ties around the handlebar and switch harness.

## Testing Ignition Coil Output

Before testing ignition coil output (after testing the main wiring harness and safety switches), all wiring harnesses must be connected. Also, check to be sure all switches (ignition switch and emergency stop switch) are in the ON position and the tether switch cap is installed. Ignition coil output may be tested by using either one of the following procedures:

To test ignition coil output using the Electro-Specialties Model 1L Tester, use the following procedure:

### WARNING

For safety purposes, raise the rear of the snowmobile off the floor using a shielded safety stand.

1. Remove the resistor spark plug from the MAG-side cylinder and the spark-plug cap; then install an NGK B8EV plug with a non-resistor-type spark-plug cap (or a metal connector).
2. Connect the MM-1 adapter to the spark-plug wire. Attach the red tester lead to the engine.

### CAUTION

Spark plugs must be installed or damage to the coils and/or CDI unit may result.

3. Set the tester on 75 HIGH scale. Crank the engine over quickly. If the tester light illuminates, output is satisfactory. If the tester light fails to illuminate, proceed to Testing CDI Unit Output. Test three times for conclusive results.

To visually test ignition coil output, use the following procedure:

1. Remove the spark plugs from the cylinders, connect to the high tension leads, and ground on the cylinder heads.

**NOTE:** Adjust spark-plug gap to 0.125 to 0.130 in. for this test.

5



2. Crank the engine over quickly and inspect for a bright blue spark. If a bright blue spark is present, ignition coil output is satisfactory. If no spark is present, proceed to Testing CDI Unit Output.

## Testing CDI Unit Output

1. Disconnect the double-wire plugs from the CDI unit to the ignition coil.
2. Using the wire adapter harness, connect the yellow tester lead to the white/blue lead in the double-wire plug; connect the red tester lead to the black/white lead in the double-wire plug.
3. Set the tester on 85 HIGH scale. Crank the engine over quickly. If the tester light illuminates, CDI unit output is satisfactory. This pinpoints the ignition coil, spark plugs, or spark-plug caps as being defective if ignition coil output was not satisfactory. Test three times for conclusive results. Before replacing the ignition (if the ignition coil seems to be the problem), make sure its connections are not corroded or loose. If the tester light fails to illuminate, proceed to Testing Charge Coil Output.

## Testing Charge Coil (1) Output

1. Disconnect the triple-wire plug from the CDI unit to the magneto
2. Connect the red tester lead to the green/red wire in the triple-wire plug; connect the black tester lead to the black/red wire.
3. Set the tester on 40 HIGH scale. Crank the engine over quickly. If the tester light illuminates, charge coil output is satisfactory; proceed to Testing Charge Coil (2) Output. If the tester light fails to illuminate, replace the charge coil. Test three times for conclusive results.

## Testing Charge Coil (2) Output

1. Disconnect the triple-wire plug from the CDI unit to the magneto; disconnect the single black wire outside the triple-wire plug.
2. Connect the red tester lead to the green/red wire in the triple-wire plug; using the wire adapter harness, connect the yellow tester lead to the brown/white wire in the triple-wire plug.
3. Set the tester on 75 HIGH scale. Crank the engine over quickly. If the tester light illuminates, charge coil output is satisfactory. If the tester light fails to illuminate, replace the charge coil. Test three times for conclusive results.

**NOTE:** If both the charge coils (1) and (2) tested out satisfactory but the tester light did not illuminate in the CDI Unit Output Test, replace the CDI unit.

## Testing RPM Sensor Output

**NOTE:** The ignition switch must be in the OFF position during the RPM sensor test.

1. Disconnect the two-wire plug from the RPM sensor where it connects to the ECU wiring harness, just behind the recoil housing.
2. Connect the red tester lead to the green/white lead and the yellow lead to the brown lead.
3. Set the test on 45 LOW scale. Crank the engine over quickly. If the tester light illuminates, the RPM sensor output is satisfactory. If the tester light fails to illuminate, replace the RPM sensor. Test three times for conclusive results.

## Testing Injector Timing Sensor Output

1. Disconnect the double plug from the injector timing sensor located on top of the flywheel housing.
2. Connect the red tester lead to the white/black wire in the double plug and connect the yellow tester lead to the remaining brown wire in the double plug.
3. Set the tester on 40 LOW scale. Crank the engine over quickly. If the tester light illuminates, the injector timing sensor is satisfactory. If the tester light fails to illuminate, replace the injector timing sensor. Test three times for conclusive results.

## Testing Lighting Coil Output (Battery Charging Circuit)

**NOTE:** There are two lighting coil outputs that must be tested. The two yellow/red wires located in the four prong connector are used to charge the battery. The single yellow wire and brown lead is used for lighting system and accessories. When conducting either lighting coil test, the ignition switch should be in the OFF position.

1. Disconnect the four-wire plug from the magneto.
2. Connect the red tester lead to one of the yellow/red wires; connect the yellow tester to the other yellow/red wire.
3. Set the tester on 80 LOW scale.
4. Crank the engine over quickly. If the tester light illuminates, lighting coil output is satisfactory. Test three times for conclusive results.
5. If the tester light fails to illuminate, the lighting coil wires should be checked for breaks, corrosion, and looseness. If the connections are tight and free of corrosion, replace the coil ring.

## Testing Lighting Coil Output (Lighting System)

**NOTE:** There are two lighting coil outputs that must be tested. The two yellow/red wires located in the four prong connector are used to charge the battery. The single yellow wire and brown lead is used for lighting system and accessories. When conducting either lighting coil test, the ignition switch should be in the OFF position.

1. Disconnect the four-wire plug from the magneto.
2. Connect the red tester lead to one of the yellow wires; connect the brown tester to the other brown wire.
3. Set the tester on 80 LOW scale.
4. Crank the engine over quickly. If the tester light illuminates, lighting coil output is satisfactory. Test three times for conclusive results.
5. If the tester light fails to illuminate, the lighting coil wires should be checked for breaks, corrosion, and looseness. If the connections are tight and free of corrosion, replace the lighting coil.

## Testing Electrical Resistances

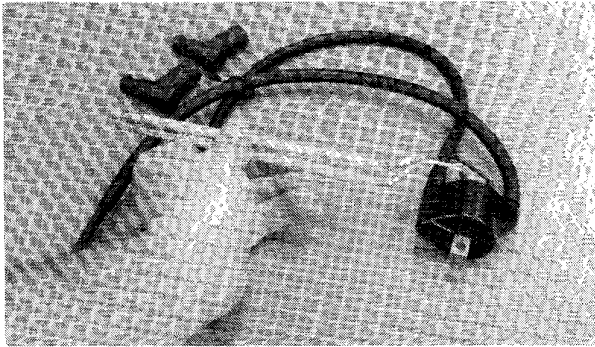
**NOTE:** All resistance tests of the engine electrical components can be made using a multimeter. Replace any component that does not have a test value within specifications.

### IGNITION COIL (PRIMARY)

1. Disconnect the double-wire plug from the CDI unit to the ignition coil
2. Set the selector on the X1 position; then touch the leads and zero the meter.
3. Connect the red meter lead to the white lead; connect the black meter lead to the black lead.



Fig. 5-2



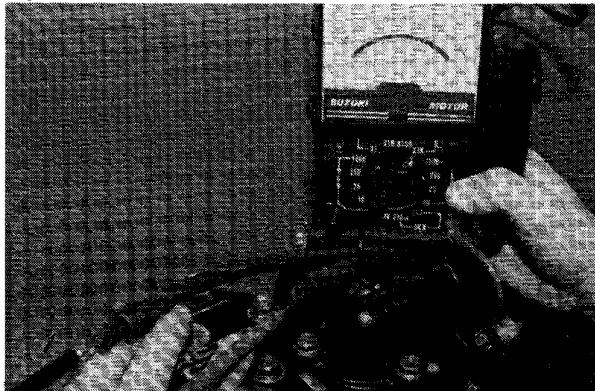
AO041

4. Ignition coil primary resistance must be 0.30 ohm  $\pm$  15%.

### IGNITION COIL (SECONDARY)

1. Remove the spark-plug caps from the high tension wires.
2. Set the selector on the X1K position; then touch the leads and zero the meter.
3. Connect one meter lead to each high tension wire.

Fig. 5-3



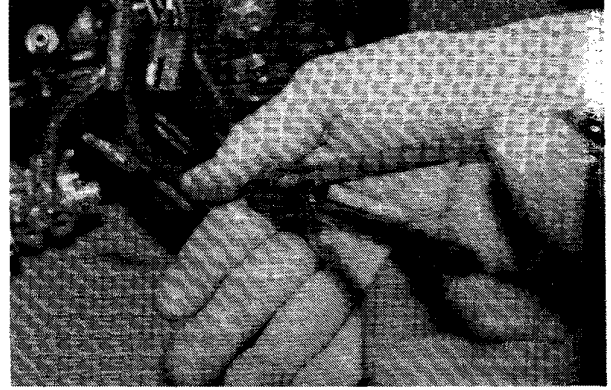
AK012

4. Ignition coil secondary resistance must be 6300 ohms  $\pm$  20%.

### CHARGE COIL (1)

1. Disconnect the triple-wire plug from the CDI unit to the magneto.
2. Set the selector on the X100 position; then touch the leads and zero the meter.
3. Connect the red meter lead to the green/red lead; connect the black meter lead to the black/red lead.

Fig. 5-4



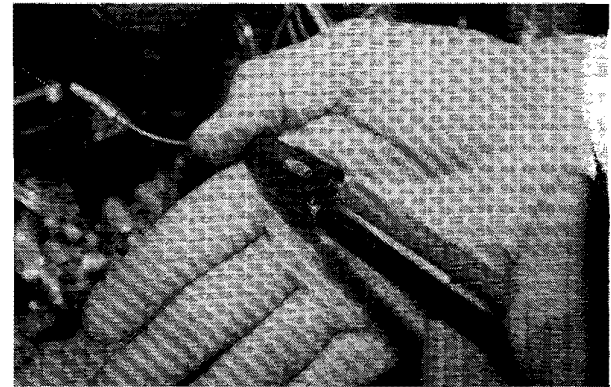
AK013

4. Charge coil resistance must be 450.0 ohms  $\pm$  20%.

### CHARGE COIL (2)

1. Disconnect the triple-wire plug from the CDI unit to the magneto.
2. Set the selector on the X1 position; then touch the leads and zero the meter.
3. Connect the red meter lead to the green/red lead; connect the black meter lead to the brown/white lead.

Fig. 5-5



AK014

4. Charge coil (2) resistance must be 45.0 ohms  $\pm$  20%.

### LIGHTING COIL

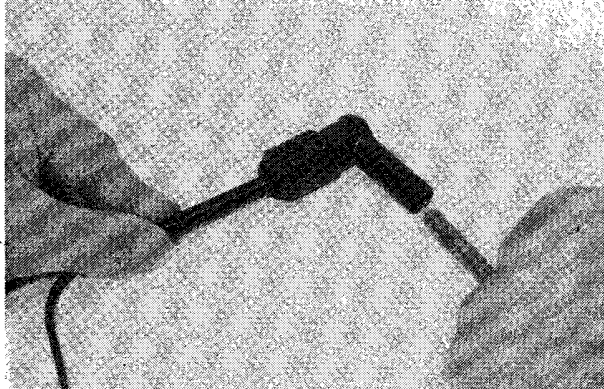
1. Disconnect main wiring harness from the engine.
2. Set the selector on the X1 position; then touch the leads and zero the meter.
3. Connect the red meter lead to a yellow wire; connect the black meter lead to the brown ground wire outside the four prong connector.

4. Lighting coil resistance must be  $0.14 \text{ ohm} \pm 20\%$ .

### SPARK-PLUG CAP

1. Remove spark-plug cap from high tension wire.
2. Set the selector on the X1K position; then touch the leads and zero the meter.
3. Connect one meter lead to one end of the cap; connect the other meter lead to the other end of the cap.

Fig. 5-6



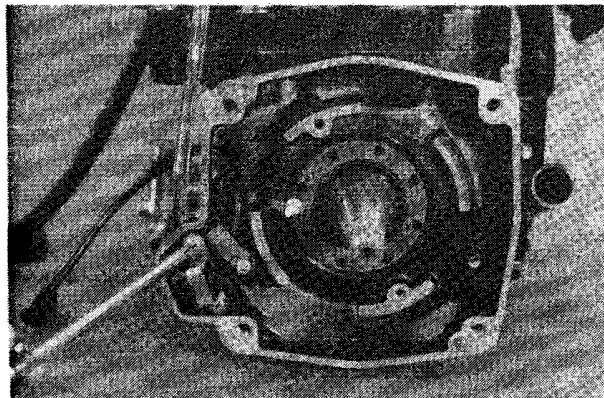
B170

4. Spark-plug cap resistance must be  $5000 \text{ ohms} \pm 20\%$ .

### IGNITION TIMING SENSOR

1. Disconnect the green/white and brown wires from the timing sensor to the main harness.

Fig. 5-7



AO001

2. Set the ohmmeter on the X100 position and zero the meter.
3. Connect the red tester lead to the green/white wire. Connect the black tester lead to the brown sensor lead.

4. Reading must be  $101 \text{ ohms} \pm 20\%$ .

### CRANKSHAFT POSITION SENSOR

1. Disconnect the white/black and brown wires from the injector timing sensor to the main harness.
2. Set the ohmmeter on the X100 position and zero the meter.
3. Connect the red tester lead to the white/black sensor wire and the black tester lead to the brown sensor wire.
4. Reading must be  $190 \text{ ohms} \pm 20\%$ .

### BATTERY CHARGE COIL

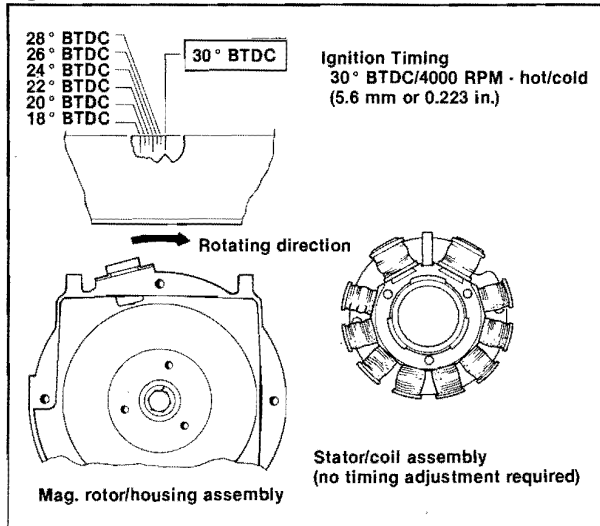
1. Disconnect the main wiring harness four-prong connector from the engine.
2. Set the ohmmeter on the X1 position and zero the meter.
3. Connect the ohmmeter leads to the two yellow/red leads in the four prong plug.
4. Reading must be  $0.20 \text{ ohms} \pm 20\%$ .

## Checking Ignition Timing

1. Connect a timing light to the MAG-side spark-plug lead.
2. Using a shielded safety stand, raise the rear of the snowmobile off the floor and start the engine. Gradually increase the engine speed to 4000 RPM. The pointer should align with the proper timing mark on the flywheel (see Fig 5-12).



Fig. 5-8



3. If timing is not correct, inspect the timing sensor to ensure it is secure on the magneto housing. Check connections to make sure they are clean and tight.
4. If connections are good, see Ignition Timing Sensor section.
5. If the timing sensor checks out good, inspect the flywheel and crankshaft keyway for twisting.
6. If all components test within specifications, install a new CDI unit and recheck timing.

## Testing Voltage Regulator

1. Using a shielded safety stand, raise the rear of the snowmobile off the floor.
2. Using a multimeter, connect the red tester lead to a yellow lead and the black tester lead to a brown lead in the accessory harness connector.
3. Set the selector on the 25 ACV position; then start the engine and allow it to idle. The meter must read 11-13 volts.
4. Increase engine speed to 2500-2700 RPM. The meter must read 11-13 volts. If the meter reads more than 13 volts, replace the voltage regulator.

## Testing Warning Light Posistor

1. Disconnect the posistor from the harness connector.
2. Connect an ohmmeter between the posistor terminals.
3. The ohmmeter must read less than 65 ohms at less than +80°F. Slowly raise the temperature of the posistor element. The ohmmeter must read more than 200 ohms at more than +135°F.

**NOTE: DO NOT USE AN OPEN FLAME to heat the posistor. An open flame will destroy the posistor body. Cigarette lighters, matches, or propane torches are NOT suitable heat sources. Hot air guns and ovens are suitable heat sources.**

## Testing Low-Oil Light Sending Unit

The low-oil light sending unit is a magnetic switch. Its operation is based on a doughnut magnet located around the inside diameter of a 1/2 in. hole in a plastic float. The switch, located in the stem of the sending unit, is positioned through the hole in the float. When the float drops to the lower part of the stem, the magnet closes the electrical contacts (located in the stem) allowing current to pass on to the light in the console.

**NOTE: Check the oil-sending unit bulb in the console and posistor for proper operation (see Testing Warning Light Posistor).**

If the sending unit should fail, it must be replaced. To test the sending unit, use the following procedure:

1. Remove the sending unit from the oil tank by twisting and pulling upwards. Wipe oil from the sending unit with a cloth.
2. Unplug the sending unit wires from the wiring harness.
3. Using an ohmmeter, set the scale selector knob on the X1K position.

4. Touch each of the meter leads to one of the two wires coming from the sending unit. With the sending unit in its normal position (float end down), the meter should read **CLOSED**.
5. If the meter reads **OPEN**, double check to make sure you have made good contact with each of the wires coming from the sending unit. If the meter still reads **OPEN**, replace the sending unit.
6. While maintaining contact between the meter leads and the sending unit, raise the float up. The meter must read **OPEN**. If the meter reads **CLOSED**, replace the sending unit.
7. If the sending unit tested out satisfactorily but the light in the console doesn't illuminate with only a small amount of oil in the oil tank, check the bulb in the console.
8. If the bulb is in good condition, check for voltage at the connection where the sending unit plugs into the wiring harness. Using a voltmeter set on the 50 ACV scale, start the engine and allow it to idle. Touch the red lead of the voltmeter to the red wire in the two prong connector. Touch the black lead of the voltmeter to the black lead in the wiring harness. At idle, the meter should read 5 to 6 volts (AC). If no voltage is present, but the lights on the snowmobile operate normally, either check the wiring harness for a broken wire or replace the harness.

## Testing High Temperature Sensor

1. Disconnect the main wiring harness connector from the water temperature sensor.
2. Connect an ohmmeter between the sensor terminal and any convenient chassis ground (or any brown wire). The ohmmeter must read less than 20 ohms of resistance with the water temperature higher than 230°F. The ohmmeter must read **OPEN** (infinite resistance) with the water temperature lower than 190°F.

**NOTE:** It may be easier to remove the sensor from the water manifold for testing purposes. Immerse the sensor body (only up to the threads) in automatic transmission fluid and slowly heat the fluid. The ohmmeter must indicate the above resistances when connected between the sensor terminal and the sensor body/chassis.

## Testing High Temperature Warning Light

1. Disconnect the main wiring harness connector from the water temperature sensor.
2. Temporarily place a jumper wire from the main wiring harness sensor connector to any convenient chassis ground (or any brown wire).
3. If the high temperature warning light is not illuminated with the engine running (and the harness terminal grounded), test the light bulb. An ohmmeter must read less than 10 ohms across the bulb filament.
4. If the bulb does not illuminate even when tested good, use the ohmmeter to test the bulb harness. Also, test the red/white wire continuity from the temperature sensor connector to the bulb connector.

## Testing Key Switch

5

1. Remove the main wiring harness connectors from the key switch.
2. Rotate the key to the **OFF** position.
3. The ohmmeter must read **OPEN** (infinite resistance) between the key switch terminals (X and Y).
4. Rotate the key to the **RUN** position.
5. The ohmmeter must indicate less than 1 ohm of resistance between the key switch terminals (X and Y).

## Testing Handlebar Heater Elements

1. Disconnect the handlebar heater elements from the main wiring harness and the handlebar heater switch.



2. Connect the ohmmeter between the handlebar heater element lead wires.
3. The ohmmeter must read between 3.5 and 5.5 ohms. If the ohmmeter indicated less than 3.5 ohms or more than 5.5 ohms, proceed to step 4.
4. Disconnect any one of the four handlebar heater element lead wires from the others so that each element can be measured separately.
5. Connect the ohmmeter to one element at a time. An individual element must indicate no less than 7 ohms or no more than 11 ohms.

**NOTE: Overheating will occur on elements measuring less than 7 ohms and insufficient heating will occur on elements measuring more than 11 ohms.**

6. Replace any element measuring less than 7 ohms or more than 11 ohms.

## Testing Thumb Warmer Element

1. Disconnect the thumb warmer element from the main wiring harness and the thumb warmer ON-OFF switch.
2. Connect an ohmmeter lead to each of the thumb warmer element lead wires.
3. The ohmmeter must read between 38 and 48 ohms. If the meter reading is not within specifications, replace the thumb warmer element.

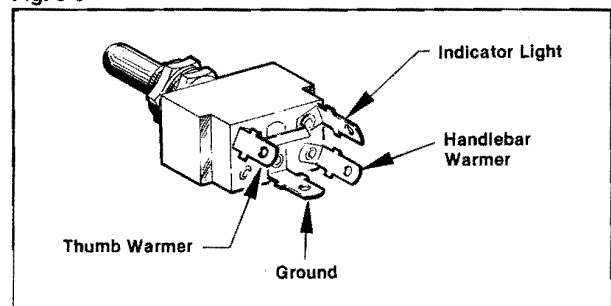
## Testing Heater Switch

The heater switch is designed to turn the thumb warmer on by itself or to turn on both the thumb warmer and handlebar warmers together.

1. Disconnect the four wire connectors from the heater switch.

2. Connect one of the ohmmeter leads to the center (ground) terminal. Connect the remaining lead to the single (handlebar warmer) terminal on the switch.

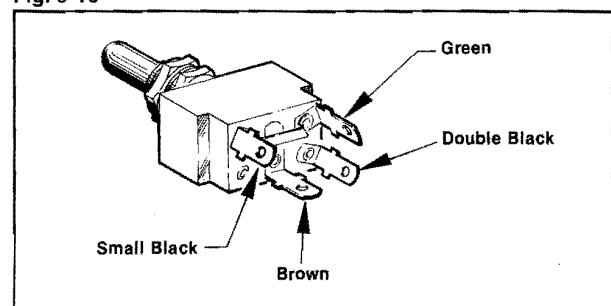
Fig. 5-9



0728-682

3. With the toggle switch flipped away from the groove in the neck of the switch, the ohmmeter must read less than 1 ohm. With the toggle switch in either of the other two positions, the ohmmeter must read OPEN (infinite resistance).
4. Maintain one ohmmeter lead on the center (ground) terminal and connect the remaining ohmmeter lead to one of the jumpered terminals (thumb warmer and indicator light terminals). The ohmmeter must read less than 1 ohm with the toggle switch in the right and left (ON) positions. The ohmmeter must read OPEN (infinite resistance) with the toggle switch in the center (OFF) position.
5. Attach the connectors to the switch according to Fig. 5-14.

Fig. 5-10



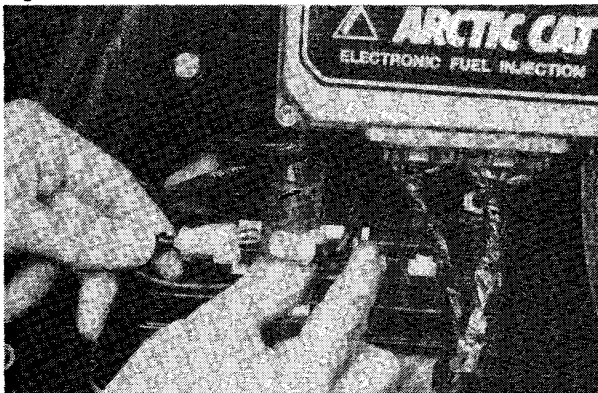
0728-682

## Battery Charging System

The battery light must illuminate with all switches in the ON position before starting the engine. Once the engine starts, the light must go out. This indicates the charging system is working correctly. If the light remains illuminated after the engine has started, the charging system is not working correctly. Follow this procedure to determine the defective component:

1. Place the multimeter in DC volt position. Start the engine. Touch the red lead to the battery positive post. Touch the black lead to the negative post. 13.5 volts must be indicated. If no voltage is indicated, proceed to step 2.
2. Inspect the fuse in the yellow fuse holder by the battery. Replace if burnt. If the fuse is good, proceed to step 3.

Fig. 5-11



AK031

3. Place the multimeter on the DC amp position. Start the engine. Test between the two yellow fuse holder wires. Touch the black lead to the fuel holder connected to the battery. Touch the red lead to the remaining fuse holder. The charging rate should be 2 to 10 amps depending on engine RPM. If amperage is not indicated proceed to testing lighting coil output step 4.

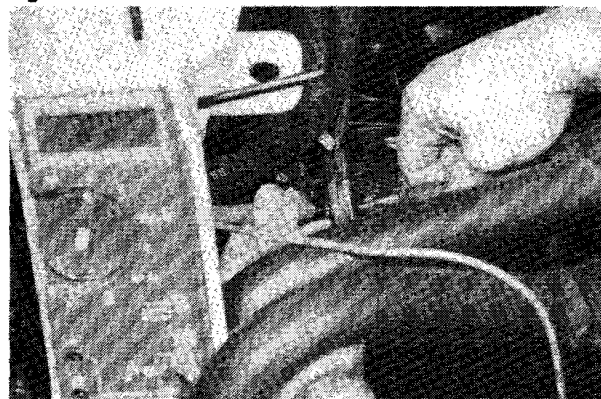
Fig. 5-12



AK032

4. Place the multimeter on the AC volt position. Slightly spread the main four-prong wiring harness connector. Start the engine. Touch the two tester leads to the two yellow/red wires in the four prong connector. AC volts should be indicated depending on engine RPM. If voltage is not indicated, replace the lighting coil.

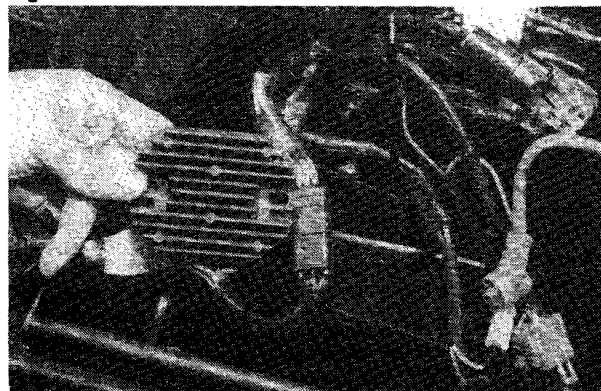
Fig. 5-13



AK034

5. If voltage is indicated in step 3 but not in step 2, replace the AC/DC voltage rectifier/regulator.

Fig. 5-14



AK033

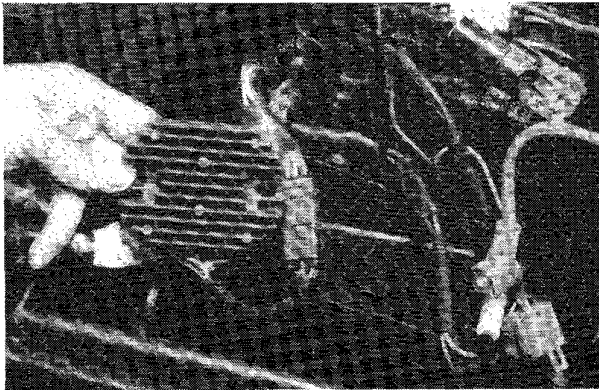


## AC/DC Voltage Rectifier/Regulator

### REMOVING

1. Disconnect the negative cable and then the positive battery cable from the battery.
2. Remove the wing nut securing the battery hold down; then remove the hold down and battery.
3. Remove the two nuts and washers securing the rectifier/regulator to the steering support; then disconnect the wiring harness and remove from the engine compartment.

Fig. 5-15



AK033

### INSTALLING

1. Connect the main wiring harness to the rectifier/regulator; then secure it to the steering support with two washers and nuts.
2. Install the battery and battery hold down. Secure with a wing nut.
3. Connect the positive battery cable to the battery; then the negative.

### WARNING

The positive cable must be connected first.

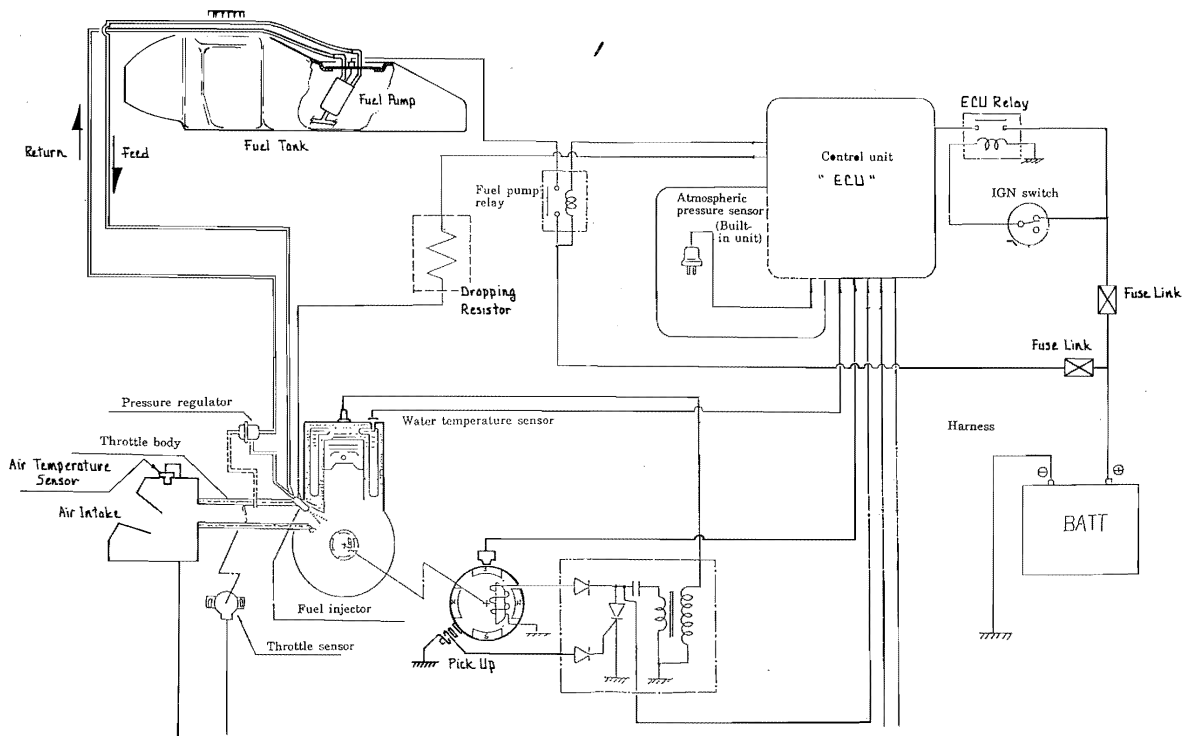
## Wire Color Code and Function Description

**NOTE:** The following wire color code and function description will assist in using the wiring diagrams in this section. Note that some colors are numbered (i.e. Red #1, Red #2, and Red #3). When you see a numbered color on any of the wiring diagrams, refer to the color code description sheet, and it will provide you with additional information.

COLOR	FUNCTION — DESCRIPTION
<b>Brown</b>	<b>Electrical Common; Chassis Ground</b>
	The brown wire is connected to the chassis at the engine stator plate and also through the voltage regulator chassis bolt (prior to 1989, the taillight harness also had a chassis connection). The headlight bracket is grounded on some models to reduce the bracket RFI emissions. All brown wires are common ground.
<b>Yellow</b>	<b>AC Power; 13 Volts AC (Alternating Current)</b>
	The yellow wire is connected to the engine stator plate lighting coil and the voltage regulator. The voltage produced by the lighting coil is very engine RPM dependent. The voltage regulator is necessary to maintain 13.5 VAC on the yellow wire whenever the engine exceeds about 3000 RPM. All yellow wires are 13 VAC. The signal on the yellow wire is AC. Not only is the voltage <b>level</b> of this signal RPM dependent, but the signal <b>frequency</b> (cycles per second) is RPM dependent as well. The electric tachometer uses this changing frequency phenomenon to indicate the engine RPM. An electric tachometer will operate properly when connected to any yellow (13 VAC) and brown (common) wire pair.
<b>White</b>	<b>Headlight Low Beam</b>
	The white wire connects the dimmer switch to the headlight bulb. The low beam filament will illuminate when the dimmer switch connects the white wire to 13 VAC power.
<b>Blue</b>	<b>Headlight High Beam and Indicator Light</b>
	The blue wire connects the dimmer switch to the headlight bulb. The high beam will illuminate when the dimmer switch connects the blue wire to 13 VAC power. Some models use a tachometer with a high beam indicator light. The high beam indicator light will also illuminate when the dimmer switch connects the blue wire to 13 VAC power.
<b>Green</b>	<b>Handlebar Heater Indicator Light</b>
	Some models use a tachometer with a handlebar heater indicator light. The green wire connects the handlebar heater on-off switch to the "warmer" indicator light. The "warmer" light will illuminate when the handlebar heater switch connects the green wire to common ground.

COLOR	FUNCTION — DESCRIPTION
<b>Black</b>	<b>Ignition System "Shut-Off"</b>
	The black wire connects the ignition system CDI module to the throttle control switches. Ignition spark is enabled when all the switches are closed connecting the black wire to common ground. Ignition spark is interrupted when any of the switches open, disconnecting the black wire from common ground.
<b>Black/Red</b>	<b>Ignition System "Shut-Off"</b>
	The black/red wire connects the throttle control switches to the key switch. "Spark" occurs when the black/red is at a common ground level and "spark" stops when the black/red wire is open (not connected to common ground).
<b>Red/White #1</b>	<b>High Temperature Warning Light</b>
	Some models use a speedometer with a high temperature warning light. The red/white #1 wire connects the high temperature sensor to the temperature warning light. The "temp" light will illuminate when the sensor connects the red/white #1 wire to common ground.
<b>Red/White #2</b>	<b>Solenoid Coil Power</b>
	The red/white #2 wire connects the key switch (12 volt DC) power to the solenoid. The solenoid will activate when the key switch connects the red/white #2 wire to the + 12 VDC battery power.
<b>Red #1</b>	<b>Brakelight</b>
	The red #1 wire connects the brake control assembly switch to the brakelight filament. The brakelight will illuminate when the brake switch connects the red #1 wire to 13 VAC power.
<b>Red #2</b>	<b>Electric Start Battery Power; 12 Volts DC (Direct Current)</b>
	The red #2 wire connects the battery positive post (+ 12 VDC) to the key switch through the fuse holder. All electric start red #2 wires are + 12 VDC. If the fuse "blows", all red #2 wires are disconnected from the battery and battery charging (via the charging diode) discontinues until the fuse is replaced.
<b>Red #3</b>	<b>Low Oil Warning Light</b>
	The red #3 wire connects the low oil sensor to the "oil" warning light. The "oil" light will illuminate when the sensor connects the red #3 wire to 13 VAC power.

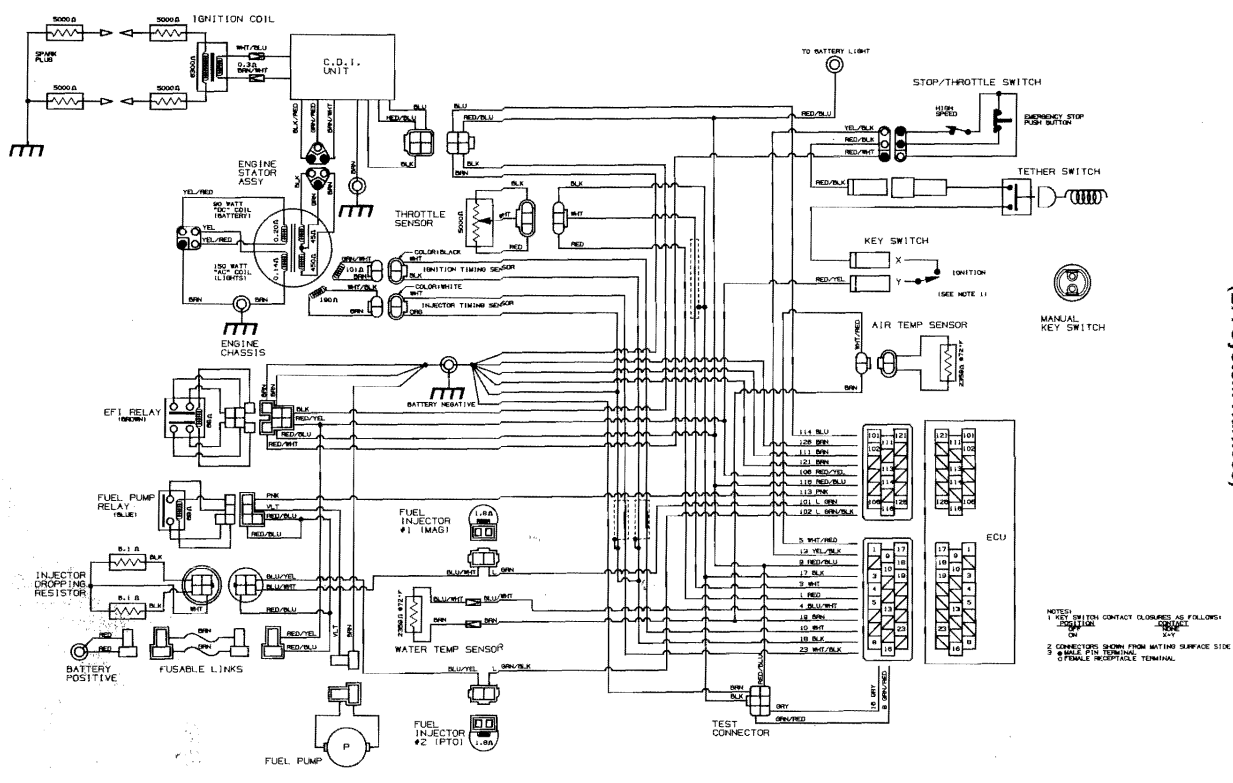








Wiring Harness  
(EFI System Harness)



NOTES:  
 1. KEY SWITCH CONTACT COLORED AS FOLLOWS:  
 CONTACT COLOR  
 X Y  
 2. CONNECTORS SHOWN FROM MATING SURFACE SIDE  
 3. MALE 25th TERMINAL IS FEMALE RECEPTACLE TERMINAL

# SECTION 6 - STEERING AND BODY

## TABLE OF CONTENTS

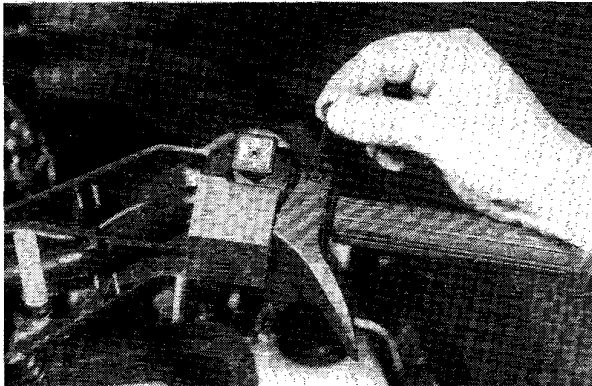
Removing and Disassembling Throttle Switch	138
Assembling and Installing Throttle Switch . . .	138
Brake Lever/Master Cylinder Assembly . . . . .	139
Removing Steering Post . . . . .	142
Inspecting Steering Post . . . . .	143
Installing Steering Post . . . . .	143
Removing Ski . . . . .	144
Inspecting Ski . . . . .	144
Installing Ski . . . . .	145
Removing Drag Link . . . . .	145
Inspecting Drag Link . . . . .	146
Installing Drag Link . . . . .	147
Removing and Disassembling Tie Rods . . . . .	148
Inspecting Tie Rods and Ball Joints . . . . .	148
Assembling and Installing Front Tie Rods . . . . .	148
Removing Spindle and Suspension Ball Joints	149
Inspecting Spindle . . . . .	150
Installing Spindle and Suspension Ball Joints	150
Removing Steering Tie Rod . . . . .	151
Inspecting Steering Tie Rod . . . . .	151
Installing Steering Tie Rod . . . . .	151
Checking Ski Alignment . . . . .	152
Adjusting Ski Alignment . . . . .	153
Removing Front Suspension Arms . . . . .	153
Inspecting Front Suspension Arms . . . . .	154
Installing Front Suspension Arms . . . . .	154
Removing and Inspecting Front Shock Absorber . . . . .	154
Installing Front Shock Absorber . . . . .	155
Removing Sway Bar . . . . .	155
Inspecting Sway Bar and Linkage . . . . .	155
Installing Sway Bar . . . . .	156
Removing Console and Console Extension . . . . .	156
Installing Console and Console Extension . . . . .	156
Removing Seat/Gas Tank Assembly . . . . .	157
Installing Seat/Gas Tank Assembly . . . . .	157
Removing Seat Cushion . . . . .	157
Installing Seat Cushion . . . . .	157
Removing Rear Bumper and Snowflap . . . . .	158
Installing Rear Bumper and Snowflap . . . . .	158
Removing Taillight Housing . . . . .	159
Installing Taillight Housing . . . . .	159
Removing Hood . . . . .	159
Installing Hood . . . . .	160
Removing Windshield . . . . .	160
Installing Windshield . . . . .	160
Removing Headlight Assembly . . . . .	160
Installing Headlight Assembly and Bulb . . . . .	161
Adjusting Headlight Aim . . . . .	161



## Removing and Disassembling Throttle Switch

1. Remove the handlebar pad.
2. Remove the retaining ring, seals, washers, and pin securing the throttle lever to the throttle switch.

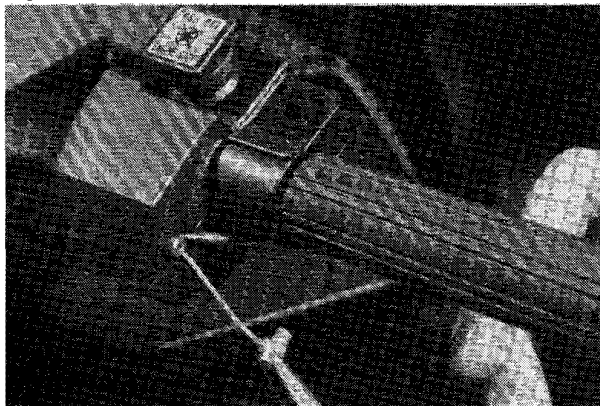
Fig. 6-1



AL025

3. Remove the retainer screw and clamp securing the thumb warmer harness to the throttle switch.
4. Disconnect the throttle cable from the seat in the throttle lever and remove the lever; then remove the cable retaining ring and slide the cable free of the throttle switch.

Fig. 6-2



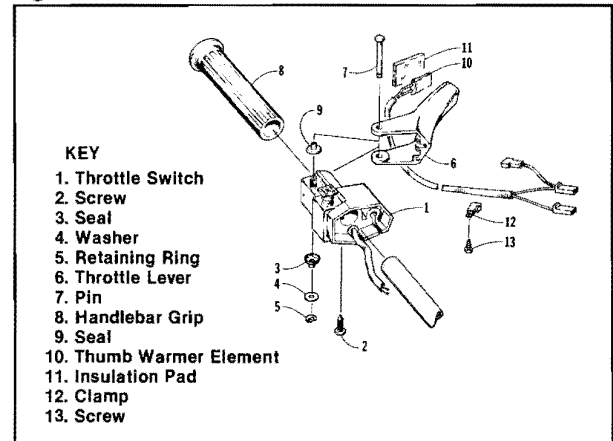
AL066

5. Using a sharp knife, cut the grip off the handlebar. Using a solvent, clean the old adhesive from the handlebar.

6. Disconnect the throttle switch harness from the main wiring harness at the front of the steering post.
7. Remove the tapping screw securing the throttle switch to the handlebar; then slide the switch off the handlebar.

## Assembling and Installing Throttle Switch

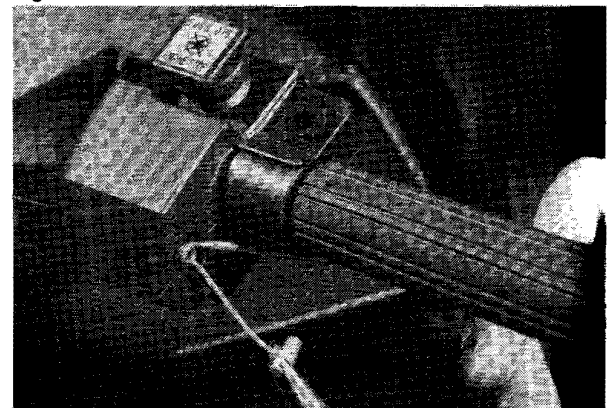
Fig. 6-3



0728-792

1. Slide the throttle switch onto the handlebar; then secure with a tapping screw.
2. Slide the throttle cable into the groove of throttle switch and secure with a retaining ring.

Fig. 6-4

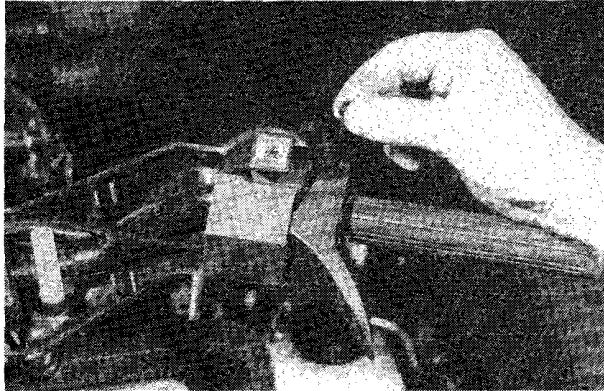


AL066

3. Connect the end of the throttle cable to the seat of the throttle lever.

- Secure throttle lever with pin, two white seal washers, washer, and retaining ring.

Fig. 6-5



AL025

**NOTE:** Apply a light coat of water-resistant grease to the seals before installing seals.

- Secure the thumb warmer harness to the throttle switch with clamp and retainer screw.
- Connect the throttle switch harness to the main wiring harness near the front of the steering post.

**NOTE:** The switch harness must be properly connected. If the switch harness is not connected, the engine will not start. Be sure there is enough slack in the switch harness to allow the steering to be turned full left and right directions without disconnecting the harnesses.

**⚠ WARNING**

Compress the throttle control lever to ensure free movement. If throttle cable sticks or binds, correct the problem before the snowmobile is operated.

- Apply Handlebar Adhesive (p/n 0636-071) to the bore of the handlebar grip and using a rubber hammer, drive the grip into position.

**⚠ WARNING**

Then handlebar adhesive is extremely flammable. The product contains acetone and vapors released can be easily ignited. Keep away from heat, sparks, and open flame. Use only in areas with adequate ventilation. Avoid prolonged breathing of vapor. Avoid eye and skin contact. Keep container closed when not in use.

- Place the handlebar pad into position and then secure.

## Brake Lever/Master Cylinder Assembly

### REMOVING

- Slide a piece of flexible tubing over the ball of the bleeder valve and direct the other end into a container. Remove the reservoir cover; then open the bleeder valve. Allow the brake fluid to drain completely.
- Remove the wire connectors from the brake-light switch.

Fig. 6-6



AF201

- Place an absorbent towel around the connection to absorb brake fluid. Remove the brake hose from the master cylinder.

**⚠ CAUTION**

Brake fluid is highly corrosive. Do not spill brake fluid on any surface of the snowmobile.

- Using a sharp knife, cut the grip off the handlebar. Using a solvent, clean the old adhesive from the handlebar.
- Remove the screw and nut securing the brake assembly to the handlebar. Slide the assembly off the handlebar.

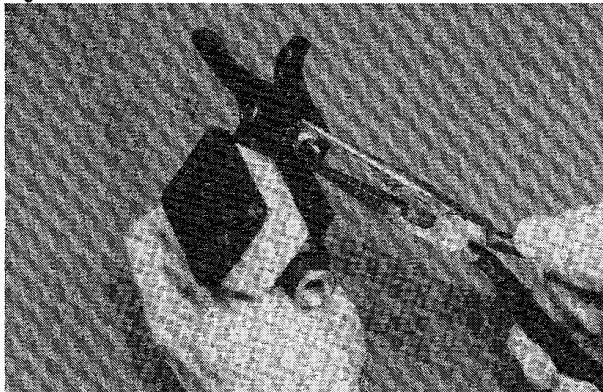
6



## DISASSEMBLING

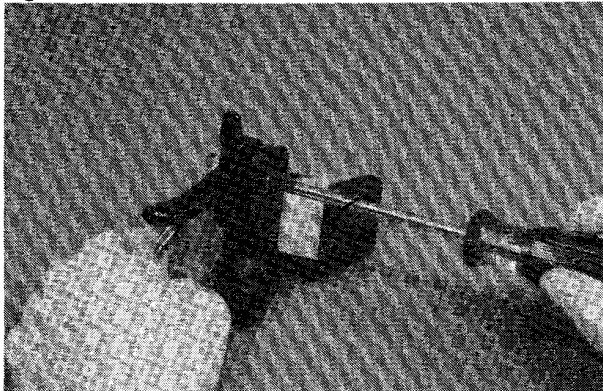
1. Remove the brakelight switch.

Fig. 6-7



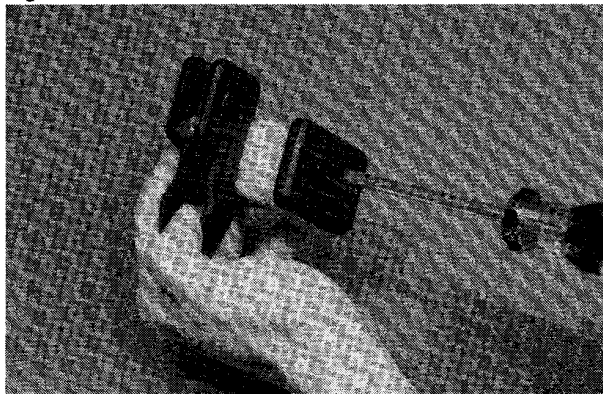
2. Remove the screw and lock nut securing the brake lever.

Fig. 6-8



3. Remove the two screws securing the brake reservoir cover; then remove the cover.

Fig. 6-9



4. Remove the two screws securing the reservoir to the master cylinder.

Fig. 6-10



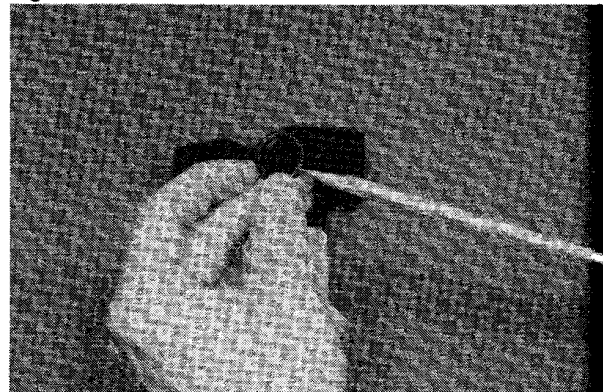
5. Compress the locking tabs of the reservoir and remove the reservoir from the master cylinder. Account for an O-ring seal.

## INSPECTING

**NOTE:** Whenever a part is worn, cracked, defective, or damaged in any way, replacement is necessary.

1. Inspect the screw securing the brake lever for wear, cracked, stretched, or damaged threads.
2. Inspect the O-ring for deterioration and distortion.

Fig. 6-11

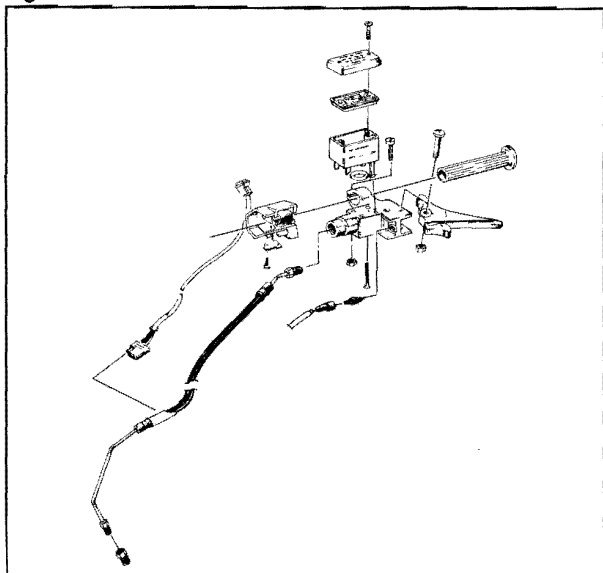


3. Inspect the reservoir for cracks and leakage.
4. Inspect the brake hose for cracks, deterioration, and the condition of the fittings (threaded and compression).



## ASSEMBLING

Fig. 6-12



0729-933

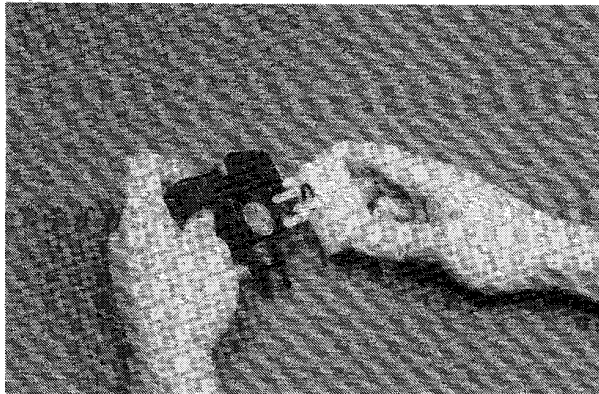
Fig. 6-13



AF207

1. Apply Arctco approved high temperature brake fluid to the O-ring seal; then install on the brake reservoir.
2. Install the brake reservoir on the master cylinder. Secure with two screws.

Fig. 6-14



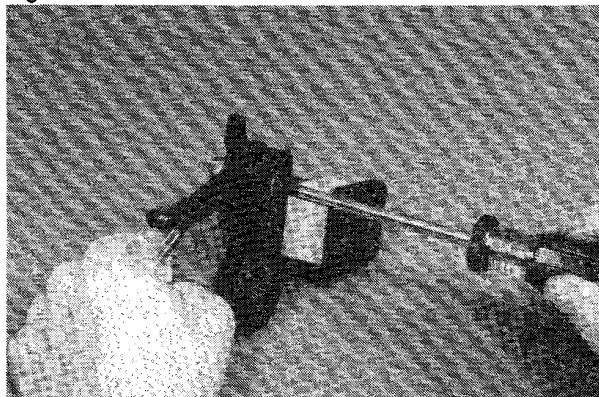
AF205

3. Install the brakelight switch.
4. Install the brake lever. Secure with a screw and lock nut. Tighten the lock nut just to the point of ensuring free brake lever movement.

### WARNING

Do not over-tighten the lock nut. Over-tightening the lock nut will cause the brake lever to bind. The lever must work freely and fully return to its stop after installation.

Fig. 6-15



AF202

### WARNING

A new lock nut must be used to secure the brake lever.

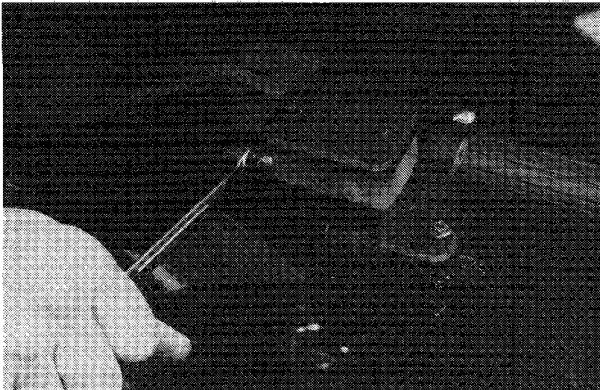
## INSTALLING

1. Slide the brake assembly onto the handlebar. Using a screw and lock nut tighten securely.



2. Install the brake hose on the master cylinder. Tighten securely.

Fig. 6-16



AF200

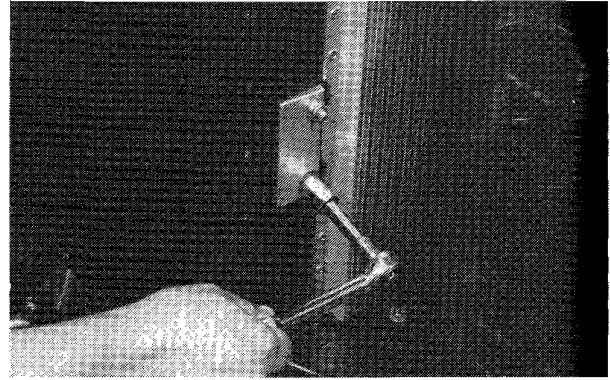
3. Attach the wire connectors to the brakelight switch.
4. Apply Handlebar Adhesive to the bore of the handlebar grip. Using a rubber hammer, drive the grip into position.
5. Bleed the brake system (see Bleeding Brake System section).

## Removing Steering Post

**NOTE:** The engine and battery must be removed for this procedure (see Removing Engine section).

1. Remove the handlebar pad.
2. Tip the snowmobile on its side and remove the two lock nuts securing the lower steering post bracket to the front end assembly; then remove the backing plate. Tip the snowmobile back upright.

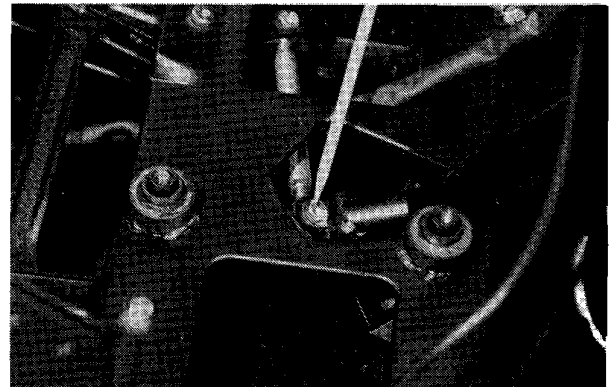
Fig. 6-17



AL046

3. Remove the four lock nuts and cap screws securing the adjuster caps to the adjuster block; then remove the caps, handlebar assembly, and adjuster block. Move the handlebar assembly out of the way. Position the handlebar assembly forward leaving all cables, brake hose, and wires attached.
4. Pull forward on the air intake silencer to unsnap it from under the steering support.
5. Remove the console and console extension (see Removing console section).
6. Remove the two cap screws, washers, and lock nuts securing the steering post to the steering support. Account for the bearing halves, bearing cap, and bearing housing.
7. Pull the two cap screws with washers out of the lower steering post bracket. Account for the bearing halves, bearing cap, and bearing housing.
8. Remove the cap screw and lock nut securing the tie rod to the lower steering post brackets; then remove the steering post.

Fig. 6-18



AL052

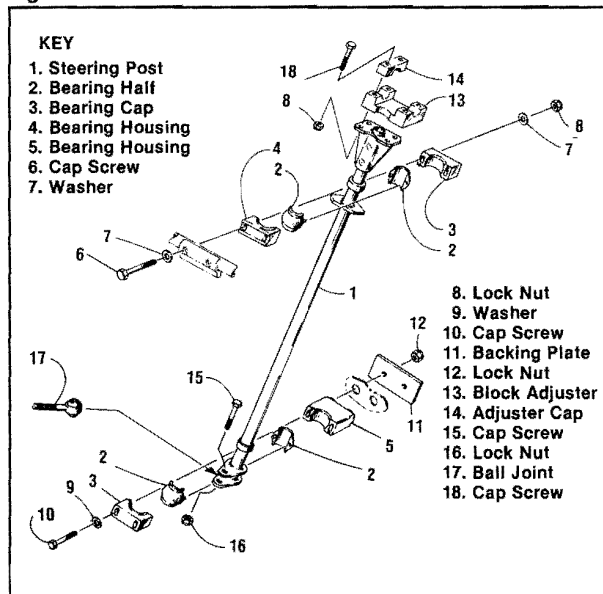
## Inspecting Steering Post

**NOTE:** Whenever a part is worn excessively, cracked, defective, or damaged in any way, replacement is necessary.

1. Inspect all welded areas for cracks or deterioration.
2. Inspect steering post and steering-post brackets for cracks, bends, or wear.
3. Inspect the bearing halves, bearing caps, and bearing housings for cracks or wear.

## Installing Steering Post

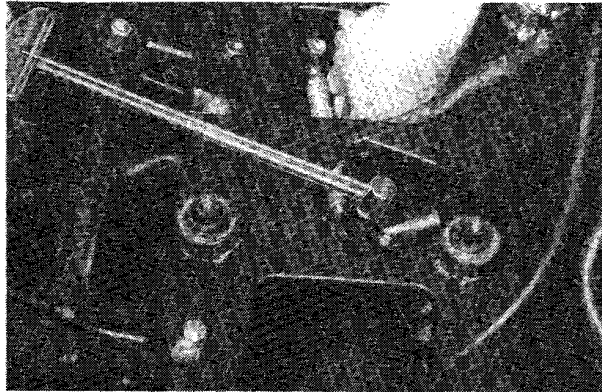
Fig. 6-19



0729-771

1. Place the steering post into position; then slide the tie rod into position between the steering post brackets and secure with the cap screw and lock nut. Coat the threads of the cap screw with LOCTITE LOCK N' SEAL before installing. Tighten to 4.2 kg-m (30 ft-lb).

Fig. 6-20



AL055

2. On the lower end of the steering post, place the bearing halves into position around the steering post; then place the bearing housing behind the steering post and the bearing cap on the front side of the steering post. Insert the two cap screws with washers.

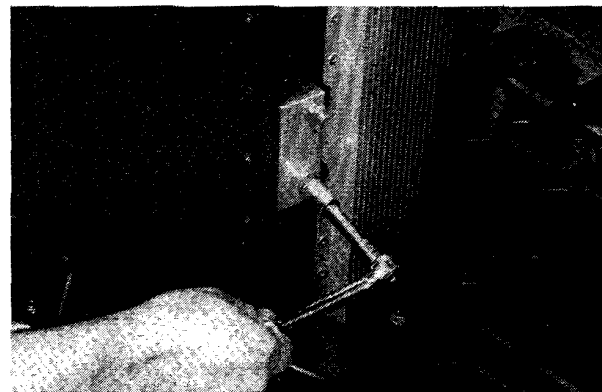
**NOTE:** The cap screws will be secured with lock nuts in step 4.

3. On the upper end of the steering post, place the bearing halves into position around the steering post; then place the bearing housing between the steering support and the steering post. Place the bearing caps into position and secure with the two cap screws, washers, and lock nuts. Tighten to 2.5 kg-m (18 ft-lb).

**NOTE:** Lubricate bearing halves with low-temperature grease.

4. Tip the snowmobile on its side and secure the lower steering post assembly with the backing plate and two lock nuts. Tighten to 2.5 kg-m (18 ft-lb). Tip the snowmobile upright.

Fig. 6-21



AL046

6



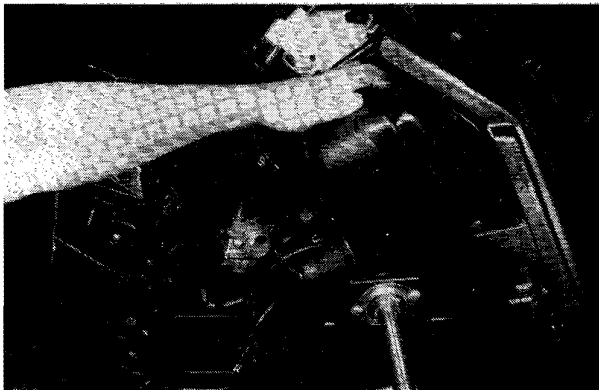
- Lubricate the steering post bearings with a light oil; then check the steering post for free movement.
- Install the console and console extension (see Installing Console and Console Extension section).

Fig. 6-22



AL049

Fig. 6-23



AL051

- Place the adjuster block, handlebar assembly, and adjuster caps into position; then secure with four cap screws and lock nuts. Tighten the lock nuts evenly to 1.4 kg-m (10 ft-lb).
- Place the handlebar pad into position and secure.
- Install the engine (see Installing Engine section).
- Install the battery. Attach the positive cable, then the negative cable to the battery.

**⚠ WARNING**

The positive cable must be connected first.

## Removing Ski

- Place the front of the snowmobile on a support stand.
- Remove the cotter pin; then remove the slotted nut and cap screws securing the ski assembly to the spindle. Remove the ski. Account for optional washers.

Fig. 6-24



AL039

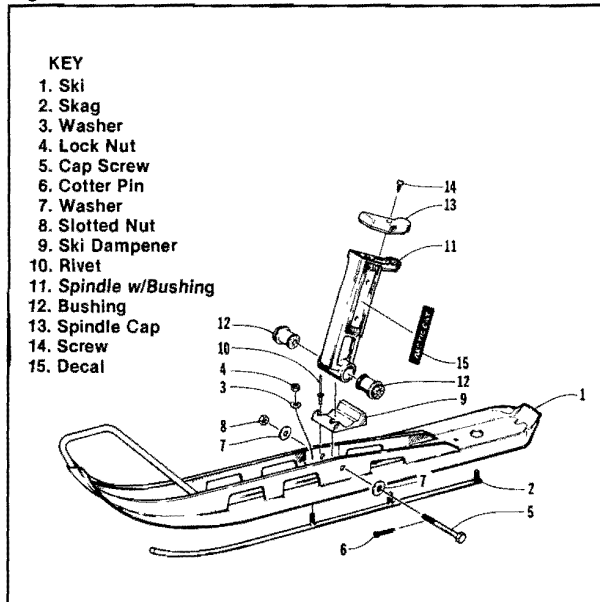
## Inspecting Ski

**NOTE:** Whenever a part is worn excessively, cracked, defective, or damaged in any way, replacement is necessary.

- Inspect welded areas for cracks or deterioration.
- Inspect the ski for abnormal bends or cracks.
- Inspect all hardware and the spindle bushings for wear and damage.
- Inspect the skag for wear.

## Installing Ski

Fig. 6-25



0729-404

1. Place the front of the snowmobile on a support stand to provide ample room for installing the ski on the spindle assembly.
2. Position the ski onto the spindle making sure the two bushings are properly positioned in the spindle; then apply a light coat of grease to the cap screw. Secure the ski with the cap screw, washers as needed, and slotted nut.
3. Set the snowmobile on the floor; then place a 25 mm (1 in.) board under the skis just in front of each spindle (so both ski tips are elevated off the floor).

**NOTE:** It is important that the ski tips are slightly elevated when torquing the cap screws. Preloading the skis in the slightly upward position enhances the handling characteristics of the snowmobile.

4. Secure each cap screw with a washer (as needed) and castle nut, and torque to 9.7-11.1 kg-m (70-80 ft-lb).
5. Place a cotter pin through each cap screw and castle nut; then spread cotter pins.

## Removing Drag Link

**NOTE:** You may wish to remove the belly pan center section for this procedure.

1. Remove the hood from the snowmobile.
2. Remove the two expansion chambers from the engine.
3. Remove the two cotter pins securing the slotted nuts; then remove the nuts securing the ball joints to the spindle arms.
4. Using the Tuning Fork (p/n 0644-098) and a hammer, drive the tuning fork between the ball joint and spindle arm; then separate the ball joint and tie rod from each spindle.

Fig. 6-26

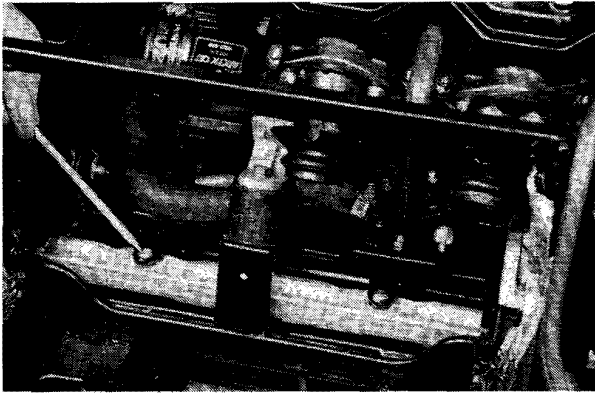


AL040

5. Remove one of the rubber boots. Using a No. 10 drill bit, drill the head off each of the four rivets securing the boot to the front end assembly.
6. Remove the two cap screws securing the drag link to the two steering arms.



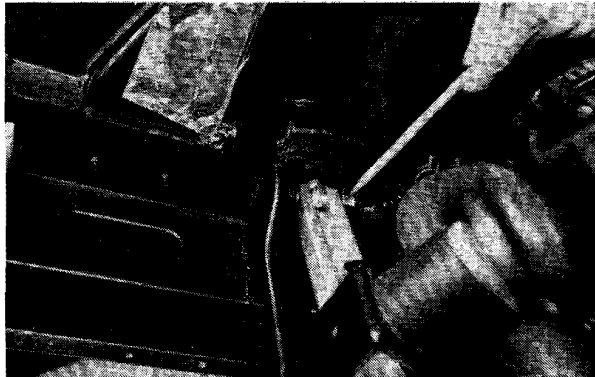
Fig. 6-27



AL073

7. Remove the lock nut from the cap screw which secures the tie-rod ball joint to the drag link opposite the rubber boot which was removed.

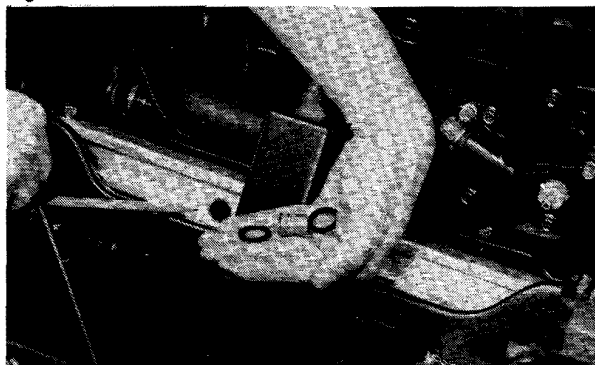
Fig. 6-28



AL076

8. Slide the drag link forward and twist upward to free the drag link of the two steering arms.
9. Remove the two drag link bushings and account for the two plastic washers found at each end of the bushings.

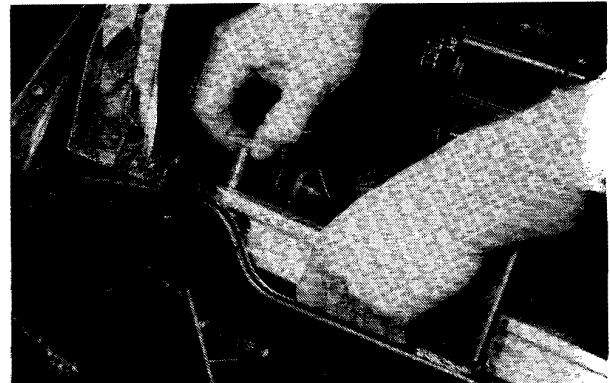
Fig. 6-29



AL075

10. Slide the drag link sideways to expose the cap screw securing the tie-rod ball joint to the drag link (the lock nut was removed in step 7.)

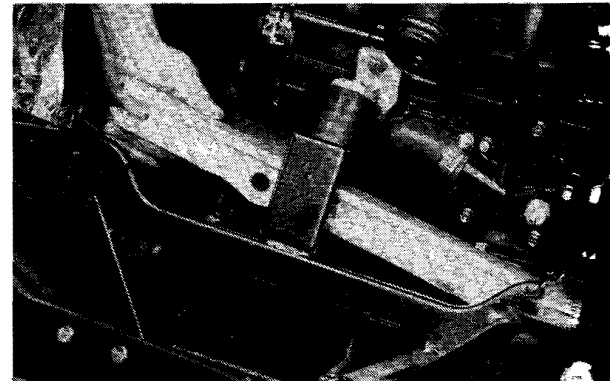
Fig. 6-30



AL077

11. Pull the cap screw from the drag link and account for the two flat washers.
12. With the drag link tipped on its side, slide it out through the side of the snowmobile front-end assembly.

Fig. 6-31



AL078

13. With the drag link removed, remove the remaining tie rod and rubber boot.

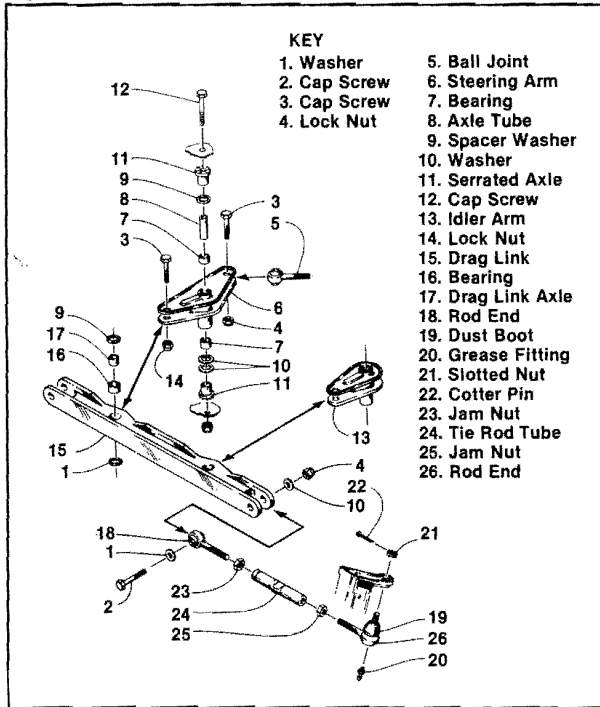
## Inspecting Drag Link

1. Inspect the entire drag link (especially in the areas where the ball joints attach) for any signs of cracks, wear, or damage.
2. Inspect the bearings, inserts, and axles for wear or damage.

**NOTE:** Whenever a part is worn excessively, cracked, defective, or damaged in any way replacement is necessary.

## Installing Drag Link

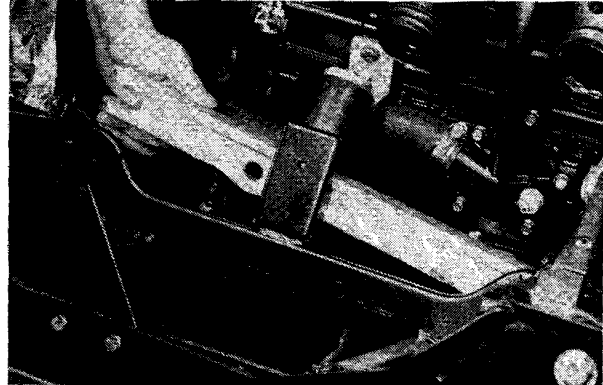
Fig. 6-32



0729-197

1. With the drag link tipped on its side with the two machined openings down, slide the drag link into position through the side of the front-end assembly.

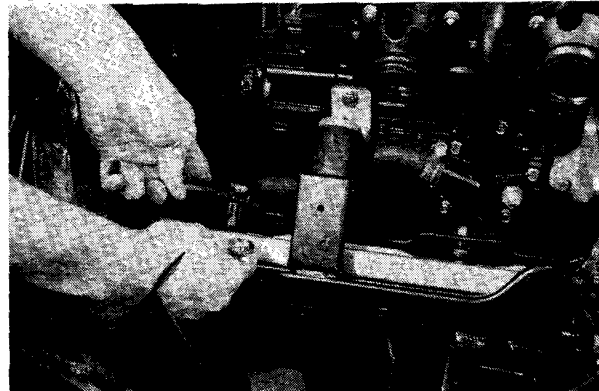
Fig. 6-33



AL078

2. Secure the tie-rod ball joint to the drag link, opposite the end from which the rubber boot was removed. Place the tie-rod ball joint into position, and secure with cap screw, flat washers, and lock nut. The lock nut must be located on the backside of the drag link along with a flat washer. Apply LOCTITE LOCK N' SEAL and tighten to 4.2 kg-m (30 ft-lb).
3. Apply a light coat of grease to the two drag link axles and slide them into position in the drag link. Position a plastic spacer washer on each end of the axles after they have been installed.
4. Position the drag link into the two steering arms and secure with two cap screws and lock nuts. Apply LOCTITE LOCK N' SEAL to the threads of each cap screw; then torque the lock nuts to 4.2 kg-m (30 ft-lb).

Fig. 6-34



AL074

5. Installing the remaining tie rod and rubber boot. Secure the tie-rod ball joint to the drag link with a cap screw and flat washers on each side. Apply LOCTITE LOCK N' SEAL to the cap screw threads and tighten the lock nut to 4.2 kg-m (30 ft-lb).

6



6. Place the rubber boot into position along with its metal retainer ring; then secure with four rivets.
7. Grease each ball joint at the spindle end of the tie rods. Wipe excess from the ball joint area.
8. Secure the tie-rod ball joints to the spindle arms with the slotted nut located on top of each arm. Tighten the slotted nut to 3.5 kg-m (25 ft-lb). Install a cotter pin and spread its end.

**NOTE:** Before installing the expansion chambers and hood, double-check all drag link and ball joint hardware to make sure every cap screw and nut is tightened to specifications.

9. Install the two expansion chambers and secure with springs.
10. Install the hood and secure with two hinge pins. Connect the hood cable and headlight harness connector. Secure the headlight harness to the metal screen using an electrical tie to prevent contact with the exhaust system.

## Removing and Disassembling Tie Rods

1. Remove the cotter pin and slotted nut securing the ball joint on the spindle end of the front tie rod; then remove the cap screw and lock nut securing the ball joint to the drag link.
2. Using the Tuning Fork (p/n 0644-098) and a hammer, drive the tuning fork between the ball joint and spindle arm and separate the ball joint from the spindle.

Fig. 6-35



AL069

## CAUTION

When separating a ball joint from the spindle, the Tuning Fork (p/n 0644-098) must be used. Do not strike the ball joint to attempt to remove it. Damage to the ball joint will occur.

3. Loosen the jam nut securing each ball joint to the tie rod; then remove the ball joints from the tie rod. Remove the jam nuts and slide the tie rod from the rubber boot.

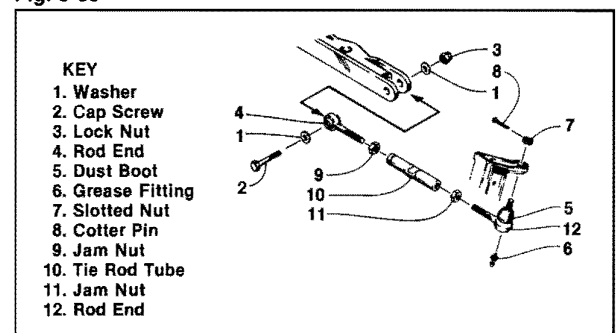
## Inspecting Tie Rods and Ball Joints

**NOTE:** Whenever a part is worn excessively, cracked, defective, or damaged in any way, replacement is necessary.

1. Inspect the ball joints and tie rods for damaged threads or wear.
2. Inspect the ball joints and tie rods for cracks or unusual bends.
3. Inspect the ball joint pivot area for wear. Remove the seal and wash the ball joint in parts cleaning solvent. Install the seal after inspecting and grease the ball joint after installing.

## Assembling and Installing Front Tie Rods

Fig. 6-36



0729-197

1. Slide the tie rod through the rubber boot; then install the jam nuts on the ball joints and thread the ball joints onto the tie rod.

**NOTE:** Each jam nut and ball joint is either a right-hand or left-hand thread; therefore, each can only be installed on one end of the tie rod. The right-hand thread is the inside ball joint and jam nut.

2. Place the tie-rod assembly into position and secure to the spindle with a slotted nut. Tighten to 3.5 kg-m (25 ft-lb). Install a cotter pin in the ball joint and spread.
3. Place the tie rod into position between the forked end of the drag link and secure with a cap screw and lock nut. Torque to 3.9 kg-m (28 ft-lb).
4. Grease the ball joint at the spindle end; then adjust ski alignment.
5. Apply LOCTITE LOCK N' SEAL to the threads of each ball joint; then tighten the jam nuts against the tie rod.

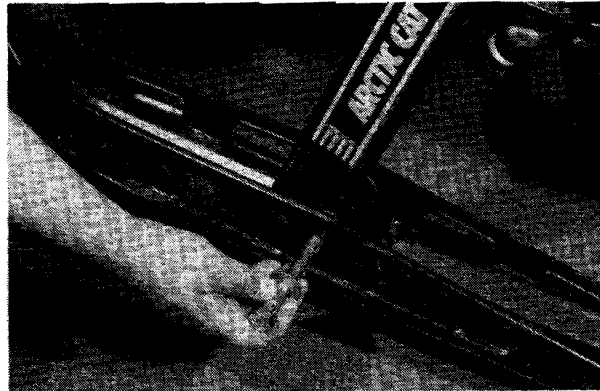
**WARNING**

Neglecting to lock the jam nuts against the tie rod may cause loss of snowmobile control and possible personal injury.

## Removing Spindle and Suspension Ball Joints

1. Position the front of the snowmobile up onto a 12 in. stand.
2. Remove the lock nuts and cap screw securing the shock absorber to the lower arm. Account for all mounting hardware.
3. Remove the ski; then remove the screw securing the spindle cap and remove the cap.

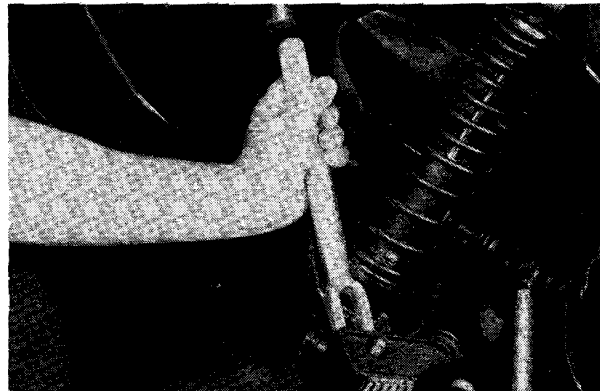
Fig. 6-37



AL039

4. Remove the three cotter pins and slotted nuts securing the ball joints to the spindle.
  5. Raise the spindle until the arms are parallel to the floor; then support the spindle in this position.
- NOTE:** The arms must be moved to the parallel position in order to access the ball joints with the tuning fork.
6. Using the Tuning Fork (p/n 0644-098) and a hammer, drive the tuning fork between each ball joint and the spindle and separate each ball joint from the spindle.

Fig. 6-38



AL041

**CAUTION**

When separating a ball joint from the spindle, the Tuning Fork (p/n 0644-098) must be used. Do not strike the ball joint to attempt to remove it. Damage to the ball joint will occur.

6



7. Inspect the suspension ball joints in place. If damage, wear, or unusual bends are noted, remove the lock nut; then remove the ball joint from the arm.

## Inspecting Spindle

**NOTE:** Whenever a part is worn excessively, cracked, defective, or damaged in any way, replacement is necessary.

1. Inspect the spindle for cracks or imperfections in the casting.
2. Inspect the ball joint bushings (located in the spindle) for wear, damage, or loose fit. If any of these conditions exist, replace the spindle.
3. Inspect the ski bolt bushings for wear, damage, or loose fit. Replace the bushings as a set.

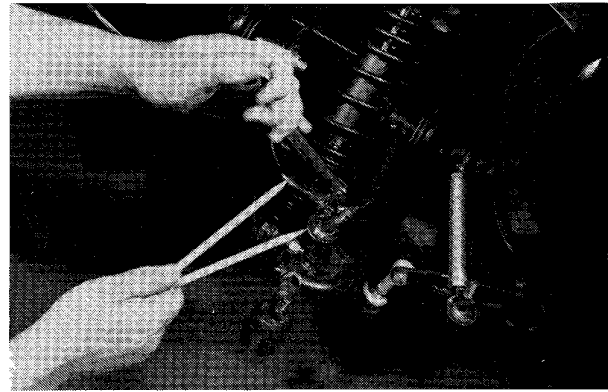
**NOTE:** Replacing the ski bolt bushings is difficult. The existing bushings will be demolished during removal. Be careful, however, not to damage the spindle when removing the bushings. Press the new bushings into the spindle.

## Installing Spindle and Suspension Ball Joints

**NOTE:** If the suspension ball joints were not removed or loosened, omit steps 1 and 2.

1. Press the upper suspension ball joint into the arm until it bottoms out and square the ball joint with the arm. Apply LOCTITE LOCK N' SEAL to the lock nut, hold the ball joint parallel to the arm, and secure with the lock nut tightened to 12.5 kg-m (90 ft-lb).

Fig. 6-39



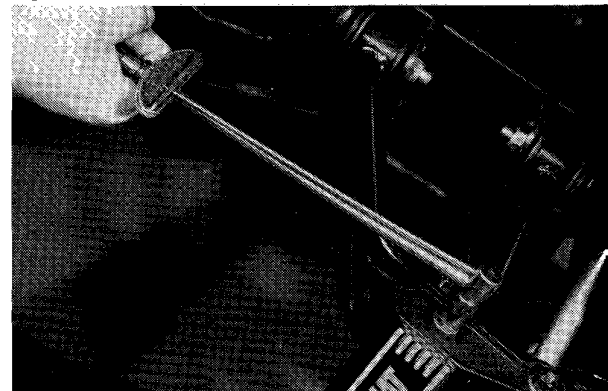
AL044

### CAUTION

When installing or adjusting the suspension ball joints, they must be secured parallel to the arm.

2. Press the lower ball joint into the arm until it bottoms against the support tube. Apply LOCTITE LOCK N' SEAL to the ball joint threads and install the lock nut. While holding the ball joint parallel to the arm, tighten the lock nut to 24 kg-m (180 ft-lb).
3. Place the spindle into position on the suspension ball joints. Secure the upper ball joint with a washer and slotted nut tightened to 8.3 kg-m (60 ft-lb). Secure the lower ball joint with a slotted nut tightened to 12.5 kg-m (90 ft-lb). Place the steering ball joint into position below the spindle arm and secure with a slotted nut tightened to 3.5 kg-m (25 ft-lb). secure the three slotted nuts with the cotter pins.

Fig. 6-40



AL045

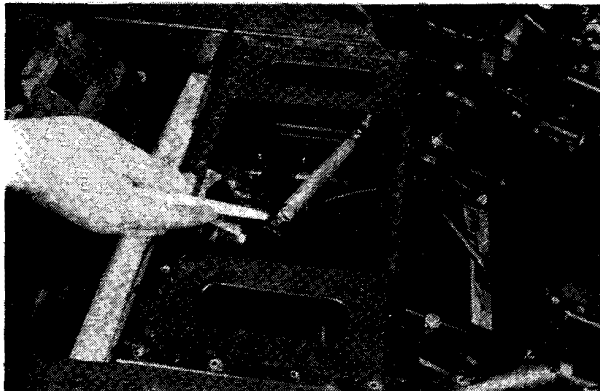
4. Place the spindle cap into position and secure with a screw.

5. Install the ski and secure with a cap screw, washer(s), and slotted nut. DO NOT tighten at this time.
6. Align the shock eyelet with the mounting hole in the lower arm; then secure with the cap screw and lock nut. Tighten to 3.2 kg-m (23 ft-lb).
7. Remove the stand from beneath the front end assembly and set snowmobile on floor.
8. Elevate the ski tip 1 in. above the floor; then torque the ski cap screw and slotted nut to 9.7-11.1 kg-m (70-80 ft-lb). Install the cotter pin and spread.

## Removing Steering Tie Rod

1. Disconnect the negative battery cable; then the positive. Remove the battery box and battery.
2. Tip the snowmobile on its side and remove the screws securing the center belly pan section to the front-end assembly.
3. Remove the two lock nuts and cap screws securing the tie rod to the steering post and steering arm; then remove the tie-rod assembly.

Fig. 6-41



AL072

4. If the tie-rod assembly is to be disassembled, measure the exact distance between the two ball joint centers and write down measurement for assembly purposes.
5. To disassemble the tie rod, loosen the tie-rod jam nuts and rotate the ball joints from the tie rod.

**NOTE:** One end of the tie-rod tube is marked with a groove. The opposite end has left-hand threads.

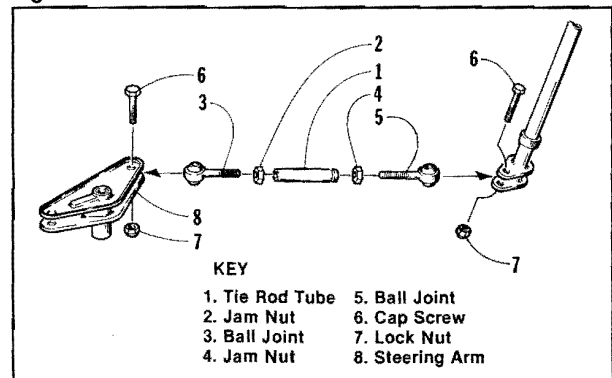
## Inspecting Steering Tie Rod

**NOTE:** Whenever a part is worn excessively, cracked, defective, or damaged in any way, replacement is necessary.

1. Inspect the ball joints for damaged threads or wear.
2. Inspect the tie rod for damage, unusual bends, or wear.

## Installing Steering Tie Rod

Fig. 6-42



0728-391

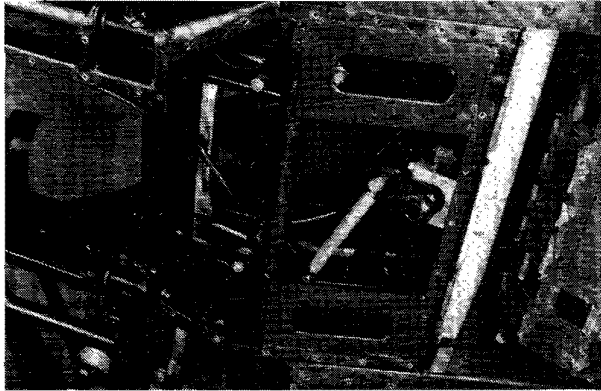
1. Tip the snowmobile on its side and position the handlebar in the straight-forward position.
2. Thread the jam nuts onto the ball joints; then equally thread the ball joints into the tie rod.

**NOTE:** There must be an approximate equal number of threads exposed on each ball joint.



3. If the tie rod was disassembled, measure the distance between the two ball joints and refer to measurement taken earlier. Adjust the tie rod until the center distance between the two ball joints measures the same as the original tie-rod assembly.
4. Place the tie-rod assembly into position with the grooved end of the tie rod located in the steering arm. If necessary, rotate the tie rod to align its ball joints with the steering post bracket and steering arm.

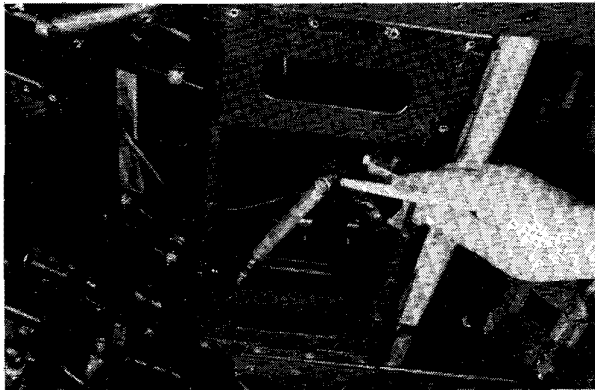
Fig. 6-43



AL071

5. Secure the tie-rod assembly by installing the two cap screws from the top side of each ball joint. Coat the threads of each cap screw with GREEN LOCTITE and tighten the lock nuts to 4.2 kg-m (30 ft-lb). The two lock nuts must be located on the bottom side of each ball joint.

Fig. 6-44



AL072

6. Set the machine back down onto the floor. Check to make sure the handlebar and drag link are centered. Adjust the tie rod as necessary; then apply LOCTITE LOCK N' SEAL to the tie-rod jam nuts threaded area. Tighten both jam nuts securely.

### WARNING

After adjusting the tie rod, you must maintain a minimum of 3/8 in. ball joint thread contact with the tie rod at each end. Less thread contact may cause the ball joint to pull loose and may cause personal injury.

### WARNING

Neglecting to lock the jam nuts against the tie rod may cause loss of snowmobile control and possible personal injury.

7. Install bottom belly pan section.
8. Install the battery and battery box. Attach the positive battery cable; then the negative cable.

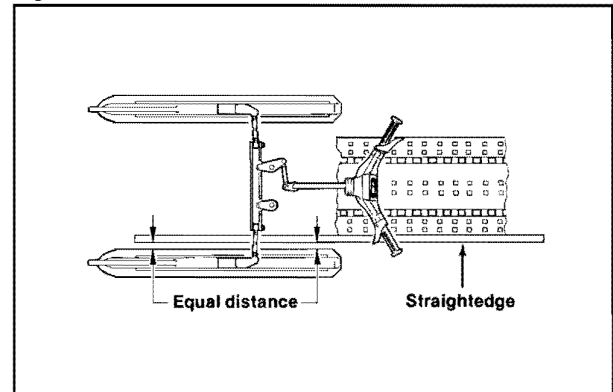
### WARNING

The positive cable must be connected first.

## Checking Ski Alignment

1. Turn the handlebar to the straight-ahead position.
2. Place a long straightedge against the outside edge of the track so it lies next to the inside edge of the left-side ski.

Fig. 6-45



0730-129

**NOTE:** The straightedge should be long enough to extend from the back of the track to the front of the ski.

3. Measure the distance from the straightedge to the edge of the ski in two places. Take one measurement from the forward end of the ski edge and the other measurement from the rearward end of the ski edge.

**NOTE:** Make sure measurements are taken on a flat surface of the ski edge and not on a rounded surface.

4. The measurements from the forward and rearward ends of the ski edge must be equal or the forward measurement must not exceed the rearward measurement by more than 3 mm (1/8 in.).
5. If ski alignment is not a specified, adjust ski alignment.
6. Repeat checking ski alignment procedures on the right-side ski.

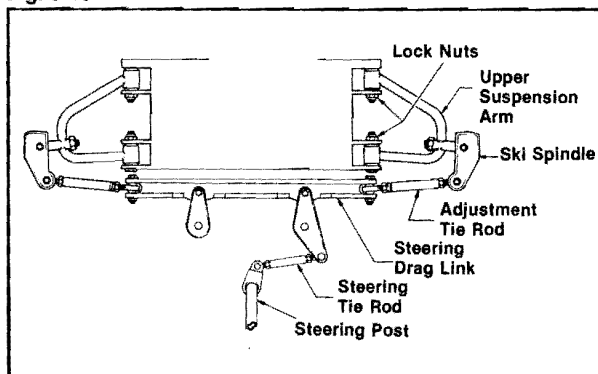
## Adjusting Ski Alignment

**NOTE:** The following procedure can be used to adjust the alignment of either ski.

1. Determine which ski is out of alignment; then unlock the tie rod by loosening the jam nuts.

**NOTE:** The outside jam nuts are "left-hand" thread. Care should be taken to rotate them in the proper direction.

Fig. 6-46



0729-406

2. Adjust the ski alignment by rotating the tie rod attached to the spindle arm.
3. When the ski alignment is correct, lock the tie rod by tightening the two jam nuts. Tighten both jam nuts against the tie rod.

## WARNING

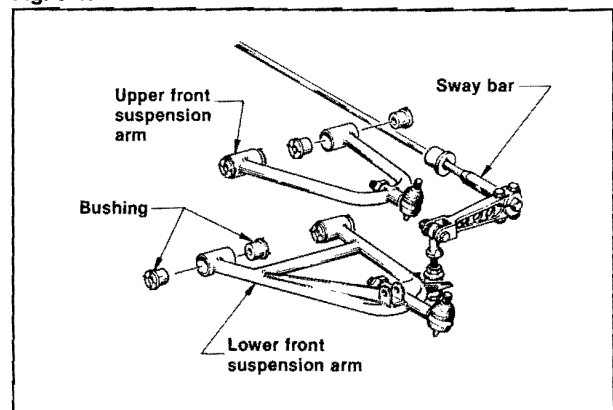
Neglecting to lock the tie rod by tightening the jam nuts may cause loss of snowmobile control and possible personal injury.

## Removing Front Suspension Arms

1. Position the front of the snowmobile up onto a 12 in. stand.
2. Remove the lock nuts and cap screws securing the shock absorber; then remove the shock absorber.
3. Remove the spindle and, if necessary, the ball joint(s) (see Removing Spindle and Suspension Ball Joints section).
4. Remove the cap screw and nut securing the sway bar linkage to the lower arm. Account for the bushings and bushing retainers.
5. Remove the two cap screws and lock nuts securing each of the arms to the front end; then remove each of the arms.

6

Fig. 6-47



0729-405



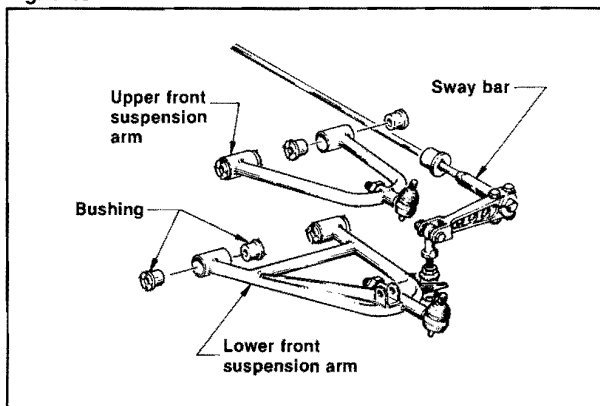
## Inspecting Front Suspension Arms

**NOTE:** Whenever a part is worn excessively, cracked, defective, or damaged in any way, replacement is necessary.

1. Inspect the arm welded areas for cracks or any signs of deterioration.
2. Inspect the bushings for wear or damage.
3. Inspect the arm tubing for signs of being twisted or bent.

## Installing Front Suspension Arms

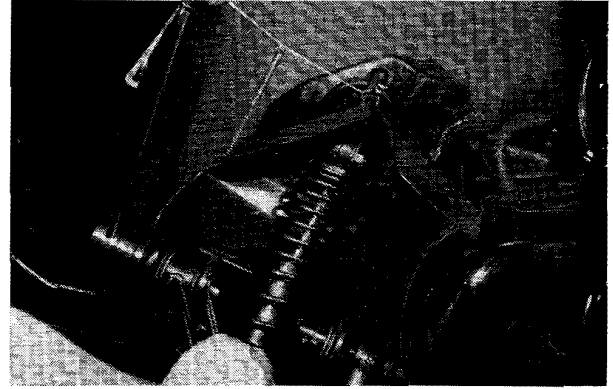
Fig. 6-48



0729-405

1. Place the upper arm into position and secure to the front end with two cap screws and lock nuts. Torque to 9.0-9.7 kg-m (65-70 ft-lb).

Fig. 6-49



AL038

**NOTE:** Position the lock nuts on the back side of each mounting bracket.

2. Place the lower arm into position and secure to the front end with two cap screws and lock nuts. Torque to 9.0-9.7 kg-m (65-70 ft-lb).
3. Install the ball joints and spindle (see Install Spindle and Suspension Ball Joints).
4. Place a bushing retainer and bushing onto the sway bar adjusting cap screw; then slide it up through the bracket on the lower arm. Place the remaining bushing and bushing retainer on the cap screw; then apply LOCTITE LOCK N' SEAL to the area above the bushing retainer and install the nut. Tighten to 0.4 kg-m (3 ft-lb).
5. Thread the sway bar adjusting cap screw into the sway bar ball joint.
6. Place the shock absorber into position and secure to the front end with two cap screws and lock nuts. Tighten to 3.2 kg-m (23 ft-lb).
7. Adjust the sway bar linkage (see Adjusting Sway Bar section).

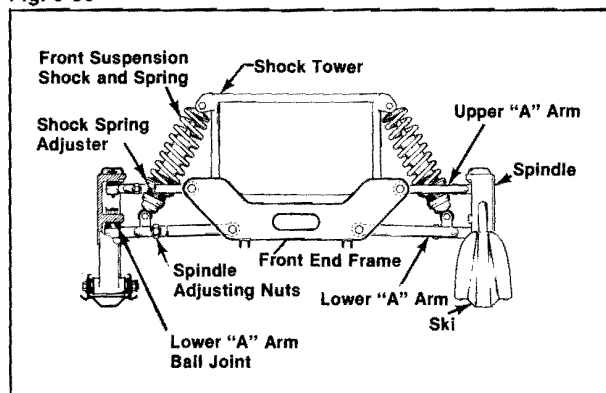
## Removing and Inspecting Front Shock Absorber

1. Position a support stand under the front-end assembly, taking all pressure off the skis.
2. Remove the cap screws securing the shock absorber to the front-end assembly; then remove the shock absorber.

3. *Inspect the shock absorber seal area for signs of excessive oil leakage.*
4. Inspect the shock mounting eyelet, bushings and sleeve for wear or damage.
5. Using the Shock Spring Removal Tool (p/n 0644-057), remove the spring from the shock body by compressing the spring; then remove the spring retainer from the top of the spring. Inspect the shock absorber by quickly compressing and extending the shock plunger while firmly holding the shock body. Resistance must be felt in both directions.
6. Inspect the threaded shock sleeve for damage or wear. Clean the sleeve and apply a light coat of grease to threads before assembly.

## Installing Front Shock Absorber

Fig. 6-50



1. Using the Shock Spring Removal Tool (p/n 0644-057), place the spring on the shock absorber and secure with the retainer.
2. Adjust the shock adjuster until there are 19-25 mm (3/4-1 in.) of thread exposed below the shock adjuster.
3. Place the shock absorber into position (threaded end up). Install both cap screws from the front. The short cap screw must be installed in the upper shock mount and the long cap screw in the lower shock mount. Torque both lock nuts to 3.2 kg-m (23 ft-lb).

## Removing Sway Bar

**NOTE:** Perform steps 1-3 on both sides of the snowmobile.

1. Remove the two lock nuts and cap screw securing the sway bar arm to the sway bar.
2. Remove the lock nut and cap screw securing the sway bar arm to the ball joint; then remove the arm. Pull the sway bar out and account for two bushings.
3. Remove the ball joint and jam nut from the sway bar adjusting cap screw; then remove the cap screw from the lower arm. Account for two bushings and bushing retainers.

## Inspecting Sway Bar and Linkage

**NOTE:** Whenever a part is worn excessively, cracked, defective, or damaged in any way, replacement is necessary.

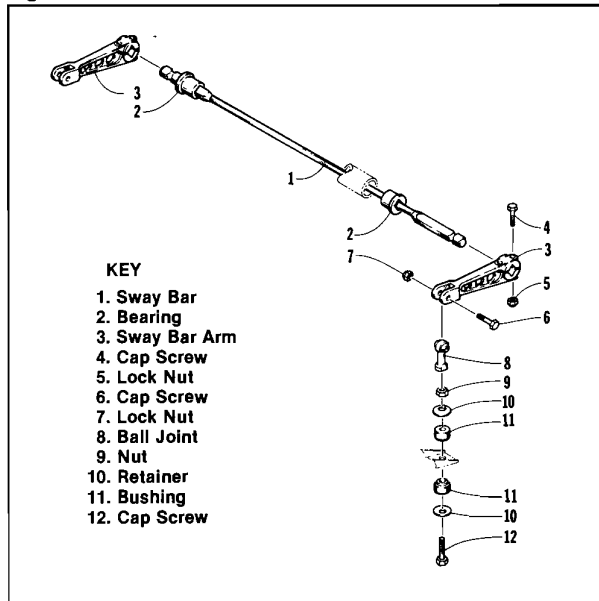
1. Inspect the sway bar for any signs of twisting, fatigue, or wear.
2. Inspect the sway bar arms for cracks or damage.
3. Inspect the bushings, bushing retainers, and hardware for damage or wear.

6



## Installing Sway Bar

Fig. 6-51



0728-386

1. Place the sway bar into position; then install a bearing on each end of the sway bar.

**NOTE:** Perform steps 2-5 on both sides of the snowmobile.

2. Place a bushing retainer and bushing onto the sway bar adjusting cap screw; then slide it up through the bracket on the lower arm. Place another bushing and bushing retainer on the cap screw; then apply LOCTITE LOCK N' SEAL to the area above the bushing retainer and install the jam nut. Tighten to 0.4 kg-m (3 ft-lb).
3. Thread the ball joint onto the adjusting cap screw.
4. Slide a sway bar arm onto the sway bar until the holes in the arm align with the notch in the sway bar. Install the two cap screws and lock nuts. Tighten to 1.8 kg-m (13 ft-lb).
5. Place the ball joint into position on the sway bar arm; then secure with a cap screw and lock nut. Tighten to 3.2 kg-m (23 ft-lb).
6. Check and adjust sway bar linkage (see Adjusting Sway Bar section).

## Removing Console and Console Extension

1. Pull the recoil rope outward; then tie a slip knot in the recoil rope near the recoil case. Slowly allow the rope to retract to the knot.
2. Untie the knot in the end of the recoil rope; then remove handle from rope.
3. Disconnect the wiring harnesses from the battery light, key, warmer, and tether switches.
4. Disconnect the speedometer cable and wiring harness from the speedometer. Disconnect the wiring harness from the tachometer.
5. Remove the screws securing the console extension; then remove the console extension.
6. Remove the screws securing the console.
7. Remove the gas cap and spill seal; then remove the console.

## Installing Console and Console Extension

1. Place the console into position; then install the spill seal and gas cap. Secure the console with screws.
2. Place the console extension into position and secure with screws.
3. Connect the speedometer cable and wiring harness to the speedometer. Connect the wiring harness to the tachometer.
4. Connect the wiring harnesses to the battery light, key, warmer, and tether switches.
5. Thread the recoil rope through the console and recoil handle. Tie a knot at the end of the recoil rope. Remove the slip knot and allow the rope to retract.

## Removing Seat/Gas Tank Assembly

1. Remove the console and console extension.
2. Disconnect the wiring harness and fuel lines from the fuel pump. Label the hoses. Remove the vent line from its fitting.

### WARNING

Fuel supply hose may be under pressure. Place an absorbent towel around the connection when removing.

3. Remove the two lock nuts and washers securing the seat to the tunnel. The lock nuts are located inside the toolbox.
4. Pull seat back just far enough to disconnect the taillight wiring harness; then remove the seat from the tunnel.

## Installing Seat/Gas Tank Assembly

1. Place the seat/gas tank assembly into position on the tunnel; then connect the taillight wiring harness.
2. Connect the fuel supply hose and vent hose to the gas tank.
3. Secure the seat to the tunnel with two screws, washers, and lock nuts.
4. Install the console and console extension.

## Removing Seat Cushion

1. Remove the seat/gas tank assembly.
2. Remove the rod securing the front of the seat cover; then, using a sharp tool, pry out all staples securing the seat cushion to the plastic seat base. Remove the cover from the seat base and foam.

## Installing Seat Cushion

1. Position cover over seat foam and base. Check to make sure it is positioned straight.
2. Fold the rear edge of the cushion down and around the plastic base. Using a staple gun and 6 mm (1/4 in.) staples, staple the rear flap of cushion to the plastic base in the same area as it was originally located. Position staples 2.5 cm (1 in.) apart.
3. Fold the sides of the cushion down around the bottom edge of the plastic seat base. Position staples in the same area as original staples were found.

**NOTE:** Pay close attention to cushion fit. If any wrinkles are noted, correct by pulling the cushion material in the appropriate direction before securing with staples.

4. Pull the seat cushion forward so it is tight and free of all wrinkles; then place the seat cushion rod into position and secure with two lock nuts. Tighten securely.



5. Place the seat/gas tank assembly into position, connect the taillight wiring harness, and secure with two lock nuts and washers.
6. Connect the fuel line and the vent line to their fittings.
7. Place the console and console extension into position and secure.

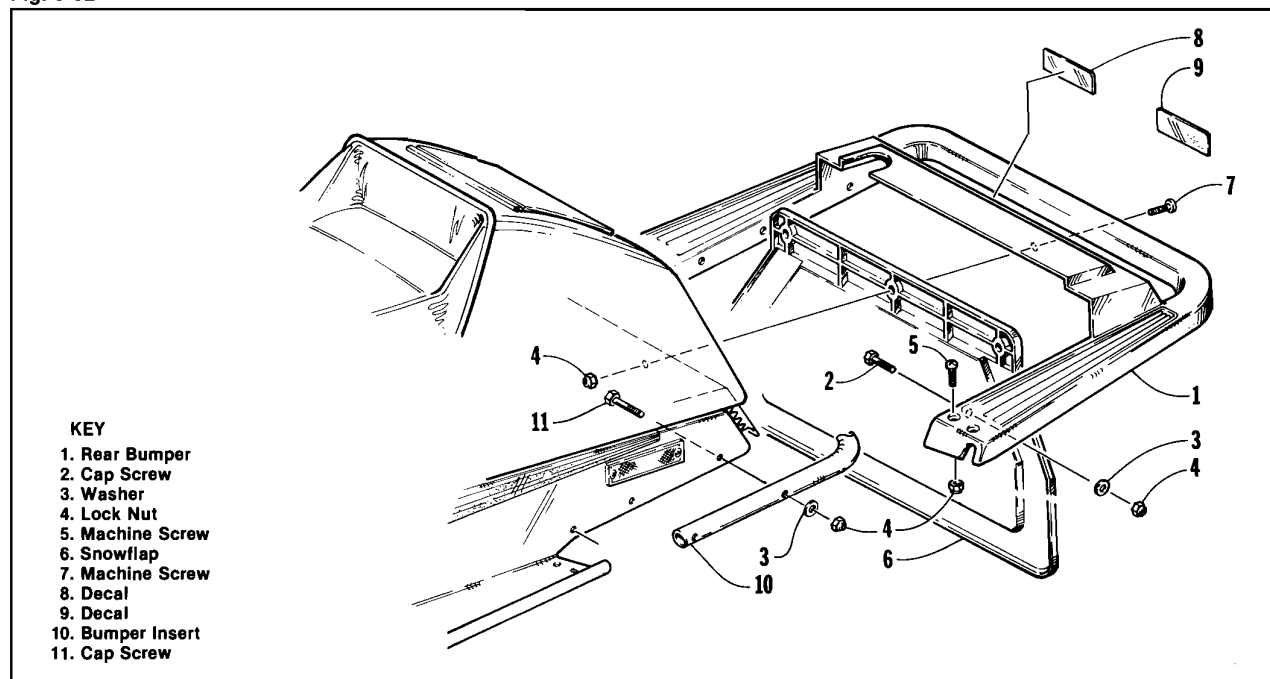
2. Remove the three lock nuts, washers, and cap screws from each side of the tunnel.
3. Remove the two machine screws and lock nuts securing the bumper to each running board.
4. Remove the three machine screws and lock nuts securing the snowflap and bumper to the lower edge of the heat exchanger.
5. Remove the snowflap, bumper, and inner support tube.

## Removing Rear Bumper and Snowflap

1. On standard models, loosen the lock nuts securing the rear of the seat base to the tunnel. Lift the rear of the set just enough to slip the plastic bumper shell from between the seat base and tunnel. On Mountain Cat models, remove the tunnel extension cover.

## Installing Rear Bumper and Snowflap

Fig. 6-52



0728-385

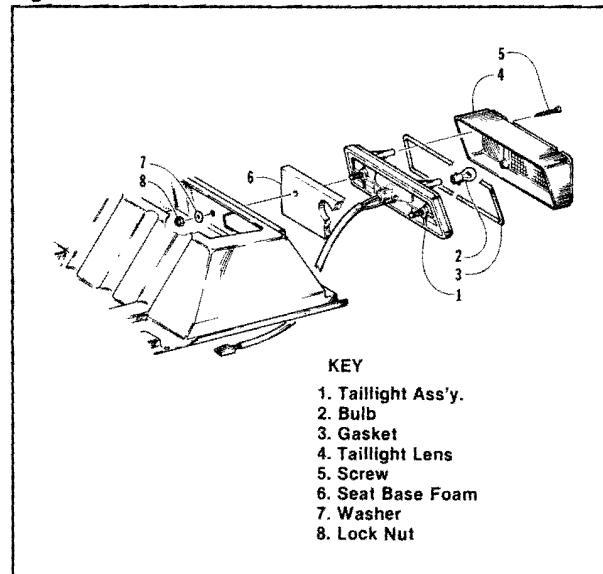
1. Place the inner support tube into the rear bumper; then place the rear bumper into position with its plastic shell between the seat base and tunnel.
2. Secure the bumper to the sides of the tunnel using six cap screws and lock nuts. The nuts must be located on the outside of the tunnel.
3. Secure the bumper to the running boards with four machine screws and lock nuts. The nuts should be positioned on the bottom side of the running board.
4. Slide the snowflap between the plastic shell and heat exchanger. Secure with three machine screws and lock nuts.
5. Tighten all bumper mounting hardware. On standard models, tighten the two lock nuts securing the rear of the seat base. On Mountain Cat models, install the tunnel extension cover.

## Removing Taillight Housing

1. Remove the four screws securing the taillight lens to the housing. Account for a gasket.
2. Remove the two lock nuts and washers securing the taillight housing. Pull the housing free.

## Installing Taillight Housing

Fig. 6-53



0728-364

1. Place the taillight housing into position and secure with two lock nuts and washers. Tighten securely.
2. Install taillight bulb, gasket, and lens. Secure lens with four screws.

6

## Removing Hood

1. Open the hood. Disconnect the headlight wiring harness connector down near the left hood hinge.
2. While supporting the hood in the open position, remove the hood cable.
3. Close the hood; then remove the two hood hinges pins. Open and lift the hood free of the snowmobile and place on a clean piece of cardboard.

**NOTE:** If the hood is being replaced; remove the two hood hinges, headlight assembly, and the windshield.



## Installing Hood

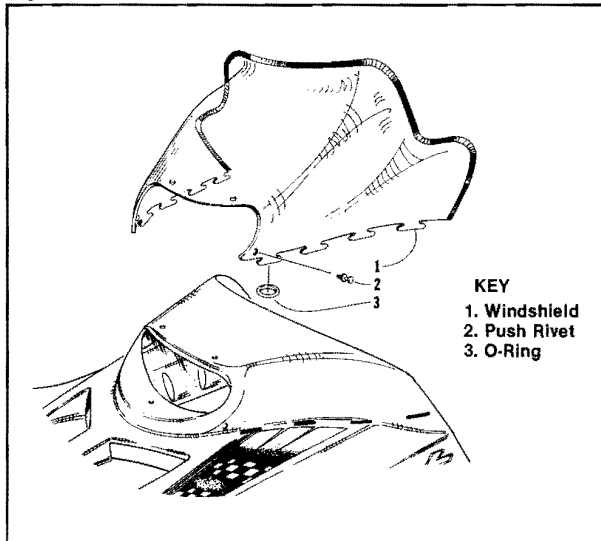
1. Set the hood into position and secure with two hinge pins and cotter pins.
2. Open the hood; then connect the hood cable. Connect the headlight wiring harness.

## Removing Windshield

1. Remove the push clips and O-rings securing the windshield.
2. Remove the windshield.

## Installing Windshield

Fig. 6-54



0729-793

1. Place the windshield into position and install the push clips.

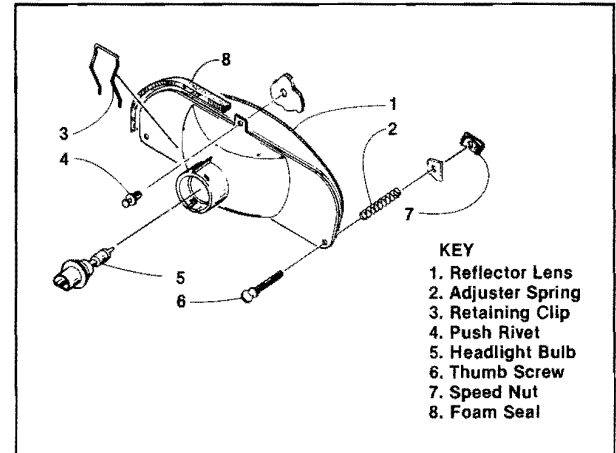
2. Push the sides of the windshield down and install the O-rings.

## Removing Headlight Assembly

**NOTE:** The headlight assembly is secured at the top with a single plastic push rivet. It is located at the top center of the assembly.

1. To remove the headlight assembly, first locate the plastic push rivet by using a small flashlight and looking over the top of the lens from the front of the hood. With the push rivet located, use a small flat blade screwdriver to push the center post of the rivet back.

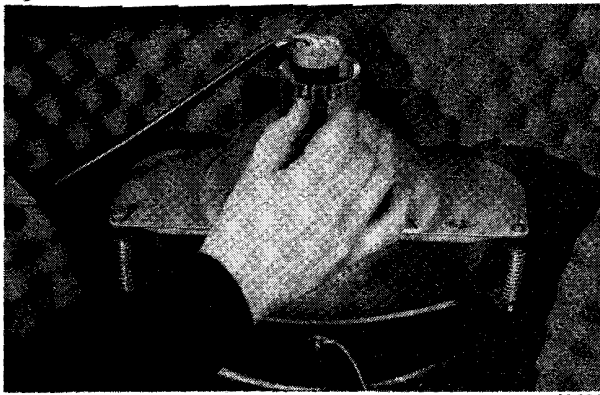
Fig. 6-55



0730-440

2. Open the hood; then unsnap the wire spring clip and remove the bulb assembly from the lens. Do not touch the bulb lens area.

Fig. 6-56



AL084

3. Unscrew the two adjustment screws securing the bottom of the headlight lens assembly; account for the two springs as the adjustment screws are removed. Lift the headlight assembly free of the hood.

## Installing Headlight Assembly and Bulb

1. Secure the headlight lens assembly with one plastic push rivet and two adjustment screws and springs.
2. Connect the headlight harness to the bulb; then place the bulb and harness assembly into position and secure with the wire spring clip.

Fig. 6-57



AL085

**NOTE:** The bulb portion of the headlight is fragile. Handle with care. When replacing the headlight bulb, the bulb must not be touched. If the glass is touched it must be cleaned with a dry cloth before installing.

3. Adjust headlight aim.

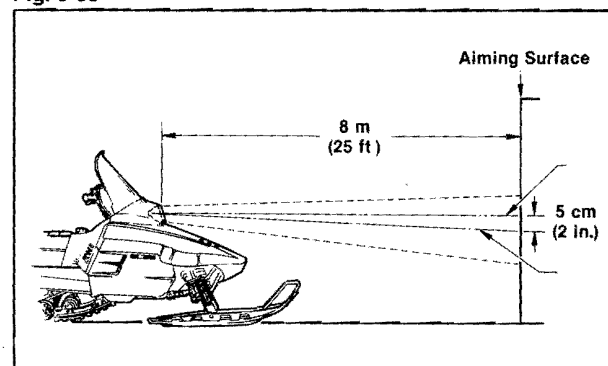
## Adjusting Headlight Aim

The headlight can be adjusted vertically and horizontally. The geometric center of the HIGH beam light zone is to be used for vertical and horizontal aiming.

1. Position the snowmobile on a level floor so the headlight is approximately 8 m (25 ft) from an aiming surface (wall or similar surface).
2. Measure the distance from the floor to midpoint of the headlight.
3. Using the measurement obtained in step 2, make a horizontal mark on the aiming surface.
4. Make a vertical mark which intersects the horizontal mark on the aiming surface directly in front of the headlight.
5. Start the engine. Move the headlight dimmer switch to the HIGH beam position. **DO NOT USE LOW BEAM.**
6. Observe the headlight beam aim. Proper aim is when the most intense beam is centered on the vertical mark 5 cm (2 in.) below the horizontal mark on the aiming surface.
7. Adjust the vertical and horizontal adjusting screws until the correct aim is obtained.

6

Fig. 6-58



0728-235



# SECTION 7 - TRACK/SUSPENSION

## TABLE OF CONTENTS

Skid Frame Schematics . . . . .	164
Removing Skid Frame . . . . .	166
Disassembling and Assembling Skid Frame . . . . .	166
End Cap . . . . .	166
Wear Strip . . . . .	167
Rear Spring . . . . .	168
Rear Idler Wheels & Axle . . . . .	169
Rear Arm . . . . .	170
Front Arm . . . . .	173
Front Idler Wheels & Bracket, Front Shock Bracket, and Front Arm Bracket . . . . .	174
Front Shock Absorber . . . . .	178
Rear Shock Absorber and Shock Rods . . . . .	178
Rear Shock Pivot . . . . .	180
Rear Inner Idler Wheels . . . . .	181
Slide Rail . . . . .	181
Installing Skid Frame . . . . .	184
Track Tension . . . . .	185
Track Alignment . . . . .	186
Adjusting Suspension . . . . .	187
Adjusting Front Shock Springs . . . . .	187
Adjusting Skid Frame Front Shock . . . . .	187
Adjusting Rear Spring Tension . . . . .	187
Adjusting Sway Bar Linkage . . . . .	188

# Skid Frame Schematics

Fig. 7-1

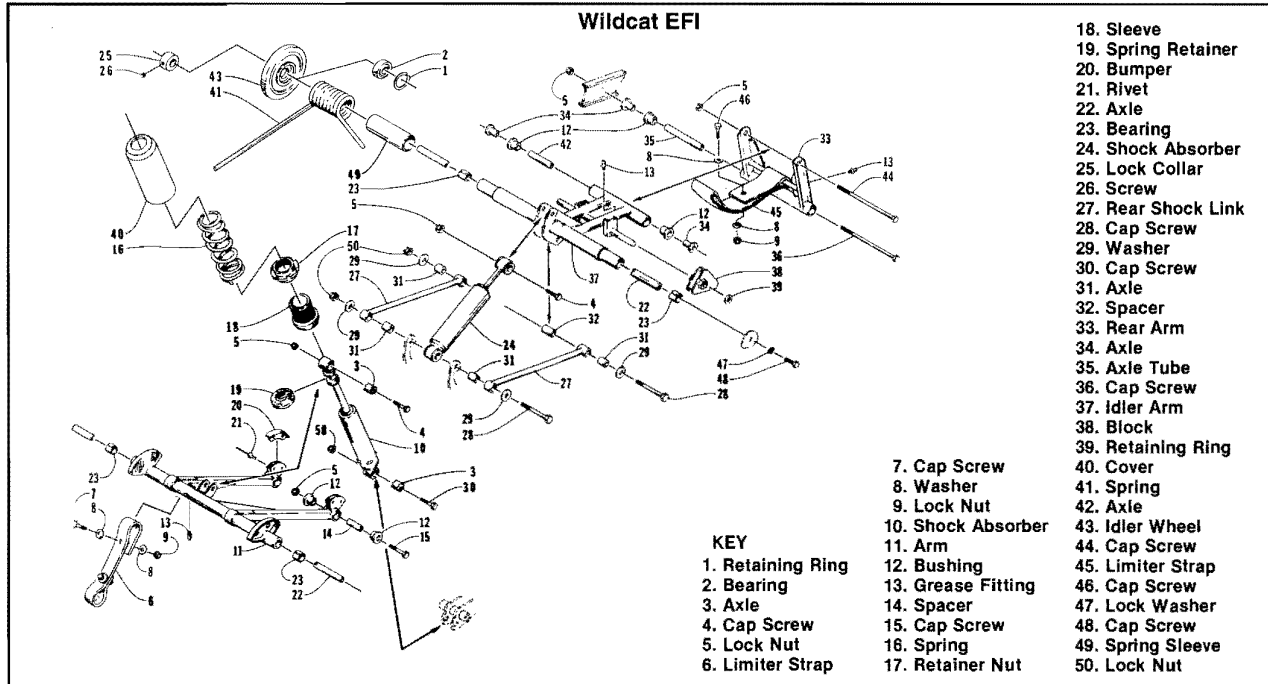


Fig. 7-2

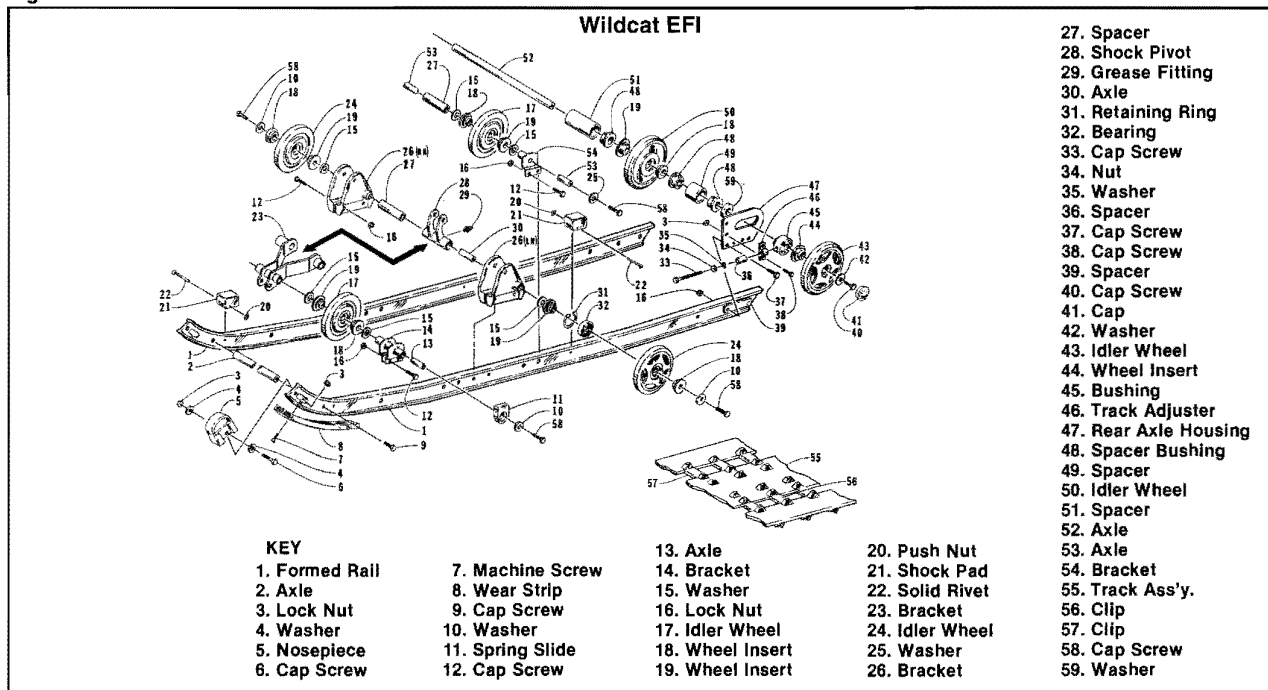




Fig. 7-3

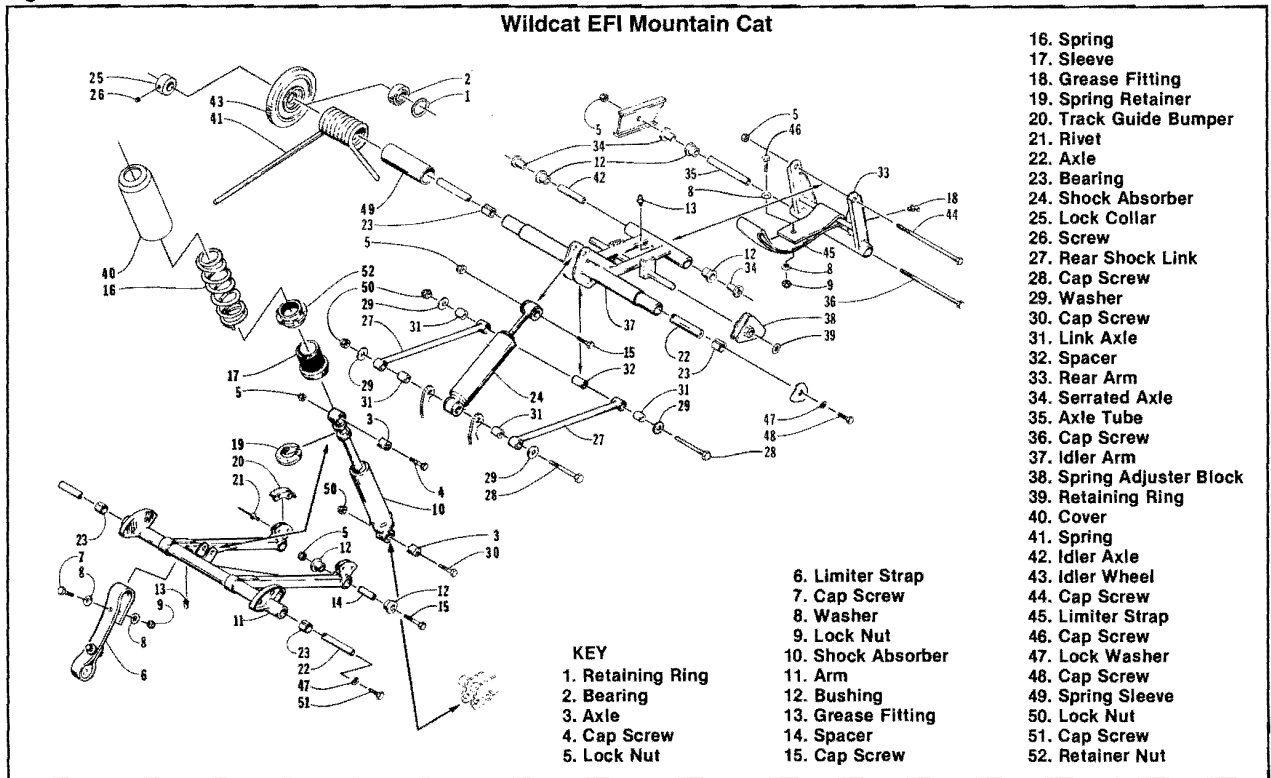
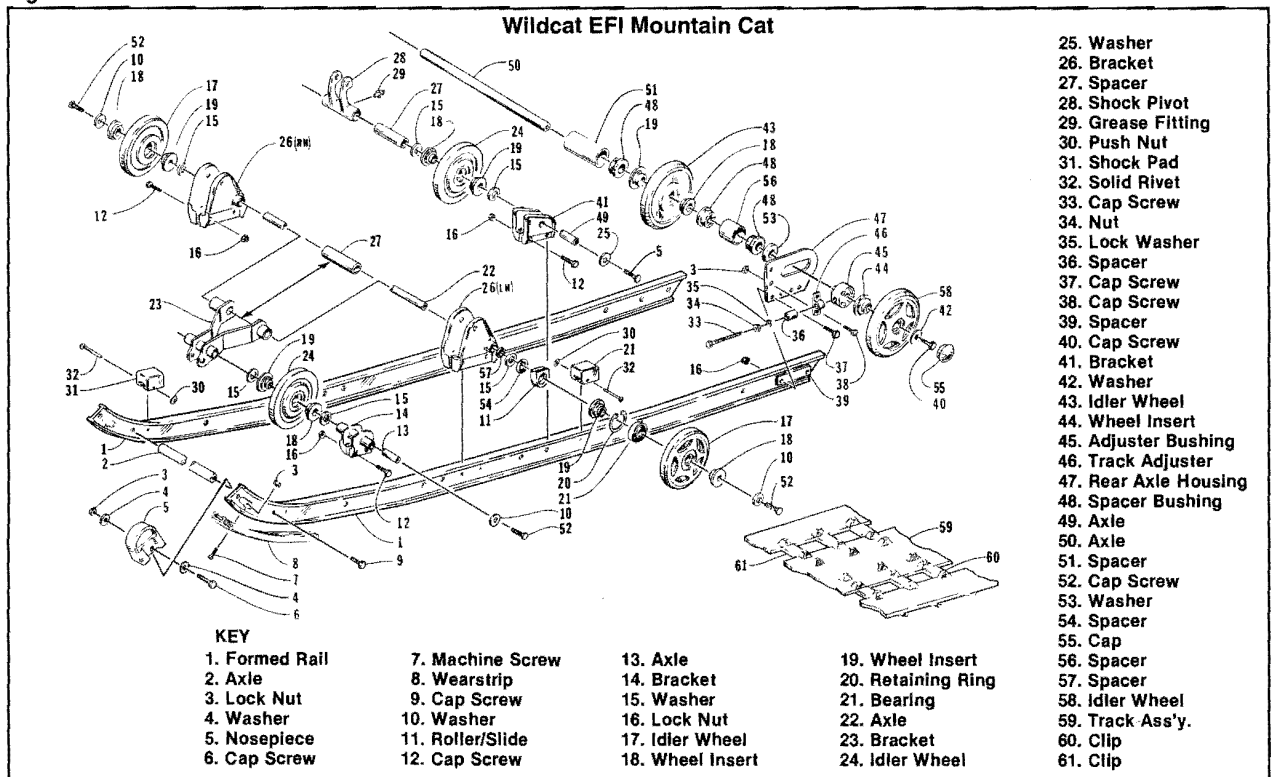


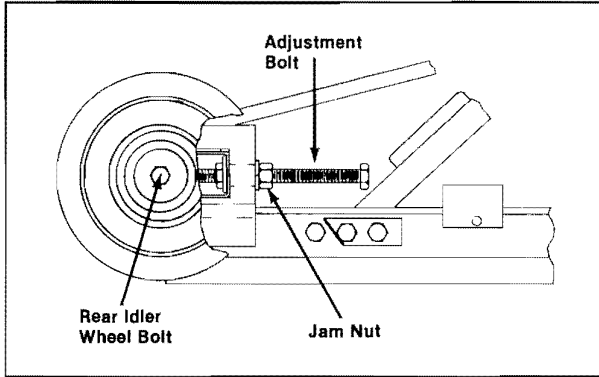
Fig. 7-4



## Removing Skid Frame

1. Loosen the jam nuts and two track-tension adjustment cap screws.

Fig. 7-5



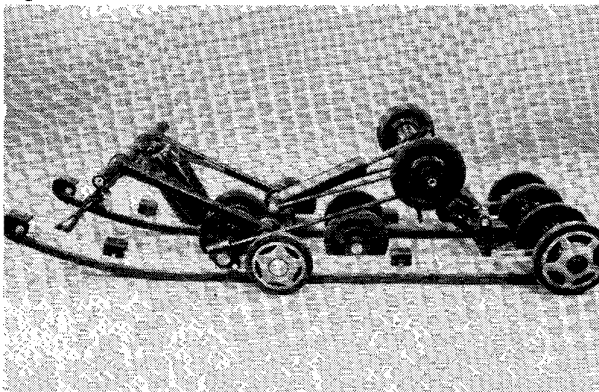
0727-752

2. Place a support stand under the rear bumper; then remove the four cap screws securing the skid frame to the tunnel.

**NOTE:** The support should hold the snowmobile level and not raised off the shop floor.

3. Disconnect the negative battery cable; then the positive cable. Remove the nuts, washers, and cap screws securing the battery box. Remove the battery and box.
4. Remove the support stand; then tip the snowmobile onto one side using a piece of cardboard to protect against scratching. Remove the skid frame.

Fig. 7-6



AG296

## Disassembling and Assembling Skid Frame

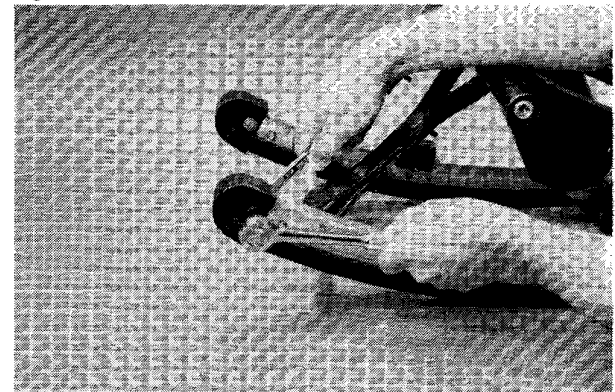
**NOTE:** This track and suspension system section has been written so each disassembly and assembly procedure can be completed individually. For each subsection, a complete disassembling, inspection, and assembling procedure will be found.

### END CAP

#### Removing

1. Remove the lock nut, washer, and cap screw securing the end cap. Using a hammer, tap the end cap off the rail.

Fig. 7-7



AG297

#### Cleaning & Inspecting

**NOTE:** Whenever a part is worn excessively, cracked, defective, or damaged in any way, replacement is necessary.

1. Inspect the end cap area of the slide rail for cracks and wear.
2. Inspect the end cap for any signs of cracking or wear.
3. Using a high pressure air hose, clean both the slide rail and the end cap areas of dirt and gravel.



**⚠ WARNING**

Always wear an approved pair of safety glasses while using a high pressure air hose.

4. Inspect the cap screw for cracked, stretched, or damaged threads. Use a new lock nut when assembling.

**Installing**

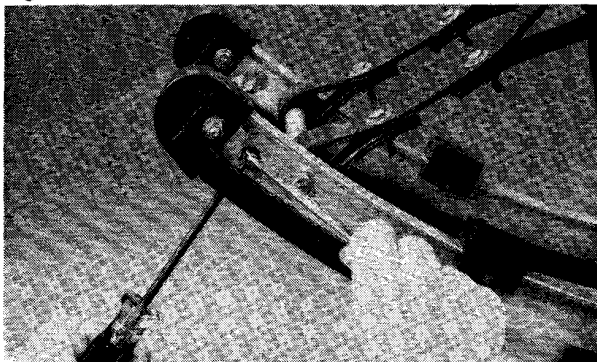
1. Position the end cap on the slide rail, align the hole in the end cap with the hold in the slide rail and install the cap screw, washer, and new lock nut. Torque lock nut to 1.5 kg-m (11 ft-lb).

**WEAR STRIP**

**Removing**

1. Remove the machine screw and lock nut securing the wear strip to the front of the slide rail.

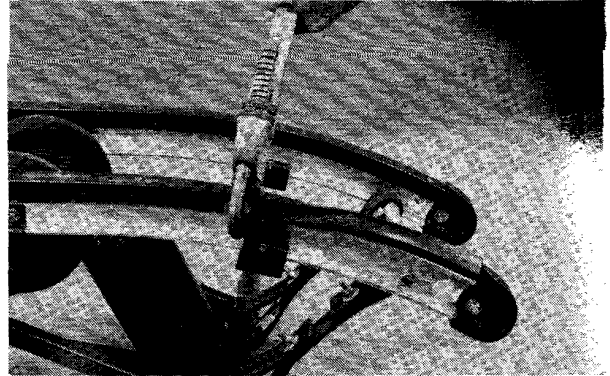
Fig. 7-8



AG298

2. Using a pipe wrench and starting from either end, hook the edge of the wear strip with the pipe wrench jaw and twist the wear strip off the slide rail. Move the pipe wrench 7.5 cm (3 in.) and again twist the wear strip off the rail. Repeat procedure until the wear strip is free of the rail.

Fig. 7-9



AG299

**NOTE:** The wear strip can also be driven off the slide rail using a block of wood and hammer; however, it is much quicker to use a pipe wrench.

**Cleaning & Inspecting**

**NOTE:** Whenever a part is worn excessively, cracked, defective, or damaged in any way, replacement is necessary.

1. Inspect the slide rail for cracks. If any crack is found, replace the slide rail.
2. Using a straightedge, inspect the slide rail for any unusual bends. Place the straightedge along the top surface of the slide rail. If the rail is found to be bent, it must either be straightened or replaced.
3. Clean the slide rail using parts-washing solvent and a high pressure air hose.

**⚠ WARNING**

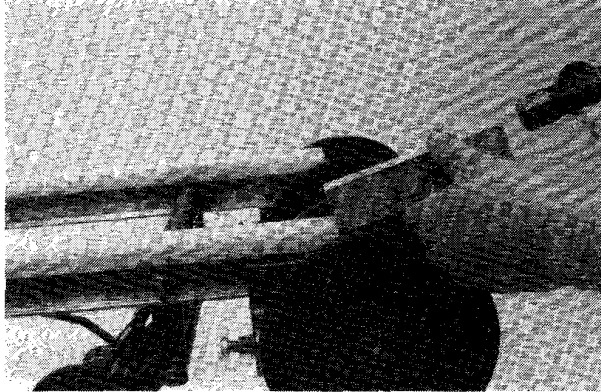
Be sure to wear an approved pair of safety glasses while using a high pressure air hose.

**Installing**

**NOTE:** Apply a light coat of grease to the slide rail surface to aid in installing new wear strips.

1. Starting from the back, start the wear strip onto the rail; then using a block of wood and a hammer, drive the wear strip forward into position. Secure with a machine screw and lock nut.

Fig. 7-10



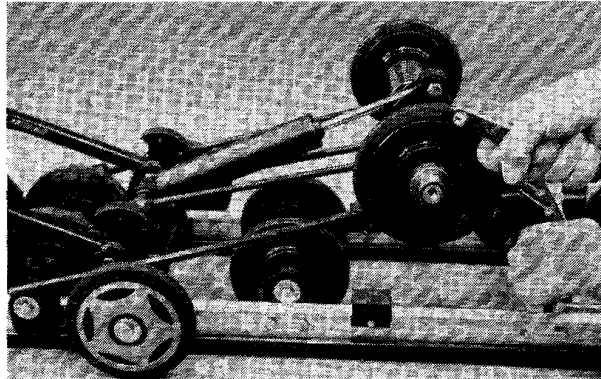
AG070

## REAR SPRING

### Removing

1. Remove the set screw from the lock collar securing the upper idler wheels to the rear arm; then remove the lock collar.

Fig. 7-11

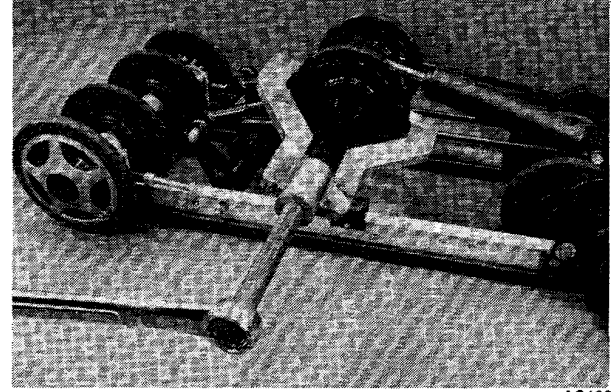


AG307

2. Using the Idler Wheel Puller Kit (p/n 0644-122), pull the idler wheel from the upper arm.

**NOTE:** For assembly purposes, scribe a line on the upper arm tube marking the location of the idler wheel bearing. Mark the inside edge of the bearing.

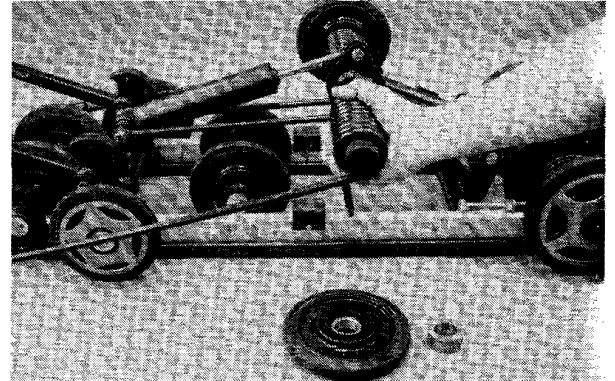
Fig. 7-12



AG199

3. Slide the spring and the plastic sleeve off the rear arm.

Fig. 7-13



AG308

4. Repeat these steps for the other rear spring.

### Inspecting

**NOTE:** Whenever a part is worn excessively, cracked, defective, or damaged in any way, replacement is necessary.

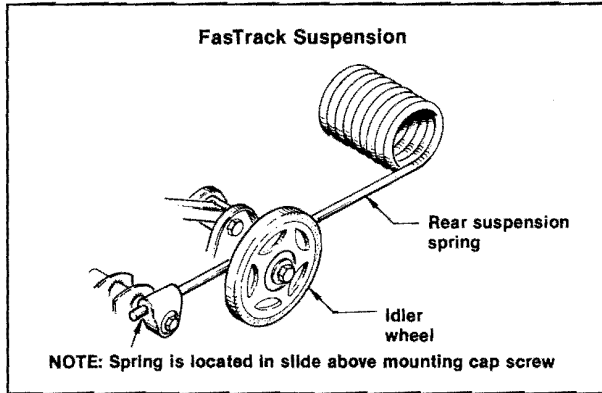
1. Inspect the spring slide, washers, and shaft area for wear.
2. Inspect the rear adjustment cam for cracks.

### Installing

1. Slide the spring and plastic sleeve onto the rear arm.
2. Position the long spring leg into the spring slide. Make sure the spring is located above the spring slide mounting bolt.



Fig. 7-14



3. Position the idler wheel with the snap ring facing inward on the rear arm. Drive the idler wheel into position (up to line scribed earlier) using the Idler Wheel Puller Kit (p/n 0644-122), and secure with a lock collar and set screw.

## REAR IDLER WHEELS & AXLE

### Disassembling

1. Remove the idler wheel caps; then remove the cap screws and large flat washers securing the outer idler wheels. Remove the idler wheels from the shaft.

**NOTE:** The large wheel insert is positioned next to the inner plastic adjuster bushing. The idler wheel must be installed with the large wheel insert properly positioned.

Fig. 7-15

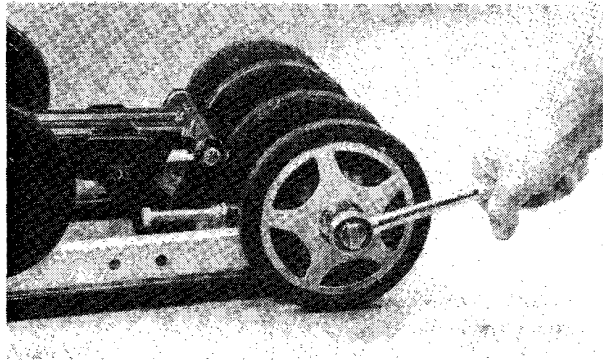
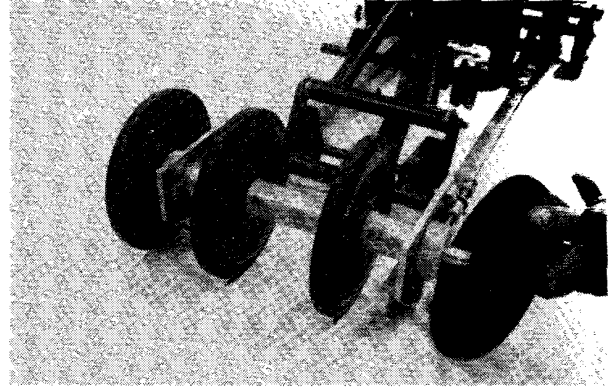
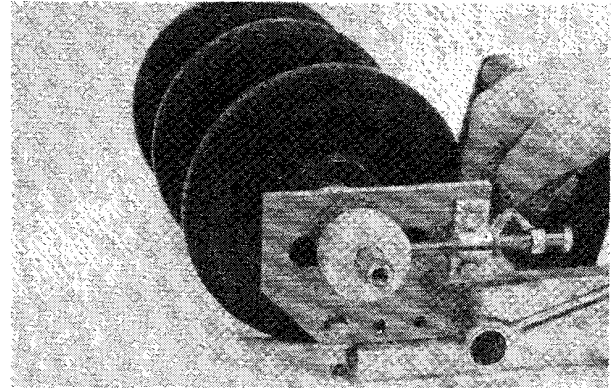


Fig. 7-16



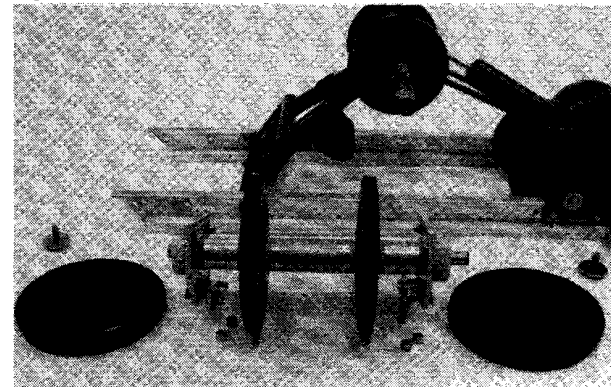
2. Remove the two cap screws and lock nuts securing each of the rear axle brackets to the rails. Remove the brackets and account for the spacers.

Fig. 7-17



3. Carefully slide the shaft out from the inner idler wheels and note the position of the spacers.

Fig. 7-18



## Inspecting

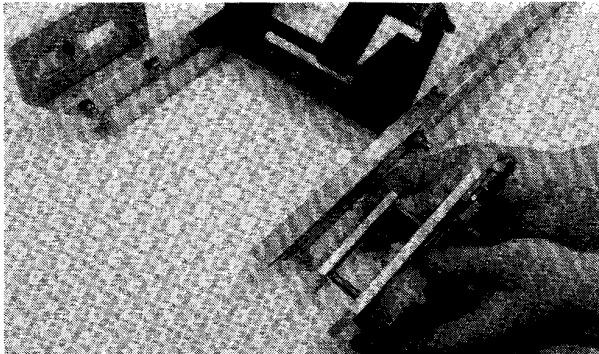
**NOTE:** Whenever a part is worn excessively, cracked, defective, or damaged in any way, replacement is necessary.

1. Inspect all idler wheel bearings. Turn each bearing (by hand) and if any roughness or binding is noted, replace the idler wheel assembly.
2. Check all idler wheel inserts (inner and outer) for any cracks.
3. Inspect the outer rubber portion of the idler wheels for cracks and poor bonding.
4. Inspect the plastic hub of each idler wheel for cracking.
5. Inspect the shaft for wear and damaged threads. Damaged threads may be repaired with a 3/8 x 16 tap.

## Assembling

1. Assemble the rear axle brackets and spacers on the slide rails. Secure each bracket with two cap screws and lock nuts. Torque to 1.5 kg-m (11 ft-lb).

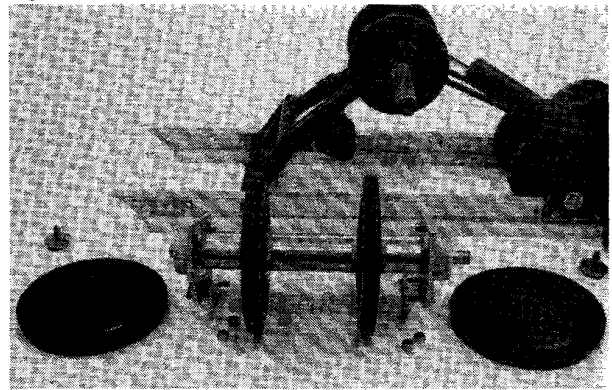
Fig. 7-19



AG077

2. Slide the axle through an axle bracket and, in order, place a short spacer, idler wheel, long spacer, idler wheel, and short spacer on the axle. Push the axle through the opposite axle bracket. Place the plastic adjuster bushings on the axle on the outside of each axle bracket. Make sure the hole in each adjuster bushing is positioned towards the adjuster bolt.

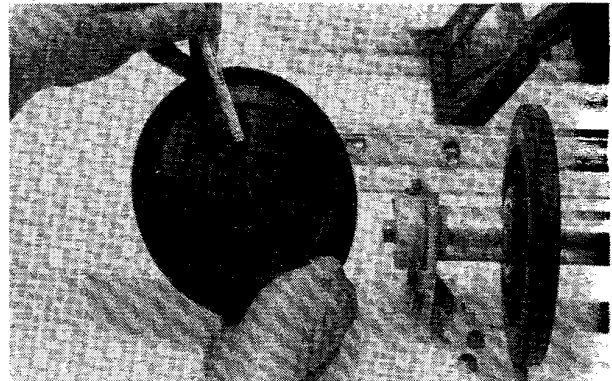
Fig. 7-20



AG078

3. Place the outer idler wheels on the axle with the large insert directed inward and secure with two cap-lock screws. Torque cap-lock screws to 1.5 kg-m (11 ft-lb). Install the idler wheel caps.

Fig. 7-21



AG124

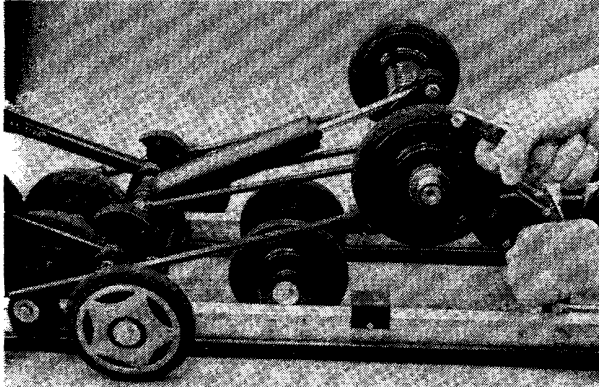
## REAR ARM

### Disassembling

1. Remove the set screw from the lock collar securing the upper idler wheel to the rear arm; then remove the lock collar and idler wheels.



Fig. 7-22

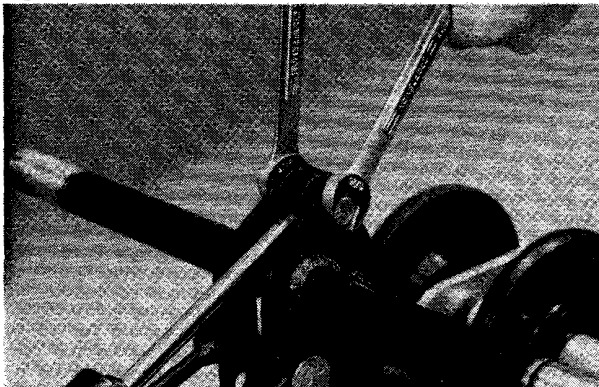


AG307

**NOTE:** If the idler wheels are frozen to the rear arm, use Idler Wheel Puller (p/n 0644-122) to remove the idler wheels.

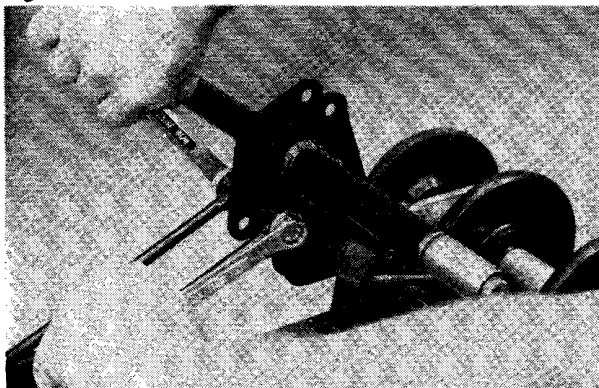
3. Remove the cap screw and lock nut securing the upper shock eyelet to the rear arm.

Fig. 7-23



AG309

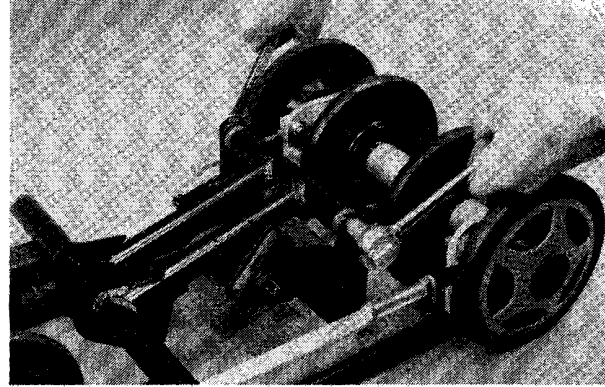
Fig. 7-24



AG310

4. Remove the lock nut and cap screw securing the rear arm at its center pivot point. Account for two axles and a center tube.

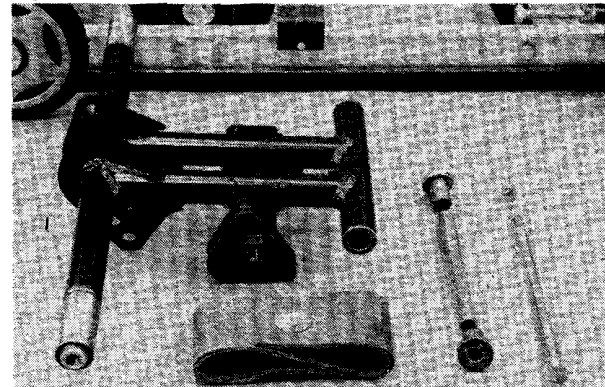
Fig. 7-25



AG311

5. Remove the lock nut, washer, and cap screw securing the limiter strap to the rear arm. Remove limiter strap.

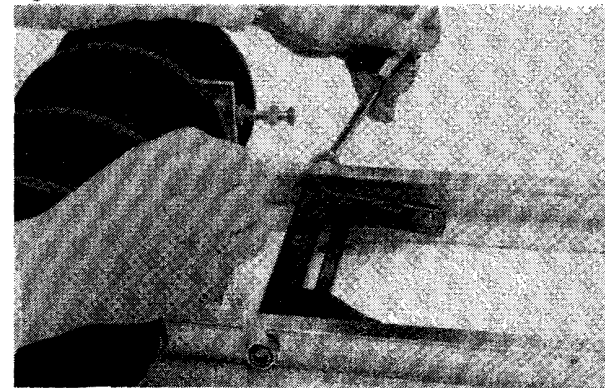
Fig. 7-26



AG312

6. Remove the lock nut and cap screw securing the lower arm to the slide rails. Twist the arm forward and from between the slide rails.

Fig. 7-27



AG083

7



## Inspecting

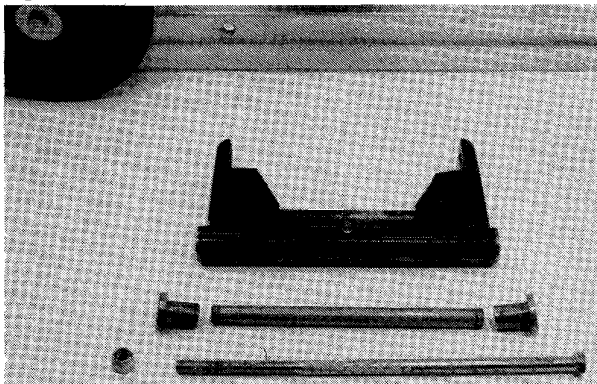
**NOTE:** Whenever a part is worn excessively, cracked, defective, or damaged in any way replacement is necessary.

1. Inspect each idler wheel and plastic hub for cracks or damage.
2. Rotate the idler wheel bearings (by hand) and check for binding or roughness.
3. Examine the bushings (located in the arm pivot area) for wear or damage.
4. Examine all welds and the tubing of the upper arm for cracks or unusual bends.
5. Inspect the two adjustment cams for damage.

## Assembling

1. Apply grease to the bushings and axles; then place the axle tube and the two axles into position in the lower arm.

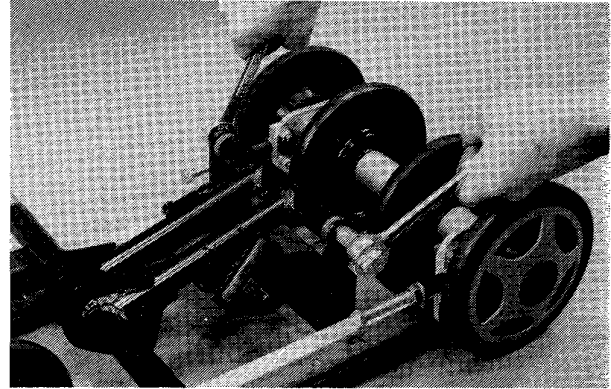
Fig. 7-28



AF084

2. Place the lower arm into position between the slide rails with the grease fitting forward and secure with a cap screw and lock nut. Torque to 3.2 kg-m (23 ft-lb).
3. Position the upper arm with axles into the lower arm and secure with a cap screw and lock nut. Torque to 3.2 kg-m (23 ft-lb).

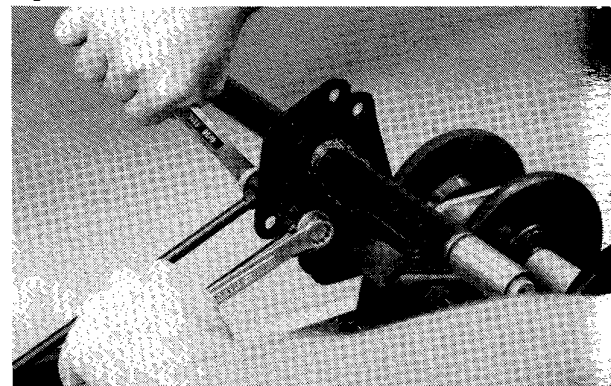
Fig. 7-29



AG311

4. Place the limiter strap into position around the upper and lower arm tubes and secure with cap screw, washers, and lock nut.
5. Position the shock rods into the upper hole of the rear arm bracket. Place a spacer between the center of the brackets and push the cap screw through the shock rod, spacer, bracket, and remaining shock rod. Secure with a washer and lock nut. Torque to 3.2 kg-m (23 ft-lb).

Fig. 7-30



AG310

6. Place the shock eyelet between the upper arm brackets and secure with a cap screw and lock nut. Torque to 3.2 kg-m (23 ft-lb).

**NOTE:** Do not over-tighten the shock cap screws as the shock eyelet must be free to pivot.

7. Grease the pivot tube of the upper and lower arm.

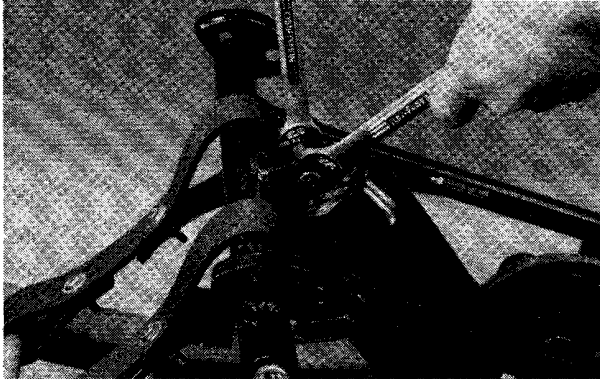


## FRONT ARM

### Disassembling

1. Remove the cap screw securing the upper shock absorber eyelet to the front arm. Pull the shock eyelet free of the bracket.

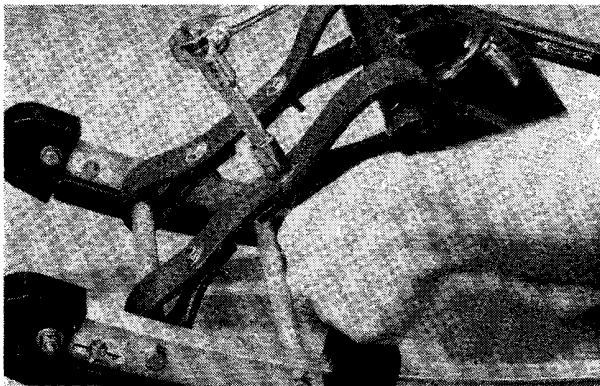
Fig. 7-31



AG303

2. Remove the upper cap screw, washers, and lock nut securing each limiter strap to the front arm.

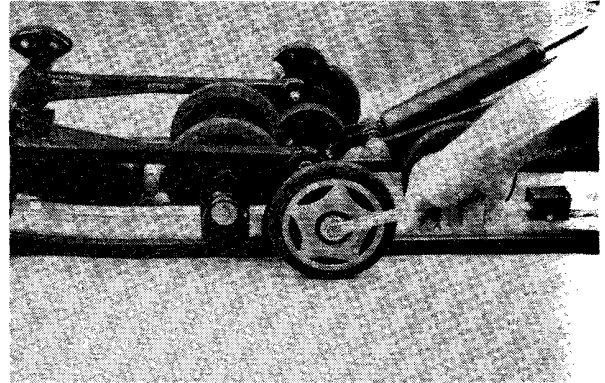
Fig. 7-32



AG300

3. Remove the cap screws and washers securing the outer idler wheels and slide the idler wheels from shaft.

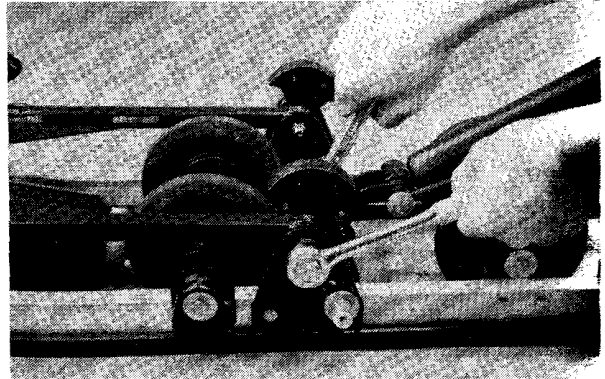
Fig. 7-33



AG322

4. Remove the two cap screws and lock nuts securing the front arm to the slide rail brackets.

Fig. 7-34



AG304

5. Remove the front arm and account for the axles.

### Inspecting

**NOTE:** Whenever a part is worn excessively, cracked, defective, or damaged in any way, replacement is necessary.

1. Inspect all front arm weldments for cracks or unusual bends.
2. Closely inspect all tubing (square and round) for cracks or unusual bends.
3. Inspect the bushings and axles for wear or damage.
4. Check the upper and lower track bumpers. If worn, remove the rivets securing the bumpers to the arm and replace with new bumpers.

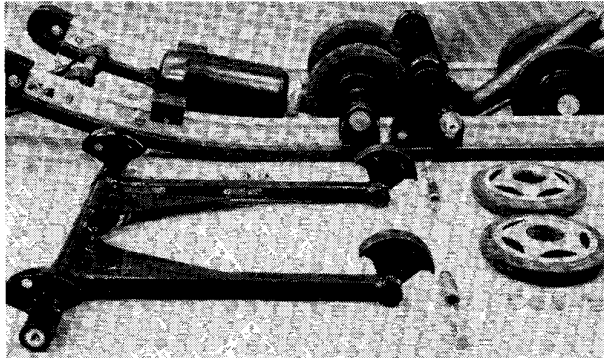
7



## Assembling

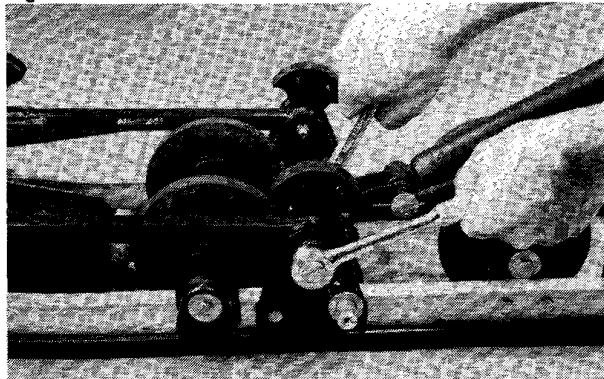
1. Apply a light coat of grease to the axles and bushing areas. Position the front arm into the mounting brackets (upper holes) and secure with two cap screws and lock nuts. Position lock nuts to the inside of the brackets. Torque to 3.2 kg-m (23 ft-lb).

Fig. 7-35



AG305

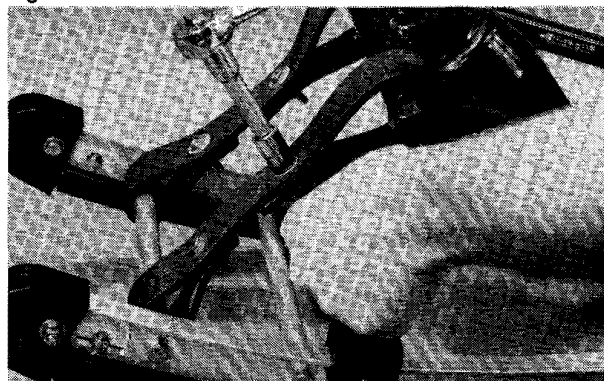
Fig. 7-36



AG304

2. Wrap the limiter straps around the front arm and align the holes. Secure each strap with a cap screw, washers (one on each side of the strap), and lock nut. Tighten securely.

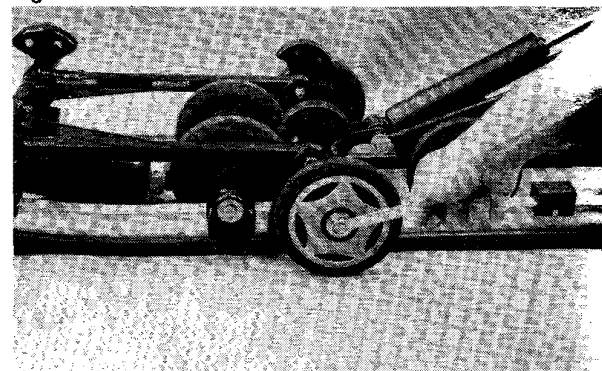
Fig. 7-37



AG300

3. Install the outer idler wheels on the idler wheel shaft and secure with flat washers and cap screws. Tighten securely.

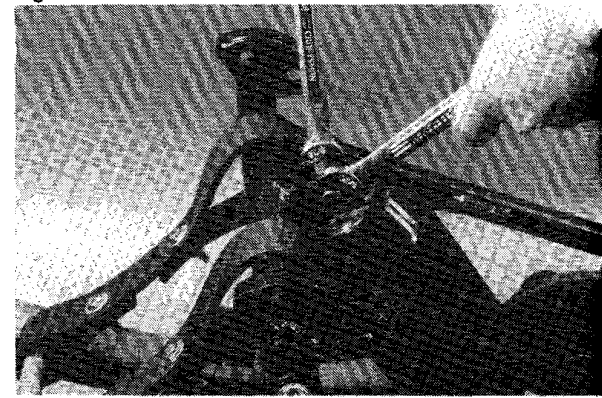
Fig. 7-38



AG322

4. Position the shock eyelet with bushing into the bracket of the front arm and secure with a cap screw and lock nut. Torque to 3.2 kg-m (23 ft-lb).

Fig. 7-39



AG303

**NOTE:** Do not over-tighten the shock cap screws as the shock eyelet must be free to pivot.

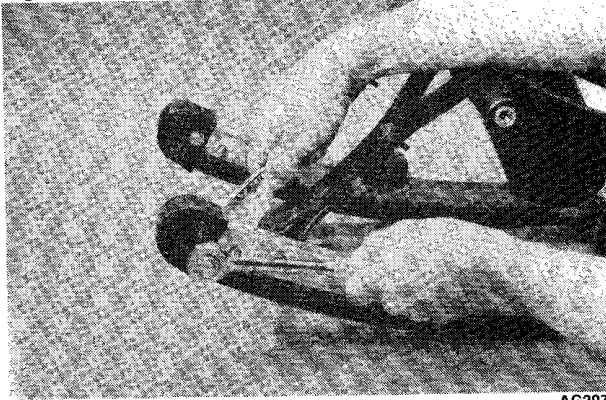
## FRONT IDLER WHEELS & BRACKET, FRONT SHOCK BRACKET, AND FRONT ARM BRACKET

### Disassembling

1. Remove the lock nut, washers, and bolt securing the end cap; then remove the end cap.



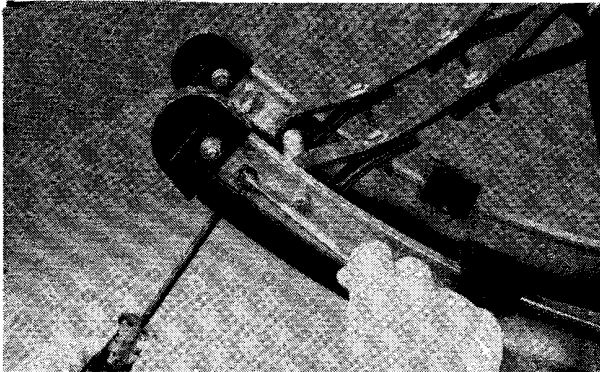
Fig. 7-40



AG297

2. Remove the lock nut securing the wear strip to the slide rail.

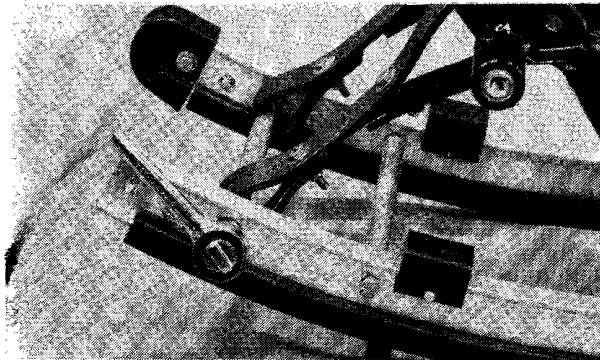
Fig. 7-41



AG298

3. Remove the four cap screws securing both front crossbrace tubes; then remove the crossbraces.

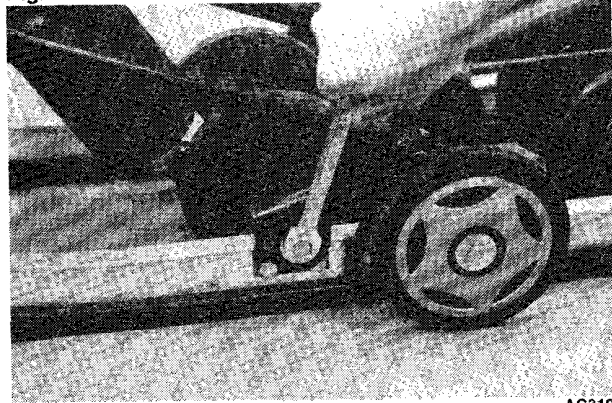
Fig. 7-42



AG301

4. Remove the push nut and pin securing the shock pad and remove the pad.
5. Remove the cap screw and flat washer securing the rear spring slide block and remove the spring slide block.

Fig. 7-43



AG319

6. Remove the cap screw and lock nut securing the lower shock eyelet to the front shock bracket. Swing shock forward out of bracket. Account for a bushing.

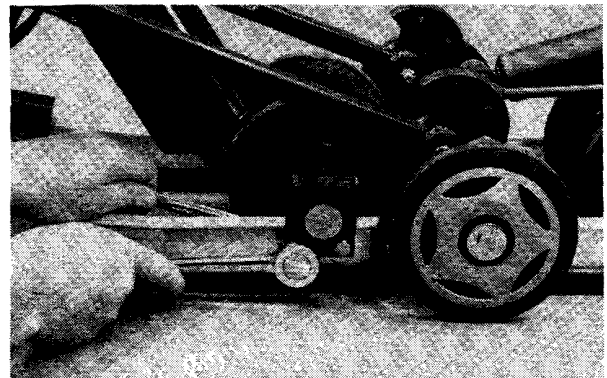
Fig. 7-44



AG317

7. Slide the idler wheel axle out of the front idler wheel brackets and idler wheels; then remove the idler wheels. Account for spacers.
8. Remove the two cap screws and lock nuts from the front shock bracket and slide the bracket forward off the rail.

Fig. 7-45



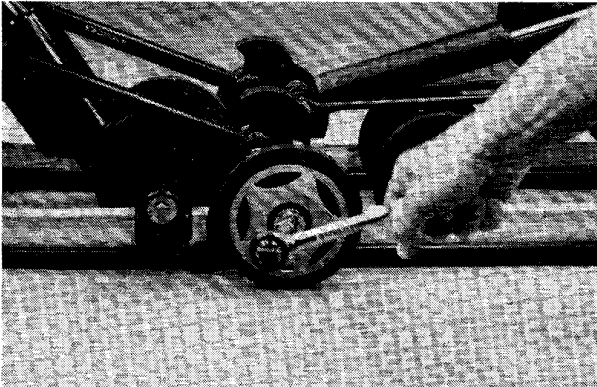
AG320

7



- Remove the cap screw and flat washer securing the outer idler wheel. Remove the outer idler wheel and account for two spacer washers.

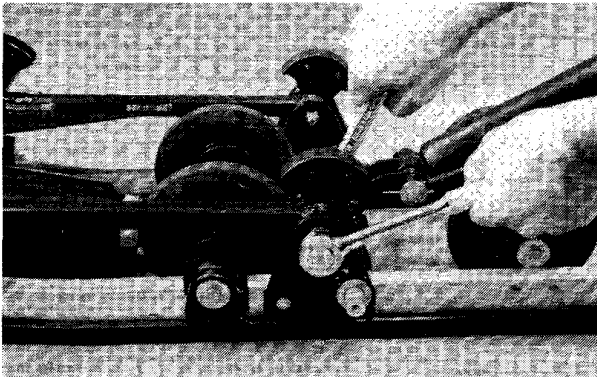
Fig. 7-46



AG321

- Slide the inner axles out of the front arm brackets; then remove the front shock bracket.
- Remove the cap screw and lock nut securing the front arm to the front arm bracket.

Fig. 7-47



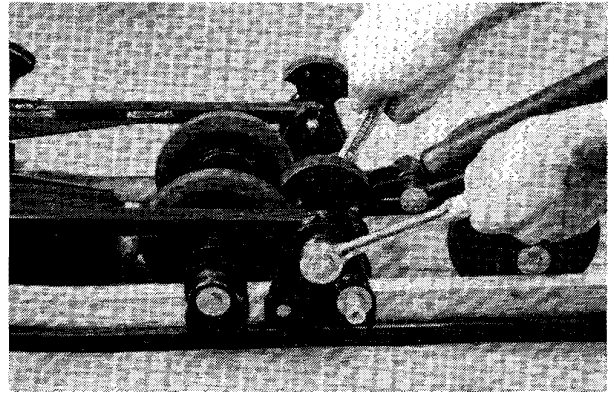
AG304

- Remove the two cap screws and lock nuts securing the front arm bracket to the slide rail; then slide the front arm bracket forward off the slide rail.

### Assembling

- Slide the front arm bracket on the slide rail. Install the two cap screws and lock nuts. Torque to 3.2 kg-m (23 ft-lb).
- Position the front arm into the front arm bracket. Install the cap screw and lock nut. Torque to 3.2 kg-m (23 ft-lb).

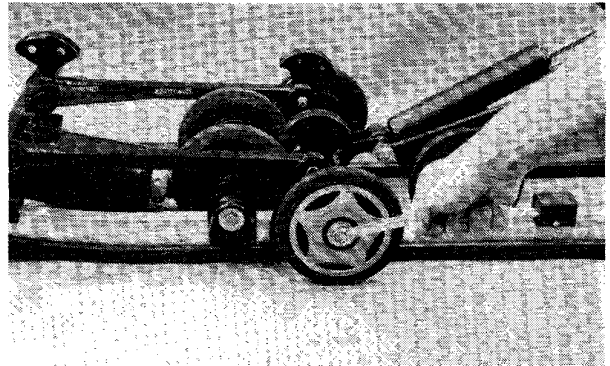
Fig. 7-48



AG304

- Align front shock bracket and rear shock pivot between the front arm brackets; then slide the inner axle through the brackets. Install the spacers and outer idler wheel on the inner axle and secure with a flat washer and cap screw.

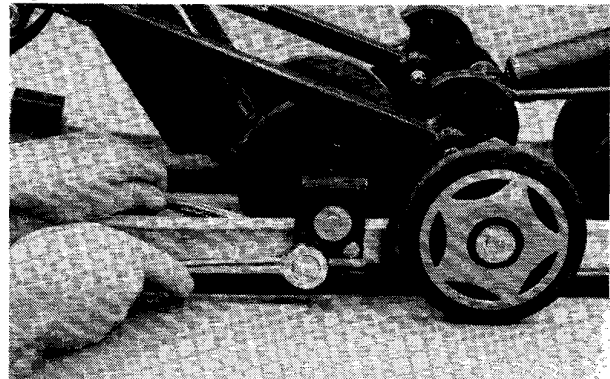
Fig. 7-49



AG322

- Slide the front idler wheel bracket onto the slide rail. Install the two cap screws and lock nuts securing the front idler wheel bracket to the slide rail. Torque to 3.2 kg-m (23 ft-lb).

Fig. 7-50

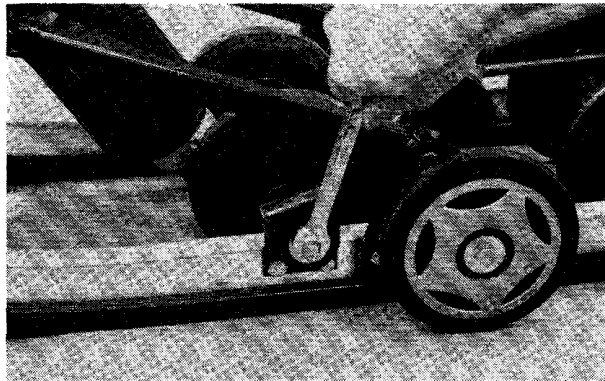


AG320



5. Place the front idler wheels and spacers into position and slide the inner wheel axle through the idler wheels and front shock bracket.
6. Install the rear spring slide block on the idler wheel axle and secure with a flat washer and cap screw. Tighten securely.

Fig. 7-51



AG319

7. Install the bushing into the lower shock eyelet and place the lower shock eyelet into the lower shock bracket. Install a cap screw and lock nut. Tighten securely.

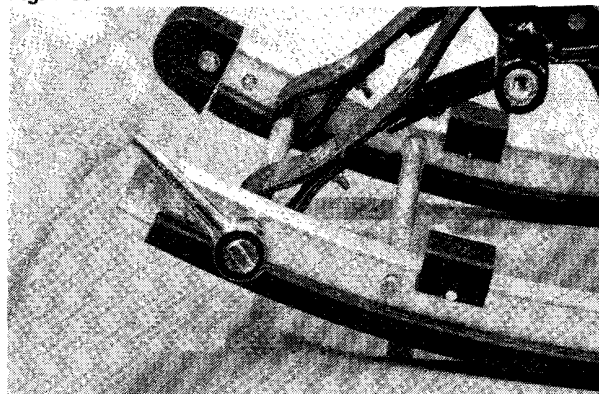
Fig. 7-52



AG317

8. Install the shock pad on the slide rail and secure with a push pin and a new push nut.
9. Install both front crossbrace tubes between the slide rails and secure with four cap screws. Torque to 3.2 kg-m (23 ft-lb).

Fig. 7-53

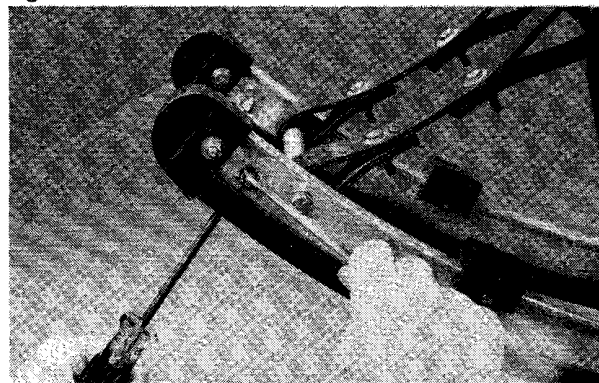


AG301

**NOTE:** Be sure to place the forward cross-brace tube through the limiter straps.

10. Install the lock nut securing the wear strip to the slide rail. Tighten securely.

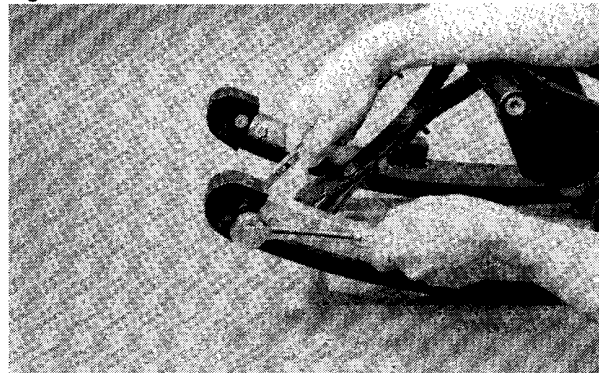
Fig. 7-54



AG298

11. Place the end cap onto the rail and secure with cap screw, washers, and lock nut.

Fig. 7-55



AG297

7

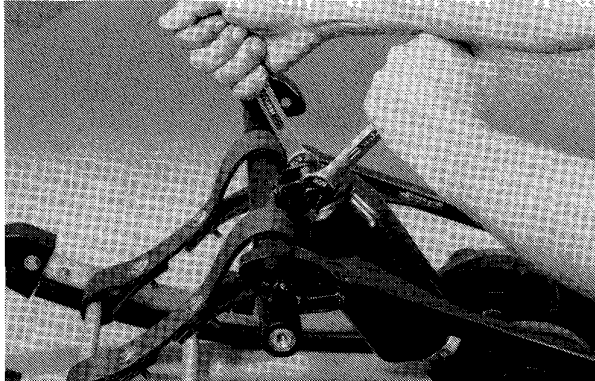


## FRONT SHOCK ABSORBER

### Removing

1. Remove the cap screw and lock nut securing the upper shock absorber eyelet to the front arm. Account for a bushing.

Fig. 7-56



AG306

2. Remove the cap screw and lock nut securing the lower shock eyelet to the front shock bracket. Remove the shock absorber and account for a bushing.

Fig. 7-57



AG317

3. Slide the rubber shock boot off the shock absorber.

### Inspecting

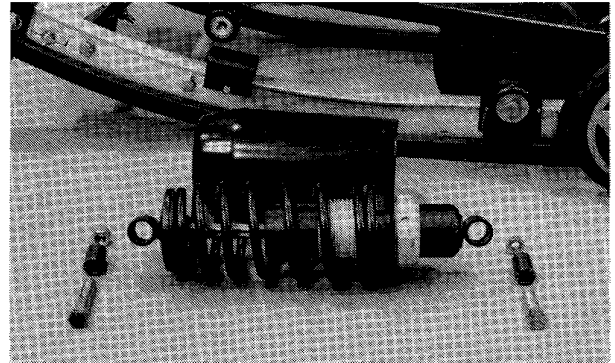
**NOTE:** Whenever a part is worn excessively, cracked, defective, or damaged in any way replacement is necessary.

1. Inspect the shock absorber for any signs of oil leakage, especially at the point where the shock ram enters the shock body.
2. Inspect the shock absorber eyelet welds (at each end) for any cracks or signs of separation.

### Installing

1. Apply a light coat of grease to both bushings and install the bushings into the shock absorber eyelets.

Fig. 7-58



AG318

2. Position the lower shock absorber eyelet into the crossbrace bracket and secure with a cap screw and lock nut. Torque to 3.2 kg-m (23 ft-lb).
3. Position the upper shock absorber eyelet into the front arm bracket and secure with a cap screw and lock nut. Torque to 3.2 kg-m (23 ft-lb).

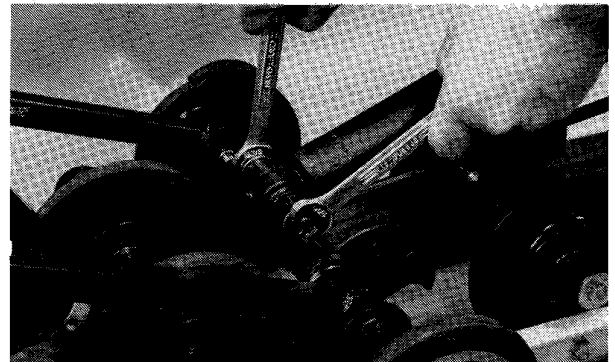
**NOTE:** Do not over-tighten the shock cap screws as the shock eyelet must be free to pivot.

## REAR SHOCK ABSORBER AND SHOCK RODS

### Removing

1. Remove the cap screw and lock nut securing the lower shock absorber eyelet and shock rods to the pivot tube bracket. Account for the two shock rod axles.

Fig. 7-59

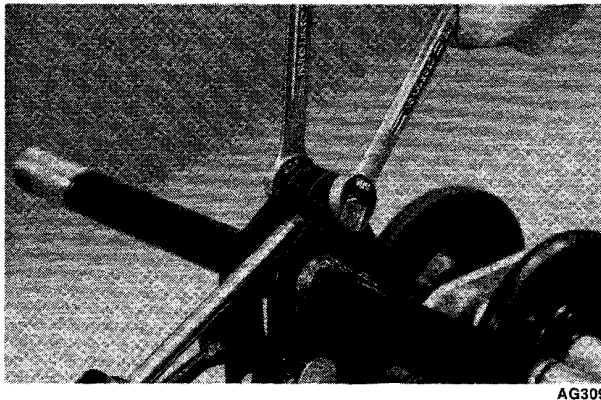


AG314



2. Remove the cap screw and lock nut securing the upper shock absorber eyelet to the rear arm bracket. Remove the shock absorber.

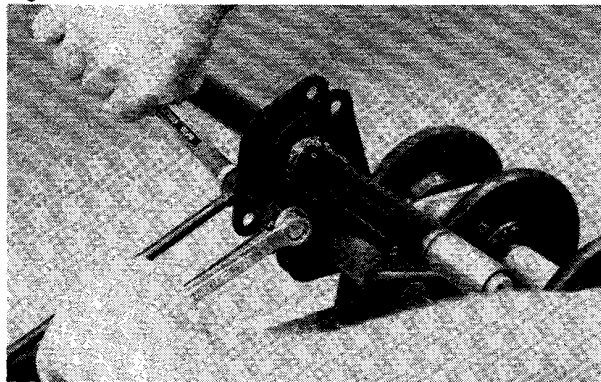
Fig. 7-60



AG309

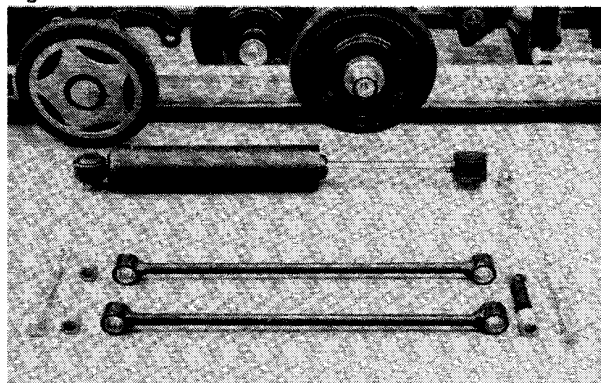
3. Remove the cap screw and lock nut securing the shock rods to the upper arm bracket. Account for the two shock rod axles and washers.

Fig. 7-61



AG310

Fig. 7-62



AG316

## Inspecting

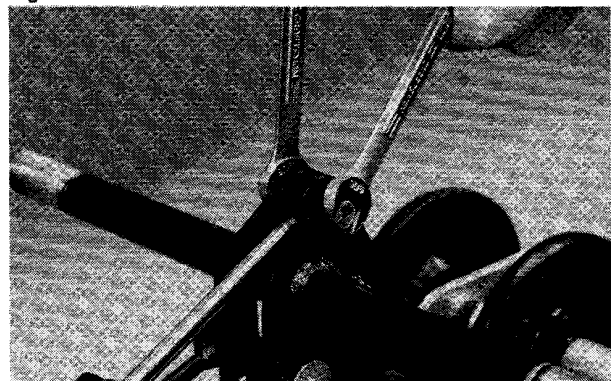
**NOTE:** Whenever a part is worn excessively, cracked, defective, or damaged in any way, replacement is necessary.

1. Inspect the shock absorber for any signs of oil leakage, especially at the point where the shock ram enters the shock body.
2. Inspect the rubber shock bushings located in the shock absorber eyelets for cracks or deterioration.
3. Inspect the shock absorber eyelet welds (at each end) for any cracks or signs of separation.
4. Examine the welds securing the eyelets of the shock rods for cracks or signs of separation. Either weld the eyelet or replace the shock rod assembly.
5. Examine the axle surfaces for any signs of corrosion. If corrosion is found, lightly buff the surface of the axle with #400 wet-or-dry sandpaper; then apply a light coat of grease.

## Installing

1. Apply a light coat of grease to the upper shock absorber eyelet axle; then install the axle. Position the eyelet into the upper arm bracket and secure with a cap screw and lock nut. Torque to 3.2 kg-m (23 ft-lb).

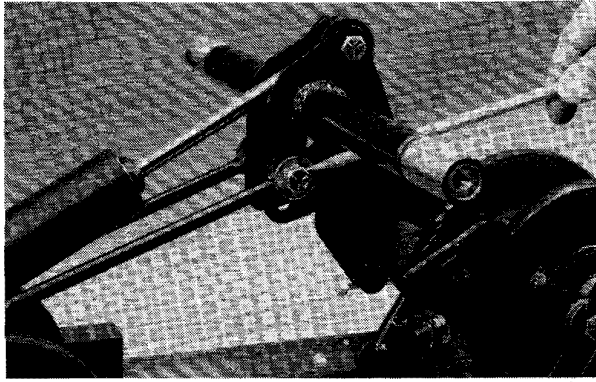
Fig. 7-63



AG309

2. Apply a light coat of grease to the outer surface of the shock rod axles and slide the axles into the shock rod eyelets.
3. Place the shock rod eyelets on each side of the upper arm bracket and place a spacer into the bracket ends. Secure shock rods and spacer to the upper arm bracket using a cap screw, washers (on the outside of each eyelet) and lock nut. Torque lock nut to 3.2 kg-m (23 ft-lb).

Fig. 7-64



AG313

- Place the lower shock absorber eyelet into the rear pivot bracket. Place the lower shock rod eyelet with bushings into position. Secure the lower shock rod eyelet and the shock absorber to the rear pivot bracket with a cap screw, two washers, and lock nut. Torque to 3.2 kg-m (23 ft-lb).

**NOTE:** When installing shock rods, the longest side of the shock rod eyelet must be positioned toward the shock absorber.

Fig. 7-65



AG314

## REAR SHOCK PIVOT

### Disassembling

- Remove the cap screw and lock nut securing the lower shock absorber eyelet and shock rods to the pivot tube bracket. Account for the two shock rod axles.

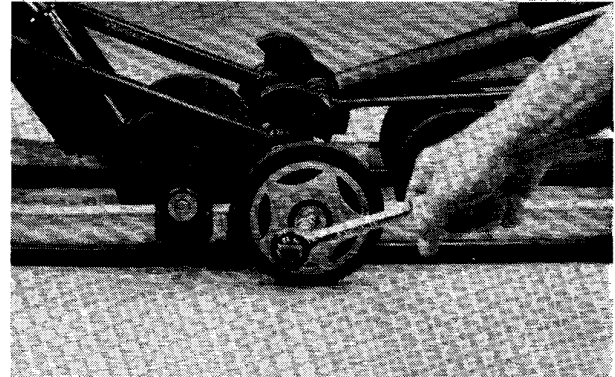
Fig. 7-66



AG314

- Remove cap screws and flat washer securing outer idler wheel. Remove the outer idler wheel and account for two spacer washers.

Fig. 7-67



AG321

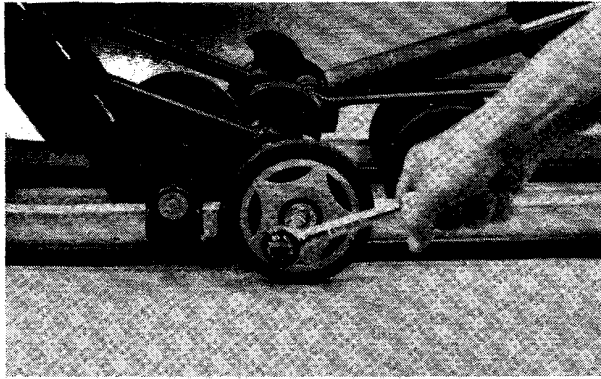
- Slide the inner axle out of the front arm bracket far enough to remove the rear shock pivot and account for spacer axle.

### Assembling

- Align the front shock bracket and rear shock pivot with the spacer installed between the front arm brackets; then slide the inner axle through the brackets. Install spacers and outer idler wheel on the inner axle and secure with a flat washer and cap screw.



Fig. 7-68



AG321

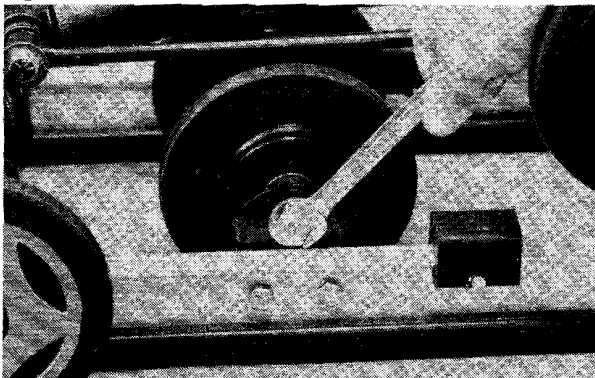
2. Place the lower shock absorber eyelet into the rear pivot bracket. Place the lower shock rod eyelets with bushings into position. Secure the lower shock rod eyelet and the shock absorber to the rear pivot bracket with cap screw, two washers, and lock nut. Torque to 3.2 kg-m (23 ft-lb).

## REAR INNER IDLER WHEELS

### Disassembling

1. Remove the cap screws and flat washer securing the idler wheels to the rear idler wheel brackets.

Fig. 7-69



AG327

2. Slide the inner axle out of the rear idler wheel brackets and remove the idler wheel. Account for the spacer axle and four washers.

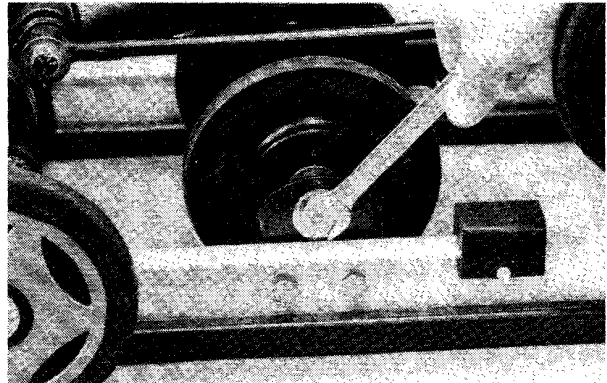
### Inspecting

1. Inspect each idler wheel and plastic hub for cracks or damage.
2. Rotate the idler wheel bearings (by hand) and check for binding or roughness.

## Assembling

1. Position the idler wheels with spacer and spacer washers (one on each side of the idler wheel) between the idler wheel brackets.
2. Slide the inner axle through the idler wheel brackets, idler wheels, spacers, and spacer washers. Secure with two flat washers and cap screws. Tighten securely.

Fig. 7-70



AG327

## SLIDE RAIL

### Removing

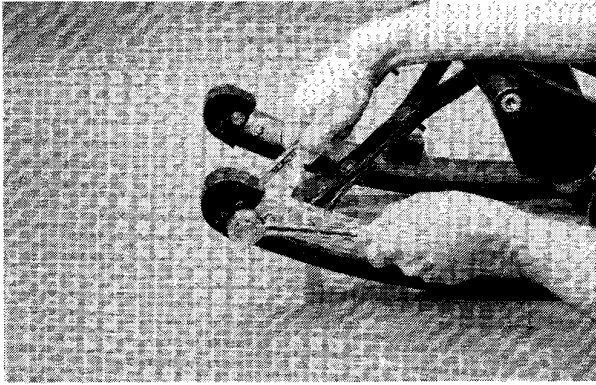
**NOTE:** When it is necessary to replace one or both slide rails, it is recommended that one slide rail be removed at a time. The remaining slide rail will then hold the crossbraces and brackets in their correct assembly order. This method is much quicker than to completely disassemble the entire skid frame. To replace either rail, use the following procedure:

1. Remove the cap screw, washer, and lock nut securing the end cap to the slide rail. Remove the end cap from the slide rail.

7



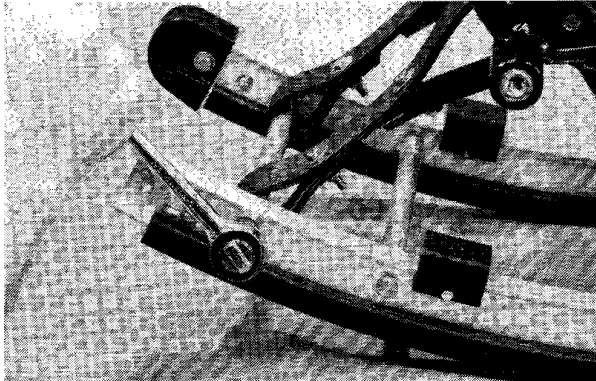
Fig. 7-71



AG297

2. Remove the four cap screws securing both front crossbrace tubes between the slide rails; then remove the crossbrace tubes.

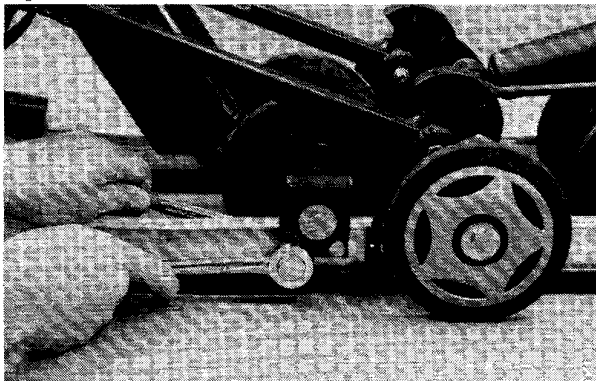
Fig. 7-72



AG301

3. Remove the push nuts and pins securing the shock pads and remove the shock pads.
4. Remove the two cap screws and lock nuts securing the center crossbrace to the slide rail being removed.

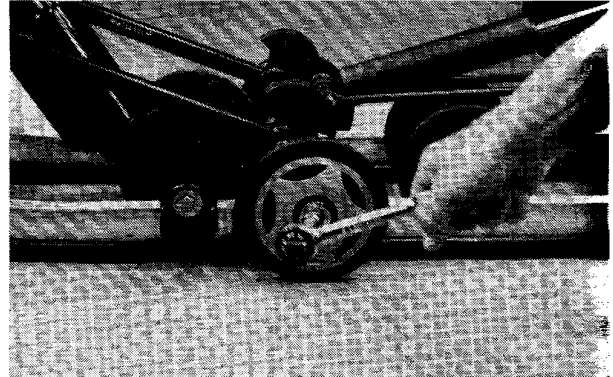
Fig. 7-73



AG320

5. Remove the cap screw and flat washer securing the outer idler wheel to the front arm crossbrace.

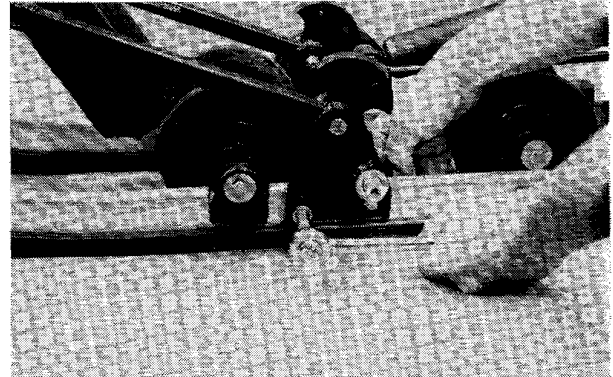
Fig. 7-74



AG321

6. Remove the two cap screws and lock nuts securing the front arm crossbrace to the slide rail.

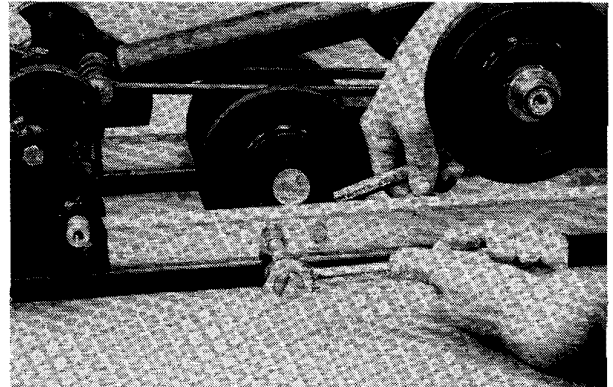
Fig. 7-75



AG323

7. Remove the two cap screws and lock nuts securing the rear idler wheel bracket to the rail.

Fig. 7-76

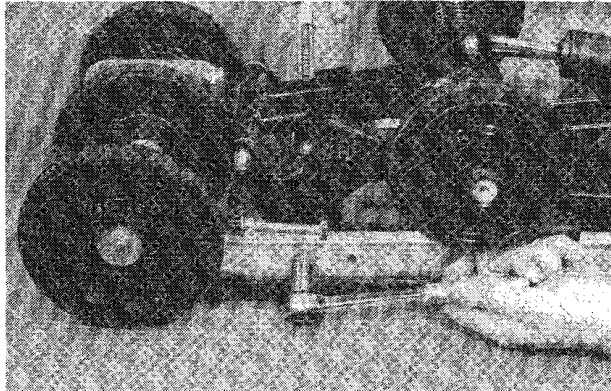


AG324



- Remove the long cap screw securing the lower rear arm assembly to the slide rails.

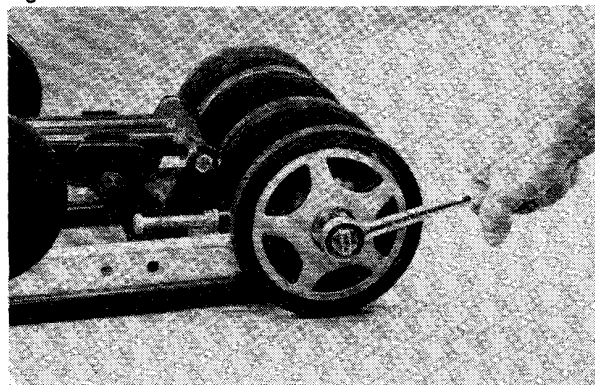
Fig. 7-77



AG332

- Remove the hub cap; then remove the cap screw securing the rear idler wheel to the shaft. Slide the idler wheel off the shaft.

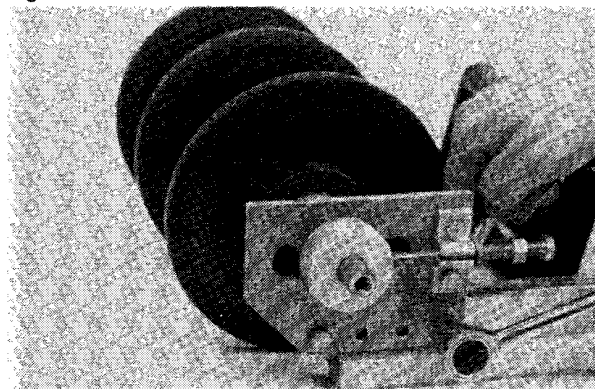
Fig. 7-78



AG325

- Remove the rear idler wheel bracket.

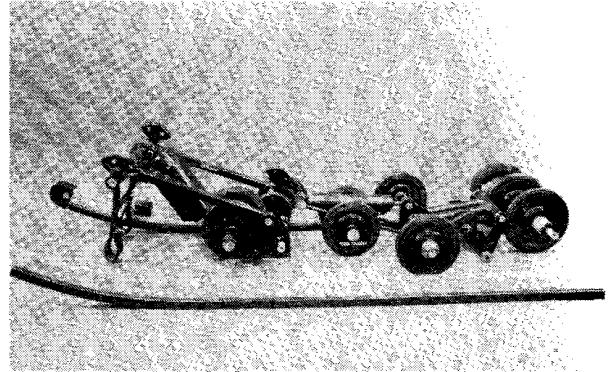
Fig. 7-79



AG120

- With all bracket hardware removed, pull the slide rail slowly forward and out of all brackets.

Fig. 7-80



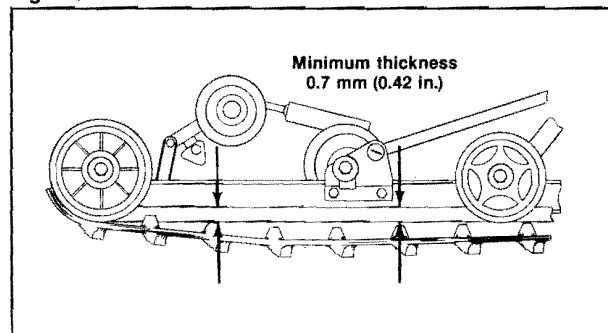
AG326

## Inspecting

**NOTE:** Whenever a part is worn excessively, cracked, defective, or damaged in any way, replacement is necessary.

- Inspect the slide rail for cracks or unusual bends.
- Inspect the wear strip for wear. The wear strip must be 10.7 mm (0.42 in.) thick or thicker. If the wear strip measurement is less than specified, replacement of both wear strips is necessary.

Fig. 7-81

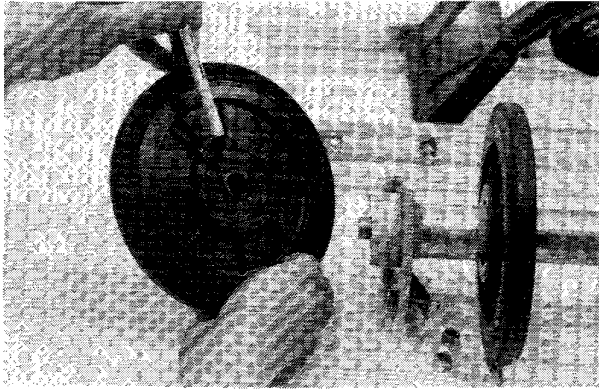


0727-726

## Installing

- Starting in front, place the back end of the slide rail into the first bracket and slowly work it back through all brackets. Install the cap screws and lock nuts securing the slide rail to the brackets. Torque all slide rail hardware to 3.2 kg-m (23 ft-lb).
- Install the rear idler wheel (with the large diameter insert positioned to the inside) and secure the rear idler wheel with a cap screw and large washer. Torque to 1.5 kg-m (11 ft-lb).

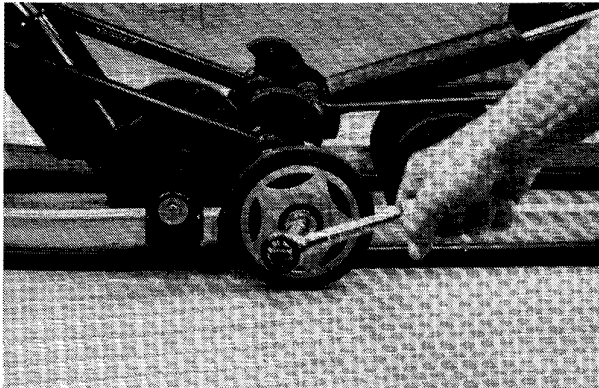
Fig. 7-82



AG123

3. Secure the lower rear arm assembly with the long cap screw. Torque to 3.2 kg-m (23 ft-lb).
4. Install the outer idler wheel on the front arm crossbrace. Secure with a cap screw and lock nut. Tighten securely.

Fig. 7-83

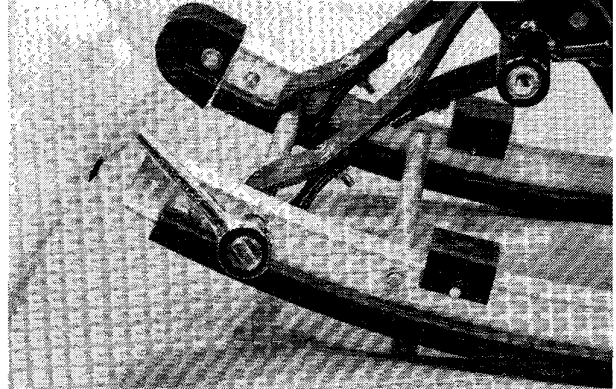


AG321

5. Place the shock pads into position and secure with pins and push nuts.
6. Install both front crossbrace tubes between the slide rails. Secure with four cap screws. Tighten securely.

**NOTE:** Be sure to place the forward crossbrace tube through the limiter straps.

Fig. 7-84



AG301

7. Place the end cap onto the rail and secure with the cap screw, washers, and lock nut.

## Installing Skid Frame

1. Place a piece of cardboard on the floor to protect against scratching and tip the snowmobile onto one side.
2. Pull the track away from the tunnel and spread open; then place the skid frame into the track making sure the track is positioned above the track deflectors located in the tunnel. Slide the inner axles through the upper and rear arms of the skid frame.
3. Position the front of the skid frame into the tunnel and align the front arm with the upper mounting hole in the tunnel. Slide the lock washer onto the cap screw; then secure the front arm to the tunnel with the cap screw and lock washer. Thread cap screw in only half way. **DO NOT TIGHTEN AT THIS TIME.**

**NOTE:** To aid in centering the front arm with the holes in the tunnel, position skid frame and track at a 45° angle to bottom of tunnel.

4. Slide the skid frame and track into the tunnel.
5. Tip the snowmobile onto the opposite side and install the remaining front arm cap screw and lock washer. Use the same procedure as step 3.



- Align the rear arm with the rear hole in the mounting bracket (see Fig. 7-85). Secure the rear arm with a cap screw and lock washer. **DO NOT TIGHTEN AT THIS TIME.**

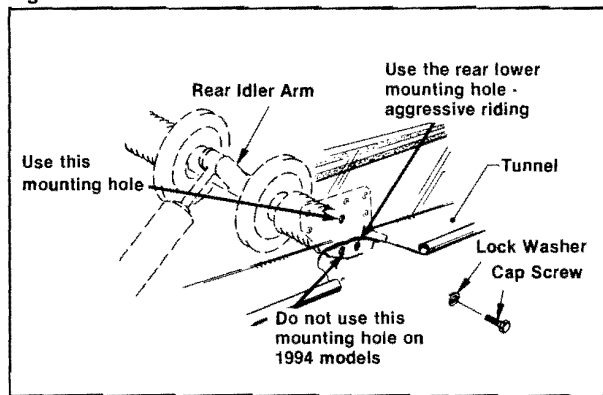
**WARNING**

Do not use the lower front mounting hole.

**NOTE:** Do not tighten any of the four cap screws until all have been started. To obtain proper alignment of the rear arm, pry the arm in the proper direction until alignment is obtained.

- Again tip the snowmobile onto the opposite side and install the remaining rear arm cap screw and lock washer. Follow the same procedure as in step 6.
- Tighten all four skid frame mounting cap screws to 3.2 kg-m (23 ft-lb).

Fig. 7-85



- Tighten the two track-tension adjustment bolts. Tighten evenly until track deflection is within specifications; then lock the jam nuts to secure the adjustment.

**NOTE:** The cap screws securing the rear idler wheels must be loosened when adjusting track tension. Be sure to tighten after making the adjustment.

- Check track tension and alignment (see Track Tension and Alignment sections).
- Adjust suspension.
- Install the battery and battery box. Secure with nuts, washers, and cap screws. Attach the positive battery cable, then the negative.

**CAUTION**

The positive cable must be connected first.

**Track Tension**

**WARNING**

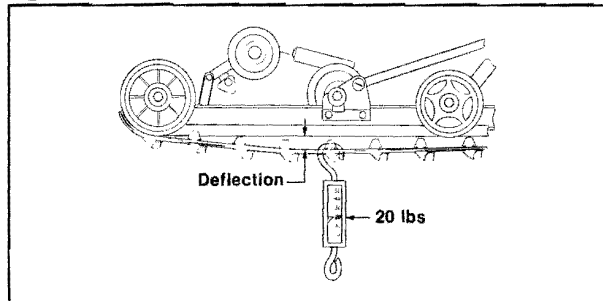
Shut engine off and make sure ignition switch key is in the OFF position.

- Using a shielded safety stand, raise the rear of the snowmobile off the floor.
- Using a scale to exert moderate pressure (9 kg or 20 lb), pull track down at mid-span and measure the distance between the bottom of the wear strip and the inside surface of the track. Track deflection must be within specifications.

**Track Tension**

mm	in.
13-19	1/2-3/4

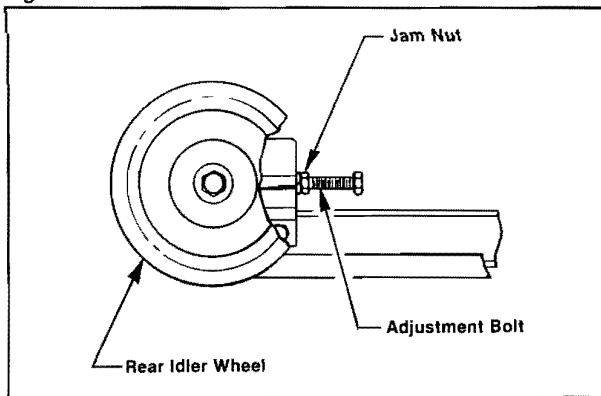
Fig. 7-86



**NOTE:** When the track is new, it will stretch slightly and take a "set" within the first 300 to 500 miles of operation.

- If measurement is not as specified, loosen the jam nuts of the adjustment bolts.

Fig. 7-87



4. If measurement obtained in step 2 is more than specified, tighten adjustment bolts. If measurement obtained is less than specified, loosen adjustment bolts. When measurement is within the specified range, lock adjustment by bottoming the jam nuts against the axle housings.

**NOTE:** Slide your hand along the inside of the tunnel and vigorously push the underside of the track up and down. Track must not hit top of tunnel or slap skid frame.

5. After correct track tension is obtained, check track alignment.

**NOTE:** Track tension and track alignment are interrelated; always check both even if only one adjustment seems necessary. Always establish correct track tension before checking and/or adjusting alignment.

## Track Alignment

Proper track alignment is when the rear idler wheels are equidistant from the inner drive lugs on the inside surface of the track.

1. Using a shielded safety stand, raise the rear of the snowmobile off the floor making sure the track is free to rotate.

## WARNING

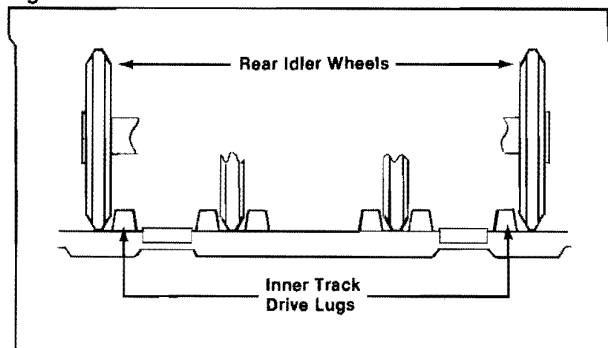
The tips of the skis must be positioned against a wall or similar object for safety.

2. Start the engine and accelerate slightly. Use only enough throttle to turn the track several revolutions. SHUT ENGINE OFF.

**NOTE:** Allow the track to coast to a stop. DO NOT apply the brake because it could produce inaccurate alignment conditions.

3. When the track stops rotating, check the relationship of the rear idler wheels and the inner track drive lugs. If the distance from the idler wheels to the inner drive lugs is the same on both sides, no adjustment is necessary.

Fig. 7-88



4. If the distance from the idler wheels to the inner drive lugs is not the same on both sides, proceed to step 5.
5. On the side of the track that has the inner drive lugs closer to the rear idler wheel, loosen the adjustment bolt jam nut; then rotate the adjustment bolt clockwise 1-1½ turns.
6. Check track alignment and make necessary adjustments until proper alignment is obtained.

**NOTE:** Make sure correct track tension is maintained after adjusting track alignment.

7. After proper track alignment is obtained, lock the adjustment bolt jam nut against the axle housing.
8. Field test the track under actual conditions.
9. After the field test, check track alignment and track tension; adjust if necessary.



## Adjusting Suspension

This suspension is fully adjustable and can be adjusted to meet most everyone's driving style. However, if not adjusted correctly, it can also be a very poorly-handling snowmobile.

The front ski shocks and springs have been matched to the rear suspension. If either of these components are changed, the rear suspension should also be changed to keep the suspension system in balance.

The front shocks and springs perform a couple of very important tasks. First, they keep the front end from bottoming out on harsh bumps and make the ride much more enjoyable under such conditions. They also affect the amount of ski pressure upon deceleration and handling in tight turns. Along with these important facts, the front springs also greatly affect weight transfer to the rear suspension. With heavy or stiff springs, more weight is transferred to the rear upon acceleration. With soft springs, less weight gets transferred.

The rear springs influence the load-carrying ability of the snowmobile and should be adjusted for the weight and riding preference of the operator.

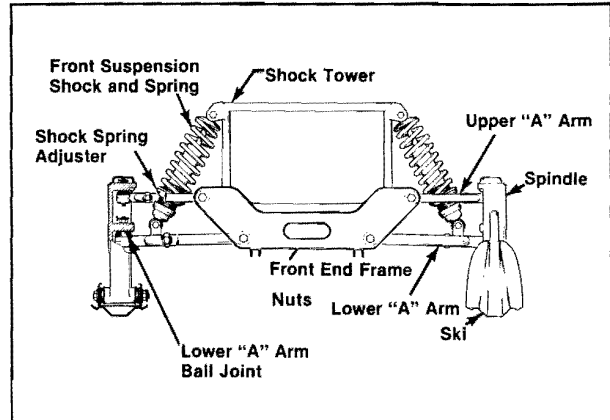
### ADJUSTING FRONT SHOCK SPRINGS

Although the front shock springs are individually adjustable for the terrain conditions and driving style of the operator, Arctco recommends that they be set so 19-25 mm (3/4-1 in.) of threads are exposed below the adjuster nut. Additional ski pressure can be obtained by tightening the spring tension; ski pressure can be decreased by relaxing spring tension.

To adjust spring tension, rotate the entire spring in whichever direction is desired. Equal adjustments should be maintained on both sides of the snowmobile. If, after adjusting spring tension you note the snowmobile front end wants to pitch, relax the spring tension on the side that is pitching. If both side are pitching, relax the spring tension on both sides.

**NOTE:** The adjuster nut will normally rotate with the spring.

Fig. 7-89



0728-709

### ADJUSTING SKID FRAME FRONT SHOCK

The skid frame front arm shock spring is adjustable. However, Arctco recommends that the shock spring be maintained as loose as possible. Tightening the skid frame front arm shock spring may ruin the handling features of the snowmobile.

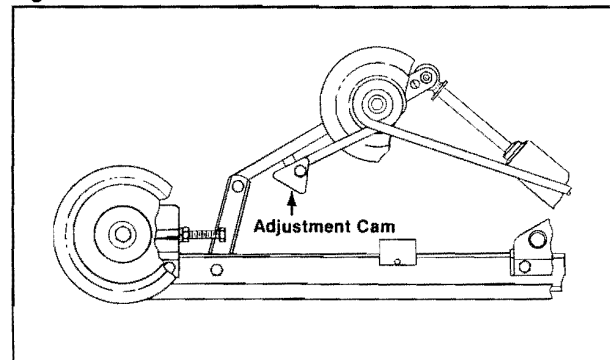
### ADJUSTING REAR SPRING TENSION

Rear spring tension adjustment is accomplished by rotating the adjusting cams. Position 3 provides the stiffest ride. Position 1 is for the light rider or slow-speed trail riding. Position 2 is for the average operator under normal conditions.

Block Position	Weight of Rider
1st	100-150 lbs
2nd	150-200 lbs
3rd	200 lbs and over

7

Fig. 7-90



0727-720

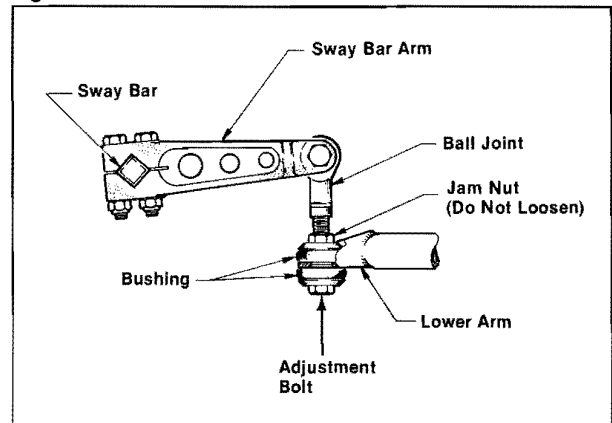
**NOTE:** To rotate an adjusting cam, use a spark plug wrench. Always rotate the cam toward the direction of the spring center.

Rotate the wrench until the cam is in the desired position. To stiffen the ride, rotate the cam to raise the spring end. Make the adjustment on the other cam and be sure both cams are adjusted equally.

## Adjusting Sway Bar Linkage

1. Place the rear of the snowmobile up on a jackstand and have the snowmobile sitting on a level surface.
2. Open the hood and place an angle finder on top of the front cross tube.
3. If the snowmobile is not level, adjust the sway bar linkage by rotating the adjustment bolt at the very bottom (located under the lower rubber bushing). Rotating the adjustment bolt clockwise will lower the side; rotating the adjustment bolt counterclockwise will raise the side.

Fig. 7-91



0728-208

**NOTE:** There is a jam nut located just above the upper rubber bushing on the sway bar linkage. **DO NOT LOOSEN THIS JAM NUT** as it has been adjusted at the factory. With the jam nut set, the rubber bushings work as a friction stop and will prevent the linkage from working loose.

The sway bar linkage length may vary from one side of the snowmobile to the other. This is not important, and should not cause any concern as long as the snowmobile is level.



# SECTION 8 - RECOIL STARTER

## TABLE OF CONTENTS

Removing . . . . .	190
Disassembling . . . . .	190
Inspecting . . . . .	191
Assembling . . . . .	191
Installing . . . . .	192

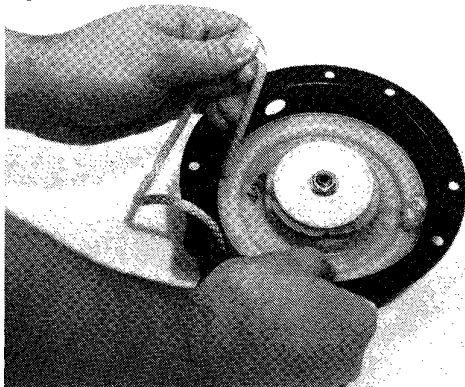
## Removing

1. Tie a slip knot in the recoil rope below the console, and allow the rope to slowly retract against the recoil case.
2. Remove the knot at the handle, remove the handle, and account for the recoil handle cap; then thread the rope through the recoil bushing in the console.
3. Remove the four cap screws and lock washers securing the recoil assembly to the magneto case; then remove the recoil.

## Disassembling

1. Secure the recoil in a vise.
2. Rotate the recoil roller counterclockwise until the notch of the roller is near the recoil rope guide in the case. Guide the rope into the notch and slowly allow the roller to retract until all recoil spring tension is released.

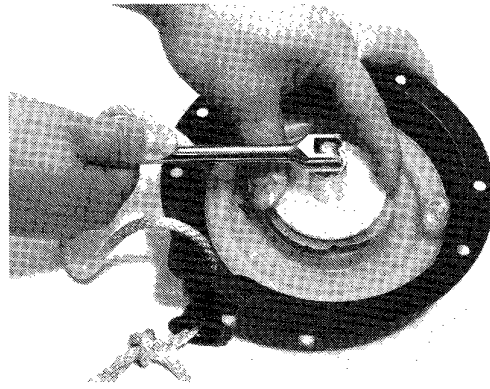
Fig. 8-1



B522

3. While exerting downward pressure on the drive plate, remove the nut and washer.

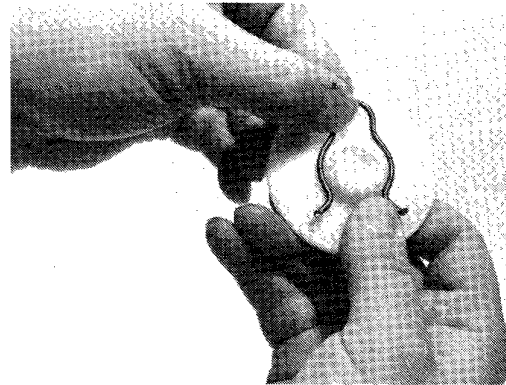
Fig. 8-2



B523

4. Slowly release the drive plate and lift the drive plate with spring clip free of the recoil roller.
5. Remove the spring clip from the drive plate.

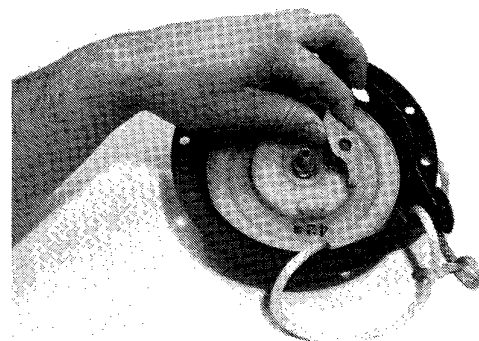
Fig. 8-3



B524

6. Remove the pawl; then remove the pawl spring.

Fig. 8-4



B525

7. Carefully lift the recoil free of the case making sure the recoil spring does not accidentally disengage from the recoil case.



- Remove the recoil spring from the recoil case by lifting the spring end up and out. Hold the remainder of the recoil spring with thumbs and alternately release each thumb to allow the recoil spring to gradually release from the recoil case.

**NOTE:** Do not remove the recoil spring unless replacement is necessary. It should be visually inspected in place to save time.

- Unwind the rope from the recoil roller, untie the knot, and remove the rope.

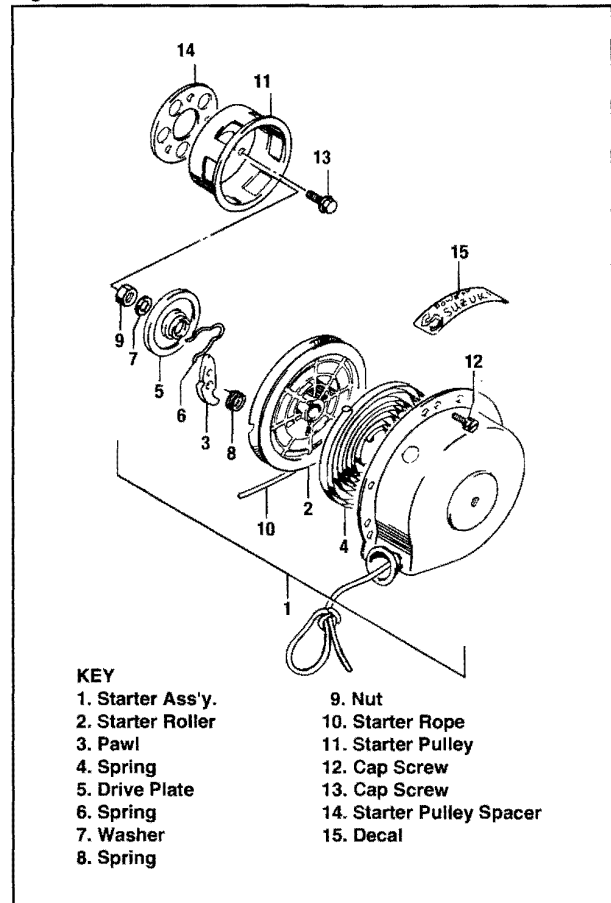
## Inspecting

**NOTE:** Whenever a part is worn excessively, cracked, defective or damaged in any way, replacement is necessary.

- Inspect all springs, washers, and pawl for wear or damage.
- Inspect the recoil roller and case for cracks or damage.
- Inspect the center hub for wear, cracks, or damage.
- Inspect the recoil rope for breaks or fraying.
- Inspect the recoil spring for cracks, crystallization, or abnormal bends.
- Inspect the handle for damage, cracks, or deterioration.

## Assembling

Fig. 8-5



0728-160

- Hook the end of the recoil spring around the mounting lug in the recoil case.
- Insert the recoil spring into the recoil case; then wind it in a counterclockwise direction until the complete recoil spring is installed.

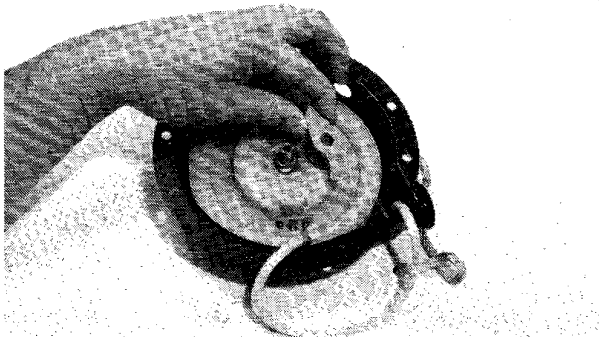
**NOTE:** The recoil spring must seat evenly in the recoil case.

- Insert the rope through the hole in the recoil roller and tie a knot in the end; then wrap the rope counterclockwise around the roller leaving approximately 50 cm (20 in.) of rope free of the roller.
- Apply low-temperature grease to the spring and hub.

8

5. Align the hook in the end of the recoil spring with the notch in the recoil roller.
6. Carefully slide the recoil over the hub and engage the spring with the roller.
7. Install the pawl spring making sure the end is properly installed in the hole in the recoil roller; then install the pawl making sure the pawl spring is properly preloaded.

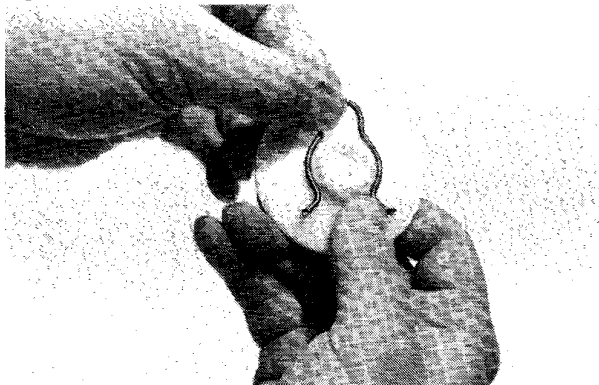
Fig. 8-6



B525

8. Slide the end of the recoil rope through the rope guide of the case; then tie a slip knot in the recoil rope.
9. Place the spring clip into position on the drive plate making sure the head of the clip is opposite the flat of the inner hole. Apply a low-temperature grease to the drive plate.

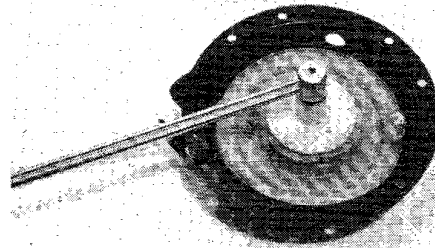
Fig. 8-7



B524

10. Place the drive plate into position making sure the flat of the inner hole is correctly positioned in the hub. Apply LOCTITE 242 to the threads; then secure the drive plate with a washer and nut. Tighten to 1.0 kg-m (7 ft-lb).

Fig. 8-8



B526

11. With 50 cm (20 in.) of rope exposed, hook the rope in the notch of the recoil roller.
12. Rotate the recoil roller four or five turns counterclockwise; then release the recoil rope from the notch and allow the rope to retract.
13. Pull the recoil rope out two or three times to check for correct tension.

**NOTE:** Increasing the rotations in step 12 will increase spring tension.

## Installing

1. Place the recoil assembly into position against the magneto case.
2. Secure the recoil with four cap screws and lock washers. Tighten to 0.7 kg-m (5 ft-lb).

**NOTE:** Before tightening the cap screws, slowly pull the recoil rope until the pawl engages; then tighten the cap screws. This will center the recoil on the magneto case.

3. Thread the recoil rope through the recoil bushing in the console; then install the handle and cap. Secure with a knot. Seat the cap.
4. Release the slipknot in the rope.



# SECTION 9 - AIDS FOR MAINTENANCE

## Table Of Contents

Special Tools . . . . .	194
General Bolt Torque Specifications . . . . .	195
Torque Conversions . . . . .	195
Torque Specifications . . . . .	196
Engine Torque Patterns . . . . .	197

## Special Tools

P/N	DESCRIPTION	P/N	DESCRIPTION
0133-043	Imprinter	0644-072	Spring Tool
0133-417	Imprinter Ink Roller	0644-076	Shielded Safety Stand
0144-003	Piston Pin Puller	0644-077	Gram Scale
0144-007	Flywheel Spanner Wrench	0644-079	Engine Stand
0144-109	Ramp Grinding Holder	0644-084	Water Pump Bearing & Seal Tool Kit
0144-112	Flywheel Puller	0644-086	Spider Removal Tool Handle
0144-124	Spring Mounting Bar	0644-087	Spider Removal Kit (Comet)
0144-302	Bearing Remover (Crankshaft)	0644-094	Carbide and Stud Spec Gauge
0144-304	Engine Compression Tester	0644-096	Clutch Puller - Comet (Short Bolt)
0144-306	Ignition Test Plug	0644-097	Angle Finder
0144-310	Flywheel Puller/Spanner Wrench	0644-098	Ball Joint Fork
0144-311	Rear Suspension Spring Tool (78 and Newer Suspensions)	0644-100	Clutch Puller Comet (Long Bolt)
0636-072	Mikuni Carburetor Tool Set	0644-110	Driven Clutch Puller
0638-167	Snowmobile Dolly	0644-121	Ball Hone (76 mm)
0644-001	Spider Repair Tool Kit	0644-122	Idle Wheel Puller
0644-003	Clutch Alignment Bar	0644-123	Comet Clutch Compressor Tool
0644-006	Arctic Clutch Bushing Tool	0644-131	Vacuum Pump Kit
0644-007	Oil Injection Usage Tool	0644-136	Comet Clutch Spanner Wrench
0644-010	Clutch Puller (Arctic)	0644-137	Arctco Drive Clutch Bushing Kit
0644-014	Track Stud Hole Drill	0644-138	1 <sup>7</sup> / <sub>16</sub> " Spider Jam Nut Socket
0644-016	Surface Plate	0644-139	Fan Holder
0644-018	Stud Runner 6 mm	0644-142	Gas Shock Holding Blocks
0644-019	Stud Runner 8 mm	0644-151	Nitrogen Regulator
0644-020	Stud Runner 10 mm	0644-158	Gas Shock Inflator Tool
0644-021	T Wrench	0644-167	Driven Clutch Bearing Driver
0644-022	V Blocks	0644-169	Gas Shock Piston Locator
0644-023	Carburetor Synchronizing Tool Adapters	0644-179	Flywheel Puller Insert
0644-035	Ball Hone (60-64 mm)	0644-181	EFI Diagnostic Harness
0644-036	Ball Hone (65-70 mm)	0644-188	EFI Chip Puller
0644-037	Ball Hone (72-74 mm)	0644-191	Fluke Model 73 Multimeter w/Case
0644-038	T-Nut Tool	0644-194	Track Clip Tool - Camoplast & Yokohama
0644-041	Cylinder Hone Set	0644-197	Timing Light
0644-042	Rigid Hone Stone Set (2.5-2.7 in.)	0644-202	Arctco EFI Analyzer
0644-043	Rigid Hone Stone Set (2.7-4.1 in.)	0644-203	Fuel Pressure Tester - EFI
0644-044	Alcohol Test Kit	0644-205	Arctco Drive Clutch Cover Bushing Removal and Installation Tool
0644-046	Ignition Analyzer	0644-206	Arctco Drive Clutch Movable Sheave Bushings Installation Tool
0644-052	Starter Assembly Tool	0644-207	Arctco Clutch Puller
0644-055	Pinion Shimming Tool	0686-069	Arctco Ignition Analyzer Test Harness*
0644-057	Shock Spring Removal Tool	0686-070	Arctco Ignition Analyzer Test Harness*
0644-058	Comet Clutch Holder	0686-071	Arctco Ignition Analyzer Test Harness*
0644-062	Carburetor Balancer Repair Kit	0686-085	Arctco Ignition Analyzer Test Harness*
0644-069	Carburetor Synchronizer		

\*Refer to the Special Tool Catalog for models this harness will test.



## General Bolt Torque Specifications

SIZE	SAE GRADE 2 ASSEMBLY TORQUE		SAE GRADE 5 ASSEMBLY TORQUE		SAE GRADE 8 ASSEMBLY TORQUE	
	DRY	LUB	DRY	LUB	DRY	LUB
8-32	19 in.-lb	14 in.-lb	30 in.-lb	22 in.-lb	41 in.-lb	31 in.-lb
8-36	20 in.-lb	15 in.-lb	31 in.-lb	23 in.-lb	43 in.-lb	32 in.-lb
10-24	27 in.-lb	21 in.-lb	43 in.-lb	32 in.-lb	60 in.-lb	45 in.-lb
10-32	31 in.-lb	23 in.-lb	49 in.-lb	36 in.-lb	68 in.-lb	51 in.-lb
1/4-20	66 in.-lb	50 in.-lb	8 ft-lb	75 in.-lb	9 ft-lb	10 ft-lb
1/4-28	76 in.-lb	56 in.-lb	10 ft-lb	86 in.-lb	14 ft-lb	12 ft-lb
5/16-18	11 ft-lb	8 ft-lb	17 ft-lb	13 ft-lb	25 ft-lb	18 ft-lb
5/16-24	12 ft-lb	9 ft-lb	19 ft-lb	14 ft-lb	28 ft-lb	20 ft-lb
3/8-16	20 ft-lb	15 ft-lb	30 ft-lb	23 ft-lb	45 ft-lb	33 ft-lb
3/8-24	23 ft-lb	17 ft-lb	35 ft-lb	25 ft-lb	50 ft-lb	35 ft-lb
7/16-14	32 ft-lb	24 ft-lb	50 ft-lb	35 ft-lb	70 ft-lb	55 ft-lb
7/16-20	36 ft-lb	27 ft-lb	55 ft-lb	40 ft-lb	80 ft-lb	60 ft-lb
1/2-13	50 ft-lb	35 ft-lb	75 ft-lb	55 ft-lb	110 ft-lb	80 ft-lb
1/2-20	55 ft-lb	40 ft-lb	90 ft-lb	65 ft-lb	120 ft-lb	90 ft-lb

NOTE: Lub indicates lubricants or plating on fasteners.

## Torque Conversions

kg-m x 7.235 = ft-lb  
ft-lb x 0.1383 = kg-m

ft-lb	kg-m	ft-lb	kg-m	ft-lb	kg-m	ft-lb	kg-m	ft-lb	kg-m
1	0.1	21	2.9	41	5.7	61	8.4	81	11.2
2	0.3	22	3.0	42	5.8	62	8.6	82	11.3
3	0.4	23	3.2	43	5.9	63	8.7	83	11.5
4	0.6	24	3.3	44	6.1	64	8.9	84	11.6
5	0.7	25	3.5	45	6.2	65	9.0	85	11.8
6	0.8	26	3.6	46	6.4	66	9.1	86	11.9
7	1.0	27	3.7	47	6.5	67	9.3	87	12.0
8	1.1	28	3.9	48	6.6	68	9.4	88	12.2
9	1.2	29	4.0	49	6.8	69	9.5	89	12.3
10	1.4	30	4.2	50	6.9	70	9.7	90	12.5
11	1.5	31	4.3	51	7.1	71	9.8	91	12.6
12	1.7	32	4.4	52	7.2	72	10.0	92	12.8
13	1.8	33	4.6	53	7.3	73	10.1	93	12.9
14	1.9	34	4.7	54	7.5	74	10.2	94	13.0
15	2.1	35	4.8	55	7.6	75	10.4	95	13.1
16	2.2	36	5.0	56	7.7	76	10.5	96	13.3
17	2.4	37	5.1	57	7.9	77	10.7	97	13.4
18	2.5	38	5.3	58	8.0	78	10.8	98	13.6
19	2.6	39	5.4	59	8.2	79	10.9	99	13.7
20	2.8	40	5.5	60	8.3	80	11.1	100	13.8

# Torque Specifications

ENGINE		
Cylinder Head	ft-lb kg-m	13-20 1.8-2.8
Cylinder Base 8 mm	ft-lb kg-m	13-20 1.8-2.8
Cylinder Base 10 mm	ft-lb kg-m	29-43 4.0-6.0
Crankcase 6 mm	ft-lb kg-m	6-8.5 0.8-1.2
Crankcase 8 mm	ft-lb kg-m	13-20 1.8-2.8
Crankcase 10 mm	ft-lb kg-m	29-43 4.0-6.0
Exhaust Manifold	ft-lb kg-m	13-16 1.8-2.2
Intake Flange	ft-lb kg-m	13-16 1.8-2.2
Intake Manifold	ft-lb kg-m	13-20 1.8-2.8
Magneto Case	ft-lb kg-m	13-16 1.8-2.2
Flywheel	ft-lb kg-m	50.5-65 7.0-9.0
Engine Mounting	ft-lb kg-m	50-55 6.9-7.6
Mounts	ft-lb kg-m	20-25 2.8-3.5
Spark Plug	ft-lb kg-m	18-20 2.5-2.8

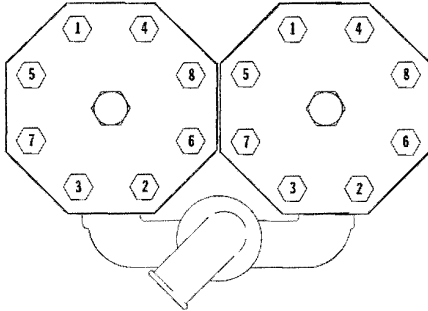
DRIVE		
Drive Clutch	ft-lb kg-m	50.55 7.6-6.9
Spider	ft-lb kg-m	250 34.5
Drive Clutch Cover Plate	ft-lb kg-m	7 1.0
Retainer Plug	ft-lb kg-m	50-55 6.9-7.6
Driven Pulley Retainer	ft-lb kg-m	11-13 1.5-1.8
Driven Pulley	ft-lb kg-m	19-24 2.6-3.3

CHASSIS		
Ski	ft-lb kg-m	70 9.7
Skid Frame Mounting	ft-lb kg-m	23 3.2
Skid Frame Crossbraces	ft-lb kg-m	17 2.4
Idler Wheels	ft-lb kg-m	17 2.4
Idler Wheel Brackets	ft-lb kg-m	17 2.4
Skid Frame Arms	ft-lb kg-m	30 4.2
End Caps	ft-lb kg-m	8 1.1
Chain Case Sprockets	ft-lb kg-m	19-24 2.6-3.3
Handlebar Block	ft-lb kg-m	10 1.4
Tie Rods	ft-lb kg-m	25 3.5
Sway Bar	ft-lb kg-m	13 1.8



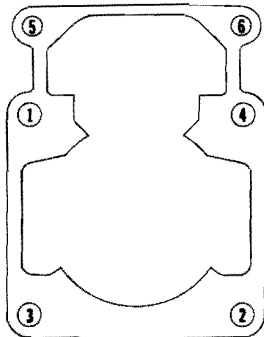
# Engine Torque Patterns

## CYLINDER HEAD



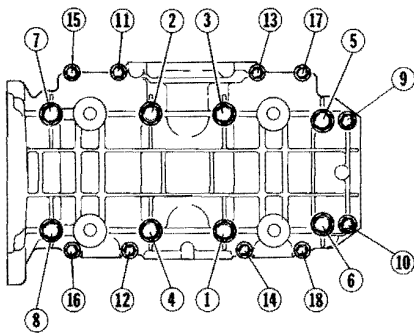
0727-158

## CYLINDER BASE



0726-551

## CRANKCASE



0727-491

# SECTION 10 - TROUBLESHOOTING

## TABLE OF CONTENTS

10

Engine . . . . .	200
Fuel System . . . . .	204
Drive Clutch/Driven Pulley . . . . .	204
Drive Belt . . . . .	206
Track . . . . .	207
Light System . . . . .	207



# Engine

## Problem: Engine Does Not Start (No Spark At Spark Plugs)

Condition	Remedy
1. Discharged <b>battery</b>	1. Check battery condition — charge or replace if necessary
2. Brown <b>fuse link wire</b> blown	2. Replace fuse link
3. <b>EFI relay</b> defective	3. Replace relay
4. <b>Ignition switch</b> malfunctioning — switch not in RUN position	4. Replace ignition switch — turn switch to RUN position
5. <b>Wiring harness</b> shorting — disconnected	5. Repair — replace — connect wiring harness
6. <b>Emergency stop switch</b> in DOWN position — switch malfunctioning	6. Move switch to UP position — replace throttle switch
7. <b>Throttle/ignition monitor switch</b> malfunctioning	7. Adjust throttle cable tension — replace throttle body assembly
8. <b>Tether switch</b> disconnected — defective	8. Connect — replace tether switch
9. <b>Spark plugs</b> fouled — damaged	9. Clean — replace spark plugs
10. <b>Spark-plug caps</b> damaged — leaking — shorting	10. Replace spark-plug caps
11. <b>High tension wires/coil</b> loose — grounded — defective	11. Service — replace high tension wires/coil
12. <b>CDI unit</b> defective	12. Replace CDI unit
13. <b>Charge coil</b> defective	13. Replace charge coil
14. <b>RPM sensor</b> defective	14. Replace RPM sensor
15. <b>Throttle position sensor</b> defective	15. Replace position sensor
16. <b>ECU</b> defective	16. Replace ECU

## Problem: Engine Does Not Start (No Fuel At Cylinders)

Condition	Remedy
1. <b>Gas tank</b> empty	1. Fill tank
2. Low or discharged <b>battery</b>	2. Charge — replace battery
3. Brown <b>fuse link wire</b> blown	3. Replace fuse link
4. Brown <b>ECU relay</b> defective	4. Replace relay
5. Green <b>fuse link wire</b> blown	5. Replace fuse link
6. Blue <b>fuel pump relay</b> defective	6. Replace blue relay
7. <b>Injector dropping resistor</b> defective	7. Replace dropping resistor
8. <b>Fuel pressure regulator</b> defective	8. Replace regulator — hose
9. Water in <b>fuel tank</b>	9. Replace fuel
10. <b>Fuel pump</b> defective	10. Service — replace fuel pump — connections — wires

**Problem: Engine Does Not Start (No Fuel At Cylinders) (Cont.)**

Condition	Remedy
11. <b>Fuel hose</b> broken — pinched	11. Replace — service hose
12. <b>Gas-tank vent</b> — hose obstructed	12. Remove obstruction — replace vent — hose
13. <b>Pick-up valve(s)</b> obstructed — damaged	13. Remove obstruction — replace pick-up valve(s)
14. Primary <b>compression</b> absent	14. Repair — replace damaged — worn engine components

**Problem: Engine Does Not Start (Fuel Does Not Ignite)**

Condition	Remedy
1. Check <b>ECU L.E.D.</b> for trouble code	1. Service — replace problem area
2. No <b>spark</b>	2. Check for spark — see condition "no spark"
3. Primary <b>compression</b> low	3. Service engine
4. Secondary <b>compression</b> low	4. Service engine
5. Engine <b>flooded</b>	5. Clear engine
6. <b>Gasoline</b> contaminated	6. Clean tank and entire fuel system

**Problem: Engine Does Not Idle**

Condition	Remedy
1. Check <b>ECU L.E.D.</b> for trouble code	1. Service — replace problem area
2. <b>Battery</b> voltage low	2. Charge — replace battery
3. <b>Injector(s)</b> defective	3. Replace injector(s)
4. <b>Fuel pressure regulator</b> defective	4. Replace regulator — hose
5. <b>Air silencer</b> obstructed	5. Clean air intake

**Problem: Engine Loses Power**

Condition	Remedy
1. <b>Battery</b> voltage low	1. Charge — replace battery
2. Bad <b>sensor</b> — check L.E.D. for trouble code	2. Repair — replace problem circuit or sensor
3. <b>Spark plug</b> fouled	3. Replace spark plugs
4. <b>External coil</b> defective	4. Service — replace coil
5. <b>Gas tank vent</b> — hose obstructed	5. Service — replace vent hose
6. <b>Charge coil</b> defective	6. Replace coil
7. <b>Tether switch</b> defective	7. Replace tether switch
8. Secondary <b>compression</b> low	8. Service engine
9. <b>CDI unit</b> defective	9. Replace CDI unit
10. <b>Fuel pressure regulator</b> defective	10. Replace regulator
11. <b>Pick-up valve(s)</b> obstructed	11. Replace pick-up valve(s)
12. <b>Oil-injection pump</b> malfunctioning — adjusted incorrectly	12. Replace — bleed — adjust oil-injection pump



**Problem: Engine Overheats**

Condition	Remedy
1. <b>Spark plug</b> heat range too hot	1. Install lower heat-range spark plugs
2. <b>Coolant</b> low — absent	2. Add coolant
3. <b>Heat exchanger</b> obstructed	3. Remove obstruction
4. Intake flange to cylinder <b>air leak</b>	4. Replace — seal intake flange(s)
5. <b>Drive system</b> (drive clutch — driven pulley — track — drive belt) adjusted incorrectly — worn — damaged	5. Troubleshoot — adjust drive system
6. <b>Rings/grooves</b> carboned	6. Clean — replace rings — pistons
7. <b>Exhaust ports</b> obstructed	7. Remove obstruction
8. <b>Muffler</b> obstructed	8. Remove obstruction
9. <b>Oil-injection pump</b> malfunctioning — adjusted incorrectly	9. Replace — bleed — adjust oil-injection pump
10. Primary <b>compression</b> low — absent	10. Repair — replace damaged — worn engine components
11. <b>Gasoline</b> octane too low	11. Use 87 minimum octane gasoline
12. <b>Water pump</b> — <b>thermostat</b> damaged — defective	12. Replace water pump — thermostat

**Problem: Engine Backfires**

Condition	Remedy
1. Check <b>L.E.D.</b> for trouble code	1. Repair problem area indicated
2. <b>Throttle/ignition monitor switch</b> adjusted incorrectly	2. Adjust throttle cable tension — service spring
3. <b>Spark plugs</b> fouled — damaged	3. Clean — replace spark plugs
4. <b>Spark plug</b> heat range too hot	4. Install lower heat-range spark plugs
5. <b>High tension wires/coil</b> shorting	5. Service — replace high tension wires/coil
6. <b>CDI</b> unit	6. Replace CDI unit
7. <b>Fuel</b> mixture lean	7. Repair fuel regulator — injector(s)
8. <b>Oil-injection pump</b> malfunctioning — adjusted incorrectly	8. Replace — bleed — adjust oil-injection pump
9. <b>Tether switch</b> defective	9. Replace tether switch

**Problem: Engine Four-Cycles (Floods Excessively)**

Condition	Remedy
1. Check <b>L.E.D.</b> for trouble code	1. Repair problem area indicated
2. <b>Fuel pressure</b> too high	2. Replace regulator — hose
3. <b>Injector</b> defective	3. Replace injector
4. <b>ECU</b> defective	4. Replace ECU
5. <b>Air intake silencer</b> obstructed	5. Remove obstruction

**Problem: Engine Stops Suddenly**

<b>Condition</b>	<b>Remedy</b>
1. No <b>fuel</b>	1. Fill tank
2. No <b>spark</b>	2. See section on "No Spark"
3. Check <b>L.E.D.</b> for trouble code	3. Repair problem area indicated
4. Low — discharged <b>battery</b>	4. Charge — replace battery
5. Brown <b>fuse link</b> blown	5. Replace brown fuse link
6. Brown <b>ECU relay</b> defective	6. Replace relay
7. <b>Wiring harness</b> connection loose	7. Service — tighten wiring harness connectors
8. <b>Fuel filter(s)</b> obstructed	8. Replace filter(s)
9. <b>Fuel pressure</b> low	9. Replace regulator — hose
10. <b>Fuel pump</b> not operating	10. Service — replace fuel pump
11. Green <b>fuse link</b> blown	11. Replace fuse link
12. Blue <b>fuel pump relay</b> defective	12. Replace relay
13. <b>Gas tank vent line</b> obstructed	13. Service vent hose
14. <b>ECU</b> defective	14. Replace ECU
15. <b>Fuel hose</b> obstructed — broken — pinched	15. Remove obstruction — repair — replace fuel hose
16. <b>CDI unit</b> defective	16. Replace CDI unit
17. <b>Ignition coil</b> defective	17. Replace ignition coil
18. <b>Charge coil</b> defective	18. Replace charge coil
19. <b>Tether switch</b> defective	19. Replace tether switch
20. <b>Gas-tank vent — hose</b> obstructed — damaged	20. Remove obstruction — replace vent — hose
21. <b>Engine</b> seized	21. Overhaul engine
22. <b>Throttle/ignition monitor switch</b> defective — <b>throttle cable</b> adjusted incorrectly	22. Replace throttle control — adjust throttle cable

**Problem: Engine Fails To Stop (Continues To Run, Even With All Switches Turned Off)**

<b>Condition</b>	<b>Remedy</b>
1. <b>CDI unit</b> shorted to ground	1. Replace CDI unit
2. Engine <b>wiring harness plug</b> wet	2. Disconnect and clean both plugs



## Fuel System

Problem: Too Rich	
Condition	Remedy
1. Check <b>L.E.D.</b> for trouble code	1. Replace problem sensor
2. <b>Fuel pressure</b> too high	2. Replace regulator
3. <b>Fuel return hose</b> obstructed	3. Service — replace hose — remove obstruction
4. <b>Injectors</b> leaking	4. Replace injectors
5. <b>ECU</b> defective	5. Replace ECU
Problem: Too Lean	
Condition	Remedy
1. Check <b>L.E.D.</b> for trouble code	1. Replace problem sensor
2. <b>Fuel pressure</b> too low	2. Replace regulator
3. <b>Vent line</b> obstructed	3. Remove obstruction
4. <b>Fuel filter(s)</b> obstructed	4. Replace fuel filter(s)
5. <b>ECU</b> defective	5. Replace ECU

## Drive Clutch/ Driven Pulley

Problem: Drive Clutch Engagement (Before Specified RPM)	
Condition	Remedy
1. <b>Spring</b> weak — broken	1. Replace spring
2. <b>Cam arm(s)</b> incorrect — worn	2. Replace cam arms
Problem: Drive Clutch Engagement (After Specified RPM)	
Condition	Remedy
1. <b>Spring</b> incorrect	1. Replace spring
2. <b>Guide buttons</b> worn	2. Replace guide buttons
Problem: Drive Clutch Sticks	
Condition	Remedy
1. Drive clutch <b>component</b> dirty	1. Clean drive clutch components
2. <b>Movable sheave</b> bent — binding	2. Clean — replace movable sheave
3. <b>Guide buttons</b> worn	3. Replace guide buttons

**Problem: Jerks — Shifts Erratically**

Condition	Remedy
1. Drive clutch <b>dirty</b>	1. Clean — repair drive clutch
2. <b>Rollers</b> worn	2. Replace rollers
3. <b>Cam arms</b> rough	3. Polish — replace cam arms
4. <b>Guide buttons</b> worn	4. Replace guide buttons
5. <b>Sheaves</b> dirty	5. Clean sheaves

**Problem: Engine Bogs At Engagement**

Condition	Remedy
1. <b>Belt</b> worn thin — stretched	1. Remove shim(s) from between driven sheaves — replace belt
2. <b>Center-to-center</b> incorrect	2. Tighten torque link — remove shim(s) from between driven sheaves
3. <b>Driven clutch</b> too wide	3. Remove shim(s) from between sheaves
4. Incorrect <b>cam arm</b> for altitude	4. Install correct high altitude kit

**Problem: Midrange Shift-up (Too Quickly - Lowers RPM)**

Condition	Remedy
1. <b>Drive clutch spring</b> weak	1. Replace drive clutch spring
2. <b>Driven pulley spring</b> weak	2. Replace driven pulley spring
3. <b>Spring preload</b> tension inadequate	3. Increase spring preload tension
4. <b>Center-to-center</b> distance too close	4. Adjust center-to-center distance
5. <b>Driven pulley bushing (bearing)</b> worn — damaged	5. Replace movable sheave

**Problem: Midrange Shift-up (Too Slowly - Raises RPM)**

Condition	Remedy
1. Drive clutch components <b>dirty</b>	1. Clean drive clutch components
2. Driven pulley components <b>dirty</b>	2. Clean driven pulley components
3. <b>Spring preload</b> tension excessive	3. Decrease spring preload tension
4. <b>Shoe-ramp slides</b> worn excessively	4. Replace shoe-ramp slides
5. <b>Driven pulley bushing (bearing)</b> worn — damaged	5. Replace movable sheave

**Problem: Excessive Belt Deposits**

Condition	Remedy
1. <b>Offset</b> adjusted incorrectly	1. Adjust offset
2. <b>Drive clutch/driven pulley sheaves</b> rough — damaged — dirty	2. Repair — replace — clean drive clutch/driven pulley sheaves
3. <b>Driven pulley movable sheave</b> travel impaired	3. Service driven pulley
4. <b>Driven pulley bushing (bearing)</b> worn — dirty	4. Clean bushing — replace movable sheave



**Problem: Excessive Belt Drag — Impaired Drive Clutch Disengagement**

Condition	Remedy
<ol style="list-style-type: none"> <li>1. Drive clutch components <b>dirty</b> — damaged</li> <li>2. <b>Drive belt</b> does not meet measurement specifications</li> </ol>	<ol style="list-style-type: none"> <li>1. Clean — replace drive clutch components</li> <li>2. Replace drive belt</li> </ol>

**Problem: Driven Pulley Vibrates**

Condition	Remedy
<ol style="list-style-type: none"> <li>1. <b>Sheave rivets</b> loose — broken</li> <li>2. <b>Driven pulley</b> out of balance</li> </ol>	<ol style="list-style-type: none"> <li>1. Replace sheave</li> <li>2. Service — replace driven pulley</li> </ol>

## Drive Belt

**Problem: Drive Belt Glazed**

Condition	Remedy
<ol style="list-style-type: none"> <li>1. Drive belt does not meet <b>measurement specifications</b></li> <li>2. <b>Drive clutch spring</b> tension inadequate</li> <li>3. Drive clutch components <b>dirty</b> — damaged</li> <li>4. <b>Offset — parallelism — center-to-center</b> distance adjusted incorrectly</li> </ol>	<ol style="list-style-type: none"> <li>1. Replace drive belt</li> <li>2. Replace drive clutch spring</li> <li>3. Clean — replace drive clutch</li> <li>4. Adjust offset — parallelism — center-to-center distance</li> </ol>

**Problem: Drive Belt Lugs Torn Off — Frayed — Worn in One Spot**

Condition	Remedy
<ol style="list-style-type: none"> <li>1. Drive belt does not meet <b>measurement specifications</b></li> <li>2. <b>Offset — parallelism — center-to-center</b> distance adjusted incorrectly</li> <li>3. <b>Drive clutch engagement — idle RPM</b> too high</li> <li>4. Drive clutch components <b>dirty</b> — damaged</li> <li>5. <b>Driven pulley/shaft</b> rotation impaired</li> </ol>	<ol style="list-style-type: none"> <li>1. Replace drive belt</li> <li>2. Adjust offset — parallelism — center-to-center distance</li> <li>3. Service drive clutch — reduce idle RPM</li> <li>4. Clean — replace drive clutch components</li> <li>5. Service driven pulley/shaft chain-case components</li> </ol>

## Track

Problem: Track Edge Frayed — Drive Lugs Worn	
Condition	Remedy
1. <b>Track alignment</b> adjusted incorrectly	1. Align — replace track
Problem: Track Worn Adjacent To Outer Drive Lugs	
Condition	Remedy
1. <b>Track tension</b> adjusted incorrectly	1. Adjust track tension
2. <b>Rear idler wheels</b> dirty — damaged	2. Clean — replace idler wheels
Problem: Track Ratchets — Slaps Tunnel	
Condition	Remedy
1. <b>Track tension</b> adjusted incorrectly (too loose)	1. Adjust track tension
2. <b>Drive sprockets</b> misaligned — damaged	2. Align — replace sprockets
Problem: Wear-Strip Wear Excessive	
Condition	Remedy
1. <b>Slide rail</b> bent — broken — damaged	1. Repair — replace slide rail
2. <b>Track alignment</b> adjusted incorrectly	2. Adjust track alignment

## Light System

Problem: Bulbs Burn Out Repeatedly	
Condition	Remedy
1. <b>Voltage regulator</b> malfunctioning — damaged — defective — not connected	1. Replace — connect regulator
Problem: Complete Lighting System Failure	
Condition	Remedy
1. <b>Wiring harness</b> connectors disconnected — damaged	1. Connect — replace harness — connectors
2. <b>Lighting coil</b> defective	2. Replace lighting coil

10



# NOTES



Printed in U.S.A.

p/n 2255-009