

TELEGRAMS: "HOPIT, WOLVERHAMPTON."

TELEPHONE: 1731 (FIVE LINES).

A.J.S.

Motor Cycles

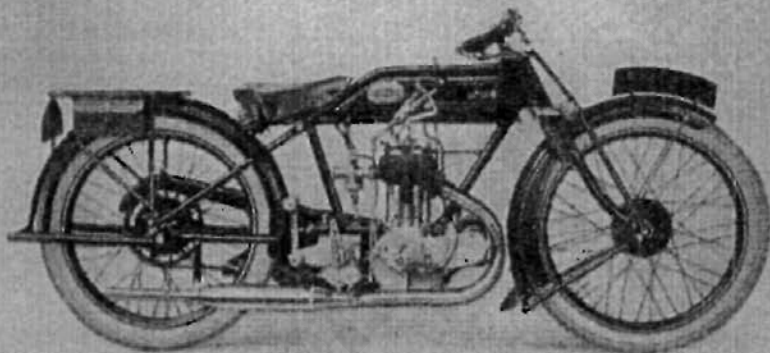

◦ 1927 ◦

3-49 h.p. 3-SPEED A.J.S. SOLO MACHINES.
MODELS H3, H4 and H5.

Applicable also to MODELS G3, G4, G5, 1926, E3, E4 and E5, 1925,
and Models B, B1, and B5, 1922-24, and MODEL B2, 1922.

HOW TO MANAGE THEM.

A. J. STEVENS & CO. (1914) Ltd.,
GRAISELEY HOUSE, WOLVERHAMPTON.

PLAN **A.J.S.** VIEW.

A.J.S. 3.49 H.P.

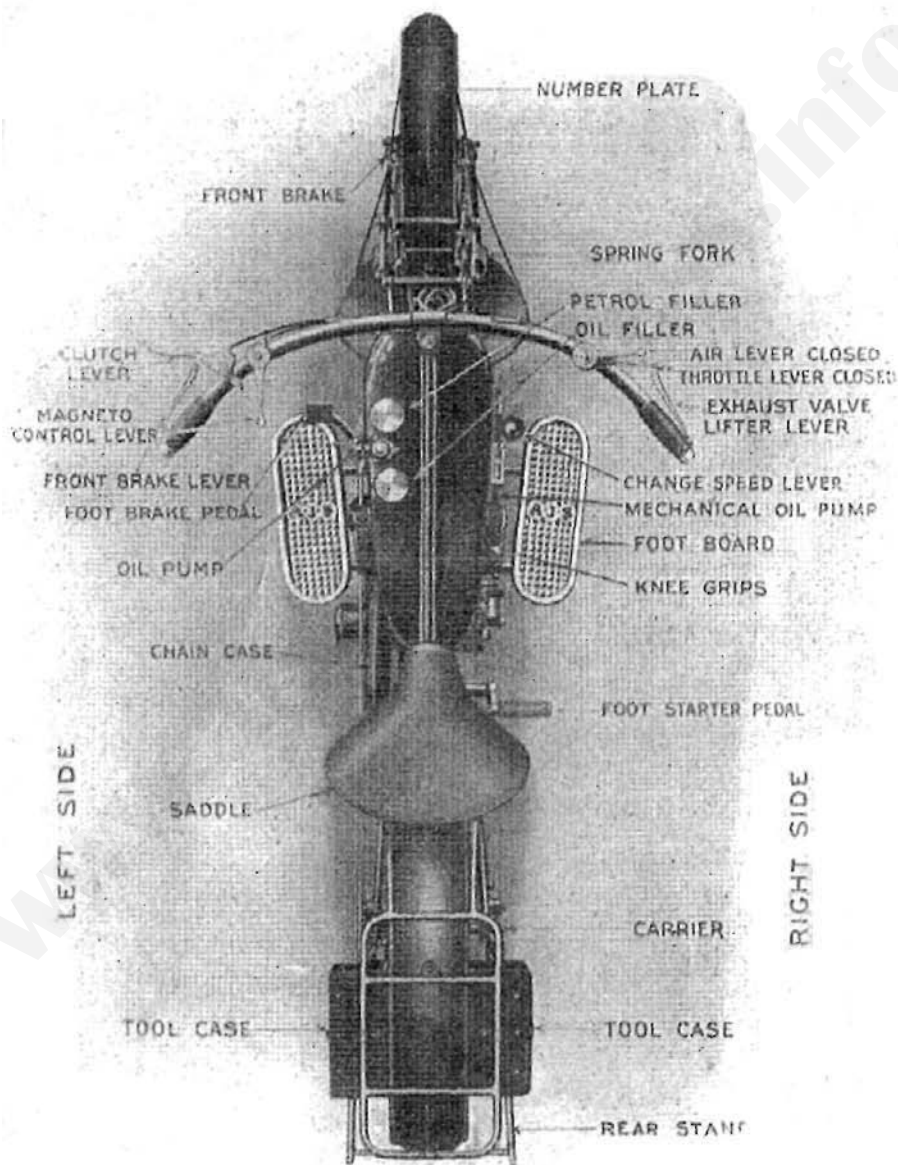

3.49 H.P.  3.49 H.P.

MOTOR CYCLES

FOREWORD.

It has always been our aim to construct A.J.S. Motor Cycles on such simple and straightforward lines that their management, running and upkeep, shall present no difficulties, even to the motor cyclist with little or no previous experience.

Complications in the way of design have always been studiously avoided ; and this little booklet is intended to render the owner familiar with the salient features of the 3.49 h.p. A.J.S., and so enable him to get the best out of his machine.

The information given in the following pages has been very carefully compiled in the hope that it will prove of assistance to the rider in keeping his machine in the best possible condition, and aid him in elucidating any little difficulties which may arise from time to time.

The reader's attention is specially drawn to the pages detailed to Driving Instructions and General Care of the Machine, and particularly to those parts of the instructions which are emphasised by being printed in italica.

Re Supply of this Publication.

A copy of this booklet is supplied free with every new 3.49 h.p. A.J.S. Motor Cycle. Applications for extra copies must be accompanied in every case by a remittance for 6d. to cover cost and postage.

A. J. STEVENS & Co. (1914) LTD.

1927.

CONTENTS.

	PAGE
Driving Instructions	6
Carburettor	10
„ Controls	6
„ Starting Up when Cold	6
„ Adjustment	7
„ Principle of	11
„ Tuning and Driving	11-13
Engine Lubrication	14
Engine Adjustments and Cleaning	15
Magneto	16
„ Point Adjustment	16
„ Timing	16
„ Ignition Trouble	17
Engine Timing	18
Gear Box	19
Gear Box Dismantling	19
Clutch Adjustment	20
Transmission	22
Adjustment of Chains	22
Care of Chains	22
Chain Repair	23
Chain Guard	24
Steering Head Adjustment	25
Spring Fork Adjustment	25
Rear Wheel Adjustment Gauge	26
Detachable Wheels	27
Removal of Back Wheel	27
Tyre Repair	27
Removal of Front Wheel	28
Adjustment of Hub Bearings	28
Replacing Foot Starter Spring	29
General Instructions	30

INDEX TO ILLUSTRATIONS.

	PAGE
Plan View	2
Change Speed Gear Lever	8
Binks Carburettor	10
A.J.S. 3.49 h.p. Engine	14
Magneto	16
Magneto Timing	17
Magneto Adjustment	18
Arrangement of Timing Gear	18
Gear Box in Position	19
Gear Box in Section	19
Clutch Parts	20
Chain Guard with Clutch Cover removed	21
Chain Rivet Extractor	23
Chain Repair Parts	24
Adjusting Steering Head	25
Rear Wheel Adjustment Gauge	26
Back Detachable Wheel removed	27
Front Wheel removed	28
Internal Expanding Brake	28
Replacing Footstarter Spring	29

DRIVING INSTRUCTIONS, ETC.

For 3.49 h.p. Three-speed A.J.S. Motor Cycle.

AFTER receiving the machine, thoroughly examine it and get conversant with its details. Fill up with petrol and oil.

Only oil suitable for air cooled engines must be used. We use and recommend Wakefield Castrol C, P.ice's "Huile de Luxe" heavy grade, or Mobilol "BB Summer," "TT Winter," are also suitable.

The oil tap of the Hand Pump will be found below the elbow outside the tank. This tap can be left in the "on" position while riding, and need only be turned off when the machine is left standing for a long period. For further instructions regarding lubrication see "Engine Lubrication" on Page 14.

Inject a small quantity of petrol into the cylinder through the compression tap by means of the priming pipe under the tank. It will greatly facilitate the entry of the petrol into the cylinder if the exhaust valve lifter is raised. After the petrol has been injected see that the compression tap is closed again.

Unless the engine is cold and difficult to turn, it is seldom necessary to inject petrol into the cylinder.

To start the machine carry out the following operations —

See that the gear lever is in the "Neutral" position marked on the gate change quadrant (Illustration B).

Retard the ignition lever about $\frac{1}{4}$ or $\frac{1}{2}$ its travel. This is to prevent back-firing. The lever is pushed to the left (outwards) to retard, and to the right (inwards) to advance.

Carburettor Controls. For easy starting, the throttle setting is important. The air control lever is the top or shorter lever on the right handlebar, and opens the air valve inwards. For general running, this air lever should be at least half way open; only closing for starting from cold. The throttle lever is the bottom or longer lever on the right hand bar, and opens the throttle inwards.

If the cable is properly adjusted, the least movement inwards of the levers should begin to operate against the springs in the carburettor. If there is any slackness in the cable, the adjusting screw in the top of the carburettor should be raised to remove the backlash.

Starting up from Cold.

- Turn on the petrol by pushing the tap to the "on" position and when the float needle has risen, give it one or two taps with the finger to flood the carburettor.
- Shut the air lever.
- Open the throttle very slightly; that is, about $\frac{1}{4}$ " pull on the wire after you have felt the resistance of the throttle spring.

Footstarter. Now lift the exhaust lever and turn the engine over, say twice, with the footstarter, to get gas into the cylinder. Then give one smart kick downward, dropping the exhaust lifter at the correct moment, and the engine should start. Take the foot off the pedal immediately the engine fires, but do not allow the footstarter to spring back with a bang. Bring the foot back with the pedal, and so prevent a heavy blow being given to the stop. Should the footstarter fail to engage for any reason, do not use force, but lift the clutch lever on the left-hand side of the handlebar, and at the same time depress the footstarter pedal.

Carburettor Adjustment. If the engine has been started with the air closed, it will be found that the mixture is very rich, so steadily open the air lever until the engine runs smoothly. For dead slow running, the air lever should be rather more than half open. In traffic the air lever should be set approximately three-quarters open, and for touring wide open; closing slightly only for hill climbing and running through towns.

The correct position of the air lever of course, varies with atmospheric conditions, the quality of petrol, etc., but in a short time the rider should be able to get the correct setting of the air lever from the behaviour of the engine on the road. If the air lever is set properly, the carburettor should be practically automatic throughout its touring range.

If the engine does not start easily after the first attempt, the rider is usually inclined to heavily flood the carburettor, and so cause the mixture to be so rich that starting is impossible. If it is thought the mixture is too rich, open the throttle and air lever fully. Raise the exhaust valve lifter and turn the engine over a few times with the footstarter. This will get rid of the excessive petrol in the engine. Then proceed to start the engine again as described in the first part of these instructions.

To sum up for Starting. Do not flood the carburettor except when cold or when petrol has been turned off for any length of time.

There is no need to shut the air lever if the engine is hot.

Do not open the throttle more than the slightest amount.

Set the ignition lever a quarter or half retard, and when the engine is started, advance the ignition fully.

Presuming these instructions have been carried out, withdraw the clutch, place the gear lever in the low position, speed up the engine by opening the throttle a little, and gently release the clutch lever. The machine will then move forward on the low gear. When the machine has attained a fair speed on this gear, again pull out the clutch and move the gear lever into second gear position, immediately re-engaging the clutch.

Repeat this operation to engage high gear. When running on high gear, the machine must be controlled by means of the throttle lever and brakes. To stop, close the throttle and when the machine is almost at a standstill, take out the clutch and apply the foot brake.

Twist Grip Control. In the case of twist grip control, the throttle is operated by a movement of the right handlebar grip which opens and closes the throttle. To open, twist the handlebar grip inwards, that is, in an anti-clockwise direction when seated on the machine. The twist grip pulls the control wire like the ordinary control lever, but working around the bar instead of on top of it. Backlash is taken up by adjusting the screw on top of the carburettor, as previously mentioned. When twist grip control is fitted, the ignition control lever is mounted on the right handlebar. This is the top or shorter lever of the two and advances inwards and retards outwards. The air control lever is the bottom or lower one on the right hand bar, and opens the air valve inwards. For general running this air lever should be at least half open, and only closed when starting from cold.

Starting up from Cold. The previous instructions under the headings (a) and (b) should be carried out.

(c) Now open the throttle about a quarter inch movement on the diameter of the rubber grip. Afterwards proceed to start up, see under the heading of "Footstarter."

The change speed lever is operated as follows.—To engage the low gear from neutral, press the lever lightly to the right and pull backwards (see "important warning" below). To move to second gear, again press lightly to right and move the lever forward into second gear position. To engage high gear from second, press the lever to the left and move it forward into the high position. How to operate the gear lever will be obvious if a careful examination is made of its construction. The gear lever has a positive stop for each gear, whether changing up or down, and is automatically locked in each position when released by the hand.

Important Warning.—If the change speed lever does not move quite easily into position, do not attempt to force it. Move the machine slightly backwards or forwards, or turn the back wheel, while keeping a little pressure on the lever. This will bring the "dog clutches" in the gear box into proper position for engagement, and the gears will engage without using unnecessary force. Under no circumstances must this lever be forced into position, or the working parts will be strained and damage done.

This warning only applies when the machine is stationary, not when being ridden.

Always drive with the air lever of carburettor open as far as possible consistent with the engine firing properly. It is not always necessary to stop the engine when the machine is brought to a standstill, but it can be left quietly running until ready to start away again. This can be done by taking out the clutch momentarily, and slipping the gear lever into the neutral position, afterwards releasing the clutch again. The engine will now be running free. Do not "race" the engine while standing, throttle it down just sufficient to keep it firing until ready to start away again. In the case of a short stop, as when obstructed by traffic, the clutch only need be taken out, but always remember to engage low gear when starting again.

Although it is not absolutely necessary to do so, it will be found a much nicer method of changing gear if the following instructions are carried out:—When changing from a low to a higher gear, slightly slow the engine down by closing the throttle a little immediately before changing. When changing down let the engine accelerate slightly with the clutch out before engaging the lower gear. A little practice will soon make the rider proficient.

The most common cause of damage to gears is changing to a low gear whilst the machine is travelling fast. Many riders make a practice of approaching a corner at a high speed, and to bring the machine to a safe pace to negotiate it, they forcibly engage lower gear. If it is desired to turn a corner on a lower gear, the machine should be brought down to a safe pace by means of the throttle and brakes before changing to the lower gear. Changing from a high gear to a low one when travelling fast, for the purpose of braking the machine, is abuse which no orthodox gear box will put up with for long.

Always change gear quickly and firmly, but without using unnecessary force.

When climbing a steep hill which necessitates changing down to a lower gear, always change while the machine has reasonable "way" on it. Do not let the machine come almost to a standstill before changing.



THE A.J.S. PATENT CHANGE SPEED LEVER.

Illustration B.

If the machine will not climb a hill on top gear, do not force it to do so by slipping the clutch but change to a lower gear. If the clutch is allowed to slip for a lengthy period under such a heavy driving load it will—owing to the intense heat generated by friction—burn out the cork inserts, in fact would destroy, by heat, any material of which a clutch may be composed. There is really no excuse for the rider who destroys his clutch by this practice. It is not only bad driving, but it is trying to make the clutch do the work of the gear box which is utterly impossible.

Do not run the machine unnecessarily on low gear. This gear is only provided for ease of starting, and climbing exceptionally steep hills, or when negotiating thick traffic demanding a very slow rate of progress. Using the low gear unnecessarily simply means extra wear and tear, high petrol consumption, and shortens the life of the engine and transmission.

When climbing an exceptionally steep hill it is sometimes an advantage to slightly retard the spark, but under normal conditions the spark lever should be kept in the "advanced" position. If the engine has any tendency to "kick back" when starting it with the footstarter, slightly retard the ignition. The lever on the left handle bar is moved inwards to advance and outwards to retard.

When running at very low speeds on top gear a slight harshness in the drive may be felt, which is common to all petrol driven machines, however well balanced an engine may be. More especially is this so in the case of a single cylinder engine. To counteract this we fit a shock absorber on the engine shaft, which damps out as far as possible any snatch at slow speeds. The driver has also a further means of eliminating this slight harshness by judicious use of the ordinary clutch. By easing the hand clutch a little, by means of the lever on the handlebar, the drive can be made just as sweet and as comfortable as one may wish. A slight pressure of the hand on this lever allows the clutch to slip slightly under the impulses of the engine, and so the clutch is instantly converted into a perfect shock absorber at the will of the rider. The foregoing hints also refer to "picking up" again after slowing down for a corner, or any other occasion when the machine is to be accelerated suddenly from a slow to a higher speed. It must be quite understood, however, that the clutch is not disengaged so much that it slips to the extent that the engine can "race." Only just so much pressure should be exerted on the lever to allow the clutch to absorb the impulses of the engine. We earnestly commend this paragraph to those riders who are anxious to get the best results and long life from the engine, gears, and chains, to say nothing of the added comfort and satisfaction.

Do not control the speed of the machine with the free engine clutch, excepting in very congested traffic as previously mentioned. Always drive "on the throttle." The object of the clutch is **not** to control the speed, the throttle in conjunction with the gear box and the brakes should be used for this purpose.

After a short run it will be found that the control of the machine is quite simple, and the disposition of the levers, operating the footbrake and the clutch, give the rider absolute mastery over his mount. On low gear the machine can be driven at a perfect crawl, and on high gear it is capable of attaining a speed to satisfy even the fastest of riders.

3.49 h.p. SIDE VALVE
BINKS **2 JET** **CARBURETTOR.**
 SEMI-AUTOMATIC
MODEL 425.

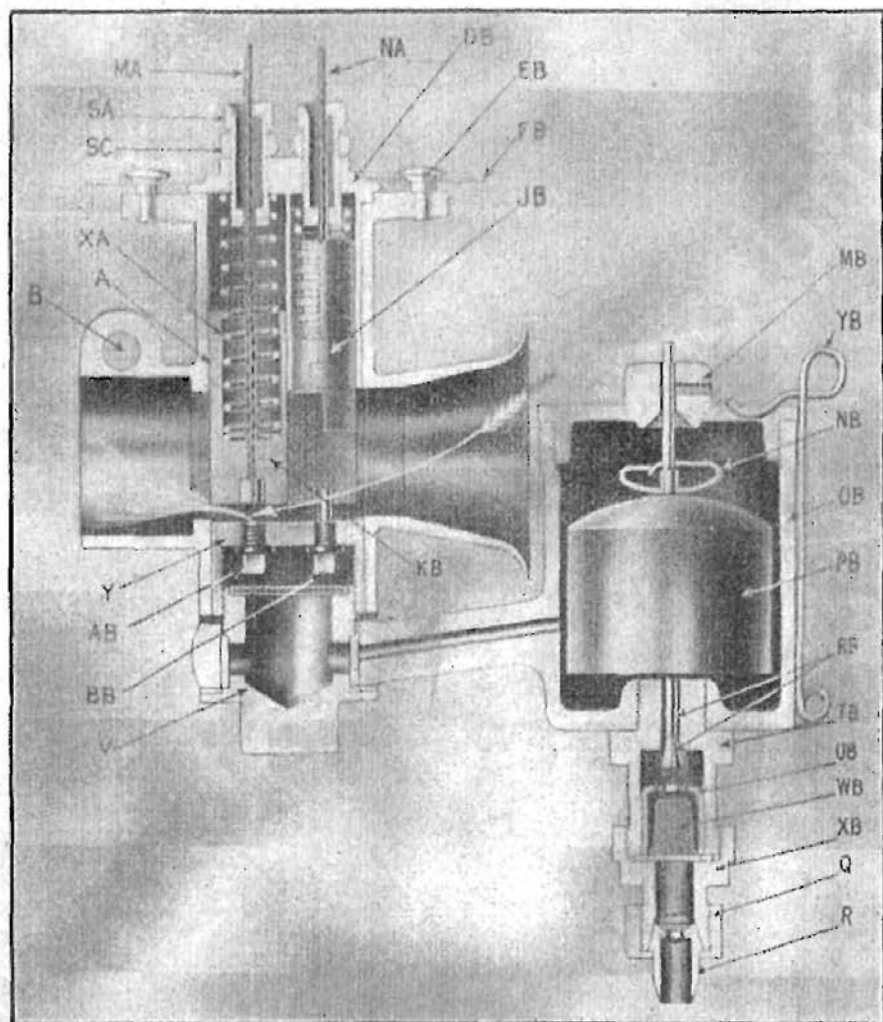

This illustration shows the Pilot Jet only working.

PROBABLE JET SIZES in a 19 mm. choke tube:—

PILOT JET (short A B) nearer the engine, No. 2.

MAIN JET (long B B) nearer the air inlet, No. 7.

Try one size larger or smaller.

This carburettor is specially made for us to screw direct into the cylinder head and is backed into position by a nut—thus air leaks are avoided.

PRINCIPLE OF THE CARBURETTOR.

This Carburettor has two jets and two controls, as can be seen by the illustration on page 10.

The pilot jet under the throttle at first works alone in a high velocity of air and provides the gas for starting and slow running, and then as the throttle is opened leads off on to the main jet which comes into operation when the throttle is lifted more than a fifth of its movement. The quantity of gas is controlled by a round throttle with a slot in it; the strength of the mixture for the recommended jet setting is varied by a plunger working above the main jet. A correct mixture is obtained by lifting the jets specified (see page 10) which, when the engine is warm, will allow the air lever to be two thirds open for ordinary touring.

The two jets have their sizing orifices submerged in the petrol at the bottom of the jet and as they are protected by a filter right underneath, it is practically impossible for them to choke up. The outlet of the main jet stands at a higher level than the outlet from the pilot jet, consequently its action is delayed. At small throttle openings the air proceeding to the pilot jet passes the main jet without causing it to deliver petrol, but at wider throttle openings both jets are working, thus with a movement of the throttle a see-saw action takes place on the two jets and with the recommended jet setting provides an almost automatic carburettor.

One of the many convenient features of this carburettor is that when closing the throttle to run in traffic the mixture is automatic and there is no need to fiddle about with the air lever or keep the engine running quietly when declutched.

THINGS TO KNOW ABOUT IN THE DESIGN.

(1.) **FLOAT CHAMBER.** To undo the Float chamber lid, pull off the spring "YB" and then unscrew the lid by fixing the key on the hexagon.

The Float can be removed by pinching the bow spring between finger and thumb and lifting it off the needle.

The Petrol Level is fixed and is suitable for all fuels that can be bought on the roadside.

To get at the jets unscrew the filter holding screw "V" and with the key provided in a separate packet they can be screwed out. Only tighten the jets finger tight—the bigger the number on the jet the bigger the jet.

To remove the Throttle and Air Plunger press down the two ends of the spring "FB" with your two thumbs, then swivel it round until it disengages from the conical pegs—the parts will then lift out. When replacing see that the adjusting screw plate key goes into the slot at the top of the throttle barrel, and finally make sure that the spring "FB" is fully engaged under the conical pegs on both sides.

INSTRUCTIONS FOR TUNING AND DRIVING.

Read instructions on page 6, especially paragraphs "A," "B" and "C," and if the carburettor should not work to your full satisfaction, read through the following headlines to trace the fault, assuming you have verified that the Engine and Ignition are in good order:—

(a). **LACK OF POWER.** If better acceleration can be obtained with the air lever half closed the main jet may be too small—**REMEDY**, fit a larger main jet.

If closing the air valve makes matters worse and there is a trace of black smoke in the exhaust, the main jet is too large—**REMEDY**, fit a smaller one.

BINKS CARBURETTORS—continued.

Verify the flow of petrol through the petrol pipe and if it is not good, clean out the tap in the tank and the pipe itself.

Verify that the jets are not choked (although this is most unlikely) and see that the filters are clean.

(b). **IMPERFECT SLOW RUNNING.** Are the sparking plug points too close together? There should be a gap of .028", or less if the magneto current is not sufficiently strong for a gap of this size. In any case the points should not be further apart than specified. Sparking plug oily inside—**REMEDY**, clean out with petrol.

If the engine runs jerkily and 8-strokes, the pilot jet is too large—**REMEDY** fit a smaller one. If the engine misfires and will run better if you shut the air lever right off the pilot jet is too small—**REMEDY**, try a larger one.

Sometimes a weak mixture is due to a slack inlet valve guide which allows air to pass down the stem and so upsets the carburettor—**REMEDY**, a larger pilot jet or new inlet valve guide.

If the above suggestions do not lead to good slow running remove the throttle and see whether it has worn out of round at the bottom. If so the **REMEDY** is a new throttle.

(c). **HEAVY PETROL CONSUMPTION.** Are you driving with the air lever too much closed? Have you verified the jet setting that the jets are the smallest that permits the engine to run well? Have you been doing a lot of low gear driving which might reasonably account for bad petrol consumption? Is petrol leaking from the carburettor? If so read through the paragraph headed "Flooding."

(d). **FLOODING.** Is nearly always due to impurities in petrol getting on to the valve seat. See that there is a filter in the petrol pipe union and in good order.

See that the needle clip has not come out of the groove in the needle.

Rattle the float to see if same is petrol-logged.

See that the needle is not bent.

Never grind in a needle into its seat with emery; rub it in only with the finger and thumb.

To see the petrol level, unscrew the lid. The level should be not quite up to the domed top of the float.

(e). **ENGINE WILL NOT START AFTER HAVING TRIED AIR LEVER SHUT AND HALF-OPEN.** Make sure there is a good spark at the plug by taking it out and actually seeing the spark when the engine is being turned over with the plug resting on the cylinder.

The plug points may be oiled up and require cleaning.

The plug may have a cracked insulator and requires renewing.

Verify that the pilot jet is the correct size and that it is not choked up.

Have you been opening the throttle too wide? (see paragraph "C" on page 8).

Remember, only open the throttle slightly, so that you can hear the hiss of the air over the pilot jet.

If you have failed to get a start and have been flooding the carburettor you may have glutted the engine—**REMEDY**, turn off the petrol, open the throttle and air lever wide and give the engine several kicks over, then try starting again with the throttle only a little open, with the air lever open.

(6) **ENGINE SPITS BACK INTO CARBURETTOR WHEN THROTTLE IS OPENED GRADUALLY.** If the main jet is the correct size for power the general **REMEDY** is to close the air valve a little. However—

- (1). Make sure there is a good supply of petrol.
- (2). See there is no obstruction in the main jet.
- (3). See that the level of the petrol is not more than $\frac{1}{4}$ " below the top surface of the jet plate.
- (4). If the above conditions are correct and spitting still continues at one particular throttle opening, it may indicate a weak phase in the mixture. If the engine runs slowly on the pilot jet and also gives good power on the main jet, **this particular weak spot can be absolutely eliminated by fitting a special main jet perforated by side holes, the effective area of which is less than the main sizing hole of the jet.** This particular weakness of mixture is caused by the main jet coming into operation too late. An alternative remedy is to shorten the main jet by $\frac{1}{8}$ ", but it is better to fit a main jet with side holes which allow a small supply of petrol to add to the mixture before the main jet comes fully into operation.

(a) **ENGINE RUNS WELL SLOWLY BUT AT SPEEDS MISFIRES.** If there are explosions in the exhaust pipe the trouble is probably due to a faulty sparking plug.

(b) **FUEL.** The jet settings recommended are suitable for petrol, benzole or any mixture of petrol and benzole. If you use "discol" the main jet should be about six sizes larger, but it is better not to use this unless you have a special float chamber.

(c) **OVERHEATING.** Possibly the main jet is one size too small or there is a restriction in the flow of petrol to the jets which does not show itself at lower speeds—**REMEDY**, verify the flow of petrol and if necessary fit a larger main jet.

TWIST GRIP CONTROL TOO TIGHT. Loosen the two screws in the twist grip clamp and push the grip up the bar so that you can remove the inverted lever, then slide off the twist grip. Clean it out and smear with grease. Before replacing see that the bar is smooth and well greased.

TWIST GRIP CONTROL TOO SLACK. Remove the twist grip as above and look inside the tube on which the rubber is mounted. You will there see an "X" cut in the tube and by hammering down through the rubber the two points in the centre of the "X," increased friction will be obtained on the handlebar. Remount on a well greased bar.

CARE OF THE MACHINE.

ENGINE.

Lubrication.—On Models H3 and H4 we fit as standard a Pilgrim Mechanical Oil Pump with Sight Feed. When the machine leaves the works this mechanical pump is set to give approximately the correct supply of oil, on Model H5 the hand Pump only is fitted.

During the first one hundred miles, when engine should be quietly run in, the rider should take out the sparking plug occasionally, and see if it is unduly wet with oil. If the plug is not dead dry cut down the supply of oil by turning the adjusting disc on the front of the mechanical pump to the right moving the end of the pointer about $\frac{1}{8}$ in. at a time, until the engine gets a definite supply of oil without oiling up the plug. The top of the pump is provided with a glass window, through which the flow of oil can be seen, and acts as an indicator as to whether the pump is working. Keep an eye on this. When the machine is left standing for any length of time, the feed pipe tap under the tank should be placed in the "off" position. If the machine is lubricated by means of a hand pump only, and over-lubrication causes the plug to get oiled up, the remedy is obvious—give less oil.

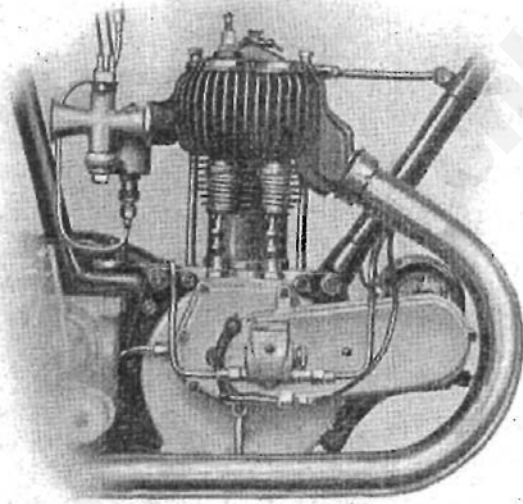

A.J.S. 3.49 H.P. ENGINE.
Illustration C.

Hand Pump.—To give a charge of oil to the engine, push the tap to the "on" position and depress the plunger of the oil pump to its full extent. This will fill the barrel with oil, and the plunger being spring loaded, will automatically ascend, and in so doing force the oil into the engine, the plunger rising during the process until it is in position for the next charge to be delivered. When the hand pump is not being used, it is advisable to have the tap in the oil pipe on the "Off" position. In any case, the tap should always be turned off when the machine is left standing for any length of time. As a further precautionary measure the pump can be put out of action by pressing down the plunger to its full extent, and fixing it in this position by means of the small catch provided. In the case of a machine fitted with the mechanical Pump, this Hand Pump is only used as an auxiliary in case an additional charge is required, such as when the machine is being driven hard up long steep hills on second or low gear.

Riders and riding conditions vary, so it is absolutely necessary to leave the question of lubrication to each individual's judgment to a certain extent.

The engine working harshly, and a falling off of power, are the usual symptoms of under lubrication. Over lubrication is shown by oil unduly working out of the valve tappets, and smoke issuing from the silencer. Over oiling will sometimes cause the exhaust valve to stick or move sluggishly in their guides. The symptoms are mostly apparent when the engine is cold. Misfiring occurs, also explosions in silencer and difficulty of starting. The remedy is to take out the valves and clean the stems and guides with petrol.

Adjustments and Cleaning.—See that the valve tappets are always properly adjusted. .006" inlet and .008" exhaust is the correct clearance, or about the thickness of a visiting card between the tappet top and valve stem when the valve is on its seat. Check the clearance when the engine is hot, not when cold. Use two spanners to unlock the adjusting nuts.

To remove the cylinder for cleaning first disconnect the inlet pipe, exhaust pipe, sparking plug. Next unscrew the holding down nuts and remove the bridge. This now leaves the cylinder head free for removal. With a screwdriver or similar tool inserted between the top cylinder fin and the head, prise the head carefully off the cylinder on both sides, taking care not to break the radiating fins. **Prise upwards not downwards.** When the heads are removed it is an easy matter to draw the cylinder off the piston. In doing this the engine should be turned over until the piston is at its lowest position, and draw off the cylinder carefully, taking care that when the piston is free not to let it fall sharply against the connecting rod, as this may crack or break the skirt of the piston, which is easily done. Having removed the cylinder, wrap a clean cloth or rag round underneath the piston to prevent any foreign matter or dirt getting into the crankcase. If the combustion head is badly carbonised this must be cleaned. The generally accepted method being to scrape the chamber free of the burnt charges, which can be done with an old screwdriver or similar tool. The top of the piston should also be scraped free of all deposit, using an old blunt knife or chisel, and while carrying out this operation see that no side strain is thrown on the piston. If the rings are quite free in their grooves they need not be removed, but if they are obviously choked up with burnt oil loosen them very carefully, take them off the piston and clean the grooves thoroughly. Take the piston off the connecting rod to do this. First remove the gudgeon pin from the piston, take out the retaining springs, one of which will be found on either side of the gudgeon pin. These fit into recessed rings in the piston bosses and to withdraw must be squeezed together with the special small pliers provided. Afterwards the gudgeon pin can be pushed out. When replacing the piston, see that both the Gudgeon Pin retaining springs are in place. Having got rid of all deposit from both the head and piston, wash all particles off with paraffin. Before replacing the cylinder after cleaning, carefully oil the piston, and see that the joints of the piston rings are on opposite sides of the piston. Take care when replacing the cylinder on to the crankcase to see that the packing washer is inserted between the top of crankcase and the base of cylinder.

If it is required to remove the valves at any time for inspection, grinding in, etc., there is no need to touch the cylinder. All that has to be done is to unscrew and take out the valve cap, then place the hooked end of the special valve extractor, which is provided in every tool kit, on the top of the valve, using the valve cap spanner, which fits at the bottom of the hook, for the necessary leverage to lift the valve spring to allow the cotter to be withdrawn.

The valve can then be pushed up and drawn out of the head, via the valve cap aperture. If the valve seatings are at all pitted grind in the valves with fine emery flour, taking care that all emery is cleared out of the valve chamber after the operation. The valves should, generally speaking, be ground in about every 1,500 miles.

Drain old waste oil out of the crankcase of engine about every 1,500 miles. For this purpose a drain plug is fitted on chain case side of crankcase. See that four to five pumpfuls of fresh oil are pumped into the engine again, after draining out the old oil.

Examine periodically the bolts which hold the engine in frame, and tighten any nuts that may have worked loose. Keep the engine clean externally, which can be done quickly and easily with a painter's brush and a pan of paraffin.

MAGNETO.

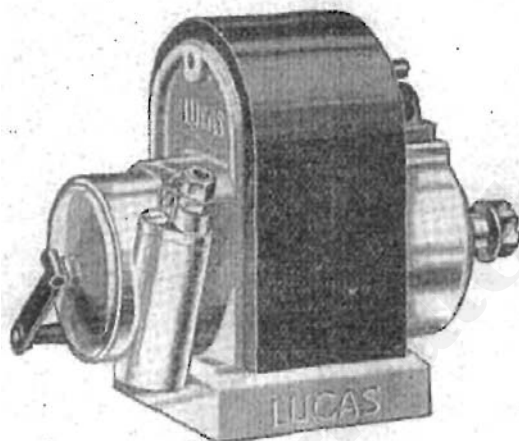

LUCAS MAGNETO.

TYPE K S A I.

Illustration M.

Lubrication.—The instrument is provided with ball bearings throughout, which are packed with grease before leaving the manufacturers. Fresh lubricant should not be required under normal circumstances until the machine has run from 10 to 12 thousand miles.

Adjustment.—The contact breaker points should be examined after about 1,000 miles, and if the break should be more than the thickness of a visiting card they should be adjusted. The proper distance of the gap is 0.5 mm or roughly 1/64 in. full. Too great a gap will advance the timing. A special small spanner is provided with each machine, and the gauge of this is the correct distance for the break of the points. This adjustment, owing to the arrangement of the contact breaker, can be carried out without removing the contact breaker from the magneto. If it is necessary to take the contact breaker out, unscrew the long taper fixing screw, and pull the contact breaker off. The points only need attention at very long intervals, and we warn users against unnecessarily interfering with the setting. *The points must only be dressed with a dead smooth file if the surface has become at all pitted, and then the least possible amount taken off; the greatest care being exercised.*

Timing.—If the magneto has been removed from the machine it will be necessary to see that it is timed correctly after it is refitted. The engine magneto driving sprocket is secured to its shaft by means of castellations, which render wrong replacement impossible. The sprocket on the armature shaft of the magneto is supplied with a vernier timing adjustment, which allows a very accurate and certain method of fixing the drive after the correct setting has been arrived at. The setting of this vernier adjustment may at first sound a trifle complicated, but in reality it is perfectly simple. Keyed to the armature shaft of the magneto is a sleeve (1), which has thirteen holes ranged in a circle. Fitting over a collar on this sleeve is the chain sprocket (2), which has twelve holes similarly arranged. Now on the sprocket on engine driving shaft and on the magneto shaft an arrow will be found. These must point to each other before anything else is done. The first thing then in timing up is to set these two arrows so that they face exactly towards each other. To do this turn engine over until the arrow on the driving sprocket is pointing directly towards the arrow on the magneto sprocket. This latter should be held free in the fingers and moved a tooth backwards or forwards in the chain until the correct setting is arrived at. When this is so, place the magneto sprocket on to the sleeve, and turn the armature shaft of magneto until a mark found punched over one of the twelve holes on the sprocket exactly registers with a similar mark on the outside of

the collar of the sleeve. It will now be found that the marked holes in sleeve and sprocket respectively exactly coincide, so that all that has to be done is to push the peg washer (3) into these holes, which effectively prevents the sprocket from moving from its correct setting and tightly screw up the sleeve lock nut (4), which can be done without fear of the timing shifting in the process, as is often the case with other methods. Set the piston 1-in. from top of compression stroke—make sure it is not on the exhaust stroke. With the engine in this position take off the sleeve lock nut on magneto sprocket and remove the peg washer. This will leave the armature free from the engine drive, but still connected via the chain to the engine. See that the sprockets have their arrows facing as previously mentioned. Move the ignition control lever to the limit of its motion of advance. Remove the cover of contact breaker and slowly turn the armature till the fibre block of the make and break lever arises on the inclined plane of the steel segment just sufficient to separate the points. This is the firing point, and in this position the markings previously referred to on the sleeve and sprocket should register if correctly fitted up. If so, the drive should be fixed up as before detailed. It is, however, always advisable to check the timing after tightening up.

It will prevent misfiring, and make starting easier, if the slip ring is cleaned occasionally. This is done by taking out the high tension terminal and while the magneto is being revolved by slowly turning the engine round, insert a lead pencil, the end of which is covered with a clean rag moistened with petrol. The pencil should be pressed on the revolving slip ring.

When Ignition Trouble is suspected.—Before interfering with the magneto verify that the sparking plug, the cable, and the connections are correct. If these are in order, turn the engine slowly by hand and watch if the contact breaker lever works properly. This is bedded in a fire insulating bush, and in moist weather there is an occasional danger of the material swelling. If this happens, ease it out very slightly. This is a most common fault with all magnetos, and should be watched particularly by motor cyclists in winter. Do not take the magneto to pieces needlessly. It is easily possible to damage it.

Most Important.—If it is necessary to take out the armature first see that the carbon collectors and safety gap screw are removed, or the collector ring will be broken during removal. Keep all parts clean and free from oil, particularly the contact breaker. Oil or dirt between the points will give instant trouble.

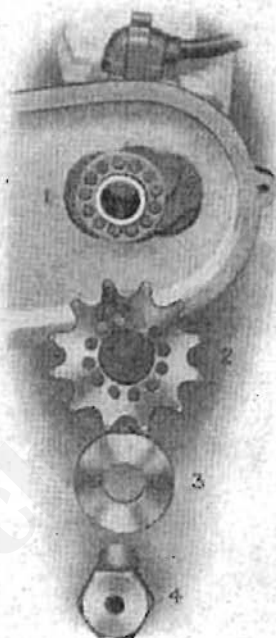

MAGNETO TIMING—VERNIER
ADJUSTMENT.

Illustration N.

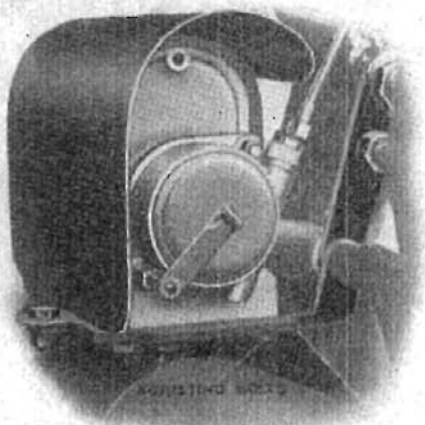

3.49 H.P. A.J.S. MAGNETO ADJUSTMENT
Illustration D.

Magneto Drive Adjustment.—Examine the driving chain occasionally, and, if slack, tighten it by moving the magneto along the platform in a forward direction. Slacking off the four pins underneath the platform allows this. When the correct tension has been obtained, screw the pins up again tightly. Examine also the nuts securing the chain sprockets to the engine shaft and armature shaft of magneto respectively. After examination, before replacing the cover, oil the chain.

Engine Timing.—Except in case of necessity we do not advise tampering with the valve timing arrangement. However, if the engine has been completely dismantled for any reason, we make it a practice to so mark the timing pinions that replacement is a matter of perfect ease if the following instructions are carried out. To facilitate correct setting and meshing of the pinions these are marked with a dot system of identification as shown in Illustration E. On the small timing pinion will be found a single dot and a double dot. These dots correspond to similar marks on the inlet and exhaust valve timing pinions. To set the inlet valve place the single dot found stamped thereon in register with the single dot on the small pinion, and similarly in the case of the exhaust wheel which has two dots stamped on it.

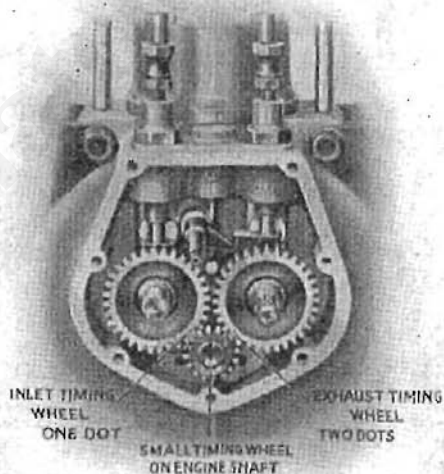

ARRANGEMENT OF TIMING GEAR
3.49 H.P. A.J.S.
Illustration E.

Magneto Timing.—The spark is timed to take place 9.5 m/m or $\frac{1}{4}$ -in. on Model JG3 before the top of the compression stroke, with the magneto control lever in the fully advanced position, and 12.7 m/m or $\frac{1}{2}$ -in. on models G4 and C5, also on model B2 1922.

With the exception of carrying out the above instructions, do not tinker with the engine, nor fancy you can do better than the makers by tampering with the valve timing gear.

GEAR BOX.

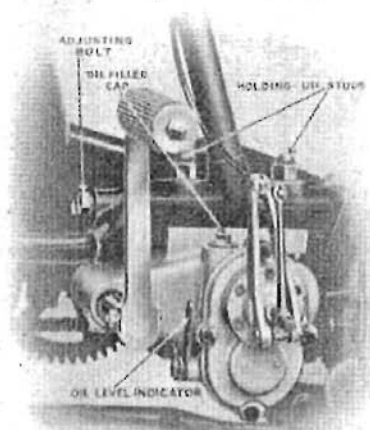

A.J.S. GEAR BOX IN POSITION.
Illustration F.

Lubrication.— The gear box needs no attention whatever with the exception of replenishing with oil every 500 to 800 miles. Oil as used for the engine is suitable, but a very thick oil is the most suitable. It will facilitate the entry of oil into the box if the back wheel is slowly revolved (with gear in neutral position) while pouring in the oil.

An oil level indicator is provided in the form of a small shutter on the left hand side of the gear box, looking at it from the front. When pouring in oil leave the shutter open, and as soon as oil begins to overflow, close it. This is the correct level and no more oil need be inserted.

To dismantle the box the following procedure must be carried out:—

First detach the Bowden cable from the clutch operating lever on gear box. To do this press the lever inwards sufficiently to allow the nipple of the cable to be inserted into the cap which hold this to the gear box cover. The clutch operating mechanism can now be taken off entirely. Take care when doing this not to lose the short push rod. It will be found that on the end of the main shaft a thrust lock nut is fitted. This has a left-hand thread, and the punch provided in the tool kit should be employed to unfasten it. An arrow will be found on this nut pointing towards the left; this is the direction in which the nut must be unscrewed. Behind this will be found the ball thrust nut; remove this and the thrust washer. To take this out push the main shaft back a little so as to allow the washer to be withdrawn. This washer fits on a dowel peg, and care should be taken when replacing to ascertain that this is correctly in place. Now take out all bolts round the cover of the box and pull the cover off. The low gear dog wheel and lay shaft can then be taken out, also the sliding sleeve. The main shaft, complete with clutch, etc., can be drawn out from the opposite side of the box. To reassemble simply reverse these operations.

N.B.—Be sure the Thrust Lock Nut is tight after replacing.

Do not forget to put fresh oil in the box after dismantling.

1. Clutch operating Lever for disengaging clutch.
2. Push Rod adjusting Screw.
3. Oil Filler Cap.
4. Oil Level Indicator.
5. Main or Primary Shaft Drive.
6. Lay or Secondary Shaft.
7. Sprocket for Transmitting to road Wheel.
8. High Gear Dog Wheel.
9. Sliding Sleeve.
10. Low Gear Dog Wheel.
11. Clutch Fixed Plate.
12. Clutch Sprocket receiving drive from Engine.
13. Footstarter Ratchet Wheel.
14. Clutch Spring.
15. Clutch Spring Adjusting Nut.

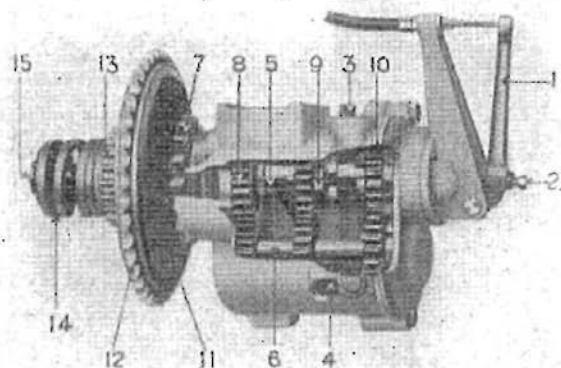

A.J.S. 3 SPEED GEAR (PORTION OF CASE CUT AWAY).
Illustration G.

CLUTCH.

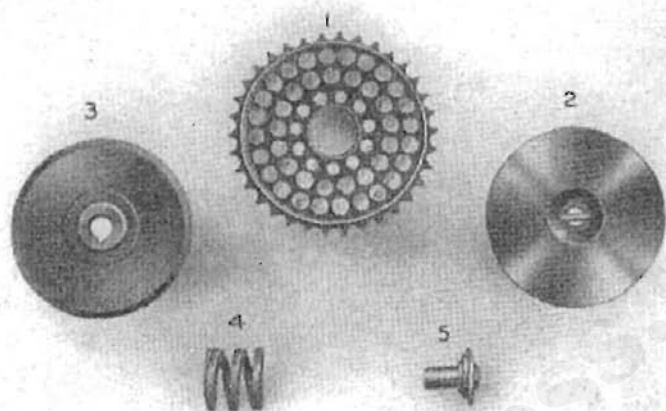

Illustration H

- | | |
|---|---------------------------------|
| 1. Clutch Sprocket fitted with Cork Inserts. | 3. Fixed Plate |
| 2. Sliding Plate (note key in centre which passes through main Gear Box Shaft). | 4. Clutch Spring. |
| | 5. Clutch Spring Adjusting Nut. |

The Clutch parts are assembled in the following order—3, 1, 2, 4 and 5.

Adjustment.—If the clutch should slip when climbing steep hills, tighten up the clutch spring a little by means of the adjusting nut on end of the clutch shaft, and adjust the Bowden cable until there is a little play in the lever. Do not tighten up the spring more than necessary to obtain a perfect grip, or unnecessary strain will be put upon the Bowden control, &c., when the clutch is disengaged.

Do not put Oil into the Clutch under any circumstances.

No. 2 To take up excessive backlash in Bowden lever on handle bar adjust by means of the operating shaft adjusting screw (Illustration G). A further adjustment is also provided by a stop formed by an extension of the rear engine plate (left-hand side) through which the Bowden cable passes. However, always allow a little backlash in the lever, or the clutch spring cannot exert all its pressure on the plates. If the Clutch slips without any external reason, take it apart and ascertain if any portion of its mechanism is fouling another, and so keeping the plates apart. If the key in boss of clutch plate No. 2 (Illustration H) should foul the end of slot in shaft it would prevent the clutch engaging.

TO DISMANTLE THE CLUTCH, take off the front portion of the chain cover.

Unscrew the clutch spring adjusting nut No. 5 (Illustration H) and remove the spring No. 4. Take out the cotter pin of foot-starter crank and remove crank. This will allow the starting quadrant with its spindle to be drawn out until it can pass the stop on chain stay. The quadrant can then be swung clear of the clutch and allow the plates to be drawn off the clutch shaft. Before replacing, wipe the clutch plates clean, and smear a thin film of oil on the portion of shaft on which the front clutch plate slides. Also before replacing, examine the lock nut which holds the fixed plate in position. If loose see that it is carefully tightened up again.

CLUTCH.—continued.

It is, of course, necessary to take the chain off the clutch sprocket before this can be removed (see Illustration L for particulars of chain joint). It will be found that a flat key passes through a slot in the end of the clutch shaft, and fits in the boss of front or sliding plate. Great care must be taken to see that this key is in its proper position or the clutch cannot be disengaged. This key is clearly shown in Fig. 2 (Illustration H) across the centre of the plate. To fit this key when re-assembling the clutch, turn the shaft till the slot is perfectly horizontal. Then put key in slot with each end projecting equally on each side of the shaft. The sliding plate should then be slipped on shaft with its keyway in a corresponding horizontal position.

For method of replacing Footstarter Spring see page 29.

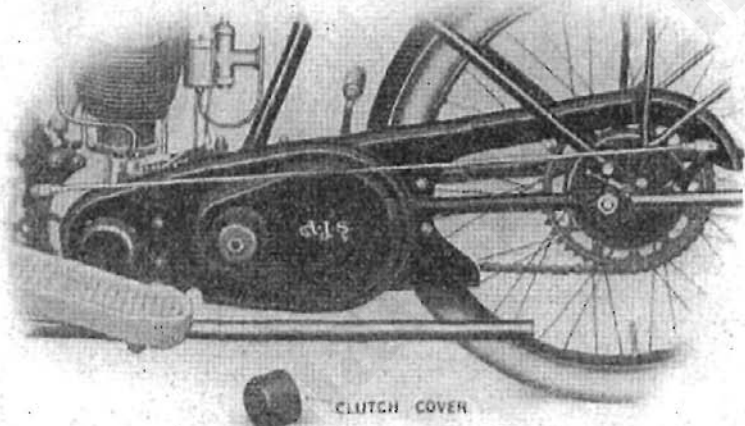

CHAIN GUARD, WITH CLUTCH COVER REMOVED.

Illustration L.

If to disengage the clutch becomes difficult smear a little oil on that portion of shaft on which the outer plate slides.

If the clutch should "drag," even when fully disengaged, it will make gear changing very difficult, especially when changing down, for the reason that the drive is never properly taken off the gears, thus making it difficult to move the gear lever. This difficulty can be temporarily overcome by suddenly closing the throttle before changing down, immediately opening the throttle again after the change is made. The closing of the throttle takes the drive off the gears, and so allows easy disengagement.

To those riders who prefer a light adjustment of the clutch, the following hint will be useful. A clutch that is lightly adjusted will sometimes slip for a time after changing gear, but the slip will cease if the throttle is momentarily closed when the slip takes place. This is explained by the fact that for the moment the drive is taken off the clutch and allows the plates to settle down to their work.

TRANSMISSION.

Adjustment of Chains.—To adjust the chain from engine to gear box it is only necessary to slack off the two nuts on top of bracket and slide the box bodily backwards by means of the adjusting bolt, situated at rear of bottom bracket.

It is important that the nuts are screwed tightly again after adjustment.

Back Chain.—Slack off the nuts on each side of back hub spindle, and move the wheel backwards by means of the adjusting screws in fork-ends. Care must be taken to adjust each side equally or the wheel will be out of alignment. Screw the spindle nuts up tightly again after the chain is properly adjusted. It may be found that moving the wheel back has caused the brake to be "on." This is easily rectified by means of the brake adjustment.

If the chain is too slack it is apt to "whip," which intensifies the wear and tends to break the rollers, especially in the case of the front chain. If on the other hand it is too tight, a crushing effect is produced on the rollers, and the whole chain is strained unduly.

The chains should be adjusted, and kept adjusted, so that they can be pressed down in the centre with the finger from $\frac{1}{8}$ in. on the front chain, and about $\frac{1}{4}$ in. on the back chain.



CARE OF CHAINS.

Lubrication.—As the chains of the 349 A.J.S. are only partly enclosed it is a good plan to make a point of oiling the chains every day before starting out. One oiling will suffice for a day's riding whatever mileage is done. An oil gun is the best means of oiling the chains. With this instrument draw a charge of oil from the oil compartment of tank, and insert spout of oiler into the chain case oil plug hole, which will be found on top of front of chain case above the front chain. Lift the exhaust valve and while pressing down plunger of oil gun, slowly turn the engine round with the foot starter, taking care that the oil from the oil gun is falling on the chain. This ensures the whole chain being well lubricated. Treat the back chain in the same way by slowly revolving the back wheel.

Long life, less need of adjustment, and complete satisfaction with the transmission is assured if the rider will make a point of oiling his chain frequently, to say nothing of the knowledge that they are regularly having a supply of fresh clean oil.

CHAIN REPAIRS.

A Chain hardly ever breaks if properly adjusted (we have never yet heard of a chain breaking with our system of transmission), since it is usually worn out long before the breaking point is arrived at.

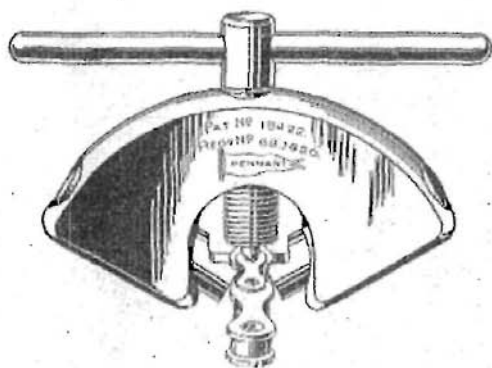

Illustration KI.

If lubrication or adjustment is neglected, broken rollers may occasionally be found. The chain can, however, be easily repaired with the Pennant Chain Rivet Extractor (Illustration KI) and a few spare parts. This tool provides a simple means of removing the rivets, which cannot be filed down, as they are casehardened. It can also be used for putting in a new outer link.

This tool provides a simple means of removing outer links by pushing the rivet heads through the plate.

The illustration shows clearly the method used in the removal of the outer link by means of this tool.

CHAIN RIVET EXTRACTOR.

To Remove complete Links.—Screw down the punch on to the head of each rivet in turn through the top plate. Both rivets should be pushed out from the same side of the chain.

To Remove Broken Links.—Insert chain roller between the jaws and screw down the punch in order to press the head of the rivet through the top plate. Remove chain from extractor, and link will fall out.

Note—Before attempting to extract a rivet, compress the ends of the jaws to obtain a grip on the chain roller.

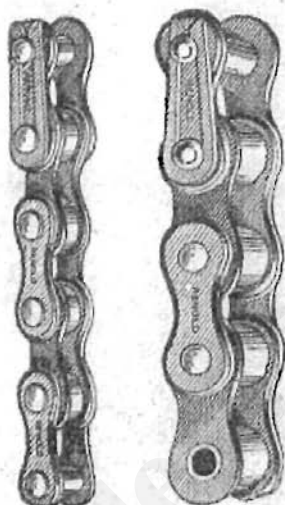
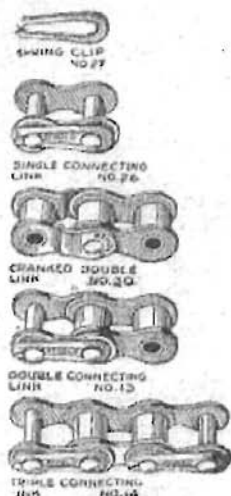

CHAIN REPAIR PARTS.

Illustration L.

- The above illustration contains all the parts necessary to effect repairs to a chain:
- To shorten a chain containing an even number of pitches replace by parts No. 30 and 26.
 - To shorten a chain containing an odd number of pitches replace by parts No. 13.
 - To repair a chain with a broken roller or faulty inside link, replace by parts No. 14.
 - For joining up any length of chain where extremities are inside links, use part No. 26.

When a chain is joined up with a spring clip, it is most important that the clip is correctly fitted over the cover plate. The open end should always face in the opposite direction to which the chain travels.



CHAIN GUARD.

To remove the case completely, first disconnect the rod from the foot pedal by undoing the yoke end pin. This allows the rod to be swung back out of the way. Next remove the two bolts found on the forward end of the guard, then the rear bolts on chain stay clip and the anchorage to carrier stay. The rear portion of the guard can be removed independently of the front by means of the carrier stay anchorage previously referred to.

These directions will be suitable for the G4 and G5 Models. It will be found unnecessary however, to remove brake rod.

STEERING HEAD.

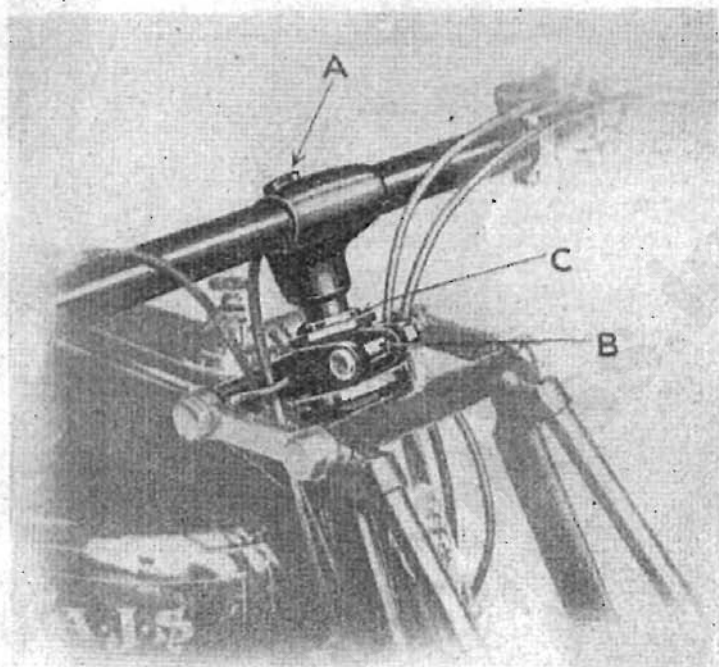

Illustration O.

1. Unscrew Bolt A four turns and give it a sharp tap with hammer.
2. Slacken Nut B.
3. Adjust steering head by Nut C.
4. Lock up Nut B and Bolt A.

SPRING FORK ADJUSTMENT.

To take up any excessive play which may have developed in the side links, unscrew the spindle lock nuts on the right-hand side of the forks (looking at the machine from the front), and turn the spindles by means of the heads on the left-hand side until all slackness is taken up. Afterwards tighten up lock nuts.

REAR WHEEL ADJUSTMENT GAUGE.

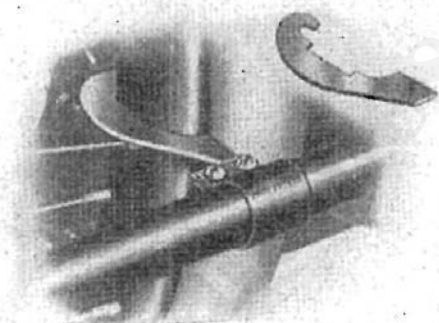
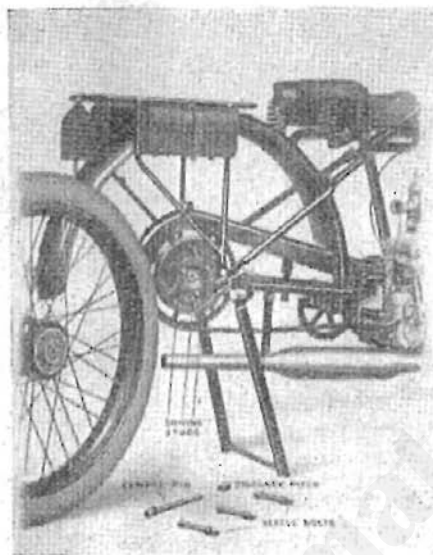

Illustration P.

Rear Wheel Adjustment Gauge.—On the right-hand side of the bottom chain stay will be found a piece of sheet metal, held in position by a clip which passes round the tube.

In the tool kit will be found a flat gauge that can be fitted round the rim (see illustration). When replacing the rear wheel after removal, or after making adjustment to chain, place the gauge just touches the rim with the extension to the right, and set the wheel so that the edge of the gauge just touches the plate that is held by the clip on the chainstay. This ensures the wheel being correctly aligned and must be done before finally tightening up the spindle nuts. Do not attempt to unscrew the clip from the chain stay as the position of the plate is set correctly before the machine leaves the factory.

DETACHABLE WHEELS.



A.I.S. Quick-Detachable Wheel, as fitted to Models H3 and H4.

point out that when the centre pin is removed, the wheel is hanging on one fork only, so any rough treatment must be carefully avoided or there is great danger of straining or breaking the fork end. *Under no circumstances must the centre pin be removed until the machine is jacked up on the stand, and the centre pin must always be in position before the machine is taken off the stand again.* If for any reason the wheel should be difficult to pull off the driving studs, screw in the centre pin a few turns (without the distance piece), this will steady the wheel while drawing it off the driving studs.

If the rider wishes to fit a new tube without removing the wheel entire, he must first take off the one side of the tyre and remove the tube in the ordinary way. Next take out the centre pin and distance piece only, leaving the sleeve nuts intact. This will be found to give sufficient space between the hub and the fork end to allow the tube to be passed through and drawn completely out. Now replace the distance piece and the centre pin and proceed to refit tube and cover. Fitting the centre pin first, hold the wheel firmly while the tyre is being manipulated.

Periodically test the centre pin and sleeve nuts with a spanner, and keep them tight. If the sleeve nuts are loose a dull hammering will be felt when driving at slow speeds. If this is noticed, tighten the sleeve nuts at once. When the back wheel is removed, the *wheel only* is taken out, leaving the chain, sprocket, brake, chain case, etc., remaining in their original position. If desired the wheel complete with sprocket, brake, etc., can be taken out, which is quite a simple operation. Remove the back portion of chain guard, slack off spindle nut and detach brake cable by removing the pin in shackle. Take the chain off the sprocket by means of the spring link, and unscrew the anchor pin which projects into slot of brake anchor plate sufficient to clear. The wheel will then fall out of slots in fork-ends.

Back Wheel.—To remove the back wheel proceed as follows: Put the machine on the stand and with the box spanner provided *first* unscrew the three sleeve nuts which pass through the hub flanges. To prevent the wheel revolving while unscrewing the sleeve nuts, place the foot against the tyre at bottom of wheel. The three sleeve nuts extend right through the wheel and near hub flange, and screw on to the three threaded studs on the driving sprocket. There are also three plain studs on the sprocket which act as dummy drivers. These fit into the three remaining holes in the hub flange. After the sleeve nuts have been unscrewed *then* unscrew the centre pin and draw it completely out, together with distance piece. The space now left by the distance piece will allow the wheel to be drawn off the driving studs in sprocket. The whole operation should not take more than 30 to 40 seconds.

To replace the wheel, push it squarely on to the driving studs and *not* (with the distance piece in position) screw up the centre pin moderately tight.

The three sleeve nuts can now be screwed up *tightly*, afterwards giving a final turn to the centre pin. It is very important to

DETACHABLE WHEELS.—continued.

When replacing the chain it will facilitate the fitting of spring link if the ends of the chain are encircling an equal portion of the sprocket. This also applies to removing the spring link.

When the wheel is replaced, see that the brake anchor pin is screwed into the slot in anchor plate and the spindle nuts are tight.

The back wheel of model G5, E5 1925 and B5 1922-24 is not fitted with our patent quick detachable system, the wheel and driving sprocket being bolted together permanently. To remove the wheel it is necessary to detach the rear portion of the chain cover by unfastening the chain stay fixing; remove the brake drum anchor-pin, and disconnect the yoke end of the brake pedal rod. Next unfasten the chain by means of the spring clip coupling, finally slackening off the spindle nuts on either side of the fork ends, when the wheel can be dropped out in the usual way.

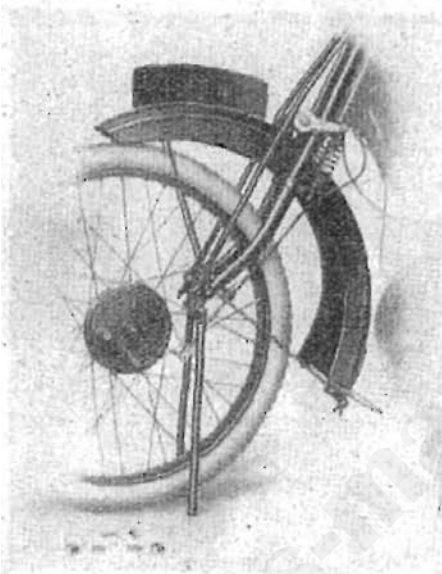
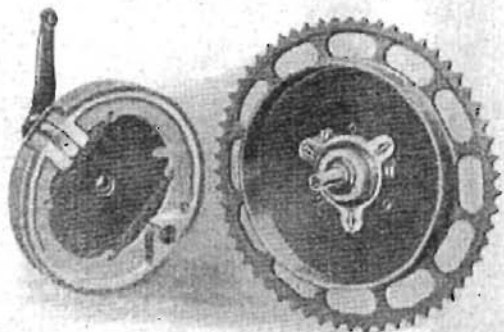

Illustration showing the front wheel removed, of Models H3, H4 and H5.

This brake requires no attention except occasional adjustment at the rear end of operating rod.

Illustration R,



Removing Front Wheel.—Disconnect cable yoke end from brake operating lever, remove anchor plate bolt from fork end and after slackening off spindle nuts the wheel will then fall out of slots in fork ends.

The adjustment of the hub bearings is perfectly obvious. Both wheels are disc-adjusting. Don't let the hubs run loosely, but take care that they are not adjusted too tightly.

This is a common cause of broken balls and cracked ball races. When properly adjusted, the weight of tyre valve should revolve the wheel, if placed above the centre of wheel. At the same time the wheel should have no shake.

METHOD OF REPLACING FOOTSTARTER SPRING.

1. Hook free end of Spring over Top Spoke of Footstarter Quadrant.

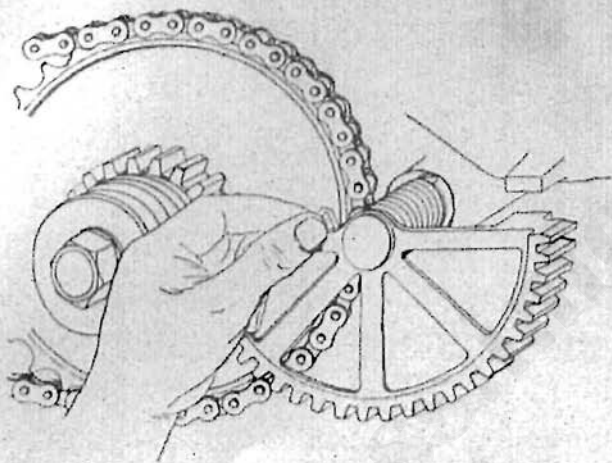

2. Turn Quadrant a complete Revolution in Direction of Arrow.

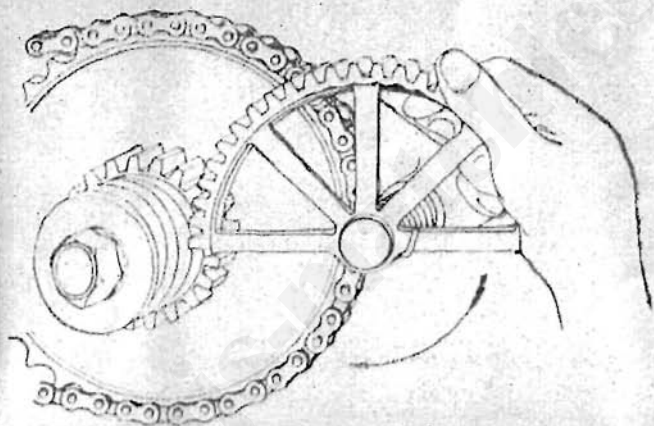

3. Push Quadrant into position, at the same time pressing with both thumbs the outer coils of the Spring down and over Footstarter Shaft Tube.

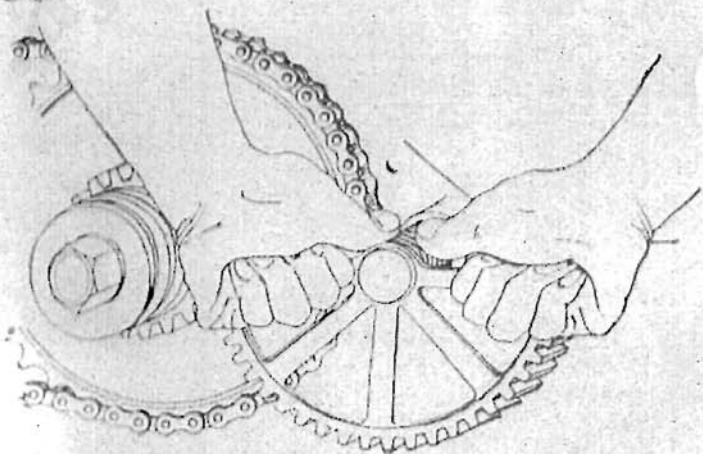

GENERAL.

Remember you have a bicycle as well as a power plant. Frequently oil the links of spring fork. Periodically put oil in the hubs or fill with Price's Hub Lubricant "Stiff." Oil occasionally any little moving parts about the machine, such as brake shackles, Bowden levers, joints of control rods, change speed lever, gear box clutch lever, etc. An oil gun is a most useful accessory. A charge of oil can be drawn out of the oil tank and used for lubricating every part of the machine.

Keep the machine clean. If mud, etc., is allowed to accumulate, it will work into bearings, especially the hubs, and cause undue wear. Do not wash the machine down with a hose-pipe. By so doing it is easy to get water in the petrol tank or carburettor, and cause trouble. Remove mud by means of a sponge and a bucket of water.

Pack tools tightly in the tool case with cleaning cloths, and so prevent them rattling about. Treat spare parts the same. The pannier bags can be used for carrying spare tubes if they are carefully and tightly packed, but it means certain destruction if they are not.

Keep the back tyre fully inflated, but not board hard. It is not necessary to have the front tyre inflated as hard as the back.

Do not fit all-steel studded tyres. They are positively dangerous on granite sets or tramlines, especially if wet.

It is not necessary to carry a load of spare parts with the machine. The only parts that may be required under ordinary conditions are:—

One spare valve complete with spring, washer and cotter, a good substantial tyre repair outfit, one each spring link and half link for chains, two good sparking plugs, an inside plaster for tyre in case of a bad cut or burst, and a good supply of observant common-sense.

For very long journeys or an extended tour it is wise to carry (in addition to the above) a spare front chain complete with spring link.

Any further information required we shall only be too happy to give if communicated with direct, but it will save unnecessary correspondence if our patrons will ascertain first that the information is not already given in this booklet.

"SAFETY FIRST" HINTS.

Never drive faster than you can pull up in the distance you can see.

Never attempt to overtake another vehicle on a blind corner.

Always keep closely to your right side of the road when taking a blind corner.

If the machine will not comfortably climb a hill on high gear it is no disgrace to change down, and besides it is faster to do so.



