

**aprilia**

**1312 5**

12/2005-00

**Pegaso 650 Strada - Trail**

[www.serviceaprilia.com](http://www.serviceaprilia.com)

**workshop** manual



8140963

INTRODUCTION

**SUMMARY**

0.1. INTRODUCTION ..... 3  
0.1.1. FOREWORD ..... 3  
0.1.2. REFERENCE MANUALS ..... 4  
0.1.3. ABBREVIATIONS/SYMBOLS/CONVENTIONS ..... 5

## 0.1. INTRODUCTION

### 0.1.1. FOREWORD

This manual provides the information required for normal servicing.

This publication is intended for use by **aprilia** Dealers and their qualified mechanics; many concepts have been omitted on purpose as their inclusion would be superfluous. Since complete mechanical explanations have not been included in this manual, the reader must be familiar with basic notions of mechanics, as well as with basic repair procedures. Without such familiarity, repairs and checks could be ineffective and even hazardous. Since the repair and vehicle check instructions are not exhaustive, special care must be taken to avoid damage and injury. To ensure maximum customer satisfaction with the vehicle, **aprilia s.p.a.** continuously improves its products and their documentation. The main technical modifications and changes in repair procedures are communicated to all **aprilia** dealers and agencies worldwide. Such modifications will be entered in subsequent editions of the manual. Should you need assistance or clarifications about the inspection and repair procedures, please contact the **aprilia** SERVICE DEPT., they will be glad to give you any information on the matter, or supply you with any detail on updates and technical changes applied to the vehicle.

**aprilia s.p.a.** reserves the right to make changes to its products at any time, barring any such changes as may alter the essential features of a product as specified in the relevant manual.

All rights of storage using electronic means, reproduction and total or partial adaptation, whatever the means adopted, are reserved in all countries.

Third parties' products are only mentioned for information purposes, and constitute no engagement.

**aprilia s.p.a.** is not liable in any way for the performance or use of these products.

First edition: December 2005

Produced and printed by:

**VALLEY FORGE DECA**  
Ravenna, Modena, Turin

**DECA s.r.l.**  
via Vincenzo Giardini, 11  
48022 Lugo (RA) - Italy  
Tel. +39 - 0545 216611  
Fax +39 - 0545 216610  
E-mail: [deca@vftis.spx.com](mailto:deca@vftis.spx.com)  
[www.vftis.com](http://www.vftis.com)

on behalf of:

**aprilia s.p.a.**  
via G. Galilei, 1  
30033 Noale (VE) - Italy  
Tel. +39 – (0)41 58 29 111  
Fax +39 – (0)41 58 29 190  
[www.aprilia.com](http://www.aprilia.com)  
[www.serviceaprilia.com](http://www.serviceaprilia.com)

0.1.2. REFERENCE MANUALS

PEGASO 650 STRADA

PEGASO 650 TRAIL

OWNER'S MANUALS

OWNER'S MANUALS

| aprilia part# (description) | I  | F  | D  |
|-----------------------------|----|----|----|
| 8104896                     | I  | F  | D  |
| 8104895                     | P  | E  | UK |
| 8104897                     | ML | DK | SF |
| 8104894                     | DK | J  | UK |

| aprilia part# (description) | I  | F  | D  |
|-----------------------------|----|----|----|
| 8104937                     | I  | F  | D  |
| 8104936                     | P  | E  | UK |
| 8104938                     | ML | DK | SF |
| 8104942                     | DK | J  | UK |

CHASSIS WORKSHOP MANUAL

CHASSIS WORKSHOP MANUAL

| aprilia part# (description) | I  |
|-----------------------------|----|
| 8140874                     | I  |
| 8140877                     | E  |
| 8140875                     | F  |
| 8140876                     | D  |
| 8140878                     | UK |

| aprilia part# (description) | I  |
|-----------------------------|----|
| 8140959                     | I  |
| 8140962                     | E  |
| 8140960                     | F  |
| 8140961                     | D  |
| 8140963                     | UK |

ENGINE TECHNICAL MANUAL

ENGINE TECHNICAL MANUAL

| aprilia part# (description) | I  |
|-----------------------------|----|
| 8140880                     | I  |
| 8140883                     | E  |
| 8140881                     | F  |
| 8140882                     | D  |
| 8140884                     | UK |

| aprilia part# (description) | I  |
|-----------------------------|----|
| 8140880                     | I  |
| 8140883                     | E  |
| 8140881                     | F  |
| 8140882                     | D  |
| 8140884                     | UK |

CD FOR THE NETWORK - ENGINE

CD FOR THE NETWORK - ENGINE

| aprilia part# (description) | I | E | F | D | UK |
|-----------------------------|---|---|---|---|----|
| 8CM0086                     | I | E | F | D | UK |

| aprilia part# (description) | I | E | F | D | UK |
|-----------------------------|---|---|---|---|----|
| 8CM0086                     | I | E | F | D | UK |

CD FOR THE NETWORK - CHASSIS

CD FOR THE NETWORK - CHASSIS

| aprilia part# (description) | I | E | F | D | UK |
|-----------------------------|---|---|---|---|----|
| 8CM0084                     | I | E | F | D | UK |

| aprilia part# (description) | I | E | F | D | UK |
|-----------------------------|---|---|---|---|----|
| 8CM0097                     | I | E | F | D | UK |

**0.1.3. ABBREVIATIONS/SYMBOLS/CONVENTIONS**

|                 |   |
|-----------------|---|
| <b>#</b>        | = number  |
| <b>&lt;</b>     | = less than   |
| <b>&gt;</b>     | = greater than  |
| <b>≤</b>        | = less than or equal to                                 |
| <b>≥</b>        | = more than or equal to                                 |
| <b>~</b>        | = approximately   |
| <b>∞</b>        | = infinity  |
| <b>°C</b>       | = degrees Celsius (centigrade)                          |
| <b>°F</b>       | = degrees Fahrenheit                                    |
| <b>±</b>        | = plus or minus   |
| <b>a.c</b>      | = alternating current                                   |
| <b>A</b>        | = Ampere  |
| <b>Ah</b>       | = Ampere per hour                                       |
| <b>API</b>      | = American Petroleum Institute                          |
| <b>AT</b>       | = high voltage  |
| <b>AV/DC</b>    | = Anti-Vibration Double Countershaft                    |
| <b>bar</b>      | = pressure measurement unit (1 bar = 100 kPa)           |
| <b>d.c.</b>     | = direct current  |
| <b>cc</b>       | = cubic centimetres                                     |
| <b>CO</b>       | = carbon monoxide                                       |
| <b>CPU</b>      | = Central Processing Unit                               |
| <b>DIN</b>      | = German industrial standards (Deutsche Industrie Norm) |
| <b>DOHC</b>     | = Double Overhead Camshaft                              |
| <b>ECU</b>      | = Electronic Control Unit                               |
| <b>rpm</b>      | = revolutions per minute                                |
| <b>HC</b>       | = unburnt hydrocarbons                                  |
| <b>ISC</b>      | = Idle Speed Control                                    |
| <b>ISO</b>      | = International Standardisation Organisation            |
| <b>kg</b>       | = kilograms   |
| <b>kgm</b>      | = kilograms per metre (1 kgm = 10 Nm)                   |
| <b>km</b>       | = kilometres  |
| <b>km/h</b>     | = kilometres per hour                                   |
| <b>kΩ</b>       | = kilo Ohm  |
| <b>kPa</b>      | = kiloPascal (1 kPa = 0.01 bar)                         |
| <b>KS</b>       | = clutch side (from the German "Kupplungsseite")        |
| <b>kW</b>       | = kilowatt  |
| <b>ℓ</b>        | = litres  |
| <b>LAP</b>      | = racetrack lap   |
| <b>LED</b>      | = Light Emitting Diode                                  |
| <b>LEFT</b>     |   |
| <b>SIDE</b>     | = left side   |
| <b>m/s</b>      | = metres per second                                     |
| <b>max</b>      | = maximum   |
| <b>mbar</b>     | = millibar (1 mbar = 0.1 kPa)                           |
| <b>mi</b>       | = miles   |
| <b>MIN</b>      | = minimum   |
| <b>MPH</b>      | = miles per hour  |
| <b>MS</b>       | = flywheel side (from the German "Magnetoseite")        |
| <b>MΩ</b>       | = MegaOhm   |
| <b>N.A.</b>     | = Not Available   |
| <b>N.O.M.M.</b> | = Motor Octane Number                                   |
| <b>N.O.R.M.</b> | = Research Octane Number                                |
| <b>Nm</b>       | = Newton metre (1 Nm = 0.1 kgm)                         |
| <b>Ω</b>        | = ohm   |
| <b>PICK-UP</b>  | = pick-up   |
| <b>BDC</b>      | = Bottom Dead Centre                                    |
| <b>TDC</b>      | = Top Dead Centre                                       |
| <b>PPC</b>      | = Pneumatic Power Clutch                                |

|                 |                                   |
|-----------------|-----------------------------------|
| <b>RIGHT</b>    |                                   |
| <b>SIDE</b>     | = right side                      |
| <b>SAE</b>      | = Society of Automotive Engineers |
| <b>TEST</b>     | = diagnostic check                |
| <b>T.B.E.I.</b> | = crown-head Allen screw          |
| <b>T.C.E.I.</b> | = cheese-head Allen screw         |
| <b>T.E.</b>     | = hexagonal head                  |
| <b>T.P.</b>     | = flat head screw                 |
| <b>TSI</b>      | = Twin Spark Ignition             |
| <b>UPSIDE-</b>  |                                   |
| <b>DOWN</b>     | = inverted fork                   |
| <b>V</b>        | = volt                            |
| <b>W</b>        | = watt                            |
| <b>Ø</b>        | = diameter                        |

GENERAL INFORMATION

1



SUMMARY

1.1. STRUCTURE OF THE MANUAL..... 3  
1.1.1. CONVENTIONS USED IN THE MANUAL ..... 3  
1.1.2. SAFETY WARNINGS..... 4  
1.2. GENERAL RULES..... 5  
1.2.1. BASIC SAFETY RULES..... 5  
1.3. DANGEROUS ELEMENTS ..... 8  
1.3.1. WARNINGS ..... 8  
1.4. RUNNING-IN ..... 12  
1.4.1. RUNNING-IN..... 12  
1.5. VEHICLE IDENTIFICATION ..... 13  
1.5.1. POSITION OF THE SERIAL NUMBERS ..... 13

## 1.1. STRUCTURE OF THE MANUAL

### 1.1.1. CONVENTIONS USED IN THE MANUAL

- This manual is divided in sections and subsections, each covering a set of the most significant components. Refer to the index of sections when consulting the manual.
- Unless expressly specified otherwise, assemblies are reassembled by reversing the dismantling procedure.
- The terms "right" and "left" are referred to the rider seated on the vehicle in the normal riding position.
- Motorcycle operation and basic maintenance are covered in the "OWNER'S MANUAL".

In this manual any variants are identified with these symbols:

 optional

 catalytic version

- all versions









MP national certification

SF European certification (EURO 2 limits)

Strada Pegaso 650 Strada

Trail Pegaso 650 Trail

### VERSION:

|  |   |  |
|--|---|--|
|  Italy          |  Greece        |  Malaysia                   |
|  United Kingdom |  Holland       |  Chile                      |
|  Austria       |  Switzerland  |  Croatia                   |
|  Portugal     |  Denmark     |  Australia                |
|  Finland      |  Japan       |  United States of America |
|  Belgium      |  Singapore   |  Brazil                   |
|  Germany      |  Slovenia    |  South Africa             |
|  France       |  Israel      |  New Zealand              |
|  Spain        |  South Korea |  Canada                   |

**1.1.2. SAFETY WARNINGS**

The following precautionary warnings are used throughout this manual in order to convey the following messages:



**Safety warning.** This symbol appears, whether in the manual or on the vehicle itself, to indicate a personal injury hazard. Non-compliance with the indications given in the messages preceded by this symbol may result in serious risks for your and other people's safety and for the vehicle!

**DANGER**

Indicates a potential hazard which may result in serious injury or even death.

**WARNING**

Indicates a potential hazard which may result in minor personal injury or damage to the vehicle.

**NOTE** The word "NOTE" in this manual precedes important information or instructions.

## 1.2. GENERAL RULES

### 1.2.1. BASIC SAFETY RULES

#### CARBON MONOXIDE

Should it be necessary to perform some operations with the vehicle running, make sure to work outdoors or in a well-aerated room.

Avoid starting the engine indoors.

In case you are working indoors, use a gas exhaust system.



#### DANGER

Exhaust gases contain carbon monoxide, which is extremely toxic if inhaled and may cause loss of consciousness or even lead to death.

#### FUEL



#### DANGER

The fuel used in internal combustion engines is highly flammable and can become explosive under particular conditions.

Refuelling and engine service should take place in a well-ventilated area with the engine stopped. Do not smoke when refuelling or in the proximity of sources of fuel vapours, avoid flames, sparks and any element that could ignite fuel or provoke explosions.

**DO NOT DISPOSE OF FUEL IN THE ENVIRONMENT.**

**KEEP AWAY FROM CHILDREN.**

#### HIGH-TEMPERATURE COMPONENTS

The engine and the components of the exhaust system become very hot and remain hot for some time after the engine has been stopped.

Before handling these components, wear insulating gloves or wait until the engine and the exhaust system have cooled down.

#### USED GEARBOX AND FORK FLUIDS



#### DANGER

Wear latex gloves when servicing.

Gear fluid may cause serious damage to the skin if handled daily and for long periods.

Wash your hands carefully after handling engine oil.

Take it to the filling station where you usually buy it or to an oil salvage centre.

Wear latex gloves when servicing.

**DO NOT DISPOSE OF FLUID IN THE ENVIRONMENT**

**KEEP AWAY FROM CHILDREN.**

#### BRAKE FLUID



#### WARNING

When handling the brake fluid, take care not to spill it on the plastic, rubber or painted parts, since it can damage them. When carrying out the maintenance operations on the braking system, use a clean cloth to cover these parts.

Always wear safety goggles when working on the braking system.

The brake fluid is highly irritant. Avoid contact with your eyes.

If the brake fluid gets in contact with your eyes, carefully wash them with fresh water and immediately seek medical advice.

**KEEP AWAY FROM CHILDREN.**

#### COOLANT

Coolant contains ethylene glycol that is flammable, under certain conditions. When ignited, ethylene glycol produces invisible flames that might cause burns.

**DANGER**

Take care not to spill coolant onto hot engine parts and exhaust system. It may ignite and produce invisible flames.

Wear latex gloves when servicing.

Although toxic, it has a sweet taste that might attract animals. Never leave coolant in open container or in a position easily reachable by animals.

**KEEP AWAY FROM CHILDREN.**

Do not remove radiator cap when engine is still hot. Coolant is under pressure and might cause burns.

**HYDROGEN GAS AND BATTERY ELECTROLYTE****DANGER**

The battery electrolyte is a toxic, caustic substance containing sulphuric acid and thus able to cause severe burns in case of contact with the skin.

Always wear tight gloves and protective clothes when handling this fluid.

In case of contact with skin, rinse with plenty of fresh water.

Always use a protection for your eyes since even a very small amount of the battery fluid can cause blindness. In the event of contact with your eyes, carefully wash them with water for fifteen minutes and then consult immediately an eye specialist.

Should you accidentally drink some fluid, drink abundant water or milk, then drink magnesia milk or vegetable oil and immediately seek medical advice.

The battery gives off explosive gases and must be kept away from flames and sources of ignition or heat; do not smoke near the battery.

**KEEP AWAY FROM CHILDREN.**

Battery fluid is corrosive.

Do not spill it, especially on plastic parts.

Make sure that the electrolyte acid is suitable for the type of battery used.

**GENERAL PRECAUTIONS AND INFORMATION**

Follow these instructions closely when repairing, disassembling or reassembling the motorcycle or its components.

**DANGER**

Using bare flames is strictly forbidden when working on the motorcycle. Before servicing or inspecting the motorcycle: stop the engine and remove the key from the ignition switch; allow for the engine and exhaust system to cool down; where possible, lift the motorcycle using adequate equipment placed on firm and level ground. Be careful of any parts of the engine or exhaust system which may still be hot to the touch to avoid scalds or burns.

Do not put any vehicle parts into your mouth: vehicle components are not edible and some of them are harmful or even toxic.

Unless expressly specified otherwise, assemblies are reassembled by reversing the dismantling procedure. Where a procedure is cross-referred to relevant sections in the manual, proceed sensibly to avoid disturbing any parts unless strictly necessary. Do not polish matt-painted surfaces with polishing paste.

Never use fuel instead of solvent to clean the motorcycle.

Do not clean any rubber or plastic parts or the seat with alcohol, petrol or solvents. Clean with water and mild detergent.

Always disconnect the battery negative (-) lead before soldering any electrical components.

When two or more persons service the same motorcycle together, special care must be taken to avoid personal injury.

**BEFORE DISASSEMBLING ANY COMPONENTS**

- Clean off all dirt, mud, and dust and clear any foreign objects from the vehicle before disassembling any components.
- Use the model-specific special tools where specified.

### DISASSEMBLING THE COMPONENTS

- Never use pliers or similar tools to slacken and/or tighten nuts and bolts. Always use the suitable spanner.
- Mark all connections (hoses, wiring, etc.) with their positions before disconnecting them. Identify each connection using a distinctive symbol or convention.
- Mark each part clearly to avoid confusion when refitting.
- Thoroughly clean and wash any components you have removed using a detergent with low flash point.
- Mated parts should always be refitted together. These parts will have seated themselves against one another in service as a result of normal wear and tear and should never be mixed up with other similar parts on refitting.
- Certain components are matched-pair parts and should always be replaced as a set.
- Keep away from heat sources.

### REASSEMBLING THE COMPONENTS



#### DANGER

**Never reuse a circlip or snap ring. These parts must always be renewed once they have been disturbed.**

**When fitting a new circlip or snap ring, take care to move the open ends apart just enough to allow fitment to the shaft.**

**Make it a rule to check that a newly-fitted circlip or snap ring has located fully into its groove.**

**Never clean a bearing with compressed air.**

**NOTE** All bearings must rotate freely with no hard spots or noise. Replace any bearings that do not meet these requirements.

- Use ORIGINAL **aprilia** SPARE PARTS only.
- Use the specified lubricants and consumables.
- Where possible, lubricate a part before assembly.
- When tightening nuts and bolts, start with the largest or innermost nut/bolt and observe a cross pattern. Tighten evenly, in subsequent steps until achieving the specified torque.
- Replace any self-locking nuts, gaskets, seals, circlips or snap rings, O-rings, split pins, bolts and screws which have a damaged thread.
- Lubricate the bearings abundantly before assembly.
- Make it a rule to check that all components you have fitted are correctly in place.
- After repairing the motorcycle and after each service inspection, perform the preliminary checks, and then test ride the motorcycle in a private estate area or in a safe area away from traffic.
- Clean all mating surfaces, oil seal edges and gaskets before assembly. Apply a thin layer of lithium grease along the edges of oil seals. Fit oil seals and bearings with the marking or serial number facing outwards (in view).

### ELECTRICAL CONNECTORS

To disconnect the electrical connectors, follow the procedures below. Failure to comply with these procedures may lead to irreparable damage to the connector and the wiring as well.

If present, press the special safety hooks.



#### WARNING

**Do not pull cables to disconnect the two connectors.**

- Grasp the two connectors and disconnect them by pulling them in the two opposite directions.
- In case of dirt, rust, moisture, etc., thoroughly clean the inside of the connectors with compressed air.
- Make sure that the cables are correctly fitted inside the connector terminals.

**NOTE** The two connectors have just one correct positioning. Make sure to position them in the right direction.

- Then fit the two connectors. Make sure they are correctly coupled (a click will be heard if hooks are present).

### TIGHTENING TORQUE SETTINGS



#### DANGER

**Always remember that the tightening torque settings of all wheel, brake, wheel shaft and other suspension parts play a fundamental role to ensure vehicle safety. Make sure that these values are always within the specified limits.**

**Check fastening parts tightening torque settings at regular intervals. Upon reassembly, always use a torque wrench.**

**Failure to comply with these recommendations could lead to the loosening and detachment of one of these parts with a consequent locking of the wheel or other serious troubles affecting the vehicle manoeuvrability, and thus the risk of falls and serious injuries or death.**

### 1.3. DANGEROUS ELEMENTS

#### 1.3.1. WARNINGS

##### FUEL

**DANGER**

The fuel used to operate engines is highly flammable and becomes explosive under particular conditions.

Refuelling and engine service should take place in a well-ventilated area with the engine stopped.

Do not smoke when refuelling or in the proximity of sources of fuel vapours, avoid flames, sparks and any element that could ignite fuel or provoke explosions.

Take care not to spill fuel out of the filler, or it may ignite when in contact with hot engine parts.

In the event of accidental fuel spillage, make sure the affected area is fully dry before starting the engine. Fuel expands from heat and when left under direct sunlight.

Never fill the fuel tank up to the brim. Tighten the filler cap securely after each refuelling.

Avoid contact with skin. Do not inhale vapours. Do not swallow fuel. Do not transfer fuel between different containers using a hose.

**DO NOT DISPOSE OF FUEL IN THE ENVIRONMENT.**

**KEEP AWAY FROM CHILDREN.**

Use only premium grade unleaded petrol, min. O.N. 95 (RON) and 85 (MON).

##### LUBRICANTS

**DANGER**

A good lubrication ensures the vehicle safety.

Failure to keep the lubricants at the recommended level or the use of a non-suitable new and clean type of lubricant can lead to the engine or gearbox seizure, thus causing serious accidents, personal injury or even death.

Gear fluid may cause serious damage to the skin if handled daily and for long periods.

Wash your hands carefully after use.

Do not dispose of oil in the environment.

Take it to the filling station where you usually buy it or to an oil salvage centre.

**WARNING**

When filling the vehicle with this oil, take care not to spill it out. Immediately clean spilt oil, or it might damage the vehicle paintwork.

In case of contact with oil, the tyres surface will become very slippery, thus becoming a serious danger for your safety.

In case of leaks, do not use the vehicle. Check and trace the cause of leaks and proceed to repair.

##### ENGINE OIL

**DANGER**

Engine oil may cause serious damage to the skin if handled daily and for long periods.

Wash your hands carefully after use.

Do not dispose of oil in the environment.

Dispose of engine oil through the nearest waste oil reclamation firm or through the supplier.

Wear latex gloves when servicing.

##### FRONT FORK FLUID

**DANGER**

Front suspension response can be modified to a certain extent by changing damping settings and/or selecting a particular grade of oil. Standard oil viscosity: SAE 20 W. Different oil grades can be selected to obtain a particular suspension response (choose SAE 5W for a softer suspension, 20W for a stiffer suspension).

The two grades can also be mixed in varying solutions to obtain the desired response.

**BRAKE FLUID**

**NOTE** This vehicle is fitted with front and rear disc brakes. Each braking system is operated by an independent hydraulic circuit. The information provided below applies to both braking systems.

**DANGER**

Do not use the vehicle in case brakes are worn out or do not work properly. The brakes are the parts that most ensure your safety and for this reason they must always be perfectly working. Failure to comply with these recommendations will probably lead to a crash or an accident, with a consequent risk of personal injury or death.

A wet surface reduces brakes efficiency.

**DANGER**

In case of wet ground the braking distance will be doubled, since both brakes and tyre grip on the road surface are extremely reduced by the water present on the road surface.

Any water on brakes, after washing the vehicle or driving on a wet road surface or crossing puddles or gips, can wet brakes so as to greatly reduce their efficiency.

Failure to comply with these recommendations may lead to serious accidents, with a consequent risk of severe personal injuries or death.

Brakes are critical safety components. Do not ride the vehicle in case brakes are not working at their best.

Check for brakes proper operation before every trip.

Brake fluid is an irritant. Avoid contact with eyes or skin.

In the event of accidental contact, wash affected body parts thoroughly. In the event of accidental contact with eyes, contact an eye specialist or seek medical advice.

**DO NOT RELEASE BRAKE FLUID INTO THE ENVIRONMENT.**

**KEEP AWAY FROM CHILDREN.**

When handling brake fluid, take care not to spill it onto plastic or paint-finished parts or they will damage.

**DANGER**

Do not use any brake fluids other than the specified type. Never mix different types of fluids to top up level, as this will damage the braking system.

Do not use brake fluid from containers which have been kept open or in storage for long periods.

Any sudden changes in play or hardness in the brake levers are warning signs of problems with the hydraulic circuits.

Ensure that the brake discs and brake linings have not become contaminated with oil or grease. This is particularly important after servicing or inspections.

Make sure the brake lines are not twisted or worn.

Prevent accidental entering of water or dust into the circuit.

Wear latex gloves when servicing the hydraulic circuit.

**DISC BRAKES****DANGER**

The brakes are the parts that most ensure your safety and for this reason they must always be perfectly working; check them before every trip.

A dirty disc soils the pads.

Dirty pads must be replaced, while dirty discs must be cleaned with a high-quality degreaser.

Perform the maintenance operations with half the indicated frequency if the vehicle is used in rainy or dusty areas, on uneven surfaces or for racing.

Check brake pads for wear.

When the brake pads wear out, the level of the fluid decreases to automatically compensate for their wear.

The front brake fluid reservoir is located on the right handlebar, near the front brake lever.

The rear brake fluid reservoir is located under the right fairing.

Do not use the vehicle if the braking system leaks fluid.



## COOLANT

**DANGER**

Coolant is toxic when ingested, contact with eyes or skin may cause irritation. In the event of contact with your skin or eyes, rinse repeatedly with abundant water and seek medical advice. In the event of ingestion, induce vomiting, rinse mouth and throat with abundant water and seek medical advice immediately.  
**DO NOT RELEASE INTO THE ENVIRONMENT.**  
**KEEP AWAY FROM CHILDREN.**

**DANGER**

Take care not to spill coolant onto hot engine parts. It may ignite and produce invisible flames. Wear latex gloves when servicing.  
**Do not ride when coolant is below the minimum level.**

Coolant mixture is a 50% solution of water and antifreeze. This is the ideal solution for most operating temperatures and provides good corrosion protection.

This solution is also suited to the warm season, as it is less prone to evaporative loss and will reduce the need for top-ups.

In addition, less water evaporation means fewer minerals salts depositing in the radiator, which helps preserve the efficiency of the cooling system.

When the temperature drops below zero degrees centigrade, check the cooling system frequently and add more antifreeze (up to 60% maximum) to the solution, if needed.

Use distilled water in the coolant mixture. Tap water will damage the engine.

Refer to the chart given below and add water with the quantity of antifreeze to obtain a solution with the desired freezing point:

| Freezing point °C (°F) | Coolant % of volume |
|------------------------|---------------------|
| -20°C (-4°F)           | 35                  |
| -30°C (-22°F)          | 45                  |
| -40°C (-40°F)          | 55                  |

**NOTE** Coolants have different specifications. The protection degree is written on the label.

**WARNING**

Use nitrite-free coolant only, with a protection until at least -35°C.

## DRIVE CHAIN

Check drive chain operation, wear, slack and lubrication at regular intervals.

The vehicle is equipped with an endless chain with a joint link.

**WARNING**

If too slack, the chain can come off the front or rear sprockets thus leading to serious accidents and damage to the vehicle, with consequent serious personal injury or death.

Do not use the vehicle if the chain slack has not been correctly adjusted.

To check the chain, take it with your hand where it turns on the rear sprocket and pull it as to separate it from the sprocket itself.

If you can move the chain apart of the front sprocket for more than 3 mm (0.125 in), change chain, front and rear sprocket.

**DANGER**

If not properly maintained, chain can early wear out and lead to the damage of both front and rear sprockets.

Perform chain maintenance operations more frequently if the vehicle is used on dusty or muddy areas.

## TYRES

**WARNING**

If tyres are excessively inflated, the vehicle will be hard, difficult and uncomfortable to ride. In addition, the roadworthiness, mainly on wet surfaces and during cornering, will be impaired. Flat tyres (insufficient pressure) can slip on the rim and make you lose the control of the vehicle. In this case too, both vehicle roadworthiness, manoeuvrability and brake efficiency will be impaired. Tyres changing, repair, maintenance and balancing must be carried out by specialized technicians using suitable equipment. When new, tyres can have a thin slippery protective coating. Drive carefully for the first kilometres (miles). Never use rubber treating substances on tyres. In particular, avoid contact with fluid fuels, leading to a rapid wear. In case of contact with oil or fuel, do not clean but change the tyres.

**DANGER**

Some of the factory-assembled tyres of this vehicle are provided with wear indicators. There are several kinds of wear indicators. For more information on how to check the wear, contact your Dealer. Visually check if the tyres are worn and in this case have them changed. If a tyre deflates while driving, stop immediately. Avoid hard brakings or moves and do not close throttles too abruptly. Slowly close the throttle grip, move to the edge of the road and use the engine brake to slow down until coming to a halt. Failure to comply with these recommendations may lead to accidents, with a consequent risk of personal injuries or death. Do not install tyres with air tube on rims for tubeless tyres and vice versa.

## 1.4. RUNNING-IN

### 1.4.1. RUNNING-IN

Correct engine running-in is essential to ensuring proper performance and durability.

If possible, drive on hilly roads and/or roads with many bends, so that the engine, the suspensions and the brakes undergo a more effective running-in.

During running-in, change speed.

In this way the components are first "loaded" and then "relieved" and the engine parts can thus cool down.

Even if it is important to stress the engine components during running-in, take care not to exceed.



#### WARNING

**Only after the first 2000 km (1250 mi) of running-in is it possible to obtain the best acceleration performance from the vehicle.**

Keep to the following indications:

- Do not open the throttle completely if the speed is low, both during and after running-in.
- During the first 500 km (312 mi) pull the brakes with caution, avoiding sharp and prolonged brakings. This ensures a correct bedding-in of the pads on the brake discs.
- During the first 500 km (312 mi), never exceed 4000 rpm (see table).
- From 500 km (312 mi) up to 1000 km (625 mi), never exceed 5000 rpm.



#### DANGER

**After the first 1000 km (621 mi), have the checking operations indicated in the column "After running-in" carried out by an aprilia Authorised Dealer, see REGULAR SERVICE INTERVALS CHART, in order to avoid hurting yourself or other people and/or damaging the vehicle.**

- Between the first 1000 km (625 mi) and 2000 km (1250 mi) drive more briskly, change speed and use the maximum acceleration only for a few seconds, in order to ensure better coupling of the components; never exceed 5500 rpm (see table).
- After 2000 km (1250 mi) you can squeeze some more power out of your engine.

| Recommended maximum rpm |      |
|-------------------------|------|
| Mileage Km (mi)         | rpm  |
| 0-500 (0 - 312)         | 4000 |
| 500-1000 (312-625)      | 5000 |
| 1000 – 2000 (625-1250)  | 5500 |

## 1.5. VEHICLE IDENTIFICATION

### 1.5.1. POSITION OF THE SERIAL NUMBERS

These numbers are necessary for vehicle registration.

**NOTE** *Altering the vehicle identification numbers is a legal offence. Altering the frame number invalidates the warranty.*

#### FRAME NUMBER

The frame number (A) is stamped on the right side of the steering column.



#### ENGINE NUMBER

The engine number (B) is stamped on the rear right part, near the starter motor.



GENERAL TECHNICAL INFORMATION 2

**SUMMARY**

|        |   |    |
|--------|---|----|
| 2.1.   | GENERAL TECHNICAL INFORMATION .....     | 3  |
| 2.1.1. | TECHNICAL DATA .....                    | 3  |
| 2.1.2. | REGULAR SERVICE INTERVALS CHART .....   | 5  |
| 2.1.3. | LUBRICANT TABLE.....                    | 7  |
| 2.1.4. | TIGHTENING TORQUES .....                | 8  |
| 2.1.5. | SPECIAL TOOLS .....                     | 11 |
| 2.1.6. | LOCATION OF KEY COMPONENTS .....        | 12 |
| 2.1.7. | INSTRUMENT PANEL OPERATION.....         | 16 |
| 2.2.   | SCHEDULED MAINTENANCE.....              | 37 |
| 2.2.1. | CHANGING ENGINE OIL AND OIL FILTER..... | 37 |
| 2.2.2. | CLEANING THE AIR FILTER .....           | 39 |
| 2.2.3. | CHANGING THE COOLANT .....              | 40 |
| 2.2.4. | FRONT BRAKE.....                        | 41 |
| 2.2.5. | REAR BRAKE .....                        | 43 |
| 2.2.6. | ADJUSTING THE VALVE CLEARANCE .....     | 45 |

## 2.1. GENERAL TECHNICAL INFORMATION

## 2.1.1. TECHNICAL DATA

| DIMENSIONS  |   |
|---|---|
| Max. length Strada / Trail                            | 2173 mm /2232 mm (85.55 in /87.87 in).  |
| Max. width Strada / Trail                             | 810 mm /820 mm (31.89 in /32.28 in).    |
| Max. height (at the headlight fairing) Strada / Trail | 1150 mm /1180 mm (45.27 in /46.45 in).  |
| Seat height Strada / Trail                            | 780 mm /810 mm (30.71 in /31.89 in).    |
| Wheel base Strada / Trail                             | 1490 mm /1510 mm (58.66 in /59.44 in).  |
| Minimum ground clearance Strada / Trail               | 200 mm /230 mm (7.87 in /9.05 in).      |
| Dry weight Strada / Trail                             | 179 kg / 183 kg (394.72 lb / 403.44 lb) |

| ENGINE              |   |
|---------------------|---|
| Model               | MY 660  |
| Type                | one-cylinder, 4-stroke with 4 valves per cylinder, single overhead camshaft     |
| Number of cylinders | 1   |
| Total displacement  | 660 cu. cm (40.27 cu in).   |
| Bore/stroke         | 100 mm /84 mm (3.93 in /3.31 in).   |
| Compression ratio   | 10.0 ± 0.5: 1   |
| Starting            | Electric starter  |
| Engine idling speed | 1500 ± 100 rpm  |
| Clutch              | Multiplate, wet clutch with hydraulic control on the left side of the handlebar |
| Lubricating system  | dry pan with separate oil tank  |
| Air filter          | with dry filter cartridge   |
| Cooling             | Liquid  |

| TRANSMISSION |  |
|--------------|--|
| Type         | mechanical, 5 gears with foot control on the left side of the engine |

| CAPACITY                |   |
|-------------------------|---|
| Fuel (reserve included) | 15 ± 0.5l (27.24 ±0.91 pt)  |
| Fuel reserve            | 3l (5.45 pt)  |
| Engine oil              | engine oil change 2500 cu.cm (152.66 cu in)<br>engine oil and oil filter change 2700 cu.cm (164.76 cu in) |
| Fork oil Strada         | 105 mm (4.13 in) of air (per leg, measured without spring and with the leg fully compressed)              |
| Fork oil Trail          | 570 cu.cm (34.78 cu in) per leg   |
| Coolant                 | 1.2 l (2.18 pt) (50% water + 50% coolant with ethylene glycol)  |
| Seats                   | 2   |
| Vehicle max. load       | 210 kg (462.98 in) (rider + passenger + luggage + fluids)   |

| GEAR RATIOS |                  |                  |                  |             |
|-------------|------------------|------------------|------------------|-------------|
| Ratio       | Primary          | Secondary        | Final ratio      | Total ratio |
| 1st         | 36/75 = 1: 2.083 | 12/30 = 1: 2.500 | 15/44 = 1: 2.933 | 1 : 15.278  |
| 2nd         |                  | 16/26 = 1: 1.625 |                  | 1 : 9.930   |
| 3rd         |                  | 20/23 = 1: 1.150 |                  | 1 : 7.028   |
| 4th         |                  | 22/20 = 1: 0.909 |                  | 1 : 5.556   |
| 5th         |                  | 26/20 = 1: 0.769 |                  | 1 : 4.700   |

| DRIVE CHAIN |   |
|-------------|---|
| Type        | endless (with no master link) with sealed links |

| FUEL SYSTEM |                      |
|-------------|----------------------|
| Type        | Electronic injection |
| Throttle    | Ø 45.5 mm (1.79 in)  |

| FUEL SYSTEM |   |
|-------------|---|
| Fuel        | premium grade unleaded petrol, min. O.N. 95 (RON) and 85 (MON). |

| FRAME |  |
|-------|--|
| Type  | with steel composite structure with seat support that can be removed |

| <b>SUSPENSIONS</b>          |   |
|-----------------------------|---|
| Front                       | hydraulic telescopic fork, Ø 45 mm (1.77 in) legs |
| Wheel travel Strada / Trail | 140 mm (5.51 in) / 170 mm (6.69 in)               |
| Rear                        | swinging arm and hydraulic adjustable monoshock   |
| Wheel travel Strada / Trail | 130 mm (5.12 in) / 170 mm (6.69 in)               |

| <b>BRAKES</b>        |  |
|----------------------|--|
| Front Strada / Trail | disc brake – Ø 320 mm (12.60 in) / 300 mm (11.81 in), with hydraulic control |
| Rear                 | disc brake – Ø 240 mm (9.45 in), with hydraulic control                      |

| <b>WHEEL RIMS</b>    |                          |
|----------------------|--------------------------|
| Type Strada / Trail  | light alloy /with spokes |
| Front Strada / Trail | 3.50 x 17" / 2.15 x 19"  |
| Rear Strada / Trail  | 4.50 x 17" / 3.00 x 17"  |

| <b>FRONT TYRE</b>                                       |  |
|---|--|
| Type Strada   | 110/70 ZR 17 54 W                                    |
| As an alternative, Strada                               | 110/70 R 17 54H – 120/65 ZR 17 56W – 120/65 R 17 56H |
| Type Trail  | 110/90 M/C 19 57H                                    |
| Inflating pressure (rider only) Strada / Trail          | 180 kPa (1.8 bar) / 190 kPa (1.9 bar)                |
| Inflating pressure (rider and passenger) Strada / Trail | 190 kPa (1.9 bar) / 190 kPa (1.9 bar)                |

| <b>REAR TYRE</b>  |  |
|---|--|
| Type Strada   | 160/60 ZR 17 69W                                     |
| As an alternative, Strada                               | 160/60 R 17 69H – 150/60 ZR 17 66W – 150/60 R 17 66H |
| Type Trail  | 130/80 M/C R 17 65H                                  |
| As an alternative, Trail                                | 140/80 M/C R 17 69H                                  |
| Inflating pressure (rider only) Strada / Trail          | 200 kPa (2.0 bar) / 210 kPa (2.1 bar)                |
| Inflating pressure (rider and passenger) Strada / Trail | 220 kPa (2.2 bar) / 230 kPa (2.3 bar)                |

| <b>IGNITION</b> |                                   |
|-----------------|-----------------------------------|
| Type            | DENSO - inductive ignition system |

| <b>SPARK PLUGS</b>       |                                    |
|--------------------------|------------------------------------|
| Standard                 | NGK CR7E                           |
| Spark plug electrode gap | 0.7 - 0.8 mm (0.028 in – 0.031 in) |
| Resistance               | 5 KΩ                               |

| <b>ELECTRIC SYSTEM</b>            |                 |
|-----------------------------------|-----------------|
| Battery                           | 12 V - 12 Ah    |
| Auxiliary fuses                   | 5 A, 15 A, 20 A |
| Generator (with permanent magnet) | 12 V – 290 W    |

| <b>BULBS</b>                  |                 |
|-------------------------------|-----------------|
| Low beam                      | 12 V – 55 W     |
| High beam                     | 12 V – 60 W     |
| Front parking light           | 12 V – 3 W      |
| Turn indicator light          | With microbulbs |
| Number plate light            | 12 V – 5 W      |
| Rear parking lights/Stoplight | LED             |
| Revolution counter            | LED             |

| <b>WARNING LIGHTS</b> |     |
|-----------------------|-----|
| Neutral               | LED |
| Direction indicators  | LED |
| Fuel reserve          | LED |
| High beam             | LED |
| Alarm                 | LED |
| Side stand            | LED |
| ABS                   | LED |
| Heated handgrips      | LED |



### 2.1.2. REGULAR SERVICE INTERVALS CHART

OPERATIONS TO BE CARRIED OUT BY THE **aprilia** Authorised Dealer (WHICH CAN BE CARRIED OUT EVEN BY THE USER).

#### Key

- 1 = check and clean, adjust, lubricate or change, if necessary;
- 2 = clean;
- 3 = change;
- 4 = adjust.

(\*) = Check every two weeks or according to the intervals indicated.

(\*\*) = OPT (as standard in the countries where required)

CO = carbon monoxide

**NOTE** Carry out the maintenance operations halving the intervals indicated, if the vehicle is used in rainy or dusty areas or on uneven surfaces, or in competitions.

| Component  | After running-in<br>[1000 km (625 mi)]  | Every 10000 km<br>(6250 mi) or 12<br>months         | Every 20000 km<br>(12500 mi) or 24<br>months |
|--|---|---|--|
| Battery - Clamp tightening                                       | 1                                       | 1   | -  |
| Spark plug   | -                                       | 1   | 3  |
| Fork   | 1                                       | -   | 1  |
| Light operation/direction  | -                                       | 1   | -  |
| Light system   | 1                                       | 1   | -  |
| Safety switches  |   |   |  |
| Brake fluid  | 1                                       | 1   | -  |
| Coolant  | -                                       | -   | 1  |
| Side panniers coupling pins<br>(**)                              |   | 1   |  |
| Tyres  | every 1000 km (625 mi): 1               |   |  |
| Tyre pressure *  | every 1000 km (625 mi): 4               |   |  |
| Engine idling rpm and CO   | 4                                       | 4   | -  |
| Securing locks for the side<br>panniers and the top case<br>(**) | -                                       | 1   | -  |
| Alarm warning light  | at every start: 1                       |   |  |
| Cush drive dampers and<br>sliding roller                         | upon each final transmission change : 3 |   |  |
| Timing belt lubrication and<br>tensioning                        | every 500 km (375 mi): 1                |   |  |
| Brake pads wear  | 1                                       | before every trip and every 2000 km<br>(1250 mi): 1 |  |
| Flexible coupling wear and<br>flexible coupling unit slack       | -                                       | -   | 1  |



#### WARNING

Have the final drive checked (rear, front sprockets and chain) every 5000 km (3125 mi) by an **aprilia** Authorised Dealer.

OPERATIONS TO BE CARRIED OUT BY THE **aprilia** Authorised Dealer.

**Key**

- 1 = check and clean, adjust, lubricate or change, if necessary (follow Workshop Manual specifications);
- 2 = clean;
- 3 = change;
- 4 = adjust.

(\*) = Check every two weeks or according to the intervals indicated.



























(\*\*) = OPT (as standard in the countries where required)

CO = carbon monoxide

**NOTE** Carry out the maintenance operations halving the intervals indicated, if the vehicle is used in rainy or dusty areas or on uneven surfaces, or in competitions.

| Component  | After running-in<br>[1000 km (625 mi)]  | Every 10000 km<br>(6250 mi) or 12<br>months | Every 20000 km<br>(12500 mi) or 24<br>months |
|--|---|---|--|
| Rear shock absorber  | -   | -   | 1  |
| Battery - Clamp tightening                                   | 1   | -   | -  |
| Carburetion, CO adjustment                                   | 1   | 1   | -  |
| Timing chain   | -   | 1   | -  |
| Transmission cables and controls                             | 1   | 1   | -  |
| Wheel truing   | -   | 1   | -  |
| Rear suspension linkage bearings                             | -   | -   | 1  |
| Steering bearings and steering clearance                     | 1   | 1   | -  |
| Wheel bearings   | -   | 1   | -  |
| Brake discs  | 1   | 1   | -  |
| Fuel pump filter   | -   | -   | 1  |
| Air filter   | -   | 1   | 3  |
| Engine oil filter  | 3   | 3   | -  |
| Engine oil filter (on oil tank)                              | 2   | -   | 2  |
| General running of the vehicle                               | 1   | 1   | -  |
| Clutch clearance   | 4   | 4   | -  |
| Adjusting the valve clearance                                | 4   | -   | 4  |
| Braking systems  | 1   | 1   | -  |
| Cooling system   | -   | 1   | -  |
| Brake fluid  | every 24 months: 3  |   |  |
| Coolant  | every 24 months: 3  |   |  |
| Fork oil   | -   | -   | 3  |
| Engine oil   | 3   | 3 (*)                                       | -  |
| Fork oil seals   | after the first 30000 km (18650 mi) and successively every 20000 km (12500 mi): 3 |   |  |
| Brake pads   | if worn: 3  |   |  |
| Adjusting the valve clearance                                | 4   | -   | 4  |
| Wheels/tyres (*)   | 1   | 1   | -  |
| Nut, bolt, screw tightening                                  |   |   | -  |
| Suspensions and track alignment                              | 1   | -   | 1  |
| Spoke tension  | 1   | 1   | -  |
| Final transmission (chain, rear sprocket and front sprocket) | every 5000 km (3125 mi): 1  |   |  |
| Fuel pipes   | -   | 1   | every 4 years: 3                             |
| Clutch wear  | -   | 1   | -  |

## 2.1.3. LUBRICANT TABLE

| LUBRICANT                             | PRODUCT   |
|---------------------------------------|---|
| Engine oil                            | <p>RECOMMENDED:  EXTRARIDE 4, SAE 15W – 50 or  GEAR SYNTH, SAE 75W - 90.</p> <p>As an alternative to recommended oils, top brand oils meeting or exceeding CCMC G-4, A.P.I. SG specifications can be used.</p>  |
| Fork oil                              | <p>RECOMMENDED:  F.A. 5W.  F.A. 20W; as an alternative  FORK 5W or  FORK 20W.</p> <p>When you wish to obtain an intermediate response between those offered by  F.A. 5W and  F.A. 20W oils or  FORK 5W or  FORK 20W, you may mix the different products as follows:</p> <p>SAE 10W =  F.A. 5W 67% of volume, +  F.A. 20W 33% of volume,  FORK 5W 67% del volume +  FORK 20W 33% of volume.</p> <p>SAE 15W =  F.A. 5W 33% of volume, +  F.A. 20W 67% of volume,  FORK 5W 33% of volume +  FORK 20W 67% of volume.</p> |
| Bearings and other lubrication points | <p>RECOMMENDED:  AUTOGREASE MP or  GREASE 30.</p> <p>As an alternative to recommended grease, use top brand rolling bearing grease that will resist a temperature range of -30 °C to +140 °C (-22 °F to +284 °F), with dripping point 150 °C to 230 °C (302 °F to 446 °F), high corrosion protection, good resistance to water and oxidisation.</p>   |
| Battery lead protection               | Use neutral grease or Vaseline.   |
| Chains                                | RECOMMENDED spray grease:  CHAIN SPRAY or  CHAIN LUBE.   |
| Brake fluid                           | <p>RECOMMENDED:  F.F. DOT 4 (the braking system is also compatible with DOT 5);  BRAKE 5.1, DOT 4 (the braking system is also compatible with DOT 5).</p> <p><b>NOTE</b> Use new brake fluid only. Do not mix different makes or types of oil without having checked bases compatibility.</p>   |
| Engine coolant                        | <p>RECOMMENDED:  ECOBLU – 40° C (- 40°F) or  COOL.</p> <p><b>NOTE</b> Use only nitrite-free antifreeze and corrosion inhibitors with a freezing point of - 35°C (- 31°F) as a minimum.</p>  |

## 2.1.4. TIGHTENING TORQUES

| DESCRIPTION                           | QUANTITY | SCREW / NUT | TIGHTENING TORQUES(Nm) | NOTES       |
|---------------------------------------|----------|-------------|------------------------|-------------|
| <b>HANDLEBAR AND CONTROLS</b>         |          |             |                        |             |
| counterweight                         | 1+1      | M6          | 10                     | loctite 243 |
| handlebar and clamps                  | 4        | M8          | 25                     | Manual      |
| front brake master cylinder           | 2        | M6          | 12                     | -           |
| <b>ELECTRIC SYSTEM</b>                |          |             |                        |             |
| battery bracket                       | 1        | M5          | 3                      | -           |
| horn / horn mount                     | 1        | M6          | 12                     | -           |
| rear direction indicators             | 2        | M6          | 3                      | -           |
| voltage regulator                     | 2        | M6          | 12                     | loctite 243 |
| front direction indicators            | 2        | M6          | 3                      | -           |
| tail light fastener                   | 2        | M5          | 1                      | -           |
| ground fastener onto engine           | 1        | M6          | 15                     | -           |
| relay cable to starter motor fastener | 1        | M6          | 5                      | -           |
| cables to relay fastener              | 2        | M6          | 4                      | -           |
| <b>SEAT</b>                           |          |             |                        |             |
| hinge to seat fastener                | 4        | NUT M6      | 7±20%                  | -           |
| <b>LOCKS</b>                          |          |             |                        |             |
| rear lock                             | 2        | M6          | 10                     | -           |
| <b>FRAME</b>                          |          |             |                        |             |
| sump guard                            | 3        | M6          | 8                      | -           |
| voltage regulator support             | 2        | M6          | 12                     | loctite 243 |
| coils to frame                        | 2        | M5          | 6                      | loctite 243 |
| map sensor                            | 2        | M6          | 12                     | -           |
| seat support                          | 4        | M8          | 25                     | loctite 243 |
| cradle fastener onto frame            | 2        | M10         | 50                     | -           |
| <b>FUEL TANK</b>                      |          |             |                        |             |
| flange to tank                        | 6        | M5          | 6                      | -           |

| DESCRIPTION  | QUANTITY | SCREW / NUT | TIGHTENING TORQUES(Nm) | NOTES       |
|--|----------|-------------|------------------------|-------------|
| <b>CENTRE BODYWORK</b>                             |          |             |                        |             |
| radiator spoiler                                   | 3        | M6          | 5                      | -           |
| radiator cowling                                   | 4        | M6          | 3                      | -           |
| number plate holder to seat support lower cover    | 2        | M6          | 3                      | -           |
| cat's eye holder to number plate holder            | 2        | M5          | 6                      | -           |
| front mudguard                                     | 4        | M5          | 5                      | -           |
| rear mudguard                                      | 4        | M5          | 3                      | -           |
| front fairing to arch                              | 4        | M6          | 3                      | -           |
| inner conveyors to frame                           | 2        | M6          | 3                      | -           |
| external conveyors                                 | 4 and 2  | M5 AND M6   | 3 and 3                | Manual      |
| instrument panel fairing cover                     | 4        | M6          | 2                      | -           |
| lug  | 4        | M6          | 3                      | -           |
| fairing side support to frame                      | 4        | M6          | 10                     | loctite 243 |
| side fairings to fairing side support              | 6        | M5          | 5                      | -           |
| bush and seat support lower cover                  | 2        | M6          | 5                      | -           |
| seat support lower cover to seat support           | 4        | M6          | 4                      | -           |
| seat support lower cover to frame                  | 2        | M6          | 4                      | -           |
| tail guard to seat support lower cover             | 4        | M5          | 2                      | -           |
| tail guard front cover                             | 4        | M4          | 0,5                    | Manual      |
| tail guard to seat support                         | 4        | M5          | 3                      | -           |
| tail guard-passenger belt                          | 2        | M6          | 12                     | -           |
| under-seat side body panels                        | 2        | M6          | 7                      | -           |
| front fairing lower cover                          | 3        | M6          | 7                      | -           |
| windshield to front fairing                        | 6        | M4          | 0,5                    | Manual      |
| instrument panel to arch                           | 3        | M6          | 5                      | -           |
| <b>BRAKING SYSTEM</b>                              |          |             |                        |             |
| front brake calliper                               | 2        | M10X1.25    | 50                     | -           |
| rear brake lever pin                               | 1        | M8          | 20                     | -           |
| rear brake fluid tank                              | 1        | M5          | 6                      | -           |
| rear brake rod lock nut                            | 1        | M6          | Manual                 | -           |
| <b>COOLING SYSTEM</b>                              |          |             |                        |             |
| expansion tank + carbon protection to coil support | 2        | M5          | 6                      | -           |
| head pipe fastener onto radiator                   | 2        | -           | Manual                 | -           |
| <b>FRONT WHEEL</b>                                 |          |             |                        |             |
| wheel shaft nut                                    | 1        | -           | 80                     | -           |
| <b>EXHAUST</b>                                     |          |             |                        |             |
| muffler to seat support fastener                   | 1+1      | M8          | 25                     | -           |
| exhaust pipe clamps fastener                       | 2+1      | -           | 16                     | -           |
| exhaust pipes to engine fastener                   | 2+2      | M8          | 25                     | -           |
| <b>REAR WHEEL</b>                                  |          |             |                        |             |
| rear sprocket to sprocket holder fastener          | 5        | M10         | 50                     | -           |
| wheel shaft nut                                    | 1        | -           | 80                     | -           |

| DESCRIPTION  | QUANTITY | SCREW / NUT | TIGHTENING TORQUES(Nm) | NOTES       |
|--|----------|-------------|------------------------|-------------|
| <b>SIDE STAND</b>                                      |          |             |                        |             |
| side stand pin   | 1        | M10X1.25    | 10                     | loctite 243 |
| switch screw   | 1        | M6          | 10                     | -           |
| lock nut   | 1        | M10X1.25    | 30                     | loctite 243 |
| <b>ENGINE</b>  |          |             |                        |             |
| engine to cradle fastener                              | 2        | M10         | 50                     | -           |
| engine lower fastener                                  | 1        | M10         | 50                     | -           |
| engine upper fastener                                  | 1        | M10         | 50                     | -           |
| lower connection plate to frame fastener               | 2        | M10         | 50                     | -           |
| upper connection plates to frame fastener              | 2        | M10         | 50                     | -           |
| gear shift lever                                       | 1        | M6          | 10                     | -           |
| front sprocket case                                    | 2        | M6          | 10                     | -           |
| <b>REAR SUSPENSION</b>                                 |          |             |                        |             |
| shock absorber fastener onto frame                     | 1        | M10         | 50                     | loctite 243 |
| single connecting rod fastener onto frame              | 1        | M10         | 50                     | -           |
| single connecting rod / double connecting rod fastener | 1        | M10         | 50                     | -           |
| double connecting rod / swinging arm fastener          | 1        | M10         | 50                     | -           |
| double connecting rod / shock absorber fastener        | 1        | M10         | 50                     | -           |
| <b>SWINGING ARM</b>                                    |          |             |                        |             |
| swinging arm shaft ring nut                            | 1        | M17X1       | 35                     | -           |
| swinging arm shaft adj. bush                           | 1        | M25X1.5     | 12                     | -           |
| swinging arm shaft                                     | 1        | -           | 100                    | -           |
| shock absorber guard fastener                          | 2        | 4.8X13      | 20                     | -           |
| chain tensioner screw and nut                          | 1+1      | M8          | Man.                   | -           |
| chain slider fastener                                  | 1        | 4.8X13      | 20                     | -           |
| rear stand bush  | 1+1      | M6          | 12                     | -           |
| rear brake hose posit.plate fastener                   | 1        | M5          | 6                      | -           |
| chain guard fastener                                   | 2        | M5          | 6                      | -           |
| <b>FRONT SUSPENSION</b>                                |          |             |                        |             |
| fork leg fastener to top yoke                          | 1+1      | M8          | 25                     | -           |
| fork leg fastener to bottom yoke                       | 3+3      | M8          | 25                     | -           |
| steering tube ring nut                                 | 1        | M25X1.5     | 7                      | -           |
| top yoke plug  | 1        | M22X1       | 100                    | -           |
| fork hub plug  | 2+2      | M6          | 12                     | -           |
| cable guide for front brake line                       | 1        | M6          | 12                     | -           |
| stiffening plate                                       | 4        | M6X20       | 12                     | -           |
| <b>FOOTRESTS</b>                                       |          |             |                        |             |
| rider footrests to frame                               | 2+2      | M10         | 50                     | -           |
| rear footrests to seat support                         | 2+2      | M8          | 25                     | -           |

### 2.1.5. SPECIAL TOOLS

In order to perform assembly, reassembly and settings correctly, special tools suitable for the task must be used. The use of special tools avoids the potential risk of damage as a result of inappropriate tools and/or improvised methods.

The special tools developed specifically for this vehicle are listed below.

Ask for the general special tools, if necessary.

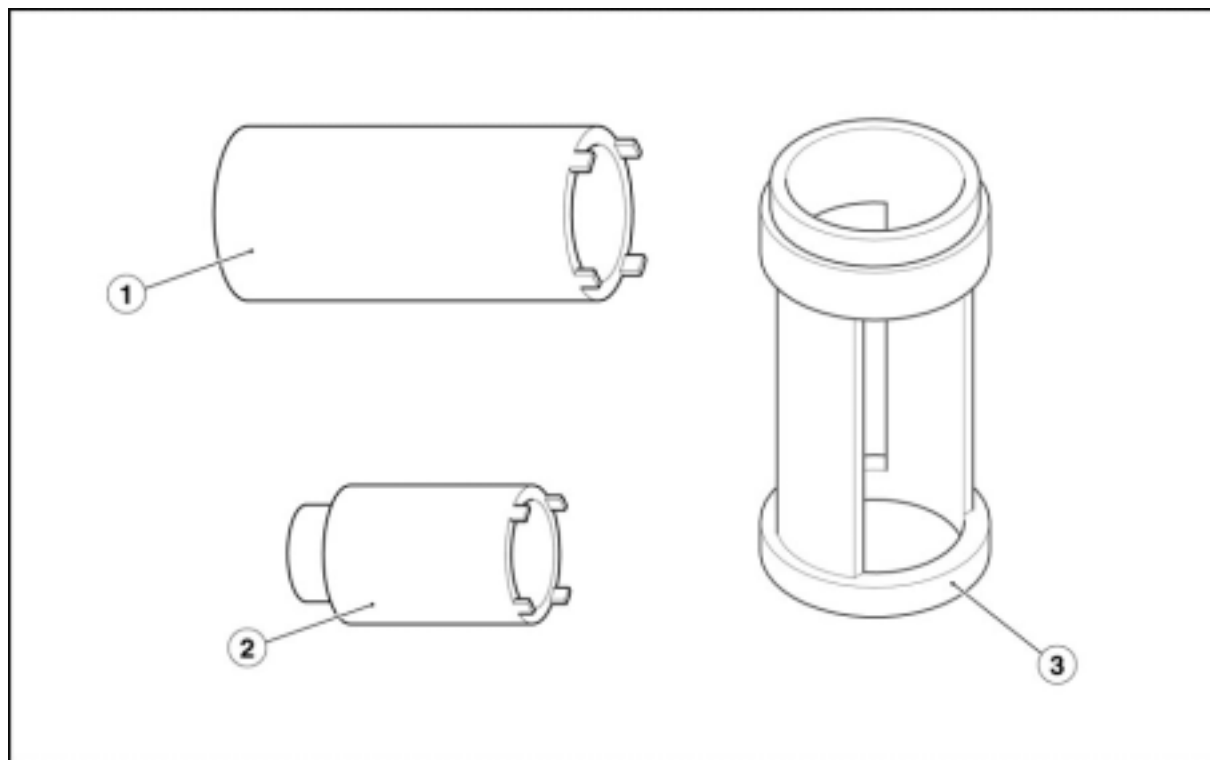

| Pos. | Description                          | Part number |
|------|--------------------------------------|-------------|
| 1    | Fork shaft ring nut                  | 8101945     |
| 2    | Fork tube ring nut                   | 8163500     |
| 3    | Tool to fit fork oil seal D.63 H.125 | 8140843     |

## 2.1.6. LOCATION OF KEY COMPONENTS

## PEGASO 650 STRADA

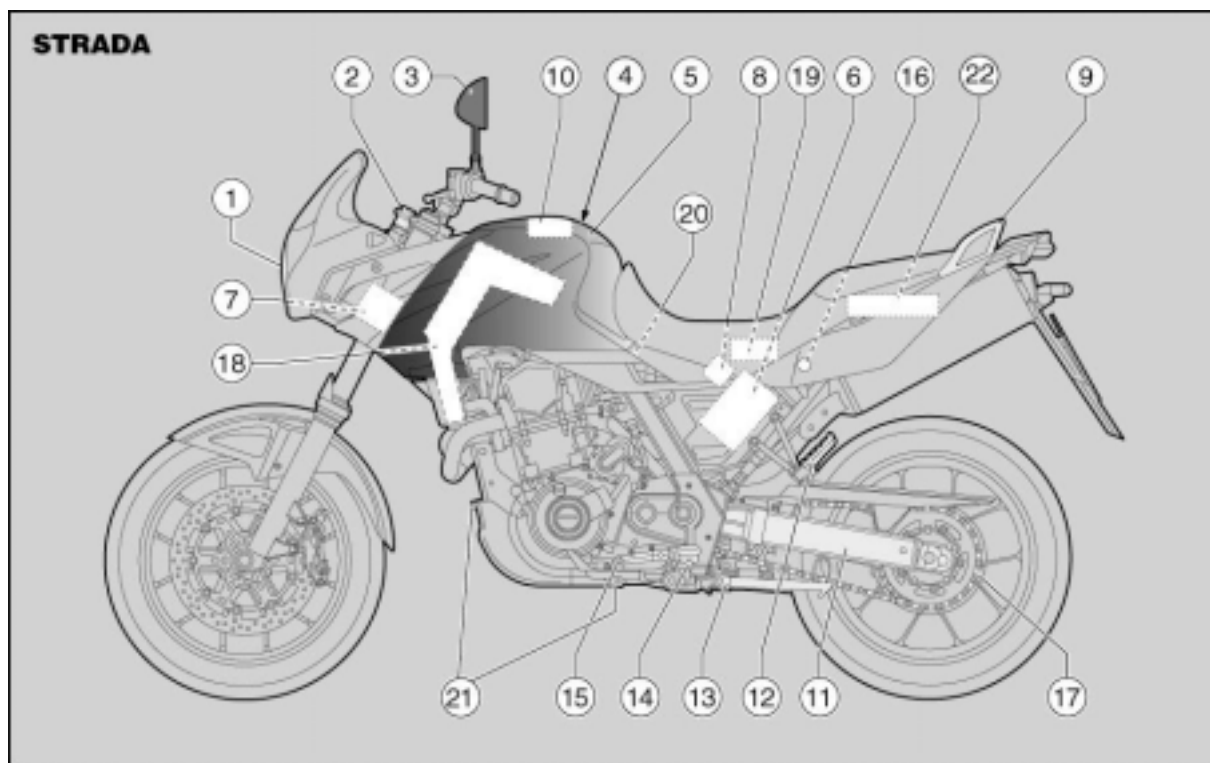

## KEY PEGASO 650 STRADA

1. Headlight
2. Ignition switch/steering lock
3. Left rear-view mirror
4. Fuel tank filler cap
5. Fuel tank
6. Battery
7. Electronic control unit
8. Fuse carrier
9. Passenger grab rail
10. Glove compartment
11. Swinging arm
12. Passenger left footrest (snapping, closed/open)
13. Side stand
14. Rider left footrest
15. Gear shift lever
16. Seat lock
17. Drive chain
18. Engine oil tank
19. Tool kit
20. Idle speed adjuster
21. Oil drain plugs
22. Underseat compartment



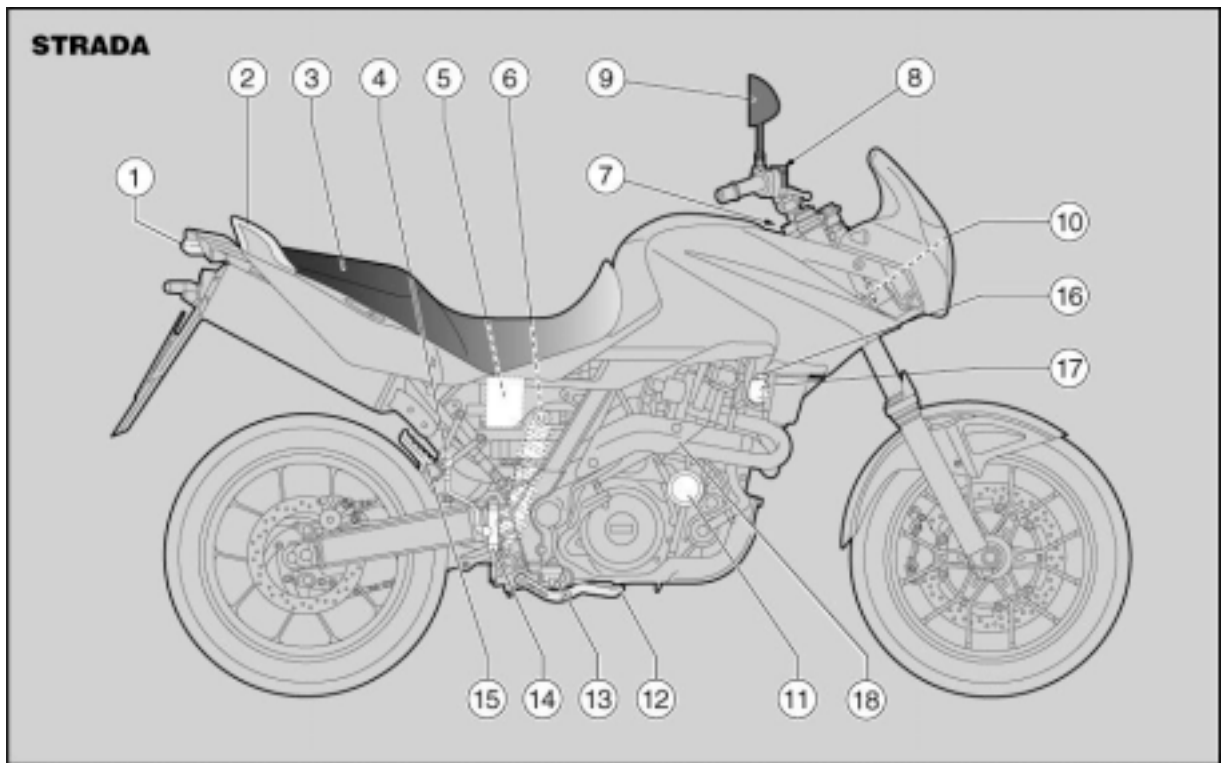

#### KEY PEGASO 650 STRADA

1. Tail light
2. Passenger grab rail
3. Seat
4. Rear brake fluid tank
5. Air filter
6. Rear shock absorber
7. Engine oil level plug-dipstick
8. Front brake fluid tank
9. Right rear-view mirror
10. Horn
11. Engine oil filter
12. Rear brake control lever
13. Rider right footrest
14. Rear brake master cylinder
15. Passenger right footrest (snapping, closed/open)
16. Coolant expansion tank cap
17. Coolant expansion tank
18. CO sensor plug

## PEGASO 650 TRAIL

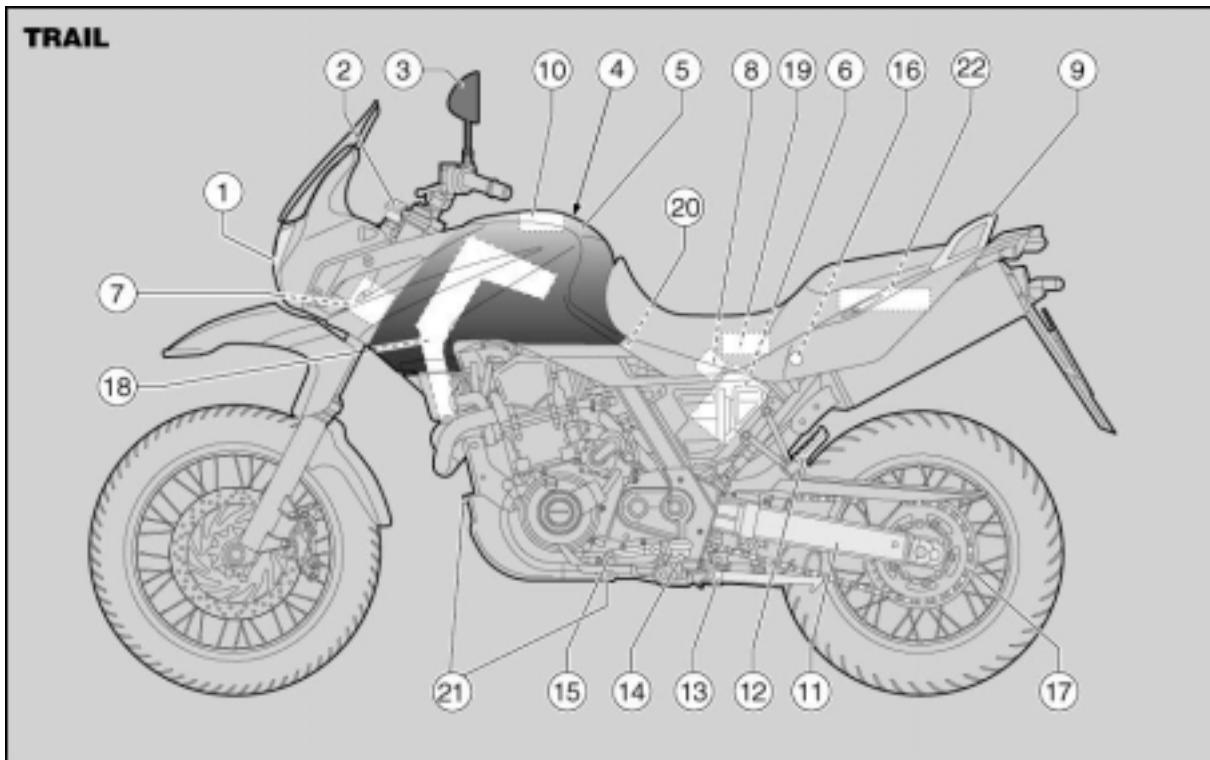

## KEY PEGASO 650 TRAIL

1. Headlight
2. Ignition switch/steering lock
3. Left rear-view mirror
4. Fuel tank filler cap
5. Fuel tank
6. Battery
7. Electronic control unit
8. Fuse carrier
9. Passenger grab rail
10. Glove compartment
11. Swinging arm
12. Passenger left footrest (snapping, closed/open)
13. Side stand
14. Rider left footrest
15. Gear shift lever
16. Seat lock
17. Drive chain
18. Engine oil tank
19. Tool kit
20. Idle speed adjuster
21. Oil drain plugs
22. Underseat compartment

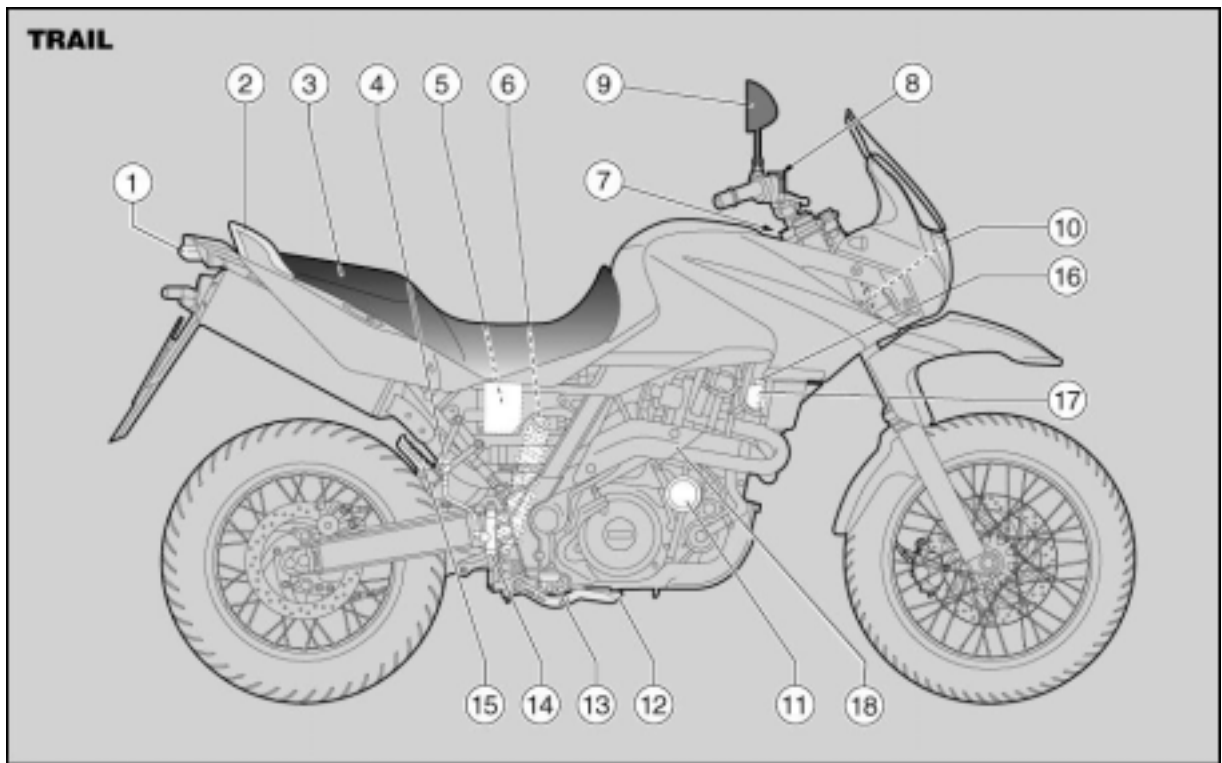

#### KEY PEGASO 650 TRAIL

1. Tail light
2. Passenger grab rail
3. Seat
4. Rear brake fluid tank
5. Air filter
6. Rear shock absorber
7. Engine oil level plug-dipstick
8. Front brake fluid tank
9. Right rear-view mirror
10. Horn
11. Engine oil filter
12. Rear brake control lever
13. Rider right footrest
14. Rear brake master cylinder
15. Passenger right footrest (snapping, closed/open)
16. Coolant expansion tank cap
17. Coolant expansion tank
18. CO sensor plug

**2.1.7. INSTRUMENT PANEL OPERATION**

When you turn the ignition key to "I", the following will turn on for two seconds on the instrument panel:

- The "PEGASO 650 STRADA" logo
- All lights, except "Heated handgrips light"
- Backlighting

Rev counter index (1) moves to maximum value, as set by the user.

During the initial check-up, all instruments will briefly show the current values of the corresponding parameters.

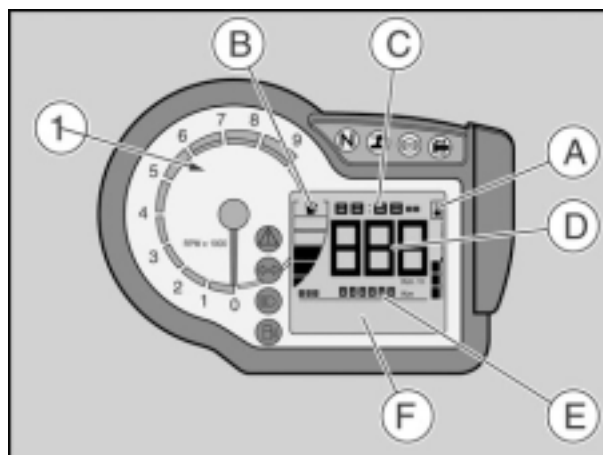

The display shows the following standard settings:

- A) coolant temperature;
- B) fuel quantity;
- C) clock;
- D) speedometer;
- E) odometer;
- F) on-board computer and accessories functions.

MODE selector (2) features three positions: a left one to decrease values and scroll the drop-down menus, a right one to increase values and scroll the drop-down menus in the other direction, and a centre one to confirm values by pressing the button.

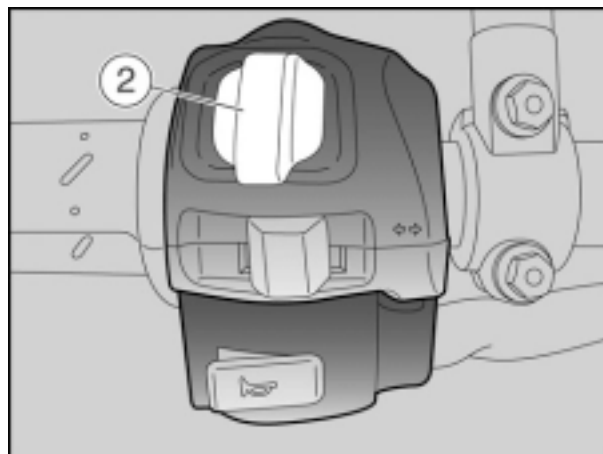

Turn selector (2) to display on the LCD the pages indicating in zone (F) the following quantities:

- A) TRIP METER 1
- B) TRIP TIME 1
- C) TRIP METER 2
- D) TRIP TIME 2
- E) MAXIMUM SPEED
- F) LAP TIMER
- G) BATTERY VOLTAGE
- H) KM COVERED W/FUEL RESERVE (distance covered on fuel reserve for trips longer than 2 km).

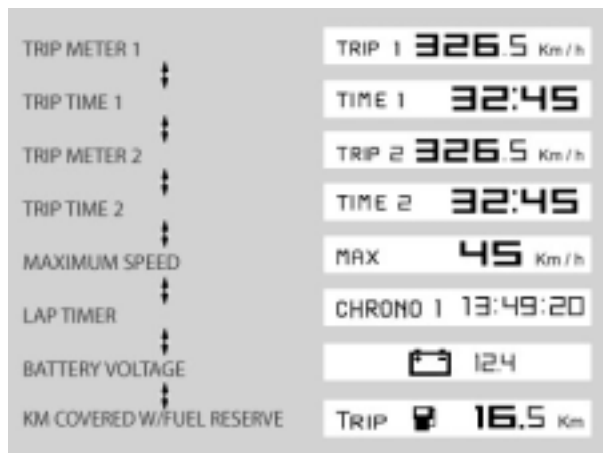

**PEGASO 650**

Trip meter 1 and 2 can be reset: press selector (2) for a certain time in the centre position to reset all quantities concerning the active trip meter.

After the distance covered on fuel reserve (KM COVERED W/FUEL RESERVE), the display shows the MENU page, but only if vehicle is not moving.

**MENU**

If vehicle is stopped, it is possible to gain access to the configuration menu from the MENU page by pressing the MODE selector in the centre position; while if vehicle is moving, go back to the TRIP METER 1 page.

Configuration menu options are:

- EXIT
- SETTINGS
- LAP TIMER
- DIAGNOSIS
- LANGUAGE

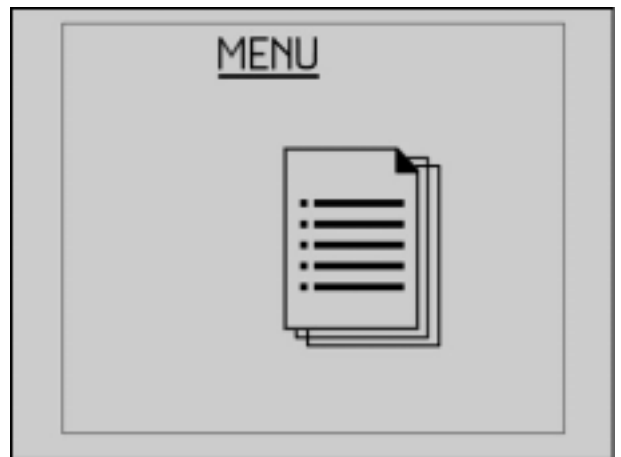
**SETTINGS**

When the SETTINGS function is selected the following options are displayed:

- EXIT
- TIME SETTINGS
- GEAR SHIFT INDICATOR
- BACK LIGHTING
- CHANGE THE CODE
- UNLOCK SAFETY LOCKS

Once the operation is over, the instrument panel goes back to main menu.

**TIME SETTINGS**

This mode allows you to set the clock.

The main page with "TIME SETTINGS" is displayed.

As soon as you enter this mode, indication of minutes disappears and only hours are displayed.

Value increases every time the MODE selector is pressed to the right, once the value reaches 12, it goes back to 0.

In the same way, value decreases every time the MODE selector is pressed to the left, once the value reaches zero, it goes to 59 when the MODE selector is again pressed to the left.

A Confirmation signal stores the set value and lets you quit clock setting mode.

As soon as you enter this mode, indication of hours disappears and only minutes are displayed.

Minutes value increases every time the MODE selector is pressed to the right, once the value reaches 59, it goes to 0 when the MODE selector is again pressed to the right.

In the same way, value decreases every time the MODE selector is pressed to the left, once the value reaches zero, it goes to 59 when the MODE selector is again pressed to the left.

A Confirmation signal stores the set value and lets you quit clock setting mode.

### GEAR SHIFT THRESHOLD

This function allows you to set the value for the Gear shift indicator threshold. The main page with "GEAR SHIFT THRESHOLD" message is displayed.

Threshold value is increased by 100 RPM every time the MODE selector is pressed to the right, vice versa, threshold value is decreased by 100 RPM every time the MODE selector is pressed to the left.

If the upper or lower limit is reached and you further press the selector, nothing will happen.

Press the MODE selector to the centre position to end the operation and store the set value, the index goes back to zero and the instrument panel goes back to configuration menu page.

When battery is connected for the first time, the instrument panel sets to running-in rpm value, the next time battery is connected it sets to last set value.

RUNNING-IN RPM: 5000  
MINIMUM RPM: 4000  
MAXIMUM RPM: 8000

When the set threshold is exceeded, the alarm light (3) on the instrument panel flashes until the value goes below the threshold.

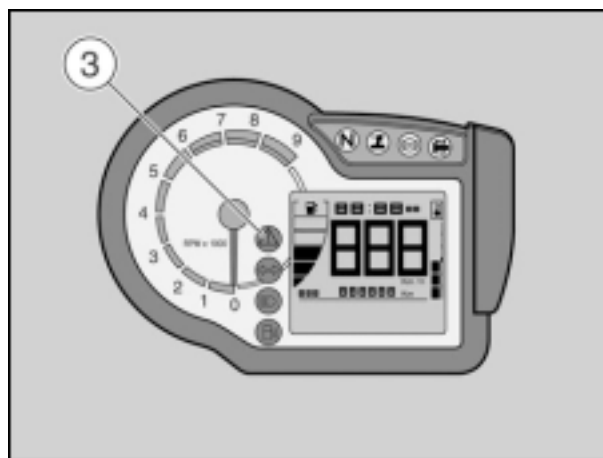

### BACK LIGHTING

This function allows you to set backlighting: three levels are available. Every time the MODE selector is pressed to the right or to the left, the following icons are displayed:

- LOW
- MEAN
- HIGH

Press the MODE selector to the centre position to set the instrument panel back to SETTINGS MENU.

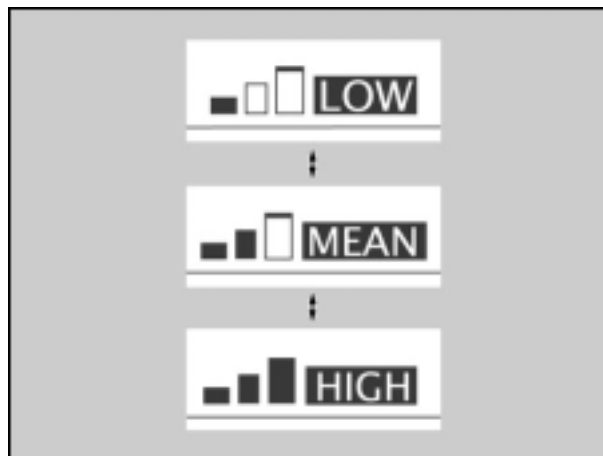

## PEGASO 650

**CHANGE THE CODE**

This function is used when the old CODE is available and you want to change it; in this case the instrument panel should be turned on using a stored key. The following message is first displayed:

Insert the old code

Once the code has been recognised, you are prompted to enter the new code:

Insert the new code

Once the operation is over, the instrument panel goes back to diagnosis menu. This operation is not allowed in case the user entered with the code.

Once the operation is over, the instrument panel goes back to settings menu.

This function is used when the old CODE is not available and you want to change it; in this case two stored keys should be inserted. The first one is already in and you will be prompted to insert the second key:

insert the II key

The instrument panel should not switch off in-between one key and the other, operation is aborted if the second is not inserted within 20 seconds. Once the key has been recognised, you are prompted to enter the new code:

Insert the new code

Once the operation is over, the instrument panel goes back to diagnosis menu. This operation is not allowed if the user entered with the code or only one key is stored.

Once the operation is over, the instrument panel goes back to settings menu.

**UNLOCK SAFETY LOCKS**

In case of failure to the stand sensor, the neutral and clutch switch, use function "UNLOCK SAFETY LOCKS" to disable the safety logic and be able to start the engine.

The display will show "SERVICE".

The safety logic is re-enabled when turning the key off.

**DANGER**

**This function should be used only in an emergency.**

**LAP TIMER**

When the LAP TIMER function is selected the following options are displayed:

- EXIT
- VIEW TIMES
- DELETE TIMES

**VIEW TIMES**

This function also displays the acquired lap times. Briefly press the MODE selector to the right and to the left to scroll the time pages, press it for a certain time to set the display back to the LAP TIMER menu. If the battery is disconnected, stored times are lost.

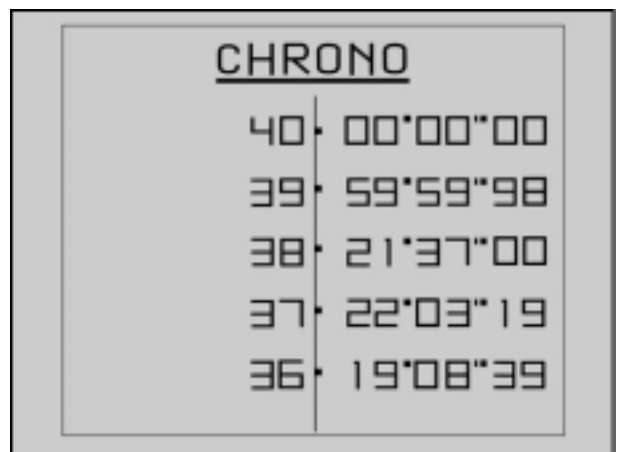

## DELETE TIMES

This function deletes the acquired lap times. Deletion should be confirmed. Once the operation is over, the display goes back to LAP TIMER menu.

### Operation

To use the lap timer, set the display to the main page indicating CHRONO. Briefly press the MODE selector to the centre position, the lap timer starts recording. Press again the MODE selector to the centre position before 10 seconds have elapsed from timer start, time measurement is cancelled and a new one is started.



Press again the MODE selector to the centre position after 10 seconds have elapsed from timer start, time measurement is interrupted, stored and a new one is started. Press the MODE selector for a certain time to the centre position to interrupt lap time set.

Once 40 lap times have been recorded, acquisition ends and "FULL" is displayed: stop the vehicle to read recorded lap times, enter VIEW TIMES option in the LAP TIMER menu. A new timer session can be started only if all previously recorded lap times are deleted: enter the DELETE TIMES function in the LAP TIMER menu.

## DIAGNOSIS

This menu interfaces with the systems fitted to the motorcycle to carry out diagnosis. To enable the menu, a password is needed that is available only to aprilia service centres.

- Insert the service code

It is a 5 digit code, for Pegaso the code is: 25973  
If code is wrong, appears the message:

- Incorrect code

The instrument panel goes back to main menu; if not, the menu appears:

- EXIT
- ECU ACTUATIONS
- ECU PARAMETERS
- ECU ERRORS
- DASHBOARD ERRORS
- DELETE ERRORS
- CO ADJUSTMENT
- SERVICE RESET
- DISCONNECT
- UPDATE
- UPDATE KEYS
- KM / MILES



**PEGASO 650**

Once the operation is over, the instrument panel goes back to main menu.

There are two types of ECU diagnosis, the passive one and the active one. During passive diagnosis, the user simply reads data from the ECU, such as: battery voltage, throttle opening angle, atmospheric pressure or error reading (current or stored). During active diagnosis, the ECU performs operations such as: generate 5 sparks or 5 fuel injections.

Parameters necessary for parameter reading are the following:

| Part number | Description            |
|-------------|------------------------|
| 01          | Throttle opening angle |
| 03          | Air intake pressure    |
| 05          | Air intake temperature |
| 06          | Water temperature      |
| 07          | Vehicle speed pulse    |
| 08          | Turnover sensor        |
| 09          | Fuel system voltage    |
| 20          | Side stand switch      |
| 21          | Neutral switch         |
| 70          | Program Ver. No.       |

Parameters necessary for actuations are the following:

| Part number | Description     |
|-------------|-----------------|
| 30          | Ignition coil   |
| 36          | Injector        |
| 48          | AIS solenoid    |
| 50          | Main relay      |
| 51          | Fan relay       |
| 52          | Headlight relay |

Errors: This page shows all present and/or stored errors

| Part number | Description       |
|-------------|-------------------|
| 60          | EEPROM Error      |
| 61          | Error FLAG Δ CODE |

Delete errors: this page allows you to delete stored errors.  
Deletion will be effective upon key OFF.

| Part number | Description             |
|-------------|-------------------------|
| 62          | Error FLAG Δ CODE clear |

### CU actuations

The following message is displayed:

- Turn the key to stop

Once the key is turned off, the following message is displayed:

- Set the key to run.

Set the ENGINE-ON switch to STOP.

Once the key is turned on, the following menu is displayed:

- EXIT
- COIL
- INJECTOR
- AIS SOLENOID
- INJECTION RELAY
- FANS
- LIGHTS

Turn the key to stop to quit, the following message will be displayed:

- Turn the key to stop to quit

- **Ignition coil**

The following message is displayed:

- Set the ENGINE-ON switch first to RUN and then to STOP.

The coil will be activated for 5 times.

- **Injector**

The following message is displayed:

- Set the ENGINE-ON switch first to RUN and then to STOP.

The injector will be activated for 5 times.

**PEGASO 650**

- **AIS solenoid**

The following message is displayed:

- Set the ENGINE-ON switch first to RUN and then to STOP.

The secondary air system solenoid valve will be activated for 5 times.

- **Injection relay**

The following message is displayed:

- Set the ENGINE-ON switch first to RUN and then to STOP.

The injection relay will be activated for 5 times.

- **Fans**

The following message is displayed:

- Set the ENGINE-ON switch first to RUN and then to STOP.

The fan piloting relay will be activated for 5 times.

- **Lights**

The following message is displayed:

- Set the ENGINE-ON switch first to RUN and then to STOP.

The lights relay will be activated for 5 times.

### ECU errors

This page displays both current (live) errors and stored ones.  
The following message is displayed:

- Turn the key to stop

Once the key is turned off, the following message is displayed:

- Turn the key to Drive

Once the key is turned on, the table of errors read by the ECU is displayed. Turn the key to stop to quit, the following message will be displayed:

- Turn the key to stop to quit

### ECU parameters

This page displays parameters read by the ECU. The following message is displayed:

- Turn the key to stop

Once the key is turned off, the following message is displayed:

- Turn the key to Drive

Once the key is turned on, the following table is displayed. Turn the key to stop to quit, the following message will be displayed:

- Turn the key to stop to quit

### CO adjustment

In this page the instrument panel increases or decreases the CO rate. Press the UP or DOWN buttons on the control switch to increase or decrease the value. The instrument panel should display the set value; the ECU shall store the set value upon key OFF.

At this stage, the rpm are displayed.

The following message is displayed:

- Turn the key to stop

Once the key is turned off, the following message is displayed:

- Turn the key to Drive

Once the key is turned on, the following message is displayed, while waiting for the connection with the ECU:

- Wait for the connection

Once connection is established, the following messages are displayed:

- Connection established

- Set value

- CO = □□□

- Turn the key to stop to set in memory and exit

The value of the parameter setting the CO rate should be within -127 and +128.

**PEGASO 650****Dashboard errors**

In this mode, a table is displayed indicating possible immobilizer errors or errors related to sensors connected to it. Following is the error decoding table:

| DESCRIPTION  | ERROR CODE |
|--|------------|
| Immobilizer failure: Key code was read but not acknowledged                    | DSB 01     |
| Immobilizer failure: Key code not read (Key not present or transponder faulty) | DSB 02     |
| Immobilizer failure: Antenna faulty (Open or short-circuited)                  | DSB 03     |
| Immobilizer failure: Inner controller fault                                    | DSB 04     |
| Fuel sensor failure  | DSB 05     |

The instrument panel should store past errors in memory.

In case of fuel sensor failure, the relevant icon on the display should be flashing.

**Delete errors**

Use this option to delete all errors, both from the ECU and the instrument panel; a confirmation is needed.

**Service reset**

This function resets the service interval.

**Disconnect**

On the Pegaso, the instrument panel uses diagnostics instruments communication K line for gathering data. To avoid any interference, use the user's interface settings to set the instrument panel in such a status for which there is no interference. Using the outer devices, the ECU will be reset and can start communication with the diagnostics tool.

The LCD shows:

- Dashboard disabled. Now it is possible to connect the diagnostic tool.

The instrument panel will start operating in a normal way after one cycle of key on-off.

### Update

This function allows reprogramming of the instrument panel.  
This page shows the currently loaded software version.  
The LCD shows:

- Dashboard disabled. Now it is possible to connect the diagnostic tool.

The instrument panel will start operating in a normal way after one cycle of key on-off.

### Update keys

This function allows the instrument panel to update the keys.  
It is possible to store up to 4 keys.

You will be prompted to enter the user code:

- Insert the code

If the code is correct, the display should show the message:

- Insert the **X** key.
- Memorised **X+1** key.

At least one key should be stored, then the procedure is ended if no further key is inserted within 20 seconds or in case power is missing or after the fourth key. All vehicle and instrument panel functions should be enabled (even with just one key stored).

### Km / miles

This menu allows selection of the unit of measurement for speed.

|       |
|-------|
| KM    |
| MILES |

### Language

This menu allows you to choose the user's interface language.

- ITALIANO
- ENGLISH
- FRANCAIS
- DEUTSCH
- ESPAGNOL

## PEGASO 650

## SERVICE INTERVAL

When the scheduled service intervals are reached, an icon is displayed (symbol of a spanner).

## ALARM DISPLAY

In case a serious failure is detected, one that might jeopardise the vehicle or the rider's safety, the display will show an icon indicating the failure cause, in the area where the odometer usually is.

Alarms are divided in two groups depending on their priority:  
High priority: overtemperature, ECU errors, Instrument panel errors;

Low priority: Direction indicators.

Direction indicators fault is indicated only when all indicator leds are faulty.

Should there be many alarms with same priority level, the relevant icons are displayed alternately.

High priority alarms do not allow you to display low priority ones.

If the alarm light and the SERVICE icon briefly come on it does not mean that there is a failure.

## FUNCTION FEATURES

## Speedometer

The speed value is shown on the display with [nnn] format and with indication of unit of measurement [km/h] or [MPH].

Accuracy should be higher than required by Directive 2000/7/CE dated 20/03/00 and in any case between +0% and +2%.

Measurement is taken with a reading in the Denso ECU of the number of pulses in-between the readings. 20 pulses/revolution are set, front sprocket has 15 teeth while rear sprocket has 44, wheel development is 1926 mm.

For homologation reasons, the data indicated by the instrument should be 6% higher than the data read by the ECU.

## Revolution counter

Engine rpm indication is on the left side of the instrument.

- Accuracy: 0/+5% with respect to input signal.
- The instrument panel should filter the signal to avoid index oscillation, especially at idle speed.
- Maximum index oscillation at idle speed:  $\pm 1^\circ$  with respect to input signal.
- Maximum index oscillation at maximum rpm:  $\pm 0.5^\circ$  with respect to input signal.
- Index increasing speed, smooth from scale start to end or vice versa: 0.6 sec.

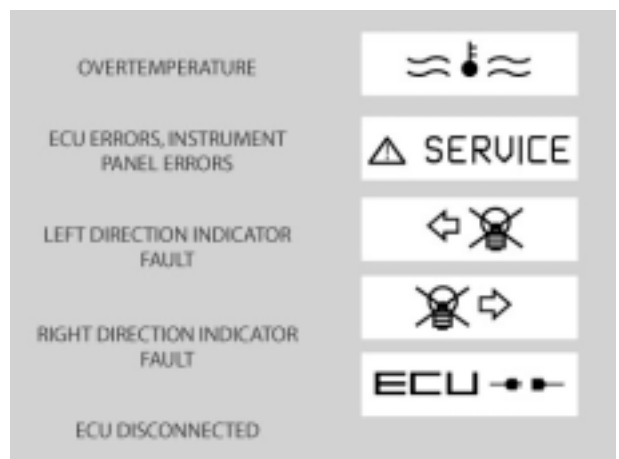
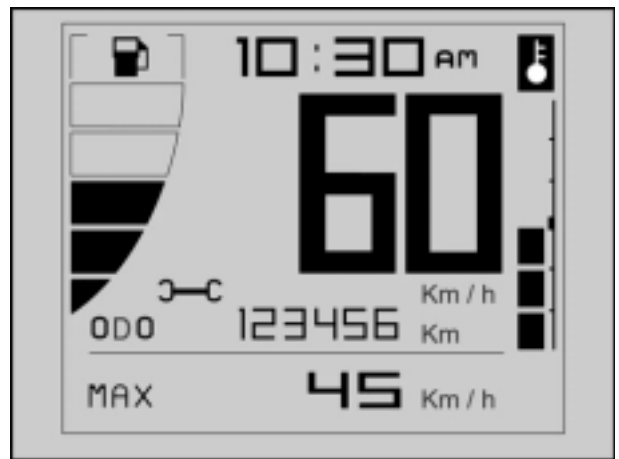

Measurement is taken by reading the value in the Denso ECU. The relationship between engine speed and data from ECU is:

$$\text{RPM} \times 1000 = \text{DATA1} \times (189/7) = \text{DATA1} \times 27$$

Index recovery logic: index is taken to scale start every time the vehicle is switched off. Every time the battery is reconnected, index is taken back to zero, regardless of its current position. At every ignition, a 20° recovery is performed.

### Engine temperature indicator

Temperature measurement is done by Denso ECU. The light turns on when coolant reaches temperature of 120°.

### Fuel level indicator

The instrument panel should interface to a resistive level sensor both of the potentiometric type and the resistive steps type. The measurement of values exceeding the sensor limits should be considered as faults and be signalled by the diagnostic. Indication is given in the LCD and with relevant reserve light. The features and calibration curves are indicated in the following table:

| LEVEL       | RESISTANCE | WARNING LIGHT |
|-------------|------------|---------------|
| 15.8 litres | 22.5 Ohm   | off           |
| 3.8 litres  | 240.0 Ohm  | on            |
| 0.0 litres  | 296.0 Ohm  | on            |

### Distance covered w/fuel reserve

The display should show how many km have been covered since the fuel reserve light came on. The value is indicated in [nn.n] format followed by the unit of measurement [km] or [mi].

The counter starts when it detects that the light has been on for 5 seconds in a row and count is stopped when it detects that the light has been off for 30 seconds in a row. In any case, data should be shown only after count has exceeded 2 km.

Value is displayed after 40 seconds from key-on so that the odometer value can be viewed even with vehicle on fuel reserve.

### Odometer

Selection between Km and Miles is made via user interface.

- Value should be given with an accuracy of 6 digits and **[Km]** or **[Miles]** indication. Saturation occurs when shifting from 999998 to 999999 with count block; the digits that are not used, are not displayed.
- Accuracy:  $\pm 0.5\%$
- The value of total kilometres covered should be stored for at least 5 years, with instrument not powered.
- Data are saved at least every 2 km.

Odometer data should not be lost whatever the power supply condition.



### Clock

It is displayed only when vehicle is on, indication stays displayed for 5 seconds upon switching-off.

- Accuracy should be higher than 30ppm.

The clock should not reset in case of temporary voltage drop in the electric system (see qualification test). Settings are lost upon battery disconnection; upon following key-on the clock will constantly display "0:00" until a new setting is performed.

### On-board Computer

In the display bottom are the on-board computer indications, i.e. two trip meters with relevant maximum speed and average speed, trip time and fuel consumption. When resetting one trip meter, all connected values are reset.

Km and miles selection is made via user interface and is connected to the unit set for odometer.

The instrument panel should not lose data in case of temporary voltage drops, for example due to vehicle start-up; Data might be lost in case of battery disconnection. See the qualification tests for further details.

Upon saturation of trip meter, i.e. from 999.9 to 0.0, or upon saturation of the trip times, from 99:59 to 00:00, all values of relevant trip meter should be reset.

### Trip meter

Trip meter value is calculated since last reset. The value is shown on the display with [nnn.n] format, with indication of unit of measurement [km/h] or [MPH]. Value is refreshed at least every 10 seconds. Saturation occurs from 999.9 to 0.0.

### Trip time

Trip time value is calculated since last trip meter reset. This calculation also includes stops (zero speed and engine running) while does not include intervals with key-on and engine off. Count stops with engine off.

The value is indicated in the display in [hh:mm] format, with [TIME] written before. Saturation occurs from 99:59 to 00:00.

### Maximum speed

Maximum speed is calculated since last reset. The value is shown on the display with [nnn] format, with [MAX] written before and the unit of measurement [km/h] or [MPH] indicated after it.

Speed value is stored only if it stays the same for at least 3 samplings taken at intervals of 0.5 seconds.

I.e., given  $V_n, V_{n+1}, V_{n+2}$

If  $(V_n \leq V_{n+1}) \& (V_n \leq V_{n+2})$  then  $V_{MAX} = V_n$

### Battery voltage

This function measures battery voltage. The value is shown in the display with [nn.n] format, the battery icon precedes the value and the unit of measurement [V] follows the value.

- Range: **9.0 ÷ 16.0** [V]. If voltage is lower than 9V or higher than 16V, accuracy might exceed required tolerances but should have a constant increasing trend.
- Accuracy: **±0.2V** with respect to voltage at the battery (correction factors should then be added, as per table, varying according to the vehicle the instrument is fitted to).

Refresh: every 10 secs. To avoid indication oscillation, a suitable software damping should be set.

### Safety logic

Immobilizer and safety logic actuation are performed through the CONTACT 1 and CONTACT 2 signals from the instrument panel and should be closed to enable ignition. Immobilisation is performed by opening all contacts.

Vehicle is immobilised maintaining at high logic level (open contacts) CONTACT 1 and CONTACT 2 signals and at low logic level (open contact) the STARTER RELAY ACTUATION signal.

Safety devices are released setting at low logic level (closed contact) CONTACT 1 and CONTACT 2 signals and at high logic level (closed contact) the STARTER RELAY ACTUATION signal.

### Service intervals

The SERVICE icon coming on to indicate that the vehicle is due for first service coupon occurs when odometer reaches 1000 km. The next service intervals are indicated when odometer will reach a multiple of 10000 km.

The service warning can be reset from 300 Km before the scheduled interval and in this condition the service icon should flash for 5 seconds and then go off.

### Direction indicators

The instrument panel works as a control driver for direction indicators, as single channel control and as synchronised control for both channels ("Hazard"). Required features are the following:

**PEGASO 650**

The hazard control device is a push-button.

Flashing frequency in normal operation: as per FMVSS 108 standard (60÷120 blinks/min.) and anyway  $\approx 87$  blinks/min.

The instrument panel should be able to directly pilot a lamp load up to 4x21W. Consider in any case the chance of piloting even sundry loads (such as front lamps and rear LEDs) or LEDs only for all 4 outputs. It is then necessary to have 4 separate control channels. Minimum current per channel will be 1mA.

Failure signal (burnt-out or short-circuited bulb) by doubling the light flashing frequency ( $\approx 175$  blinks/min.).

Protection against short-circuit (with indefinite short-circuit stay time) for all outputs.

Hazard operation logic: can be enabled/disabled with key ON only. After activation, it stays active even when taking the key to OFF.

For the USA version, the instrument panel should be marked DOT (SAE J590b standard, October 1965).

**Hazard**

The hazard control device is a push-button. It can be enabled or disabled only with KEY-ON. When activated, the direction indicators stay active even when removing the key. To disable them, turn the key back to ON.

**Automatic switch-off**

The automatic switch-off of direction indicators is required. If vehicle is stopped, so with speed equal to zero, the direction indicators carry on flashing indefinitely; if the vehicle is in motion, the indicators switch-off automatically when one of the following two conditions is true:

- After a set time  $t = 40$  sec.

After covering 500 m.

**Immobilizer**

The immobilizer system is integrated in the instrument panel electronic board. Board design allows manufacturing instrument panels without immobilizer, or with immobilizer function disabled, so that they can be used in countries where immobilizer system is not allowed or not fitted.

The supplier shall have the instrument panel immobilizer device homologated according to the standards of the relevant Ministries of the various countries and shall stick the suitable label indicating system certification on the instrument panel itself.

## Operation

The instrument panel reads key code upon switch-on. If this code matches one of the memorised codes, the instrument panel shall perform the initial check routine and enable engine start.

The system should be able to store up to four keys.

If the key code is not acknowledged, the instrument panel should inhibit engine starting and the display should show manual override code request. In this case it should be possible to gain access to the menu via the diagnosis functions.

## Code

This function allows immobilizer manual override through a code. In case the instrument panel does not acknowledge inserted key, access code is requested with the message:

- Insert the code

The code should be made of 5 digits, 0 to 9. At line output, code will be empty (5 digits equal to 0, i.e. 00000) and will be programmed by the user, upon switch-on an alarm message should be displayed for 10 seconds, until code is entered:

- Remember to insert your user code

This code can be changed by the user, in this case the old code should be entered and if the user loses the access code, it can be changed through a procedure requiring insertion of both keys.

## Memorisation of keys at first start-up

The customer will receive two keys fitted with transponder. Upon instrument panel first start-up, it should request key memorisation.

The display shows:

- Insert the **X** key.
- Memorised **X+1** key.

At least one key should be stored, then the procedure is ended if no further key is inserted within 20 seconds or in case power is missing or after the fourth key. All vehicle and instrument panel functions should be enabled (even with just one key stored).

## Memorisation of new keys

In case one key is lost, the customer can disable the lost key or disable and completely change the set of keys by changing the complete ignition switch.

## Diagnosis

The instrument panel should indicate the failure of the component controlling the immobilizer function, failure of the antenna and reading fault because of transponder with code not stored, in this case the access code is requested.

PEGASO 650

CONNECTOR

The figure shows the connector diagram, on instrument panel, and its pin layout.

The numbers are printed on the plastic element of the pins and on the connector body.

The grey end pin layout is as follows:

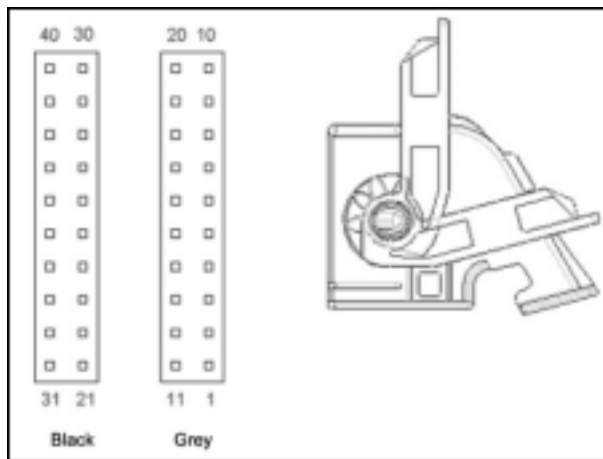

| PIN | Service                           |
|-----|-----------------------------------|
| 1   | +KEY                              |
| 2   | RIGHT DIRECTION INDICATOR CONTROL |
| 3   | HIGH BEAM INPUT                   |
| 4   | *                                 |
| 5   | HEATED HANDGRIPS INPUT            |
| 6   | K-LINE                            |
| 7   | NEUTRAL                           |
| 8   | SELECT 1 - DOWN                   |
| 9   | FUEL LEVEL SENSOR                 |
| 10  | *                                 |
| 11  | +BATTERY                          |
| 12  | LEFT DIRECTION INDICATOR CONTROL  |
| 13  | *                                 |
| 14  | *                                 |
| 15  | *                                 |
| 16  | GENERAL GROUND                    |
| 17  | ABS INPUT                         |
| 18  | SENSORS GROUND                    |
| 19  | MAIN GROUND (OPTION)              |
| 20  | MAIN GROUND (OPTION)              |

The black end pin layout is as follows:

| PIN | Service                                   |
|-----|---|
| 21  | +BATTERY                                  |
| 22  | FRONT LEFT DIRECTION INDICATOR ACTUATION  |
| 23  | REAR LEFT DIRECTION INDICATOR ACTUATION   |
| 24  | ANTENNA 1                                 |
| 25  | CONTACT 1 (NEUTRAL ECU INPUT)             |
| 26  | *   |
| 27  | INDICATORS RESET                          |
| 28  | *   |
| 29  | STAND                                     |
| 30  | SELECT 2 - UP                             |
| 31  | +BATTERY                                  |
| 32  | FRONT RIGHT DIRECTION INDICATOR ACTUATION |
| 33  | REAR RIGHT DIRECTION INDICATOR ACTUATION  |
| 34  | ANTENNA 2                                 |
| 35  | CONTACT 2 (ECU STAND INPUT)               |
| 36  | *   |
| 37  | HAZARD                                    |
| 38  | STARTER RELAY ACTUATION                   |
| 39  | CLUTCH SENSOR                             |
| 40  | SELECT 3 - SET                            |

Pins marked with \* are available but not used.

## CONNECTIONS

Following are input and output lines and their electrical features; all inputs, outputs and lights should be controlled by microprocessor. Power lines should be equipped with devices limiting current in case of failure.

- K-line

The interface line consists in a line with physical level complying to ISO-9141, to be used for communication with the Denso ECU. Speed shall be 15.625 Kbit/sec. The line shall be fitted with a 1K $\Omega$  pull-up resistor powered by battery (according to key position), it should feature a diode connected in series to avoid backflow of power through the signal lines.

- Select 1÷3

These inputs are used for user interface controls and should be fitted with a 1K $\Omega$  pull-up resistor powered by inner power supply.

- High beam input

It is the signal indicating high beam on to the instrument panel and should switch on the relevant warning light. With lights off there is no power, while when lights are on there is either the battery voltage or a signal directly derived from the regulator, therefore it is a pulsating signal that might reach high values.

In case the signal is taken directly from the generator, its minimum frequency can be 100 Hz with an idle speed of 600 rpm and one polar expansion only.

In case the bulb is failed, the warning light should stay off: a pull-down resistor is required.

- Right indicator control
- Left indicator control
- Indicators reset control
- Hazard control

These are signals indicating the status of direction indicators to the instrument panel, they are NO push-buttons that give a ground contact when pressed.

- Heated handgrips

When handgrip heating is on, battery voltage is input to this input. Since they are an option item, it is necessary to fit a pull-down resistor so that light stays off when heated handgrips are not fitted.

- Fuel level sensor

It is a sensor with a 12-296  $\Omega$  resistive race, and one end connected to ground.

- Neutral

It is a contact, present only on vehicles with selectable speeds, signalling if the gear is engaged or not. It is grounded when the vehicle is in neutral and in this condition the relevant warning light shall be on.

**PEGASO 650**

- Stand

It is a contact, present only on vehicles fitted with side stand, signalling if the side stand is down or not.

- ABS

This input controls the ABS light status. With input open or with level high, light shall be on, on ABS control unit control, the light is off with input at low level.

- Antenna 1
- Antenna 2

- Contact 1, Contact 2

These are two contacts providing for engine disable, piloted both by the immobilizer and by the engine control logic. These contacts shall be properly sized for a loop current equal to 200 mA, while current at start-up is 500 mA and should be protected to allow inductive loads piloting.

- Starter relay actuation

Shall be able to pilot a relay with maximum current of 4A.

**DESIGN REQUIREMENTS****Operating conditions**

- Nominal voltage: 13.5±0.5 V
- Operating voltage (not calibrated): 6V+18V (it is in any case necessary to ensure data storage in case of temporary power failure such as upon start-up with flat battery).
- Operating voltage (calibrated): 9+16 V
- Absorption with key not inserted (excluded immobilizer led, where fitted): <1mA
- Operating temperature (not calibrated): -20°C + +85°C
- Operating temperature (calibrated): -18°C ++65°C
- Stocking temperature: -30°C + +90°C
- Materials with slow combustion, resistant to fire as per UL94-HB V2 standard.

**Vehicle mission profile**

Forecast life-span shall not be shorter than 50000 km or 8 years.

**LCD Specifications**

The display has a resolution of 128x112 pixel (X-axis - Y-axis), the visible area is 62x55mm while active area (the one actually covered by pixels) is 56x49 mm (X-axis - Y-axis).

Display cone is: On the horizontal surface (x-z) it is +45° - 45°, on the vertical surface (y-z) it is +10° -30°. The contrast shall be more than 5 in the whole display cone.

All LCD shall be legible with Polaroid glasses up to 35° with respect to the horizontal line.

### Display temperatures

The display operating temperature specifications are the following:

- Operating temperature (with no ghost effect):  $-20^{\circ}\text{C} \div +85^{\circ}\text{C}$
- Stocking temperature:  $-30^{\circ}\text{C} \div +90^{\circ}\text{C}$

The instrument panel shall therefore implement a display compensation system upon ambient temperature variation.

### Labelling

A label should be stuck at the back of every component; it shall be indelible and water proof, indicating the following details:

- supplier code
- Aprilia code
- hardware board version
- software version
- production date

The Supplier shall add more labels for DOT certification or immobilizer system homologation.



## 2.2. SCHEDULED MAINTENANCE

### 2.2.1. CHANGING ENGINE OIL AND OIL FILTER

Change the oil filter after the first 1000 km (621 mi), end of running-in, and then every 10000 km (6250 mi).

- Position the vehicle on firm and flat ground.
- Position the vehicle on the stand.



#### WARNING

**Allow several minutes for the engine and exhaust system to cool down.**

- Stop the engine and let it cool down, in order to allow the oil to flow into the crankcase and to cool down.

**NOTE** Failure to perform the operations described above may result in the incorrect measurement of the engine oil level.

- Unscrew and extract the plug/dipstick.



- Place a container under engine oil drain plug.
- Loosen and remove the oil drain plug and let oil drain off completely.



#### WARNING

**Used oil contains substances that are very dangerous for the environment. Dispose of used oil in accordance with applicable regulations.**



- Loosen and remove the three oil filter cover screws.

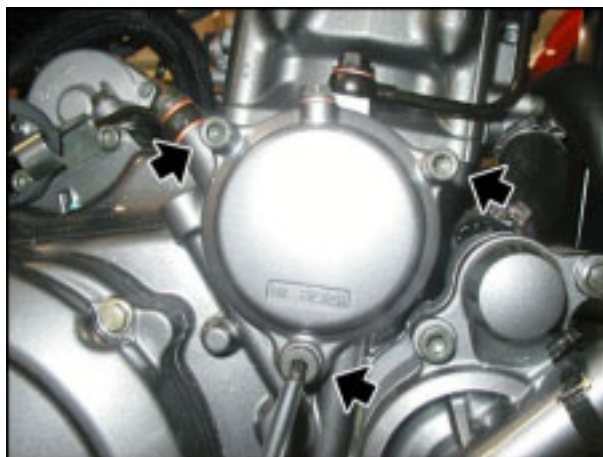

- Remove the oil filter cover with gasket, collect the O-ring.



- Remove the oil filter.
- Install a new oil filter.
- Fit the oil filter cover and tighten the three screws.
- Screw and tighten the oil drain plug.
- Fill up with about 1500 cu.cm of engine oil (91.5 cu.in.).
- Screw and tighten the plug/dipstick.
- Start the engine and let it run for a few minutes. Stop the engine and let it cool down.
- Check engine oil level.



### 2.2.2. CLEANING THE AIR FILTER

- Remove the right side body panel, see (REMOVING THE REAR FAIRING).
- Loosen and remove the four screws.

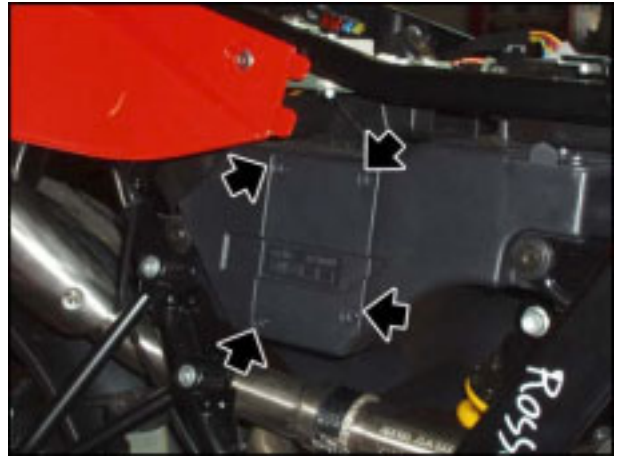

- Slide out the filter mount and air filter.



- Remove the air filter from its mount and clean the filtering element.



### 2.2.3. CHANGING THE COOLANT

- Remove the headlight, see (REMOVING THE HEADLIGHT).
- Remove the fuel tank, see (REMOVING THE FUEL TANK).
- Set a container of suitable capacity under drain screw to collect exhausted fluid.



#### WARNING

**Do not remove the filler plug with hot engine. Coolant is hot and under pressure.**

- Release and remove the drain screw, collect the copper washer.
- To help coolant draining off completely, remove circuit filler plug (A) on radiator and expansion tank filler plug (B) on expansion tank.



- Refit the drain screw with a new copper washer.
- Pour fluid into filler until full.
- Repeatedly press with your hand on the unions to allow fluid to fill in all channels.

**NOTE** The correct level is when fluid gets just below the filler.

- Top up again until full.



- Tighten circuit filler plug (A).
- Release expansion tank plug and top up fluid in the expansion tank until level is between **MIN** and **MAX** notches.
- Tighten the expansion tank plug (B).
- Start the engine and let it idle for a few minutes, stop it and let it cool down.
- Check again fluid level in the expansion tank and top up if necessary.

## 2.2.4. FRONT BRAKE

### BLEEDING

The air, if any, present inside the hydraulic circuit will serve as "pad" by absorbing most of the pressure coming from the brake master cylinder and thus reducing the calliper efficiency during braking.

If some air is present inside the circuit, the brake control is "spongy" and the braking efficiency is reduced.



#### DANGER

**It is fundamental that air is bled off the hydraulic circuit after the brakes have been refitted and the braking system has been restored to its standard operating conditions, since it would be very dangerous for the vehicle and the rider not to do so.**

**NOTE** The following procedure applies to both front brake callipers.

*Bleed air with vehicle on flat ground. While bleeding the hydraulic circuit, top up reservoir with brake fluid as required. Make sure there is always some fluid in the reservoir throughout the process.*

- Remove the bleed valve rubber cap.
- Insert one end of a transparent plastic tubing inside the front brake calliper bleed valve and the other end in a container for collection.
- Pull and quickly release the front brake lever a few times, then keep it pulled.
- Loosen the bleed valve by 1/4 of a turn so as the brake fluid flows in the container, this will remove any tension from the lever and help it travel fully home.
- Retighten the bleed valve before the lever is fully squeezed in.
- Repeat process until the fluid draining into the container is totally clear of air bubbles.

**NOTE** While bleeding the hydraulic circuit, top up reservoir with brake fluid as required. Make sure there is always some fluid in the reservoir throughout the process.

- Tighten the bleed valve and remove the tubing.
- Top up fluid inside tank.
- Refit the rubber cap.

### CHANGING THE PADS

- Turn the pins and slide out both slit pins.



- Remove both pins.



- Remove the vibration damper.



- Remove one pad at a time.

**WARNING**

Do not operate the brake lever when the pads are not in place or the calliper pistons might come off their housing, thus causing brake fluid leakage.

- Install two new pads, fit them so as the holes match those on the calliper.

**WARNING**

Always change both pads and ensure they are correctly in place inside the calliper.

- Fit the vibration damper.
- Fit both pins.
- Fit both split pins.
- Check brake fluid level.



### 2.2.5. REAR BRAKE

#### BLEEDING

The air, if any, present inside the hydraulic circuit will serve as "pad" by absorbing most of the pressure coming from the brake master cylinder and thus reducing the calliper efficiency during braking.

If some air is present inside the circuit, the brake control is "spongy" and the braking efficiency is reduced.



#### **DANGER**

**It is fundamental that air is bled off the hydraulic circuit after the brakes have been refitted and the braking system has been restored to its standard operating conditions, since it would be very dangerous for the vehicle and the rider not to do so.**

**NOTE** Bleed air with vehicle on flat ground. While bleeding the hydraulic circuit, top up reservoir with brake fluid as required. Make sure there is always some fluid in the reservoir throughout the process.

- Remove the bleed valve rubber cap.
- Insert one end of a transparent plastic tubing inside the rear brake calliper bleed valve and the other end in a container for collection.
- Pull and quickly release the rear brake lever a few times, then keep it pulled.



- Loosen the bleed valve by 1/4 of a turn so as the brake fluid flows in the container, this will remove any tension from the lever and help it travel fully home.
- Retighten the bleed valve before the lever is fully squeezed in.
- Repeat process until the fluid draining into the container is totally clear of air bubbles.

**NOTE** While bleeding the hydraulic circuit, top up reservoir with brake fluid as required. Make sure there is always some fluid in the reservoir throughout the process.

- Tighten the bleed valve and remove the tubing.
- Top up fluid inside tank.
- Refit the rubber cap.



#### CHANGING THE PADS

- Turn pin and slide out split pin.
- Remove the split pin.



- Remove the pin.



- Remove one pad at a time.

**WARNING**

Do not operate the brake lever when the pads are not in place or the calliper pistons might come off their housing, thus causing brake fluid leakage.

- Install two new pads, fit them so as the holes match those on the calliper.

**WARNING**

Always change both pads and ensure they are correctly in place inside the calliper.

- Insert the pin.
- Fit the split pin.
- Check brake fluid level.





### 2.2.6. ADJUSTING THE VALVE CLEARANCE

**NOTE** The following procedure applies to all valves.

Adjust clearance when the engine is cold, at ambient temperature.

Measure or adjust valve clearance with the piston at top dead centre (TDC) during the compression stroke.

- Release and remove the four screws.



- Remove the intake tappet cover.



- Loosen and remove the four screws and remove the exhaust tappet cover.

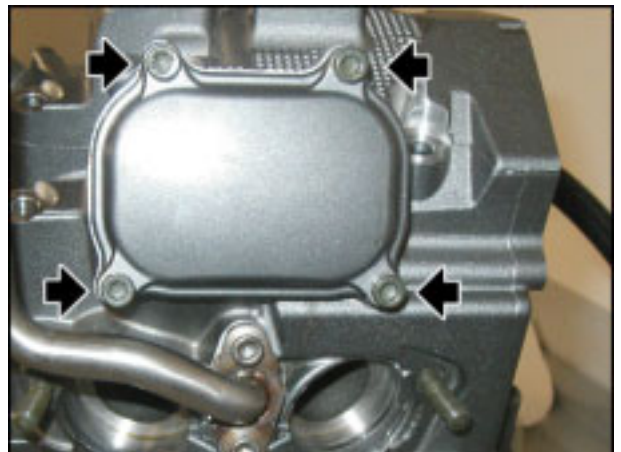

- Loosen and remove the two screws (1), collect the washers.
- Remove the camshaft gearwheel cover (2).

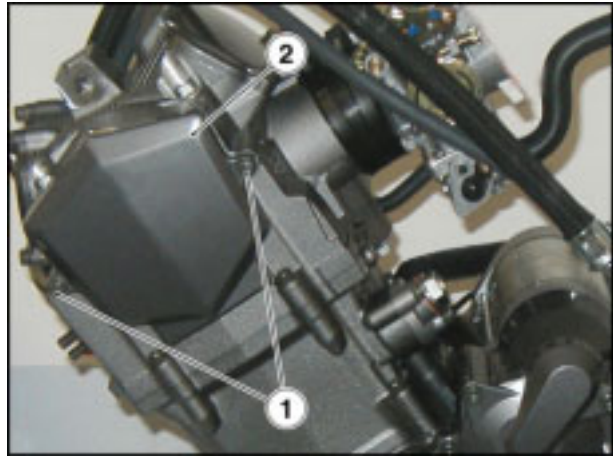

- Release and remove the spark plug.



- Release and remove the timing reference screw (3) and crankshaft screw (4).



- Measure the valve clearance as follows:
  - 1 - Turn the crankshaft counter clockwise.
  - 2 - With piston at TDC, in the compression stroke, align reference "1" (a) on magnet rotor to the fixed reference (b) onto magnet cover.



**NOTE** To set piston at TDC in the compression stroke, align reference "I" on camshaft gearwheel to the fixed reference on the cylinder head.

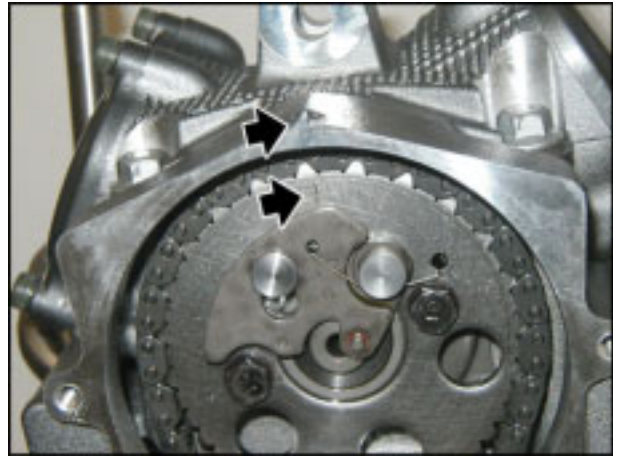

- 3 - Using a feeler gauge, check that valve clearance stays within the indicated values and possibly adjust it.

#### Valve clearance (from cold)

##### Intake valve:

0.09 ÷ 0.13 mm (0.0035 ÷ 0.0051 in.)

##### Exhaust valve:

0.16 ÷ 0.20 mm (0.0063 ÷ 0.0079 in.)

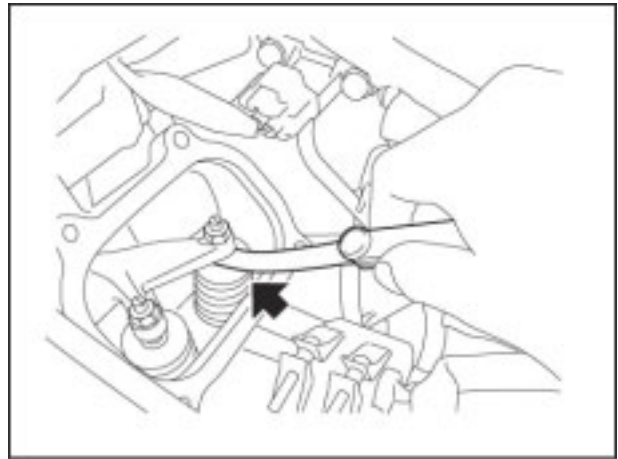

- Adjust the valve clearance as follows:
- 1 - Loosen the lock nut (5).
- 2 - Insert a suitably sized feeler gauge (see valve clearance from cold) in-between the adjuster screw end (6) and the valve tip.

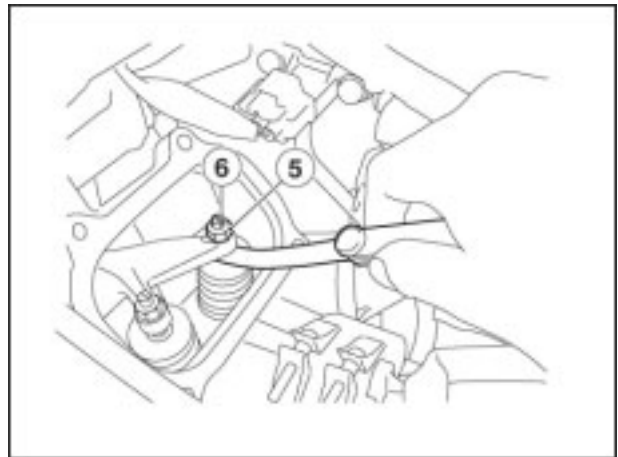

- 3 - Turn the adjuster screw in direction (d) or (e), until obtaining prescribed clearance using the feeler gauge.

**Direction d**                      **Valve clearance increases.**

**Direction e**                      **Valve clearance decreases.**

- 4 - Hold the adjuster screw (6) to prevent it from moving and tighten the lock nut (5) to the specified torque.

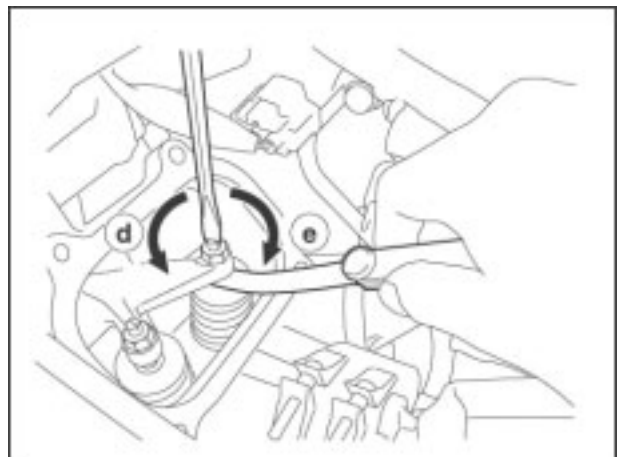

- 3 - Using the feeler gauge, check again that valve clearance is within the indicated values and possibly repeat all steps relevant to valve clearance adjustment until obtaining the prescribed clearance.

**NOTE** Lubricate the valve shims, see (LUBRICANT TABLE).

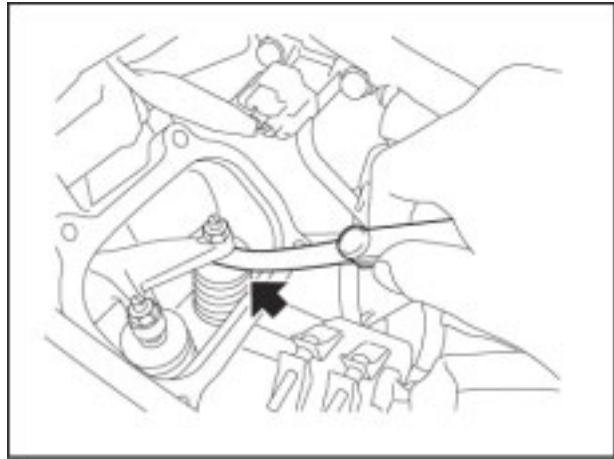

- Using the suitable special tool (no. 8140850), tighten the flywheel cover giving access to the timing reference mark (3) and the flywheel cover giving access to the crankshaft (4).



- Install camshaft gearwheel cover (2) in its seat and secure it with two washers and tighten the two screws (1).

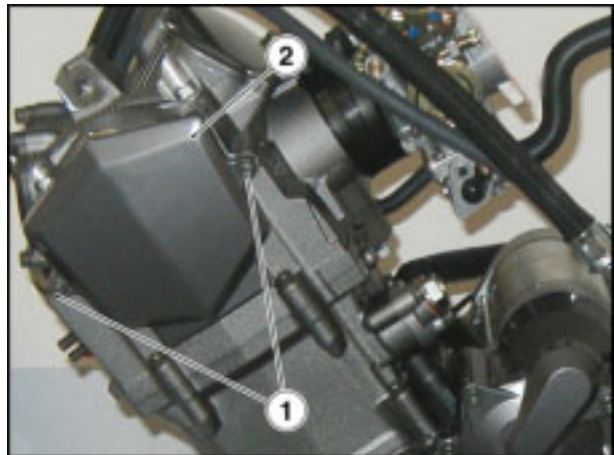

- Install the exhaust tappet cover and tighten the four screws.

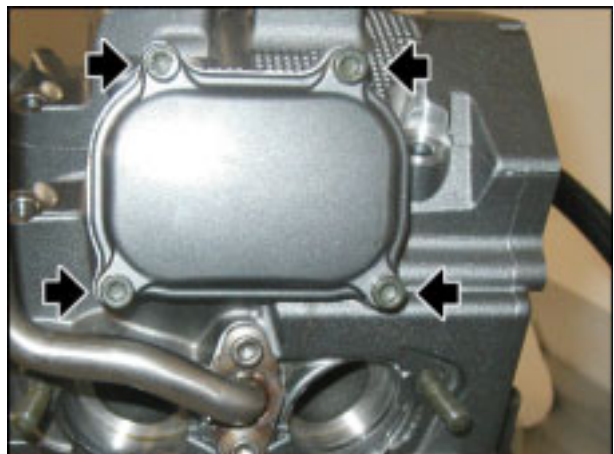

## PEGASO 650

- Install the intake tappet cover and tighten the four screws.



FUEL SYSTEM

3

**SUMMARY**

3.1. FUEL SYSTEM ..... 3  
3.1.1. DIAGRAM ..... 3  
3.1.2. REMOVING THE FUEL TANK ..... 4  
3.2. INJECTION ..... 7  
3.2.1. INJECTION SYSTEM DIAGRAM ..... 7

## 3.1. FUEL SYSTEM

## 3.1.1. DIAGRAM

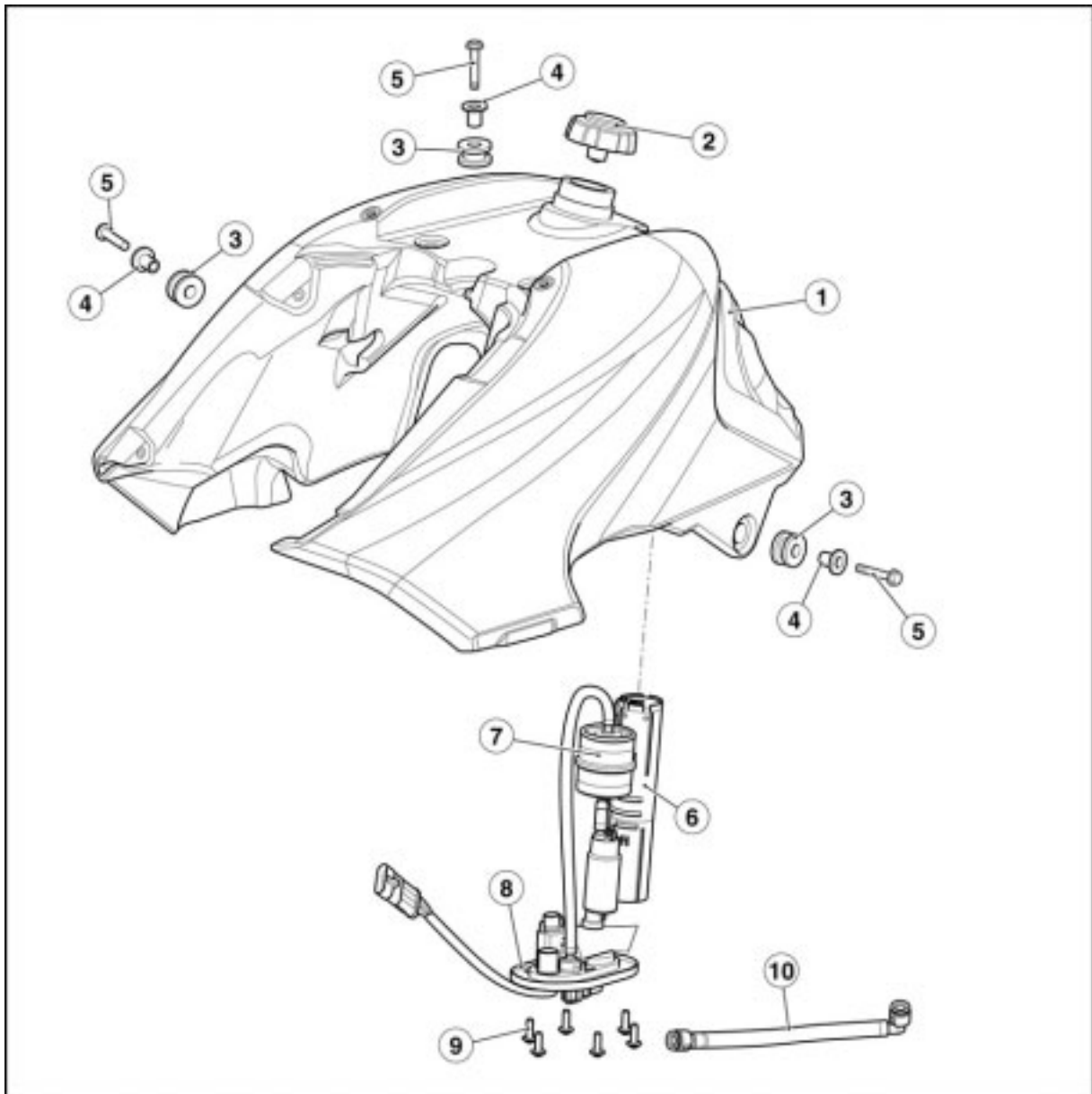
**Key:**

1. Fuel tank
2. Fuel tank plug
3. Rubber block
4. Spacer
5. Flanged screw
6. Fuel level sensor
7. Fuel filter
8. Fuel pump flange seal
9. Flanged screw
10. Fuel delivery hose



### 3.1.2. REMOVING THE FUEL TANK

- Remove the headlight, see (REMOVING THE HEADLIGHT).
- Remove the seat.
- Release and remove the two screws, remove the right support cover to release the wiring.



- Raise the glove compartment cover using the suitable control.
- Release and remove the five screws.



- Release and remove the two screws on motor for opening the glove compartment, raise it and disconnect the connector.

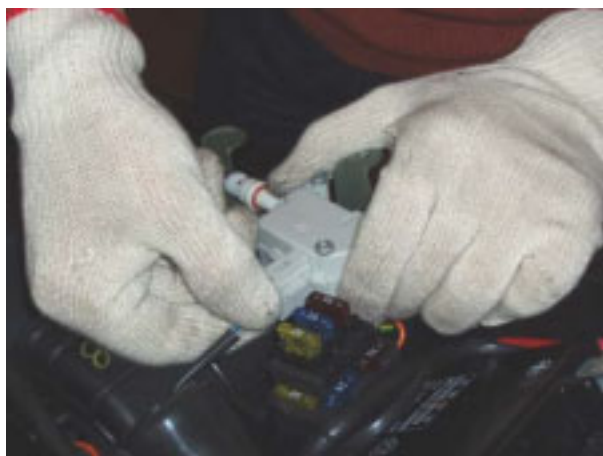
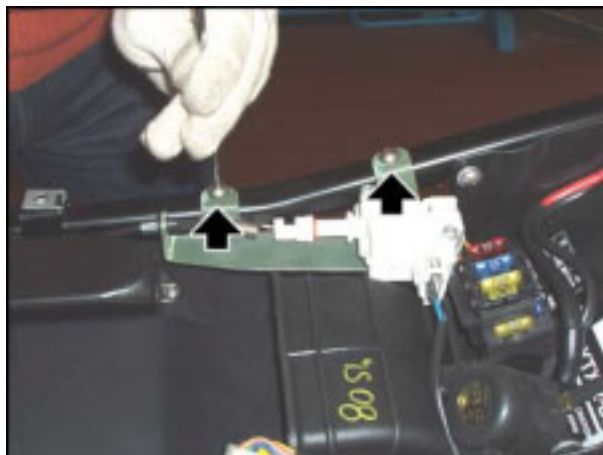

## PEGASO 650

- Remove the fuel filler plug.



- Raise the glove compartment and slide out the fuel breather hose.
- Remove the three fuel breather hose clamps.
- Slide out the fuel breather hose.



- Remove the glove compartment with motor.
- Tighten the fuel tank plug.



- Disconnect the fuel tube.



- Release and remove the fuel tank front screw.



- Release and remove the two side screws (one on each side).



- Disconnect the fuel pump connector.



- Remove the fuel tank.



## 3.2. INJECTION

## 3.2.1. INJECTION SYSTEM DIAGRAM

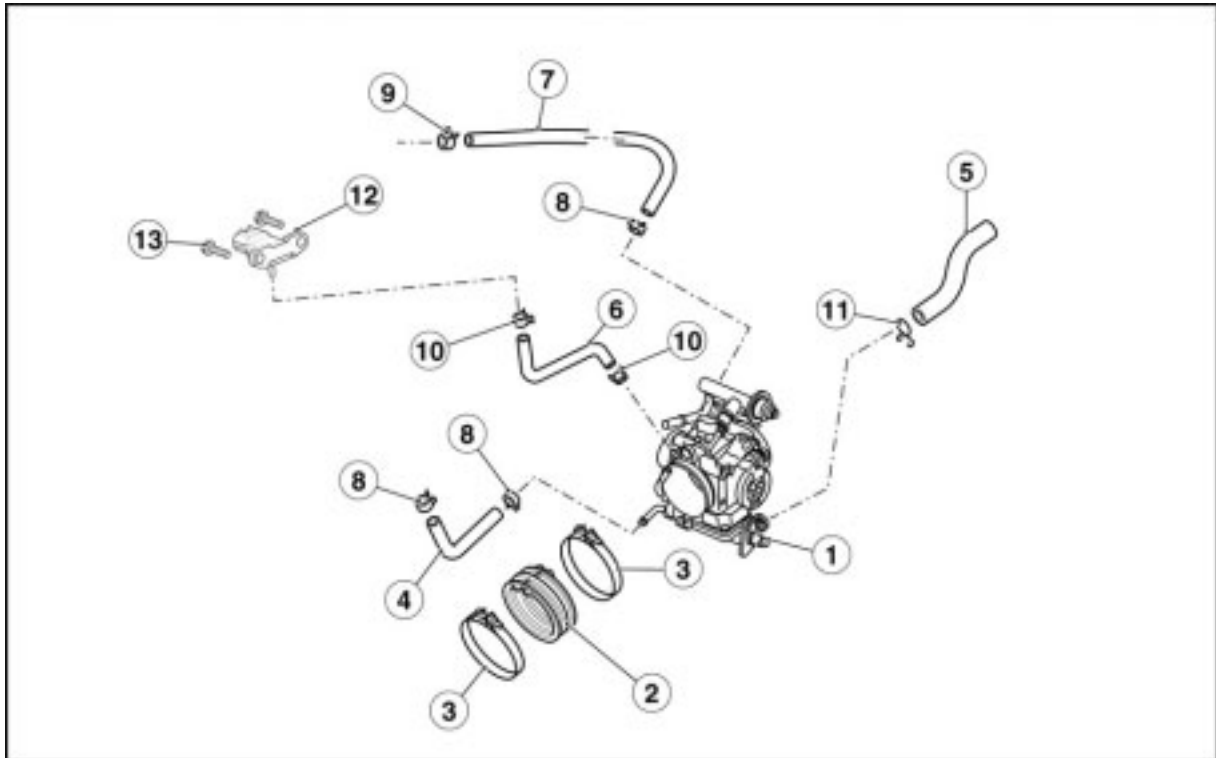
**Key:**

1. Throttle body
2. Manifold D.46
3. Clamp for manifold D.72
4. Preformed tube D.5.5x11.5
5. Preformed tube D.13x18
6. Pressure sensor tube
7. Throttle body tube
8. Elastic clip D.11.5
9. Elastic clip D.11.5
10. Yellow elastic clip D.8.5
11. Elastic clip D.18
12. Air pressure sensor (MAP Sensor)
13. Flanged screw

ENGINE

4

**SUMMARY**

|        |   |    |
|--------|---|----|
| 4.1.   | REMOVING AND REFITTING THE ENGINE ..... | 3  |
| 4.1.1. | REMOVING THE ENGINE .....               | 3  |
| 4.1.2. | REFITTING THE ENGINE .....              | 15 |
| 4.1.3. | TIGHTENING TORQUES .....                | 26 |
| 4.2.   | SECONDARY AIR SYSTEM.....               | 27 |
| 4.2.1. | SECONDARY AIR .....                     | 27 |

## 4.1. REMOVING AND REFITTING THE ENGINE

### 4.1.1. REMOVING THE ENGINE

- To remove the engine, first remove the fuel tank, the rear fairing panels, the sump guard, the battery and the exhausts.
- Remove the clamp and slide off the hose.



- Remove the clamp and slide off the hose.



- Remove the air box connector.



- Remove the clamp from “fuel vapour recycle” hose.



- Remove the tie from wiring.

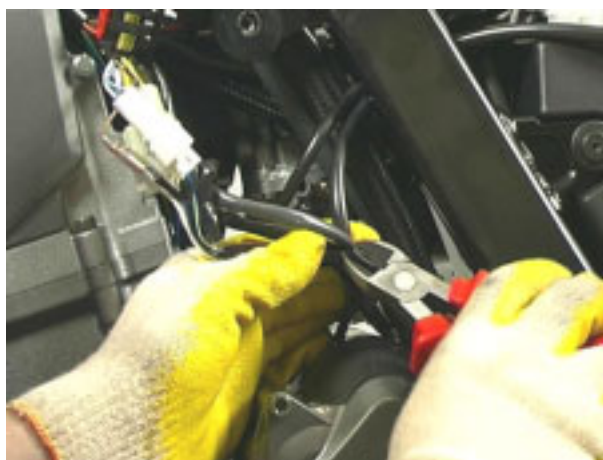
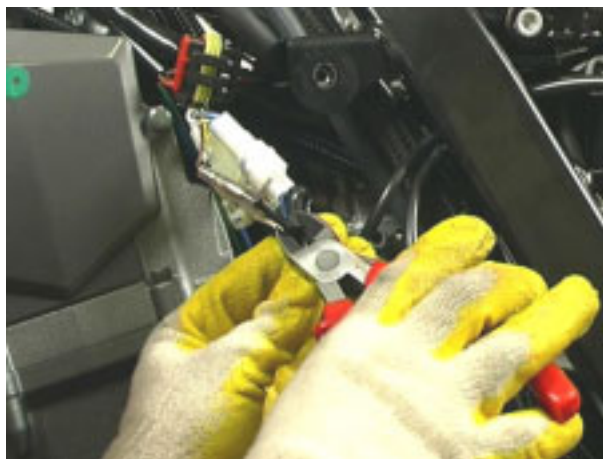

- Disconnect the speed sensor.

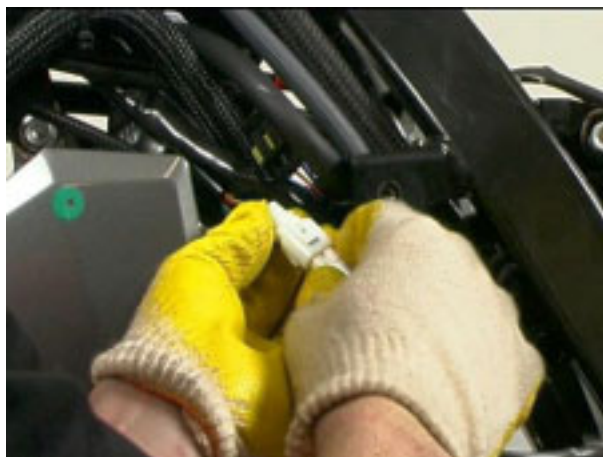



- Disconnect the neutral sensor connector.

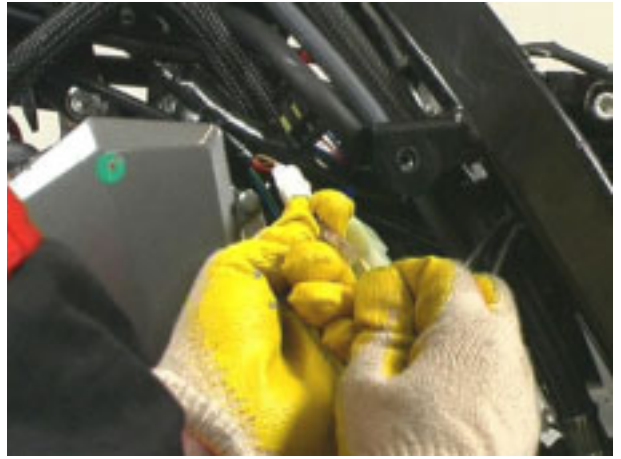

- Disconnect the generator connectors.

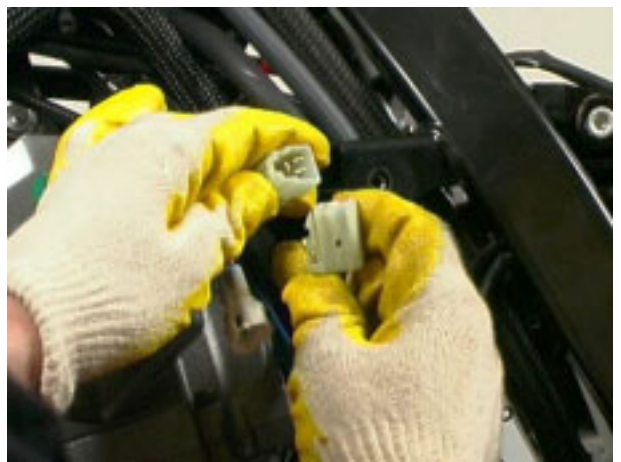
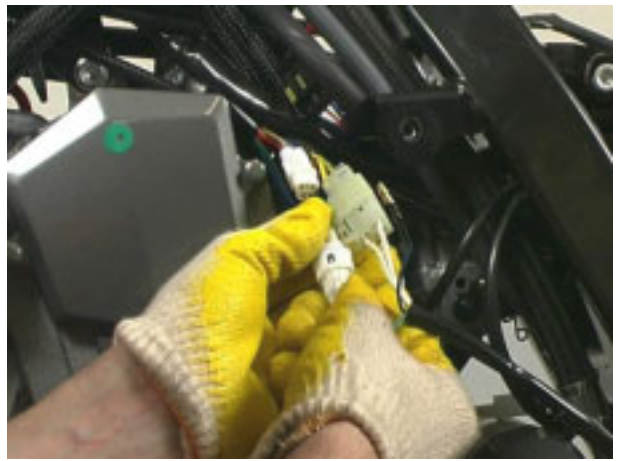

- Disconnect the stand sensor.

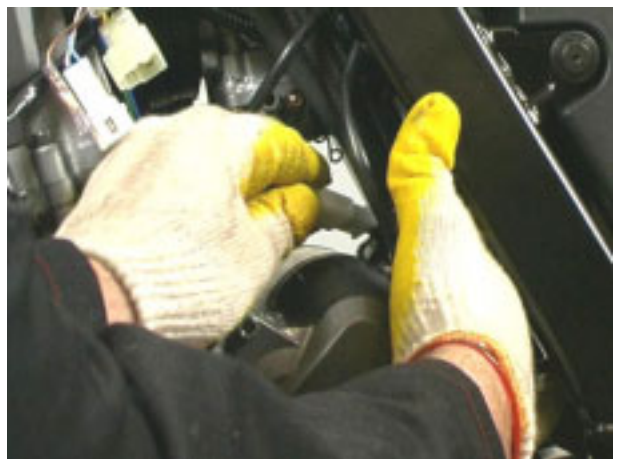

- Loosen and remove the screw and disconnect the ground cables.



- Disconnect the starter motor power cable.



- Loosen the nut and slide out the clutch cable from its housing.



- Disconnect the clutch cable from its lever.



- Disconnect the spark plug cap.



- Loosen the secondary air system tube tie.



- Slide out the tube from the throttle body.



- Disconnect the engine temperature sensor connector.



- Disconnect the expansion tank breather hose.



- Remove the tie from wiring.

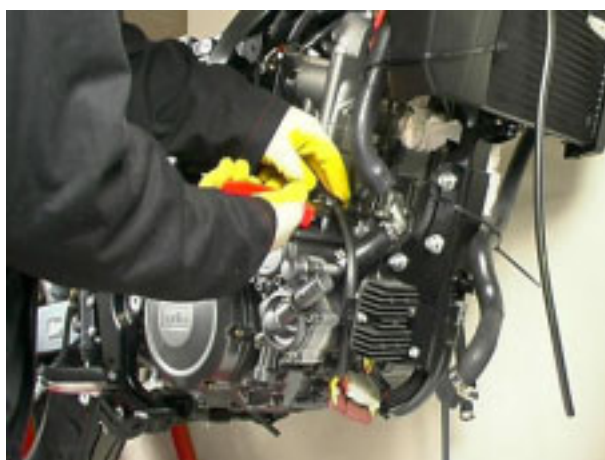

- Disconnect the generator connectors.

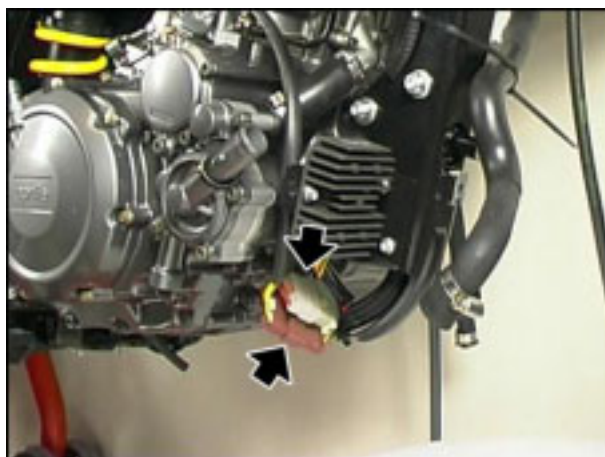

## PEGASO 650

- Prepare a container for collecting engine oil.
- Unscrew and remove the screw.



- Drain all engine oil.



- Loosen and remove the two screws, collect the spacers.



- Remove the sprocket cover.



- Remove the guide plate.



- Straighten the safety washer.



- Engage the first gear.
- Loosen and remove the nut and collect the safety washer.

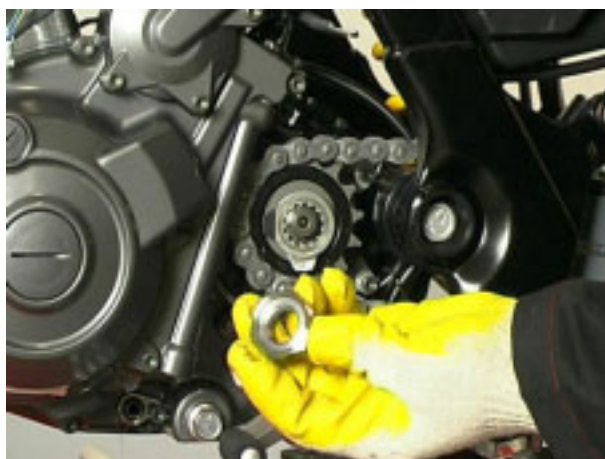



- Remove the chain from the sprocket and remove the sprocket.



- Loosen and remove the screw, collect the washer and slide out the cable guides.

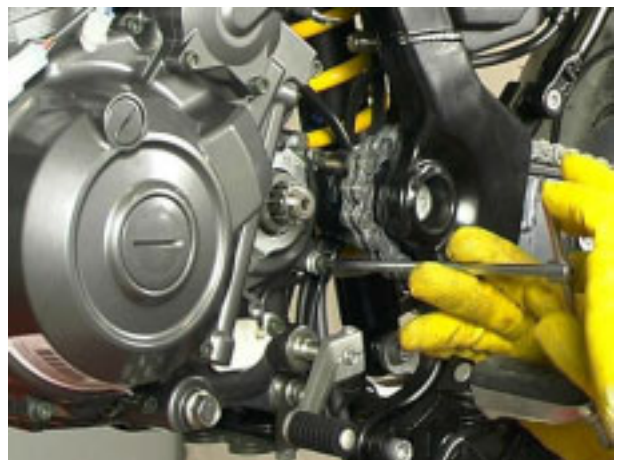

- Disconnect the neutral sensor.





- Loosen the ties and disconnect the tube from the air box.



- Support the engine with slings.
- Loosen and remove the ring nut on swinging arm shaft.

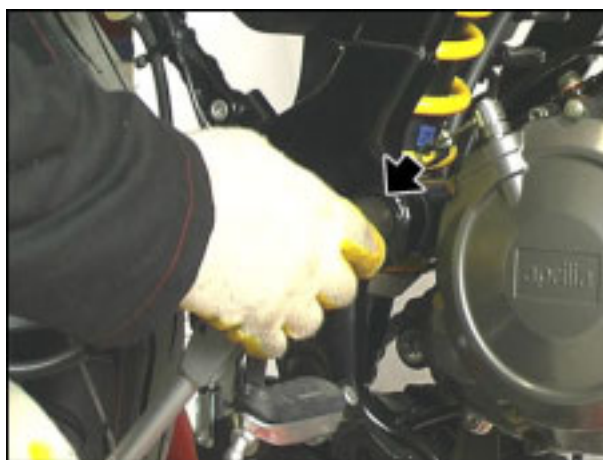

- Loosen the swinging arm adjuster bush.





- Slide out the shaft from the left side.



- Support the engine using a lift.
- Working on the right side, loosen and remove the two nuts.
- Slide out the two screws, on the opposite side.

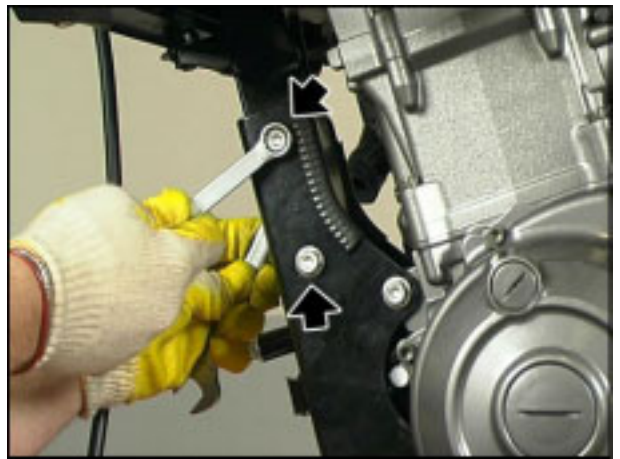

- Working on the right side, loosen and remove the two nuts from engine.
- Slide out the two screws, on the opposite side.



- Remove the engine front support.



- Working on the right side, loosen and remove the top nut.
- Slide out the screw, on the opposite side.



- Loosen and remove the two lower screws, collect the washers.

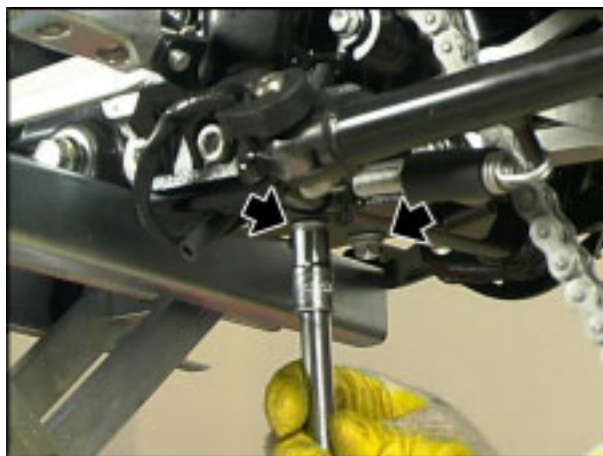

- Loosen the ties and remove the intake manifold.



- Lower the engine.



#### 4.1.2. REFITTING THE ENGINE

- Suitably fix the vehicle frame and lift the engine to desired position.



- Set the throttle body in the intake manifold and tighten the clamp.



- Tighten the two lower screws.

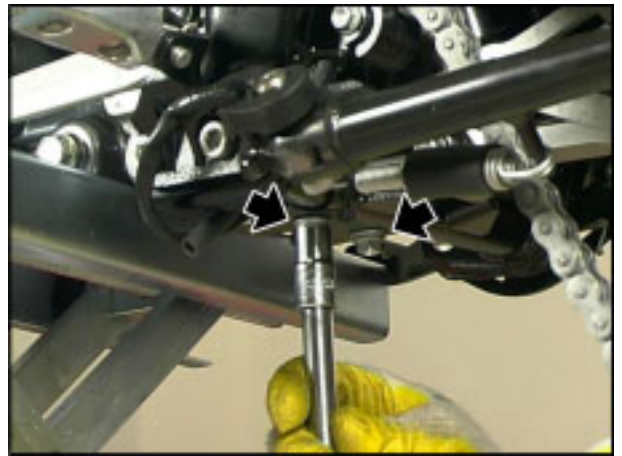

- Set the screw.
- Tighten the top nut.



- Fit the engine front support.



- Fit the two screws.
- Working on the right side, tighten the two nuts on engine.



- Fit the two screws.
- Working on the opposite side, tighten the two nuts.

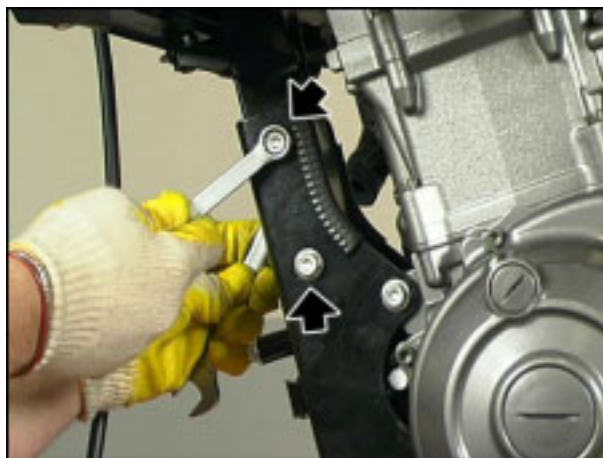

- Remove the engine lift.
- Fit the shaft.

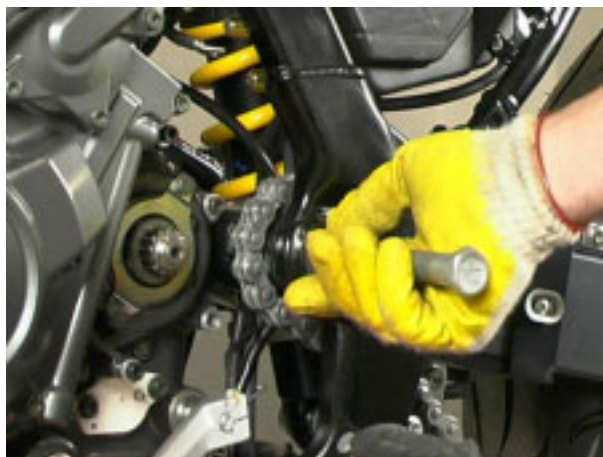

## PEGASO 650

- Fit the bushing and tighten it.
- Tighten the pin.



- Set the ring nut to the centring bush and tighten it.

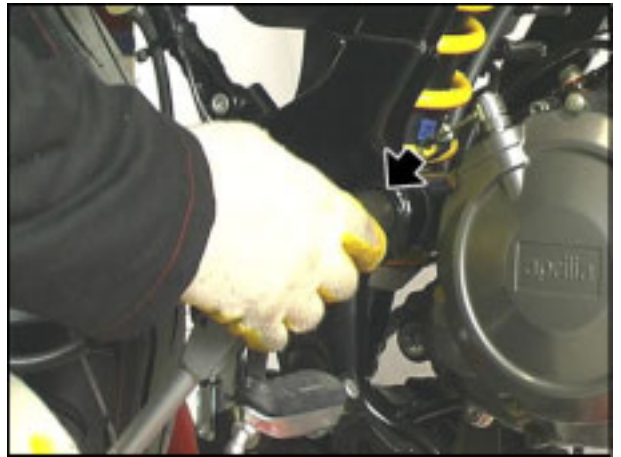

- Remove the slings.
- Set the air box hose and tighten the clamp.



- Connect the neutral sensor.





- Fit the cable guides and tighten the screw with washer.

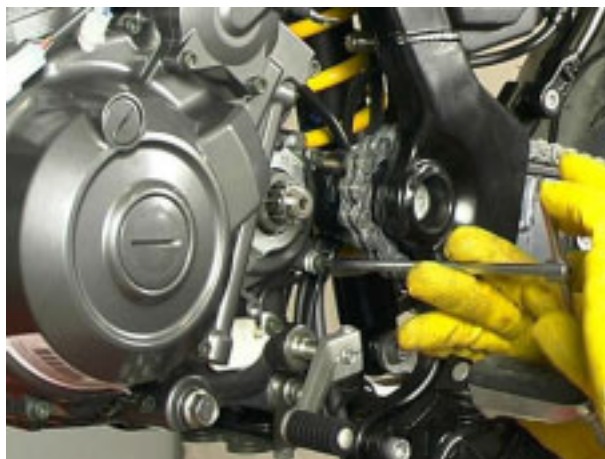

- Install the sprocket.
- Engage the first gear.



- Fit the safety washer and tighten the nut.

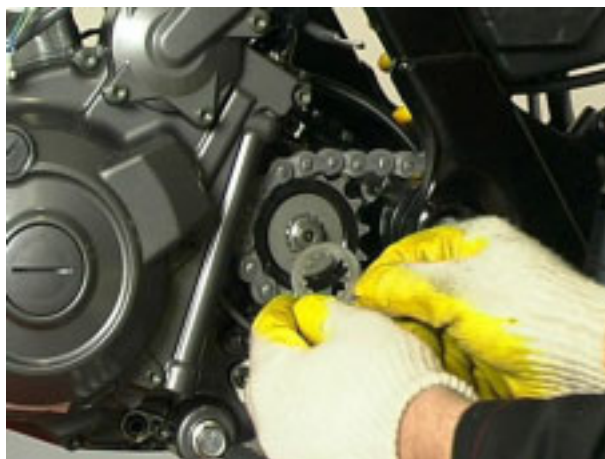



- Bend the safety washer.



- Refit the guide plate.



- Refit the sprocket cover.



- Fit and tighten the two screws with spacers.



- Fit and tighten the screw.



- Connect the generator connectors.
- Fit a tie to the wiring.

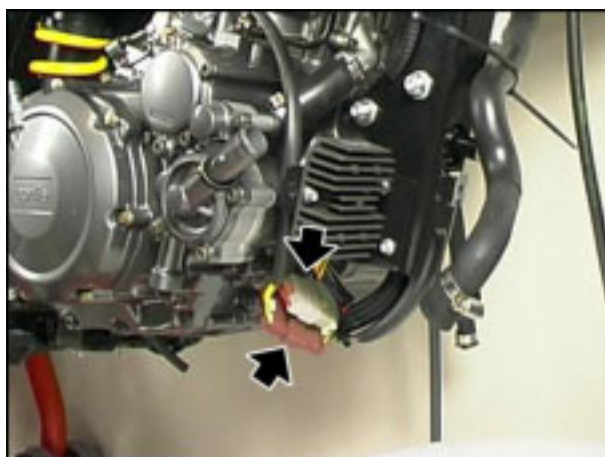



- Connect the expansion tank breather hose.



- Connect the engine temperature sensor connector.



- Fit the tube to the throttle body.



- Tighten the secondary air system tube tie.



- Connect the spark plug cap



- Connect the clutch cable to its lever.



- Fit the clutch cable in its housing and tighten the nut.



- Connect the starter motor power cable.





- Connect the ground cables and tighten the screw.



- Connect the stand sensor.

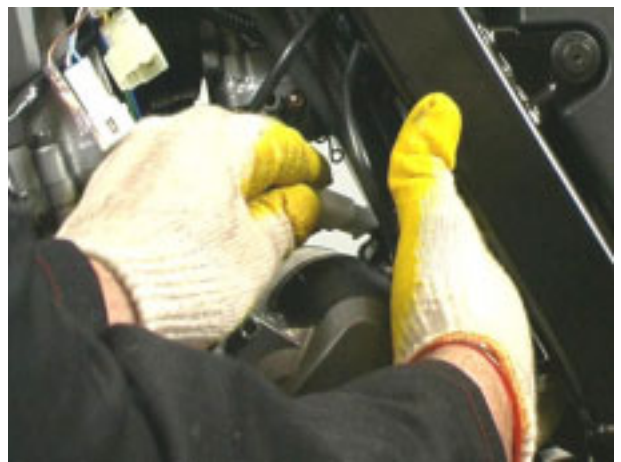

- Connect the generator connectors.

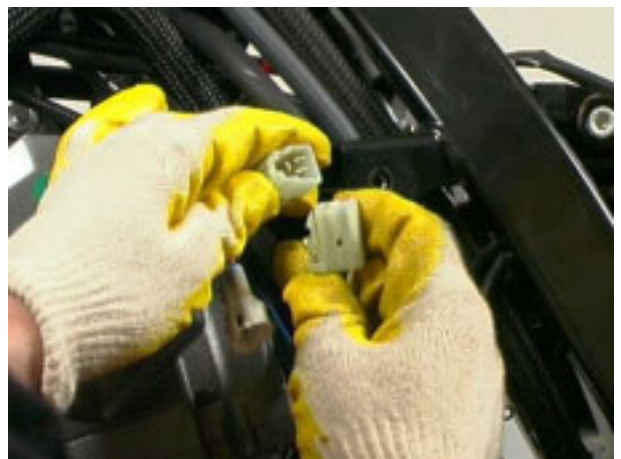



- Connect the neutral sensor connector.

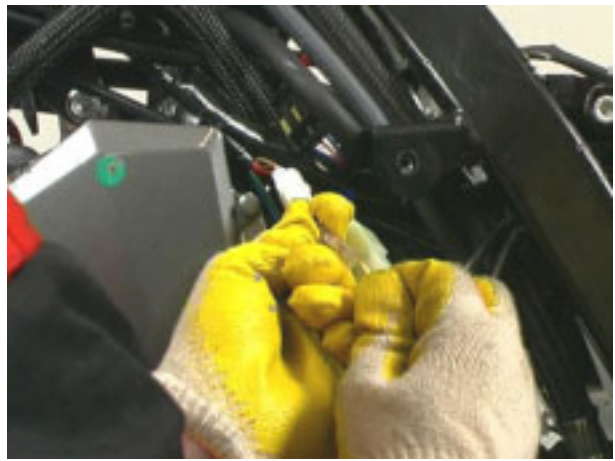

- Connect the speed sensor.
- Fit ties to the wiring.

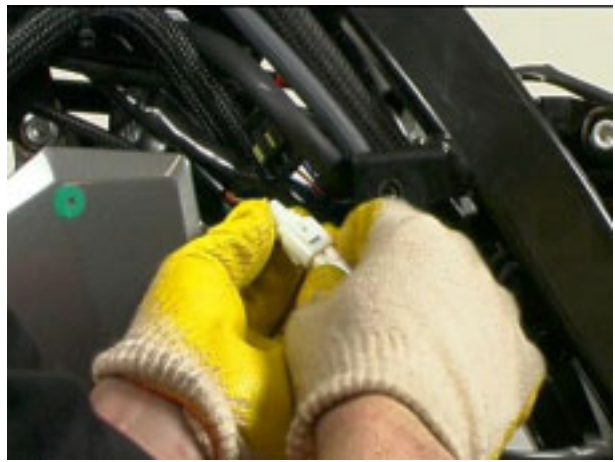

- Refit the clamp to fuel vapour recycle hose.



- Refit the air box connector.



- Fit the hose and tighten the clamp.



- Fit the hoses and tighten the clamp.



## 4.1.3. TIGHTENING TORQUES

| DESCRIPTION                | QUANTITY | SCREW / NUT | TIGHTENING TORQUES(Nm) | NOTES       |
|----------------------------|----------|-------------|------------------------|-------------|
| <b>FRAME</b>               |          |             |                        |             |
| sump guard                 | 3        | M6          | 8                      | -           |
| voltage regulator support  | 2        | M6          | 12                     | loctite 243 |
| coils to frame             | 2        | M5          | 6                      | loctite 243 |
| map sensor                 | 2        | M6          | 12                     | -           |
| seat support               | 4        | M8          | 25                     | loctite 243 |
| cradle fastener onto frame | 2        | M10         | 50                     | -           |

| <b>EXHAUST</b>                   |     |    |    |   |
|----------------------------------|-----|----|----|---|
| muffler to seat support fastener | 1+1 | M8 | 25 | - |
| exhaust pipe clamps fastener     | 2+1 | -  | 16 | - |
| exhaust pipes to engine fastener | 2+2 | M8 | 25 | - |

| <b>SIDE STAND</b> |   |          |    |             |
|-------------------|---|----------|----|-------------|
| side stand pin    | 1 | M10X1.25 | 10 | loctite 243 |
| switch screw      | 1 | M6       | 10 | -           |
| lock nut          | 1 | M10X1.25 | 30 | loctite 243 |

| <b>ENGINE</b>                             |   |     |    |   |
|---|---|-----|----|---|
| engine to cradle fastener                 | 2 | M10 | 50 | - |
| engine lower fastener                     | 1 | M10 | 50 | - |
| engine upper fastener                     | 1 | M10 | 50 | - |
| lower connection plate to frame fastener  | 2 | M10 | 50 | - |
| upper connection plates to frame fastener | 2 | M10 | 50 | - |
| gear shift lever                          | 1 | M6  | 10 | - |
| front sprocket case                       | 2 | M6  | 10 | - |

| <b>SWINGING ARM</b>                  |     |         |      |   |
|--------------------------------------|-----|---------|------|---|
| swinging arm shaft ring nut          | 1   | M17X1   | 35   | - |
| swinging arm shaft adj. bush         | 1   | M25X1.5 | 12   | - |
| swinging arm shaft                   | 1   | -       | 100  | - |
| shock absorber guard fastener        | 2   | 4.8X13  | 20   | - |
| chain tensioner screw and nut        | 1+1 | M8      | Man. | - |
| chain slider fastener                | 1   | 4.8X13  | 20   | - |
| rear stand bush                      | 1+1 | M6      | 12   | - |
| rear brake hose posit.plate fastener | 1   | M5      | 6    | - |
| chain guard fastener                 | 2   | M5      | 6    | - |

| <b>FOOTRESTS</b>               |     |     |    |   |
|--------------------------------|-----|-----|----|---|
| rider footrests to frame       | 2+2 | M10 | 50 | - |
| rear footrests to seat support | 2+2 | M8  | 25 | - |

## 4.2. SECONDARY AIR SYSTEM

### 4.2.1. SECONDARY AIR

The Secondary Air System (SAS) has been developed to reduce carbon oxide and unburnt hydrocarbon emissions in vehicles that are not equipped with a lambda sensor. Natural air (which is rich in oxygen) is channelled into the exhaust stream to trigger a post-combustion process.

The secondary air system is especially useful when the engine is idling and during warm-up, as the catalyst alone is not capable of triggering post-combustion under these operating conditions.

The post-combustion process is activated just outside of the combustion chamber and raises the temperature of the exhaust gasses for a quick light-off of the catalyst.



The secondary air system operates on pressure fluctuation in the exhaust system.

During depression stages, the exhaust takes in oxygen-rich air from the secondary air system so unburnt gasses in the exhaust stream -hot and active- can complete the combustion.

During overpressure stages, the secondary air reed valve cuts air supply to prevent backflow.

The reed valve is equipped with a cut-off device -controlled by a vacuum pick-up point on the intake manifold- that shuts down additional air during cut-off stages, as exceedingly lean exhaust gasses would lead to exhaust blowing, resulting in exhaust valve and catalytic converter damage.

Valve stays closed when engine is running.

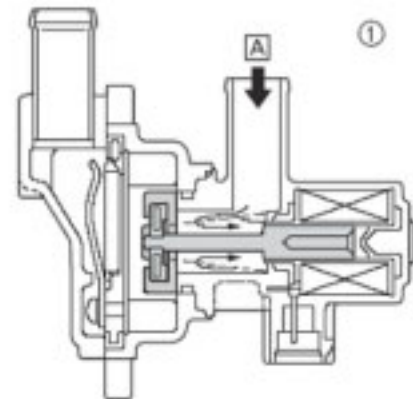

At low rpm the valve is activated to bring down carbon monoxide emissions.

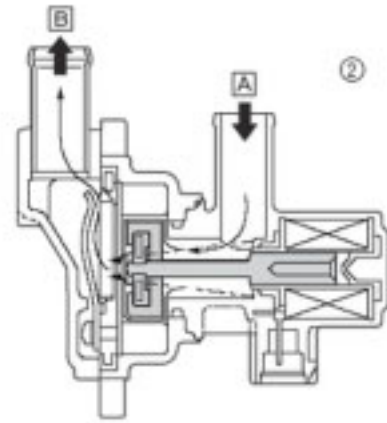
**WARNING**

When adjusting the CO rate, disable the Secondary Air System or exhaust gas dilution caused by the system would give a wrong reading of the carbon monoxide percentage. See CO ADJUSTMENT for instructions on how to disable the SAS.

**WARNING**

After setting the CO rate, remember to re-enable the Secondary Air System. The vehicle will operate regularly even with system disabled but in this case the harmful emissions will be higher. Moreover, overheating might derive due to air not circulating, thus causing damages to SAS tubes and unions.

**DANGER**

Stop air from circulating using only suitable equipment; using plugs to block off the air box scoop might overheat and damage the secondary air system and, if left there for a certain time, the plug might enter the intake channel while the vehicle is running, thus jamming the throttle and making the vehicle impossible to control.



**CYCLE PARTS**

**5**

**SUMMARY**

|        |                                      |    |
|--------|--------------------------------------|----|
| 5.1.   | OUTER STRUCTURES.....                | 3  |
| 5.1.1. | REMOVING THE HEADLIGHT.....          | 3  |
| 5.1.2. | REMOVING THE REAR FAIRING.....       | 6  |
| 5.1.3. | REMOVING THE OIL SUMP GUARD.....     | 8  |
| 5.1.4. | TIGHTENING TORQUES.....              | 9  |
| 5.2.   | FRONT FORK.....                      | 10 |
| 5.2.1. | DIAGRAM.....                         | 10 |
| 5.2.2. | REMOVING THE FORK LEGS.....          | 11 |
| 5.2.3. | INSTALLING THE FORK LEGS.....        | 14 |
| 5.2.4. | CHANGING FORK FLUID.....             | 17 |
| 5.2.5. | DISASSEMBLY.....                     | 19 |
| 5.2.6. | REASSEMBLY.....                      | 22 |
| 5.2.7. | CHECK.....                           | 25 |
| 5.2.8. | TIGHTENING TORQUES.....              | 27 |
| 5.3.   | STEERING BEARINGS.....               | 28 |
| 5.3.1. | ADJUSTING THE STEERING BEARINGS..... | 28 |
| 5.3.2. | TIGHTENING TORQUES.....              | 29 |

## 5.1. OUTER STRUCTURES

### 5.1.1. REMOVING THE HEADLIGHT

- Release and remove the six screws.



- Remove the unit.



- Disconnect the instrument panel connector.



- The right bracket stays on the vehicle because wiring is routed inside it. Release and remove the two outer screws.



- The left bracket stays secured to the headlight. Release and remove the two inner screws.

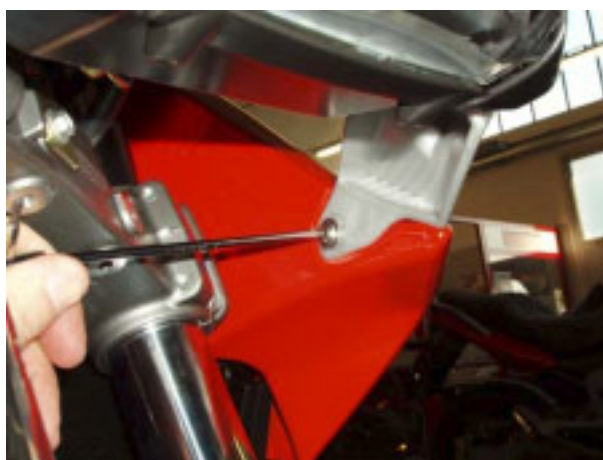
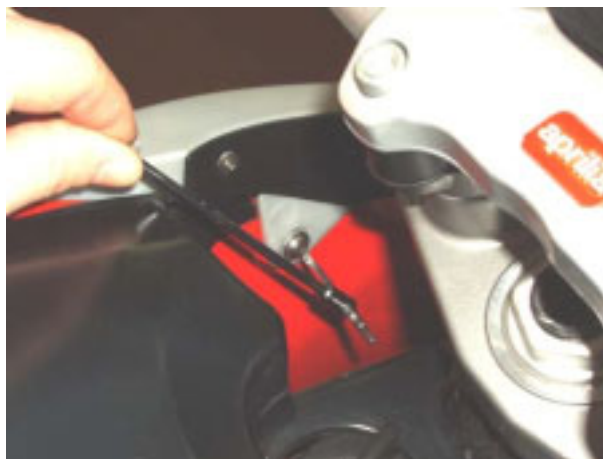

- Unscrew and remove the outer screw.

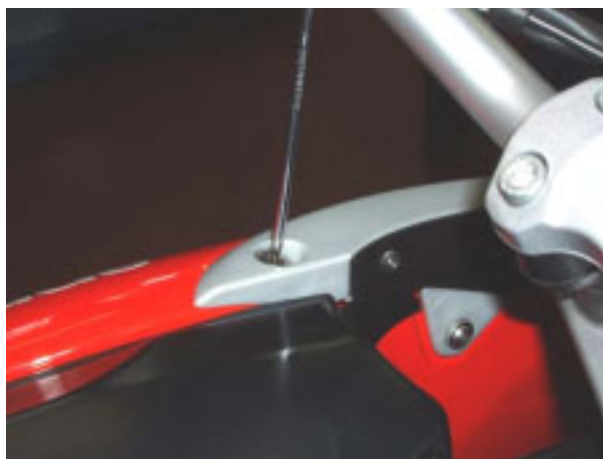

- Release the headlight wiring connector.

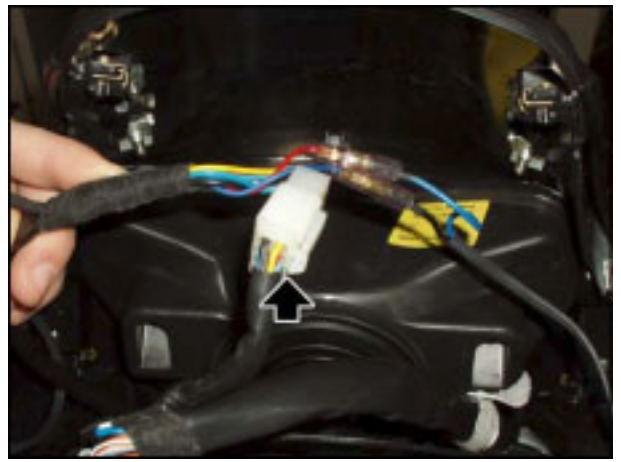

- Remove the headlight together with left mount.



**5.1.2. REMOVING THE REAR FAIRING**

- Remove the seat.
- Working on either side, release and remove the two side body panel screws and remove the side body panels.



- Loosen and remove the three passenger grab handle screws.
- Remove the grab handle.



- Working on either side, loosen and remove the front screw.



- Working on either side, loosen and remove the top screw.



- Working on either side, loosen and remove the two rear bottom screws.



- Raise the rear fairing.



- Disconnect the seat release cable.
- Remove the rear fairing.



**5.1.3. REMOVING THE OIL SUMP GUARD**

- Release and remove the sump guard front screw.



- Release and remove the sump guard rear screw.



- Remove the sump guard, pay attention to the breather hose.





## 5.1.4. TIGHTENING TORQUES

| DESCRIPTION                                     | QUANTITY | SCREW / NUT | TIGHTENING TORQUES(Nm) | NOTES       |
|---|----------|-------------|------------------------|-------------|
| <b>CENTRE BODYWORK</b>                          |          |             |                        |             |
| radiator spoiler                                | 3        | M6          | 5                      | -           |
| radiator cowling                                | 4        | M6          | 3                      | -           |
| number plate holder to seat support lower cover | 2        | M6          | 3                      | -           |
| cat's eye holder to number plate holder         | 2        | M5          | 6                      | -           |
| front mudguard                                  | 4        | M5          | 5                      | -           |
| rear mudguard                                   | 4        | M5          | 3                      | -           |
| front fairing to arch                           | 4        | M6          | 3                      | -           |
| inner conveyors to frame                        | 2        | M6          | 3                      | -           |
| external conveyors                              | 4 and 2  | M5 AND M6   | 3 and 3                | Manual      |
| instrument panel fairing cover                  | 4        | M6          | 2                      | -           |
| lug   | 4        | M6          | 3                      | -           |
| fairing side support to frame                   | 4        | M6          | 10                     | loctite 243 |
| side fairings to fairing side support           | 6        | M5          | 5                      | -           |
| bush and seat support lower cover               | 2        | M6          | 5                      | -           |
| seat support lower cover to seat support        | 4        | M6          | 4                      | -           |
| seat support lower cover to frame               | 2        | M6          | 4                      | -           |
| tail guard to seat support lower cover          | 4        | M5          | 2                      | -           |
| tail guard front cover                          | 4        | M4          | 0.5                    | Manual      |
| tail guard to seat support                      | 4        | M5          | 3                      | -           |
| tail guard-passenger belt                       | 2        | M6          | 12                     | -           |
| under-seat side body panels                     | 2        | M6          | 7                      | -           |
| front fairing lower cover                       | 3        | M6          | 7                      | -           |
| windshield to front fairing                     | 6        | M4          | 0.5                    | Manual      |
| instrument panel to arch                        | 3        | M6          | 5                      | -           |
| <b>SEAT</b>                                     |          |             |                        |             |
| hinge to seat fastener                          | 4        | NUT M6      | 7±20%                  | -           |

## 5.2. FRONT FORK

## 5.2.1. DIAGRAM

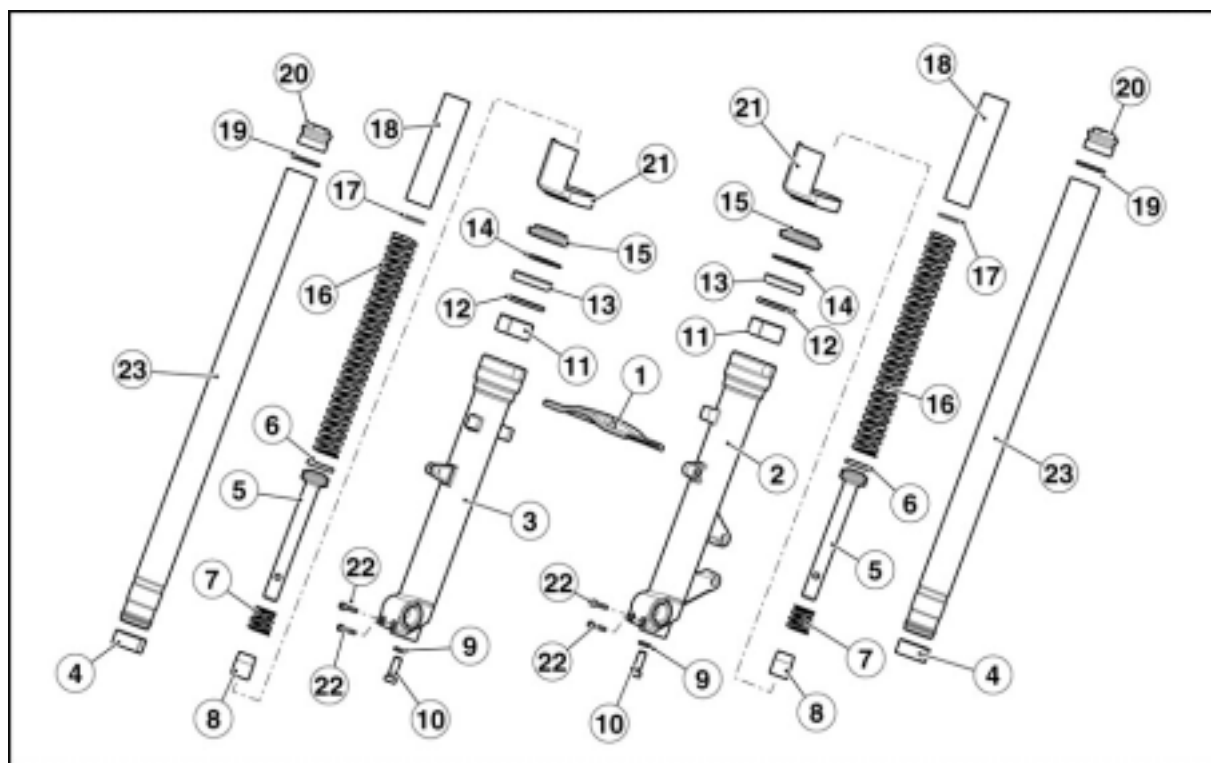

## Key:

1. Stiffening plate
2. Left sleeve
3. Right sleeve
4. Sliding bush
5. Damping rod
6. Damper rod ring
7. Counter spring
8. Buffer
9. Washer
10. Allen cheese-headed screw M12x1.25x25
11. Guide bush
12. Ring
13. Oil seal
14. Snap ring
15. Dust seal
16. Spring
17. Spring seat
18. Spacer
19. O-ring
20. Plug
21. Protection
22. Allen cheese-headed screw M6x20
23. Complete fork leg

### 5.2.2. REMOVING THE FORK LEGS

- Remove the headlight, see (REMOVING THE HEADLIGHT).
- Remove the fuel tank, see (REMOVING THE FUEL TANK).
- Support the stand front part using stand (OPT).
- Loosen and remove the two mudguard shell screws.



- Working on either side, loosen and remove the screw securing the front mudguard shell.



- Loosen and remove the two screws securing the rear mudguard shell.



- Loosen and remove the two screws securing fork plate and remove it.



- Loosen and remove the two screws securing the front brake calliper.
- Remove the front brake calliper, pay special attention not to pull the front brake lever to avoid pad jamming.



- Unscrew the wheel shaft nut, collect the washer.



- Working on either side, partially loosen the wheel shaft pinch bolts and completely loosen the wheel shaft.

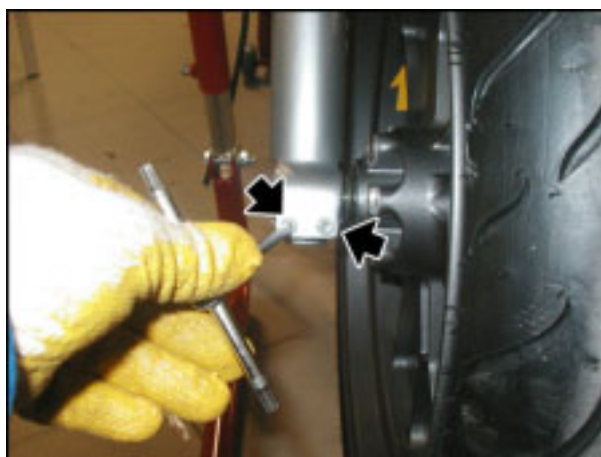

- Support the front wheel and manually withdraw the wheel shaft.
- Remove the wheel by withdrawing it from the front.



- Support the stanchion and loosen the three screws securing stanchions to bottom yoke.

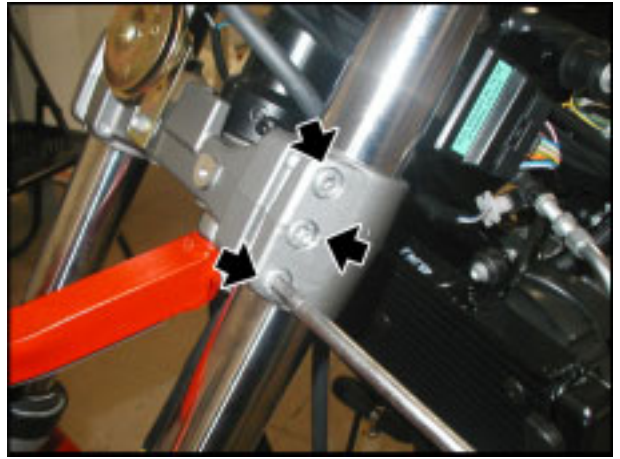

- Loosen the screw securing stanchion to top yoke.



- Slide out the stanchion, be careful not to damage it.



### 5.2.3. INSTALLING THE FORK LEGS

- Install the stanchion, be careful not to damage it.
- Take the stanchion in position and tighten the screw securing stanchion to top yoke.
- Support the stanchion and loosen the three screws securing stanchion to bottom yoke.
- Smear some grease all along the wheel shaft.
- Position the front wheel between the fork legs on the support.
- Move the wheel until its central hole and the holes on the fork are aligned.
- Set one of the two spacers between wheel hub and fork right leg.
- Position the other spacer between the wheel hub and the fork left leg.
- Push the wheel shaft fully home from the right side.

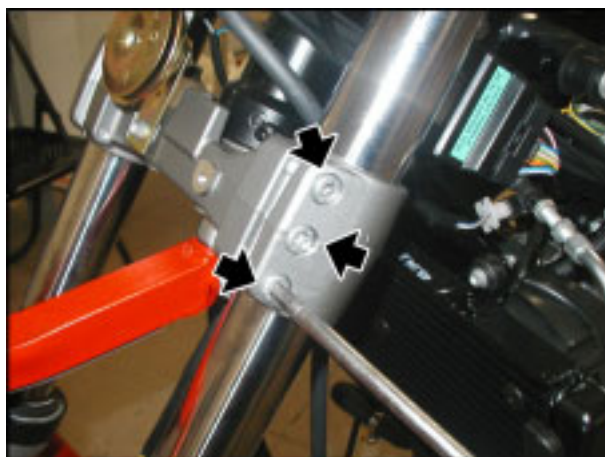

- Tighten the wheel shaft clamp bolts to the right.



- Install the washer to the shaft and tighten the wheel shaft nut.
- Tighten the wheel shaft clamp bolts to the left.
- Loosen the wheel shaft clamp bolts to the right.
- Press on the front end to settle the fork legs.
- Tighten the wheel shaft clamp bolts to the right.
- Remove the support that upon disassembly was put under the tyre.



- Fit the brake calliper, tighten the screws.
- Remove the front support stand.
- Remove the rear support stand.
- With pulled brake lever, press the handlebar repeatedly, thrusting the fork downwards. In this way the fork legs will settle properly.
- Position the vehicle on the stand.
- Tighten the wheel shaft clamp bolts on either side.



- Fit the fork plate and tighten the two screws.



- Fit the rear mudguard shell and tighten the two screws.

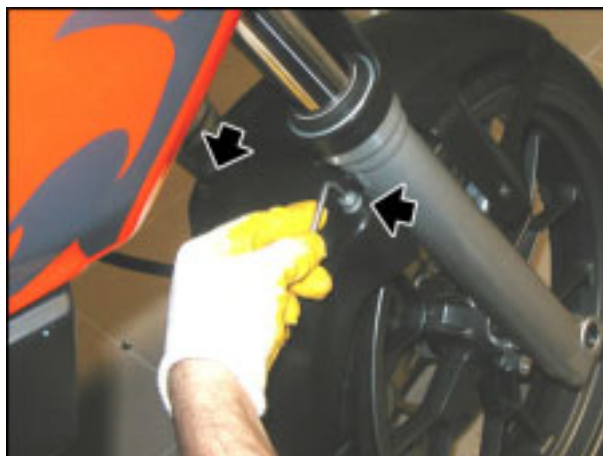

- Fit the front mudguard shell and tighten the two screws, working on either side.

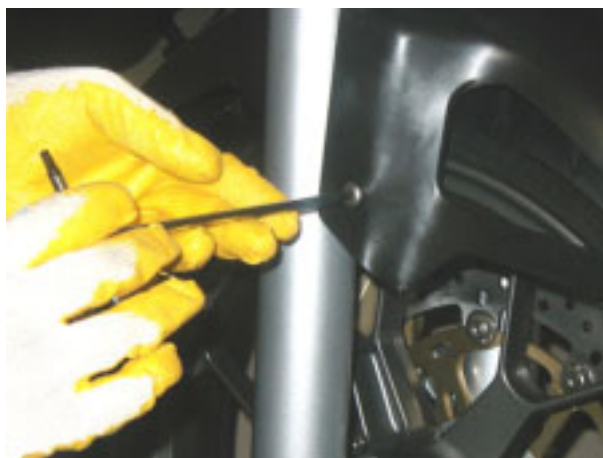

- Tighten the two mudguard shell screws.

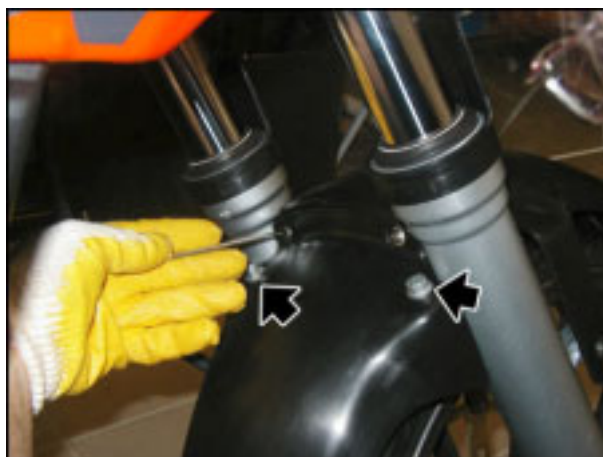



### 5.2.4. CHANGING FORK FLUID

**NOTE** The following procedure applies to both fork legs.

Periodically change the fork fluid, see (REGULAR SERVICE INTERVALS CHART).

**NOTE** While draining and filling fork fluid, the stanchion and its parts should be clamped in a vice; be careful not to tighten them too much and damage them; always use aluminium protections.

#### DRAINING

Drain oil as follows:

- Remove the fork leg, see (REMOVING THE FORK LEGS).
- Release and remove the top cap, be careful not to damage the surface and the O-ring.



- Remove the spring preload spacer.



- Collect the washer.



- Collect the spring.



- Drain oil in a container.

**NOTE** Pump the tube inside the stanchion to help oil drain out completely from the damper rod.



#### FILLING UP:

- Tighten the sleeve in a vice in vertical position.
- Pour oil in the tube.
- Pump with the stanchion, ensure that oil completely filled the damper rod.
- Install the spring, the washer and the spring preload spacer in this order.



- Tighten the top cap.



### 5.2.5. DISASSEMBLY

- Drain fluid from the fork leg.
- Clamp the sleeve in a vice, in horizontal position.
- Loosen the bottom screw.



- Clamp the sleeve in a vice, in vertical position.
- Remove the dust seal, prise with a screwdriver.



**WARNING**  
Be careful not to damage the tube edge and the dust seal.



- Pull up the dust seal to remove it.



- Remove the snap ring from inside the sleeve, using a screwdriver.



**WARNING**  
Be careful not to damage the sleeve edge.



- Unclamp the sleeve from the vice and remove the damper rod with bottom buffer.



- Clamp the sleeve in a vice, in vertical position.
- Firmly remove the tube with lower sliding bush.



- Remove the oil seal.



- Remove the shim.



- Remove the top sliding bush.



**5.2.6. REASSEMBLY**

- Fit the top sliding bush.



- Fit the oil seal to the fork leg.



- Fit the shim to the fork leg.



- Install the damper rod with bottom buffer to the tube.



- Install the tube to the sleeve, fit the shim and oil seal in the relevant seats in the sleeve.

**WARNING**

Be careful not to damage the sleeve edge.



- Fit the snap ring from inside the sleeve, using a screwdriver.



- Install the dust seal.



- Clamp the sleeve in a vice, in horizontal position.
- Tighten the bottom screw.



- Clamp the sleeve in vertical position.
- Pour oil inside the stanchion, ensure it fills up all damper rod channels.
- Pump with the stanchion, ensure that oil completely filled the damper rod.
- Insert the spring.



- Insert the washer.



- Install the spring preload spacer.



- Start the plug onto stanchion tube, be careful not to damage the O-ring. Tighten the plug to the specified torque.





### 5.2.7. CHECK

#### STANCHION

Inspect the sliding surface for scoring and/or scratching.  
Eliminate minor scoring with wet sand paper (grain size 1).  
Replace the stanchion if badly scored.  
Check for stanchion buckling using a dial gauge.  
Replace the stanchion if buckled beyond the service limit.

**Buckling limit: 0.2 mm (0.00787 in.)**



#### **DANGER**

**NEVER attempt to straighten a buckled stanchion as this would weaken the overall structure leading to a dangerous riding condition.**

#### SLIDER

Inspect for damage and/or cracking. Replace if damaged.

#### SPRING

Check spring conditions and straightness.  
Ensure that there is no interference between one winding and the other.

Check conditions of the following components:

- top sliding bush;
- bottom sliding bush;



- damper rod.  
Change any component which is badly worn or damaged.



**WARNING**  
Remove any residues from the bushes, be careful not to scratch the surface.



Renew the following components on assembly:

- seal;



- dust seal;



- O-ring on the plug.



## 5.2.8. TIGHTENING TORQUES

| DESCRIPTION                      | QUANTITY | SCREW / NUT | TIGHTENING TORQUES(Nm) | NOTES |
|----------------------------------|----------|-------------|------------------------|-------|
| <b>BRAKING SYSTEM</b>            |          |             |                        |       |
| front brake calliper             | 2        | M10X1.25    | 50                     | -     |
| rear brake lever pin             | 1        | M8          | 20                     | -     |
| rear brake fluid tank            | 1        | M5          | 6                      | -     |
| rear brake rod lock nut          | 1        | M6          | Manual                 | -     |
| <b>FRONT WHEEL</b>               |          |             |                        |       |
| wheel shaft nut                  | 1        | -           | 80                     | -     |
| <b>FRONT SUSPENSION</b>          |          |             |                        |       |
| fork leg fastener to top yoke    | 1+1      | M8          | 25                     | -     |
| fork leg fastener to bottom yoke | 3+3      | M8          | 25                     | -     |
| steering tube ring nut           | 1        | M25X1.5     | 7                      | -     |
| top yoke plug                    | 1        | M22X1       | 100                    | -     |
| fork hub plug                    | 2+2      | M6          | 12                     | -     |
| cable guide for front brake line | 1        | M6          | 12                     | -     |
| stiffening plate                 | 4        | M6X20       | 12                     | -     |

### 5.3. STEERING BEARINGS

#### 5.3.1. ADJUSTING THE STEERING BEARINGS

- Position the vehicle on the rear stand.
- Working on either side, loosen the screw securing the fork leg to the top yoke.

**Tightening torque: 5 kgm (50 Nm).**



- Remove the nut from the steering tube.

**Tightening torque: 10 kgm (100 Nm).**

- Slide out the yoke complete with handlebar from the fork legs.
- Adjust bearing load, using the suitable tool (no. 8163500).

**Tightening torque: 10 kgm (100 Nm).**



## 5.3.2. TIGHTENING TORQUES

| DESCRIPTION                      | QUANTITY | SCREW / NUT | TIGHTENING TORQUES(Nm) | NOTES |
|----------------------------------|----------|-------------|------------------------|-------|
| <b>FRONT SUSPENSION</b>          |          |             |                        |       |
| fork leg fastener to top yoke    | 1+1      | M8          | 25                     | -     |
| fork leg fastener to bottom yoke | 3+3      | M8          | 25                     | -     |
| steering tube ring nut           | 1        | M25X1.5     | 7                      | -     |
| top yoke plug                    | 1        | M22X1       | 100                    | -     |
| fork hub plug                    | 2+2      | M6          | 12                     | -     |
| cable guide for front brake line | 1        | M6          | 12                     | -     |
| stiffening plate                 | 4        | M6X20       | 12                     | -     |

WIRING DIAGRAM

6

**SUMMARY**

6.1. ELECTRIC SYSTEM ..... 3  
6.1.1. CHECKING THE ELECTRICAL COMPONENTS ..... 3  
6.1.2. WIRING DIAGRAM..... 9

6.1. ELECTRIC SYSTEM

6.1.1. CHECKING THE ELECTRICAL COMPONENTS

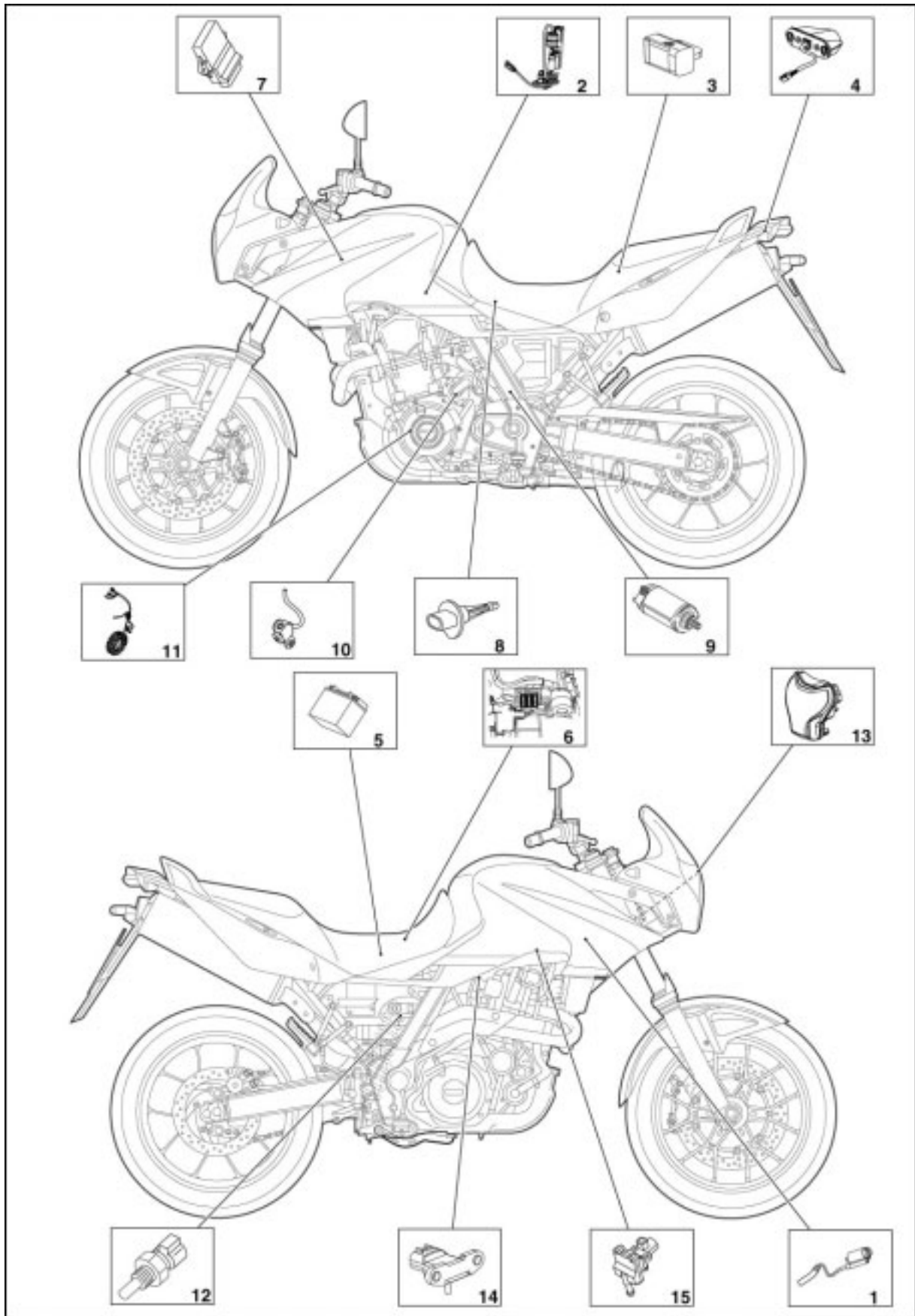



**1 COIL**

Primary coil resistance 3.4 ~ 4.6 ohm at 20 °C (68 °F)  
(across red/black cable and orange cable)

Secondary coil resistance 10.4 ~ 15.6 kohm at 20 °C (68 °F)  
(across red/black cable and spark plug cable)

Spark plug resistance 10.0% kohm at 20°C (68°F)

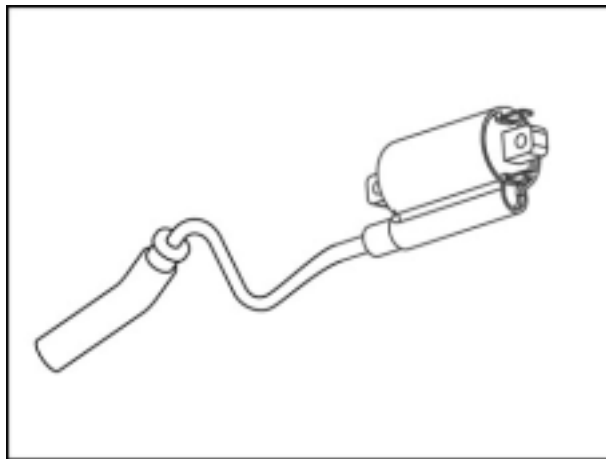
**2 FUEL PUMP**

Fuel pressure 324 kPa (3.24 kg/sq. cm, 46.1 psi)

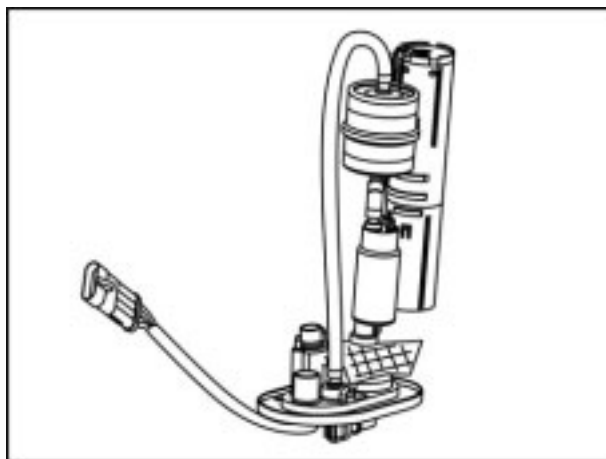
**3 BANK ANGLE SENSOR**

Voltage to be measured (across yellow/green and black/blue cable)

Less than 65° slant 0.4 ~ 1.4 V

More than 65° slant 3.7 ~ 4.4 V

Note: the sensor correct operation can also be checked via the instrument panel.

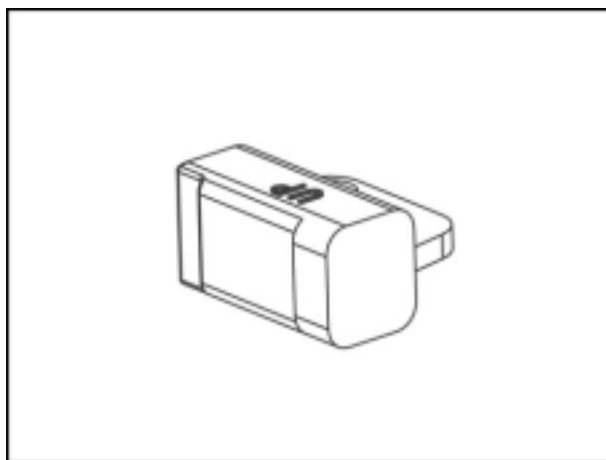
**4 TAIL LIGHT**

Led

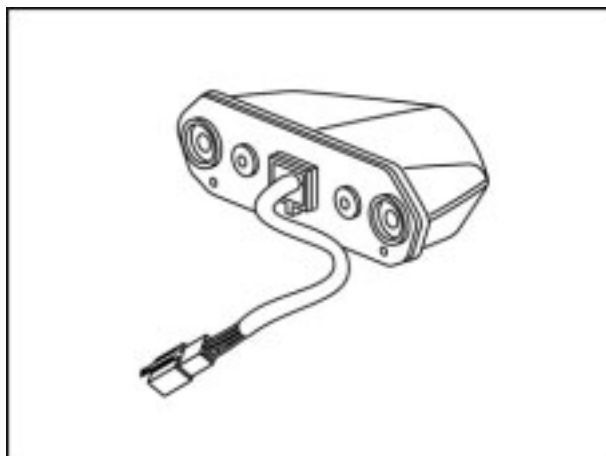

## PEGASO 650

## 5 BATTERY

12 V – 10Amp/h MF

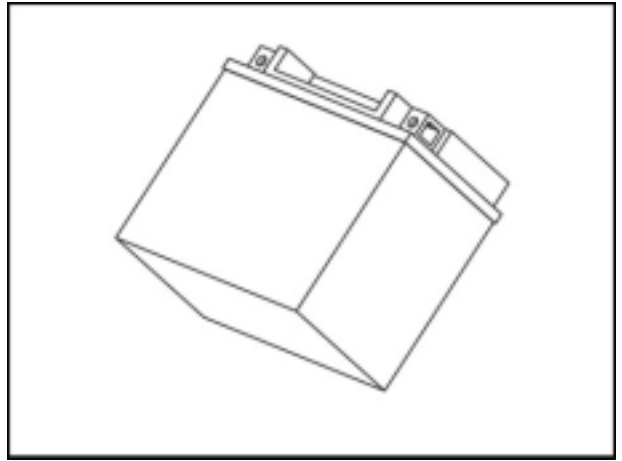

## 6 FUSES

**20 A Fuse (yellow):****From battery to:**

ignition switch, voltage regulator, electric cooling fan.

**15A Fuse:****From ignition switch to:**

all light loads.

**7,5A Fuse:****From ignition switch to:**

ignition, starting safety logic.

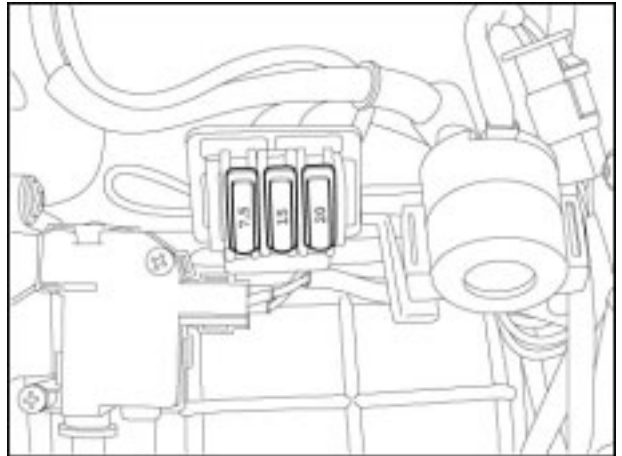

7 CONTROL UNIT

ECU

| Pin No. |                          | Pin No. |                              |
|---------|--------------------------|---------|------------------------------|
| 1       | (-) Coil                 | 14      | GND                          |
| 2       |                          | 15      | (-) Injectors                |
| 3       | (+) Key                  | 16      | (+) In from Injection relay  |
| 4       | (-) Secondary Air System | 17      | (-) Light relay              |
| 5       | (+) Injection sensor 5V  | 18      | (-) Injection relay          |
| 6       |                          | 19      | (-) Injection relay          |
| 7       | GND                      | 20      | (-) Injection control mass   |
| 8       | (+) Pick-Up              | 21      | TPS signal                   |
| 9       | Speed signal             | 22      | MAP signal                   |
| 10      |                          | 23      | Air temperature signal       |
| 11      | Bank angle signal        | 24      | Water temperature signal     |
| 12      | K Line                   | 25      | Side stand from instr. panel |
| 13      | In Starter button        | 26      | Neutral from instr. panel    |

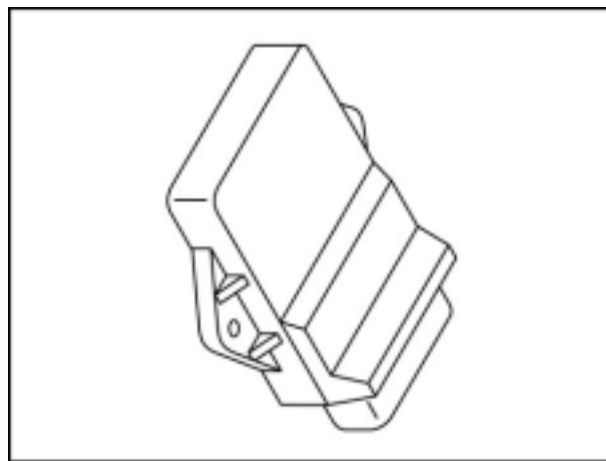

8 INTAKE AIR TEMPERATURE SENSOR

Intake air temperature sensor resistance:  
2.21 ~ 2.69 ohm at 20 °C

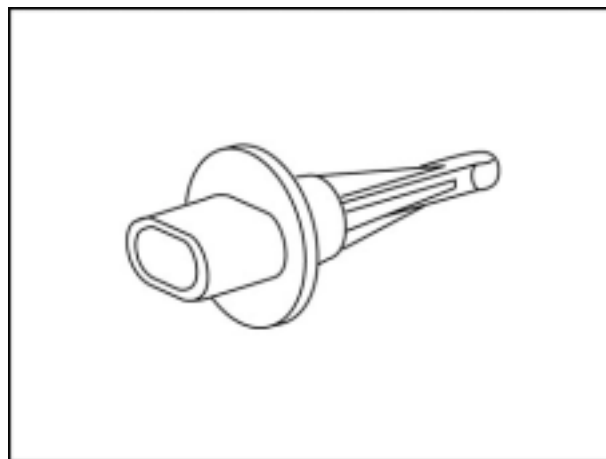

**PEGASO 650****9 STARTER MOTOR**

12V Power supply  
Max. absorption 0.8 kW

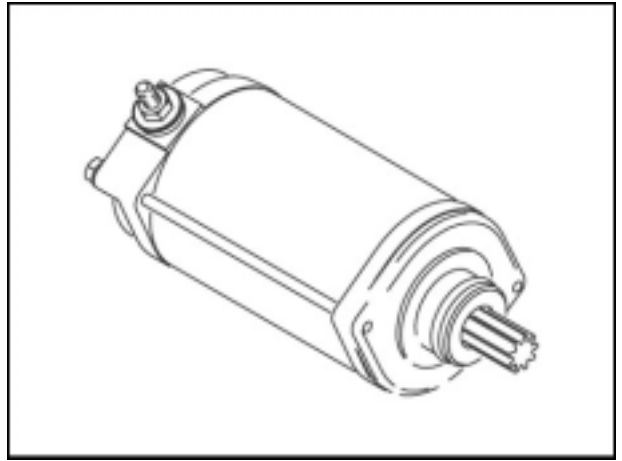
**10 PICK UP SENSOR**

192 ~ 288 ohm at 20°C (across blue/yellow and green/white)

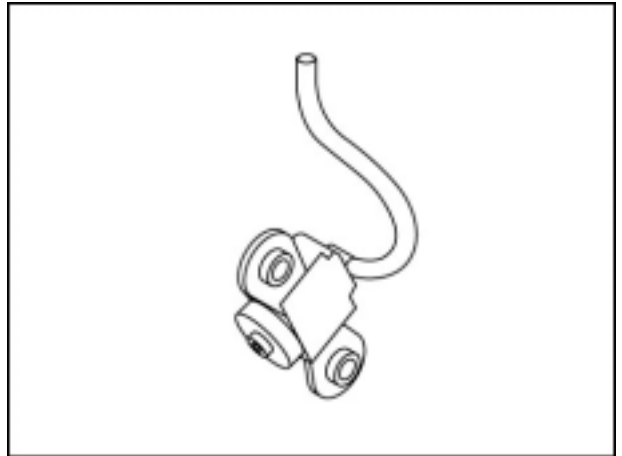
**11 GENERATOR**

Max. power 290 Watt  
Recharge voltage: 14V 5000 rpm (measured at battery terminals)  
Stator coil resistance 0.224 ~ 0.336 ohm at 20 °C (68 °F)  
(across white cable and white cable)

**12 COOLANT TEMPERATURE SENSOR**

Coolant temperature sensor resistance:

2.21 ~ 2.69% kohm at 20°C (68°F)  
0.310 ~ 0.326 kohm at 80°C (176°F)  
0.140 ~ 0.145 kohm at 110°C (230°F)

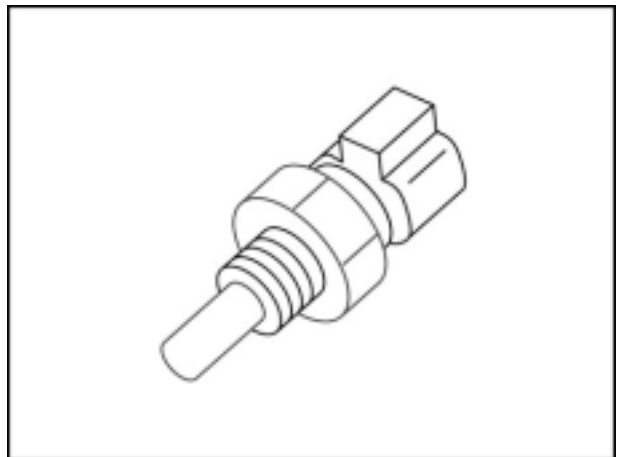

**13 HEADLIGHT**

Low beam: 12 V – 55 W in H11  
High beam: 12 V – 55 W in H11  
Front parking light: 12 V – 5 W

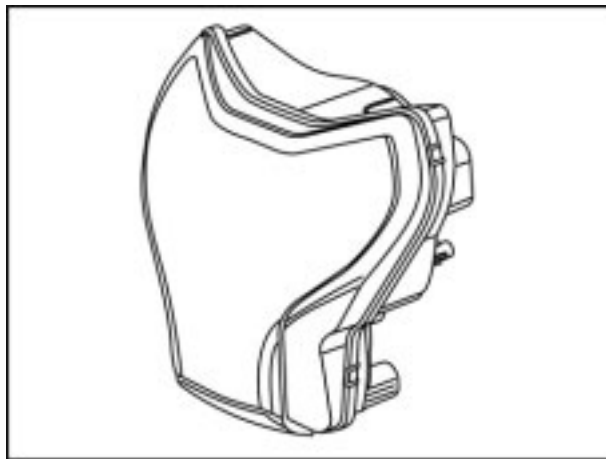
**14 INTAKE AIR PRESSURE SENSOR**

Intake air pressure sensor voltage: 3.4 to 3.8 V with engine off and key ON

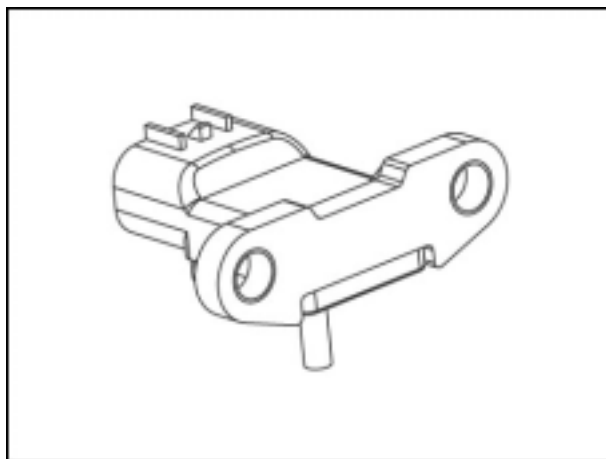
**15 SAS VALVE ACTUATOR**

SAS solenoid valve resistance  
18 ~ 22 ohm at 20 °C (68 °F) (across brown/red cable and red/white cable)

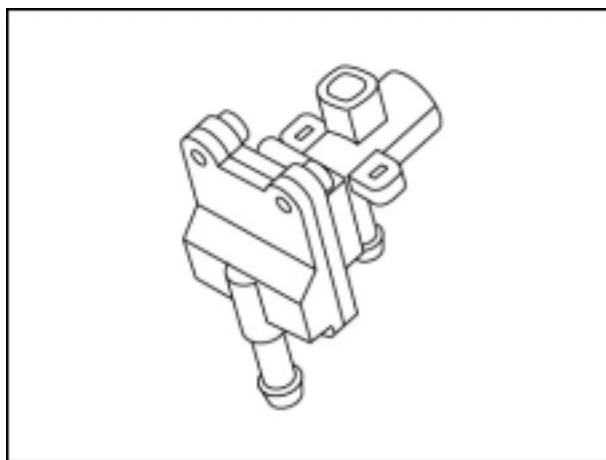

6.1.2. WIRING DIAGRAM

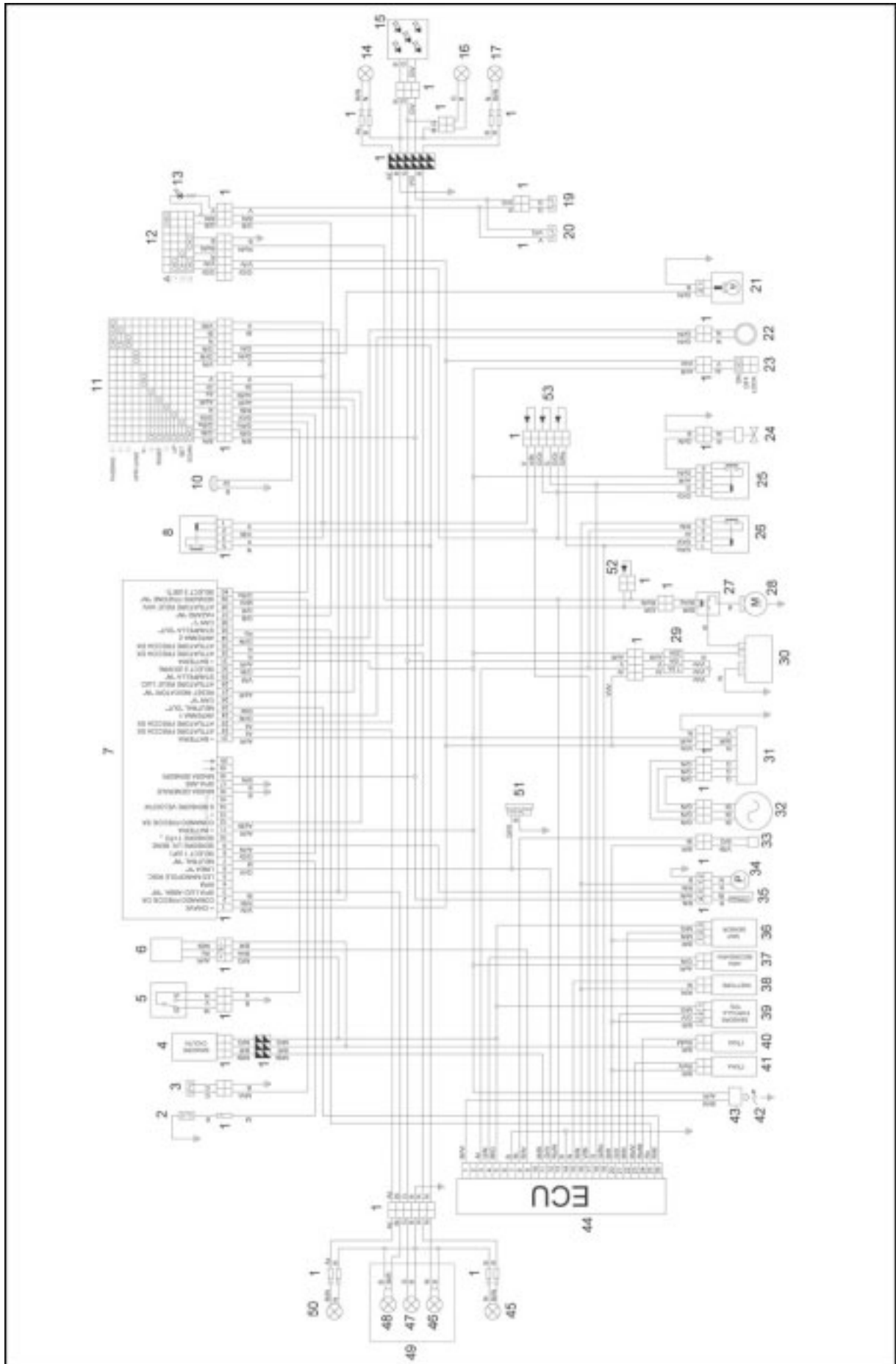

**Key:**

1. Multiple connectors
2. Neutral switches
3. Clutch switch
4. Water sensor
5. Side stand switch
6. Speed sensor
7. Instrument panel
8. Light relay
9. ----
10. Warning horn
11. Left dimmer switch
12. Right dimmer switch
13. HAZARD button back lighting
14. Rear left direction indicator
15. Tail light
16. Number plate light
17. Rear right direction indicator
18. ----
19. Rear stoplight switch
20. Front stoplight switch
21. Electric lock
22. Immobilizer antenna
23. Key-operated switch
24. Fan
25. Fan relay
26. Injection relay
27. Starter relay
28. Starter motor
29. Fuses
30. Battery
31. Voltage regulator
32. Generator
33. Pick up
34. Fuel pump
35. Fuel level sensor
36. Map sensor
37. Secondary air
38. Injector
39. Throttle Position Sensor (TPS)
40. Water temperature sensor
41. Air temperature sensor
42. Spark plug
43. Coil
44. ECU
45. Right direction indicator
46. Low beam bulb
47. Parking light bulb
48. High beam bulb
49. Headlight
50. Front left direction indicator
51. Self-diagnosis connector
52. Diode
53. Diode module

**WIRE COLOUR CODING**

|           |            |
|-----------|------------|
| <b>Ar</b> | Orange     |
| <b>Az</b> | Light blue |
| <b>B</b>  | Blue       |
| <b>Bi</b> | White      |
| <b>G</b>  | Yellow     |
| <b>Gr</b> | Grey       |
| <b>M</b>  | Brown      |
| <b>N</b>  | Black      |
| <b>R</b>  | Red        |
| <b>Ro</b> | Pink       |
| <b>V</b>  | Green      |
| <b>Vi</b> | Violet     |



**aprilia s.p.a.**  
via G. Galilei, 1  
30033 Noale (VE) Italy  
tel. +39 041.5829111  
fax +39 041.5829190  
[www.aprilia.com](http://www.aprilia.com)  
[www.serviceaprilia.com](http://www.serviceaprilia.com)