

BOMBARDIER
RECREATIONAL PRODUCTS



OPERATOR'S GUIDE

QUEST 500

2002

704 000 020



WARNING

Read this guide thoroughly.
It contains important safety information.
Minimum recommended operator age:
16 years old.

Particularly important information in this *Operator's Guide* is designated by the following:



The Safety Alert Symbol means ATTENTION!



WARNING

Identifies an instruction which if not followed, may cause injuries including the possibility of death.

CAUTION: Denotes an instruction which if not followed, may damage the ATV and/or components.

WARNING

YOUR ATV CAN BE HAZARDOUS TO OPERATE. A collision or rollover can occur quickly, even during routine maneuvers such as turning and driving on hills or over obstacles, if you fail to take proper precautions.

For your safety, understand and follow all the warnings contained in the *Operator's Guide*, the *Safety Handbook* and the labels on your vehicle. **Failure to follow these warnings can result in SEVERE INJURY OR DEATH.**

Keep this *Operator's Guide* and the *Safety Handbook* with the vehicle at all times.

In USA, products are distributed by Bombardier Motor Corporation of America. In Canada, products are distributed by Bombardier Inc.

The following are trademarks of Bombardier Inc. or its subsidiaries:

BOMBARDIER®
ROTAX®

† Simple Green is a registered trademark of Sunshine Markers Inc.

BOMBARDIER
RECREATIONAL PRODUCTS



FOREWORD

Congratulations on your purchase of a new Bombardier all-terrain vehicle (ATV). It is backed by the Bombardier warranty and a network of authorized Bombardier ATV dealers ready to provide the parts, service or accessories you may require.

Your dealer is committed to your satisfaction. He has taken training to perform the initial set-up and inspection of your vehicle as well as completed the final adjustment before you took possession. At delivery, your dealer would have explained the vehicle for the operation, maintenance and safety features. We trust you have taken full advantage of this! If you need more complete servicing information, please ask your dealer about the proper model-year *ATV Shop Manual*.

At delivery, you were also informed of the warranty coverage and completed the Warranty Registration Form which is to be sent to us for processing. In the near future you should be receiving a warranty card which will confirm our receipt of the registration as well as be used for warranty or recall purposes.

You are invited to contact our customer assistance center should you experience problems which cannot be resolved by an authorized Bombardier ATV dealer.

It is understood that this guide may be translated into another language. In the event of any discrepancy, the English version shall prevail.

The information and components/system descriptions contained in this document are correct at the time of publication. Bombardier Inc. however, maintains a policy of continuous improvement of its products without imposing upon itself any obligation to install them on products previously manufactured. Due to late changes, it may have some differences between the manufactured product and the descriptions and/or specifications in this guide. Bombardier Inc. reserves the right at any time to discontinue or change specifications, designs, features, models or equipment without incurring any obligation upon itself.

The illustrations in this document show the typical construction of the different assemblies and may not reproduce the full detail or exact shape of the parts. However, they represent parts that have the same or similar function.

Specifications are given in the SI metric system with the SAE U.S. equivalent in parenthesis. Where precise accuracy is not required, some conversions are rounded off for easier use.

We recommend genuine Bombardier products for replacement parts and accessories. They've been especially designed for your vehicle and manufactured to meet Bombardier's demanding standards.

A *Shop Manual* can be obtained for complete service, maintenance and more repair information.

TABLE OF CONTENTS

NOTICE	4
SPECIAL SAFETY MESSAGES	5
OPERATION WARNINGS	7
BOMBARDIER LIMITED WARRANTY NORTH AMERICA: 2002 BOMBARDIER® ATV	34
BOMBARDIER LIMITED WARRANTY INTERNATIONAL: 2002 BOMBARDIER® ATV	37
FREQUENTLY ASKED QUESTIONS	40
EMISSION REQUIREMENTS	41
LOCATION OF THE IMPORTANT LABELS	42
HOW TO IDENTIFY YOUR ATV	45
Engine and Vehicle Identification Number Location	45
CONTROLS/INSTRUMENTS/EQUIPMENTS	46
1) Throttle Lever	47
2) Front Brake Lever.....	47
3) Rear Brake Lever.....	47
4) Brake Lever Lock	48
5) Transmission Lever	48
6) Headlight Switch	49
7) Engine Stop Switch	50
8) Start Button	50
9) Indicator Lights Cluster	50
10) Speedometer	51
11) Ignition Switch	52
12) Choke Knob Lever.....	52
13) Fuel Tank Cap.....	52
14) Fuel Gauge	53
15) Fuel Valve.....	53
16) Rear Brake Pedal	53
17) Rewind Starter Handle (if so equipped)	54
18) Footpeg	54
19) Storage Compartment.....	54
20) Seat Latch	55
21) Front/Rear Cargo Racks	55
22) Air Duct	55
23) Trailer Hitch	56
24) Radiator Cap.....	56
25) 12-Volt Power Outlet.....	56
26) Fuses.....	57
Winch (if so equipped)	57
Winch Control Switch (if so equipped).....	57
Fairlead (if so equipped)	57

LIQUIDS	58
Fuel	58
Engine/Transmission Oil	58
Engine Coolant	60
Brake Fluid	61
Battery Electrolyte	62
BREAK-IN PERIOD	64
Engine	64
Belt	64
10-Hour Inspection	64
PRE-OPERATION CHECK	65
OPERATING INSTRUCTIONS	66
General	66
Initial Cold Starting	66
Warm Engine Starting	67
Emergency Manual Starting (if so equipped)	67
Stopping the Engine	67
Shifting the Transmission	67
SPECIAL PROCEDURES	68
Flooded Engine	68
Engine Overheat	68
Post-Operation Care	68
Flipped Over	69
ATV Immersion	69
Limp Home Mode	69
Storage and Preseason Preparation	69
MAINTENANCE CHART	70
MAINTENANCE	72
Engine/Transmission	72
Air Intake System	75
Electrical	76
Drive Train	79
Steering/Control Systems	81
Suspension	82
Brake	83
Body/Frame	84
CARGO AND TRANSPORTATION	85
Cargo	85
Transportation	86
TROUBLESHOOTING	87
SPECIFICATIONS	90
SI METRIC INFORMATION GUIDE	94
CHANGE OF ADDRESS	95

NOTICE

The *Operator's Guide* and *Safety Handbook* have been prepared to acquaint the owner/operator of a new vehicle with the various vehicle controls, maintenance and safe operating instructions. They are indispensable for the proper use of the product.

This *Operator's Guide* uses the following symbols.

WARNING

Identifies an instruction which, if not followed, could cause serious personal injuries including the possibility of death.

CAUTION: Denotes an instruction which, if not followed, could severely damage vehicle components.

NOTE: Indicates supplementary information needed to fully complete an instruction.

Although the mere reading of such information does not eliminate the hazard, the understanding and application of the information will promote the correct use of the all-terrain vehicle (ATV).

To fully appreciate the pleasures, enjoyment and excitement of using an ATV, there are some basic rules that **MUST** be observed and followed by any four-wheeler.

SPECIAL SAFETY MESSAGES

AN ATV IS NOT A TOY AND CAN BE HAZARDOUS TO OPERATE.

An ATV handles differently from other vehicles including motorcycles and cars. A collision or rollover can occur quickly, even during routine maneuvers such as turning and driving on hills or over obstacles, if you fail to take proper precautions.

SEVERE INJURY OR DEATH can result if you do not follow these instructions:

- ⚠ Read the *Operator's Guide*, the *Safety Handbook* and all labels carefully and follow the operating procedures described.
- ⚠ Never operate an ATV without proper instruction. **Take a training course.** Beginners should receive training from a certified instructor. Contact an authorized ATV dealer to find out about the training courses nearest you or call the Specialty Vehicle Institute of America (SVIA) at 1-800-887-2887 or in Canada, the Canada Safety Council (CSC) at 1-613-739-1535 ext. 227.
- ⚠ Always follow this age recommendation: A child under 16 years old should never operate this ATV.
- ⚠ Never carry a passenger on an ATV.
- ⚠ Never operate an ATV on any paved surfaces, including sidewalks, driveways, parking lots and streets.
- ⚠ Never operate an ATV on any public street, road or highway, even a dirt or gravel one.
- ⚠ Never operate an ATV without wearing an approved helmet that fits properly. You should also wear eye protection (goggles or face shield), gloves, boots, long sleeved shirt or jacket, and long pants.
- ⚠ Never consume alcohol or drugs before or while operating this ATV.
- ⚠ Never operate at excessive speeds. Always go at a speed that is proper for the terrain, visibility, and operating conditions, and your experience.
- ⚠ Never attempt wheelies, jumps, or other stunts.
- ⚠ Always inspect your ATV each time you use it to make sure it is in safe operating condition. Always follow the inspection and maintenance procedures and schedules described in the *Operator's Guide* and the *Safety Handbook*.
- ⚠ Always keep both hands on the handlebars and both feet on the footpegs of the ATV during operation.
- ⚠ Always go slowly and be extra careful when operating on unfamiliar terrain. Always be alert to changing terrain conditions when operating the ATV.
- ⚠ Never operate on excessively rough, slippery or loose terrain until you have learned and practiced the skills necessary to control the ATV on such terrain. Always be especially cautious on these kinds of terrain.
- ⚠ Always follow proper procedures for turning as described in the *Operator's Guide* and the *Safety Handbook*. Practice turning at low speeds before attempting to turn at faster speeds. Do not turn at excessive speed.
- ⚠ Never operate the ATV on hills too steep for the ATV or for your abilities. Practice on smaller hills before attempting larger hills.

- ⚠ Always follow proper procedures for climbing hills as described in the *Operator's Guide* and the *Safety Handbook*. Check the terrain carefully before you start up any hill. Never climb hills with excessively slippery or loose surfaces. Shift your weight forward. Never open the throttle suddenly or make sudden gear changes. Never go over the top of any hill at high speed.
- ⚠ Always follow proper procedures for going down hills and for braking on hills as described in the *Operator's Guide* and the *Safety Handbook*. Check the terrain carefully before you start down any hill. Shift your weight backward. Never go down a hill at high speed. Avoid going down a hill at an angle that would cause the vehicle to lean sharply to one side. Go straight down the hill where possible.
- ⚠ Always follow proper procedures for crossing the side of a hill as described in the *Operator's Guide* and the *Safety Handbook*. Avoid hills with excessively slippery or loose surfaces. Shift your weight to the uphill side of the ATV. Never attempt to turn the ATV around on any hill until you have mastered the turning technique described in the *Operator's Guide* and the *Safety Handbook* on level ground. Avoid crossing the side of a steep hill if possible.
- ⚠ Always use proper procedures if you stall or roll backwards when climbing a hill. To avoid stalling, use proper gear and maintain a steady speed when climbing a hill. If you stall or roll backwards, follow the special procedure for braking described in the *Operator's Guide* and the *Safety Handbook*. Dismount on the uphill side or to a side if pointed straight uphill. Turn the ATV around and remount, following the procedure described in the *Operator's Guide* and the *Safety Handbook*.
- ⚠ Always check for obstacles before operating in a new area. Never attempt to operate over large obstacles, such as large rocks or fallen trees. Always follow proper procedures when operating over obstacles as described in the *Operator's Guide* and the *Safety Handbook*.
- ⚠ Always be careful when skidding or sliding. Learn to safely control skidding or sliding by practicing at low speeds and on level, smooth terrain. On extremely slippery surfaces, such as ice, go slowly and be very cautious in order to reduce the chance of skidding out of control.
- ⚠ Never operate an ATV in fast flowing water or in water deeper than that specified in the *Operator's Guide* and the *Safety Handbook*. Remember that wet brakes may have reduced stopping ability. Test your brakes after leaving water. If necessary, apply them several times to let friction dry out the pads.
- ⚠ Always be sure there are no obstacles or people behind you when you operate in reverse. When it is safe to proceed in reverse, go slowly.
- ⚠ Always use the size and type tires specified in the *Operator's Guide*. Always maintain proper tire pressure as described in this guide.
- ⚠ Never modify an ATV through improper installation or use of accessories.
- ⚠ Never exceed the stated load limits for an ATV. Cargo should be properly distributed and securely attached. Reduce speed and follow instructions in the *Operator's Guide* and the *Safety Handbook* for carrying cargo or pulling a trailer. Allow greater distance for braking.
- ⚠ **FOR MORE INFORMATION ABOUT ATV SAFETY**, call the Specialty Vehicle Institute of America (SVIA) at 1-800-887-2887 or in Canada, the Canada Safety Council (CSC) at 1-613-739-1535 ext. 227.

OPERATION WARNINGS

While reading this *Operator's Guide*, remember that:

WARNING

Indicates a potential hazard that could result in serious injury or death.

The following warnings and their format have been requested by the United States Consumer Product Safety Commission and are required to be in the *Operator's Guide* and *Safety Handbook* for all ATV's.

NOTE: The following illustrations are general representations only. Your model may differ.

WARNING



V00A0AQ

POTENTIAL HAZARD

Operating this ATV without proper instruction.

WHAT CAN HAPPEN

The risk of an accident is greatly increased if the operator does not know how to operate the ATV properly in different situations and on different types of terrain.

HOW TO AVOID THE HAZARD

Beginning and inexperienced operators should complete the certified training course offered by Bombardier Inc. They should then regularly practice the skills learned in the course and the operating techniques described in the *Operator's Guide* and the *Safety Handbook*.

For more information about the training course, contact an authorized ATV dealer or call Bombardier Inc. at 1-819-566-3366.



V00A01Q

POTENTIAL HAZARD

Failure to follow the age recommendations for this ATV.

WHAT CAN HAPPEN

Use by children of ATVs that are not recommended for their age can lead to severe injury or death of the child.

Even though a child may be within the age group for which an ATV is recommended, he or she may not have the skills, abilities, or judgment needed to operate the ATV safely and may be involved in a serious accident.

HOW TO AVOID THE HAZARD

No one under 16 should operate a Bombardier ATV.

WARNING



V00A02Q

POTENTIAL HAZARD

Carrying a passenger on this ATV or in the rear cargo box.

WHAT CAN HAPPEN

Greatly reduces your ability to balance and control this ATV.

Could cause an accident, resulting in harm to you and/or your passenger.

HOW TO AVOID THE HAZARD

Never carry a passenger. The long seat is to allow the operator to shift position as needed during operation. The rear cargo box is used to transport material only. They are not for carrying passengers.

WARNING

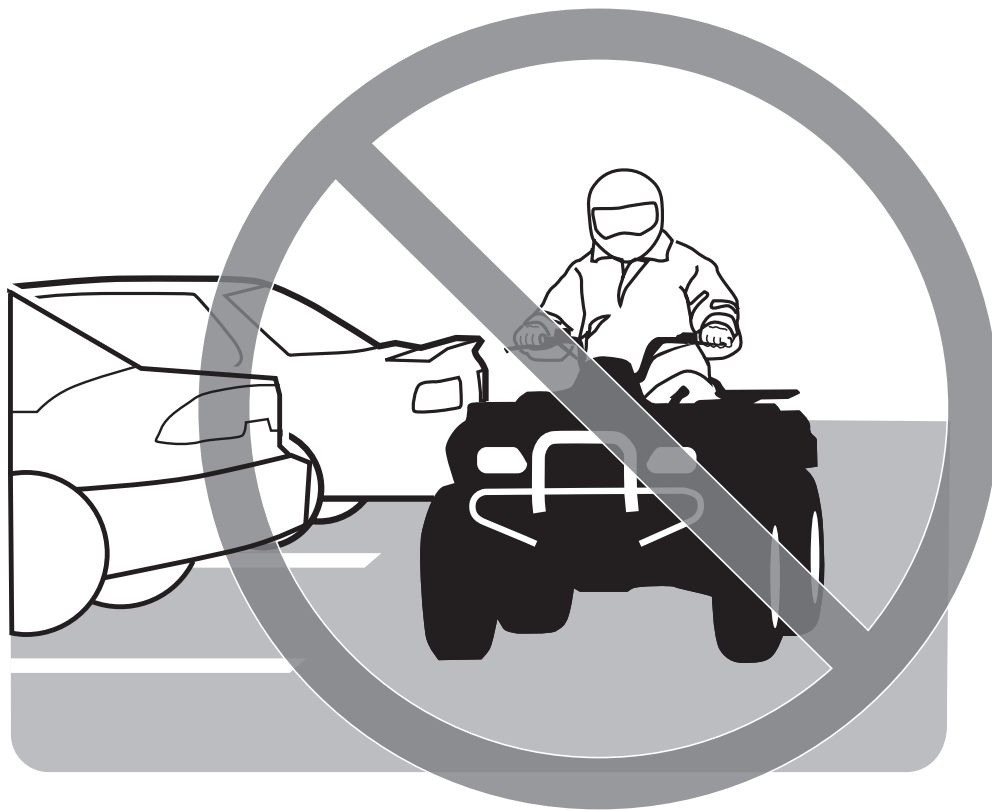

V00A03Q

POTENTIAL HAZARD

Operating this ATV on paved surfaces.

WHAT CAN HAPPEN

The ATV's tires are designed for off-road use only, not for use on pavement. Paved surfaces may seriously affect handling and control of the ATV, and may cause the vehicle to go out of control.

HOW TO AVOID THE HAZARD

Never operate the ATV on any paved surfaces, including sidewalks, driveways, parking lots and streets.

WARNING



V00A04Q

POTENTIAL HAZARD

Operating this ATV on public streets, roads or highways.

WHAT CAN HAPPEN

You can collide with another vehicle.

HOW TO AVOID THE HAZARD

Never operate this ATV on any public street, road or highway, even a dirt or gravel one. In many states it is illegal to operate ATVs on public streets, roads and highways.

WARNING



V00A06Q

POTENTIAL HAZARD

Operating this ATV without wearing an approved motorcycle helmet, eye protection and protective clothing.

WHAT CAN HAPPEN

Operating without an approved motorcycle helmet increases your chances of a severe head injury or death in the event of an accident.

Operating without eye protection can result in an accident and increases your chances of a severe injury in the event of an accident.

Operating without protective clothing increases your chances of severe injury in the event of an accident.

HOW TO AVOID THE HAZARD

Always wear an approved motorcycle helmet that fits properly. You should also wear:

- eye protection (goggles or face shield)
- gloves
- boots
- long sleeved shirt or jacket
- long pants.

WARNING



V00A07Q

POTENTIAL HAZARD

Operating this ATV after consuming alcohol or drugs.

WHAT CAN HAPPEN

- Could seriously affect your judgment.
- Could cause you to react more slowly.
- Could affect your balance and perception.
- Could result in an accident.

HOW TO AVOID THE HAZARD

Never consume alcohol or drugs before or while driving this ATV.

WARNING

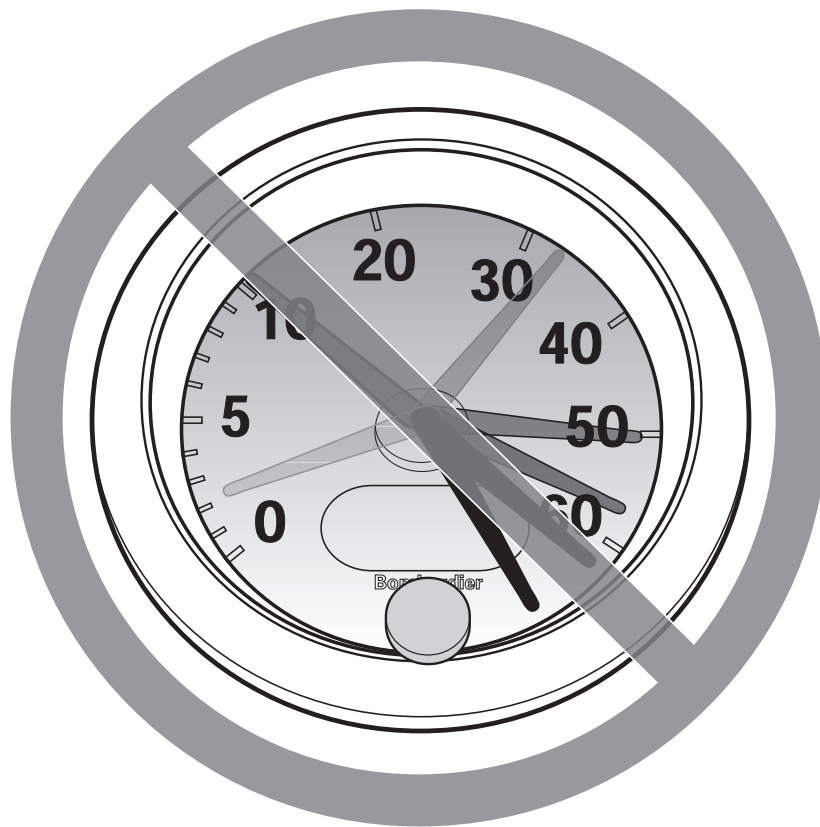

V00A08Q

POTENTIAL HAZARD

Operating this ATV at excessive speeds.

WHAT CAN HAPPEN

Increases your chances of losing control of the ATV, which can result in an accident.

HOW TO AVOID THE HAZARD

Always travel at a speed which is proper for the terrain, visibility and operating conditions, and your experience.

WARNING



V00A09Q

POTENTIAL HAZARD

Attempting wheelies, jumps and other stunts.

WHAT CAN HAPPEN

Increases the chance of an accident, including an overturn.

HOW TO AVOID THE HAZARD

Never attempt stunts, such as wheelies or jumps. Don't try to show off.

WARNING

POTENTIAL HAZARD

Failure to inspect the ATV before operating.
Failure to properly maintain the ATV.

WHAT CAN HAPPEN

Increases the possibility of an accident or equipment damage.

HOW TO AVOID THE HAZARD

Always inspect your ATV each time you use it to make sure the ATV is in safe operating condition.

Always make sure that the rear cargo box is properly latched before operating.

Always follow the inspection and maintenance procedures and schedules described in the *Operator's Guide* and the *Safety Handbook*.

WARNING



V00A0BQ

POTENTIAL HAZARD

Removing hands from handlebars or feet from footpegs during operation.

WHAT CAN HAPPEN

Removing even one hand or foot can reduce your ability to control the ATV or could cause you to lose your balance and fall off the ATV. If you remove a foot from the footpegs, your foot or leg may come into contact with the rear wheels, which could injure you or cause an accident.

HOW TO AVOID THE HAZARD

Always keep both hands on the handlebars and both feet on the footpegs of your ATV during operation.

WARNING

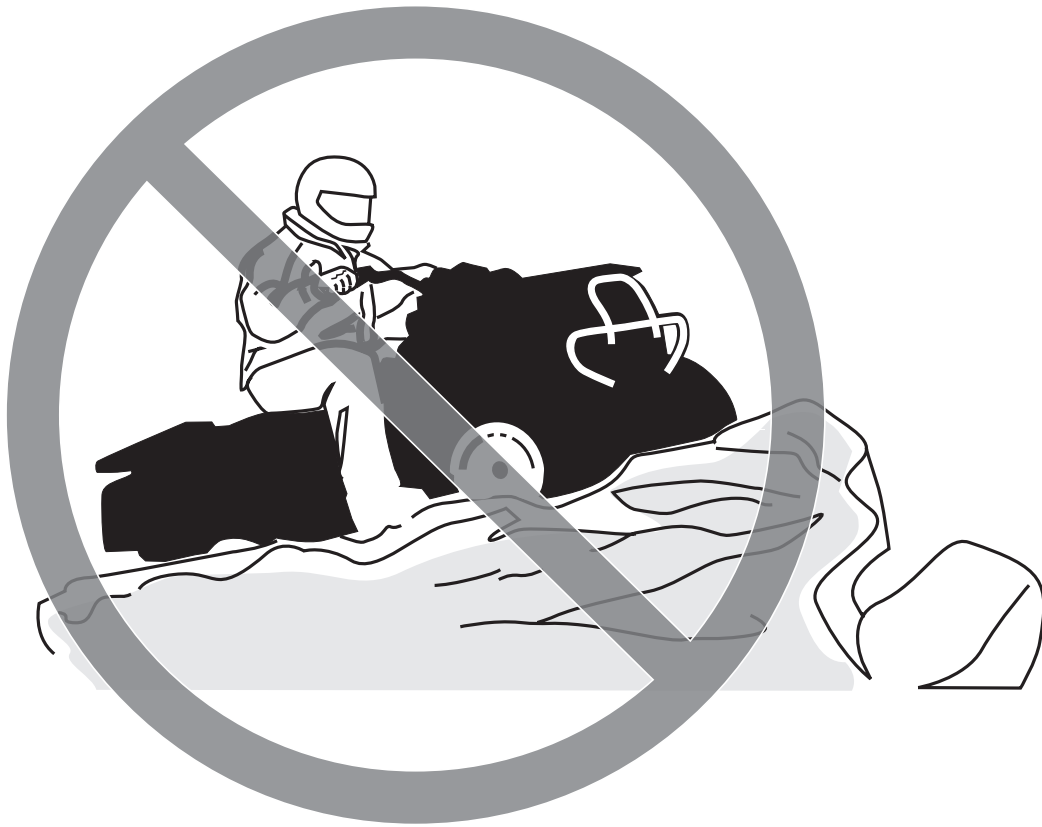

V00A0CQ

POTENTIAL HAZARD

Failure to use extra care when operating this ATV on unfamiliar terrain.

WHAT CAN HAPPEN

You can come upon hidden rocks, bumps, or holes, without enough time to react.

Could result in the ATV overturning or going out of control.

HOW TO AVOID THE HAZARD

Go slowly and be extra careful when operating on unfamiliar terrain.

Always be alert to changing terrain conditions when operating the ATV.

WARNING



V00A0DQ

POTENTIAL HAZARD

Failure to use extra care when operating on excessively rough, slippery or loose terrain.

WHAT CAN HAPPEN

Could cause loss of traction or vehicle control, which could result in an accident, including an overturn.

HOW TO AVOID THE HAZARD

Do not operate on excessively rough, slippery or loose terrain until you have learned and practiced the skills necessary to control the ATV on such terrain.

Always be especially cautious on these kinds of terrain.

WARNING



V00A0EQ

POTENTIAL HAZARD

Turning improperly.

WHAT CAN HAPPEN

ATV could go out of control, causing a collision or overturn.

HOW TO AVOID THE HAZARD

Always follow proper procedures for turning as described in the *Operator's Guide* and the *Safety Handbook*. Practice turning at low speeds before attempting to turn at faster speeds.

Do not turn at excessive speed.

WARNING



V00A00Q

POTENTIAL HAZARD

Operating on excessively steep hills.

WHAT CAN HAPPEN

The vehicle can overturn more easily on extremely steep hills than on level surfaces or small hills.

HOW TO AVOID THE HAZARD

Never operate the ATV on hills too steep for the ATV or for your abilities. Practice on smaller hills before attempting larger hills.

WARNING



V00A0FQ

POTENTIAL HAZARD

Climbing hills improperly.

WHAT CAN HAPPEN

Could cause loss of control or cause ATV to overturn.

HOW TO AVOID THE HAZARD

Always follow proper procedures for climbing hills as described in the *Operator's Guide* and the *Safety Handbook*.

Always check the terrain carefully before you start up any hill.

Never climb hills with excessively slippery or loose surfaces.

Shift your weight forward.

Never open the throttle suddenly or make sudden gear changes. The ATV could flip over backwards.

Never go over the top of any hill at high speed. An obstacle, a sharp drop, or another vehicle or person could be on the other side of the hill.

WARNING



V00A0GQ

POTENTIAL HAZARD

Going down a hill improperly.

WHAT CAN HAPPEN

Could cause loss of control or cause ATV to overturn.

HOW TO AVOID THE HAZARD

Always follow proper procedures for going down hills as described in the *Operator's Guide* and the *Safety Handbook*.

NOTE: A special technique is required when braking as you go down a hill.

Always check the terrain carefully before you start down any hill.

Shift your weight backward.

Never go down a hill at high speed.

Avoid going down a hill at an angle which would cause the vehicle to lean sharply to one side. Go straight down the hill where possible.

WARNING



V00A0HQ

POTENTIAL HAZARD

Improperly crossing hills or turning on hills.

WHAT CAN HAPPEN

Could cause loss of control or cause ATV to overturn.

HOW TO AVOID THE HAZARD

Never attempt to turn the ATV around on any hill until you have mastered the turning technique as described in the *Operator's Guide* and the *Safety Handbook* on level ground. Be very careful when turning on any hill.

Avoid crossing the side of a steep hill if possible.

When crossing the side of a hill:

Always follow proper procedures as described in the *Operator's Guide* and the *Safety Handbook*.

Avoid hills with excessively slippery or loose surfaces.

Shift your weight to the uphill side of the ATV.

WARNING



V00A01Q

POTENTIAL HAZARD

Stalling, rolling backwards or improperly dismounting while climbing a hill.

WHAT CAN HAPPEN

Could result in ATV overturning.

HOW TO AVOID THE HAZARD

Use proper gear and maintain steady speed when climbing a hill.

If you lose all forward speed:

Keep weight uphill.

Apply the brakes.

Lock parking brake after you are stopped.

If you begin rolling backwards:

Keep weight uphill.

Never apply the rear brake while rolling backwards.

Apply the front brake gradually.

When fully stopped, apply rear brake as well and lock parking brake.

Dismount on uphill side, or to a side if pointed straight uphill.

Turn the ATV around and remount, following the procedure described in the *Operator's Guide* and the *Safety Handbook*.

WARNING



V00A0JQ

POTENTIAL HAZARD

Improperly operating over obstacles.

WHAT CAN HAPPEN

Could cause loss of control or a collision. Could cause the ATV to overturn.

HOW TO AVOID THE HAZARD

Before operating in a new area, check for obstacles.

Never attempt to ride over large obstacles, such as large rocks or fallen trees.

When you go over obstacles, always follow proper procedures as described in the *Operator's Guide* and the *Safety Handbook*.

WARNING



V00A0KQ

POTENTIAL HAZARD

Skidding or sliding improperly.

WHAT CAN HAPPEN

You may lose control of this ATV.

You may also regain traction unexpectedly, which may cause the ATV to overturn.

HOW TO AVOID THE HAZARD

Learn to safely control skidding or sliding by practicing at low speeds and on level, smooth terrain.

On extremely slippery surfaces, such as ice, go slowly and be very cautious in order to reduce the chance of skidding or sliding out of control.

WARNING



V00A0LQ

POTENTIAL HAZARD

Operating this ATV through deep or fast flowing water.

WHAT CAN HAPPEN

Tires may float, causing loss of traction and loss of control, which could lead to an accident.

HOW TO AVOID THE HAZARD

Never operate this ATV in fast flowing water or in water deeper than that specified in the *Operator's Guide* and the *Safety Handbook*.

Remember that wet brakes may have reduced stopping ability. Test your brakes after leaving water. If necessary, apply them several times to let friction dry out the pads.

WARNING



V00A0MQ

POTENTIAL HAZARD

Improperly operating in reverse.

WHAT CAN HAPPEN

You could hit an obstacle or person behind you, resulting in serious injury.

HOW TO AVOID THE HAZARD

When you select reverse gear, make sure there are no obstacles or people behind you. When it is safe to proceed, go slowly.

WARNING



V00A00Q

POTENTIAL HAZARD

Operating this ATV with improper tires, or with improper or uneven tire pressure.

WHAT CAN HAPPEN

Use of improper tires on this ATV, or operation of this ATV with improper or uneven tire pressure, may cause loss of control, and increases the risk of an accident.

HOW TO AVOID THE HAZARD

Always use the size and type, tires specified in the *Operator's Guide* for this vehicle.

Always maintain proper tire pressure as described in the *Operator's Guide* and the *Safety Handbook*.

WARNING



V00A0NQ

POTENTIAL HAZARD

Operating this ATV with improper modifications.

WHAT CAN HAPPEN

Improper installation of accessories or modification of this vehicle may cause changes in handling which in some situations could lead to an accident.

HOW TO AVOID THE HAZARD

Never modify this ATV through improper installation or use of accessories. All parts and accessories added to this vehicle should be genuine Bombardier or equivalent components designed for use on this ATV and should be installed and used according to instructions. If you have questions, consult an authorized Bombardier ATV dealer.

WARNING



V00A0PQ

POTENTIAL HAZARD

Overloading this ATV or carrying or towing cargo improperly.

WHAT CAN HAPPEN

Could cause changes in vehicle handling which could lead to an accident.

HOW TO AVOID THE HAZARD

Never exceed the stated load capacity for this ATV.

Cargo should be properly distributed and securely attached.

Reduce speed when carrying cargo or pulling a trailer. Allow greater distance for braking.

Always follow the instructions in the *Operator's Guide* and the *Safety Handbook* for carrying cargo or pulling a trailer.

⚠ WARNING



V03M01Q

POTENTIAL HAZARD

Transporting inflammable or dangerous material can lead to explosions.

WHAT CAN HAPPEN

This can cause serious injury or death.

HOW TO AVOID THE HAZARD

Never transport inflammable or dangerous material.

While reading this *Operator's Guide*, remember that:

⚠ WARNING

Indicates a potential hazard that could result in serious injury or death.

BOMBARDIER LIMITED WARRANTY NORTH AMERICA: 2002 BOMBARDIER® ATV

1. SCOPE OF THE LIMITED WARRANTY

BOMBARDIER INC. (hereinafter "BOMBARDIER") warrants its 2002 Bombardier ATV from defects in material or workmanship for the period described below.

All genuine BOMBARDIER parts and accessories, installed by an authorized BOMBARDIER dealer (as hereinafter defined) at the time of delivery of the 2002 Bombardier ATV, carry the same warranty as that of the ATV.

Tires and winches supplied as original equipment on your ATV are warranted separately by the individual tire or winch manufacturer as identified below. If an original tire or winch on your Bombardier ATV has a defect in material or workmanship, please contact these manufacturers or ask your authorized BOMBARDIER dealer for assistance.

Carlisle Tire & Wheel Company
(Traxters and Quest tires)
23 Windham Boulevard
Aiken, SC 29805
Warranty Information:
in USA 1-800-260-7959
in Canada 1-800-265-6155
in Quebec 1-877-997-4999

Warn Industries Inc. (Winch)
12900 SE Capps Road
Clackamas, Oregon 97015-8903
Customer service:
in USA 1-800-543-9276
in Canada 1-800-668-6012
in Quebec 1-800-361-9291

Kenda USA (DS 650 tires)
7095 Americana Parkway
Reynoldsburg, OH 43068
1-614-866 9803

Use of the product for racing or any other competitive activity, at any point, even by a prior owner, will render this warranty null and void.

2. WARRANTY COVERAGE PERIOD

This warranty will be in effect FROM THE DATE OF DELIVERY TO THE FIRST RETAIL CONSUMER or the date the product is first put into use, whichever occurs first and for a period of:

SIX (6) CONSECUTIVE MONTHS, for private use or commercial owners.

The repair or replacement of parts or the performance of service under this warranty does not extend the life of this warranty beyond its original expiration date.

3. CONDITIONS TO HAVE WARRANTY COVERAGE

This warranty coverage is available only on 2002 Bombardier ATV purchased as new and unused by its first owner from a BOMBARDIER dealer authorized to distribute Bombardier ATV products in the country in which the sale occurred (hereinafter "**BOMBARDIER dealer**"), and then only after the BOMBARDIER specified pre-delivery inspection process is completed and documented. Warranty coverage only becomes available upon proper registration of the product by a BOMBARDIER dealer. Such limitations are necessary in order to allow BOMBARDIER to preserve both the safety of its products, and also that of its consumers and the public.

Routine maintenance outlined in the *Operator's Guide* must be timely performed in order to maintain warranty coverage. BOMBARDIER reserves the right to make warranty coverage contingent upon proof of proper maintenance.

4. WHAT TO DO TO OBTAIN WARRANTY COVERAGE

The customer must notify a servicing BOMBARDIER dealer within two (2) days of the appearance of a defect, and provide it with reasonable access to the product and reasonable opportunity to repair it. The customer must also present to the BOMBARDIER dealer, proof of purchase of the product and must sign the repair/work order prior to the start of the repair in order to validate the warranty repair. All parts replaced under this limited warranty become the property of BOMBARDIER.

5. WHAT BOMBARDIER WILL DO

BOMBARDIER's obligations under this warranty are limited to, at its sole discretion, repairing parts found defective under normal use, maintenance and service, or replacing such parts with new genuine BOMBARDIER parts without charge for parts and labor, at any authorized BOMBARDIER dealer.

BOMBARDIER reserves the right to improve or modify products from time to time without assuming any obligation to modify products previously manufactured.

6. EXCLUSIONS - ARE NOT WARRANTED

- Normal wear and tear;
- Routine maintenance items, tune ups, adjustments;
- Damage caused by failure to provide proper maintenance and/or storage, as described in the *Operator's Guide*;
- Damage resulting from removal of parts, improper repairs, service, maintenance, modifications or use of parts not manufactured or approved by BOMBARDIER or resulting from repairs done by a person that is not an authorized servicing BOMBARDIER dealer;
- Damage caused by abuse, abnormal use, neglect or operation of the product in a manner inconsistent with the recommended operation described in the *Operator's Guide*;
- Damage resulting from accident, submersion, fire, theft, vandalism or any act of God;
- Operation with fuels, oils or lubricants which are not suitable for use with the product (see the *Operator's Guide*);
- Water or snow ingestion;
- Incidental or consequential damages, or damages of any kind including without limitation towing, storage, telephone, rental, taxi, inconvenience, insurance coverage, loan payments, loss of time, loss of income.

7. LIMITATIONS OF LIABILITY

THIS WARRANTY IS EXPRESSLY GIVEN AND ACCEPTED IN LIEU OF ANY AND ALL OTHER WARRANTIES, EXPRESSED OR IMPLIED, INCLUDING WITHOUT LIMITATION ANY WARRANTY OF MERCHANTABILITY OR FITNESS FOR A PARTICULAR PURPOSE. TO THE EXTENT THAT THEY CANNOT BE DISCLAIMED, THE IMPLIED WARRANTIES ARE LIMITED IN DURATION TO THE LIFE OF THE EXPRESS WARRANTY. INCIDENTAL AND CONSEQUENTIAL DAMAGES ARE EXCLUDED FROM COVERAGE UNDER THIS WARRANTY. SOME STATES/PROVINCES DO NOT ALLOW FOR THE DISCLAIMERS, LIMITATIONS AND EXCLUSIONS IDENTIFIED ABOVE, AS A RESULT, THEY MAY NOT APPLY TO YOU. THIS WARRANTY GIVES YOU SPECIFIC RIGHTS, AND YOU MAY ALSO HAVE OTHER LEGAL RIGHTS WHICH MAY VARY FROM STATE TO STATE, OR PROVINCE TO PROVINCE.

Neither the distributor, any BOMBARDIER dealer nor any other person has been authorized to make any affirmation, representation or warranty regarding the product, other than those contained in this limited warranty, and if made, shall not be enforceable against BOMBARDIER.

BOMBARDIER reserves the right to modify this warranty at any time, being understood that such modification will not alter the warranty conditions applicable to the products sold while this warranty is in effect.

8. TRANSFER

If the ownership of a product is transferred during the warranty coverage period, this warranty shall also be transferred and be valid for the remaining coverage period provided that BOMBARDIER is notified of such transfer of ownership in the following way:

- a) The former owner contacts BOMBARDIER (at the phone number provided below) or an authorized BOMBARDIER dealer and gives the coordinates of the new owner; or
- b) BOMBARDIER or an authorized BOMBARDIER dealer receives a proof that the former owner agreed to the transfer of ownership, in addition to the coordinates of the new owner.

9. CONSUMER ASSISTANCE

- a) In the event of a controversy or a dispute in connection with this BOMBARDIER LIMITED WARRANTY, BOMBARDIER suggests that you try to resolve the issue at the dealership level. We recommend discussing the issue with the authorized dealer's service manager or owner.
- b) If the issue has not yet been resolved, please submit your complaint in writing or call the appropriate number below:

In Canada:

BOMBARDIER INC.
RECREATIONAL PRODUCTS
BOMBARDIER ATV
CUSTOMER ASSISTANCE CENTER
VALCOURT, QUEBEC
J0E 2L0
Tel: (819) 566-3366

in USA:

BOMBARDIER MOTOR
CORPORATION OF AMERICA
RECREATIONAL PRODUCTS
CUSTOMER ASSISTANCE CENTER
P.O. BOX 8035
7575 BOMBARDIER COURT
WAUSAU WI 54402-8035
Tel: (715) 848-4957
Fax: (715) 847-6879

© 2001 Bombardier Inc. All rights reserved
® Registered trademark of Bombardier Inc.
BOMBARDIER LIMITED WARRANTY INTERNATIONAL.

BOMBARDIER LIMITED WARRANTY INTERNATIONAL: 2002 BOMBARDIER® ATV

1. SCOPE OF THE LIMITED WARRANTY

BOMBARDIER INC. (hereinafter "BOMBARDIER") warrants its 2002 BOMBARDIER ATV from defects in material or workmanship for the period described below.

All genuine BOMBARDIER parts and accessories, installed by an authorized BOMBARDIER distributor/dealer (as hereinafter defined) at the time of delivery of the 2002 BOMBARDIER ATV, carry the same warranty as that of the ATV.

Tires and winches supplied as original equipment on your ATV are warranted separately by the individual tire or winch manufacturer as identified below. If an original tire or winch on your BOMBARDIER ATV has a defect in material or workmanship, please contact these manufacturers or ask your authorized BOMBARDIER distributor/dealer for assistance.

Carlisle Tire & Wheel Company
(Traxters and Quest tires)
23 Windham Boulevard
Aiken, SC 29805
Warranty Information:
International: 1-803-643-2900

Warn Industries Inc. (Winch)
12900 SE Capps Road
Clackamas, Oregon 97015-8903
Customer service:
International: 1-503-722-1200

Kenda USA (DS 650 tires)
7095 Americana Parkway
Reynoldsburg, OH 43068
1-614-866-9803

Use of the product for racing or any other competitive activity, at any point, even by a prior owner will render this warranty null and void.

2. WARRANTY COVERAGE PERIOD

This warranty will be in effect FROM THE DATE OF DELIVERY TO THE FIRST RETAIL CONSUMER or the date the product is first put into use, whichever occurs first and for a period of:

SIX (6) CONSECUTIVE MONTHS for private use or commercial owners.

The repair or replacement of parts or the performance of service under this warranty does not extend the life of this warranty beyond its original expiration date.

3. CONDITIONS TO HAVE WARRANTY COVERAGE

This warranty coverage is available only on 2002 BOMBARDIER ATV purchased as new and unused by its first owner from a BOMBARDIER distributor/dealer authorized to distribute BOMBARDIER ATV products in the country in which the sale occurred (hereinafter "**BOMBARDIER distributor/dealer**"), and then only after the BOMBARDIER specified pre-delivery inspection process is completed and documented. Warranty coverage only becomes available upon proper registration of the product by a BOMBARDIER distributor/dealer. Such limitations are necessary in order to allow BOMBARDIER to preserve both the safety of its products, and also that of its consumers and the public.

Routine maintenance outlined in the *Operator's Guide* must be timely performed in order to maintain warranty coverage. BOMBARDIER reserves the right to make warranty coverage contingent upon proof of proper maintenance.

4. WHAT TO DO TO OBTAIN WARRANTY COVERAGE

The customer must notify a servicing BOMBARDIER distributor/dealer within two (2) days of the appearance of a defect, and provide it with reasonable access to the product and reasonable opportunity to repair it. The customer must also present to the BOMBARDIER distributor/dealer, proof of purchase of the product and must sign the repair/work order prior to the start of the repair in order to validate the warranty repair. All parts replaced under this limited warranty become the property of BOMBARDIER.

5. WHAT BOMBARDIER WILL DO

BOMBARDIER's obligations under this warranty are limited to, at its sole discretion, repairing parts found defective under normal use, maintenance and service, or replacing such parts with new genuine BOMBARDIER parts without charge for parts and labor, at any authorized BOMBARDIER distributor/dealer.

BOMBARDIER reserves the right to improve or modify products from time to time without assuming any obligation to modify products previously manufactured.

6. EXCLUSIONS - ARE NOT WARRANTED

- Normal wear and tear;
- Routine maintenance items, tune ups, adjustments;
- Damage caused by failure to provide proper maintenance and/or storage, as described in the *Operator's Guide*;
- Damage resulting from removal of parts, improper repairs, service, maintenance, modifications or use of parts not manufactured or approved by BOMBARDIER or resulting from repairs done by a person that is not an authorized servicing BOMBARDIER distributor/dealer;
- Damage caused by abuse, abnormal use, neglect or operation of the product in a manner inconsistent with the recommended operation described in the *Operator's Guide*;
- Damage resulting from accident, submersion, fire, theft, vandalism or any act of God;
- Operation with fuels, oils or lubricants which are not suitable for use with the product (see the *Operator's Guide*);
- Water or snow ingestion;
- Incidental or consequential damages, or damages of any kind including without limitation towing, storage, telephone, rental, taxi, inconvenience, insurance coverage, loan payments, loss of time, loss of income.

7. LIMITATIONS OF LIABILITY

THIS WARRANTY IS EXPRESSLY GIVEN AND ACCEPTED IN LIEU OF ANY AND ALL OTHER WARRANTIES, EXPRESSED OR IMPLIED, INCLUDING WITHOUT LIMITATION ANY WARRANTY OF MERCHANTABILITY OR FITNESS FOR A PARTICULAR PURPOSE. TO THE EXTENT THAT THEY CANNOT BE DISCLAIMED, THE IMPLIED WARRANTIES ARE LIMITED IN DURATION TO THE LIFE OF THE EXPRESS WARRANTY. INCIDENTAL AND CONSEQUENTIAL DAMAGES ARE EXCLUDED FROM COVERAGE UNDER THIS WARRANTY. SOME STATES/ PROVINCES DO NOT ALLOW FOR THE DISCLAIMERS, LIMITATIONS AND EXCLUSIONS IDENTIFIED ABOVE, AS A RESULT, THEY MAY NOT APPLY TO YOU. THIS WARRANTY GIVES YOU SPECIFIC RIGHTS, AND YOU MAY ALSO HAVE OTHER LEGAL RIGHTS WHICH MAY VARY FROM STATE TO STATE, OR PROVINCE TO PROVINCE.

Neither the distributor, any BOMBARDIER dealer nor any other person has been authorized to make any affirmation, representation or warranty regarding the product, other than those contained in this limited warranty, and if made, shall not be enforceable against BOMBARDIER.

BOMBARDIER reserves the right to modify this warranty at any time, being understood that such modification will not alter the warranty conditions applicable to the products sold while this warranty is in effect.

8. TRANSFER

If the ownership of a product is transferred during the warranty coverage period, this warranty shall also be transferred and be valid for the remaining coverage period provided that BOMBARDIER is notified of such transfer of ownership in the following way:

- a) The former owner contacts BOMBARDIER or an authorized BOMBARDIER distributor/dealer and gives the coordinates of the new owner; or
- b) BOMBARDIER or an authorized BOMBARDIER distributor/dealer receives a proof that the former owner agreed to the transfer of ownership, in addition to the coordinates of the new owner.

9. CONSUMER ASSISTANCE

- a) In the event of a controversy or a dispute in connection with this BOMBARDIER LIMITED WARRANTY, BOMBARDIER suggests that you try to resolve the issue at the distributorship/dealership level. We recommend discussing the issue with the authorized dealer's service manager or owner.
- b) If further assistance is required, the distributor's service department should be contacted in order to resolve the matter.

© 2001 Bombardier Inc. All rights reserved

® Registered trademark of Bombardier Inc.

FREQUENTLY ASKED QUESTIONS

Q: Why must my vehicle be registered with the factory? After all, I do have my original invoice as proof of when I purchased my vehicle.

A: *Registration is very important and an authorized Bombardier ATV dealer must register your vehicle with Bombardier Inc. Make sure the card has been sent. All of this will allow you to:*

- a) *Have warranty work performed at any authorized Bombardier ATV dealer in North America. Your registration card will provide the dealer with all the necessary data to complete warranty claim forms.*
- b) *Be advised by Bombardier Inc. should there be a safety recall or a particular warranty campaign.*
- c) *Be contacted much faster by the police, in the event that they find your vehicle subsequent to a theft.*

Q: Why must my vehicle be registered with the governing body having jurisdiction over vehicle use?

A: *Vehicle registration has two purposes: In many provinces or States, it is mandatory to register a vehicle in the same way as for a car. It allows the State or province to maintain records of existing vehicles. In some jurisdictions, governmental agencies use part of the registration fees for establishing and maintaining trails.*

Q: Where can I find information on the lubrication and maintenance of my vehicle?

A: In the Operator's Guide provided with the vehicle at the time of delivery.

Q: Will the entire warranty be voided or cancelled, if I do not operate or maintain my new vehicle exactly as specified in the *Operator's Guide*?

A: *The warranty of the new vehicle cannot be "Voided" or "Cancelled" if predelivered by an authorized Bombardier ATV dealer. However, if a particular failure is caused by operation or maintenance other than is shown in the Operator's Guide, THAT failure may not be covered under warranty. This includes service work performed by the customer, oil and filter change and especially the critical adjustments such as the carburetor.*

Q: Would you give some examples of abnormal use or strain, neglect or abuse which may affect the limited warranty coverage?

A: *These terms are general and overlap each other in some cases. Some specific examples may include: running the engine out of oil, operating the vehicle with a broken or damaged part which causes another part to fail, and so on. If you have any specific questions on operation or maintenance, please contact an authorized Bombardier ATV dealer for advice.*

Q: What costs are my responsibility during the warranty period?

A: *The customer's responsibility includes all costs of normal maintenance services, non-warranty repairs, accidents and collision damage, as well as oils, and spark plugs, and incidental or consequential damages costs as explained in the warranty.*

Q: Are "Genuine" Bombardier replacement parts used in warranty repairs also covered by the limited warranty coverage?

A: Yes. When installed by an authorized Bombardier ATV dealer, any "Genuine" Bombardier part used in warranty repairs assumes the remaining warranty that exists on the vehicle.

Q: If I sell my vehicle within the warranty period, will the new owner qualify for the balance of the limited warranty coverage?

A: Yes, provided the re-sale has been registered with the manufacturer.

Q: How can I receive the best owner assistance?

A: The satisfaction, safety and goodwill of the owners of Bombardier products are of primary concern to your ATV dealer and Bombardier Inc. Normally, any problems that arise in connection with the sales transaction or the operation of your vehicle will be handled by your Dealer's Sales or Service Departments. It is recognized, however, that despite the best intentions of everyone concerned, misunderstandings will sometimes occur. Frequently, complaints are the result of a breakdown in communications and can quickly be resolved by a member of the dealership management. If the problem already has been reviewed with the Sales Manager or Service Manager, contact the Dealer Principal himself or the General Manager.

We are always pleased to receive your comments on the Bombardier ATV.

EMISSION REQUIREMENTS

The California Air Resources Board (CARB) requires that your ATV observe with applicable exhaust emissions standards during its useful life, when operated and maintained according to the instructions supplied.

A non-compliance Red Label (as well as a Green Label) is obtained annually during California Vehicle registration. The appropriate label is denoted by the vehicle identification number (in the 8th character detailed herein).

VEHICLE CATEGORY	VIN 8th CHARACTER
Non-complying Red Label	Must denote a C or 3
Complying Green Label	Any alphanumeric designation other than a C or 3

LOCATION OF THE IMPORTANT LABELS

The following labels are on your ATV. If missing or damaged, they can be replaced free of charge. See an authorized Bombardier ATV dealer.

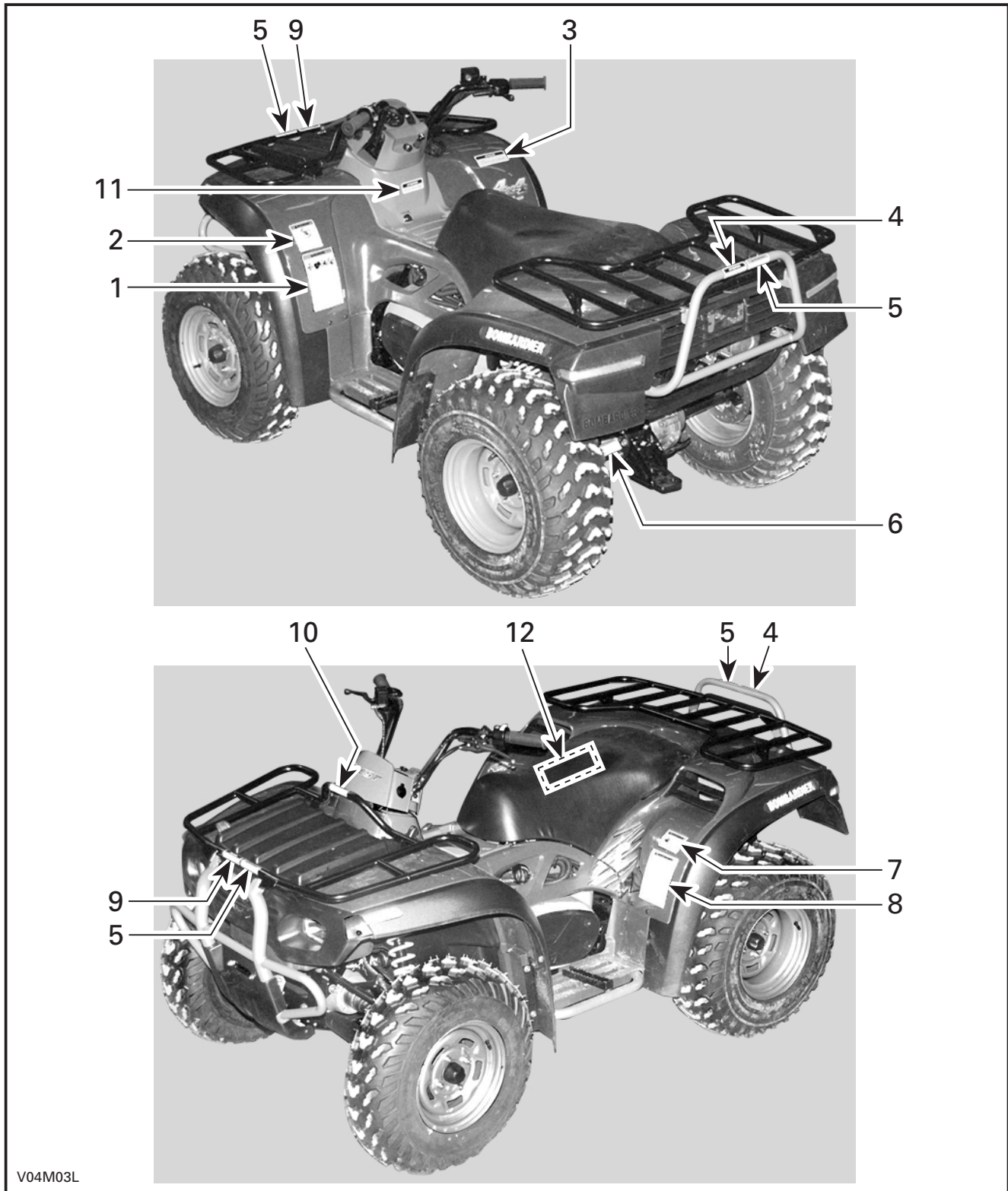

Label 1

⚠ WARNING

Improper ATV use can result in SEVERE INJURY or DEATH.



ALWAYS USE AN APPROVED HELMET AND PROTECTIVE GEAR.

NEVER USE ON PUBLIC ROADS.

NEVER CARRY PASSENGERS.

NEVER USE WITH DRUGS OR ALCOHOL.

NEVER operate:

- without proper training or instructions.
- at speeds too fast for your skills or the conditions.
- on public roads - a collision can occur with another vehicle.
- with a passenger - passengers affect balance and steering and increase risk of losing control.

ALWAYS:

- use proper riding techniques to avoid vehicle overturns on hills and rough terrain and in turns.
- avoid paved surfaces - pavement may seriously affect handling and control.

LOCATE AND READ OPERATOR'S GUIDE.
FOLLOW ALL INSTRUCTIONS & WARNINGS.

704 900 001

V01M01Z

Label 4

CAUTION

MAXIMUM REAR LOAD : 175 lb (80 kg)
(Includes trailer tongue weight if applicable)

704 900 013

V01M04Z

Label 5

⚠ WARNING

NEVER sit here.

704 900 017

V01M050

Label 6

⚠ WARNING

Improper loading of a trailer may cause loss of vehicle control.

- Maximum towing weight: 1100 lb (500 kg).
- Maximum tongue weight: 30 lb (14 kg).

704 900 009

V01M06Z

Label 2

⚠ WARNING

UNDER 16

Operating this ATV if you are under the age of 16 increases your chance of SEVERE INJURY or DEATH.

NEVER operate this ATV if you are under age 16.

704 900 011

V01M02Z

Label 7

⚠ WARNING



NEVER ride as a passenger. Passengers can cause a loss of control, resulting in SEVERE INJURY or DEATH.

704 900 005

V01M07Z

Label 3

CAUTION

- ATV **MUST** be stopped before shifting transmission lever.
- Always apply foot brake to shift from PARK (P).

704 900 007

V01M03Z

Label 8

⚠ WARNING	
Improper tire pressure or overloading can cause loss of control. Loss of control can result in SEVERE INJURY or DEATH.	
TIRE PRESSURE	
• Set with tires cold:	
- Recommended:	FRONT: 37.9 kPa, (0.39 kgf/cm ²), 5.5 psi. REAR: 31.0 kPa, (0.32 kgf/cm ²), 4.5 psi.
- Minimum:	FRONT: 34.5 kPa, (0.35 kgf/cm ²), 5.0 psi. REAR: 27.6 kPa, (0.28 kgf/cm ²), 4.0 psi.
• Never set tire pressure below minimum. It could cause the tire to dislodge from the rim.	
LOADING / TRAILER TOWING	
• Cargo or trailer can affect stability and handling.	
• When loading with cargo or towing a trailer:	
- Reduce speed.	
- Allow more room to stop.	
- Avoid hills and rough terrain.	
• Maximum Vehicle Load: 485 lb (220 kg). Includes weight of operator, cargo and accessories (and if applicable, trailer tongue weight).	
704 900 246	
V04M07Y	

Label 9

CAUTION	
MAXIMUM FRONT LOAD : 90 lb (40 kg) (Includes front storage tray load : 22 lb (10 kg))	
704 900 015	
V01M09Z	

Label 10

⚠ WARNING	
Always latch storage cover.	
704 900 038	
V01M0BZ	

Label 11

CAUTION	
CONSOLE MAXIMUM LOAD: 11 lb (5 kg).	
704 900 247	
V04M08Y	

Label 12

VEHICLE EMISSION CONTROL INFORMATION	ENGINE FAMILY CODE: 2BCXX.4982GC		 BOMBARDIER RECREATIONAL PRODUCTS
	MODEL(S): XXXX/XX, XXXX/XX/XX/XX		
	EXHAUST EMISSION CONTROL SYSTEM: EM		
	DISPLACEMENT: 498cc		
	TUNE-UP SPECIFICATIONS:		
IDLE SPEED:	1100 RPM ± 100 RPM		
IDLE AIR/FUEL MIXTURE SETTING:	FROM POSITION OF PILOT SCREW FOR MAXIMUM SPEED AT IDLE, UNSCREW 3/8 OF TURN		
SPARK PLUG:	NGK DCPR8E ELECTRODE GAP → 0.6 mm - 0.7 mm		
FUEL: (RON + MON) /2	UNLEADED 87 OCTANE		
ENGINE OIL:	SAE 10W40		
THIS VEHICLE CONFORMS TO CARB REGULATIONS APPLICABLE TO 2002 MODEL YEAR NEW OFF-ROAD MOTORCYCLES AND ALL TERRAIN VEHICLES AND IS CERTIFIED TO 10 g/bhp-hr HC+Nox ENGINE FAMILY EXHAUST EMISSION STANDARD IN CALIFORNIA.			
XXX XXX XXX			
V04M0AL			

HOW TO IDENTIFY YOUR ATV

The main components of your vehicle (engine and frame) are identified by different serial numbers. It may sometimes become necessary to locate these numbers for warranty purposes or to trace your vehicle in the event of loss. These numbers are required by the authorized Bombardier ATV dealer to complete warranty claims properly. No warranty will be allowed by Bombardier Inc. if the engine identification number (EIN) or vehicle identification number (VIN) is removed or mutilated in any way. We strongly recommend that you take note of all the serial numbers on your vehicle and supply them to your insurance company.

Engine and Vehicle Identification Number Location

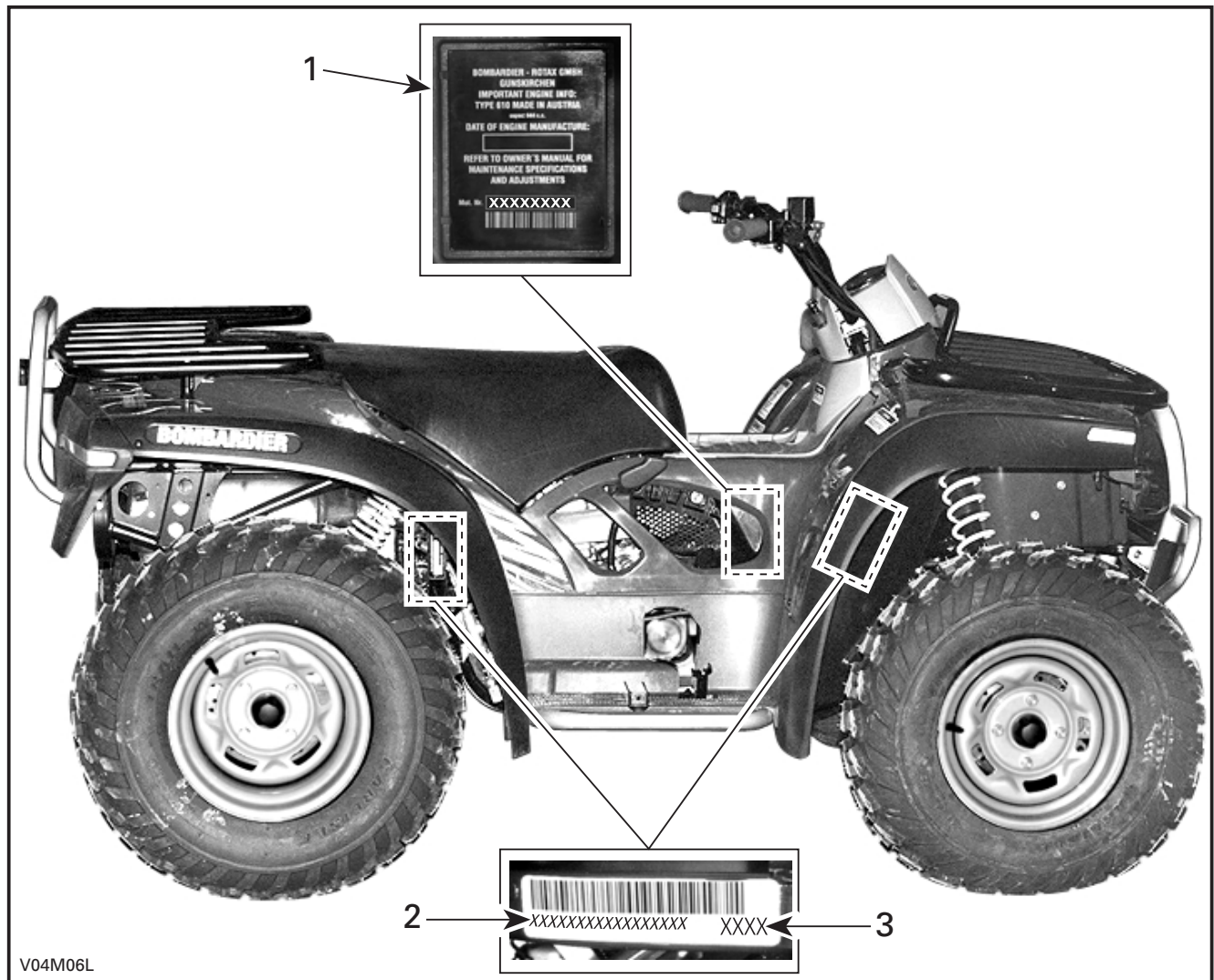

1. EIN (Engine Identification Number)
2. VIN (Vehicle Identification Number)
3. Model

CONTROLS/INSTRUMENTS/EQUIPMENTS

NOTE: Some controls/instruments/equipments are optional.

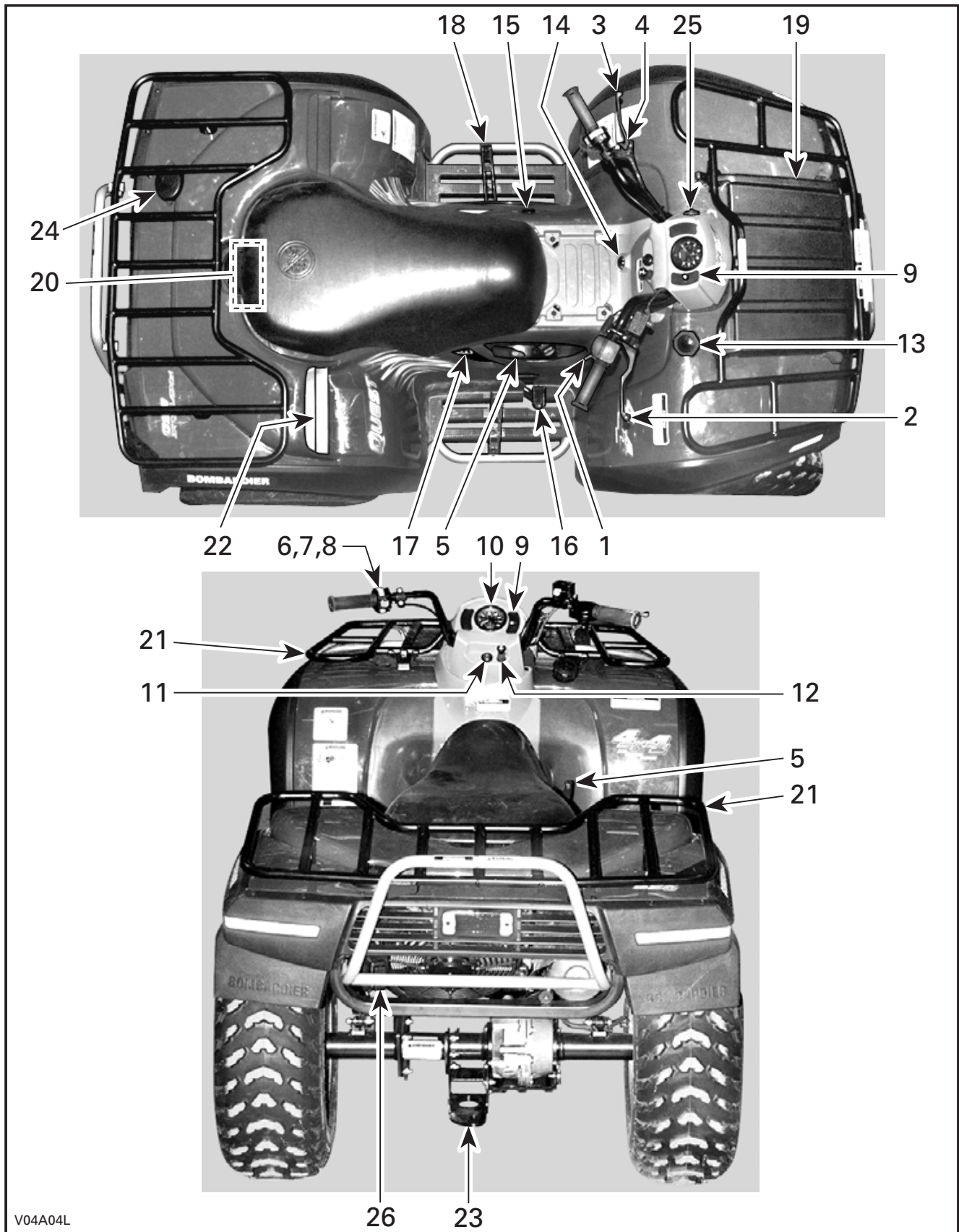

V04A04L

While reading this *Operator's Guide*, remember that:

WARNING

Indicates a potential hazard that could result in serious injury or death.

NOTE: This section gives basic functions of the various controls of your ATV. For more details of how to operate one control in conjunction with some others, refer to OPERATING INSTRUCTIONS in this *Operator's Guide* and *Safety Handbook*.

1) Throttle Lever

Located on the right side of handlebar. When pushed, it increases the engine speed that allows the engagement of the transmission on the selected gear.

When released, the engine speed should return automatically to idle and the vehicle will gradually slow down.

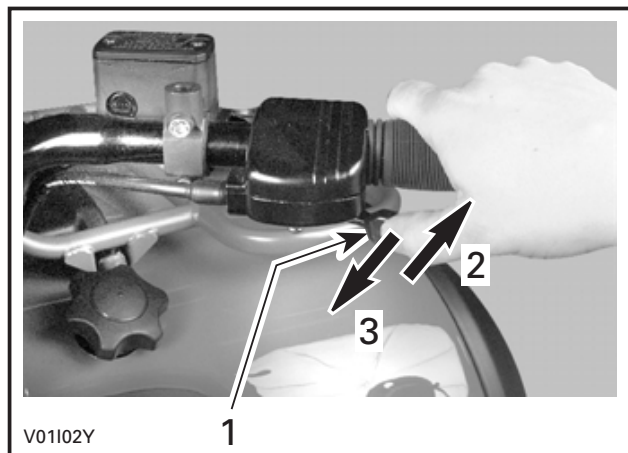

1. Throttle lever
2. To accelerate
3. To decelerate

2) Front Brake Lever

Located on the right side of handlebar. When compressed, the brake is applied. When released, it should automatically return to its original position. Braking effect is proportional to the force applied on the lever and to the type and condition of the terrain. The front brake will have also an effect on rear wheels through the drive train.

See the note at **Rear Brake Lever** below for additional information.

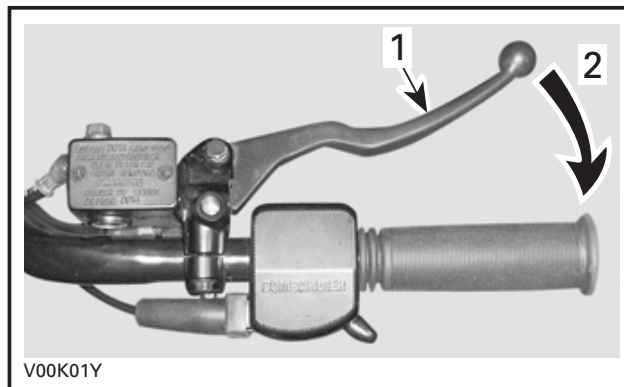

1. Brake lever
2. To apply brake

3) Rear Brake Lever

Located on the left side of handlebar. When compressed, the brake is applied. When released, it should automatically return to its original position. Braking effect is proportional to the force applied on the lever and to the type and condition of the terrain.

NOTE: Using the rear brake will have also an effect on front wheels because they are interconnected through the drive train. As on other wheeled vehicles, the vehicle weight is transferred to the front wheels when braking. To obtain greater stopping efficiency, the brake system distributes more braking force to the front wheels. This will affect vehicle handling and steering control when braking vigorously. Take it into account when braking.

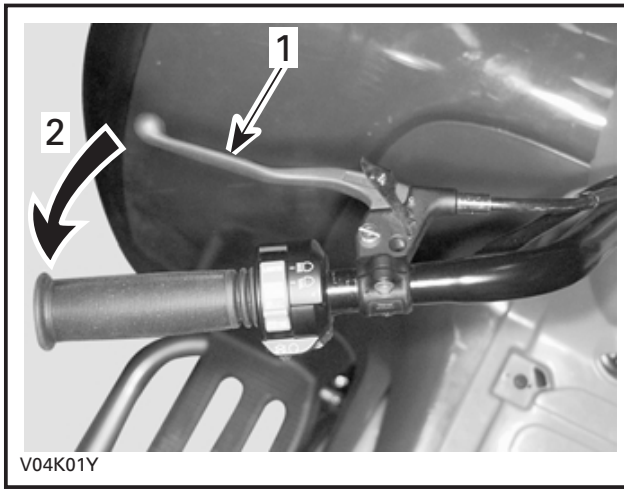

V04K01Y

1. Brake lever
2. To apply brake

4) Brake Lever Lock

Located on left side of handlebar on the rear brake lever. When applied, it prevents the vehicle from moving. Useful when the brake needs to be locked for example such as doing a K-turn.

⚠ WARNING

Always use the brake lever lock **and** engage the PARK position on the transmission lever when the vehicle is not in operation.

⚠ WARNING

Make sure brake lever lock is fully disengaged before operating the ATV.

When you ride the vehicle, the prolonged use of brakes may cause damage to the brake system and cause loss of braking capacity and/or fire.

To engage mechanism: Squeeze brake lever and maintain while moving lever lock with a finger. Brake lever is now compressed and applying rear brakes.

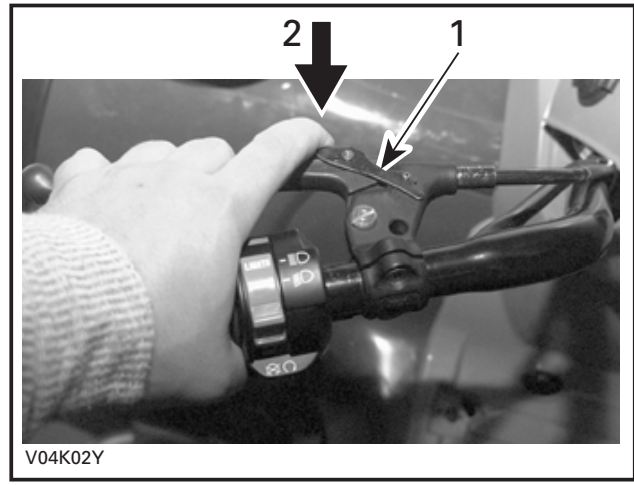

V04K02Y

1. Brake lever lock
2. To apply parking brake

To release mechanism: Squeeze brake lever. Lever lock should automatically return to its original position. Brake lever should return to rest position. Always release brake lever lock before riding.

5) Transmission Lever

Located on the right side of vehicle. A 5-position lever: P, R, N, H and L.

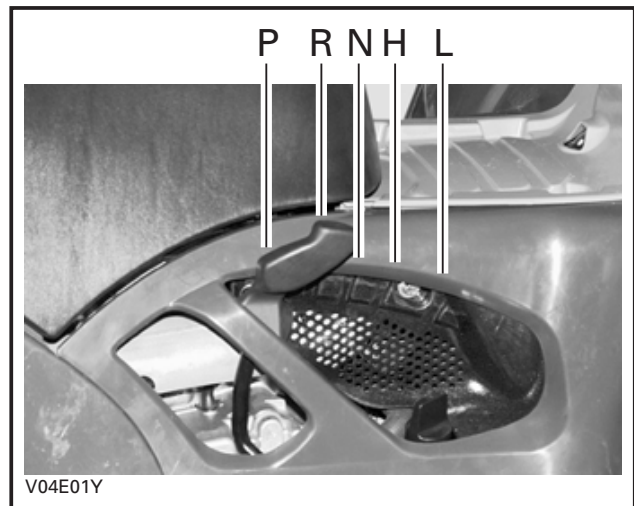

V04E01Y

To change the transmission position, completely stop vehicle then move lever to the right then to the desired position while moving lever forward. Do not force lever. If unable to shift, gently apply throttle to move ATV and try again.

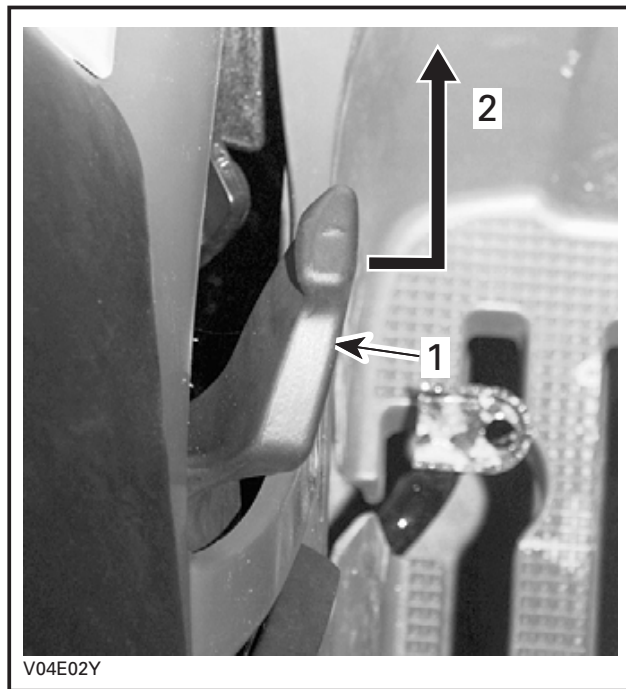

1. Transmission lever
2. To change position

CAUTION: Always completely stop the vehicle and apply the brake prior to moving the transmission lever.

P: Park

This position locks the transmission to help prevent vehicle movement. Always use when the vehicle is not in operation. In some circumstances, it may be necessary to rock the vehicle back and forth to move the gears in the transmission to allow the park to be engaged.

R: Reverse

This allows the vehicle to go backward. The vehicle speed is limited.

WARNING

Before moving vehicle in reverse, ensure the path behind is clear of obstacles or bystanders. Remain seated.

N: Neutral

This position disengages the transmission to allow manual vehicle movement or towing.

H: High gear

This selects the high speed range of the transmission in the gear box. It is the normal driving speed range. It allows the vehicle to reach its maximum speed.

L: Low gear

This selects the low speed range of the transmission in the gear box. It is the working position. It allows the vehicle to move slowly with the maximum traction and power.

6) Headlight Switch

Located on left side of handlebar. Place switch to LO for the low beam and taillight. Place switch to HI for the high beam and taillight.

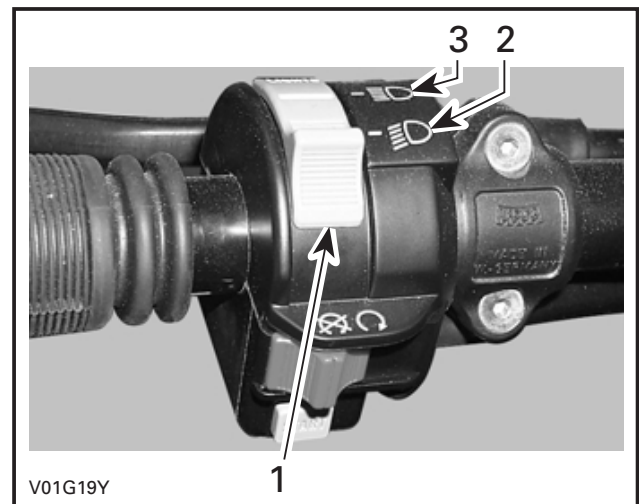

1. Headlight switch
2. Low beam position
3. High beam position

NOTE: Place ignition switch to ON "without light" position to close the headlight.

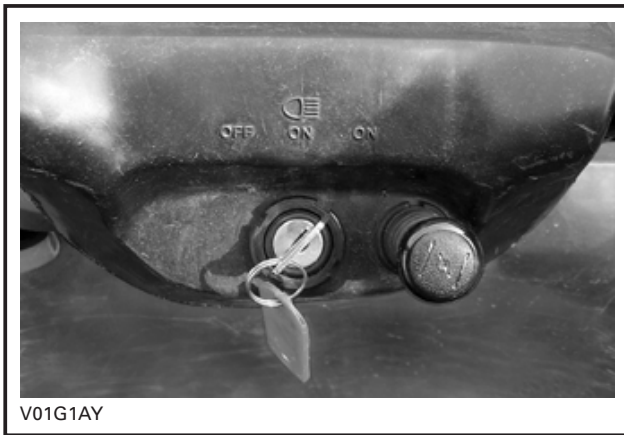

ON POSITION "WITHOUT LIGHT"

7) Engine Stop Switch

Located on left side of handlebar. The engine will turn over but will not start if the engine stop switch is turned to OFF position.

This switch can be used to stop engine and as an emergency control.

NOTE: While engine can be stopped by turning ignition key OFF, we recommend the engine be stopped by the engine stop switch.

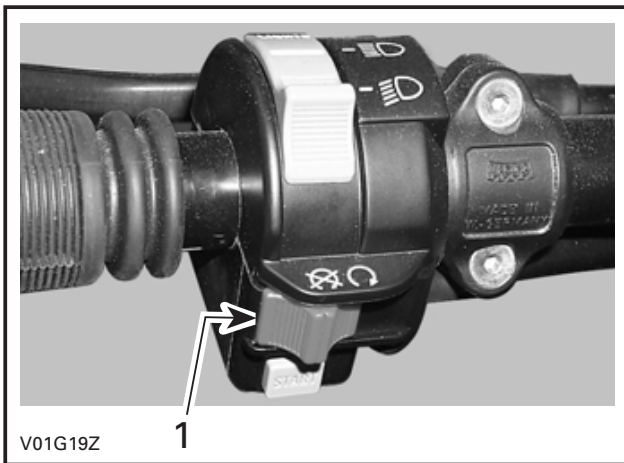

1. Engine stop switch

8) Start Button

Located on left side of handlebar.

To start engine, place the engine stop switch to RUN.

Press and hold the start button. Release immediately after engine is started.

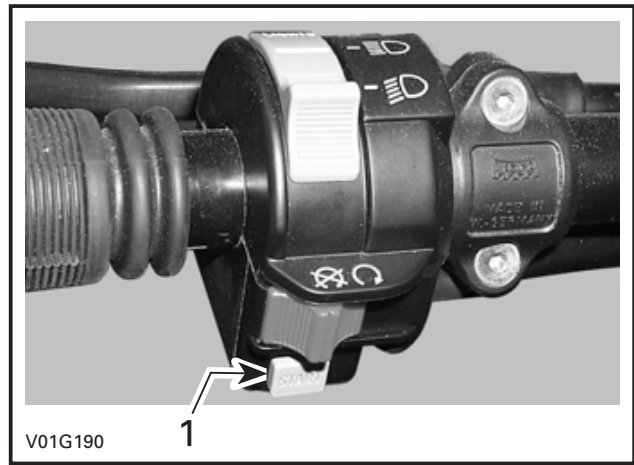

1. Start button

To stop engine, fully release throttle lever then use the engine stop switch.

9) Indicator Lights Cluster

NOTE: When first turning switch to ON (either position), the oil pressure indicator light will turn on for a brief moment. This validates its operation. Thereafter, only the lights that are activated will remain on (Reverse, Neutral and high intensity lights).

Located on right side of cluster. They light up to monitor different functions.

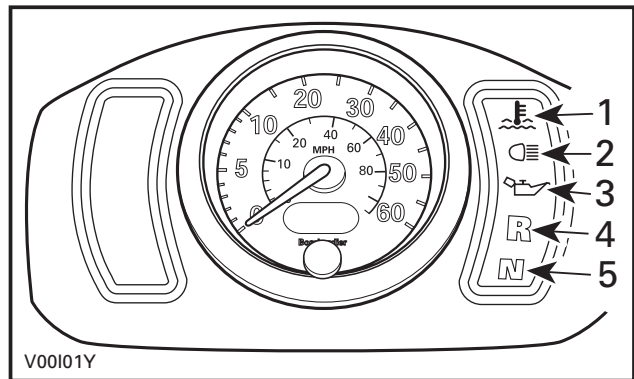

1. Engine temperature
2. High intensity
3. Oil pressure
4. Reverse
5. Neutral

Engine Temperature

When indicator light is ON, it indicates the engine is overheating.

If engine overheats, refer to **Engine Overheat** in SPECIAL PROCEDURES.

High Intensity

When the indicator light is ON, it indicates the high intensity is selected on the headlights.

Oil Pressure

When continuously ON, it indicates a low oil pressure condition of the engine. Refer to **Limp Home Mode** in SPECIAL PROCEDURES.

This light turns on when the ignition switch is turned ON and remains on until engine is running.

CAUTION: If the light does not turn off right after engine starting, stop engine. See an authorized Bombarrier ATV dealer. Do not use the vehicle until repaired.

Reverse

When lit, it indicates the transmission is engaged in reverse.

Neutral

When lit, it indicates the transmission is in neutral position.

10) Speedometer

Located in center of cluster. It indicates the speed of the vehicle in MPH and km/h. The speedometer is backlit when the ignition switch is turned on (either position).

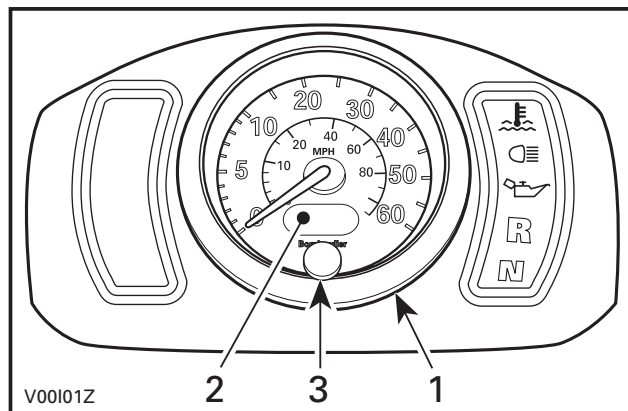

1. Speedometer
2. Odometer/trip meter
3. Display selection button

Odometer/Trip Meter

Combined LCD (Liquid Crystal Display) display. Odometer records the total distance traveled **in miles**. The trip meter records the distance traveled **in miles** until it is reset. The last right digit indicates the tenth of a **mile**. It can be used to approximately monitor the fuel tank range or distance between two locations for instance.

Display Selection Button

The odometer always appears when turning the ignition switch ON (either position). To change the display to the trip meter, momentarily press the button on the speedometer.

To reset the trip meter, push and HOLD button until all numbers read zero (while in trip meter selection).

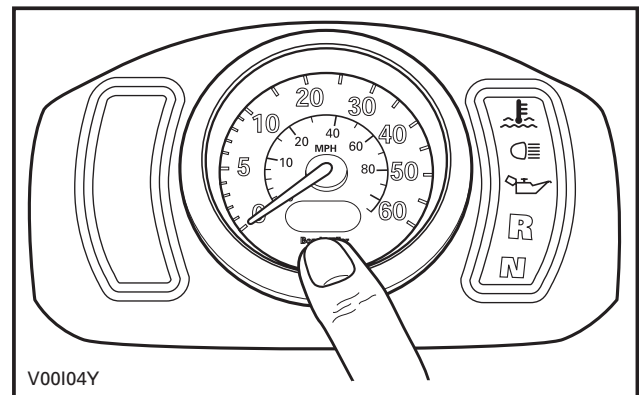

Press once to switch from odometer to tripmeter or vice versa. Press and hold to reset while in trip meter selection.

11) Ignition Switch

Located at bottom of cluster.

Key-operated, 3-position switch: OFF, ON with lights and ON without lights.

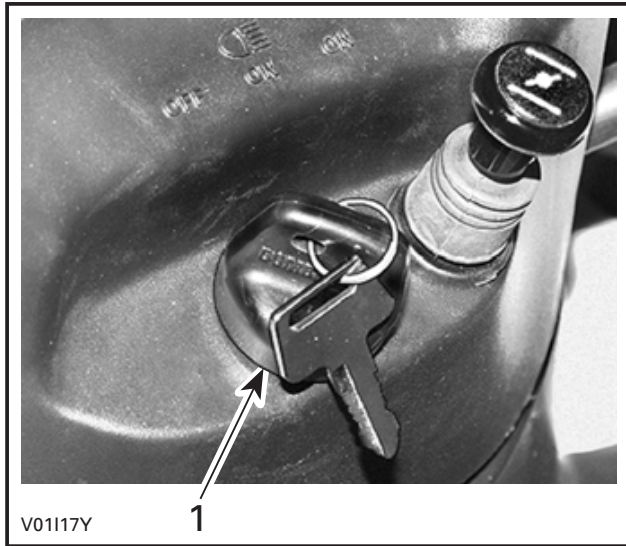

1. Ignition switch

Insert key in switch and turn to the desired position. To remove key, turn key to OFF then pull it out.

The ON with lights position, turns on all lights with either the engine running or not. Remember that having the lights on without the engine running discharges the battery. Always turn ignition to OFF after engine has been stopped.

NOTE: While engine can be stopped by turning ignition key OFF, we recommend the engine be stopped by the engine stop switch.

12) Choke Knob Lever

Located at bottom of cluster. This device features a variable lever to ease cold start.

Position OFF is for normal use with a warm engine (pushed in).

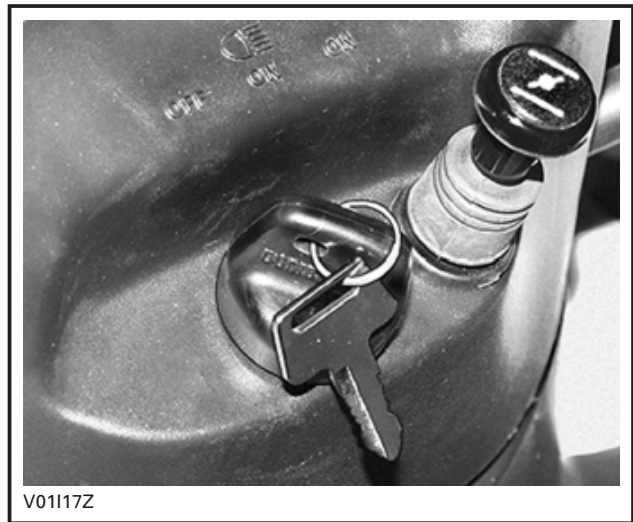

CHOKE KNOB LEVER IN THE OFF POSITION

The full choke position is used for lower temperature (fully extended).



CHOKE LEVER IN THE FULL CHOKE POSITION

The other positions between OFF and FULL position, will be use depending on the temperature.

13) Fuel Tank Cap

Unscrew counterclockwise and remove cap to allow fuel tank filling then fully tighten clockwise.

WARNING

Never use an open flame to check fuel level.

14) Fuel Gauge

Located in front of seat under cluster, the gauge shows an approximate amount of the fuel in tank.

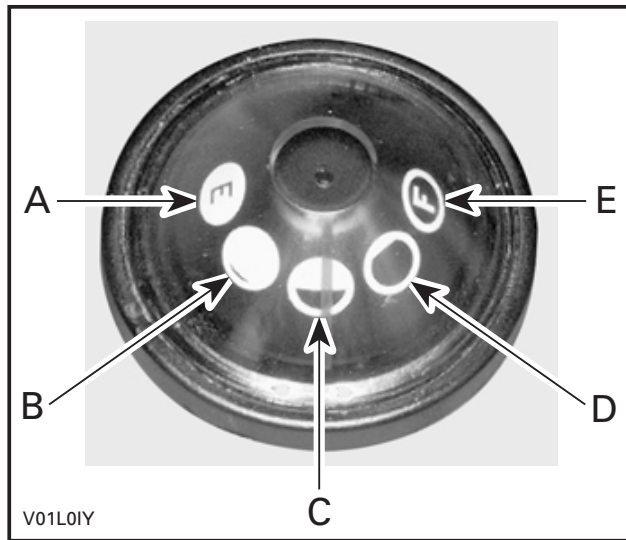

- A. Empty
- B. 1/4
- C. 1/2
- D. 3/4
- E. Full

15) Fuel Valve

Located on left side panel under front part of seat. 3-position rotary valve: OFF, ON, RES. Rotate the knob to align its pointer with ON, OFF or RES.

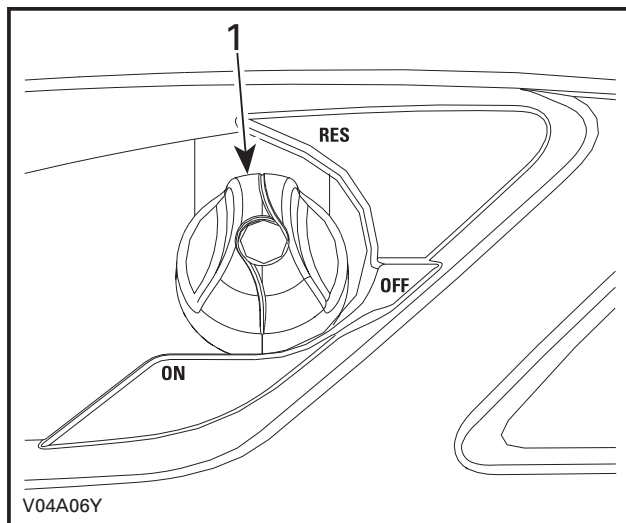

1. Align this pointer toward the desired position

OFF

Stops fuel supply to carburetor.

CAUTION: Turn valve to OFF position when ATV is not being operated or when transporting.

ON

Allows fuel to flow to carburetor. This is the normal position for operation of the vehicle.

RES (RESERVE)

When fuel is exhausted in the fuel tank when in the ON position, an emergency supply of fuel is available by turning the knob to RES. The reserve contains approximately 30% of the fuel tank capacity. Use only this position when the ON supply is empty.

When down to the reserve, refuel as soon as possible. Ensure to turn the valve back to the ON position after refuelling.

CAUTION: Improper opening of fuel valve will restrict the flow of fuel. Make sure valve is fully opened while running.

16) Rear Brake Pedal

Located on the right footpeg. When pressed down, the brake is applied. When released, it should return to its original position. Braking effect is proportional to the force applied on the lever and to the type and condition of the terrain.

NOTE: The brake will have also an effect on front wheels through the drive train.

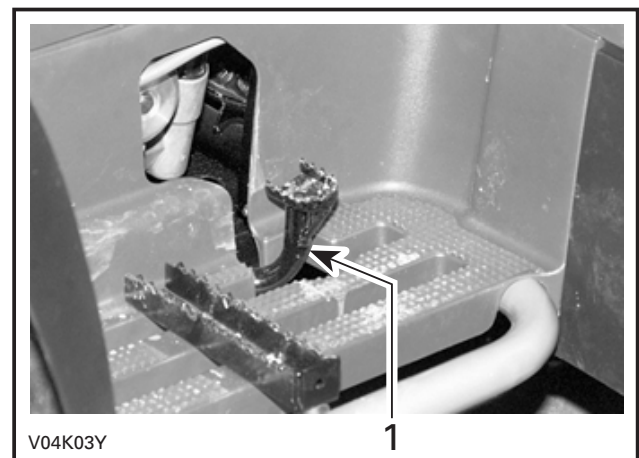

1. Rear brake pedal

17) Rewind Starter Handle (if so equipped)

The rewind starter handle is provided as an emergency starting device.

Follow the usual starting procedure; but use the rewind starter instead of the electric starter.

Located on right side panel under seat. Auto-rewind type. To engage mechanism, pull handle slowly until a resistance is felt then continue to slowly pull the handle until the compression stroke **peak** (strong rotating resistance) is overpassed then, pull vigorously. Slowly release handle.

18) Footpeg

Located on footrest. Use this area to maintain your feet stable.

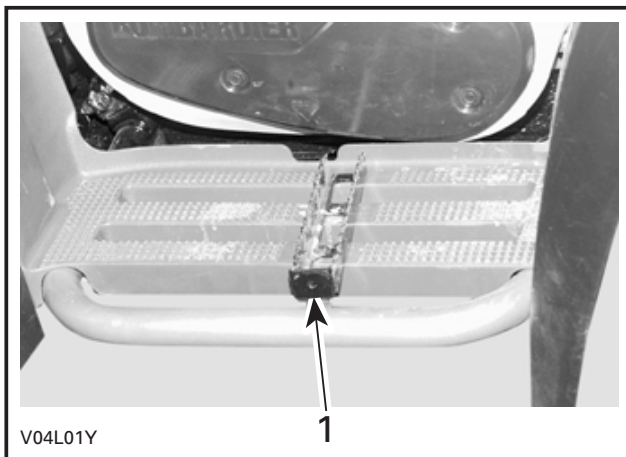

1. Footpeg

19) Storage Compartment

Located in front of vehicle. Convenient location to carry personal articles such as an a helmet, spare spark plugs, first aid kit, etc. Unlatch cover, gently lift then remove cover.

The compartment is equipped with a drain plug under the tool box. Remove plug to allow draining when necessary. Reinstall plug when finished.

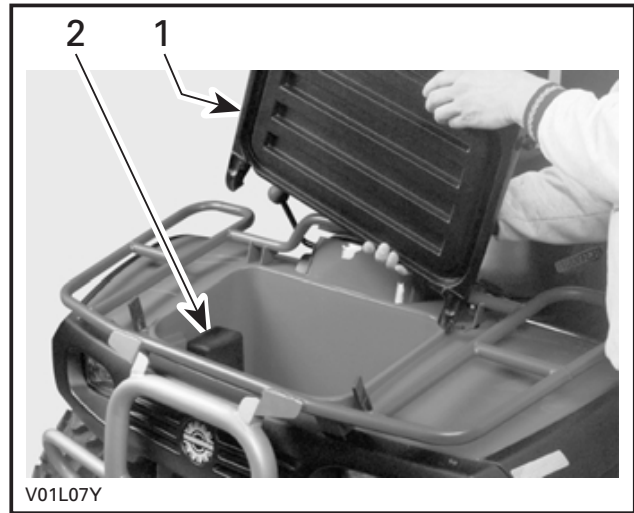

1. Removing cover
2. Tool box

It also contains the *Operator's Guide* and *Safety Handbook* that should be kept in a waterproof bag and remain with the vehicle at all times.

⚠ WARNING

Never leave any heavy or loose breakable objects in the storage basket. Always latch cover before riding. If storage cover is removed to provide greater carrying area, ensure that cargo is secured and will not "fly out" when riding at speed on rough terrain. Slow down.

Tool Box

Located in storage compartment. The tool box contains tools for basic maintenance, the *Operator's Guide* and the *Safety Handbook*.

20) Seat Latch

Located underneath rear end of seat. It allows the removal of seat to give access to engine compartment.

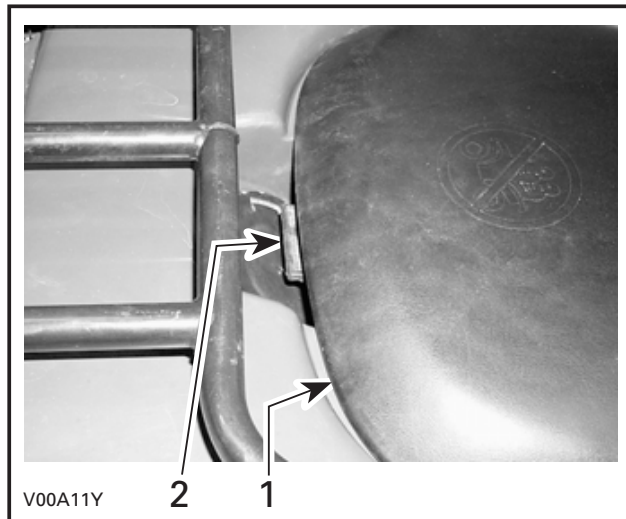

1. Seat
2. Seat latch

Seat Removal

Pull latch upward while gently lifting rear of seat. Pull seat rearward. Continue lifting movement until you can release the front retaining device then completely remove seat.

Seat Installation

Insert front tab of seat into frame hook. When seat rests in its position, firmly push seat down to latch.

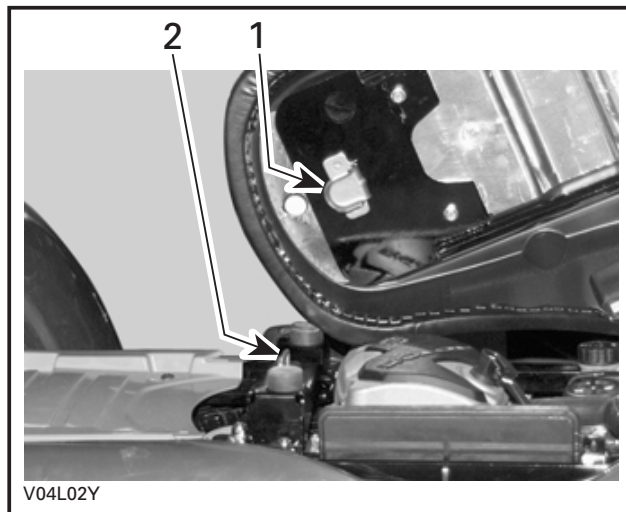

1. Insert this tab in hook
2. Hook

⚠ WARNING

Periodically verify the seat lock pin and tighten if needed. Make sure seat is securely latched before riding.

21) Front/Rear Cargo Racks

Located on top of chassis at front and rear. Convenient racks to carry gear.

⚠ WARNING

Ensure to properly secure material to rack. Do not overload. Ensure load does not interfere with visibility and/or steering. Do not carry passenger(s).

Refer to SPECIFICATIONS for carrying loads and cargo weight distribution recommendations.

22) Air Duct

Located on rear fenders. They force the flow of air to cool radiator.

CAUTION: Do not place anything over air intake ducts.

23) Trailer Hitch

Located on rear axle. Convenient hitch to install a ball to tow a trailer or other equipment. Install the proper ball size as per trailer manufacturer recommendations. Refer to SPECIFICATIONS for carrying loads and towing recommendations.

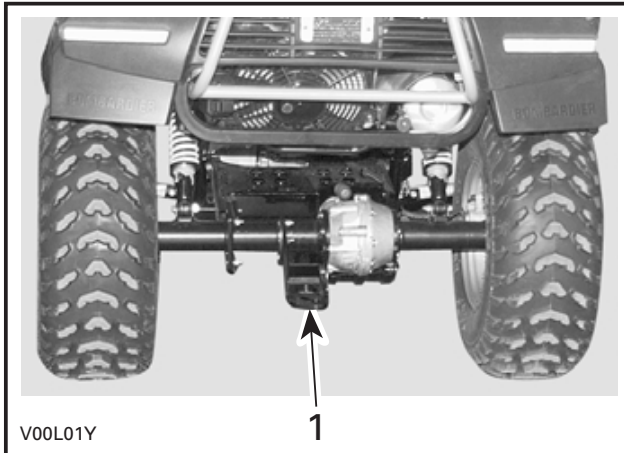

1. Trailer hitch

⚠ WARNING

Ensure to install the proper ball size that matches the equipment you will tow.

NOTE: Follow manufacturer instructions for proper attachment.

24) Radiator Cap

Located at rear of rear fender. It provides access to the radiator filling neck.

Pull the protector cap to give access to the radiator cap. When finished, properly reinstall radiator cap then protector cap.

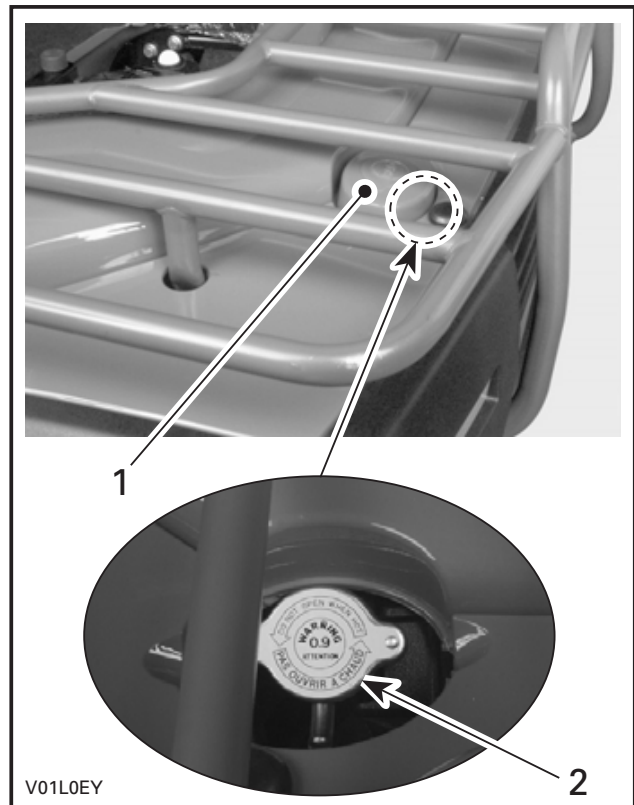

1. Protector cap
2. Radiator cap

25) 12-Volt Power Outlet

It is located on left side of cluster.

Convenient for handheld spotlight or other portable equipment.

Remove cap to use. Always reinstall protective cap after use to protect against weather.

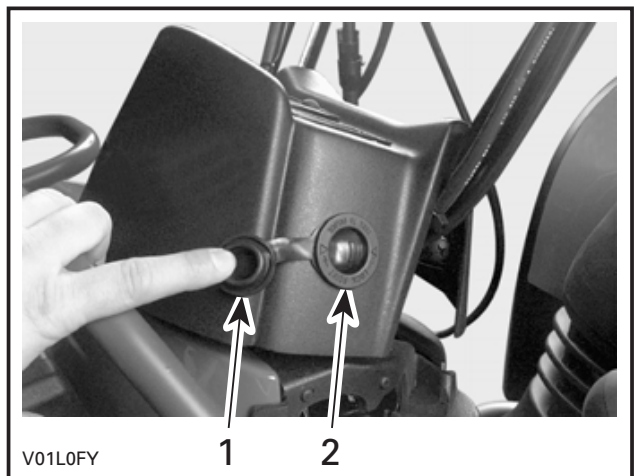

TYPICAL
1. Protective cap
2. Power outlet

Do not exceed the rating capacity. See SPECIFICATIONS.

An auxiliary supply is available to connect additional accessories through a connector at the rear of vehicle. See an authorized Bombardier ATV dealer for more details.

26) Fuses

The electrical system is protected with fuses. Refer to MAINTENANCE for details.

The fuse block is located at the rear of the vehicle, on left side, under fender.

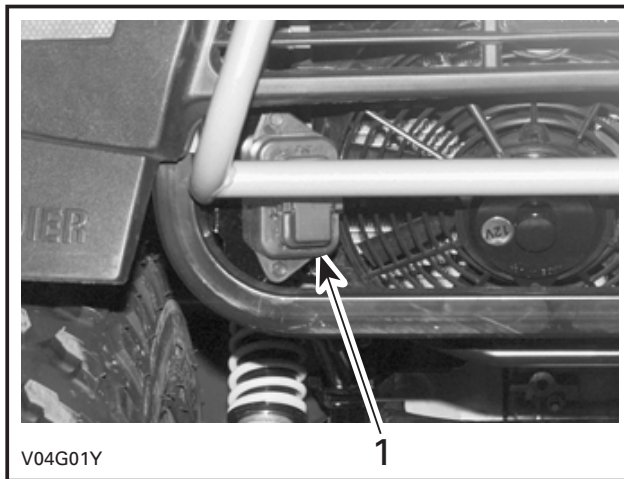

1. Fuse block

Winch (if so equipped)

Located behind front skid plate.

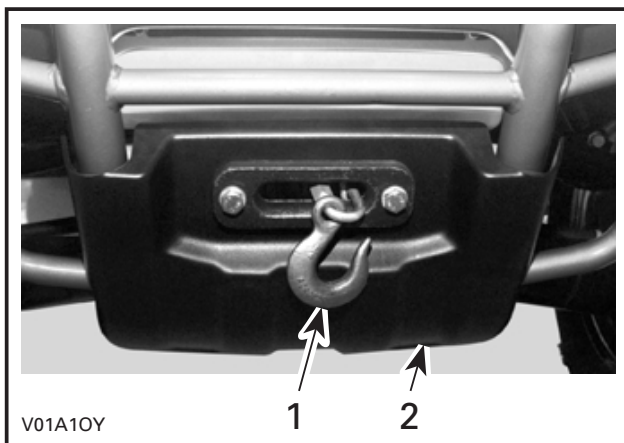

1. Winch
2. Front skid plate

Winch Control Switch (if so equipped)

Located on the LH side of the front fender.

To take out wire rope from winch, turn switch button counterclockwise.

To get wire rope into the winch, turn the switch button clockwise.

Refer to ATV Winch Operator's Manual for more informations.

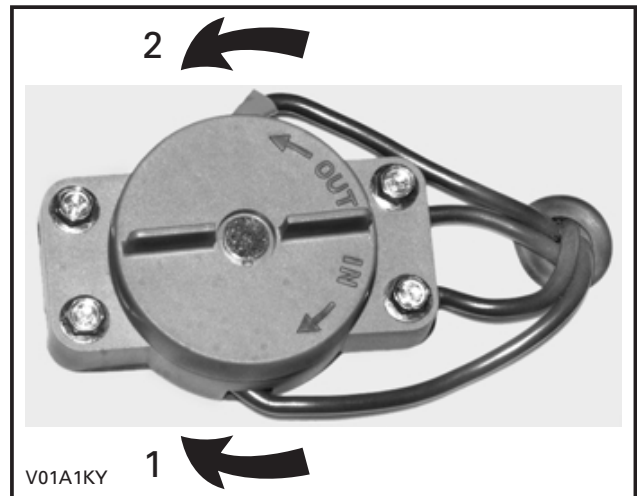

1. In
2. Out

Fairlead (if so equipped)

Located on the front skid plate.

The fairlead is used to prevent the damages to the vehicle and guide the wire rope into the winch.

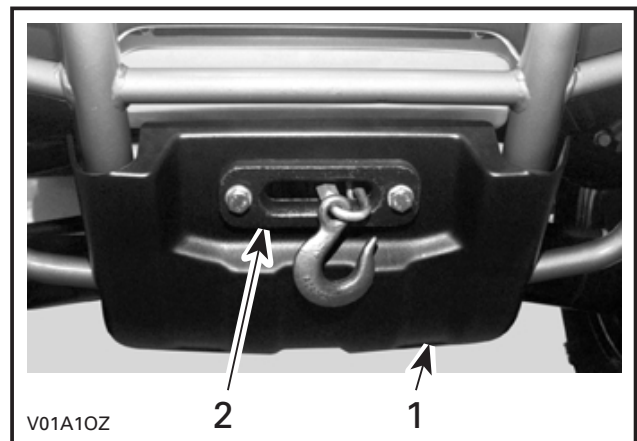

1. Front skid plate
2. Fairlead

LIQUIDS

While reading this *Operator's Guide*, remember that:

WARNING

Indicates a potential hazard that could result in serious injury or death.

This section specifies the recommended liquids and procedures to check their levels. Refer to MAINTENANCE for procedures to replace the liquids.

Fuel

Recommended Fuel

Use regular unleaded gasoline or gasohol containing less than 10% of ethanol or methanol, available from most service stations. The gasoline used must have an octane number of 87 ((R + M)/2) or higher.

NOTE: In most service station, pump octane number corresponds to (R + M)/2 octane number. Usually a sticker can be found on the pump.

CAUTION: Never experiment with other fuels. The use of unrecommended fuel can result in vehicle performance deterioration and damage to critical parts in the fuel system and engine components.

CAUTION: Never mix oil with fuel. This ATV has a 4-stroke engine. Oil must be added to engine base only.

Fuel Level

WARNING

Never top up the fuel tank before placing the vehicle in a warm area. As temperature increases, fuel expands and may overflow. Fuel is flammable and explosive under certain conditions. Always wipe off any fuel or oil spillage from the vehicle.

Engine/Transmission Oil

Recommended Oil

Use 4-stroke engine oil that meets or exceeds the requirements for API service classification SG, SH or SJ. Always check the API service label on the oil container to be sure it includes the letters SG, SH or SJ. Only use high-quality high-detergent oil.

NOTE: The same oil lubricates both engine and transmission. For improved overall performance and wear protection use Bombardier synthetic oil (P/N 293 600 039).

Oil Viscosity

SAE 10W40 is recommended for summer time.

SAE 5W30 is recommended for winter time.

For other viscosity see applicative chart below.

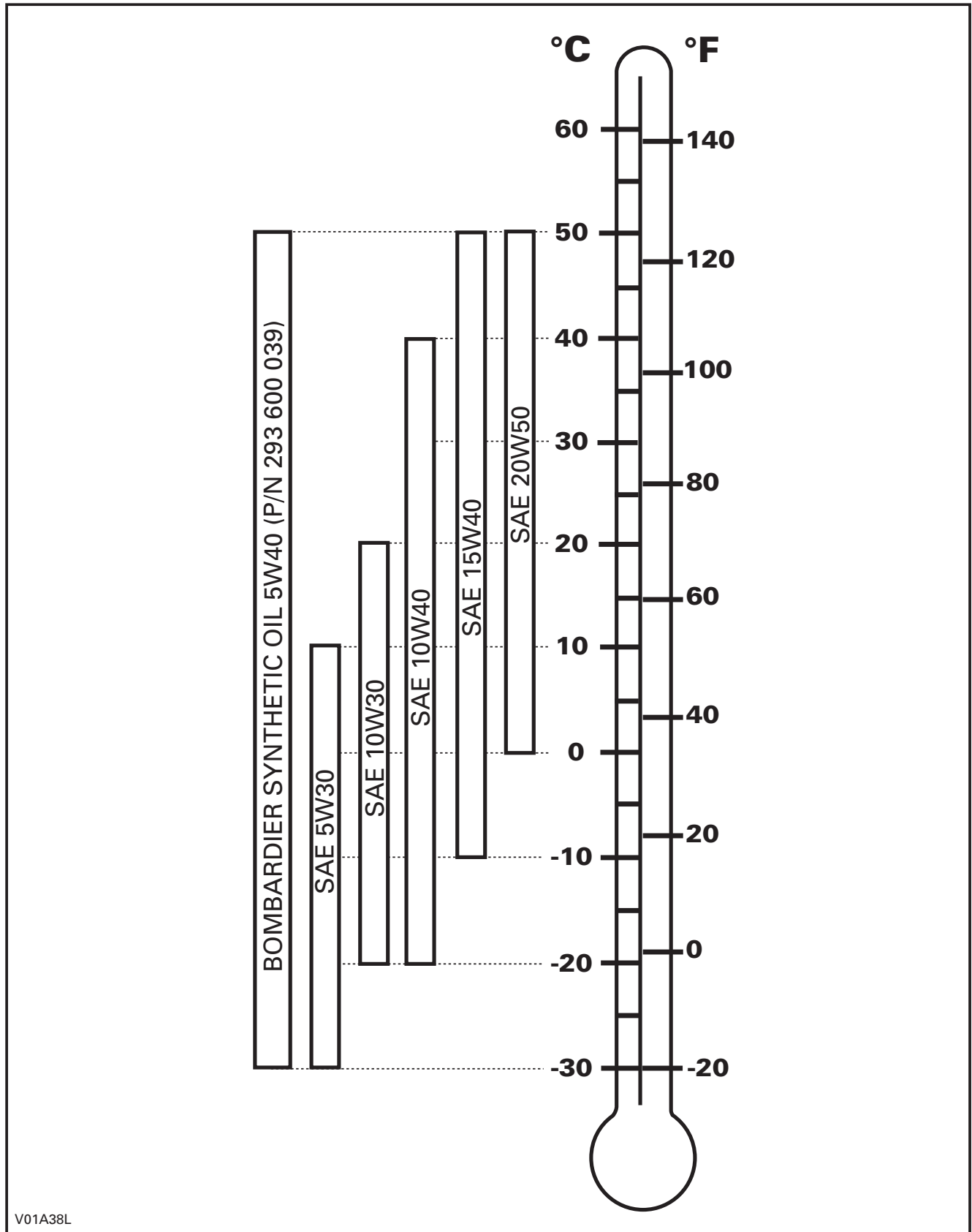

V01A38L

Oil Level

CAUTION: Check level frequently and refill if necessary. Do not overfill. Operating the engine/transmission with an improper level may severely damage engine/transmission. Wipe off any spillage.

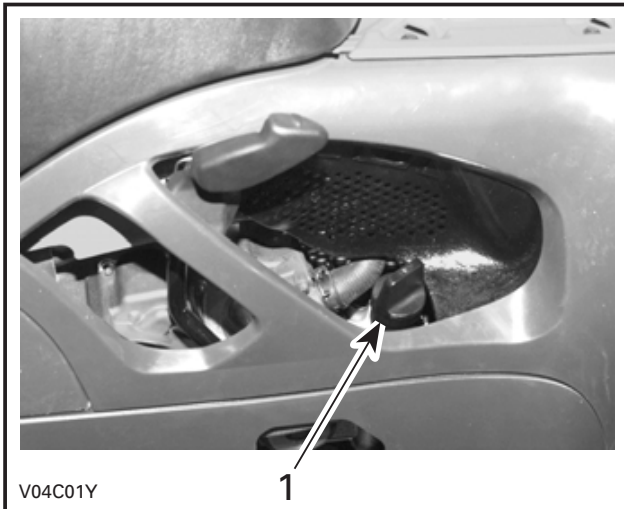

V04C01Y

1

RH SIDE OF ENGINE

1. Dipstick

With vehicle on a level surface and engine cold, not running, check the oil level as follows:

1. Unscrew dipstick then remove it and wipe clean.
2. Reinstall dipstick, screw in it completely.
3. Remove and check oil level. It should be near or equal to the upper mark.

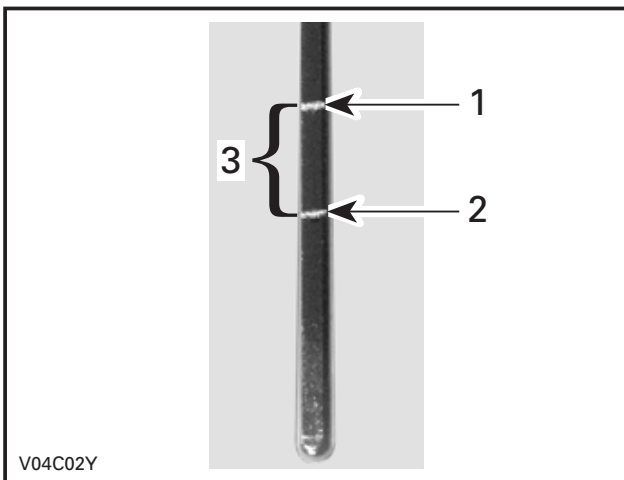

V04C02Y

1. Full
2. Add
3. Operating range

4. Add oil up to upper mark if required.
5. To add oil, remove dipstick. Place a funnel into the dipstick tube and fill with the recommended oil. Do not overfill.

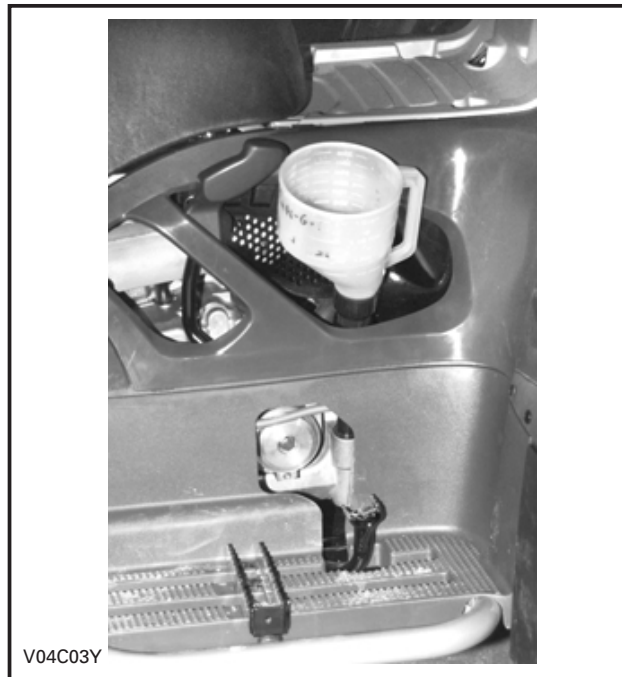

V04C03Y

6. Properly tighten dipstick.

Engine Coolant

Recommended Coolant

Always use ethylene-glycol antifreeze containing corrosion inhibitors specifically for internal combustion aluminum engines.

Cooling system must be filled with water and antifreeze solution (50% water, 50% antifreeze).

Coolant Level

WARNING

Check coolant level with engine cold. Never add coolant in cooling system when engine is hot.

Remove seat.

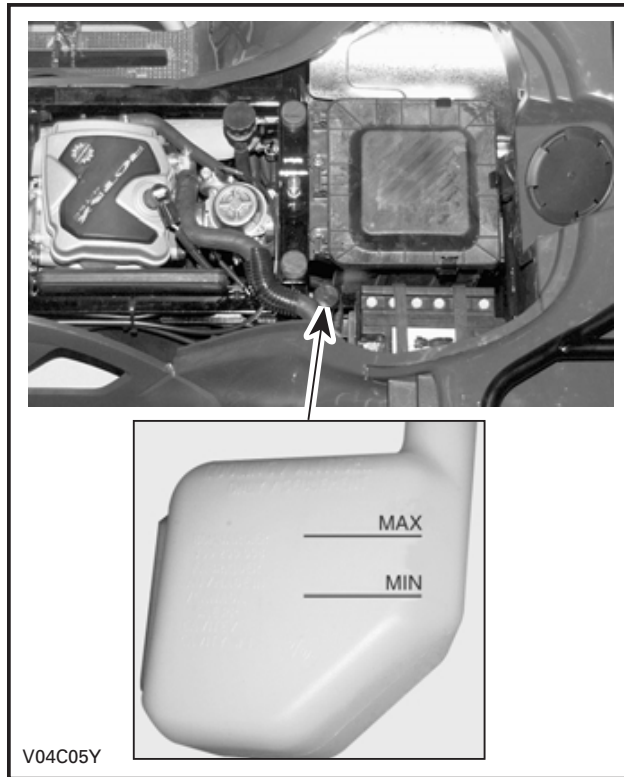

With vehicle on a level surface, liquid should be between MIN. and MAX. level marks of coolant reservoir.

NOTE: When checking level at temperature lower than 20°C (69°F), it may be slightly lower than MIN. mark.

Add coolant up to MAX. mark if required. Use a funnel to avoid spillage. **Do not overfill.**

Properly reinstall and tighten filler cap and reinstall seat.

If the coolant is added in the coolant reservoir, check the level in the radiator too. Add coolant if necessary.

NOTE: A cooling system that frequently requires coolant is the indication of leaks or engine problems. See an authorized Bombardier ATV dealer.

Coolant Replacement

Refer to MAINTENANCE section.

Brake Fluid

Recommended Fluid

Always use brake fluid meeting the specification DOT 4 only.

CAUTION: Never use other type of oil such as mineral-based or synthetic oil.

Fluid Level

With vehicle on a level surface, check brake fluid in reservoir for proper level. It should be above MIN. mark.

Add fluid as required. **Do not overfill.** Clean filler cap before removing.

CAUTION: Use only DOT 4 brake fluid from a sealed container.

NOTE: A low level may indicate leaks or worn brake pads. See an authorized Bombardier ATV dealer.

Front Brake Fluid Reservoir

Turn steering in the straight-ahead position to ensure reservoir is level. Check the brake fluid level, the reservoir is full when the fluid reaches of the top of window.

Visually inspect lever boot condition. Check for cracks, tears, etc. Replace if damaged.

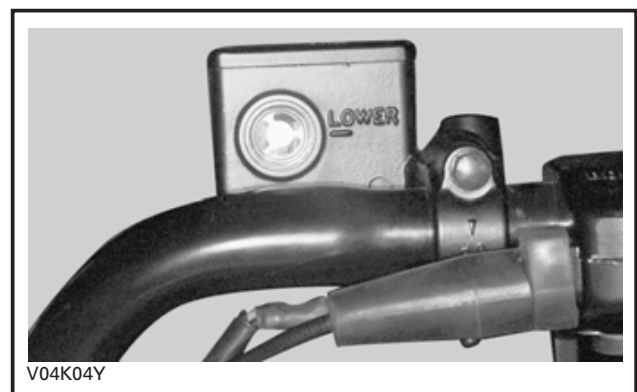

Rear Brake Fluid Reservoir

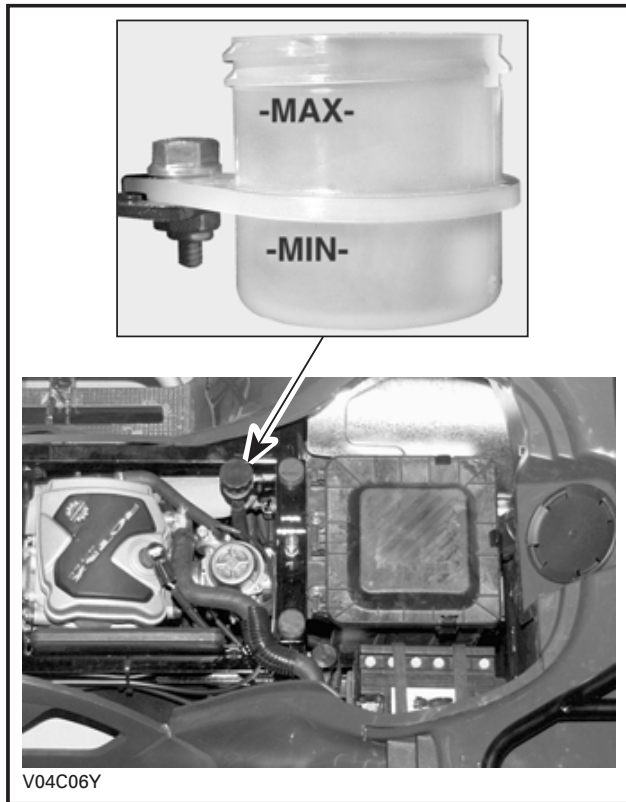

Battery Electrolyte

Recommended Liquid

It is recommended to use distilled water.

Electrolyte Level

Place the vehicle on a level surface.

Check electrolyte level by the rear left inner fender. Use a flashlight if necessary. Do not use an open flame.

The electrolyte should be between lower and upper marks. If level is low, remove battery from vehicle to add distilled water.

Battery

Removal

Disconnect negative BLACK cable first then positive cable.

WARNING

Always respect this order for disassembly; disconnect BLACK negative cable first. Electrolyte or fuel vapors can be present in engine compartment and a spark may ignite them and possibly cause personal injuries.

Remove the holding straps.

Pull out vent tube from frame.

Remove battery from vehicle being careful not to tilt it so that electrolyte flows out of vent tube.

WARNING

Electrolyte is poisonous and dangerous. Avoid contact with eyes, skin and clothing. Wear protective eyeglasses and a suitable pair of non-absorbent gloves when removing the battery by hand.

CAUTION: Should any electrolyte spillage occur, immediately wash off with a solution of baking soda and water.

Refilling

Place battery on a level surface.

Unscrew caps and add distilled water up to upper mark as required. Do not overfill.

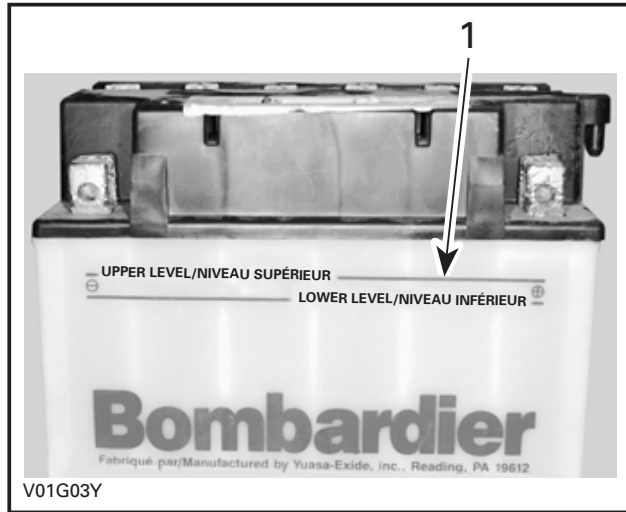

1. Upper mark

Properly retighten caps.

Installation

Reinstall battery in vehicle. Fasten battery and make sure to reinstall the vent tube.

WARNING

Connect positive RED cable first then negative cable. Always connect RED positive cable first.

NOTE: Place the positive RED cable between holding straps and battery.

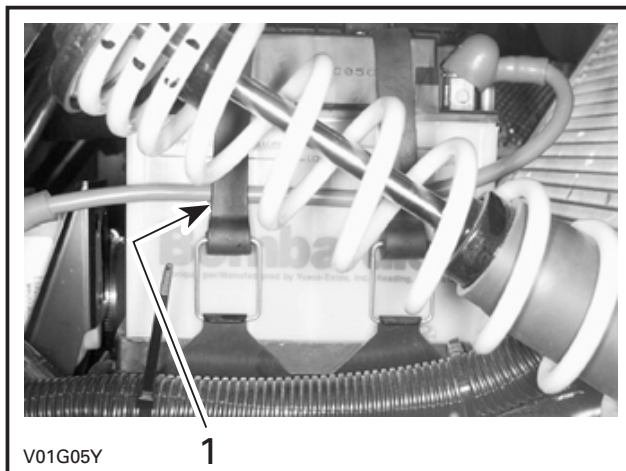

1. Cable between battery and strap

BREAK-IN PERIOD

Engine

A break-in period of 10 operating hours is required before running the vehicle at sustained full throttle.

CAUTION: Never mix oil with fuel. This vehicle has a 4-stroke engine. Oil must be added to engine base only.

During this period, maximum throttle should not exceed 3/4. **However, brief full acceleration and speed variations contribute to a good break-in.** Continued wide open throttle accelerations, prolonged cruising speeds and engine overheating are detrimental during the break-in period.

Belt

A new belt requires a break-in period of 30 miles (50 km). Avoid strong acceleration/deceleration, pulling a load or high speed cruising.

10-Hour Inspection

As with any precision piece of mechanical equipment, we suggest that after the first 10 hours or 30 days after the purchase, whichever comes first, your vehicle be inspected by an authorized Bombardier ATV dealer. This inspection will give you the opportunity to discuss the unanswered questions you may have encountered during the first hours of operation.

The 10-hour inspection is at the expense of the vehicle owner.

While reading this *Operator's Guide*, remember that:

WARNING

Indicates a potential hazard that could result in serious injury or death.

PRE-OPERATION CHECK

WARNING

The pre-operation check is very important prior to operating the vehicle. Always check the proper operation of critical controls, safety features and mechanical components before starting. If not done as specified here, severe injury or death might occur.

- Check tire pressure and condition.
- Check wheels and bearings for wear and damage.
- Check location of controls and ensure they work properly.
- Verify steering operates freely.
- Activate throttle control lever several times to ensure it operates freely. It must return to idle position when released.
- Activate the brake levers and foot pedal to make sure the brakes fully apply. Levers and pedal must fully return when released.
- Ensure transmission lever is working then reset in PARK position.
- Check fuel, oil and coolant levels.
- Check for oil leaks on the engine/transmission and drive train components.
- Ensure fuel valve is in fully open position (ON).
- Clean headlights and taillight.
- Ensure front storage cover compartment is properly latched.
- Ensure seat is properly latched.
- If you transport cargo, respect load capacity. Ensure cargo is properly secured to the racks.
- If you are pulling a trailer or other equipment, ensure it respects the tongue capacity and towing capacity. Ensure trailer is properly secured to hitch.
- Look and feel for loose parts while engine is off. Check fasteners.
- Ensure the path of travel is free of persons and obstacles.
- Check operation of ignition switch, start button, engine stop switch, headlights, dimmer switch, taillight and indicator lights.
- Start engine and drive forward slowly a few feet and apply all brakes individually to test them.

Correct any problem you may have found. See an authorized Bombar-dier ATV dealer as necessary.

OPERATING INSTRUCTIONS

General

Transmission lever must be on PARK or NEUTRAL to allow engine starting.

NOTE: For your convenience, an override mode allows the engine to be started with the transmission lever in any position. Press and hold the front brake lever while pressing the start button.

Place the engine stop switch to RUN position then press start button.

Initial Cold Starting

Insert key in ignition switch and turn to ON.

NOTE: Do not forget, place the engine stop switch to RUN position.

In cold weather, colder than 0°C (32°F), fully pull up the choke lever.



1. Full choke position

Press start button and hold until engine starts.

CAUTION: Do not hold start button more than 30 seconds. A rest period should be observed between the cranking cycles to let starter cool down. Pay attention not to discharge battery.

NOTE: Throttle assist may be used to help engine starting faster. Press the throttle lever slightly. If too much throttle is used the choke system will not be activated.

Release start button immediately when engine has started.

After a few minutes, push in the choke lever until the best engine RPM is achieved.

NOTE: Overusing choke may flood engine and make it hard to start. Refer to SPECIAL PROCEDURES if it occurs.

When the engine is warm, push the choke lever to OFF and release brakes.

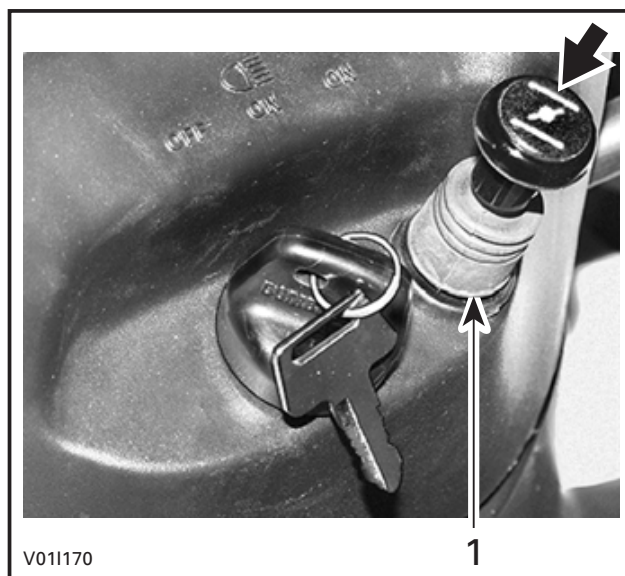

1. OFF position

Warm Engine Starting

Start the engine as explained above but without any choke. If the engine will not start after two 5-second attempts with the electric starter, pull the choke lever and place it half way position. Start the engine without activating the throttle lever. After few seconds, push the choke lever to OFF.

Emergency Manual Starting (if so equipped)

WARNING

Always place transmission lever on PARK or NEUTRAL before starting engine manually.

Manual start is provided in the event electric start does not work.

Set transmission lever in PARK or NEUTRAL position. Apply parking brake then turn the ignition key ON.

Grasp manual starter handle firmly and, slowly, crank engine until a resistance appears.

Pass this resistance and release the handle.

Take again the handle firmly and crank engine.

Repeat this procedure completely if necessary.

Stopping the Engine

WARNING

Avoid parking on an incline land.

Release throttle and completely stop the vehicle.

Apply the parking brake.

Set transmission lever in PARK position.

Push the engine stop switch in OFF position.

Turn key in ignition switch to OFF.

Remove key from ignition switch.

Shifting the Transmission

Let engine idle to warm up.

Apply brakes and select the desired gear range H/L.

NOTE: The brake must be applied when the transmission lever is engaged in the park position.

Release brakes.

CAUTION: Make sure parking brake is fully disengaged before operating the ATV.

Gradually press the throttle lever to increase engine speed and thus engaging the continuously variable transmission (CVT).

At the opposite, when the throttle lever is released, the engine speed decreases.

Using the Reverse

CAUTION: When changing from forward to reverse, or vice-versa, always completely stop the vehicle and apply the brake prior to moving the transmission lever.

The same procedures as **Shifting the Transmission** above apply except for the following.

Set the transmission lever in REVERSE position.

SPECIAL PROCEDURES

Flooded Engine

When the engine does not start after several attempts, the engine may be fuel flooded. Proceed as follows.

Turn ignition switch to ON and ensure choke is not applied.

Ensure the transmission lever is on PARK.

Fully press throttle lever and hold while starting the engine.

As soon as the engine starts, release throttle lever. Do not race engine.

If it does not work:

Disconnect the single-spark ignition coil.

Clean the single-spark ignition coil area then remove it. Remove the spark plug (tools are supplied in tool box).

WARNING

Always wear eye protector and gloves when the spark plug hole is cleaned.

Crank engine several times. Add a small quantity of engine oil in cylinder (equivalent to a cap of oil quart). Install new spark plug if possible or clean and dry spark plug.

Start engine as explained above. If engine continues to flood, see an authorized Bombardier ATV dealer.

Engine Overheat

If engine overheats and indicator light turns on, try the following:

Ensure air ducts are not obstructed.

Check and clean radiator fins. See MAINTENANCE section.

WARNING

The radiator can be very hot, wear gloves before touching radiator.

Reduce vehicle speed but try to keep vehicle moving to supply air to radiator. If engine is still overheating after approximately one minute, stop vehicle and set transmission to PARK. Stop engine.

Place the ignition switch to ON position (**Do not restart engine yet**). The radiator fan will cool the radiator.

Let engine cool down. Check coolant level and refill if possible.

WARNING

Never refill cooling system when engine is hot.

See an authorized Bombardier ATV dealer as soon as possible.

Post-Operation Care

When vehicle is used in salt-water environment (beach area, launching/loading boats etc.), rinsing the vehicle with fresh water is necessary to preserve vehicle and its components. Metallic parts lubrication is highly recommended. Use BOMBARDIER LUBE. This must be performed at the end of each operating day.

When vehicle is operated in muddy conditions, rinsing the vehicle is recommended to preserve vehicle and its components and to keep lights clean.

Flipped Over

When vehicle is flipped over or stays tilted on the side, wait 3 to 5 minutes before starting engine. Check oil level and refill if necessary. If the oil pressure light stays ON after starting engine, stop engine and see an authorized Bombardier ATV dealer as soon as possible.

ATV Immersion

Should the ATV become immersed, it will be necessary to take it to an authorized Bombardier ATV dealer as soon as possible. **DO NOT START THE ENGINE!** Immersion of the ATV can cause serious damage if not correctly repaired.

Limp Home Mode

When low oil pressure is detected in the engine, the engine RPM may be reduced and not allowed to reach its maximum RPM as usual. In this case, letting the engine return to idle speed, turning OFF the ignition key and restarting engine may allow normal operation.

This performance-reduced mode allows the rider to go back home which would not be possible without this advanced system. If this occurs, see an authorized Bombardier ATV dealer as soon as possible for inspection.

Storage and Preseason Preparation

WARNING

Have an authorized Bombardier ATV dealer inspect fuel system integrity as specified in MAINTENANCE CHART.

When a vehicle is not in use for more than one month, proper storage is a necessity.

See an authorized Bombardier ATV dealer for proper procedures.

When using your ATV after storage, a preparation is required. See an authorized Bombardier ATV dealer for proper procedures.

MAINTENANCE CHART

The maintenance is very important, if you are not familiar with safe service practices and adjustment procedures, see your authorized Bombardier ATV dealer.

LUBRICATION AND MAINTENANCE CHART I: Inspect, verify, clean, adjust, lubricate, replace if necessary C: Clean L: Lubricate R: Replace	INITIAL 10 h INSPECTION OR 185 mi (300 km) ①	EVERY				TO BE PERFORMED BY
		25 h OR 470 mi (750 km)	50 h OR 930 mi (1500 km)	100 h OR 1 YEAR OR 1865 mi (3000 km)	200 h OR 2 YEARS OR 3730 mi (6000 km)	
ENGINE/TRANSMISSION						
Engine/transmission oil and filter ④	R		R			CUSTOMER
Engine/transmission oil strainer cleaning					C	CUSTOMER
Engine mount fasteners	I			I		DEALER
Exhaust system	I			I		DEALER
Spark arrester				C		CUSTOMER
Condition of seals	I			I		DEALER
Coolant ④	I			⑥	R	CUSTOMER
Radiator cap/cooling system pressure test	I				I	DEALER
Radiator condition/cleanliness (air ducts and radiator fins) ③	I		I			CUSTOMER
Drive belt				I ②		DEALER
Cleaning/condition of drive and driven pulleys				C		DEALER
CVT air inlet duct condition/cleanliness and sealing	I		I			DEALER
Rewind starter rope condition (if so equipped)				I		DEALER
FUEL SYSTEM						
Air filter ④		C ③		R ③		CUSTOMER
Fuel lines and connections	I			I		DEALER
Fuel tank strainer					R	DEALER
Carburetor	I			I		DEALER
ELECTRICAL SYSTEM						
Spark plugs ⑤	I			R		DEALER
Battery electrolyte level/connections/vent	I		I			CUSTOMER
Wiring harnesses, cables and lines	I			I		DEALER
Condition of ignition switch, start button and engine stop switch ④	I			I		CUSTOMER
Condition of lighting system (HI/LO intensity, brake light, headlight aiming, etc.) ④	I			I		CUSTOMER
Winch connections	Refer to ATV Winch Operator's Manual					CUSTOMER
DRIVE TRAIN						
Drive shaft boot and protector ④	I	I				CUSTOMER
Drive shaft joint			I			DEALER
Front/Rear propeller shaft joint (grease fitting)	I		L			DEALER
Wheel bearings condition				I		DEALER
Front differential and rear axle oil level, seals and vents	I		I		R	DEALER
STEERING/CONTROL SYSTEMS						
Handlebar fasteners				I		DEALER

LUBRICATION AND MAINTENANCE CHART I: Inspect, verify, clean, adjust, lubricate, replace if necessary C: Clean L: Lubricate R: Replace	INITIAL 10 h INSPECTION OR 185 mi (300 km) ①	EVERY				TO BE PERFORMED BY
		25 h OR 470 mi (750 km)	50 h OR 930 mi (1500 km)	100 h OR 1 YEAR OR 1865 mi (3000 km)	200 h OR 2 YEARS OR 3730 mi (6000 km)	
Throttle/housing/cable ④	I		I			CUSTOMER
Choke condition ④	I		I			CUSTOMER
Steering system ③	I			I		DEALER
Tie rod end			I			DEALER
Wheel nuts/studs	I		I			CUSTOMER
Wear/Pressure of tires ④	I	I				CUSTOMER
Front wheel alignment	I			I		DEALER
SUSPENSION						
Swing arm ④				I		DEALER
Shock absorber ④			I			DEALER
A-arm			I			CUSTOMER
BRAKE						
Brake fluid front/rear ④	I	I			R	DEALER
Brake cable	I		I			DEALER
Brake pad		I				DEALER
Brake system (discs, hoses etc.)				I		DEALER
BODY/FRAME						
Engine compartment	C		C			CUSTOMER
Skid plates	I		I			CUSTOMER
Frame				I		DEALER
Hitch/trailer ball condition (if installed)	I		I			CUSTOMER
Chassis fasteners			I			CUSTOMER
Front storage compartment cover/seat latches ④			I			CUSTOMER
Vehicle cleaning and protection			C			CUSTOMER

- ① To be performed by an authorized Bombardier ATV dealer. The initial maintenance is very important and must not be neglected.
- ② Measure and verify the drive belt. If the drive belt width is equal or less than 30 mm (1-3/16 in) or if flat spots, cracks or other damages are visible, replace the drive belt.
- ③ More often under severe use such dusty area, sand, snow, wet or muddy conditions.
- ④ Pre-ride inspection item.
- ⑤ Make sure that the spark plug gap is correct.
- ⑥ Every 100 hours, check coolant strength.

Refer to MAINTENANCE AND LUBRICATION section of *Shop Manual* for more details.

MAINTENANCE

While reading this *Operator's Guide*, remember that:

⚠ WARNING

Indicates a potential hazard that could result in serious injury or death.

⚠ WARNING

Unless otherwise specified, engine should not be running for all maintenance procedures.

⚠ WARNING

Should removal of a locking device (e.g. lock tabs, self-locking fasteners, etc.) be required when undergoing disassembly/assembly, always replace with a new one.

The following covers the maintenance items that can be performed by the customer if desired. Other items found in maintenance chart must be performed by an authorized Bombardier ATV dealer.

NOTE: Among other things, this section gives the procedures to replace the liquids. Refer to LIQUIDS for procedures to check levels and refill.

Engine/Transmission

Oil Change and Oil Filter Replacement

Oil and filter are to be replaced at the same time. Oil change should be done with a warm engine.

⚠ WARNING

The engine oil can be very hot. Wait until engine oil is warm.

Ensure vehicle is on a level surface.
Clean the drain plug area.
Remove dipstick.

Place a drain pan under the engine drain plug area.

Unscrew drain plug.

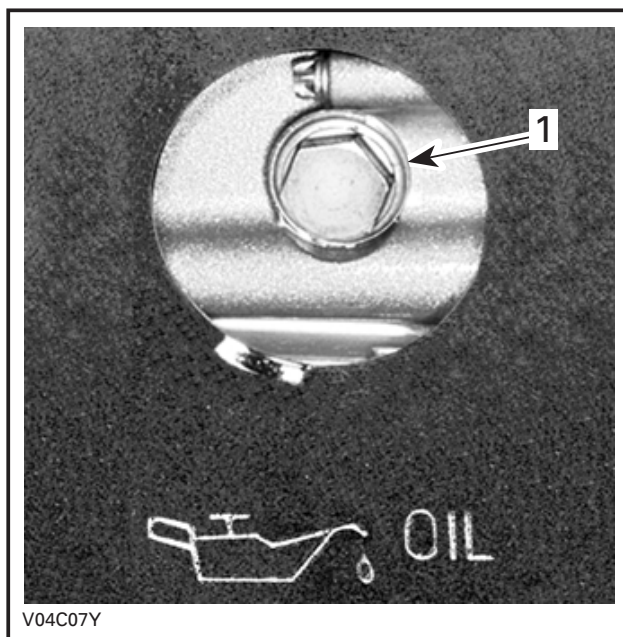

1. Oil drain plug

Allow enough time for oil to flow out of oil filter.

Unscrew the oil filter cover.

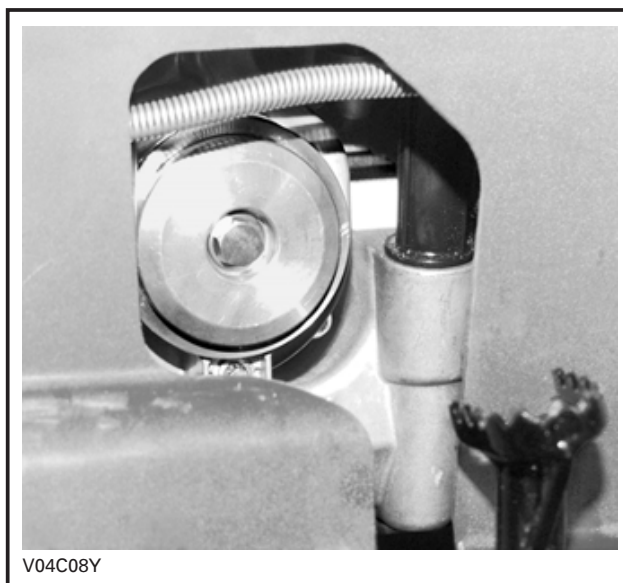

Remove the oil filter and replace with a new filter.

NOTE: Check the cover O-ring and change it if necessary.

Wipe out any oil spillage on engine.

Remove skid plate.

Remove oil strainer cover and oil collector, located near drain plug, then clean oil strainer.

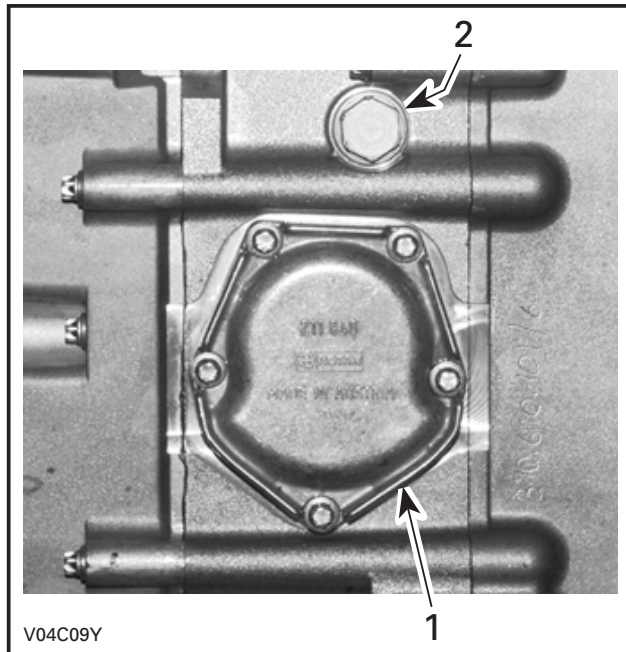

1. Oil strainer cover
2. Oil plug

To clean oil strainer, use a solvent then dry with compressed air.

⚠ WARNING

Always wear eye protection and gloves.

Reinstall oil strainer, oil collector and oil strainer cover.

Change gasket on drain plug. Clean gasket area on engine and drain plug then reinstall plug. Refill engine at the proper level with the recommended oil. Refer to SPECIFICATIONS for capacity.

Start engine and let idle for a few minutes. Ensure oil filter area and drain plug areas are not leaking.

Stop engine. Wait a while to allow oil to flow down to crankcase then check oil level. Refill as necessary.

Dispose of oil as per your local environmental regulations.

Coolant Replacement

⚠ WARNING

To prevent burning yourself, do not remove the radiator cap or loosen the engine drain plug if the engine is hot.

Remove skid plate.

Turn the radiator cap counterclockwise and remove it.

Unscrew the drain plug under oil filter cover and drain the coolant into a suitable container.



1. Cooling drain plug

NOTE: Do not unscrew the drain plug completely.

Unscrew the bleeding screw on the top of thermostat housing.

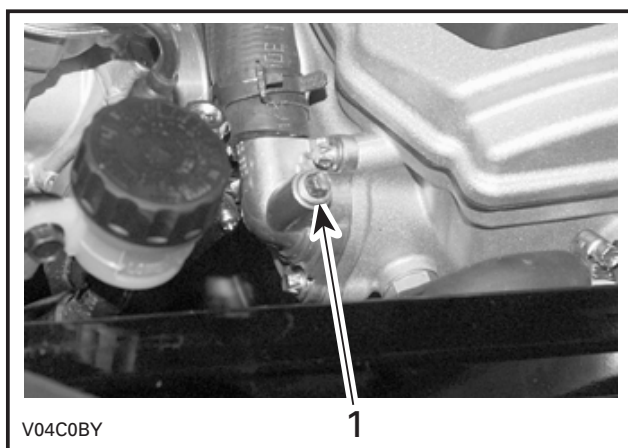

1. Bleeding screw

Drain the system completely and reinstall the drain plug.

Pinch hose between radiator and thermostat housing with a large hose pincher (P/N 529 032 500).

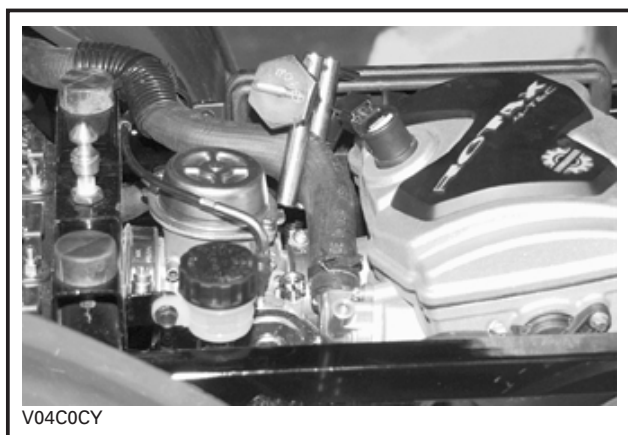

Fill the radiator until the coolant comes out by the thermostat housing hole. Install the bleeding screw then remove the hose pincher.

Complete the radiator filling.

Check the level in the coolant reservoir and refill if necessary.

Run engine at idle with the radiator cap off. Slowly add additional coolant if necessary.

At this point, wait until engine reaches normal operating temperature. Depress the throttle lever two or three times; then add coolant if required.

Install radiator cap. Inspect all connections for leaks and check coolant level in the reservoir.

Valve Adjustment

Valve adjustment is not required on this engine.

Spark Arrester

The muffler must be periodically purged of accumulated carbon.

WARNING

Never run engine in an enclosed area. Never perform this operation immediately after the engine has been run because exhaust system is very hot. Make sure that there are no combustible materials in the area. Wear eye protection and gloves. Never stand behind the vehicle while purging exhaust system. Respect all applicable laws and regulations.

Select a well-ventilated area and make sure the muffler is cool.

Place transmission on PARK position.

Remove the clean-out plug from muffler.

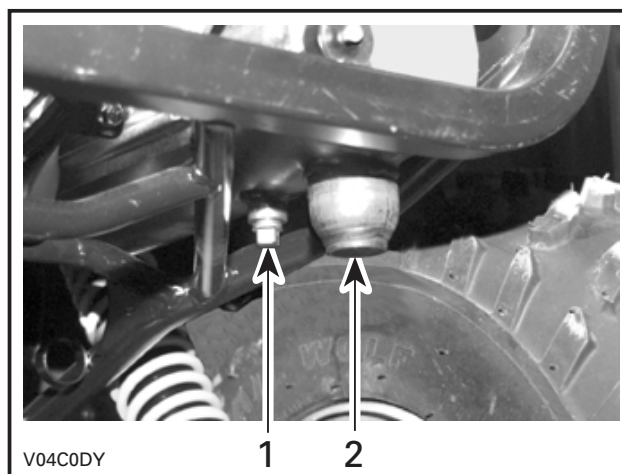

TYPICAL

1. Clean-out plug
2. Muffler

Block the end of muffler with a shop rag and start engine.

Momentarily increase engine RPM several times to purge accumulated carbon out of the muffler.

Stop engine and allow muffler to cool. Reinstall the clean-out plug.

Radiator

Periodically check the radiator area and the air ducts for cleanliness. Ensure air ducts are unobstructed to allow air flow going to the radiator.

An access hole is available to inspect the radiator condition and to give access for cleaning.

Remove seat.

Pull on the circumference of the access plug and remove plug.

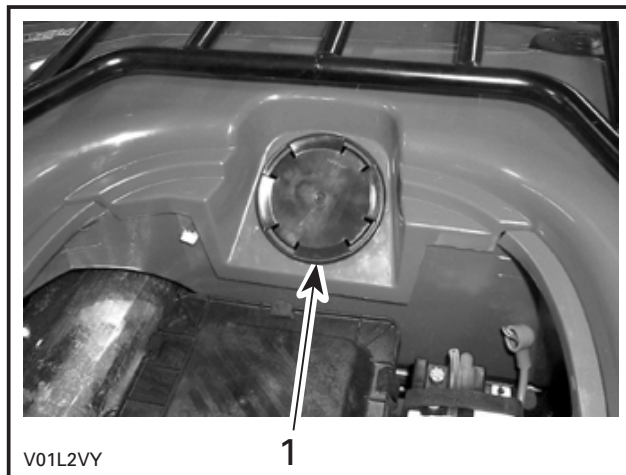

1. Access plug

Inspect radiator fins. They must be clean, free of mud, dirt, leaves and any other deposit that would prevent the radiator to cool properly.

Remove the deposits as much as you can with your hands. If water is available in proximity, try rinsing the radiator fins.

If available, use a garden hose to rinse the radiator fins.

WARNING

Never clean radiator with your hands when it is hot. Let the radiator cool down before cleaning.

CAUTION: Be careful not to damage the radiator fins when cleaning. Do not use any object/tool that could damage the fins. The fins are purposefully thin parts to allow efficient cooling. **WHEN HOSING, USE LOW PRESSURE ONLY.**

Properly reinstall access plug and seat.

Air Intake System

Air Filter Cleaning/Draining

Periodically inspect air filter box drain tube for water or deposits.

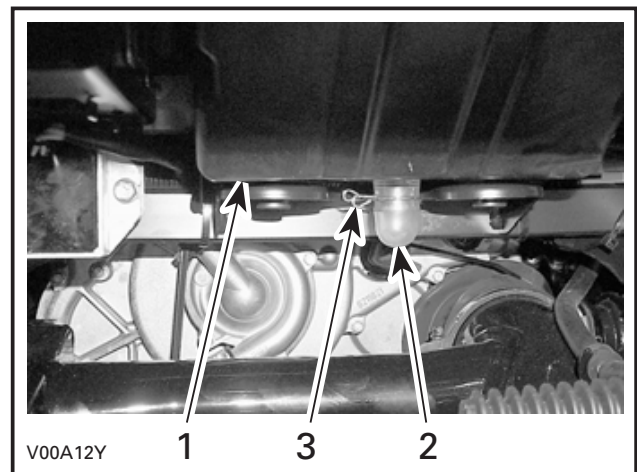

TYPICAL

1. Air filter box
2. Drain tube
3. Clamp

NOTE: If vehicle is used in dusty area, inspect more frequently than specified in MAINTENANCE CHART.

If water/deposits are found, squeeze and remove the clamp. Pull drain tube out.

CAUTION: Do not start engine when water is found in the drain tube.

When water/deposits are found, the air filter must be inspected/dried/replaced depending on its condition.

Remove air filter as explained below.

Air Filter Removal

CAUTION: Never remove or modify any component in the air box. The engine carburetion is calibrated to operate specifically with these components. Otherwise, engine performance degradation or damage can occur.

Remove seat.

Release clamps and remove air filter box cover.

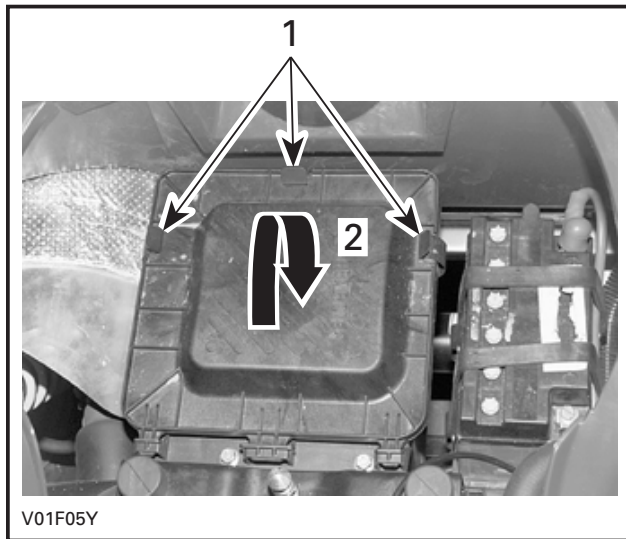

TYPICAL

1. Release clamps
2. Lift to remove

Loosen clamp and remove air filter.

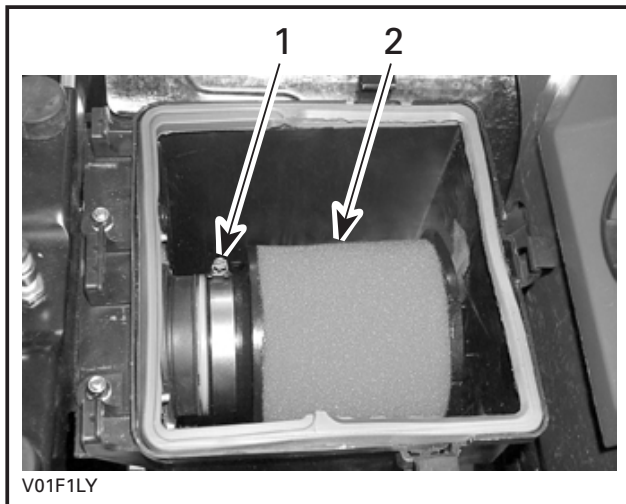

1. Clamp
2. Air filter

Pour cleaning solution into a bucket, dunk the filter multiple times until clean. Rinse with warm water.

NOTE: Products like Simple Green, dish soap or mild solvents can be used to clean the air filter. Simple Green® from Sunshine Makers Inc. is available at hardware stores or at automotive parts retailer.

While filter soaks, clean inside the air box.

Then, let the filter dry completely.

When the filter is dried, re-oil with air filter oil.

Air Filter Installation

Properly reinstall removed parts in the reverse order of their removal.

Electrical

Battery

⚠ WARNING

Never charge a battery while installed in vehicle.

Clean battery post with a wire brush. Apply dielectric grease on post to protect against oxidation.

Fuses

If a fuse is damaged, replace it by one of the same rating.

CAUTION: Do not use a higher rated fuse as this can cause severe damage.

Fuses are located on the RH side of the rear of the vehicle, behind rear bumper.

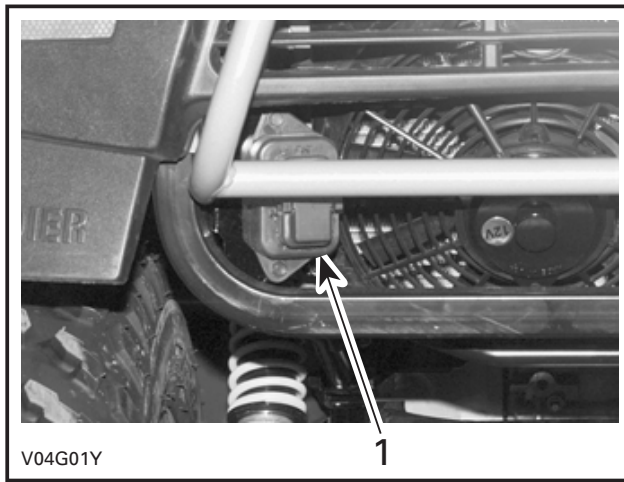

1. Fuse block

Fuses are identified by a number located beside the fuse.



1. Spare
2. Spare
3. Accessories (power outlet and auxiliary supply)
4. Fan
5. Main
6. Charging system

To remove fuse from holder, pull fuse out. Check if filament is melted.

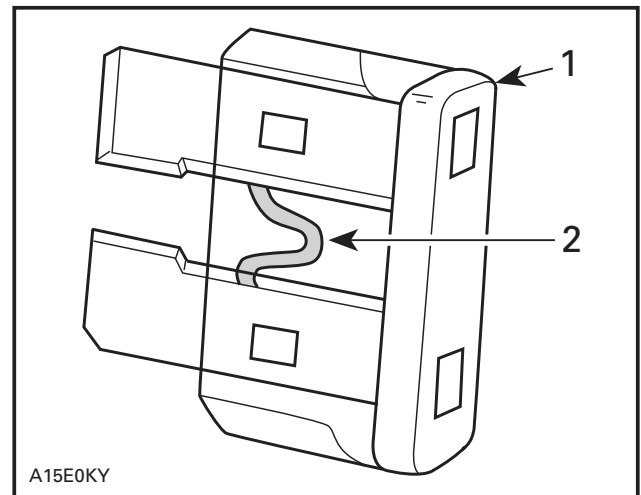

1. Fuse
2. Check if melted

Bulb Replacement

Always check light operation after replacement.

Headlights

CAUTION: Never touch glass portion of an halogen bulb with bare fingers, it shortens its operating life. If glass is touched, clean it with isopropyl alcohol which will not leave a film on the bulb.

Unplug connector from headlight.

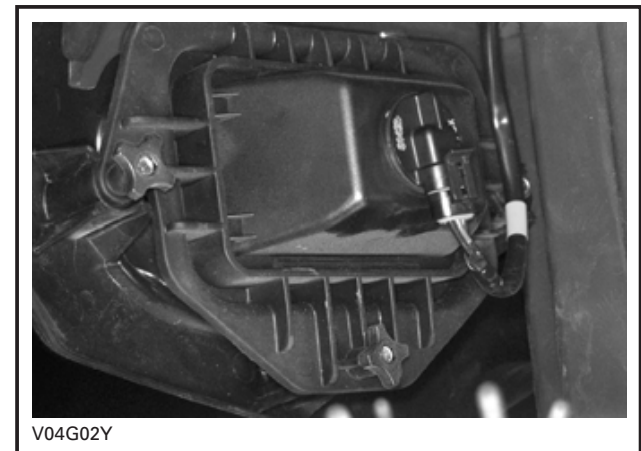

Rotate the bulb socket counterclockwise then remove headlight.

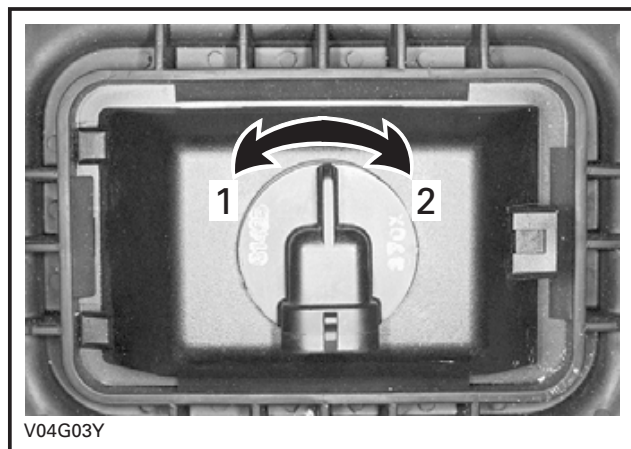

1. Unlock
2. Lock

Properly reinstall removed parts in the reverse order of their removal.

Adjust beam aiming as follows:

Turn knobs to adjust beam height and side orientation to your convenience. Adjust both headlights evenly.

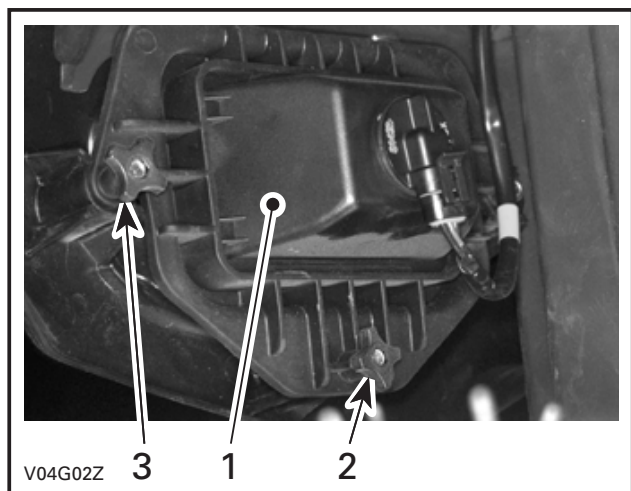

1. Headlight cover
2. Beam height adjustment
3. Beam side adjustment

Taillight Bulb Replacement

Unscrew lens screws to expose bulb. Push bulb in and hold while turning counterclockwise to release.

Install the new bulb by first pushing in while turning clockwise.

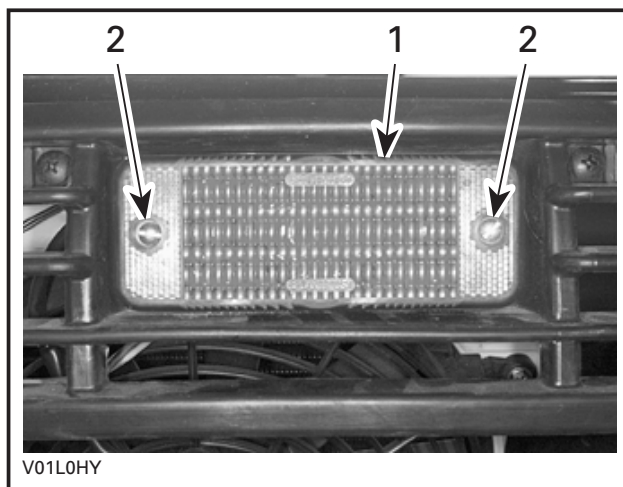

1. Lens
2. Screws

Indicator Light Replacement

If one LED is burnt in the indicator light cluster, see an authorized Bombardier ATV dealer for replacement of the light cluster.

Speedometer Bulbs

Each bulb can be replaced individually. Proceed as follows:

Remove the screw on each side of the steering cover.

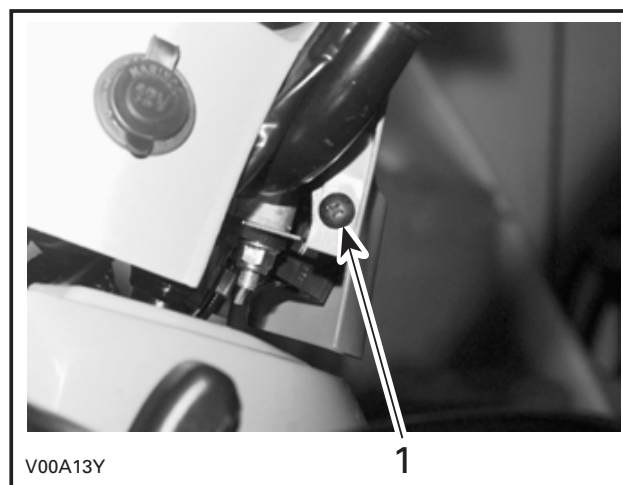

1. One screw on each side

Pull up the steering cover.

Remove the two nuts under speedometer and unplug the connector.

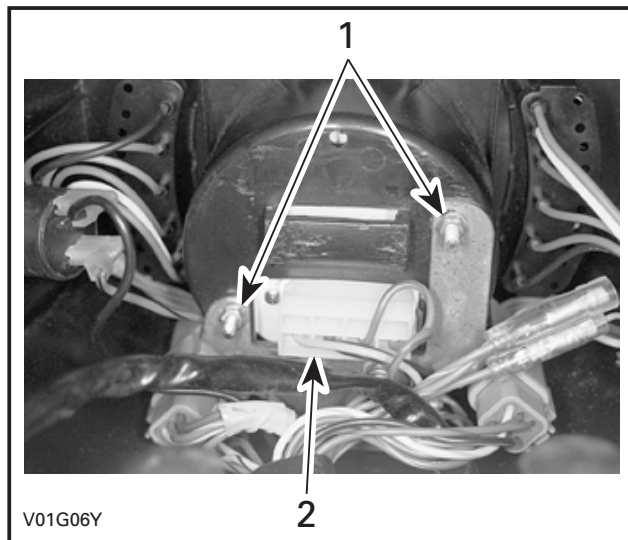

1. Remove the two nuts
2. Unplug the connector

Using a small screwdriver, pry cap out to expose bulb socket.

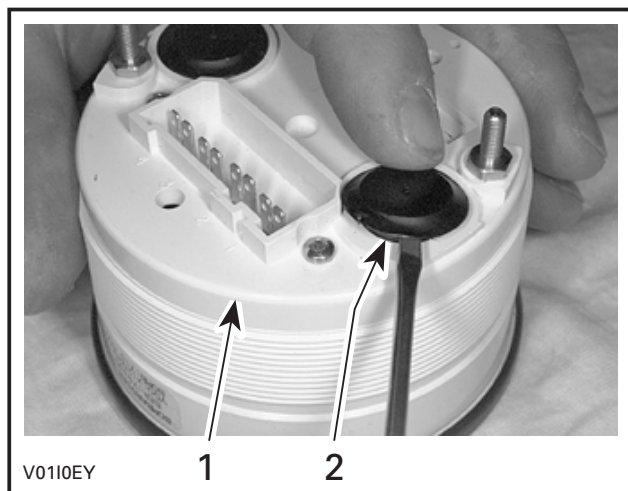

1. Speedometer
2. Pry cap out

Insert a small screwdriver in socket slot and turn counterclockwise until stopped.

Use small long nose pliers to pull bulb out or carefully pry out using a small screwdriver.

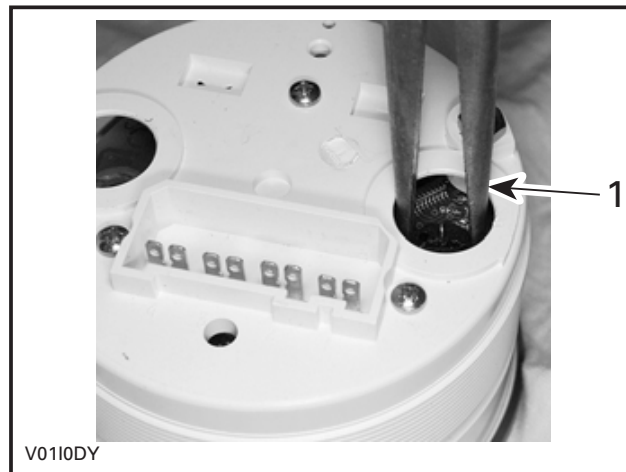

1. Pull bulb out

Reinstall new bulb using long nose pliers. Turn bulb socket clockwise to lock.

Drive Train

Drive Shaft Boot/Protector

Inspection

Visually inspect drive shaft protectors and boot conditions. Check protectors for damage or rubbing against shafts. Check boots for cracks, tears, leaking grease etc. Repair or replace damaged parts as necessary.

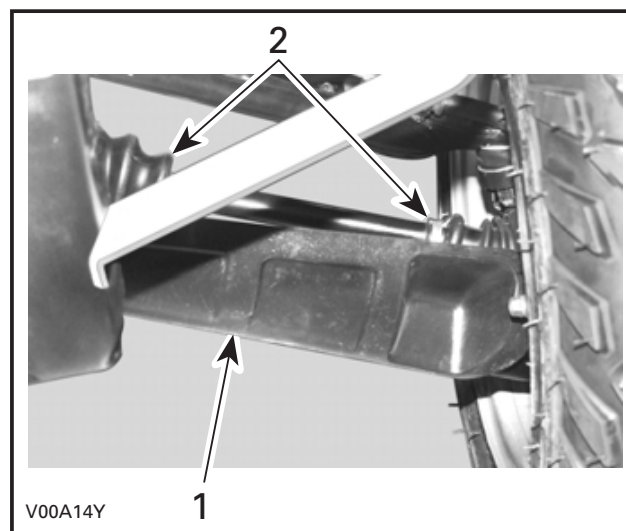

1. Drive shaft protector
2. Drive shaft boots

Wheel

Occasionally, wheel nuts should be removed to apply anti-seize lubricant on studs to ease future removal. This is particularly important when vehicle is used in salt-water environment or in mud. Remove one nut at a time, lubricate then retorque.

Wheel Bearing Condition

Push and pull the wheels from the upper edge to feel the play. See an authorized Bombardier ATV dealer if there is any play.



Tires/Wheels

Tire Pressure

⚠ WARNING

Tire pressure greatly affects vehicle handling and stability. Underpressure may cause tire to deflate and rotate on wheel. Overpressure may burst the tire. Always follow recommended pressure. Since tires are low-pressure types, a manual pump should be used.

Check pressure when tires are “cold” before using the vehicle. Tire pressure changes with temperature and altitude. Recheck pressure if one of these conditions has changed.

For your convenience, a pressure gauge is supplied in tool box.

TIRE PRESSURE		
ALL MODELS		
	FRONT	REAR
RECOMMENDED	38 kPa (5.5 PSI)	31 kPa (4.5 PSI)
MINIMUM	35 kPa (5 PSI)	28 kPa (4 PSI)

Although the tires are specifically designed for off-road use, a flat may still occur. Therefore, it is recommended to carry a tire pump and a repair kit.

Tire/Wheel Condition

Check tire for damage and wear. Replace if necessary.

Do not rotate tires. The front and rear tires have a different size. The tires are directional and their rotation must be kept in a specific direction for proper operation.

Wheel Removal

Loosen nuts then lift vehicle. Place a support under vehicle. Remove nuts then remove wheel.

At installation, it is recommended to apply anti-seize lubricant on threads. Gently tighten nuts in a criss-cross sequence then apply a final torque of 75 N•m (55 lbf•ft).

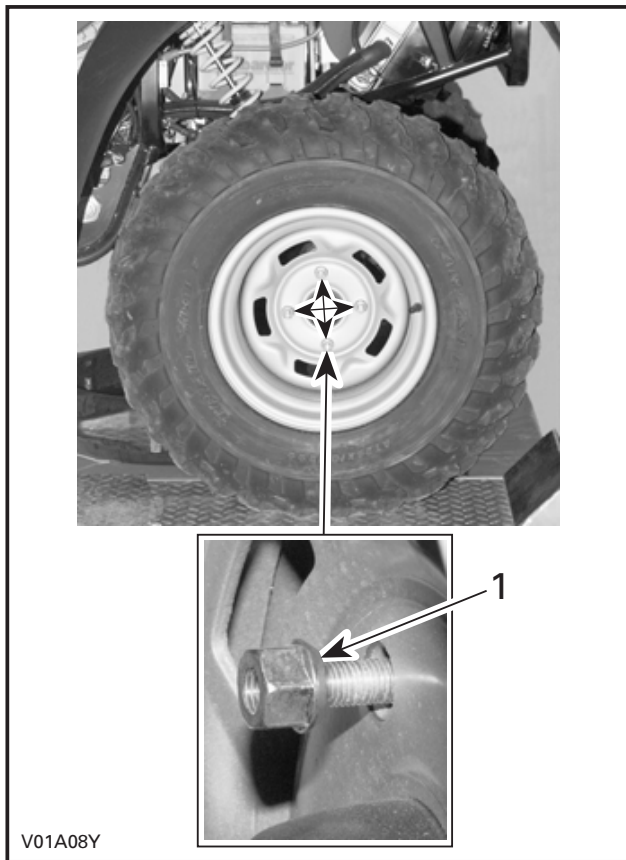

V01A08Y

1. Taper side of nut

Steering/Control Systems

Throttle Cable Lubrication

The throttle cable must be lubricated with Bombardier cable lubricant (P/N 293 600 041) or an equivalent with the same characteristics.

⚠ WARNING

Using another lubricant without same characteristics could cause the throttle lever/cable sticking or stiffness.

Open the throttle lever.

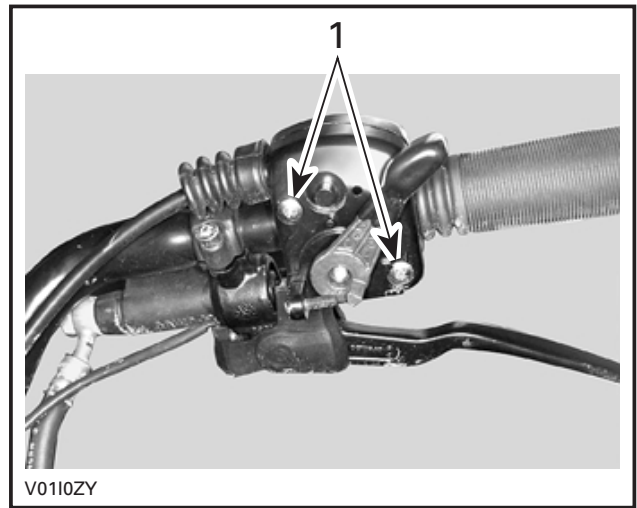

V0110ZY

1. Remove screws

Remove:

- the cable from the throttle lever

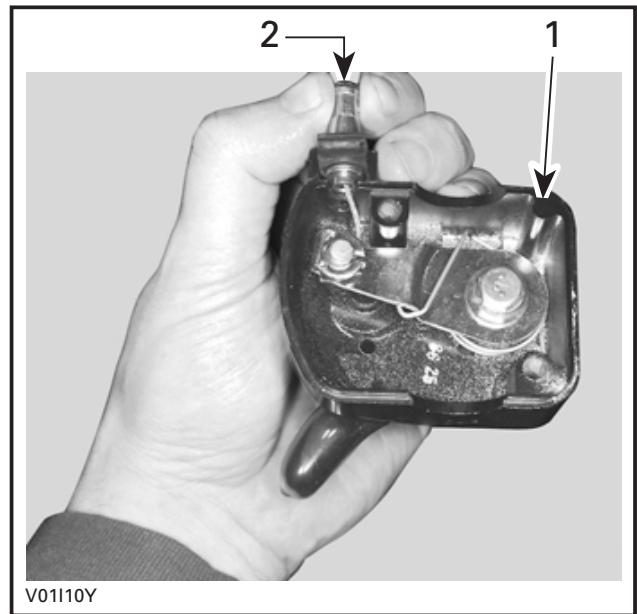

V01110Y

1. Throttle handle housing
2. Throttle cable

NOTE: Slide cable in clip slot and remove the end of cable from clip.

- the seal on the throttle cable.

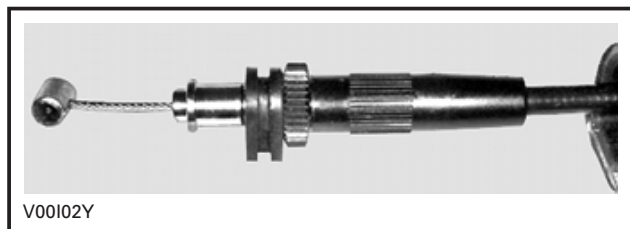

Remove the carburetor side cover.
Install the cable luber (P/N 529 035 738) on the cable.



Insert the needle of lubricant can on the cable luber hole.

⚠ WARNING

Always wear eye protection and gloves when you lubricate a cable.

NOTE: Place a rag around the cable luber to prevent the lubricant splash.

Put the lubricant until it passes through the cable.

Reinstall and adjust the cable.

Throttle Lever Adjustment

Slide rubber protector back to expose throttle cable adjuster.

Loosen lock nut then turn the adjuster to obtain correct throttle lever free play.

NOTE: Measure throttle free play at the tip of throttle lever.

Tighten lock nut and reinstall protector.

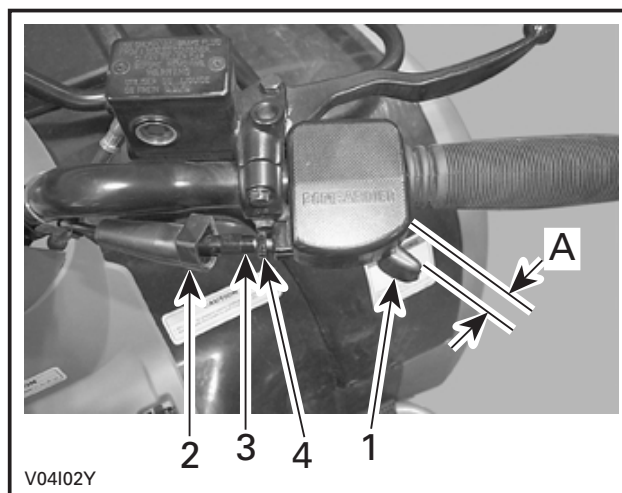

1. Throttle lever
2. Protector
3. Cable adjuster
4. Lock nut
- A. 3 to 6 mm (1/8 to 7/32 in)

Suspension

Lubrication

Lubricate front A-arms. Use synthetic grease (P/N 293 550 010). There is two grease fittings on the upper A-arm and two on the lower A-arm (underneath).

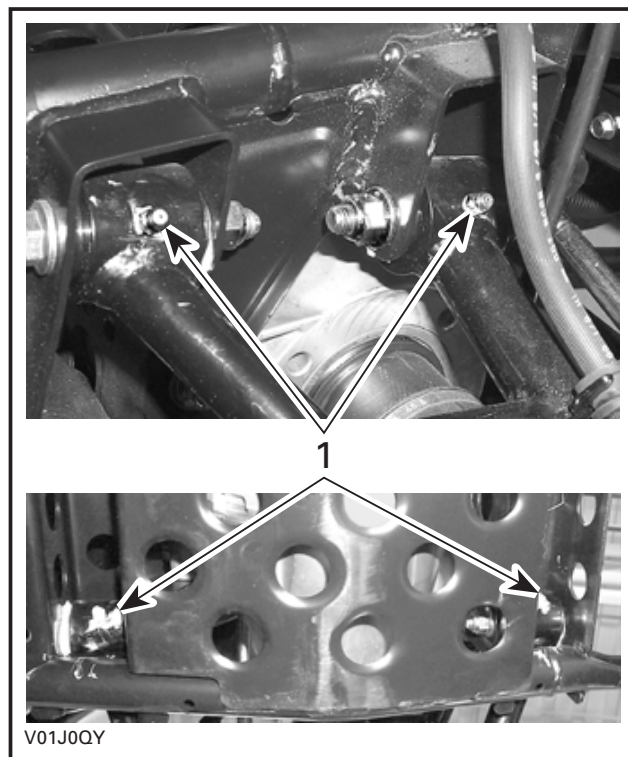

1. Grease fittings

Inspection

Inspect shock absorber for oil leaks and fasteners for tightness. See an authorized Bombardier ATV dealer as necessary.

Adjustment

Rear Shocks

⚠ WARNING

Left and right adjusting cams must always be set at the same position. Never adjust one adjusting cam only. Uneven adjustment can cause poor handling and loss of stability, which could lead to an accident.

Preload Adjustment

Adjust spring preload by turning adjusting cam accordingly with the adjusting wrench in vehicle tool box.

Turn the adjusting cams clockwise for a firmer ride and rough road condition or when carrying cargo or pulling a trailer.

Turn the adjusting cams counterclockwise for a light load and a smooth road condition.

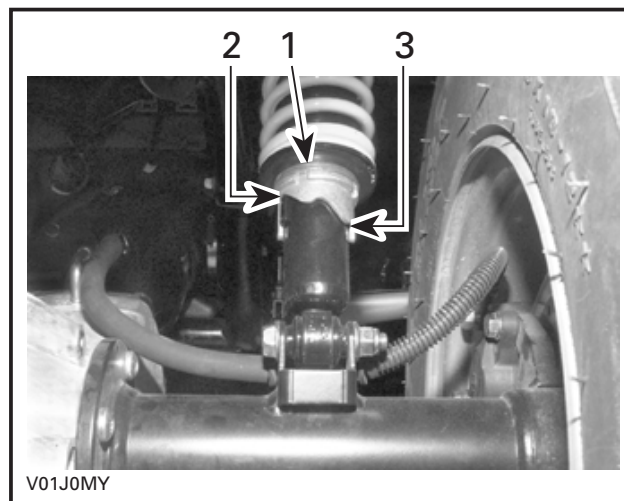

1. Adjusting cams
2. Smooth adjustment
3. Hard adjustment

Brake

Front Brake

The front brakes are hydraulic disc types. These brakes are self-adjusting and require no adjustment.

Rear Brake

The rear brake employs two systems. The first system used a cable, an adjustment is necessary, see an authorized Bombardier ATV dealer. The second system is hydraulic and require no adjustment. The systems are linked together for an higher efficiency.

Brake Cable Lubrication

Remove brake lever and lock (screw, nut and spring).

Remove cable from hand lever. To ease this operation, apply a force on the brake pedal to loosen the cable.

Put the cable luber (P/N 529 035 738) on the cable.

Insert the needle of the spray can in the hole.

Spray a small quantity of silicone lubricant (P/N 293 600 041) then press the brake pedal to move the brake cable. Repeat this procedure until the silicone lubricant exits the other end of the cable.

Body/Frame

Engine Compartment

Check engine compartment for any damage and leaks. Ensure all hose clamps are properly secured and no hose is cracked, kinked or otherwise damaged.

Inspect muffler, battery and reservoir fastening devices.

Check electrical connections for corrosion and tightness.

Replace or have damaged parts repaired.

Skid Plate Condition

Check tightness of fasteners and condition of plate for cracks or other damage. Properly retighten fasteners as necessary and have skid plate replaced if damaged.

Hitch/Trailer Ball Condition

Check tightness of fasteners and tightness/condition of trailer ball. Properly retighten as necessary and replace ball if worn.

Fasteners

Check fastener condition and tightness on the vehicle. Retighten as required.

Seat Latch

Remove seat and check latch mechanism and pin for wear. See an authorized Bombardier ATV dealer for parts replacement if damaged.

Front Storage Compartment Latch

Check latch condition. See an authorized Bombardier ATV dealer for parts replacement if damaged.

Vehicle Cleaning and Protection

Painted parts which are damaged should be properly repainted to prevent rust.

When required, wash the body with hot water and soap (only use mild detergent). Apply non-abrasive wax.

CAUTION: Never clean plastic parts with strong detergent, degreasing agent, paint thinner, acetone, etc.

WHEN HOSING, USE LOW PRESSURE.

CARGO AND TRANSPORTATION

While reading this *Operator's Guide*, remember that:

⚠ WARNING

Indicates a potential hazard that could result in serious injury or death.

Cargo

⚠ WARNING

The vehicle handling, stability and braking distance are affected when loading racks and using the vehicle. Correct loading and weight distribution are therefore important. Never overload, tow or carry cargo improperly. Always ensure the cargo is safely secured and properly distributed on the racks before operating the vehicle. Safely reduce speed according to terrain conditions when carrying cargo or pulling a trailer. Allow greater distance for breaking. Always secure cargo as low as possible on the racks to reduce the effect of a higher center of gravity. Failure to follow the recommendations here could cause changes in vehicle handling which could lead to an accident resulting in severe injuries including the possibility of death. For more information, see the *Safety Handbook*.

When cargoing vehicle, respect these maximum loads.

TOTAL LOAD ALLOWED:
220 kg (485 lb)
(includes driver, all other loads and added accessories)

80 kg (175 lb) Includes rear rack and tongue load	5 kg (11 lb) Console maximal load	40 kg (90 lb) Includes front rack and storage compartment
---	---	---

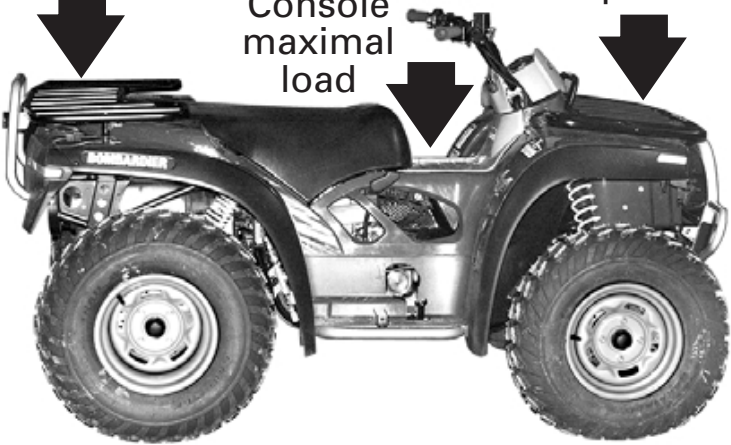

V04A01L

Transportation

When transporting a vehicle, secure vehicle to trailer with suitable tie-downs. Using ordinary ropes is not recommended.

WARNING



V00A174

Never tip this vehicle on end for transporting. We recommend that you carry the vehicle in its normal operating position (on all four wheels).

Place the fuel valve to OFF position.
Select the PARK position and set the parking brake.
Secure the vehicle to front by the front bumper and rear by the frame.

CAUTION: Attaching vehicle at other locations may damage the vehicle.

Front Location

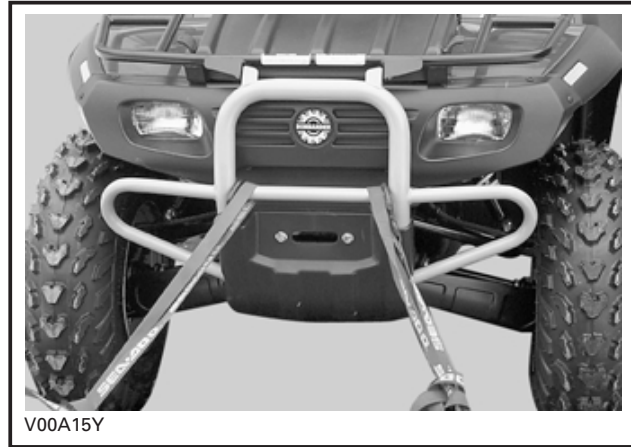

V00A15Y

TYPICAL

Rear Location

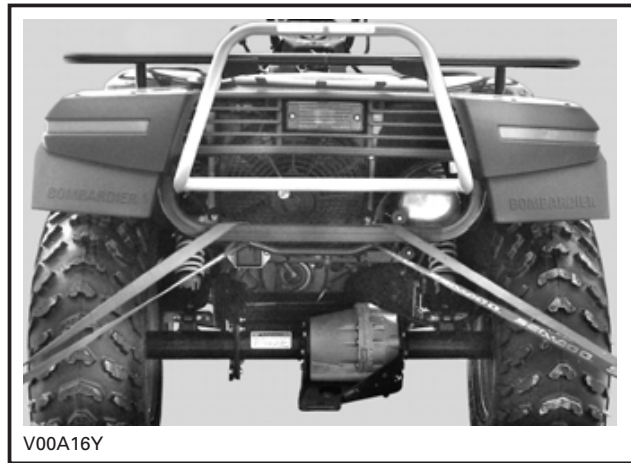

V00A16Y

TYPICAL

WARNING

Do not tow this vehicle behind a car or other vehicle.

TROUBLESHOOTING

SYMPTOM: *Engine does not turn*

POSSIBLE CAUSES	WHAT TO DO
1. Ignition switch is in the OFF position.	Place switch in the ON position.
2. Transmission is not set in the PARK or NEUTRAL.	Set transmission either in PARK or in NEUTRAL or use the override mode.
3. Burnt fuse.	Check main supply fuse.
4. Weak battery or loose connections.	Check charging system fuse. Check connections and terminals condition. Have the battery checked. Contact an authorized Bombardier ATV dealer.

SYMPTOM: *Engine turns over but fails to start*

POSSIBLE CAUSES	WHAT TO DO
1. Burnt fuse.	Check ignition fuse condition.
2. Mixture not rich enough to start cold engine.	Check fuel tank level and check starting procedure, particularly use of the choke.
3. Flooded engine (spark plugs wet when removed).	Refer to SPECIAL PROCEDURES .
4. No fuel to the engine (spark plugs dry when removed).	Check fuel tank level; turn fuel valve to ON (also try on RES). A failure of the fuel pump or carburetor may have occurred. Contact an authorized Bombardier ATV dealer.
5. Spark plug/ignition (no spark).	Check ignition fuse condition. Remove spark plug then reconnect to single-spark ignition coil. Check that ignition switch and/or engine stop switch(es) is/are in the ON position. Start engine with spark plug grounded to engine away from spark plug hole. If no spark appears, replace spark plug. If trouble persists, contact an authorized Bombardier ATV dealer.
6. Engine compression.	As the engine is pulled over with the rewind starter, "cycles" of resistance should be felt as piston goes past top dead center. If no pulsating resistance is felt, it suggests a major loss of compression. Contact an authorized Bombardier ATV dealer.
7. Engine stop switch is in the OFF position.	Place switch in the ON position.

SYMPTOM: <i>Engine lacks acceleration or power</i>	
POSSIBLE CAUSES	WHAT TO DO
1. Fouled or damaged spark plug.	Check item Engine turns over but fails to start.
2. Lack of fuel to engine.	Check item Engine turns over but fails to start.
3. Carburetor adjustments.	Contact an authorized Bombardier ATV dealer.
4. Engine is overheating.	Check Engine Overheat in SPECIAL PROCEDURES . If overheating persists, contact an authorized Bombardier ATV dealer.
5. The LIMP HOME MODE is selected.	Check sensors connectors. Contact an authorized Bombardier ATV dealer.
6. Air box plugged or dirty	Check air filter and clean if necessary. Check the position of the air intake tube.
7. CVT dirty or wear.	Contact an authorized Bombardier ATV dealer.

SYMPTOM: <i>Engine backfire</i>	
POSSIBLE CAUSES	WHAT TO DO
1. Exhaust system leakage.	Contact an authorized Bombardier ATV dealer.
2. Engine is running too hot.	See Engine lacks acceleration or power.
3. Ignition timing is incorrect or there is an ignition system failure.	Contact an authorized Bombardier ATV dealer.
4. Improper carburetor setting.	Contact an authorized Bombardier ATV dealer.

SYMPTOM: <i>Engine misfire</i>	
POSSIBLE CAUSES	WHAT TO DO
1. Fouled/damaged/worn spark plugs.	Clean/verify spark plugs and heat range. Replace as required.
2. Water in fuel.	Drain fuel system and refill with fresh fuel.

SYMPTOM: <i>Vehicle cannot reach full speed</i>	
POSSIBLE CAUSES	WHAT TO DO
1. Engine.	See Engine lacks acceleration or power.
2. Parking brake.	Ensure brake lever lock is completely removed.
3. The LIMP HOME MODE is selected.	Check sensors connectors. Contact an authorized Bombardier ATV dealer.
4. Air box plugged or dirty	Check air filter and clean if necessary. Check the position of the air intake tube.
5. CVT dirty or wear.	Contact an authorized Bombardier ATV dealer.

SYMPTOM: *Transmission lever is hard to move*

POSSIBLE CAUSES	WHAT TO DO
1. Transmission gears are in a position that prevents the transmission lever to work.	Rock the vehicle back and forth to move the gears in the transmission and allow the transmission lever to be set.
2. Engine idle speed is set too high.	Adjust the idle speed. Refer to the specification.
3. CVT dirty or wear.	Contact an authorized Bombardier ATV dealer.

SYMPTOM: *The RPM increases but the vehicle doesn't move*

POSSIBLE CAUSES	WHAT TO DO
1. The transmission is in the P or N position.	Put transmission lever on the HI, LOW or REVERSE position.
2. CVT is defective.	Contact an authorized Bombardier ATV dealer.
3. Water in the CVT housing.	a) Unscrew the drain plug of the CVT cover. b) If the problem persists, contact an authorized Bombardier ATV dealer.

SPECIFICATIONS

VEHICLE MODEL		QUEST 500
ENGINE		
Type	BOMBARDIER-ROTAX 500 4-TEC 4 stroke. Over Head Camshaft (OHC), liquid cooled	
Number of cylinder	Single cylinder	
Number of valve	4 valves with hydraulic lifters (no adjustment)	
Displacement	498 cc (30.4 cu. in)	
Bore	Standard	100 mm (3.9 in)
Stroke	63.4 mm (2-1/2 in)	
Compression ratio	10.5:1	
Lubrication	Wet sump with replaceable oil filter (lubrication of engine and transmission simultaneously)	
Decompressor	Automatic	
Exhaust system	Spark arrester approved U.S. Forest Service (USFD)	
Air filter	2 stage foam filter	
TRANSMISSION		
Transmission	Continuously Variable Transmission (CVT)	
COOLING		
Type	Liquid cooled	
Radiator	Rear mounted with thermostatic fan	
CARBURETION		
Carburetor make and type	Mikuni BSR42. Constant velocity with manual choke and ECS (Enrichner Coasting System)	
Choke plunger position	Variable	
Idle speed	± 100	1100 RPM
Fuel pump make and type	Mikuni, external (vacuum-operated)	

VEHICLE MODEL		QUEST 500
ELECTRICAL		
Magneto generator make and type	Denso, 400 W @ 6000 RPM	
Ignition type	CDI (Capacitor Discharge Ignition)	
Ignition timing	Not adjustable	
Engine RPM limiter	7550 RPM (any gear in forward)	
Vehicle speed limiter	15 km/h (9 MPH) in reverse 105 km/h (65 MPH) forward	
Spark plug make and type	NGK DCPR8E	
Number of spark plug	1	
Spark plug gap	0.7 mm (.027 in)	
Battery	12 V, 19 A (20 A, optional). Electrolyte type battery	
Starting system	Electric start. Start on P, R, N, H or L position (with brake applied)	
Headlight	2 x 30 W	
Taillight	5/27 W	
Pilot lamp cluster	LEDS, 0.7 V approx. (each)	
FUSES		
Location no. 1 (empty)	N.A.	
Location no. 2 (empty)	N.A.	
Location no. 3 (accessories)	15 A (power outlet and auxiliary supply)	
Location no. 4 (fan)	15 A	
Location no. 5 (main)	20 A	
Location no. 6 (charging system)	30 A	
DRIVE TRAIN		
Front differential	Shaft driven/single auto-lock differential (shear pump)	
Rear axle	Shaft driven/solid axle	
SUSPENSION		
Front	Type	Independent suspension — double A-arm
	Travel	178 mm (7 in)
Rear	Type	Rigid swing-arm
	Travel	191 mm (7.5 in)
TIRES		
Pressure	Front	38 kPa (5.5 PSI) recommended, 35 kPa (5 PSI) minimum
	Rear	31 kPa (4.5 PSI) recommended, 28 kPa (4 PSI) minimum
Size	Front	635 OD x 203 W x 305 ID mm (25 x 8 x 12 in)
	Rear	660 OD x 254 W x 305 ID mm (26 x 10 x 12 in)

VEHICLE MODEL		QUEST 500
WHEELS		
Size	Front	305 dia. x 165 W mm (12 in x 6.5 in)
	Rear	305 dia. x 203 W mm (12 in x 8 in)
Wheel nut torque		75 N•m (55 lbf•ft)
BRAKES		
Front		Hydraulic, 2 discs
Rear		Hydraulic, 1 disc
Parking		Park through transmission. LH brake lever includes a lock
LOADING CAPACITY		
Front rack		40 kg (90 lb) includes front storage tray
Rear rack		80 kg (175 lb) includes tongue load
Console		5 kg (11 lb)
Total vehicle load allowed		220 kg (485 lb) includes driver, all other loads and added accessories
GVWR (Gross Vehicle Weight Rating)		540 kg (1200 lb)
Towing capacity		500 kg (1100 lb)
Tongue capacity		14 kg (30 lb) included with rear rack
Front storage tray		10 kg (22 lb) included with front rack
DIMENSIONS		
Dry mass		341 kg (753 lb)
Overall length		2071 mm (81.5 in)
Overall width		1194 mm (47 in)
Overall height		1143 mm (45 in)
Wheel base		1296 mm (51 in)
Wheel track	Front	992 mm (39 in)
	Rear	940 mm (37 in)
Turning radius		2133.6 mm (84 in)
Toe-out adjustment (each side)	Front	8 mm ± 4 mm (5/16 in ± 5/32 in)
	Rear	N.A.
Ground clearance	Front and under engine	244 mm (9.6 in)
	Rear axle	188 mm (7.4 in)
Weight distribution (front/rear)		49/51%

VEHICLE MODEL		QUEST 500
LIQUIDS		
Oil type (engine and transmission)		SAE, 4-stroke mineral-based engine oil. API classification SG, SH or SJ or Bombardier synthetic oil. Do not use synthetic oil or synthetic blend oil, other than Bombardier synthetic oil Refer to OIL VISCOSITY CHART for proper grade
Coolant		Ethylene-glycol/water mix (50% coolant, 50% water). Use coolant specifically designed for aluminum engines
Fuel	Type	Regular unleaded gasoline
	Octane	87 (R + M)/2 or higher
Differential	Front and rear	Synthetic polyolester oil 75W90 (API GL-5)
Hydraulic brake		Brake fluid, DOT 4
Propeller shaft joint grease		Shell, Alvania EP-2 only
CAPACITIES		
Vehicle range		Approximately 10 hours depending on many factors such as temperature, operating conditions and load
Fuel tank		22 L (5.8 U.S. gal) including approximately 4.25 L (1.1 U.S. gal) reserve
Engine/transmission oil		Oil change with filter: 2.5 L (2.65 quarts). Total: 3.25 L (3.43 quarts)
Coolant		2.5 L (2.65 quarts)
Differential	Front	650 mL (22 U.S. oz)
	Rear	200 mL (10 U.S. oz)

OD = outside diameter

ID = inside diameter

dia. = diameter

W = width

OHV = overhead valve

LEDs = light-emitting diodes

Because of our ongoing commitment to product quality and innovation, Bombardier reserves the right, at any time, to make changes in design and specifications and/or to make additions to, or improvements in its products without imposing any obligation upon itself to install them on its products previously manufactured.

SI* METRIC INFORMATION GUIDE

BASE UNITS			
DESCRIPTION	UNIT	SYMBOL	
length	meter	m	
mass	kilogram	kg	
force	newton	N	
liquid	liter	L	
temperature	Celsius	°C	
pressure	kilo pascal.....	kPa	
torque	newton-meter	N•m	
land velocity	kilometer per hour.....	km/h	
PREFIXES			
PREFIX	SYMBOL	MEANING	VALUE
kilo	k	one thousand	1000
centi	c	one hundredth of	0.01
milli.....	m	one thousandth of.....	0.001
micro.....	μ	one millionth of	0.000001
CONVERSION FACTORS			
TO CONVERT	TO ①	MULTIPLY BY	
in	mm.....	25.4	
in	cm	2.54	
in ²	cm ²	6.45	
in ³	cm ³	16.39	
ft	m.....	0.3	
oz	g	28.35	
lb	kg	0.45	
lbf.....	N	4.4	
lbf•in.....	N•m	0.11	
lbf•ft.....	N•m	1.36	
lbf•ft.....	lbf•in.....	12	
PSI	kPa	6.89	
imp. oz	U.S. oz.....	0.96	
imp. oz	mL.....	28.41	
imp. gal	U.S. gal.....	1.2	
imp. gal	L	4.55	
U.S. oz.....	mL.....	29.57	
U.S. gal.....	L	3.79	
MPH.....	km/h	1.61	
Fahrenheit.....	Celsius	(°F - 32) ÷ 1.8	
Celsius	Fahrenheit	(°C x 1.8) + 32	
hp.....	kW.....	.75	

* The international system of units abbreviates SI in all languages.

① To obtain the reverse sequence, divide by the given factor. To convert **millimeters** to **inches**, divide by 25.4.

NOTE: Conversion factors are rounded off to 2 decimals for easier use.

CHANGE OF ADDRESS

If your address has changed, be sure to fill out and mail the card provided on this page.

Such notification is likewise necessary for your own safety even after expiration of the original warranty, since Bombardier Inc. will be in a position to contact you if correction to your ATV becomes necessary.

NOTE: This card is strictly for change of address only.



CHANGE OF ADDRESS

VEHICLE IDENTIFICATION NUMBER

Model Number	Vehicle Identification Number (V.I.N.)

OLD ADDRESS:

NAME

NO. STREET APT

CITY STATE/PROVINCE ZIP/POSTAL CODE

COUNTRY

NEW ADDRESS:

NAME

NO. STREET APT

CITY STATE/PROVINCE ZIP/POSTAL CODE

COUNTRY

STOLEN UNITS

In the event that your ATV is stolen, you should notify your area's distributor warranty department of such.

Please provide your name, address, phone number, vehicle identification number and date it was stolen.

Bombardier will provide a list of stolen units to all ATV dealers on a monthly basis to aid in recovery of such units to their owners.



AFFIX
PROPER
POSTAGE

BOMBARDIER
RECREATIONAL PRODUCTS

WARRANTY DEPARTMENT
75, J.A. BOMBARDIER ST.
SHERBROOKE (QUEBEC)
CANADA J1L 1W3

ATV MODEL No. _____

VEHICLE

IDENTIFICATION NUMBER (V.I.N.) _____

ENGINE

IDENTIFICATION NUMBER (E.I.N.) _____

Owner: _____

NAME

No.

STREET

APT

CITY

STATE/PROVINCE

ZIP/POSTAL CODE

Purchase Date _____

YEAR

MONTH

DAY

Warranty Expiry Date _____

YEAR

MONTH

DAY

To be completed by the dealer at the time of the sale.

DEALER IMPRINT AREA

Please verify with your selling dealer to ensure your ATV has been registered with Bombardier.



BOMBARDIER
RECREATIONAL PRODUCTS

WARNING

THIS VEHICLE CAN BE HAZARDOUS TO OPERATE.

A collision or rollover can occur quickly, even during routine manoeuvres such as turning and driving on hills or over obstacles, if you fail to take proper precautions.

SEVERE INJURY OR DEATH can result if you do not follow these instructions:

- **BEFORE YOU OPERATE THIS ATV, READ THE OPERATOR'S GUIDE, THE SAFETY HANDBOOK AND ALL LABELS.**
- **NEVER OPERATE THIS ATV, WITHOUT PROPER INSTRUCTION.** Beginners should complete a certified training course.
- **NEVER CARRY A PASSENGER.** You increase your risk of losing control if you carry a passenger.
- **NEVER OPERATE THIS ATV ON A PAVED SURFACE.** You increase your risk of losing control if you operate this ATV on pavement.
- **NEVER OPERATE THIS ATV ON PUBLIC ROADS.** You can collide with another vehicle if you operate this ATV on a public road.
- **ALWAYS WEAR AN APPROVED HELMET,** eye protection, and protective clothing.
- **NEVER CONSUME ALCOHOL OR DRUGS** before or while operating this vehicle.
- **NEVER OPERATE THIS ATV AT EXCESSIVE SPEEDS.** You increase your risk of losing control if you operate this ATV at speeds too fast for the terrain, visibility conditions, or your experience.
- **NEVER ATTEMPT WHEELIES, JUMPS, OR OTHER STUNTS.**

®™ TRADEMARKS OF BOMBARDIER INC. OR ITS SUBSIDIARIES.
©2001 BOMBARDIER INC. ALL RIGHTS RESERVED
PRINTED IN CANADA

