

DAELIM

OWNER'S MANUAL

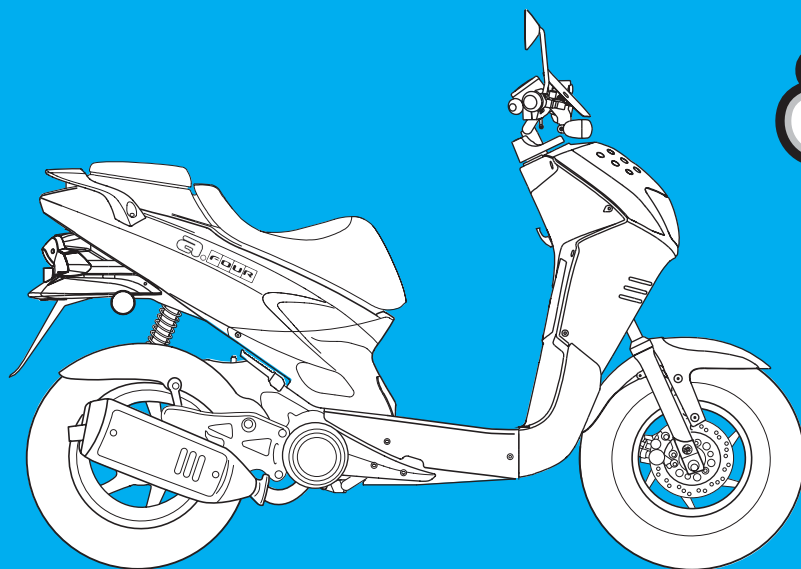

a.FOUR

IMPORTANT NOTICE

- OPERATOR AND PASSENGER

This motorcycle is designed to carry the operator and one passenger.

- ON-ROAD USE

This motorcycle is designed to be used only on the road.

- READ THIS OWNER'S MANUAL CAREFULLY

Pay special attention to statements preceded by the following words:

▲ WARNING

Indicates a strong possibility of severe personal injury or death if instructions are not followed.

▲ CAUTION

Indicates a possibility of personal injury or equipment damage if instructions are not followed.

▲ NOTE

Gives helpful information.

This manual should be considered a permanent part of the motorcycle and should remain with the motorcycle when resold or otherwise transferred to a new owner or operator.

CONTENTS

| | | | |
|--------------------------------------|----|--|----|
| SPECIFICATION | 3 | SEAT LOCK | 15 |
| OPERATION INSTRUCTION | 4 | TRUNK | 15 |
| SAFETY PRECAUTIONS | 4 | DOCUMENT STORAGE AREA | 16 |
| PRIOR TO STARTING VEHICLE | 5 | BAG HOLDER | 16 |
| CORRECT ATTIRE | 5 | BRAKE LOCK LEVER | 17 |
| OPERATION | 6 | CORRECT DRIVING OPERATION | 18 |
| CARGO | 6 | STARTING THE ENGINE | 18 |
| MODIFICATION | 7 | IF ENGINE CANNOT BE STARTED | 20 |
| ATTACHMENT | 7 | AFTER STARTING ENGINE | 20 |
| MUFFLER | 7 | PROPER DRIVING METHODS | 22 |
| PARTS LOCATION | 8 | STOPPING | 23 |
| METER READING AND USAGE | 10 | SELF INSPECTIONS BEFORE OPERATION | 25 |
| METER | 10 | INSPECTION OF CONCERNED AREA | 26 |
| WARNING AND INDICATOR LAMPS | 10 | BRAKE INSPECTION | 26 |
| SWITCH OPERATION | 11 | TIRE INSPECTION | 27 |
| MAIN SWITCH | 11 | FUEL CHECK | 28 |
| STARTER BUTTON | 12 | ENGINE OIL CHECK | 29 |
| HEADLIGHT | 12 | LIGHTS AND WINKER INSPECTION | 29 |
| WINKER SWITCH | 13 | BACK MIRROR INSPECTION | 30 |
| HORN BUTTON | 13 | FUEL LEAK INSPECTION | 30 |
| EQUIPMENT USAGE | 14 | LICENSE PLATE INSPECTION | 30 |
| HANDLE BAR LOCK | 14 | | |
| MAIN STAND LOCK | 14 | | |

| | | | |
|--------------------------------------|----|---|----|
| MAINTENANCE | 30 | SAFE DRIVING | 48 |
| MAINTENANCE SCHEDULE | 31 | PREPARATION BEFORE DRIVING | 48 |
| MAINTENANCE PRECAUTIONS | 33 | DRIVING METHOD | 49 |
| REPLENISHING BRAKE FLUID | 33 | DRIVING POSITION | 49 |
| BRAKE PAD INSPECTION | 34 | TAKING POSE OF FELLOW PASSENGER | 49 |
| BRAKE LEVER ADJUSTMENT | 35 | PRECAUTION WHEN DRIVING | 51 |
| REAR BRAKE SHOE INSPECTION | 35 | STARTING | 52 |
| REPLENISHING ENGINE OIL | 36 | TURNING METHOD | 53 |
| TRANSMISSION OIL INSPECTION | 37 | PRINCIPLE OF TURN | 53 |
| TIRE PRESSURE INSPECTION | 37 | EFFECT OF SPEED | 53 |
| WHEEL REMOVAL | 38 | 3 POSITIONS OF TURNING | 54 |
| SIDE STAND INSFECTION | 39 | TURNING METHOD | 55 |
| SPARK PLUG | 40 | PRECAUTION WHEN TURNING | 56 |
| BATTERY INSPECTION | 41 | BRAKING METHOD | 57 |
| FUSE REPLACEMENT | 42 | BASIC PRINCIPLE OF BRAKE (FRICTION FORCE) | 57 |
| BULB REPLACEMENT | 43 | RESTRAINT OF BRAKE EFFECT (INERTIA) | 57 |
| AIR CLEANER ELEMENT INSPECTION | 45 | BRAKING METHOD | 58 |
| CABLE RUBBER PART INSPECTION | 46 | COMPARISION OF BRAKING DISTANCE | 58 |
| NOTABLES FOR CAR WASHING | 46 | IMPACT WHEN COLLISION | 58 |
| STORAGE GUIDE | 46 | WIRING DIAGRAM | 59 |
| FRAME AND ENGINE NUMBER | 47 | | |

SPECIFICATION

| ITEM | DATA | ITEM | DATA |
|-----------------------------|------------------------|--------------------|---------------------------|
| LENGTH × WIDTH × HEIGHT(mm) | 1,798 × 683 × 1,107 | IGNITION SYSTEM | C.D.I |
| WHEEL BASE(mm) | 1,260 | BATTERY CAPACITY | 12V3AH(MF TYPE) |
| GROUND CLEARANCE(mm) | 115 | FUEL CAPACITY(l) | 6.0 |
| SEAT HEIGHT(mm) | 750 | OIL CAPACITY(l) | 1.2 |
| CURB WEIGHT(kgf) | 92 | TIRE SIZE | FR. 120 / 70 - 12 58L |
| PASSENGER | 2 | | RR. 130 / 70 - 12 62L |
| ENGINE TYPE | AIR COOLED 2 STROKE | SUSPENSION | FR. TELESCOPIC |
| PISTON DISPLACEMENT(cc) | 49.5 | | RR. UNIT SWING OIL DAMPER |
| BORE AND STROKE(mm) | 39.0 × 41.4 | BRAKE TYPE | FR. HYDRAULIC DISK |
| STARTING SYSTEM | START MOTOR / KICK | | RR. DRUM BRAKE |
| TRANSMISSION TYPE | V - MATIC | SPARK PLUG | BR8HSA |
| | | FUSE(A) | 7 |

OPERATION INSTRUCTION

This manual describes matters pertaining to correct operation, safe operation and simple maintenance of the vehicle you purchased.

To ensure more comfortable and safer operation, make sure to read this manual carefully prior to operation.

- The photographs and drawings shown in this manual may differ from those of actual vehicles due to changes in vehicle specifications and modifications made.
- This vehicle is designed for 2 riders including the operator.

CAUTION

- Do not use polluted gasoline.
Otherwise it cause rust inside the fuel tank, and close the supply of fuel to the carburetor, leading to an improper engine starting or may cause serious damage to engine.
- Do use genuine oil then it to protect and extend vehicle life.
- As far as any defect caused by contaminated gasoline or oil, no warranty shall be assured.

SAFETY PRECAUTIONS

- Careful driving and the wearing of proper attire and safety equipment are the most important factors in the safe operation of the scooter. Please obey traffic regulations and do not be hurried and careless.
- Many new vehicle owners operate their newly purchased vehicles with great care and attention to safety factors. However, after becoming accustomed to the operations are often discarded, which can lead to accidents. Please don't let this happen to you and always approach the operation of your vehicle with the safety considerations needed.

When operating the vehicle, always keep in mind and obey the notes of precaution printed on the “Safety Precaution Label” attached to the vehicle.

CAUTION

- Be sure to wear helmet at all time.
- Be sure to put on gloves at all time.
- Observe the speed regulations.
- Beware of muffler after driving as it is still hot to be burnt. Especially never children touch on it.
- For safety, do not change, alteration or modification the vehicle.
- Regularly conduct specified maintenance inspections.
<Maintenance Inspection Points>
Brakes, Tires, Oil, Lights, Horn, Instruments

PRIOR TO STARTING VEHICLE

- Read user's manual carefully.
- Conduct maintenance checks prior to operation.
- Always maintain vehicle in clean status and carry out specified maintenance checks.
- Make sure to stop engine and stay away from fire when fueling.
- Exhaust gas contains harmful substance such as carbon monoxide. Start engine in well-ventilated places.

CORREC ATTIRE

- Be sure to wear helmet and gloves at all time for seafy.
- Wear shirts or jackets with tight one while driving. Otherwise it can be caught in the wheel to cause serious damage by overturn of vehicle.
- Many automobile / motorcycle accidents happen because the automobile driver does not “Look” the motorcyclist.
 - Wear bright or reflective clothing.
 - Don't ride in another motorist's “blind spot”.
- Be sure to wear dress to catch an eye to avoid any crash from behind.

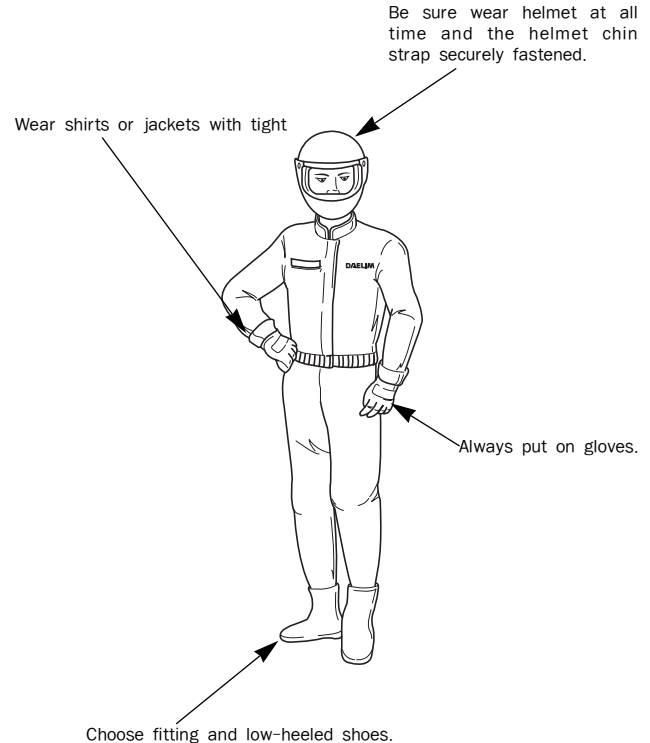

OPERATION

- Operators should naturally fix bodies to keep smooth driving.
- The driving position is most important thing to driving safely. Please always maintain the center of your body in the middle of seat.
- Passengers should firmly fix bodies using both hands and put both feet on floor panel.
- When wanting to turn, slightly lean to body toward the direction of the turn. It is unsafe if the body is not moved in union with the vehicle.
- Curvy roads and poor, unpaved roads constantly change in surface quality. Driving on these roads can be unsafe if certain safety precautions are not followed.
- In order to safely drive through these driving conditions, anticipate coming road conditions, slow down to at least half the normal speed, and relax your shoulders and wrists while securely holding the handles.
- Driving with one or both hands not holding the handles cause severe injury or death of the driver resulted from turnover of vehicle.

CARGO

- When carrying goods, you must keep in mind that operating the vehicle, especially when turning, will be different.
- Make sure not to overload the vehicle with goods as this can make the vehicle unstable during operation.

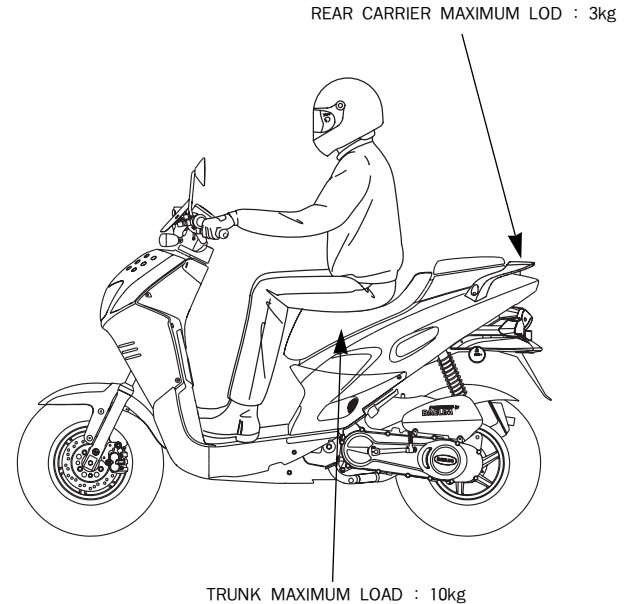

CAUTION

- Pay attention not to overload goods and fasten it tightly while driving.
- Do not place articles between the frame body cover and engine as it is hot to be burnt.
- Do not place kind of cloth materials nearby oil tank cap. If the hole in oil tank cap is clogged, oil will not flow freely into the engine which can cause severely engine damage.
- Do not attach large or heavy items (such as a sleeping bag or tent) to the handle bars, fork, or fender. Unstable handling or slow steering response may result.

MODIFICATION

- Modification of vehicle structure or function deteriorates manipulability or causes exhaust noise to become louder shortening the vehicle life. These modifications are not only prohibited by law but also are the acts harmful to other people.

CAUTION

- Modifications no warranty shall be assured.

ATTACHMENT

- Except designated attachment by DAELIM MOTOR CO., LTD., don't attach any extra lighting device, otherwise it cause premature discharging of battery.
- Carefully inspect the accessory to make sure it does not obscure any lights, reduce ground clearance and banking angle, or limit suspension travel, steering travel or control operation.
- Do not add electrical equipment that will exceed the motorcycle's electrical system capacity. A blown fuse could cause a dangerous loss of lights or engine power.
- This motorcycle was not designed to pull a sidecar or trailer. Handling may be seriously impaired if so equipped.

MUFFLER

- Pay particular attention to fellow passenger so that he/she can prevent getting burnt by the hot muffler during travel.

CAUTION

- Beware of muffler after driving as it is still hot to be burnt. Especially never children touch on it. And pay attention to park where pedestrian zone.
- If haystack or vinyl is stuck to the muffler, it might be fired.

PARTS LOCATION

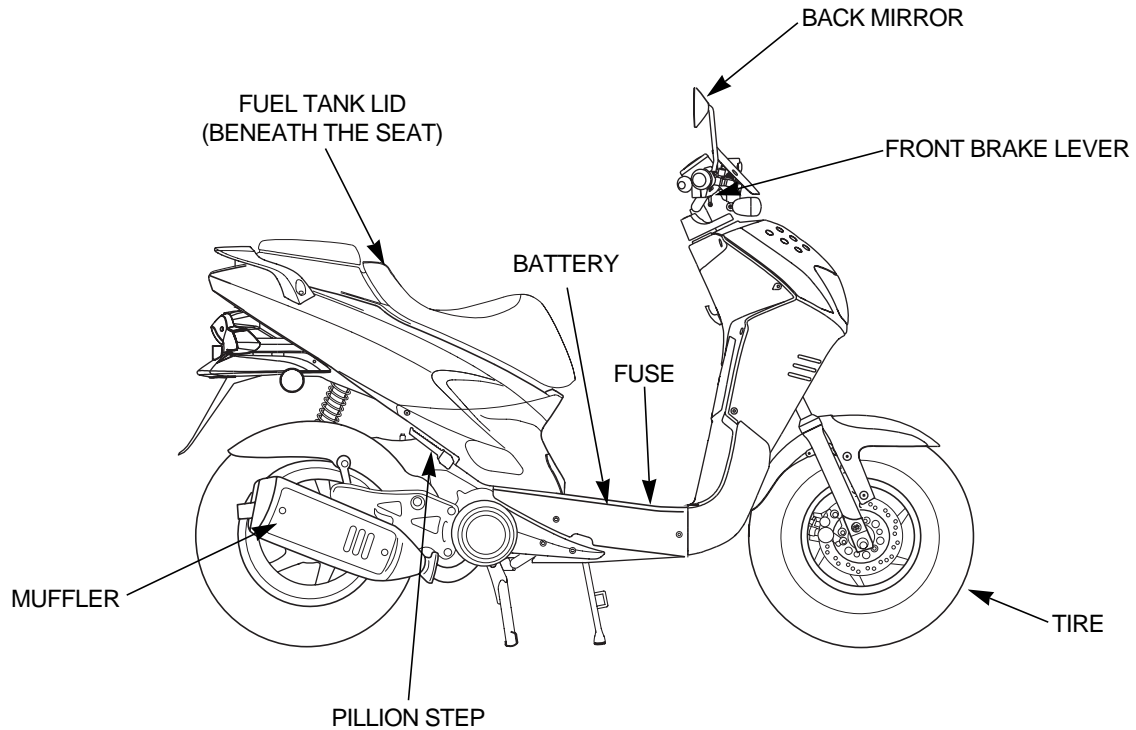

PARTS LOCATION

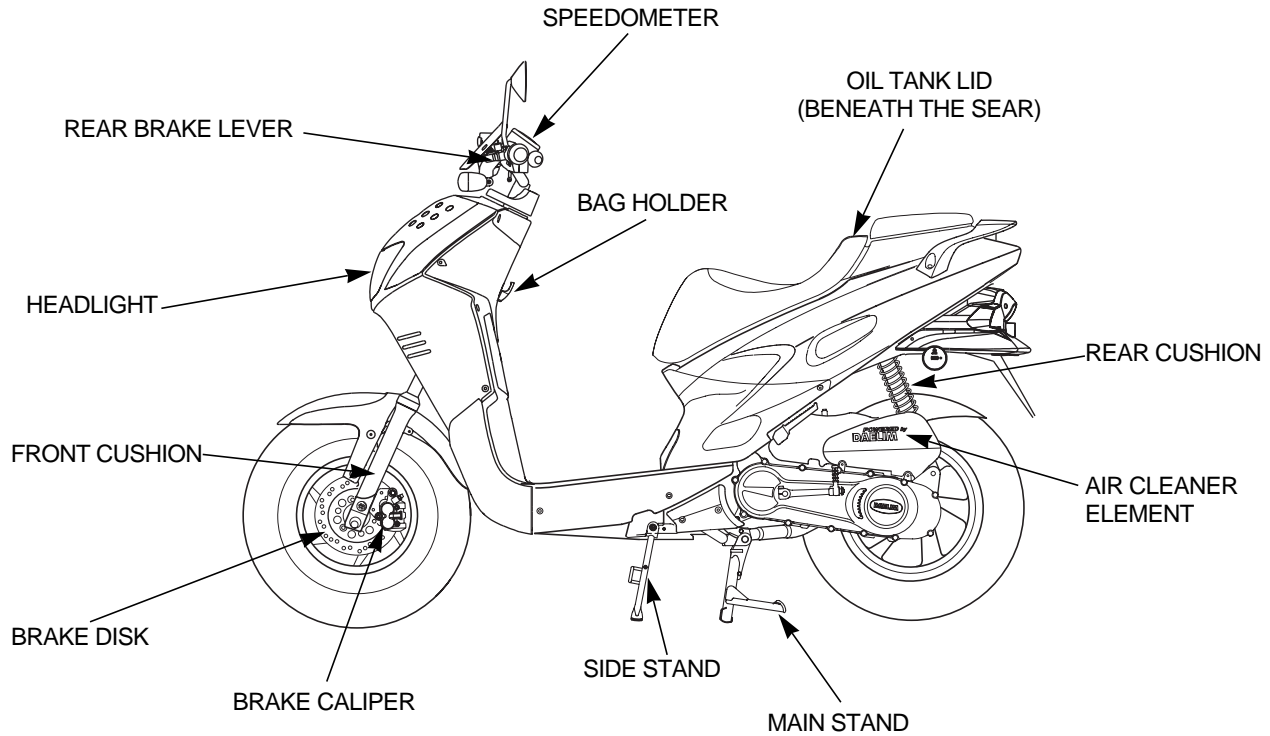

METER READING AND USAGE

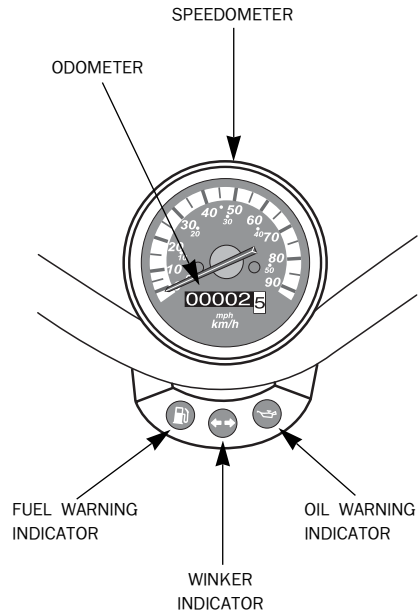

METER

<SPEEDOMETER>

Indicates driving speed. Maintain legal speed limits to ensure safe operation.

<ODOMETER>

Indicates total distance in kilometers travelled by the vehicle.

WARNING AND INDICATOR LAMP

<FUEL WARNING INDICATOR>

When fuel in the fuel tank is low, the fuel warning indicator turns on.

When this happens, fill the fuel tank with the gasoline. When the fuel warning indicator turns on, roughly 1.1 liters of gasoline can be put in the vehicle to fill tank.

WARNING

- To avoid running out of fuel which might cause severe injury due to a engine abruptly stop.

INDICATOR LAMPS

<OIL WARNING INDICATOR>

When oil in the oil tank is low, the oil warning indicator turns on. When this happens, fill the oil tank with pure oil.

CAUTION

- If the oil warning indicator turns on after the main switch is placed to an “ON” position, quickly fill the oil tank using pure oil

<WINKER INDICATOR>

If the winker switch is operated, the winker indicator flashes in union with the flashing of the turn signals.

SWITCH OPERATION

MAIN SWITCH

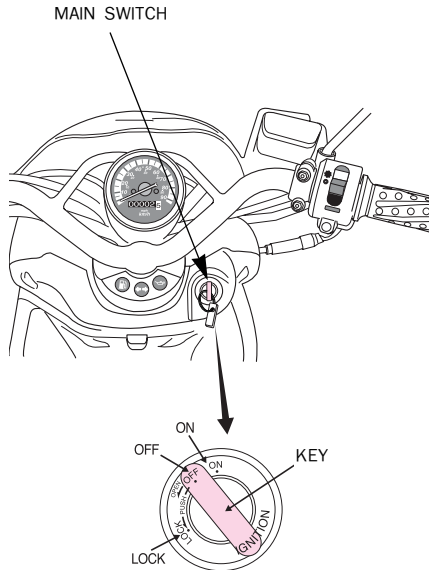

1. ON.... Starts engine. Key can not be pulled out.
2. OFF....Stops engine. Key can be placed in or taken out of the main switch.
3. LOCK....Locks handle bars. Key can be placed in or taken out of the main switch.
4. OPEN....When seat lock is released, key returns to its original position (OFF). Key can be placed in or taken out of the main switch.

CAUTION

- Do not operate main switch key whiling driving.
- If the main switch key is placed on “Off” or “Lock” position, all electrical system will not function.
- Never operate the main switch key during travel as it might cause unexpected accidents.
- If it is necessary to remove the main switch key, stop the vehicle first prior to removing.

CAUTION

- When you park the vehicle and leave it, please lock handle bars and take out the key.
- If the key is left in “ON” position without starting engine, battery is discharged.
- Rotate key smoothly without pressing to turn to OPEN.
- Do not use a number of keys together with a metal key holder. The keys and the key holder may cause scratches or other damage to the cover while operating the vehicle. (Recommend cloth or leather key holders)

START BUTTON

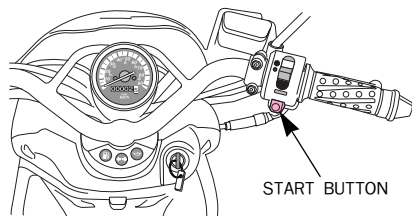

The engine is started pressing this button when pressed in a state where the main switch key is placed to an ON position and the brake lever is pulled.

⚠ CAUTION



- The engine will not start if the brake lever is not grab.
- Do not hold the brake lever and pull the throttle grip when the engine was started. It may damage the engine.

HEADLIGHT

<TURNING ON HEADLIGHT>

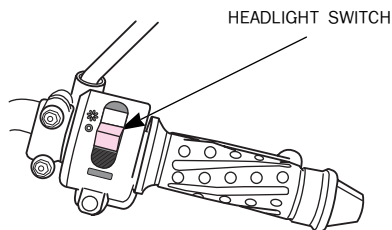
Put main switch key in "ON" position and turn on headlight switch.



| SWITCH POSITION | FUNCTION |
|---|--|
|  (H) | Headlight, taillight, position lamp and meter lights on. |
|  (P) | Position lamp, taillight, and meter lights on. |
| ○ (OFF) | Light turned off. |

<HEADLIGHT HIGH/LOW BEAM SWITCH>

High beam or low beam can be operated by the use of high/low beam switch.

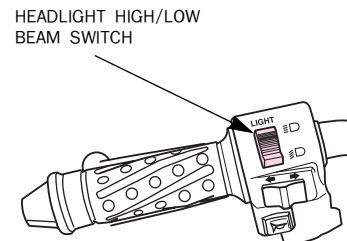

HIGH BEAM

 used when needing extra light.

LOW BEAM

 used when other vehicles are present, in the city, etc.

▲ CAUTION

- Use the high beam only in the suburban road or when the usage of the high beam not hinder the safe driving of the car ahead.

WINKER SWITCH

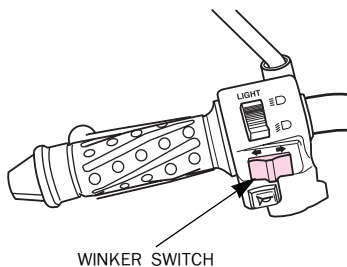

If this switch is turned on when the main switch is in an ON position, the winker will operate.

⇒ (R)...used when making a right turn.

⇐ (L)...used when making a left turn.

HORN BUTTON

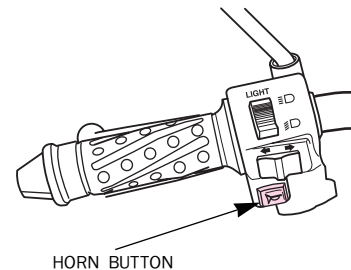

The horn is sounded if the horn button is pressed when the main switch is in an ON position.

▲ CAUTION

- The winker switch does not automatically turn back to its original position after completing the turn. Please set the switch back to its center position after turning.

EQUIPMENT USAGE

HANDLE BAR LOCK

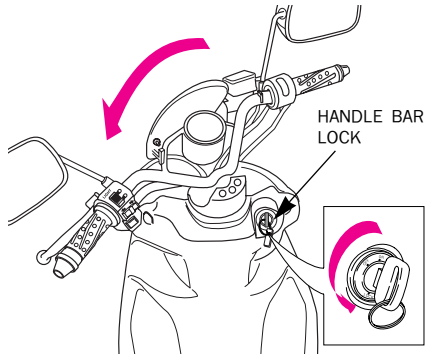

CAUTION

- Check to the handle bars securely locked by lightly moving to the left and right.
- Pay attention not obstruct traffic when the parking.

MAIN STAND LOCK

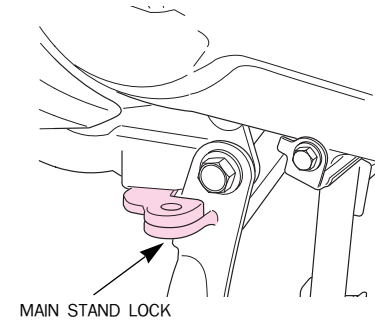

<LOCKING>

To lock the steering, turn the handlebars all the way to the left, turn the key to LOCK while pushing in. Remove the key.

<UNLOCKING>

To unlock the steering, turn the key to the OFF position.

It can be locked up in the main stand using the supplementary device(key, wire) for buglarproofing.

SEAT LOCK

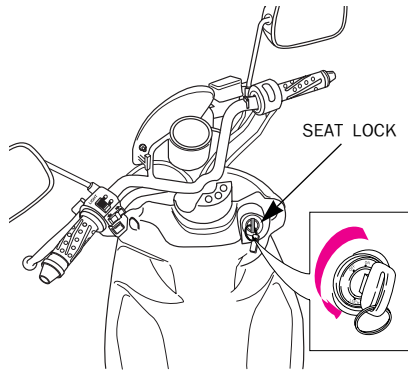

<LOCKING>

- The seat automatically locks when the seat is pushed in its downward position,
- Lightly pull upward on the seat to make sure the seat has been properly locked.

<UNLOCKING>

- Turn the main switch key from OFF to OPEN to open the seat.

⚠ CAUTION

- As the seat automatically locks, take special care not to accidentally leave the key in the trunk.
- Make sure that the seat is securely locked after closing the seat. Driving with unlocked seat lock may cause danger.
- When the seat lock is out of order, do not operate it further and inspect it in the closest authorized repair center.

TRUNK

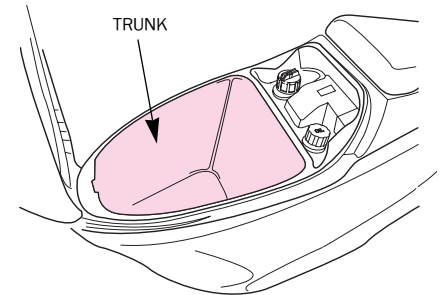

- There is a trunk under the seat.
- The seat is opened to gain access to the trunk by using the main switch key on the seat lock.

TRUNK MAXIMUM LOAD:10kg

DOCUMENT STORAGE AREA

⚠ CAUTION

- Make sure that the seat is securely locked after closing the seat.
- An unlocked seat can hinder the operation of the vehicle.
- The temperature inside the trunk rises due to heat from the engine. Do not place foodstuffs and other articles that can be damaged easily by heat. Also do not place flamm-able materials in the trunk.
- Do not place valuable or fragile goods in trunk.
- As water can enter the trunk when washing, make sure to remove articles that can be damaged by water.

DOCUMENT STORAGE AREA

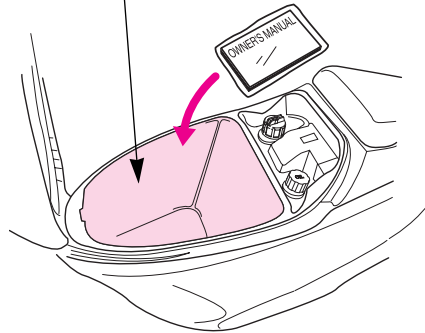

There is a document storage area on the bottom of the seat. Store the owner's manual and the maintenance notebook in this area.

BAG HOLDER

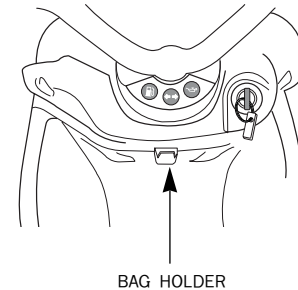

- For ease in carrying bags and similar items, they should be hung from the bag holder which is fitted for this purpose.

⚠ CAUTION

- Do not attempt to carry very heavy or bulky loads since this would affect the stability and steering characteristics of the scooter.

BRAKE LOCK LEVER

BRAKE LOCK LEVER

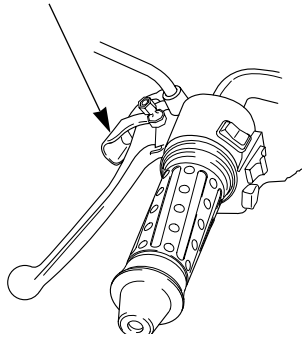

⚠ CAUTION

- If the rear brake is not adjusted properly, it will not be able to lock. Please refer to page 35 for instructions on rear brake adjustment.

<SETTING>

- ① Squeeze tightly on the rear brake lever.
- ② Move the brake lock lever in the direction of the arrow in the drawing and place it in the groove of the brake lever.
- ③ Release your hand from the rear brake lever and the rear wheel will be locked.

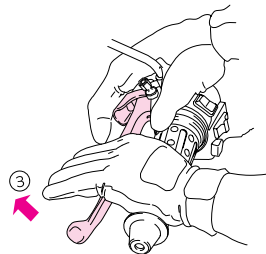
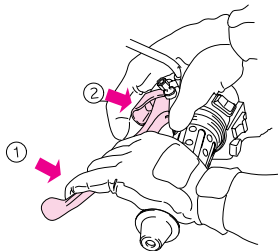

<RELEASING>

- ① Squeeze tightly on the rear brake lever and the lock lever will be automatically released.
- ② Release your hand from the rear brake lever and the rear wheel will be unlocked.

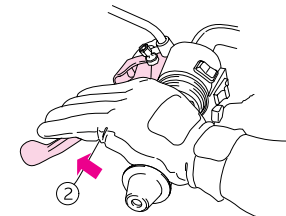
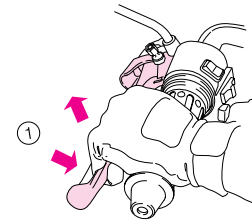

CORRECT DRIVING OPERATION

- Be sure to check the oil, gasoline, etc., before starting the engine.
- Please keep in mind that the main stand is erect while engine started.

⚠ CAUTION

- Make sure that the rear wheel is locked when engine started to prevent an unexpected quick start of the vehicle.
- Locking is not made if the rear wheel brake is not adjusted correctly.
- Pay attention the hand or any part of the body not to contact with the rear wheel when accelerating the vehicle with the main stand erected.
- If the rear wheel put on ground when accelerating the vehicle with main stand erected, the vehicle can go forward abruptly resulting in injury of the driver.

- Drive with care for safety and considering vehicle life.
- For 1 month (or 1,000km) after purchasing the vehicle, drive shall avoid fast start and acceleration.

STARTING THE ENGINE

Always follow the proper starting procedure described below.

- This motorcycle is equipped with a side stand ignition cut-off system.
- The engine cannot be started if the side stand is down.

⚠ WARNING

- Never run the engine in an closed area. The exhaust contains poisonous carbon monoxide gas that can cause loss of consciousness and lead to death.

- 1 Lock the rear wheel.(see p. 17)
- 2 Turn the main switch to an ON position.

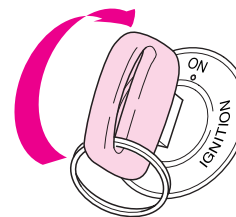

⚠ CAUTION

- If the oil warning indicator turns on after the main switch is “ON” position, quickly refill the oil tank using pure oil. Due to engine premature worn or seized.

- 3 Start engine with cell or kick.

<USING THE ELECTRIC START(CELL)>

- Press the starter button without rotating the starter grip (opening the throttle).

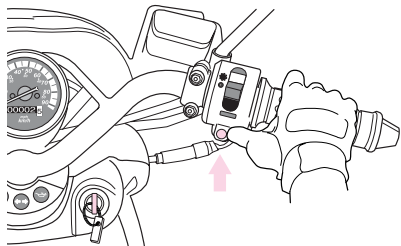

⚠ CAUTION

- Immediately release the starter button as soon as the vehicle has started.
 - Do not press the starter button when the engine is running.
This can damage the starter motor.
- If the engine is hot and does not start after pressing the starter button for 3~4 seconds, rotate the throttle grip to 1/8~1/4 of a rotation and try again. This will allow easy starting

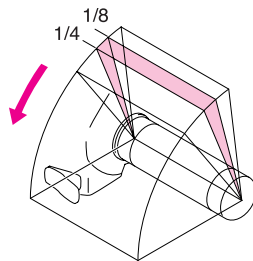

- It is possible that starting will be more difficult if the vehicle has not been used for a long period of time or if the fuel hole is plugged up(starting problems even when there is sufficient fuel in the fuel tank may be an indication of a plugged fuel hole).
When this happens, do not rotate the throttle grip and try the starter button a few times.

⚠ CAUTION

- Do not keep the starter button pressed for more than 5 seconds at a time. Release the starter button for around 10 seconds before pressing it again.

<WITHOUT ELECTRIC START(KICK)>

- Erect main stand and then step kick starter pedal strongly.

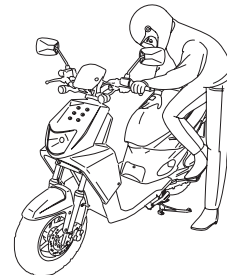

⚠ CAUTION

- Be sure to place kick starter on its original position after the engine started.
- Be sure to erect main stand and side stand when starting.
- Do not use the starter button and the kick-starter pedal simultaneously.
- When starting with the kick starter, it is not necessary to grab the front and rear brakes.

- 4 When the engine is cold morning or winter or the vehicle has not been used for a long period of time, let the engine idle for a short period allow the engine to warm up.

▲ CAUTION

- Keep holding rear brake until start.
- Exhaust has contains harmful substance such as carbon monoxide. Start engine in well-ventilated places.

IF ENGINE CANNOT BE STARTED

If engine cannot be started or vehicle does not move, check the followings.

- Is there fuel in fuel tank?
- Are you operating in accordance with the instructions given in owner's manual?
- Is fuse not cut?
- Is starter motor running?
- If starter motor is not running due to battery consumption, try starting motor by using kick start technique.

AFTER STARTING ENGINE

- 1 Fold the main stand.
- Push the vehicle forward to fold the main stand and make sure that the brake lever does not become released during this operation.

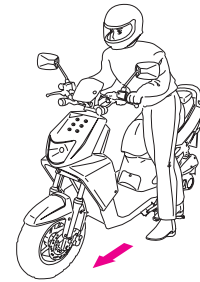

▲ CAUTION

- Do not excessively open the throttle until you actually start the driving operation of the vehicle.

2 Get on the vehicle.

- Mounting should be done from the left side, and you should sit squarely on the seat. Leave either one foot or both feet planted on the ground

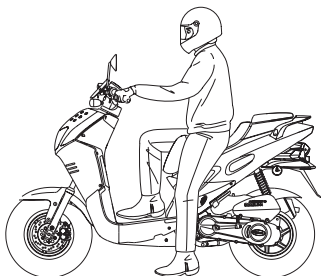

CAUTION

- Keep hold brake lever when starting.

3 Squeeze tightly on the rear brake lever and the lock lever will be automatically released.

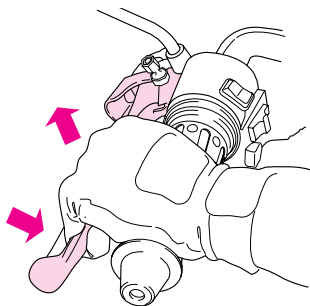

CAUTION

- Do not rapidly the throttle grip turn while releasing the rear brake lock then vehicle that may spring out causing severe injury.

4 Release the squeezing tension on the rear brake lever and slowly begin to rotate the throttle grip to allow for a slow and easy start.

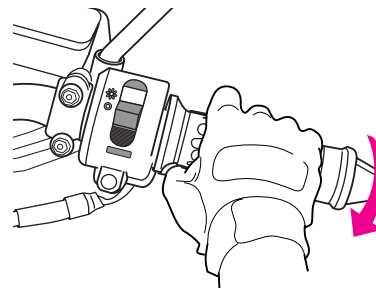

CAUTION

- A quick rotating of throttle grip will cause the vehicle to move forward abruptly.
- If the engine RPM will not turn down after throttle grip return to original position, stop operating and inspect it registered repair center nearby.

PROPER DRIVING METHODS

- Before entering traffic, use the correct turn signal to forward other drivers of your intentions.

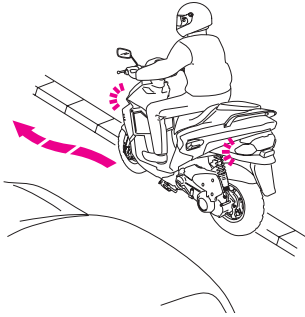

Speed is controlled by the operation of the throttle grip.

- If the throttle grip is rotated.....
The speed of the vehicle increases. Please rotate the throttle grip slowly. When climbing a hill, the throttle grip need to be rotated further to give the vehicle more power.
- If the throttle grip is allowed to rotate back.....
Speed decreases. This can be done slowly or quickly, depending on how quickly you need to decelerate.

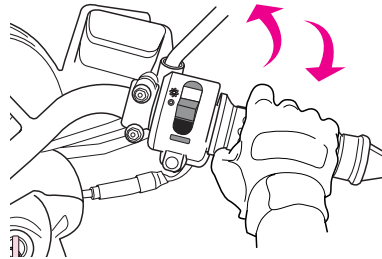

Work the front and rear brakes together.

- Allow the throttle grip to rotate back to its beginning position and then squeeze the brake levers.
- If is best to operate the brakes by first lightly squeezing the brake levers and then changing to a more firm squeeze.

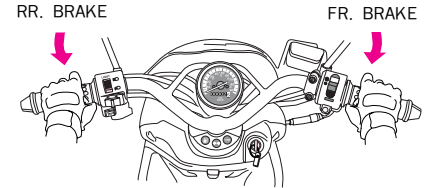

CAUTION

- If only one of the brakes is used, it is possible for the vehicle to experience sliding.

The brakes should never be suddenly applied and the handle bars should never be suddenly turned.

- Sudden braking or turning can cause the vehicle to slide and tip over.
- It is especially dangerous to perform sudden braking on wet roads or in rainy weather as the tires can lose traction and slip easily.

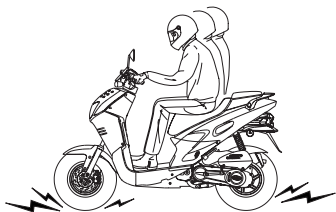

⚠ CAUTION

- Overspeed driving on the wet road can cause the vehicle to be overturned due to the water film effect or slip.
- In case of rain, the vehicle can be slipped on the painted traffic lane when braking suddenly or turning, resulting in the overturn.

Special care in driving should be taken during rainy weather.

- More braking distance is needed when driving on wet roads or in the rain. Reduce speed and be sure to initiate the braking operation sooner than when driving in normal conditions.
- On downgrades, allow the throttle grip to rotate back to its initial position to reduce speed, and apply the brakes and drive slowly down the hill.
- It is possible for the brakes to temporarily lose operative ability after driving through a puddle or when driving in the rain. To ensure that the brakes are operating properly, slow down (after checking for other vehicles) and while driving slowly, lightly apply the brakes to rid the brakes of any excess water and to dry them.
- Be extremely careful when driving in the snow or on icy roads. When driving in these conditions, both the tires lose much of their traction and the rear tire can slip when opening the throttle.

STOPPING

- 1 When approaching the desired stopping area.
 - Activate the proper winker, and after checking for other vehicles, slowly turn into the area in which you want to stop.
 - Allow the throttle grip to rotate completely back and apply the front and rear brakes. The brake light will shine to alert vehicles in back of you that you are stopping.

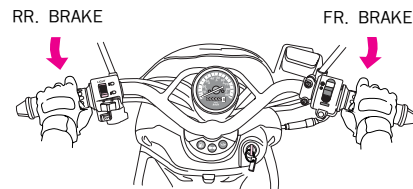

2 After the vehicle has come to a complete stop.

- Return the winker switch to the center position and turn the main switch to OFF. This will turn the engine off.

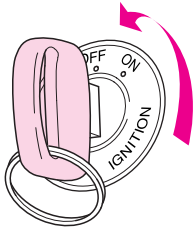

CAUTION

- Do not rotate the main switch key while driving. If the main switch is turned to an OFF or LOCK position, the electrical system will not operate. Operating the main switch key while driving can be very hazardous. Only turn the main switch key to OFF or LOCK position after completing stopping the vehicle.

3 Dismount on the left side and lower the main stand on a flat surface.

- Be sure to park in an area that is free of traffic. Also, the vehicle can tip over if the main stand is not placed on a stable and flat surface.
- The main stand is lowered by grasping the handle bars with the left hand, holding the rear carrier with the right hand, and stepping firmly on the stand with the right foot. In this position, lift the rear carrier upward, which will secure the main stand.

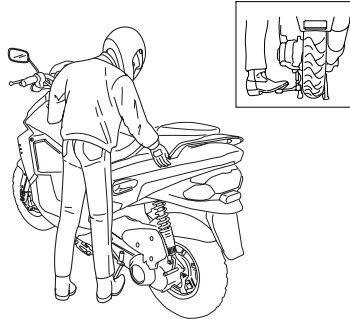

4 To prevent theft, be sure to lock handle bars when parking.

CAUTION

- Park in a safe area that will not block traffic. When you parked the vehicle after driving, make sure foot the vehicle beyond man's reach because engine and muffler are still hot.
- Do not park the vehicle on the inclined road. The vehicle can be overturned and endanger people around.

SELF INSPECTIONS BEFORE OPERATION

Self inspect the vehicle and have regular maintenance inspections for increased safety and the prevention of accidents. Regular maintenance inspections should be performed even if the vehicle has not been used for a long period of time.

Self inspections before operation should be performed on a daily basis prior to operating the vehicle.

- Inspections of concerned Area
- Brake inspection
- Tire inspection
- Fuel check
- Engine oil check
- Lights and winker inspection
- Back mirror inspection
- Fuel leak inspection
- License plate inspection
- Throttle grip inspection.

CAUTION

Observe safety rules when conducting inspections.

- Exhaust gas contains harmful substance such as carbon mono-xide. Do not carry out inspections on vehicle in closed places, or in poorly ventilated places, with engine running.
- Conduct inspections on flat, solid ground with the stand erected.
- Be careful of burns when conducting inspections immediately after engine is stopped because the engine and muffler are hot.
- Stop engine and remove the key prior to the vehicle maintenance service.
- Use appropriate types of tools.

CAUTION

- If you are unable to correct trouble even after you make adjustment or correction, contact authorized maintenance shops, dealers or designated repair shops for necessary inspection and repairs.

INSPECTION OF CONCERNED AREA

Check areas which caused for concern when last operating the vehicle.

BRAKE INSPECTION

<BRAKE LEVER FREE PLAY>

Lightly squeeze the brake levers until tension is felt to check for an appropriate amount of free play. No free play in the brake levers or overly loose brake levers are indication of a problem in the brake system.

BRAKE LEVER FREE PLAY: 10~20mm

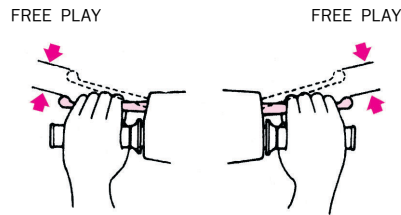

⚠ CAUTION

- Specified brake lever free play must be maintained. Excessive free play may cause long stopping distance, brake operational fault and slow reacting time resulting in the dangerous situation and insufficient free play may cause short stopping distance and damage brake system(pad, lining, etc.)

<CHECK OF BRAKE FLUID>

This is checked by placing the vehicle on its main stand on a flat surface. Make sure that the handle bars are at a horizontal level. Check to see if the fluid is below the LOWER level.

If brake fluid is significantly low, this may indicate that there is leakage in the brake system. Inspect the brake hose to check for leaks.

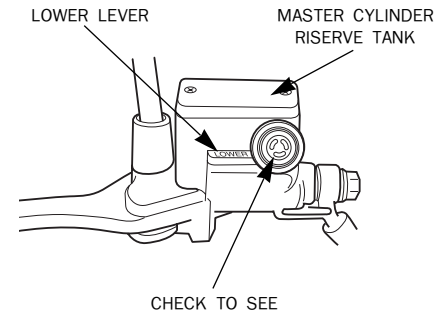

⚠ CAUTION

- If the brake fluid is significantly lower than the specified level, inspect not only brake fluid but also check the front brake pad for wear.

TIRE INSPECTION

<AIR PRESSURE CHECK>

Check for an appropriate level of air pressure by examining how the tire sits on the ground. If you notice any abnormalities in the shape of the tire with regard to the area contacting the ground, use a tire gauge to check tire pressure and adjust the tire pressure to the appropriate level.

| | | | |
|---|-----------------|---------------|------|
| SIZE | FRONT | 120/70-12 58L | |
| | REAR | 130/70-12 62L | |
| TIRE PRESSURE (kgf/cm ²) | WITH ONE PERSON | FRONT | 1.75 |
| | | REAR | 2.00 |
| | WITH TWO PERSON | FRONT | 1.75 |
| | | REAR | 2.25 |

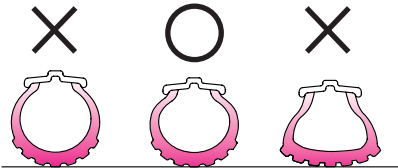

<CRACKS/DAMAGE>

Check tire tread and sides for cracks and damage.

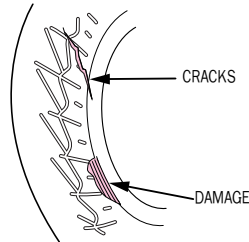

<ABNORMAL WEAR>

Check tire tread for signs of abnormal wear.

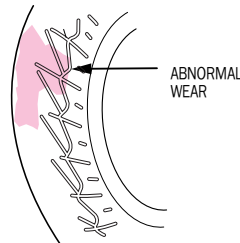

<FOREIGN MATERIALS>

Check tire tread and sides for nails, rocks, etc. That might have become wedged in the tire.

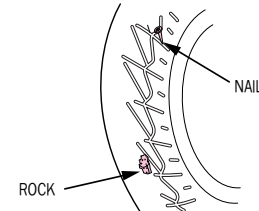

<TREAD DEPTH>

- Check the wear indicator (wear limit marking) to see if there is an insufficient amount of tread remaining.
- If the indicators are visible, replace tire with a new one.

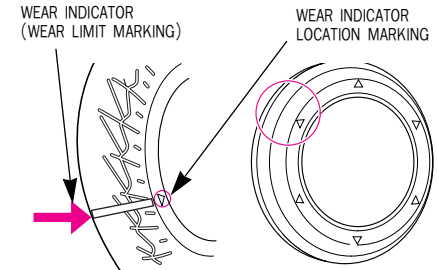

⚠ CAUTION

- If air pressure is inadequate or if there are cracks, damage or abnormal wear on tires, it may cause trembling steering wheel and flat tire.
- Insufficient air pressure may cause the heavy steering wheel making handling difficult, fuel over consumption and the excessive wear of tire outer area and excessive air pressure may cause easier wheel handling and lower fuel consumption. But it may also cause the excessive wear of tire center area.
- This vehicle is equipped with tubeless tires. If you have flat tires, please contact authorised maintenance shops for inspection.
- If nonstandardized tire is installed, tire can go flat easily due to the early wear resulted from frame interference, and the vehicle can be overturned resulting in injury of the driver.
- Depositing wasted tire in the unspecified place can pollute the environment and are subjected to legal penalty.

FUEL CHECK

<CHECK>

Check gasoline to see if there is a sufficient amount of gasoline to reach your destination.

- If the fuel warning indicator turns on after the main switch is placed to an “ON” position, fill fuel tank with gasoline as soon as possible.

RESERVE FUEL CAPACITY : 1 l

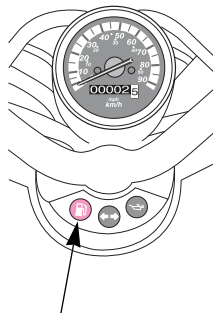

FUEL WARNING INDICATOR

<REFUELING>

- Release the seat lock by turning the main switch key OFF to OPEN to open the seat.
- Turn the fuel tank cap counterclockwise, and remove it.
- Fill the tank with gasoline until it reaches the bottom of the level plate.

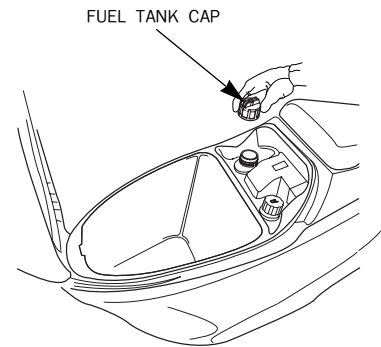

▲ CAUTION

- Make sure to stop engine and stay away from fire when refueling.
- Do not fill gasoline past the level plate. Gasoline may leak out of the fuel tank when replacing the fuel tank cap if too much gasoline is put in the fuel tank.
- Don't fill low grade gasoline. Using it can cause damage (bending, getting worn, etc.) to combustion chamber and parts of fuel.
- Do not close the fuel cap with excessive strength. It may cause the damage of the cap and the rubber packing resulting in the leak of fuel and may cause fire in case of electrical short or the overturn of the vehicle.
- If oil or water enter the fuel tank, the vehicle may not be started.
- If the fuel is leaked by rupture of the fuel hose due to the aging of the hose, fire can be occurred. Accordingly, check the hose periodically for the condition.

ENGINE OIL CHECK

<CHECK>

If the oil is low, the oil warning indicator will turn on. Turn the main switch to ON in order to check whether the oil warning indicator switches on. If it does, put oil in the oil tank.

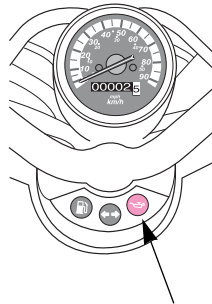

OIL WARNING INDICATOR

▲ CAUTION

- Do not allow the engine to stay at a low level. The engine will become severely damaged if the vehicle is driven while the oil warning indicator is on.

<HEADLIGHT, TAILLIGHT>

Start the engine and make sure the lights turn on. Also check to see if the lights are damaged or if there is dirt on them.

<BRAKE LIGHT CHECK>

Turn the main switch to ON.

While separately operating the front and rear brakes, check to see if the brake light turns on. Also check to see if there is any damage to the lens or if there is dirt on the brake light.

<WINKER CHECK>

Turn the main switch to ON.

Check to see if all the winker in the front and rear of the vehicle (including left and right sides) are flashing properly. At the same time, check to make sure that the automatic sound signal of the winker is working. Check also to see if any of the lens are damaged or dirty.

BACK MIRROR INSPECTION

Sit squarely on the seat and check to see if you have a good view behind the vehicle by looking at the back mirrors. Also check for dirt and damage on the back mirrors.

FUEL LEAK INSPECTION

Check to see if there is any leaking fuel by thoroughly checking the fuel tank, hose, carburetor, etc.

CAUTION

- If any fuel is spilled, make sure the area is dry before starting the engine.

LICENSE PLATE INSPECTION

Check to see if there is any dirt or damage to the license plate.
Also check to see if the license plate is firmly secured to the vehicle.

- The Required Maintenance Schedule specifies how often you should have your motorcycle served, and what things need attention.

It is essential that your motorcycle be served as scheduled to retain its high level of safety, dependability, and emission control performance.

- These instructions are based on the assumption that the motorcycle will be used exclusively for its designed purpose. Sustained high speed operation, or operation in unusually wet or dusty conditions, will require more frequent service than specified in the MAINTENANCE SCHEDULE.

Consult your authorized Daelim dealer for recommendations applicable to your individual needs and use.

MAINTENANCE SCHEDULE

Perform the Self Inspections Before Operation at each scheduled maintenance period.

I: INSPECT AND, CLEAN, ADJUST, LUBRICATE OR REPLACE IF NECESSARY

R: REPLACE L: LUBRICATE C: CLEAN

| ITEM | | FREQUENCY | ODOMETER READING(CAUTION 1) | | | | REMARK | |
|------|--------------------|-----------|-----------------------------|---|---|----|----------|----|
| | | | ×1,000Km | 1 | 4 | 8 | | 12 |
| | | | MONTH | | 6 | 12 | | 18 |
| ★ | FUEL LINE | | | I | I | I | | |
| ★ | THROTTLE OPERATION | | I | I | I | I | | |
| | AIR CLEANER | | | C | C | C | NOTE (2) | |
| | SPARK PLUG | | | I | I | I | | |
| ★★ | CARBON REMOVAL | | Every 8,000Km : C | | | | | |
| ★ | CARBURETOR IDLE | | I | I | I | I | | |
| ★ | OIL PUMP, OIL LINE | | | I | I | I | | |
| | TRANSMISSION OIL | | | | | R | NOTE (3) | |
| ★ | BRAKE FLUID | | | I | I | I | NOTE (3) | |

| ITEM | | FREQUENCY | ODOMETER READING(CAUTION 1) | | | | REMARK | |
|------|-------------------------|-----------|-----------------------------|---|---|----|--------|----|
| | | | × 1,000Km | 1 | 4 | 8 | | 12 |
| | | | MONTH | | 6 | 12 | | 18 |
| ★ | BRAKE SHOE / PAD WEAR | | | I | I | I | | |
| | BRAKE SYSTEM | | I | I | I | I | | |
| ★ | BRAKE STOP SWITCH | | | I | I | I | | |
| ★ | HEADLIGHT ADJUSTMENT | | | I | I | I | | |
| ★ | SUSPENSION | | | I | I | I | | |
| ★ | BOLTS, NUTS, FASTENERS | | I | | I | | | |
| ★★ | WHEELS / TIRES | | | I | I | I | | |
| ★★ | STEERING HANDLE BEARING | | I | | I | | | |
| ★★ | DRIVE BELT | | | I | I | I | | |
| ★★ | WEIGHT ROLLER | | | | I | I | | |
| ★★ | SLIDE PIECE | | | | I | I | | |

★ If you do not have the appropriate tools or information to conduct maintenance, or if you feel you are not capable to perform maintenance on this vehicle, contact registered repair center nearby.

★★ To ensure safety, inspections and maintenance of these parts must be carried out by dealers, or repair centers.

NOTES : (1) At higher odometer readings, repeat at the frequency interval established here.

(2) Service more frequently when riding in unusually wet or dusty areas.

(3) Replace every 2 years, or at indicated odometer interval, whichever comes first. Replacement requires mechanical skill.

MAINTENANCE PRECAUTIONS

The following is an explanation of correct inspection methods, cleaning and parts replacing. Please always refer to this section when wanting to inspect or repair your vehicle.

⚠ WARNING

- If your motorcycle is overturned or involved in a collision, inspect control levers, cables, brake hoses, calipers, accessories, and other vital parts for damage. Do not ride the motorcycle if damage impairs safe operation. Have your authorized Daelim dealer inspect the major components, including frame, suspension and steering parts, for misalignment and damage that you may not be able to detect.
- Use new, genuine Daelim parts or their equivalent for maintenance and repair. Parts which are not of equivalent quality may impair the safety of your motorcycle and the effective operation of the emission control systems.

⚠ CAUTION

- Always observe safety rules when performing maintenance on the vehicle.
- Choose a flat surface and make sure the main stand is in a secure down position.
- Use correct tools.
- Conduct engine maintenance with the engine key out of the ignition.
- Be careful around the engine and muffler when performing maintenance as these areas can become extremely hot.
- After self maintenance, the waste material must be packed in the specified container and entrusted disposal to the authorized disposal company.

REPLENISHING BRAKE FLUID

1. Clean dust and other foreign materials around reserve tank to prevent foreign materials from falling inside tank.
2. Remove the screws and take oil cup cap, diaphragm plate, diaphragm off.
3. Replenish recommended brake oil to the upper level inside reserve tank.

RECOMMENDED BRAKE OIL IS DOT 3 or DOT 4

4. Reinstall the diaphragm, diaphragm plate, and oil cup cap.
 5. Tighten the screws securely.
- Check the brake pads for wear when refilling with brake fluid.
 - A low fluid level may be due to wear of the brake pads.
 - If the brake pads are not worn and the fluid level is low, check for leakage.

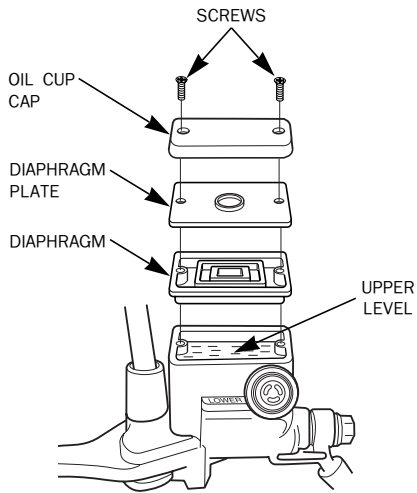

Other checks

- Visually check for fluid leaks or damage and, using a spanner, check joints and clamps for clearance. Also, check hose and pipe protective parts to see if they contact other parts when turning the handle bars or due to vibration when driving.

CAUTION

- When adding brake fluid, be very careful not to allow foreign materials to enter the reserve tank. Foreign materials can clog the system, causing a reduction or complete loss of braking ability.
- Do not fill past upper level. This can cause brake fluid to leak out of the reserve tank.
- Do not let brake fluid contact vehicle parts as this damages painted areas. If oil contacts parts, quickly clean the fluid off using a dry cloth.
- Use recommended brake fluid as other types can undergo chemical changes.
- If brake fluid is exceedingly low, this can be indication of damage to the brake system.
- A leak in the brake system can lead to reduced braking efficiency and possible loss of braking ability.

BRAKE PAD INSPECTION

Operate the brake lever to check the wear of the brake pad. While looking at the brake caliper, if the wear limit line is not visible, the pads need to be replaced.

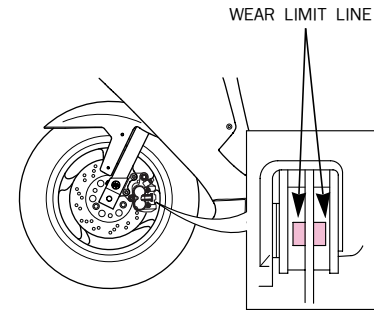

CAUTION

- The brake lever must be operated several times after replacement of the front brake pad.
- If the anticorrosive is applied to the brake disk, braking can not be performed successfully, resulting in the injury or death of the driver in case of accident.

BRAKE LEVER ADJUSTMENT

Brake lever free play is adjusted by rotating the adjuster of the brake arm.

After adjustment, check the brake lever to ensure that the clearance is not above or under the prescribed amount.

BRAKE LEVER FREE PLAY : 10~20mm

CAUTION

- After adjusting the brake, make sure that “□” part of the adjuster contacts the pin as in the drawing below. Brake clearance can change when driving if this is not done.
- It is not necessary to adjust the front brake.
- If the brake lever free play is significantly decreased, check the front/rear brake pads and the lining.

REAR BRAKE

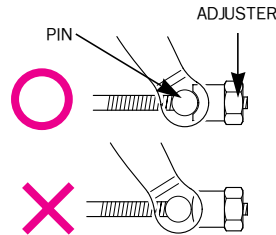
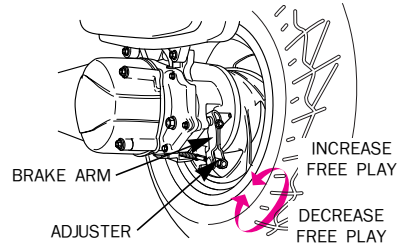

After adjusting the brakes, check the wear of the brake shoe. While tightly squeezing the rear brake lever, if the “△” mark of the brake arm is aligned with the “△” mark of the brake panel, this indicates that the brake shoe is worn. Please take the vehicle to a service center for repair.

REAR BRAKE

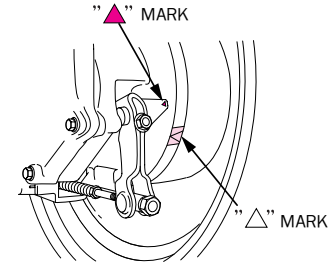

CAUTION

- If the vehicle becomes worn-out, the replacement cycle of shoe may differ depending on the wear condition of the rim drum.

REPLENISHING ENGINE OIL

<INSPECTION>

If the oil is low, the oil warning indicator will turn on. Turn the main switch to ON in order to check whether the oil warning indicator switches on. If it does, put oil in the oil tank.

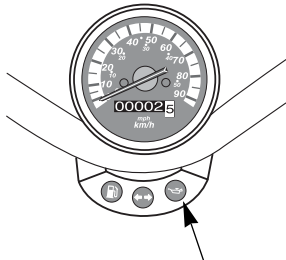

OIL WARNING INDICATOR

CAUTION

- Always pay attention to keep up proper oil level. Driving with the oil warning indicator turned on may cause severe damage to the engine.
- Sometimes, the indicator becomes inoperative due to the faulty oil warning indicator switch. Check the engine oil level periodically.

<REPLENISHING>

1. Set vehicle on main stand in upright position on level ground.
2. Open the seat.
3. Turn the oil cap counterclockwise, and remove it.
4. Fill the oil tank to the fill level.
5. Turn the oil cap clockwise, and install it.
6. Close the Seat. Check to see if the seat lock has latched.

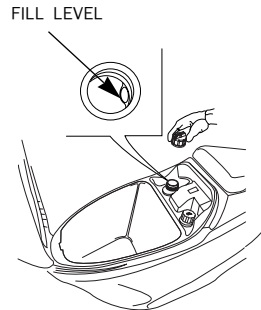

<RECOMMENDED OIL>

If oil sold on markets or privately manufactured oil (oil-grade) is used, engine life is adversely affected, and the privilege of warranty repairs cannot be guaranteed.

CAUTION

- Do not fill past the fill level. Oil will leak out if this is done.
- Immediately replace oil cap after filling oil tank with oil.
- Make sure that foreign materials do not enter the oil tank.
- Do not use other manufacturers oil and do not use low quality oil.

TRANSMISSION OIL INSPECTION

<OIL LEVEL>

- Start the engine and let it idle for a few minutes.
- Stop the engine and put the motorcycle on its mainstand on level ground.
- Remove the L. crank case cover.
- Remove the oil check bolt and make sure that the oil level is up to the lower edge of the bolt hole.
- If the level is low, release the transmission oil filler ACG cap or the L.crankcase until the oil overflow through oil hole and fill the recommended oil slowly.

RECOMMENDED OIL : SAE # 80~90

- Reinstall the oil check bolt, the cap, and the L.crankcase cover.

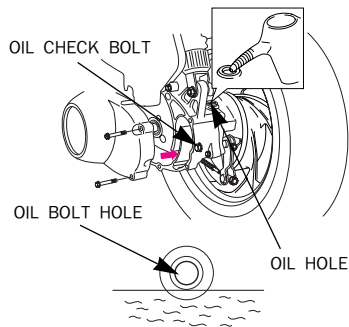

<FLUID LEAK>

Check to see if transmission oil leaks out of the transmission case.

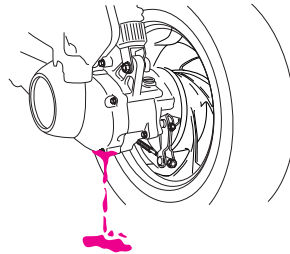

⚠ CAUTION

- Pay special attention not to let rubber etc., enter the check bolt hole.
- When draining the oil, make sure that all of the oil is removed.
- The engine can be harmed if there is too much or not enough oil.
- Do not use other manufacturers oil or low-quality oil. These oils can change quality overtime and can cause damage.

TIRE PRESSURE INSPECTION

Check the tire pressure using a tire gauge. Check tire pressure when the tires are cool.

| | | | |
|--|--------------------|-------|------|
| AIR PRESSURE (kgf/cm ²) | 1 PERSON RIDING | FRONT | 1.75 |
| | | REAR | 2.00 |
| | 2 PERSON RIDING | FRONT | 1.75 |
| | | REAR | 2.25 |

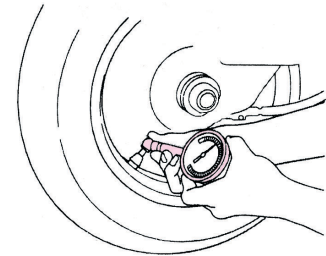

⚠ CAUTION

- If there is an improper amount of air in the tires, or if there are cracks, damage or abnormal wear on tires, this may cause unstable steering or may allow the tires to become easily punctured.

WHEEL REMOVAL

<FRONT WHEEL REMOVAL>

- ① Raise the front wheel off the ground by placing a support block under the engine.
- ② Loosen the oval screw and remove the speedometer cable.

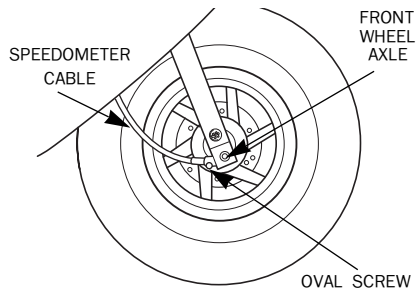

- ③ Remove the front caliper assembly from the front fork by removing the fixing bolts.

⚠ CAUTION

- Do not operate brake lever after the front wheel is removed. It will make wheel assembling difficult.

- ④ Loosen the axle nut.
- ⑤ Withdraw the front wheel axle and remove the front wheel.

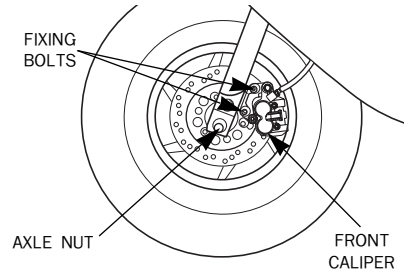

- ⑥ Install in the reverse order of removal.

⚠ CAUTION

- When installing the wheel, carefully fit the left brake disk between the brake pads to avoid damaging the pads.

- Fit the caliper over the disc, taking care not to damage the brake pads. Install the caliper fixing bolts, and tighten to a torque of : **2.7kgf · m**

- Tighten the front axle nut to the specified torque.

FRONT AXLE NUT TORQUE
: **5.0~7.0kgf · m**

- ⑦ After assembling, operate brake for a number of times and see if wheel is turning smoothly without getting interruption.

⚠ CAUTION

- If a torque wrench was not used for installation, see your authorized dealer as soon as possible to verify proper assembly. Improper assembly may lead to loss of braking capacity.

SIDE STAND INSPECTION

<REAR WHEEL REMOVAL>

- ① Set vehicle on main stand in upright position on level ground.
- ② Loosen the rear brake adjuster nut.

REAR BRAKE ARM

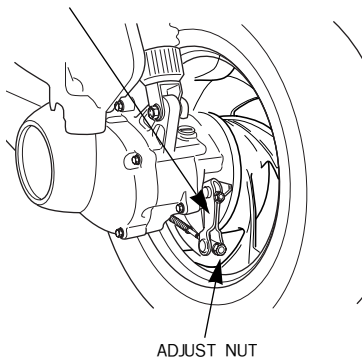

- ③ Remove the muffler.
- ④ Loosen the rear wheel axle nut.
- ⑤ Remove the lock washer and the rear wheel.

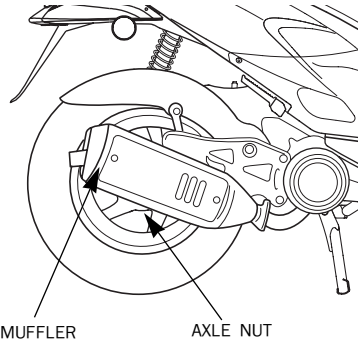

- ⑥ Install in the reverse order of removal.

REAR AXLE NUT TORQUE
: 6.0~8.0kgf · m

CAUTION

- If a torque wrench was not used for installation, see your authorized dealer as soon as possible to verify proper assembly. Improper assembly may lead to loss of braking capacity.

- Erect main stand and place vehicle in up right position on level ground.
- Check the spring for damage or loss of tension and the side stand assembly for freedom of movement.
- Check the side stand ignition cut-off system;
 - ① Put the side stand up.
 - ② Start the engine.
 - ③ Lower the side stand. The engine should stop as you put the side stand down.
- If the side stand system does not operate as described, inspect it in the closest authorized repair center.

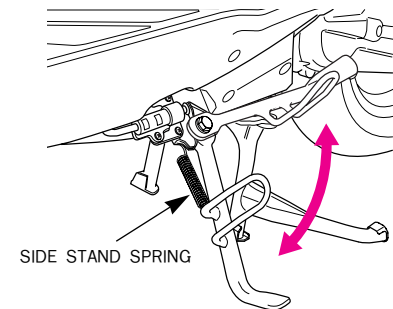

SPARK PLUG

If electrode is stained or clearance is not right, satisfactory spark is not produced. Clean and make adjustment.

- ① Loosen the special screw and remove the plug maintenance cover.
- ② Remove the spark plug cap.
- ③ Clean around the plug.
- ④ Using a plug wrench, remove the plug.

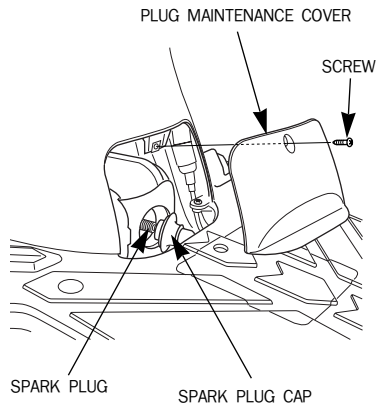

- ⑤ Clean plug with plug cleaner.
- ⑥ Check electrode for wear and corrosion.
- ⑦ Check the plug gap using a feeler gauge.

PLUG GAP : 0.6~0.7mm

- ⑧ Tighten with hands until the plug washer touches cylinder head.

STANDARD PLUG: BR8HSA

- ⑨ If new plug is installed, turn 1/2 and tighten using a plug wrench.
If plug is reused, turn 1/3~1/4 and tighten.

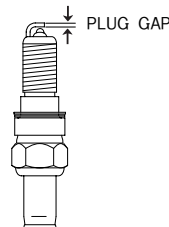

- ⑩ Install in the reverse order of removal.

CAUTION

- If plug of different maker or different heat value is used, it causes unsatisfactory engine starting, inadequate engine revolution and output deterioration.
- The spark plug must be securely tightened. An improperly tightened plug can become very hot and possibly damage the engine.

BATTERY INSPECTION

<CLEANING BATTERY TERMINALS>

- If you remove screw from battery box cover after putting floor panel met forward, you will find battery assembled.
- If the battery terminal is polluted, or in rust, separate battery and clean it.
- Battery terminal in rust with white powder should be cleaned with warm water.
- In case of serious rust of battery terminal, disassemble the battery cord and grind it with wirebrush or sandpaper.

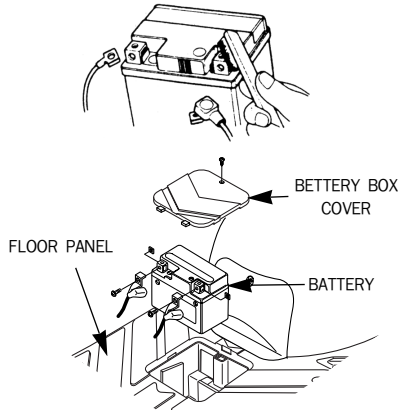

⚠ CAUTION

- Turn the ignition switch OFF before disconnecting the terminal from the battery.
- When cleaning battery, do not disassemble the battery cap to prevent foreign materials from falling inside battery.
- Remove the negative pole \ominus side cord first and the positive pole \oplus side cord next. Make sure, at this time, that \oplus side cord is connected first, followed by \ominus side cord.
- When handling the battery, stay away from flammable materials.
- Make sure that terminals do not contact with other adjacent parts when handling \oplus / \ominus terminal. Contact with other parts may cause spark resulting in electrical equipment malfunction, fire and electric shock.
- Frequent cell starting can shorten the battery lifetime. Please use a kick to start the engine after the long period storage and in case of the initial starting and the cold starting to improve starting performance and extend the battery lifetime.

<REPLENISHING BATTERY WATER>

- This vehicle doesn't need either replenishing or checking battery water because of the equipment of enclosed MF battery.
- In case battery needs a checking, it should be cared of by service center.

⚠ CAUTION

- Be careful not to disassemble injection part of enclosed battery.
- When not using vehicle during a long time, take off the battery from the vehicle to keep from self-discharge and electric discharge. Put the battery in a well ventilated place after charging fully. In case it isn't available to take battery off from the vehicle, disconnect "-" terminal.

FUSE REPLACEMENT

Turn off the main switch to see if the fuse is severed. If the fuse is severed, exchange the fuse into 7A fuse.

- To change a fuse, first take off battery cover. Then, disconnect a “fuse connector” after opening a “fuse holder.”
- If the fuse immediately becomes severed after being changed with the new one, check another problem of the electric system.

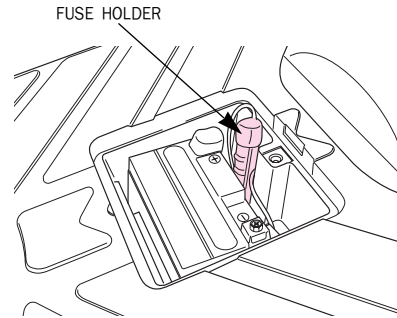

<DISASSEMBLY> <ASSEMBLY>

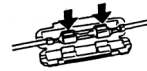
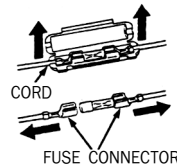

CAUTION

- When disassemble fuse, make sure that fuse holder isn't separated.
- After assembling fuse in the part of connector, check if fuse moves easily to a line. If fuse moves easily, it may cause an accident at heating.
- Do not use a fuse having a larger voltage as the wire can become overheated and damaged.

When replacing any of the electrical parts (lights and gauges), be sure to replace them with the recommended parts. Using different parts can lead to the fuses burning out or damage to the battery.

- When washing the vehicle, take special care not to allow to be splashed in the area of the fuses.

BULB REPLACEMENT

- Be sure to turn the ignition switch OFF when replacing the bulb.
- Do not use bulbs other than that specified.
- After installing a new bulb, check that the light operates properly.

⚠ CAUTION

- The light bulb becomes very hot while the light is ON, and remain hot for a while after it is turned OFF. Be sure to let it cool down before servicing.
- Do not put finger prints on the headlight bulb, as they may create hot spots on the bulb and cause it to break. Wear clean gloves while replacing the bulb.
If you touch the bulb with your bare hands, clean it with a cloth moistened with alcohol to prevent its early failure.
- When replacing the head light lamp, stop lamp and winker lamp, use only specified lamps. Do not use the lamp exceeded its capacity. the battery can be overcharged and fire can be occurred due to the burned wire.

[HEADLIGHT BULB]

- ① Put your hand under the front under cover and stretch it to the back of the headlight bulb.
- ② Remove the rubber cover.
- ③ Turn the socket clockwise, and remove it.
- ④ Slightly press down on the bulb and turn it counterclockwise.
- ⑤ Install a new bulb in the reverse order of removal.

HEADLIGHT BULB : 12V 35W/35W

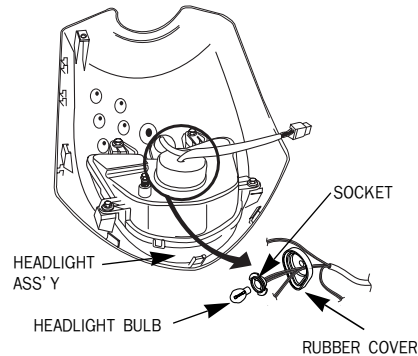

[TAIL/STOPLIGHT BULB]

- ① Loosen the 2 tapping screws and remove the tail light lens.
- ② Install a new bulb in the reverse order of removal.

TAIL/STOP LIGHT BULB : 12V 5W/21W

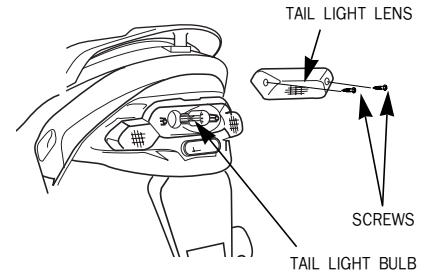

[WINKER BULB]

<FRONT WINKER BULB>

- ① Loosen the 6 upper cover setting screws, and remove the front cover assembly.

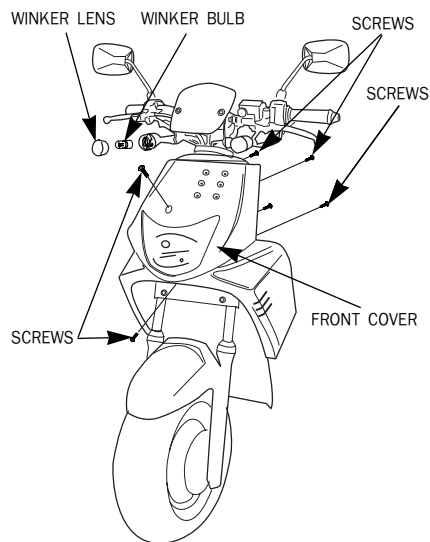

- ② Turn the winker bulb sockets counterclockwise, and remove it.
- ③ Install a new bulbs in the reverse order of removal.

FRONT WINKER BULB : 12V 10W

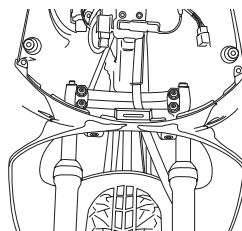

<REAR WINKER BULB>

- ① Press the winker lens groove and open the winker lens using plain screwdriver.
- ② Slightly press down on the bulb and turn it counterclockwise.
- ③ Install a new bulb in the reverse order of removal.

REAR WINKER BULB : 12V 10W

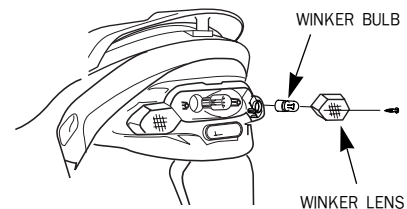

AIR CLEANER ELEMENT INSPECTION

<REMOVAL>

- ① Loosen the 6 washer screws and remove the air cleaner case cover.
- ② Inspect the air cleaner element.
- ③ Install in the reverse order of removal.

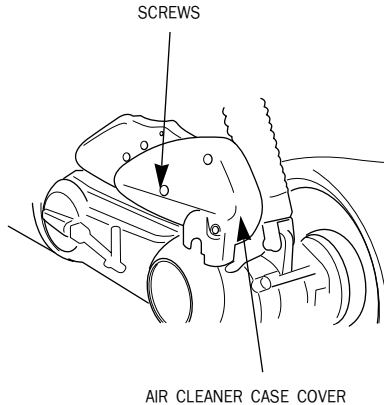

<CLEANING>

- Clean the air cleaner element in clean oil, squeeze excess oil, and then, wrapping it in a dry cloth, squeeze it again.
- Make sure all excess oil removed and reassemble the air cleaner element.

OIL : SAE # 80 ~ 90

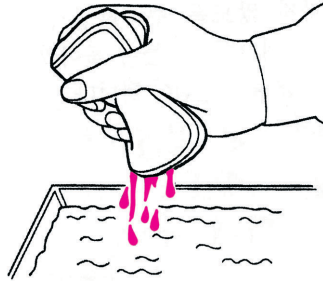

⚠ CAUTION

- Do not use gasoline or other materials having a low ignition point as this can be a fire hazard.
- If the air cleaner element is inadequately assembled, dust and other waste materials can directly enter the engine. This results in increased cylinder wear and reduced power, and reduced durability of the engine.
- When washing the vehicle, be careful not to allow water to get into the air cleaner.
Difficulties in starting the engine may result if this happens.
- If the engine start is failed during rain or after driving across water pool, check to see if the water is infiltrated in the air cleaner and clean it.
- Do not drive in the flooded area. If the water enters the air cleaner or engine, the vehicle may be subjected to the rear-end collision due to the power failure.

CABLE RUBBER PART INSPECTION

A rubber part is assembled on the cable to protect the inner cable.

Make sure that this part is placed firmly around the correct part of the cable. When washing the car, do not directly spray water on to the rubber part is dirty, use a dry cloth to clean this area.

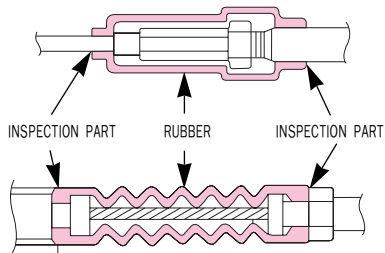

⚠ CAUTION

- Petrol is extremely flammable and is explosive under certain conditions. Perform this operation in a well-ventilated area with the engine stopped. Do not smoke or allow flames or sparks in the area where petrol is drained or stored and where the fuel tank is refueled.

PAY ATTENTION FOR CAR WASHING

- Be sure to stop the engine prior to car washing.
- Be careful not to allow water to enter the muffler during the washing. Water inside the muffler may cause an improper engine starting or rust occurrence.
- Do not let water get inside the braking system during the washing, as water inside the brake system may weaken the braking power. Upon completion of washing, select a safe place where there is no traffic obstruction, and start the vehicle. Lightly apply the brake while driving at a slow speed and check the braking power. If the braking power has been weakened, apply brake lightly while driving at a slow speed to dry up the brake system.

- Take precautions when waxing the vehicle. Excessive polish of the painted section and/or the resin part with compound wax might damage the painted section causing discoloration of the affected area.

STORAGE GUIDE

Extended storage, such as for winter, requires that you take certain steps to reduce the effects of deterioration from non-use of the motorcycle.

In addition, necessary repairs should be made BEFORE storing the motorcycle; otherwise, these repairs may be forgotten by the time the motorcycle is removed from storage.

<STORAGE>

- Empty the fuel tank into an approved gasoline container using a commercially available hand siphon or an equivalent method.
- If storage will last more than one month, carburetor draining is very important, to assure proper performance after storage.

⚠ CAUTION

- Gasoline is extremely flammable and is explosive under certain conditions. Perform this operation in a well-ventilated area with the engine stopped. Do not smoke or allow flames or sparks in the area where gasoline is drained or stored and where the fuel tank is refueled.

FRAME AND ENGINE NUMBER

- Remove the battery. Store in an area protected from freezing temperatures and direct sunlight. Slow charge the battery once a month.
- Wash and dry the motorcycle. Wax all painted surfaces.
- Inflate the tires to their recommended pressures. Place the motorcycle on blocks to raise both tires off the ground.
- Cover the motorcycle (don't use plastic or other coated materials) and store in an unheated area, free of dampness with a minimum of daily temperature variation. Do not store the motorcycle in direct sunlight.

<REMOVAL FROM STORAGE>

- Uncover and clean the motorcycle.
- Charge the battery as required. Install the battery.
- Perform all Self Inspections Before Operation checks (page 25).
Test ride the motorcycle at low speeds in a safe riding area away from traffic.

- The frame number is stamped on the front central part of the frame.
- The engine number is stamped on the rear face of the left crankcase.
- The frame and engine numbers will be used as the basis of recovering the vehicle when is stolen.
- Record the frame and engine numbers along with the vehicle license plate numbers and keep them separately from the vehicle.

<FRAME NUMBER>

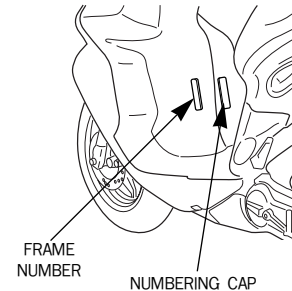

<ENGINE NUMBER>

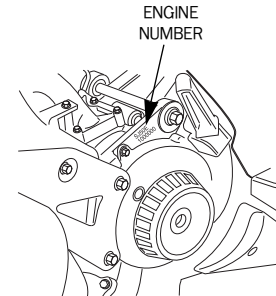

SAFE DRIVING

PREPARATION BEFORE DRIVING

- Performing daily inspection
- Putting on the protective gears (Helmet, glove, goggles, etc.)
- Bringing the driver's licence
- Determinating the path to the desired destination



DRIVING METHOD

DRIVING POSITION

The appropriate driving position is most important thing to driving safely.

- ① Eyes : Look at the front direction widely.
- ② Shoulders : Relieve the tension.
- ③ Arms : Relieve the tension and bend arms to inside and let them act as the spring.
- ④ Hands : Grip the handle the position away from the inside end of the handle with distance of one finger to facilitate the operation of the switch and lever.
- ⑤ Wrist : Keep the state to act freely without applying excessive force to the shoulder and arms.
- ⑥ Knees : Press the fuel tank slightly.
- ⑦ Feet : Place the feet to face the front parallel and make the step bar be placed in the center of feet.

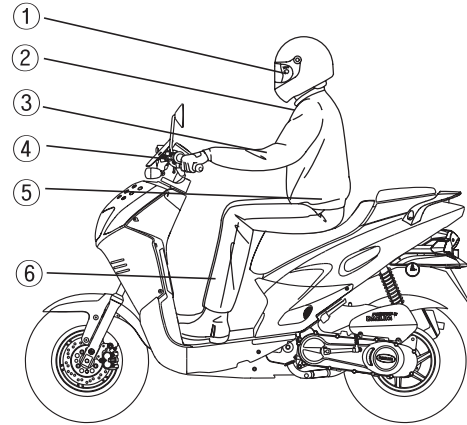

TAKING POSE OF FELLOW PASSENGER

- ① Hands: Hold the rear grip.
- ② Feet and knees: Put the feet on pillion step, and adhere the knees closely to body.

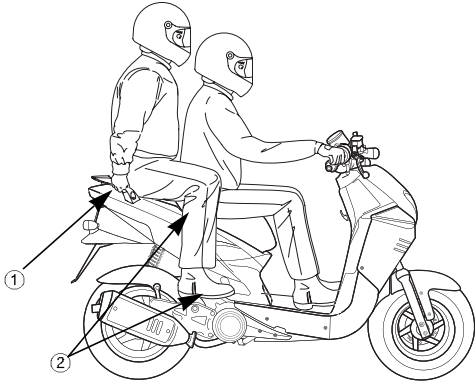

⚠ WARNING

- If the fellow passenger doesn't hold the rear grip or put the step on the pillion step, it may lead death or serious injury due to falling from the vehicle as sudden start, stop or turning.
- Do not operate the throttle while setting the main stand. If the fellow passenger sit on and the rear wheel touch the ground, it may lead death or serious injury due to sudden start.

PRECAUTION WHEN DRIVING

- Secure the safe distance.
- Drive protectively.
- Do not obstruct the traffic.
- Do not drive on the pedestrian way or walkway.
- Drive on the left driveway when passing away.
- Make sure that you can apply the brake anytime.
- Always apply the brake when stopping temporarily.
- Do not drive excessively long distance and take enough break.
- If any abnormality is found, stop driving and contact service center to inspect the vehicle.
- Restart the vehicle after 2~3 min when it is turned over.
- Always turn on the headlight at night.

STARTING

Prior to starting always look around to avoid accident.

- ① Get on the vehicle after pulling back the stand.
- ② Keep hold brake lever when starting.
- ③ Start using the cell (Erect main stand when using the kick starter)
- ④ Start driving slowly after turning on the winker and releasing the brake while ensuring the safety around the vehicle.

CAUTION

- Return the side stand to its original position. Keep driving without doing this may cause turnover accident.
- Drive the vehicle only on the driveway. Driving on the walkway can cause accident. Also, if the wheel is transformed when advancing directly to the walkway, the vehicle can be overturned resulting in injury of the driver due to the driving instability.
- Overspeed driving on the unpaved road can cause the vehicle to be overturned resulting in injury of the driver due to the driving instability.
- Do not drive in the gravel road. If any gravel enters the wheel or engine case, the vehicle can be overturned resulting in injury of the driver.
- If possible, do not drive close to the sea or on the road where calcium chloride is treated.
The muffler, external parts and welded parts can be corroded rapidly, and also in case of damage of the frame, the vehicle can be overturned resulting in injury of the driver.

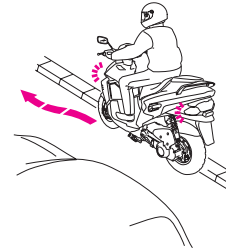
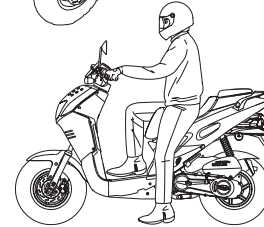
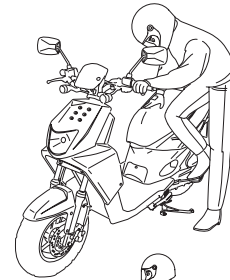

TURNING METHOD

PRINCIPLE OF TURN

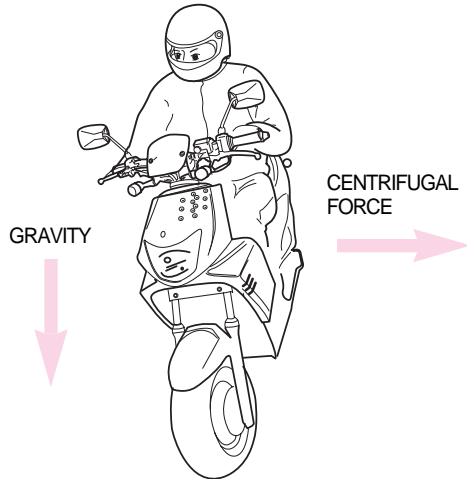

The basic principle of turn is balancing using the centrifugal force which makes vehicle go outside and the gravity which makes vehicle fall inside.

EFFECT OF SPEED

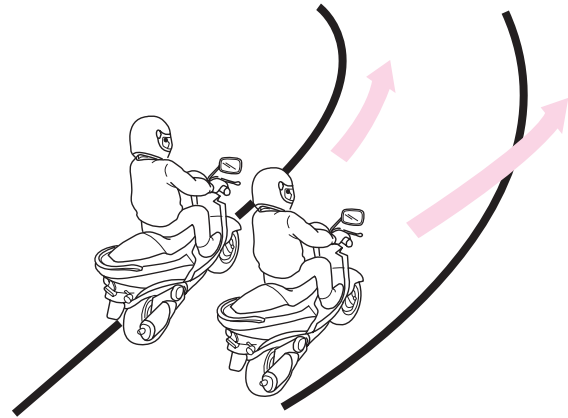

The centrifugal force increases in inverse portion to the radius of a curve and in portion to the square speed. Decelerate prior to entering the curved way to reduce the centrifugal force.

3 POSITIONS OF TURNING

The basic principle of turn is balancing using combined force of the centrifugal force and the gravity.

All 3 positions require straightening the head and keeping the eyes horizontally.

< LEAN-WITH >

This is a turning position with motorcycle and driver in a line.

This position is the most natural and exact, so driver must learn it thoroughly.

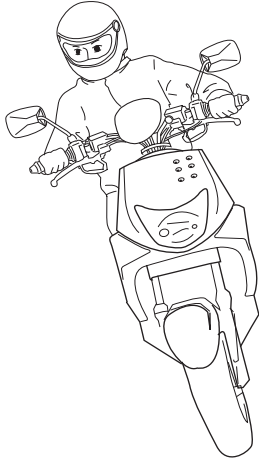

< LEAN-IN >

This is a turning position with driver leaned inside more than motorcycle. This position is adequate to drive on the rained or slippery road because it has best road holding.

However, special attention is required because front visual field is poor when driver leans inside more than motorcycle.

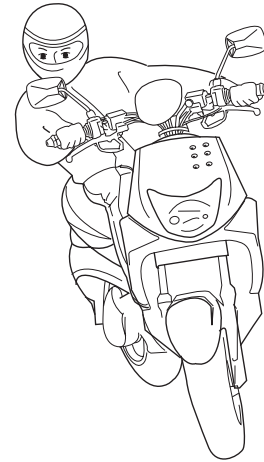

TURNING METHOD

< LEAN-OUT >

This is a turning position with motorcycle leaned inside more than driver, which is opposite to the lean-in position. With this position, quick turn is well performed and driver can obtain wide front visual field adequate to drive on the rained or slippery road because it has best road holding. However, special attention is required because there is danger of slipping on the bad holding road.

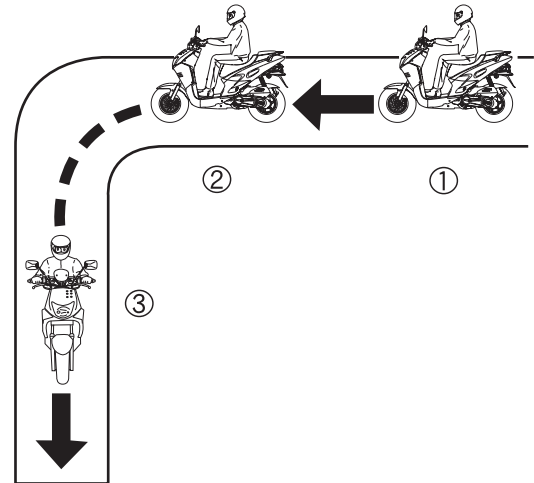
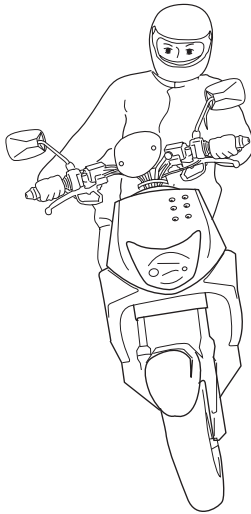

- ① Turn the throttle grip to its original position and decelerate using both front and rear brakes.
- ② Lean the vehicle toward inside of turn circle while driving slowly at constant speed.
- ③ Accelerate gradually.

PRECAUTION WHEN TURNING

Do not drive inside of large truck's turn circle.

< DEAD ANGLE ZONE >

Dead angle zone is the sight range which cannot be identified by driver and increases in proportion to the width of the vehicle.

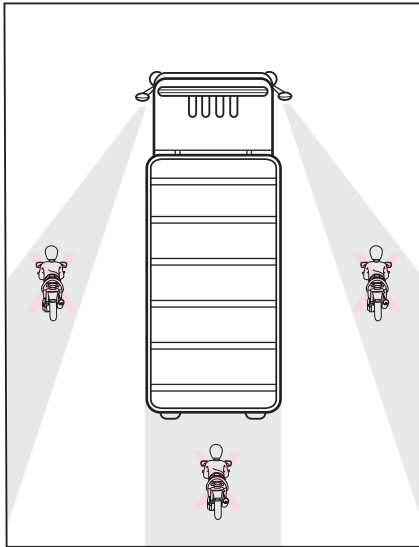

< DISTANCE BETWEEN THE FRONT AND REAR WHEEL TURN >

It is distance between path of the front and rear wheel and increases in proportion to the length of the vehicle.

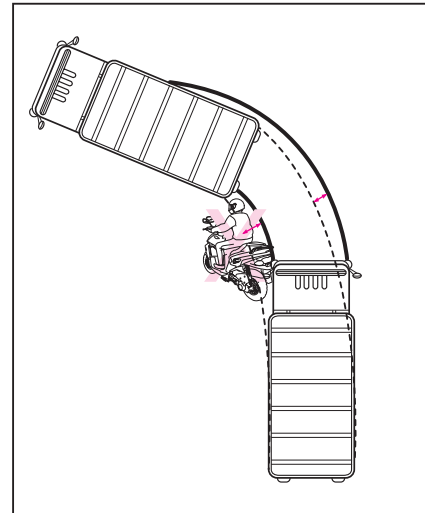

BRAKING METHOD

BASIC PRINCIPLE OF BRAKE (FRICTION FORCE)

- Vehicle is braked using friction between road surface and tires.
- Braking distance increases 1.5 times on wet road and 3 times on icy road because friction force of road surface is decreased.

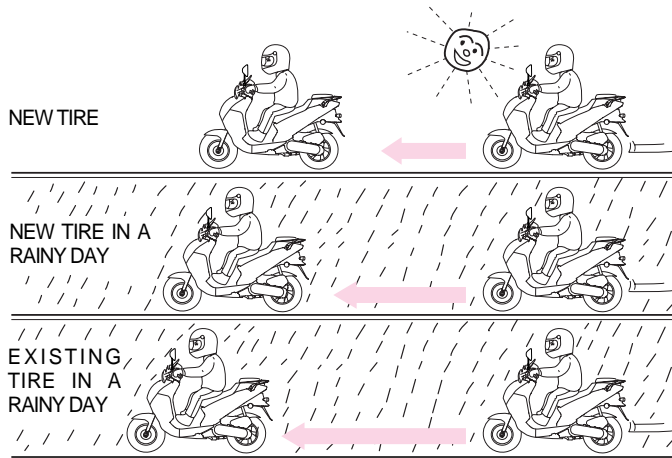

RESTRAINT OF BRAKE EFFECT (INERTIA)

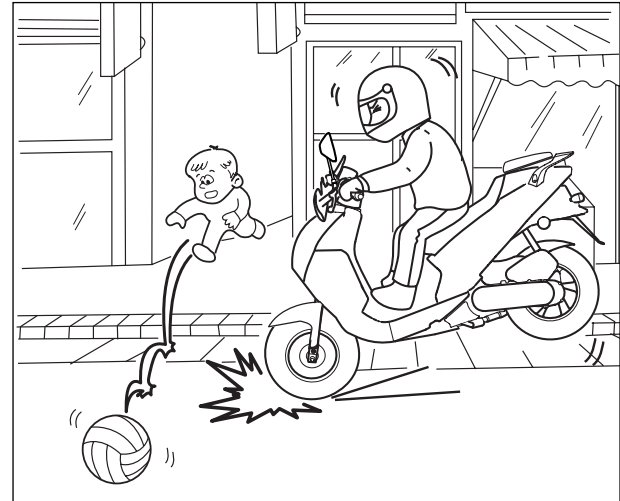

Due to the inertia, vehicle does not stop immediately after applying the brake.

BRAKING METHOD

- Turn the throttle grip to its original position and decelerate using the engine brake.
- Erect the vehicle straight.
- Brake using both front and rear brakes.

COMPARISON OF BRAKING DISTANCE

- Vehicle speed : 50 km/h

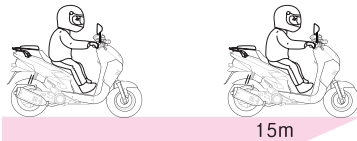

When using both front and rear brakes



When using only front brake



When using only rear brake

IMPACT WHEN COLLISION

Learn the proper braking method to prevent accident.

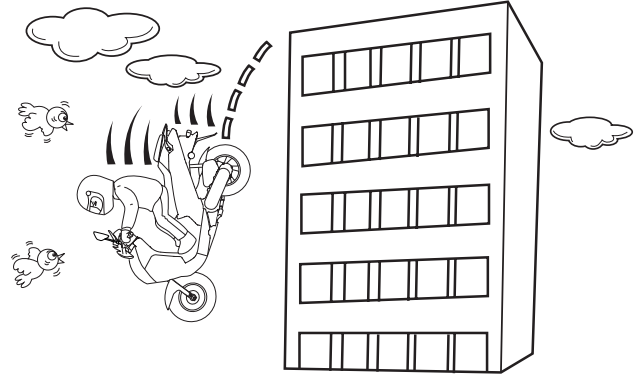

Impact increases in proportion to the speed and weight. The impact when collision to concrete wall at 50 km/h is same as one when falling from the height of 10m.

WIRING DIAGRAM

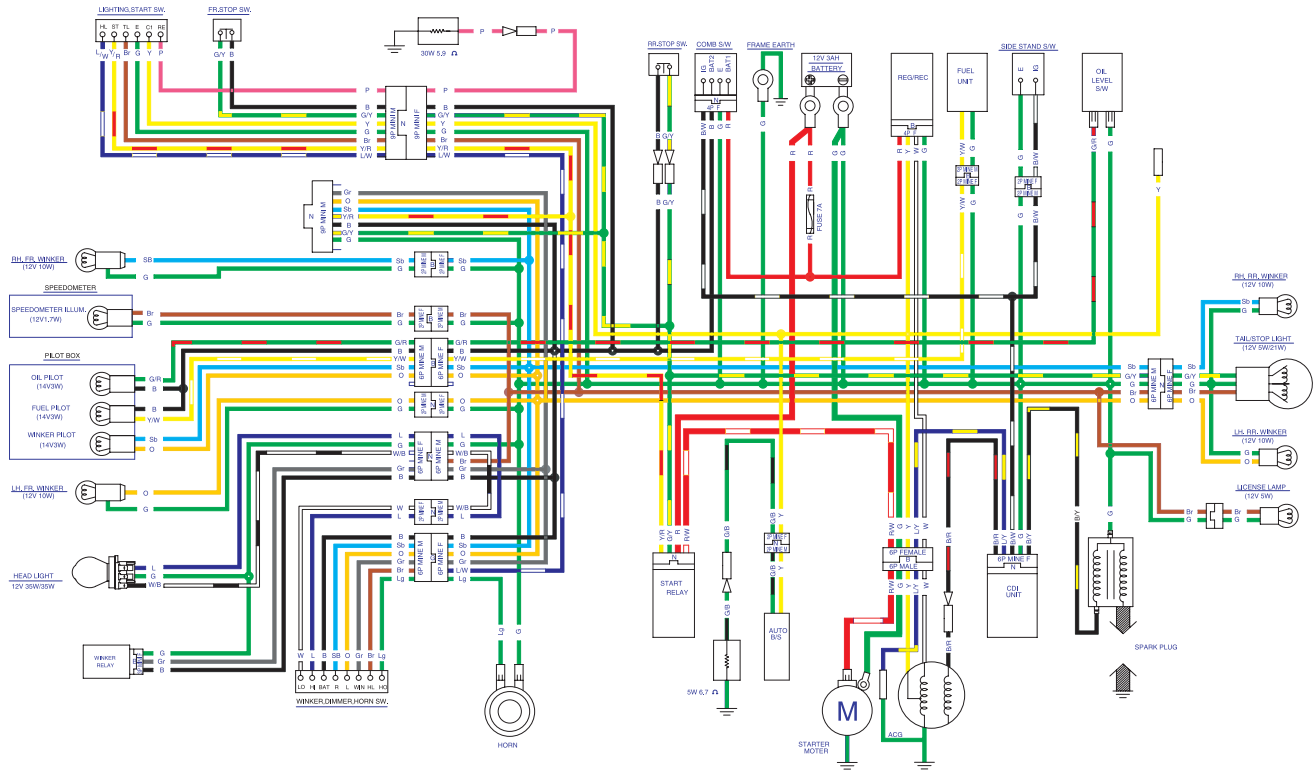

LIGHT SW



START SW



DIMMER SW



WINKER SW



SIDE STAND SW



HORN SW



COMB SW



| | | | |
|----------------------------|--------|----|-------------|
| B | BLACK | BR | BROWN |
| Y | YELLOW | DR | DRANGE |
| L | BLUE | SB | SKY BLUE |
| G | GREEN | LG | LIGHT GREEN |
| R | RED | P | PINK |
| W | WHITE | GR | GRAY |
| COLOR COMB. GROUND/MARKING | | | |

BATTERY SERVICE INSTRUCTIONS

ACTIVATING & INSTALLING YOUR BATTERY

Your new battery is supplied dry and charged. It must be activated with electrolyte for use. Do not fill electrolyte until you are ready to install and use the battery, as described below.

To Fill Electrolyte

To insure good battery performance and long life, a 10-hours' charge is needed after filling with acid.

- (1) Take off sealing tube on battery and fit an exhaust tube in an exhaust vent before filling with electrolyte.
- (2) Remove filling plugs and fill cells to UPPER LEVEL line with electrolyte (diluted sulphuric acid) having a specific gravity as follows:
Cold or Temperate Climate 1,280 at 20°C (68°F)
Tropical Climate 1,240 at 20°C (68°F)

When filling, the electrolyte temperature must be between 15°C (60°F) and 30°C (86°F).

To Charge Battery

Although battery is supplied charged for use, an initial charge is recommended after filling with electrolyte.

- (1) Before placing on charge, allow battery to stand for some time after filling. If electrolyte level has dropped after charging, add electrolyte until UPPER LEVEL is reached.
- (2) Note Serial Number on battery. The 3rd entry from the left indicates the stated battery capacity in Ampere Hours.
12 M ⑦ — 4B 12 M ⑩ — 3A

Charge the battery 3.5 hours at a current 1/10 of the stated battery capacity:
0.7 amps or 1.4 amps in the examples shown above.

- (3) After completion of charge, check to be sure that the electrolyte level is at the UPPER LEVEL. Add, if necessary.
- (4) Replace the filling plugs tightly, and wash off any electrolyte which may be on the outside of the battery. Battery is now ready for service.

To Install Battery

Fasten battery firmly to vehicle. Make sure positive and negative terminals are properly connected. Avoid crimp or fold in exhaust tube.

Check the Charge

Your battery is fully charged when (1) specific gravity of electrolyte of all cells rises above 1,280 and (2) all cells are gassing freely while on charge.

TIPS ON GOOD BATTERY MAINTENANCE

Check terminals, battery holder and electrolyte level periodically for any problems.

Correct, if required.

- (1) Add distilled water regularly. The electrolyte level must be kept above the LOWER LEVEL line. When it is below this line, refill with distilled water to the UPPER LEVEL line. Never use diluted sulphuric acid in lieu of water after the original charge. When adding water in cold weather, be sure water has mixed with the electrolyte to avoid freezing. Mixing will occur by running machine or charging battery.
- (2) Maintain battery in a charged condition. A dim head lamp or weak horn indicates an insufficiently charged battery. Remove the battery from the motorcycle and charge it at the proper rate until all cells gas freely and cell voltage and specific gravity remain constant.
- (3) Keep the outside of the battery, terminals and connections clean and dry.

OFF SERVICE MAINTENANCE

- (1) When not in use, keep the battery fully charged and the electrolyte level to UPPER LEVEL. The battery must be charged at least once a month in storage.
- (2) The battery should be stored in a dry, cool and constant temperature location, shielded from rain, dew and direct sunlight.

GENERAL INFORMATION

- (1) In operation, the battery should be secured correctly and firmly in the motorcycle.
- (2) Charge battery fully as soon as it becomes discharged.
- (3) Keep exhaust tube unclogged.
- (4) To keep electrolyte from freezing in the cold, keep the battery relatively warm and charged.
- (5) Disconnect the ground terminal if installed battery is to be left standing for a long time.
- (6) The battery should not be in contact with petroleum or vinyl chloride.

HOW TO MAINTAIN YOUR BATTERY

With minimal care, you can save money and have your battery ready when you are.

Just follow these simple rules.

- (1) Keep battery clean & filled.
- (2) Use only distilled water.
- (3) Keep terminals clean and coated with petroleum grease.
- (4) Keep terminal connections tight.
- (5) Charge battery regularly in riding season.

STORING YOUR BATTERY

- (1) Remove battery and bring it inside where warm.
- (2) Coat terminals with grease.
- (3) Maintain water level.
- (4) Check charge level regularly.
- (5) Maintain high charge during storage by recharging.

Remember, charging can reduce water level in cells, so check level from time to time.

POISON/DANGER CAUSES SEVERE BURNS

Contains sulfuric acid. Avoid contact with skin, eyes, or clothing. Antidote: EXTERNAL-Flush with water. INTERNAL-Drink large quantities water or milk. Follow with milk of magnesia, beaten egg or veg oil. Call physician immediately Eyes: Flush with water for 15 minutes and get prompt medical attention.

DANGER

Batteries produce explosive gases. Keep sparks, flame, cigarettes away. Ventilate when charging or using in enclosed space. Always shield eyes when working near batteries.

KEEP OUT OF REACH OF CHILDREN

 **DAELIM MOTOR CO.,LTD.**

MEMO :

.....

.....

.....

.....

.....

.....

.....

.....

.....

.....

.....

.....

.....

.....

.....

MEMO :

.....

.....

.....

.....

.....

.....

.....

.....

.....

.....

.....

.....

.....

.....

.....

a.FOUR OWNER'S MANUAL

3. 2005 PRINTED

3. 2005 PUBLICATION

NO COPY

 **DAELIM MOTOR CO.,LTD.**



■ **HEAD OFFICE (FACTORY)**

#58, SUNG SAN-DONG, CHANG WON, KYUNGNAM, KOREA

TEL : (82-55) 239-7000 / FAX : (82-2) 467-9997