

DAELIM

OWNER'S MANUAL

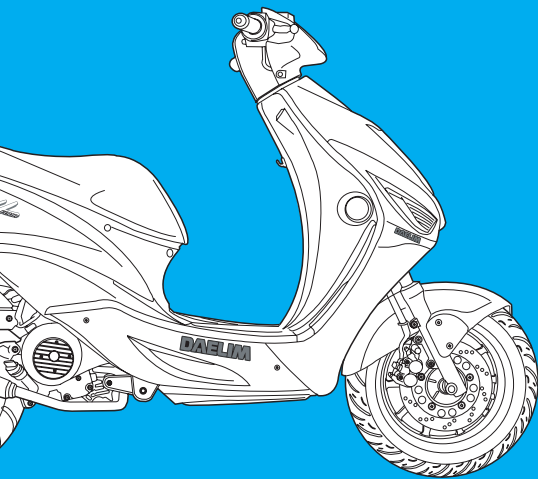

34
FOUR

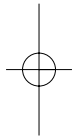

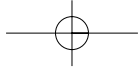

CONTENTS

IDENTIFICATION	3	EQUIPMENT USAGE	14
OPERATION INSTRUCTION	4	STEERING STEM LOCK	14
SAFETY PRECAUTIONS	4	SEAT LOCK	14
PRIOR TO STARTING VEHICLE	5	TRUNK	15
OPERATION	5	STORAGE AREA	15
CORRECT ATTIRE	6	BAG HOLDER	15
LOADING	7	OPERATION	16
ATTACHMENT	7	CORRECT DRIVING OPERATION	16
MODIFICATION	7	STARTING THE ENGINE	16
MUFFLER	7	AFTER STARTING ENGINE	18
CONTROLS LOCATION	8	PROPER DRIVING METHODS	19
Gauges	8	BRAKING	20
FUEL GAUGE	8	SELF INSPECTIONS BEFORE OPERATION	22
OIL PRESSURE GAUGE	8	INSPECTION OF CONCERNED AREA	22
WATER READING AND USAGE	10	REAR VIEW MIRROR	22
WATER METER	10	FUEL LEAK INSPECTION	22
IDENTIFICATION INFORMATION AND LOCATION	11	BRAKE INSPECTION	23
FRAME NUMBER, ENGINE NUMBER	11	FUEL CHECK	23
VIN PLATE LOCATION	11	TIRE INSPECTION	24
STARTING OPERATION	12	ENGINE OIL LEVEL CHECK	26
MAIN SWITCH	12	LIGHTS AND WINKER INSPECTION	26
START BUTTON	12	BULB REPLACEMENT METHOD	27
HEADLIGHT	13		
WINKER SWITCH	13		
HORN BUTTON	14		

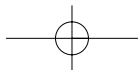
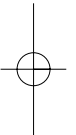

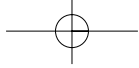

MAINTENANCE	29	SAFE DRIVING	43
MAINTENANCE SCHEDULE	30	DRIVING METHOD	44
MAINTENANCE PRECAUTIONS	32	DRIVING POSITION	44
THE ADJUSTMENT OF FREE PLAY OF REAR BRAKE LEVER	32	TAKING POSE OF FELLOW PASSENGER	45
CHECKING THE REAR BRAKE SHOE	32	PRECAUTION WHEN DRIVING	46
BRAKE HOSE, PIPE LEAKAGE, DAMAGE, ASSEMBLY STATE	34	STARTING	47
BRAKE PAD WEAR	34	TURNING METHOD	48
CHANGING ENGINE OIL	34	PRINCIPLE OF TURN	48
TRANSMISSION OIL INSPECTION	36	EFFECT OF SPEED	48
PARK PLUG	37	3 POSITIONS OF TURNING	49
BATTERY INSPECTION	38	TURNING METHOD	50
LUBE REPLACEMENT	39	PRECAUTION WHEN TURNING	51
AIR CLEANER ELEMENT INSPECTION	40	BRAKING METHOD	52
SIDE STAND INSPECTION	41	BASIC PRINCIPLE OF BRAKE(FRICTION FORCE)	52
FLEXIBLE RUBBER PART	41	RESTRAINT OF BRAKING EFFECT (INERTIA)	52
CLEANING	42	BRAKING METHOD	53
STORAGE	42	COMPARISON OF BRAKING DISTANCE	53
		IMPACT WHEN COLLISION	53
		WIRING DIAGRAM	54

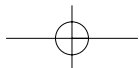
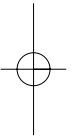

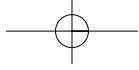

SPECIFICATION

ITEM	DATA	ITEM	DATA
LENGTH×WIDTH×HEIGHT(mm)	1,790×680×1,110	IGNITION SYSTEM	C.D.I
WHEEL BASE(mm)	1,265	BATTERY CAPACITY	12V6AH(MF TYPE)
SEAT HEIGHT(mm)	766	FUEL CAPACITY(l)	5.0
DRY WEIGHT(kgf)	88	RESERVE FUEL CAPACITY(l)	1.5
PASSENGER	2	TIRE SIZE	FR. 110 / 70 - 12, 47J
ENGINE TYPE	AIR COOLED 4 STROKE 2VALVE		RR. 120 / 70 - 12, 56J
PISTON DISPLACEMENT(cc)	49.6	SUSPENSION	FR. TELESCOPIC
BORE AND STROKE(mm)	39×41.5		RR. UNIT SWING OIL DAMPER
STARTING SYSTEM	START MOTOR / KICK	BRAKE	FR. DISK BRAKE
TRANSMISSION TYPE	CVT		RR. DRUM BRAKE
		SPARK PLUG	CR6HSA
		FUSE(A)	10

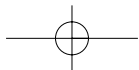
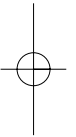

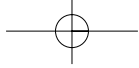

OPERATION INSTRUCTION

This manual describes matters pertaining to correct operation, safe operation and simple maintenance of the vehicle you are using.

To ensure more comfortable and safer operation, make sure to read this manual carefully prior to operation.

The photographs and drawings shown in this manual may differ from those of actual vehicles due to changes in vehicle specifications and modifications made.

This vehicle is designed for 2 riders including the operator.

CAUTION

Do not use polluted gasoline.

Using polluted gasoline will cause rust inside the fuel tank, and will close the supply of fuel to the carburetor, leading to an improper engine starting or may cause serious damage to an engine. Do not use polluted or low-grade oil.

Always use genuine oil to protect and extend vehicle performance and its life span.

If any failure occurs due to the use of polluted gasoline or oil, such failure will be excluded from being eligible for repairs under the warranty.

As far as any defect caused by contaminated gasoline or oil, the warranty will be automatically invalidated.

SAFETY PRECAUTIONS

- Careful driving and the wearing of proper attire and safety equipment are the most important factors in the safe operation of the scooter. Please obey traffic regulations and do not be hurried and careless.
- Many new vehicle owners operate their newly purchased vehicles with great care and attention to safety factors. However, after becoming accustomed to the operations are often discarded, which can lead to accidents. Please don't let this happen to you and always approach the operation of your vehicle with the safety considerations needed.

When operating the vehicle, always keep in mind and obey the notes of precaution printed on the "Safety Precaution Label" attached to the vehicle.

- Be sure to wear helmet at all time.
- Be sure to put on gloves at all time.
- Observe the speed regulations.
- Beware of muffler after driving as it is still hot to be burnt. Especially never children touch on it.
- For safety, do not change, alteration or modification the vehicle.
- Regularly conduct specified maintenance inspections.
 - <Maintenance Inspection Points>
 - Brakes, Tires, Oil, Lights, Horn, Instruments

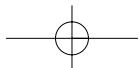

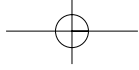

BEFORE STARTING VEHICLE

Read user's manual carefully.
Conduct maintenance checks prior to operation.
Always maintain vehicle in clean status and carry out specified maintenance checks.
Make sure to stop engine and stay away from fire when refueling.
Exhaust gas contains harmful substance such as carbon monoxide. Start engine in well-ventilated places.

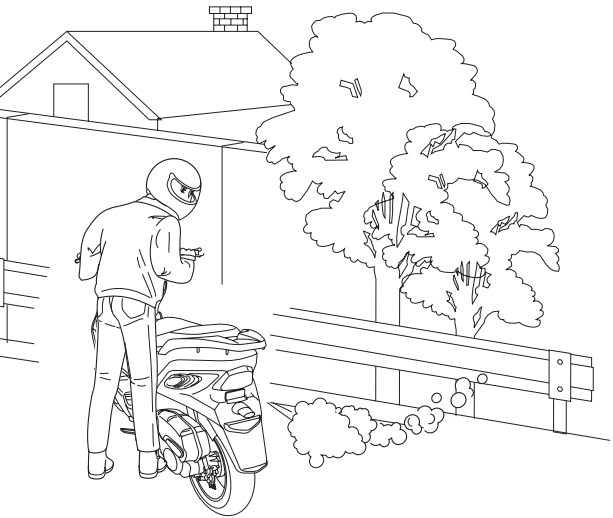

OPERATION

- Operators should naturally fix bodies to keep smooth driving.
- Please check whether or not you are unnaturally strained and strung up.
- Driving pose has a great influence on safe operation. Please always maintain the center of your body in the middle of seat. Especially do not sit at the rear seat because it may lessen the weight of front wheel and cause trembling steering wheel.
- A passenger should hold on to the vehicle or the operator with both hands and keep both feet on the pillion step bar.
- When wanting to turn, slightly lean to body toward the direction of the turn. It is unsafe if the body is not moved in union with the vehicle.
- Curvy roads and poor, unpaved roads constantly change in surface quality. Driving on these roads can be unsafe if certain safety precautions are not followed.
- In order to safely drive through these driving conditions, anticipate coming road conditions, slow down to at least half the normal speed, and relax your shoulders and wrists while securely holding the handles.

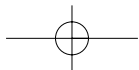
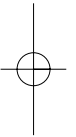

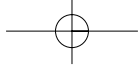

CORRECT ATTIRE

Always make sure to wear helmet for safety. Wear gloves and eye goggles.

Do not wear uniforms which might hinder operation. It is dangerous if the uniform is caught by brake lever or by the rotating part of drive chain.

Many automobile/motorcycle accidents happen because the automobile driver does not "see" the motorcyclist.

Make yourself conspicuous to help avoid the accident that isn't your fault :

Wear bright or reflective clothing.

Don't ride in another motorist's "blind spot".

WARNING

Be sure you and your passenger always wear a helmet, eye protection and other protective apparel when you ride.

Not wearing a helmet increases the chance of serious injury or death in a crash.

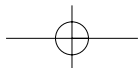
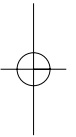
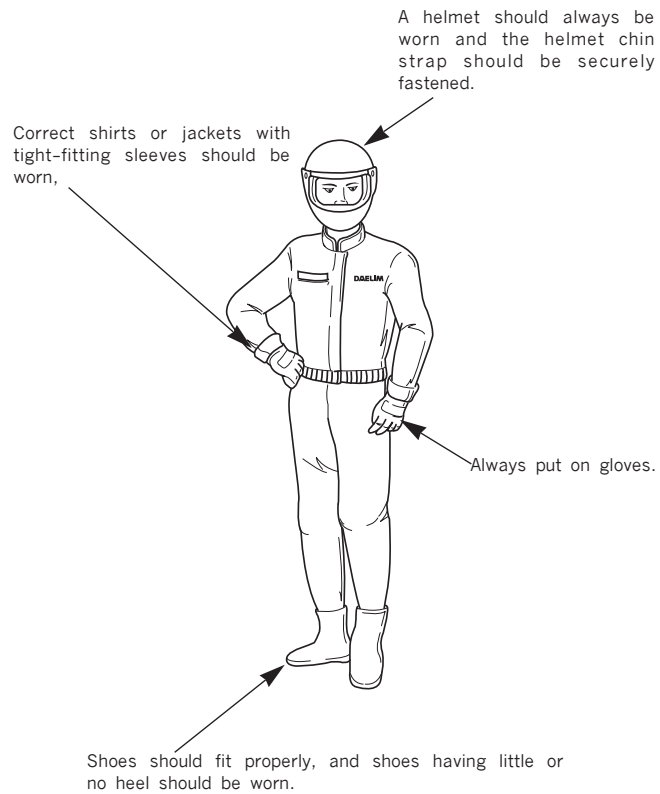

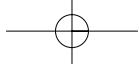

CARGO

When carrying cargo, you must keep in mind that operating the motorcycle, especially when turning, will be different. Be sure not to overload the motorcycle with goods as this will make the motorcycle unstable during operation.

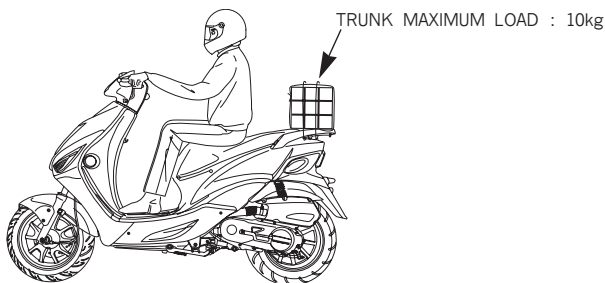

⚠ WARNING

Overloading or improper loading can cause a crash and you can be seriously hurt. Follow all load limits in this manual.

ATTACHMENT

Except designated attachment by DAELIM MOTOR CO., LTD., don't attach any extra lighting device, because it may cause an early discharging of battery.

MODIFICATION

- Modification of vehicle structure or function deteriorates manipulability or causes exhaust noise to become louder shortening the vehicle life. These modifications are not only prohibited by law but also are the acts harmful to other people. Modifications are not covered by warranty.

MUFFLER

- Pay particular attention to fellow passenger so that he/she can prevent getting burnt by the hot muffler during travel.

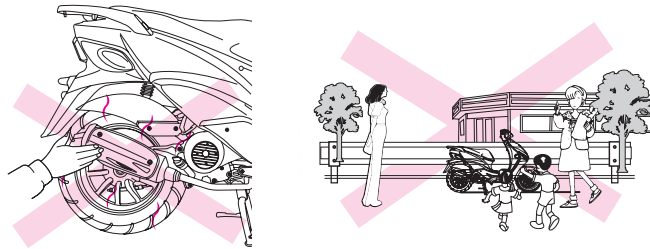

⚠ CAUTION

- Beware of muffler after driving as it is still hot to be burnt. Especially never children touch on it. And pay attention to park where pedestrian zone.
- If haystack or vinyl is stuck to the muffler, it might be fired.

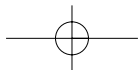

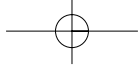

PARTS LOCATION

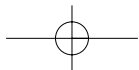
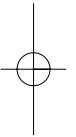
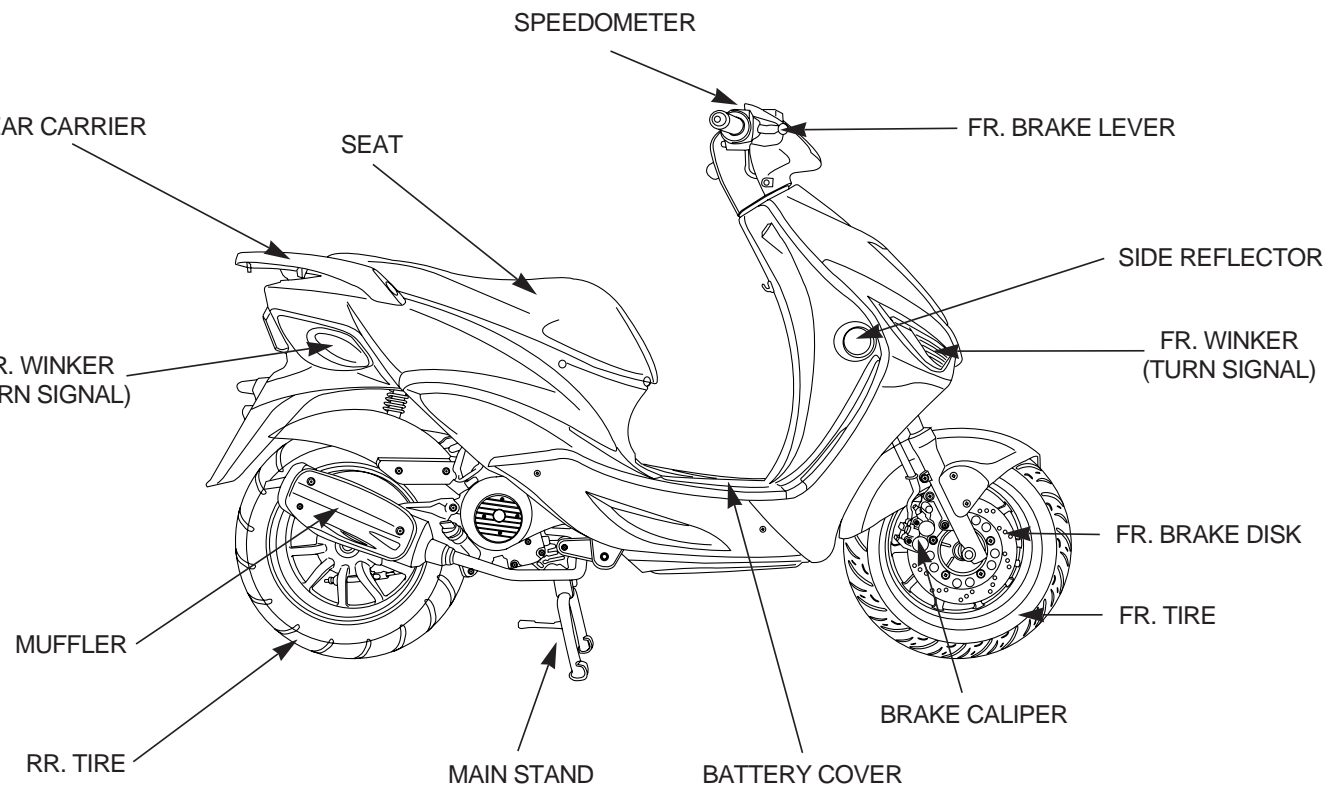

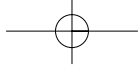

TS LOCATION

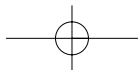
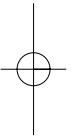
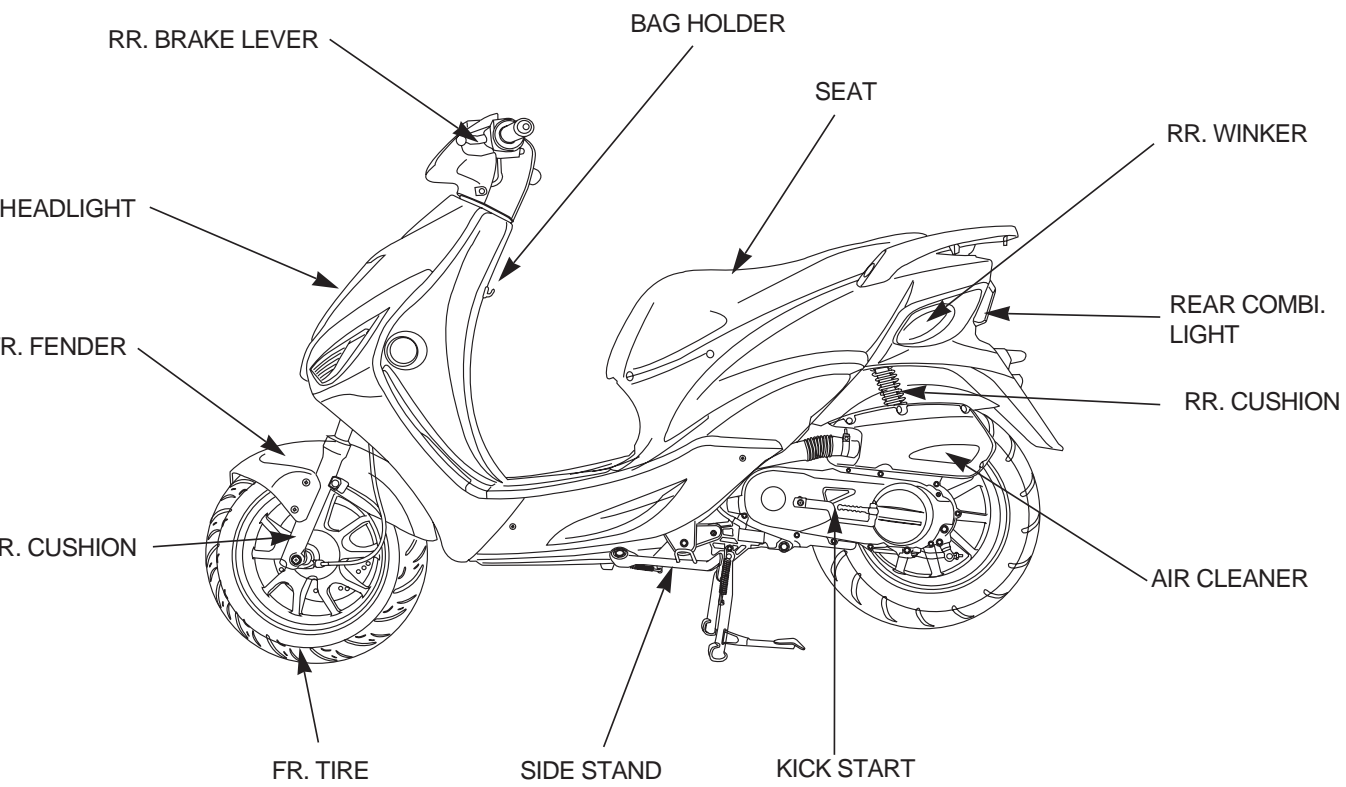

INSTRUMENT CLUSTER READING AND USAGE

WINKER INDICATOR

SPEEDOMETER>

Indicates driving speed. Maintain legal speed limits to ensure safe operation.

ODOMETER>

Indicates total distance in kilometers traveled by the vehicle.

FUEL METER>

Fuel meter indicates the gasoline level in the fuel tank.

Gasoline should be put in the fuel tank as soon as possible if the needle is resting in the red area.

FUEL TANK MAXIMUM CAPACITY : 5.0

RESERVE CAPACITY : 1.5

WINKER INDICATOR>

When the winker switch is operated, the winker indicator flashes in unison with the flashing of the turn signals.

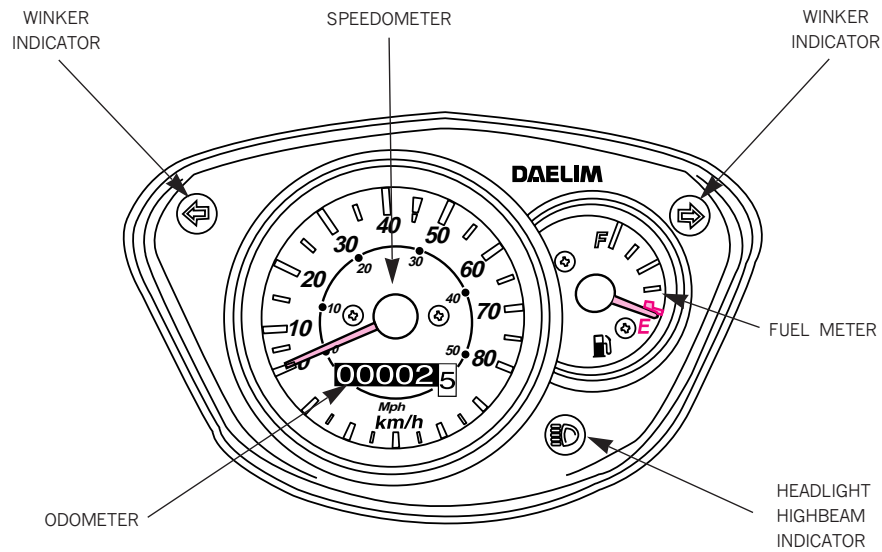

⚠ WARNING

To avoid running out of fuel, it might cause severe injury due to engine abruptly stop.

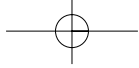

INFORMATION AND LOCATION

FRAME NUMBER, ENGINE NUMBER

The frame number, engine number are needed when registering your motorcycle.

They may also be required by your dealer when ordering replacement parts. Record the numbers along with the vehicle license plate number and keep them separately from the vehicle.

<FRAME NUMBER>

The frame number is stamped on the front part of the frame.

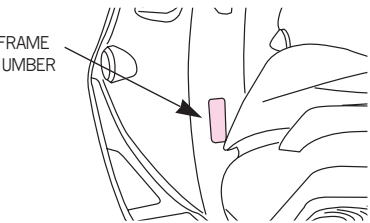

<ENGINE NUMBER>

The engine number is stamped on the lower part of the left crankcase.

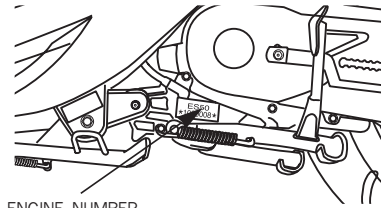

VIN PLATE LOCATION

VIN plate is located on the left engine hanger plate.

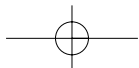
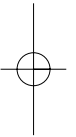
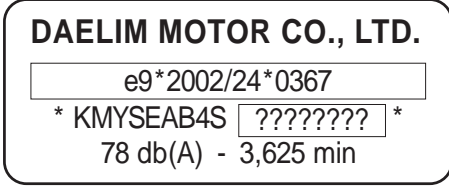
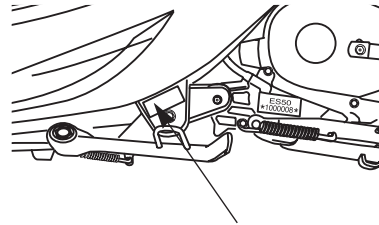

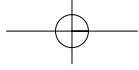

START SWITCH OPERATION

MAIN SWITCH

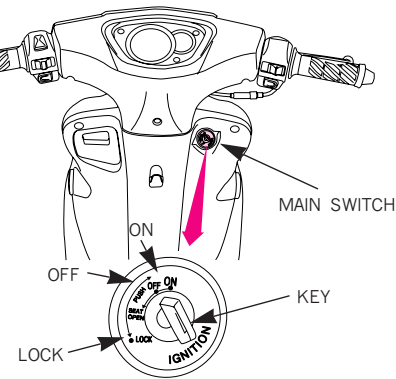

1. ON.... Starts engine. Key can not be pulled out.
2. OFF....Stops engine. Key can be placed in or taken out of the main switch.
3. LOCK....Locks handle bars. Key can be placed in or taken out of the main switch.
4. OPEN....When seat lock is released, key returns to its original position(OFF). Key can be placed in or taken out of the main switch.

CAUTION

- When you park the vehicle and leave it, please lock handle bars and take out the key.
- Rotate key smoothly without pressing to turn to OPEN.
- The headlight will be on automatically. when the key is on, so do not remove this electric circuit otherwise, it may cause severe injury when driving in the night.

START BUTTON

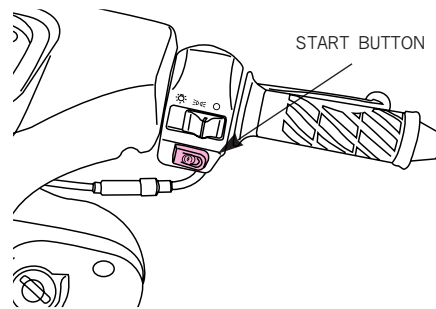

The engine is started pressing this button when pressed in a state where the main switch key is placed to an ON position and the brake lever is pulled.

CAUTION

- The engine will not start if the brake lever is not pulled.
- Do not hold the brake lever and the throttle grip when the engine was started. It may damage the engine.

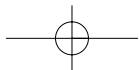

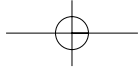

HEADLIGHT

TURNING ON HEADLIGHT

Turn the main switch key in "ON" position and turn the headlight switch.

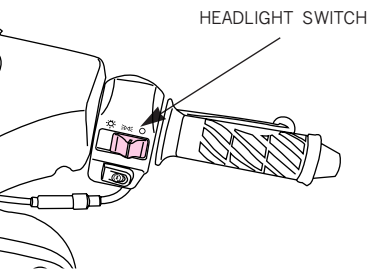

SWITCH POSITION	FUNCTION
(H)	Headlight, taillight, position lamp and meter lights on.
(P)	Position lamp, taillight, and meter lights on.
(OFF)	Light turned off.

<DIMMER SWITCH>

High beam or low beam can be operated by the use of dimmer switch.

HIGH BEAM

 (HI) use when needing extra light.

LOW BEAM

 (LO) use when other vehicles are present, in the city, etc.

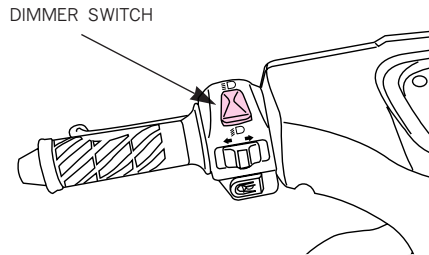

CAUTION

- Use the high beam only in the suburban road or when the usage of the high beam not hinder the safe driving of the car ahead.

WINKER SWITCH

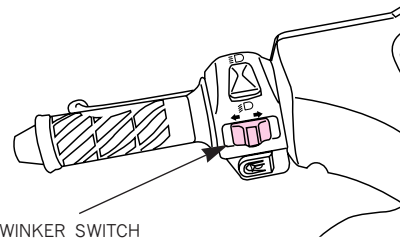

If this switch is turned on when the main switch is in an ON position, the winker will operate.

- ⇒ (R)....used when making a right turn.
- ⇐ (L)....used when making a left turn.

CAUTION

- The winker switch does not automatically turn back to its original position after completing the turn.
- Please set the switch back to its center position after turning.

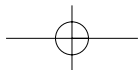
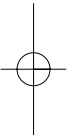

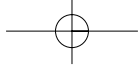

EQUIPMENT USAGE

HORN BUTTON

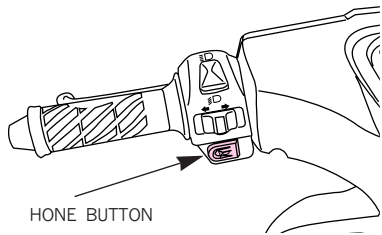

Horn is sounded if the horn button is pressed when the main switch is in an ON position.

STEERING STEM LOCK

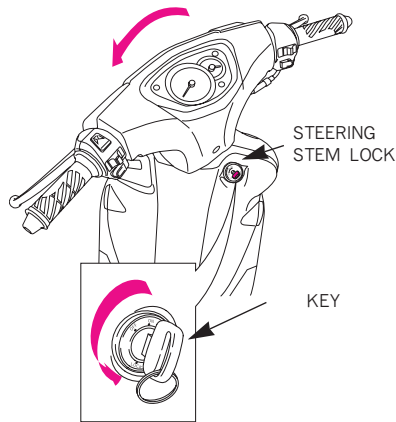

<LOCKING>

To lock the steering, turn the handlebars all the way to the left, turn the key to LOCK while pushing in. Remove the key.

<UNLOCKING>

To unlock the steering, turn the key to the OFF position.

⚠ WARNING

- Do not turn the key to LOCK while riding the vehicle; loss of vehicle control will result.

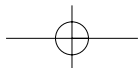

SEAT LOCK

<LOCKING>

The seat automatically locks when the seat is pushed in its downward position. Lightly pull upward on the seat to make sure the seat has been properly locked.

<UNLOCKING>

Turn the main switch key from OFF to OPEN to open the seat.

⚠ CAUTION

- As the seat automatically locks, take special care not to accidentally leave the key in the trunk.
- Make sure that the seat is securely locked after closing the seat.

Driving with unlocked seat lock may cause danger.

- When the seat lock is out of order, do not operate it further and inspect it in the closest authorized repair center.

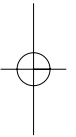

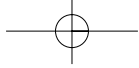

TRUNK

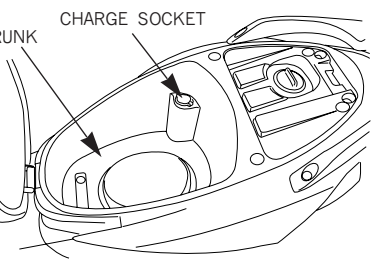

There is a trunk under the seat. The seat is opened to gain access to the trunk by using the main switch key on the seat lock.

TRUNK MAXIMUM LOAD:10kg

CAUTION

The temperature inside the trunk rises due to heat from the engine. Do not place foodstuffs and other articles that can be damaged easily by heat. Also do not place flammable materials in the trunk. Do not place valuable or fragile goods in trunk.

STORAGE AREA

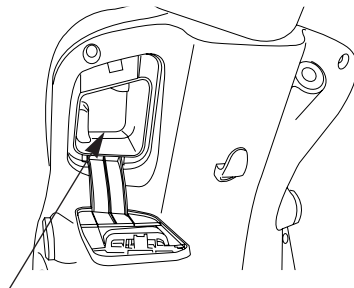

STORAGE AREA

- Store small notebook and stuffs in this area.

CAUTION

- As water can enter the trunk when washing, make sure to remove articles that can be damaged by water.

BAG HOLDER

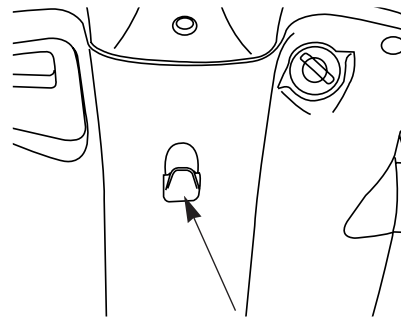

BAG HOLDER

- For ease in carrying bags and similar items, they should be hung from the bag holder which is fitted for this purpose.
- When using the bag holder, place it in the open position and return it to the normal position when not in use.

CAUTION

- Do not attempt to carry very heavy or bulky loads since this would affect the stability and steering characteristics of the scooter.

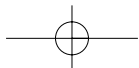
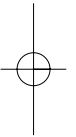

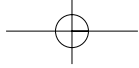

OPERATION

RECT DRIVING OPERATION

Make sure to check the oil, gasoline, and water level, before starting the engine. Please ensure that the main stand is in a down position when starting the engine.

CAUTION

Make sure that the rear wheel is locked when starting the engine to prevent an unexpected quick start of the vehicle. Locking is not possible if the rear wheel brake is not adjusted correctly.

Drive with care for both safety reasons and longer vehicle life. For 1 month (or 1,000km) after purchasing the vehicle, drive moderately avoiding fast starts and fast acceleration

STARTING THE ENGINE

WARNING

- Never run the engine in an enclosed area. The exhaust contains poisonous carbon monoxide gas that can cause loss of consciousness and lead to death.

1 Lock the rear wheel.

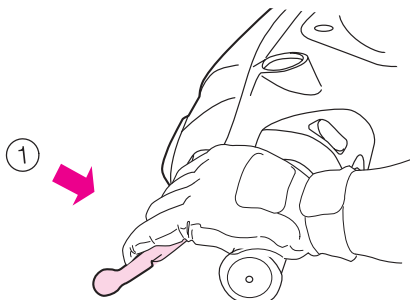

2 Turn the main switch to an ON position.

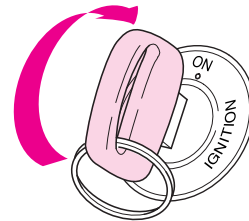

3 Press the starter button without rotating the starter grip (opening the throttle).

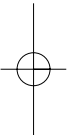
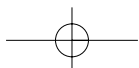
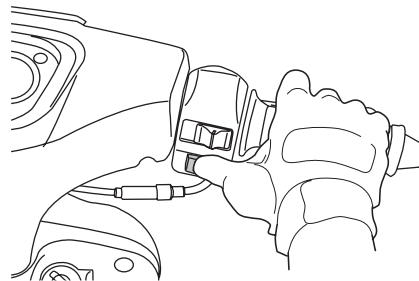

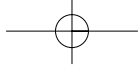

When the engine is hot and does not start after pressing the starter button for 3~4 seconds, rotate the throttle grip to approximately 1/4 of a rotation and try again. This will allow easy starting.

CAUTION

Immediately release the starter button as soon as the vehicle has started. Do not press the starter button when the engine is running.

This can damage the starting motor.

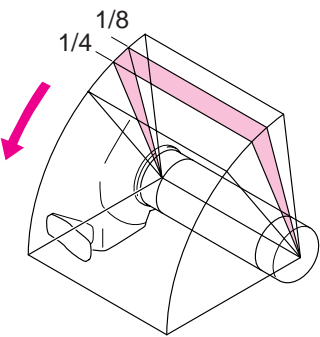

- It is possible that starting will be more difficult if the vehicle has not been used for a long period of time or if the fuel hole is plugged up (starting problems even when there is sufficient fuel in the fuel tank may be an indication of a plugged fuel hole).

When this happens, do not rotate the throttle grip and try the starter button a few times.

CAUTION

- Do not keep the starter button pressed for more than 5 seconds at a time. Release the starter button for approximately 10 seconds before pressing it again.

- 4 When the engine is cold morning or winter or the vehicle has not been used for a long period of time, let the engine idle for a short period allow the engine to warm up.

CAUTION

- Keep holding rear brake until start.
- Exhaust has contains harmful substance such as carbon monoxide.

Start engine in well-ventilated places.

<IF ENGINE CANNOT BE STARTED>

If engine cannot be started or vehicle does not move, check the followings.

- Is there fuel in fuel tank?
- Are you operating in accordance with the instructions given in owner's manual?
- Is fuse not cut?
- Is starter motor running?
- If starter motor is not running due to battery consumption, try starting motor by using kick start technique.

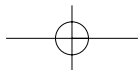

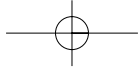

AFTER STARTING ENGINE

Hold the main stand.

Push the vehicle forward to fold the main stand and make sure that the brake lever does not become released during the operation.

2 Get on the vehicle.

- Mounting should be done from the left side, and you should sit squarely on the seat. Leave either one foot or both feet planted on the ground

3 Release the squeezing tension on the rear brake lever and slowly begin to rotate the throttle grip to allow for a slow and easy start.

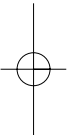
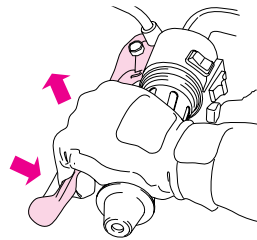
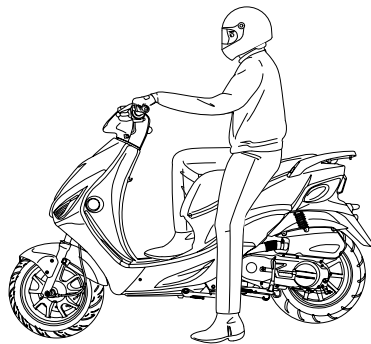
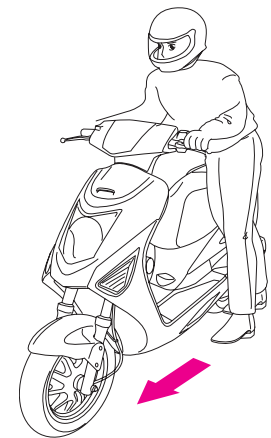

CAUTION

Do not excessively open the throttle until you actually start the driving operation of the vehicle.

CAUTION

- Keep holding rear brake lever before starting.

CAUTION

- A quick rotating of the throttle grip will cause the vehicle to move suddenly forward.
- If the engine RPM isn't decreased after the throttle grip return to its original position, stop operating and inspect it in the closest authorized repair center.

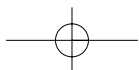

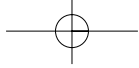

OPER DRIVING METHODS

Before entering traffic, use the correct signal to forward other drivers of your intentions.

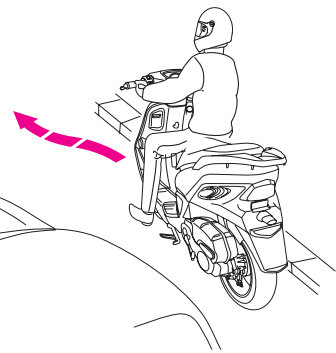

Speed is controlled by the operation of the throttle grip.

- If the throttle grip is rotated.....
The speed of the vehicle increases. Please rotate the throttle grip slowly. When climbing a hill, the throttle grip need to be rotated further to give the vehicle more power.
- If the throttle grip is allowed to rotate back.....
Speed decreases. This can be done slowly or quickly, depending on how quickly you need to decelerate.

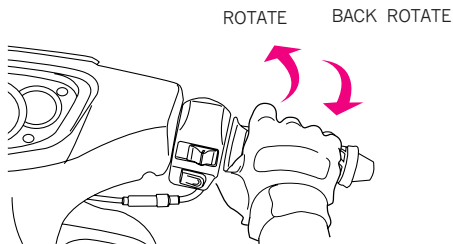

Work the front and rear brakes together.

- Allow the throttle grip to rotate back to its beginning position and then squeeze the brake levers.
- It is best to operate the brakes by first lightly squeezing the brake levers and then changing to a more firm squeeze.

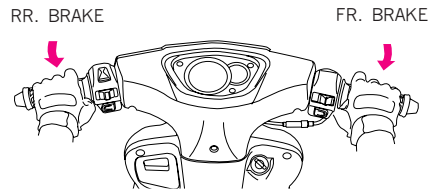

CAUTION

- If only one of the brakes is used, it is possible for the vehicle to experience sliding.

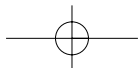

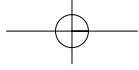

brakes should never be suddenly
ied and the handle bars should
r be suddenly turned.

dden braking or turning can cause the
nicle to slide and tip over.

is especially dangerous to perform
dden braking on wet roads or in rainy
ather as the tires can lose traction
d slip easily.

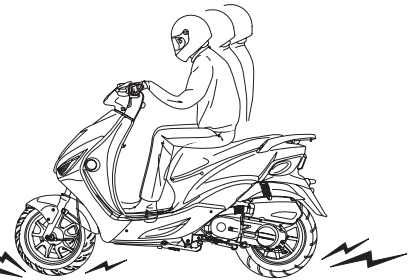

**Special care in driving should be
taken during rainy weather.**

- More braking distance is needed when driving on wet roads or in the rain. Reduce speed and be sure to initiate the braking operation sooner than when driving in normal conditions.
- On downgrades, allow the throttle grip to rotate back to its initial position to reduce speed, and apply the brakes and drive slowly down the hill.
- It is possible for the brakes to temporarily lose operative ability after driving through a puddle or when driving in the rain. To ensure that the brakes are operating properly, slow down(after checking for other vehicles) and while driving slowly, lightly apply the brakes to rid the brakes of any excess water and to dry them.
- Be extremely careful when driving in the snow or on icy roads. When driving in these conditions, both the tires lose much of their traction and the rear tire can slip when opening the throttle.

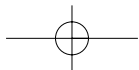

BRAKING

1 When approaching the desired stopping area.

- Activate the proper winker, and after checking for other vehicles, slowly turn into the area in which you want to stop.
- Allow the throttle grip to rotate completely back and apply the front and rear brakes. The brake light will shine to alert vehicles in back of you that you are stopping.

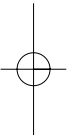
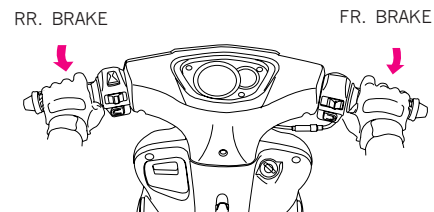

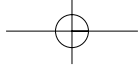

After the vehicle has come to a complete stop.

Turn the winker switch to the center position and turn the main switch to OFF. This will turn the engine off.

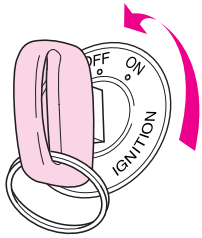

CAUTION

Do not rotate the main switch key while driving. If the main switch is turned to an OFF or LOCK position, the electrical system will not operate. Operating the main switch key while driving can be very hazardous. Only turn the main switch key to OFF or LOCK position after completing stopping the vehicle.

3 Dismount on the left side and lower the main stand on a flat surface.

- Be sure to park in an area that is free of traffic. Also, the vehicle can tip over if the main stand is not placed on a stable and flat surface.
- The main stand is lowered by grasping the handle bars with the left hand, holding the rear carrier with the right hand, and stepping firmly on the stand with the right foot. In this position, lift the rear carrier upward, which will secure the main stand.

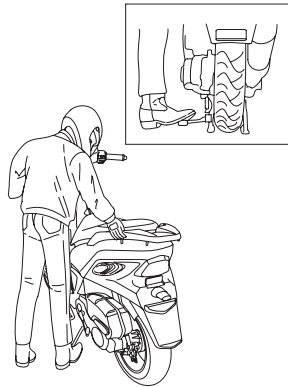

4 To prevent theft, be sure to lock the steering when parking.

CAUTION

- Park in a safe area that will not block traffic. When you parked the vehicle after driving, make sure foot the vehicle beyond man's reach because engine and muffler are still hot.
- Park the motorcycle on firm, level ground to prevent it from falling over.
- If you must park on a slight incline, aim the front of the motorcycle uphill to reduce the possibility of rolling off the side stand or overturning.

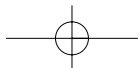
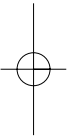

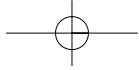

INSPECTIONS BEFORE OPERATION

Inspect the vehicle and have regular maintenance inspections for increased safety and the prevention of accidents. Regular maintenance inspections should be performed even if the vehicle has not been used for a long period of time.

Inspections before operation should be performed on a daily basis prior to starting the vehicle.

Inspections of concerned Area

- Brake inspection
- Tire inspection
- Fuel check
- Engine oil check
- Lights and winker inspection
- Rear view mirror inspection
- Fuel leak inspection
- License plate inspection
- Throttle grip inspection.

CAUTION

- Observe safety rules when conducting inspections.
- Exhaust gas contains harmful substance such as carbon mono-oxide. Do not carry out inspections on vehicle in closed places, or in poorly ventilated places, with engine running.
- Conduct inspections on flat, solid ground with the stand erected.
- Be careful of burns when conducting inspections immediately after engine is stopped because the engine and muffler are hot.
- Stop engine and remove the key prior to the vehicle maintenance service.
- Use appropriate types of tools.
- If you are unable to correct trouble even after you make adjustment or correction, contact authorized maintenance shops, dealers or designated repair shops for necessary inspection and repairs.

INSPECTION OF CONCERNED AREA

- Check areas which caused for concern when last operating the vehicle.
- If happened, contact authorized maintenance shops for necessary inspection and repairs.

REAR VIEW MIRROR

Check the objects at the back are well noticed when seating on a driver's seat, and also mirror for damage or contamination.

FUEL LEAK INSPECTION

Check there is no gasoline leakage from fuel tank, hoses, carburetor, etc.

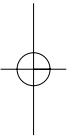
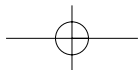

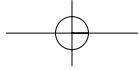

BRAKE INSPECTION

<BRAKE LEVER FREE PLAY>

Correctly squeeze the brake levers until resistance is felt to check for an appropriate amount of free play. No free play in the brake levers or overly loose brake levers are indication of a problem in the brake system.

BRAKE LEVER FREE PLAY: 10~20mm

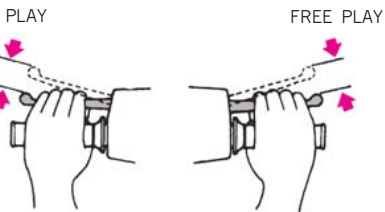

CAUTION

Specified brake lever free play must be maintained. Excessive free play may cause long stopping distance, brake operational fault and slow reacting time resulting in the dangerous situation and insufficient free play may cause short stopping distance and damage brake system(pad, lining, etc.)

<CHECK OF BRAKE FLUID>

This is checked by placing the vehicle on its main stand on a flat surface. Make sure that the handle bars are at a horizontal level. Check to see if the fluid is below the LOWER level.

If brake fluid is significantly low, this may indicate that there is leakage in the brake system. Inspect the brake hose to check for leaks.

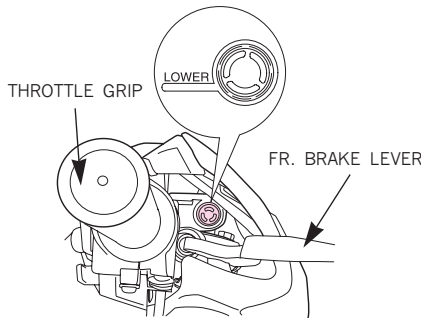

CAUTION

- If the brake fluid is significantly lower than the specified level, inspect not only brake fluid but also check the front brake pad for wear.

FUEL CHECK

<CHECK>

Check gasoline to see if there is a sufficient amount of gasoline to reach your destination.

- Place the main switch to "ON" position.
- If the fuel meter needle indicates E mark (red portion), fill fuel tank with gasoline as soon as possible.

Reserve fuel capacity : 1.5 l

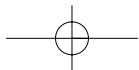
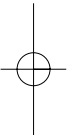
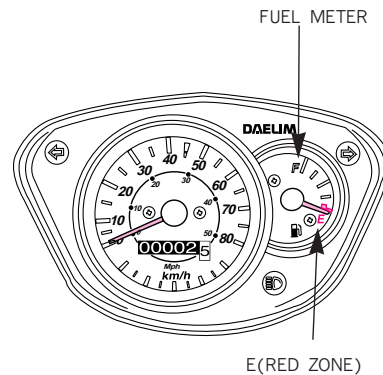

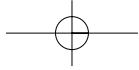

<FUELING>

Turn the key cover on fuel tank cap, and turn the key clockwise to remove the cap. Fill the tank with gasoline until it reaches the bottom of the level plate. Press the cap firmly, and pull out the key.

FUEL TANK CAP

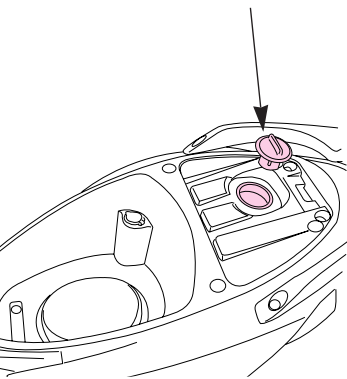

Maximum Capacity : 5.0 l

CAUTION

- Gasoline is extremely flammable and it is explosive under certain conditions.
 - Make sure to stop engine and stay away from fire when refueling.
 - Do not smoke or allow flames or sparks in the area where gasoline is stored or where the fuel tank is refueled.
 - Don't fill low grade gasoline. Using it can cause damage (bending, getting worn, etc.) to combustion chamber and parts of fuel.
 - Do not overfill the tank.
 - After refueling, make sure the fuel cap is closed securely.
 - Avoid repeated or prolonged contact with skin or breathing of vapor.
- KEEP OUT OF REACH OF CHILDREN.

TIRE INSPECTION

<AIR PRESSURE CHECK>

Check for an appropriate level of air pressure by examining how the tire sits on the ground. If you notice any abnormalities in the shape of the tire with regard to the area contacting the ground, use a tire gauge to check tire pressure and adjust the tire pressure to the appropriate level.

SIZE	FRONT	110/70-12, 47J	
	REAR	120/70-12, 56J	
TIRE PRESSURE (kgf/cm ²)	WITH ONE PERSON	FRONT	1.75
		REAR	2.00
	WITH TWO PERSON	FRONT	1.75
		REAR	2.25

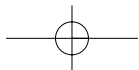

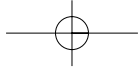

<CRACKS/DAMAGE>

Check tire tread and sides for cracks and damage.

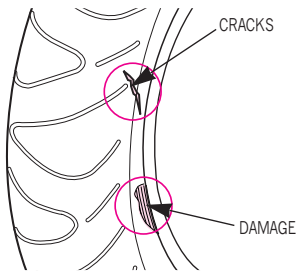

<FOREIGN MATERIALS>

Check tire tread and sides for nails, rocks, etc. That might have become wedged in the tire.

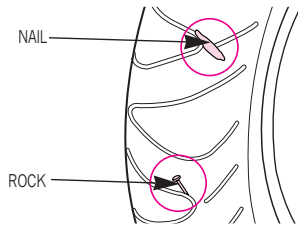

<TREAD DEPTH>

- Check the wear indicator (wear limit marking) to see if there is an insufficient amount of tread remaining.
- If the indicators are visible, replace tire with a new one.

<NORMAL WEAR>

Check tire tread for signs of abnormal wear.

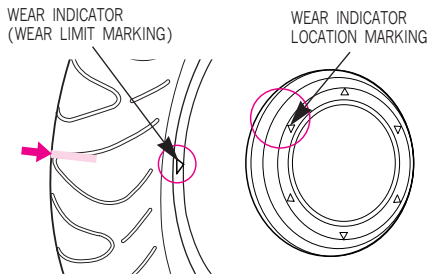
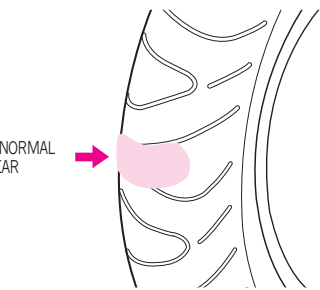

⚠ CAUTION

- If air pressure is inadequate or if there are cracks, damage or abnormal wear on tires, it may cause severe injury due to trembling steering wheel and flat tire.
- Insufficient air pressure may cause the heavy steering wheel making handling difficult, fuel over consumption and the excessive wear of tire outer area and excessive air pressure may cause easier wheel handling and lower fuel consumption. But it may also cause the excessive wear of tire center area.
- This vehicle is equipped with tubeless tires so, if you replace the tire, you should replace the tire with tubeless tire, and If you have flat tires, please contact authorised maintenance shops for inspection.

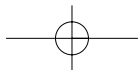
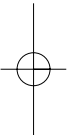

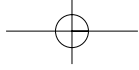

ENGINE OIL LEVEL CHECK

Check the engine oil level each day before starting the motorcycle.

The oil level must be maintained between the upper and lower level marks on the oil level gauge.

Place the motorcycle on the main stand on level ground.

Start the engine and let it idle for approximately 2~3 minutes.

Check the engine oil level.

If necessary, add the specified oil. Do not overfill.

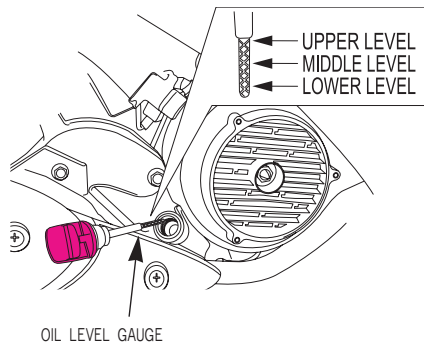

CAUTION

- Running the engine with insufficient oil pressure may cause serious engine damage.

LIGHTS AND WINKER INSPECTION

<HEAD-LIGHT, TAIL-LIGHT>

Turn the main switch "ON". Check the lamp for proper operation by operating the switch and also a lens for damage or contamination.

CAUTION

- The lighting head light emits very hot heat. If you touch with naked hand, it may be burned.
- When replacing head light lamp, stop lamp and winker lamp, use only a bulb of rated capacity. Using a lamp exceeding the rated capacity can cause over-discharge of battery and wire burning. It can lead a fire.
- If the head light is turned off due to aging while driving at night, it will cause an accident by obstructing driver's view. Check the condition daily.
- If the tail light is off while driving at night, it will cause an accident by failure of notice by the other drivers. Check the condition daily.

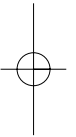
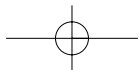

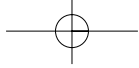

INSPECTION OF WINKER>

Turn the main switch "ON". Check the lamp for proper operation (front/rear and left/right) and sound by operating the winker, and also a lens for damage or contamination.

INSPECTION OF STOP LAMP>

Turn the main switch "ON". Check a stop lamp for proper operation by operating the front wheel and the rear wheel brakes, and a lens for damage or contamination.

BULB REPLACEMENT METHOD

- Be sure to turn a main switch "OFF" prior to replacement of a bulb.
- Use only a bulb of rated capacity.
- After replacement with new bulb, check for proper operation.

CAUTION

- Care is to be taken to avoid leaving fingerprints on a headlight bulb. Failing to observe this may cause early damage of the headlight bulb resulted from concentration of heat.
- Be sure to wear clean gloves when replacing a bulb. If touched to it with bare hands, clean it with a cloth soaked with alcohol to prevent from early damage.

<HEADLIGHT LAMP>

- (1) Loosen 4 washer screws and remove the headlight.
- (2) Press the socket spring, turn counter clockwise.
- (3) Remove the headlight bulb.
- (4) Replace the bulb with new one install in the reverse order of removal.

HEADLIGHT BULB : 12V 35/35W

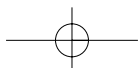
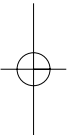
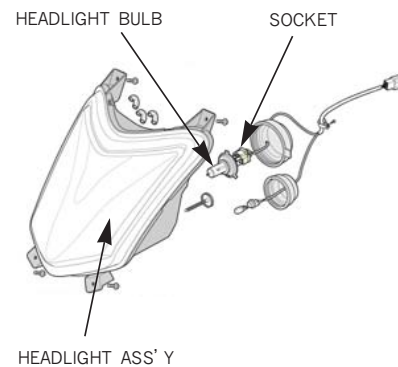

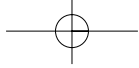

<TAIL/STOP LIGHT BULB>

Loosen 2 tapping screws to disassemble tail light lens.

Press a bulb with a light force and rotate it to counterclockwise to disassemble it.

Replace it with new bulb. Apply reverse order of disassembly for assembly.

TAIL/STOP LIGHT BULB : 12V 21/5W

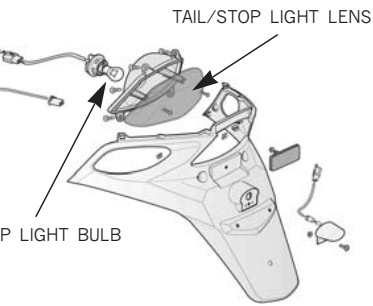

<WINKER BULB>

Front Winker Bulb

(1) Press a bulb with a light force and rotate it to counterclockwise to disassemble it.

(2) Replace it with new bulb. Apply reverse order of disassembly for assembly.

FRONT WINKER BULB: 12V 10W

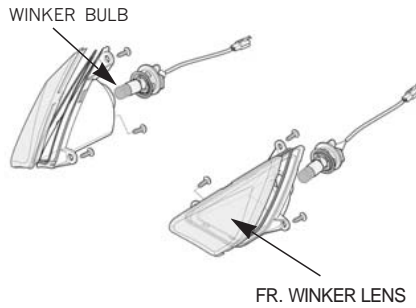

Rear Winker Bulb

(1) Loosen two tapping screws to disassemble a tail light lens and a winker lens.

(2) Press a bulb with a light force and rotate it to counterclockwise to disassemble it.

(3) Replace it with new bulb. Apply reverse order of disassembly for assembly.

REAR WINKER BULB: 12V 10W

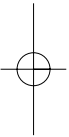
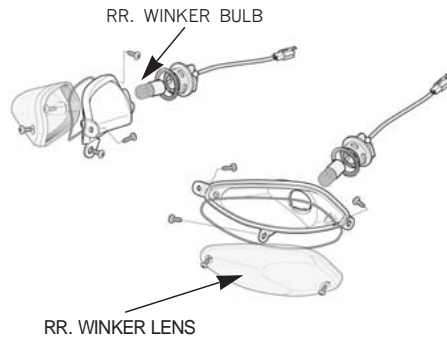

CAUTION
When disassembling, care is to be taken for ensuring that a tail light lens can not be damaged.
When replacing a tail light lens, be sure to assemble lens seal securely.

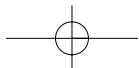

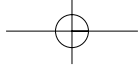

MAINTENANCE

The Required Maintenance Schedule specifies how often you should have your motorcycle served, and what things need attention. It is essential that your motorcycle be served as scheduled to retain its high level of safety, dependability, and emission control performance.

These instructions are based on the assumption that the motorcycle will be used exclusively for its designed purpose. Sustained high speed operation, or operation in unusually wet or dusty conditions, will require more frequent service than specified in the MAINTENANCE SCHEDULE.

Consult your authorized Daelim dealer for recommendations applicable to your individual needs and use.

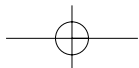
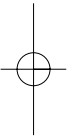

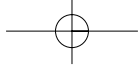

MAINTENANCE SCHEDULE

Perform the Self Inspections Before Operation at each scheduled maintenance period.
 INSPECT AND, CLEAN, ADJUST, LUBRICATE OR REPLACE IF NECESSARY
 REPLACE L: LUBRICATE C: CLEAN

ITEM	FREQUENCY	ODOMETER READING(NOTE1)					REMARK	
		× 1,000Km	1	4	8	12		16
		MONTH	1	6	12	18		24
★ FUEL LINE			I	I	I	I	I	
★ FUEL FILTER			R	R	R	R	R	
★ THROTTLE GRIP OPERATION			I	I	I	I	I	
AIR CLEANER ELEMENT				C	C	C	C	Check frequently if there is moisture or dust.
SPARK PLUG			I	I	I	I	I	If necessary, replace it
★ CARBURETOR IDLE			I	I	I	I	I	
ENGINE OIL			R	R	R	R	R	If depends on driving mode.
OIL FILTER SCREEN			C	C	C	C	C	
TRANSMISSION OIL			I		I		R	
★ BRAKE FLUID			I	I	I	I	I	
VALVE CLEARANCE			I	I	I	I	I	

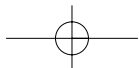
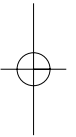

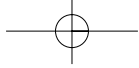

ITEM	FREQUENCY	ODOMETER READING(NOTE 1)					REMARK	
		× 1,000Km	1	4	8	12		16
		MONTH	1	6	12	18		24
	BRAKE SHOE / PAD WEAR		I	I	I	I	I	
	BRAKE SYSTEM		I	I	I	I	I	Master cylinder, Caliper
★	BRAKE STOP SWITCH		I	I	I	I	I	
★	HEADLIGHT ADJUSTMENT		I	I	I	I	I	
★	SUSPENSION			I	I	I	I	
★	BOLTS, NUTS, FASTENERS		I	I	I	I	I	
★	WHEELS / TIRES		I	I	I	I	I	
★	STEERING		I	I	I	I	I	
★	DRIVE BELT			I	I	I	I	
★	WEIGHT ROLLER			I	I	I	I	
★	SLIDE PIECE			I	I	I	I	
★	MOVABLE DRIVE FACE GREASE			L	L	L	L	

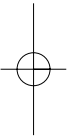

If you do not have the appropriate tools or information to conduct maintenance, or if you feel you are not capable to perform maintenance on this vehicle, contact authorized dealers or repair shops for maintenance and repairs.

To ensure safety, inspections and maintenance of these parts must be carried out by dealers, or repair centers.

- NOTES :** (1) At higher odometer readings, repeat at the frequency interval established here.
 (2) Service more frequently when riding in unusually wet or dusty areas.
 (3) Replace every 2 years, or at indicated odometer interval, whichever comes first. Replacement requires mechanical skill.

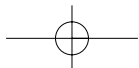

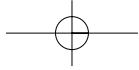

MAINTENANCE PRECAUTIONS

Following is an explanation of correct operation methods, cleaning and parts replacement. Please always refer to this manual when wanting to inspect or repair the vehicle.

CAUTION

Always observe safety rules when performing maintenance on the vehicle.
 Choose a flat surface and make sure the main stand is in a secure down position.
 Use correct tools.
 Conduct engine maintenance with the engine key out of the ignition.
 Be careful around the engine and muffler when performing maintenance as these areas can become extremely hot.
 After self maintenance, the waste material must be packed in the specified container and entrusted disposal to the authorized disposal company.

THE ADJUSTMENT OF FREE PLAY OF REAR BRAKE LEVER

Adjust the free play with the adjuster on the brake arm.
 By turning the adjuster in order to adjust. After adjustment, grip the brake lever, and pull until you feel the resistance, and check to see if the free play of lever ends is within the limit range of regulation.

THE BRAKE LEVER FREE PLAY : 10~20mm

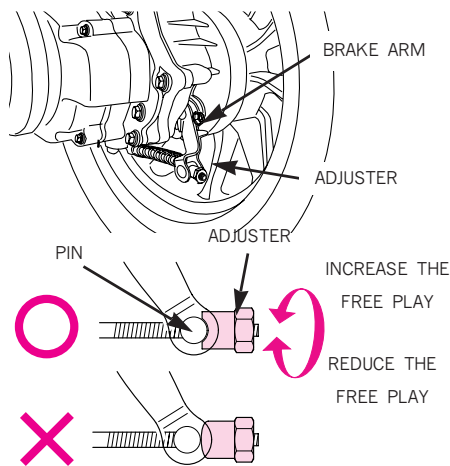

CHECKING THE REAR BRAKE SHOE

After adjustment of free play, check the wear condition of brake shoe grip the brake strongly, if the indicator of brake arm and the wear limit range of brake panel are accord, see your authorized Daelim dealer for this service.

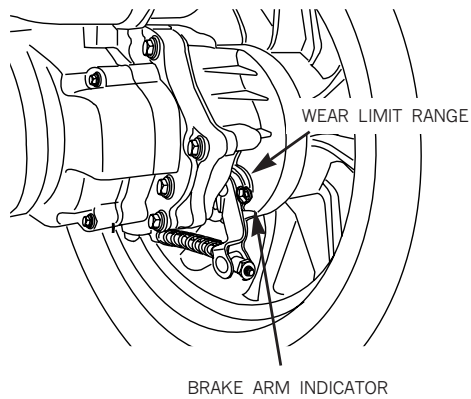

CAUTION

- If the vehicle is aging cause by using for a long time, the replacement time may be change according to wear condition of drum of limb.

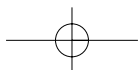

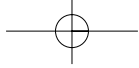

FINISHING FRONT BRAKE FLUID

Check that the fluid level is above the UPPER level mark with the motorcycle in an upright position.

Brake fluid must be added to the reservoir whenever the fluid level falls to reach the LOWER level mark.

Remove the screw rivet of fluid reservoir cover lid.

Remove dust and other foreign materials around reserve tank to prevent foreign materials from falling inside tank.

Remove the screws and take oil cup cap, diaphragm plate, diaphragm off. Add recommended brake oil to upper level inside reserve tank.

RECOMMENDED BRAKE OIL IS DOT 3 or DOT 4

Install the diaphragm plate, and oil cup cap.

Tighten the screws securely.

Replace the wind screen.

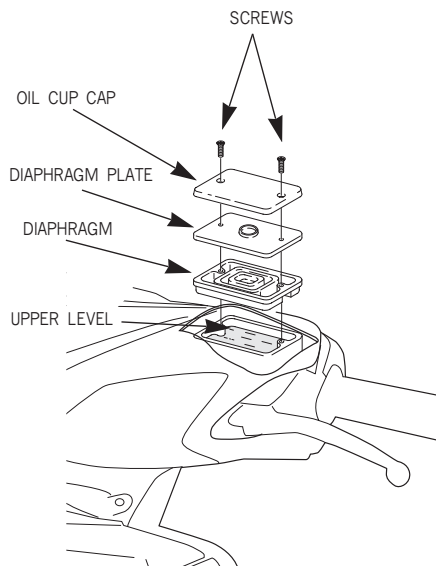

CAUTION

- When adding brake fluid, be very careful not to allow foreign materials to enter the reserve tank.
- Do not fill past upper level.

Foreign materials can clog the system, causing a reduction or complete loss of braking ability.

This can cause brake fluid to leak out of the reserve tank.

- Do not let brake fluid contact vehicle parts as this damages painted areas. If oil contacts parts, quickly clean the fluid off using a dry cloth.
- Use recommended brake fluid as other types can undergo chemical changes.
- If brake fluid is exceedingly low, this can be indication of damage to the brake system.
- A leak in the brake system can lead to reduced braking efficiency and possible loss of braking ability.

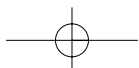
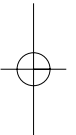

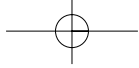

BRAKE HOSE, PIPE LEAKAGE, DAMAGE, ASSEMBLY STATE

Regularly check for fluid leaks or damage using a spanner, check joints and hoses for clearance.

Check hose and pipe protective parts to see if they contact other parts when turning the handle bars or due to vibration during driving.

FRONT BRAKE PAD WEAR

Front brake pad wear depends upon the severity of riding, the type of riding, and road conditions. (Generally, the pads will wear more on wet and dirty roads.)

Inspect the pads at each regular maintenance interval (page 31).

[FRONT/REAR BRAKE]

Check the cutout in each pad.

If either pad is worn to the cutout, replace both pads as a set.

Take your authorized Daelim dealer for service.

<FRONT BRAKE>

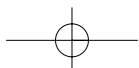
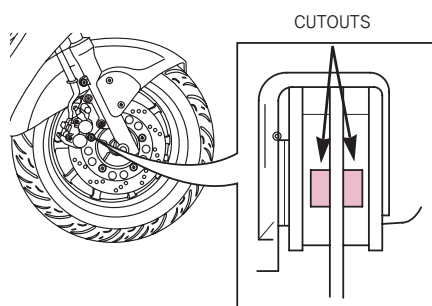

CHANGING ENGINE OIL

When the engine oil is contaminated, the life of engine will be remarkably shortened. Keep the proper oil level, kind and replacing period.

- Place the vehicle on a flat surface, and idle (warm up) the engine 2~3 minutes.
- Stop the engine, separate the oil level gauge, place a vessel under the engine, and remove the oil drain bolt to drain the oil.
- Remove the adjusting hole cap, and clean the oil filter screen.
- Check the condition of O-ring of oil filter screen.
- Install the oil filter screen, spring, adjusting hole cap.
- Install the oil drain bolt.
- Check the oil level gauge, and add the engine oil until it reaches the specified level (between max and min)
- Install the oil level gauge, and idle the engine for a while.
- Wait for 20~30 seconds after stopping the engine, check again the oil level gauge.

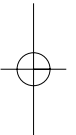

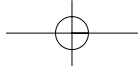

the oil level gauge, and add the engine oil until it reaches the specified level. (between max and min)

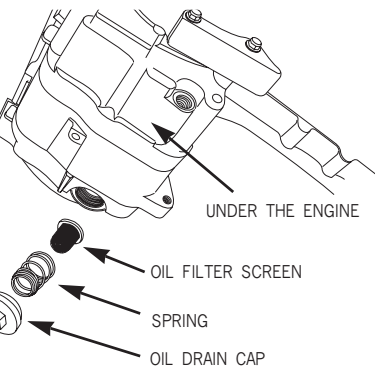

[REPLACING THE OIL DRAIN BOLT]
 Under the engine, place a vessel under the engine, remove the oil drain bolt, and drain the oil.

Remove the oil drain bolt washer.
 Install the oil drain bolt washer.
 When refilling the oil, open the oil filter screen and refill until the specified level.

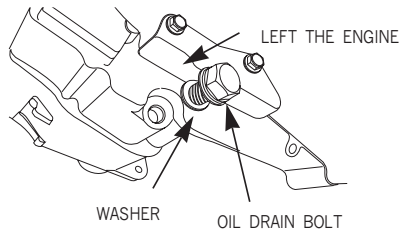

[THE ENGINE OIL CAPACITY]

FULL CAPACITY	0.85 l
WHEN CHANGING	0.7 l

[SPECIFIED GENUINE OIL]

Don't fill the low grade oil. Using it can cause damage to engine, and can't receive the warranty. Use only the genuine oil.

Genuine oil: Motics 4 oil
 SD grade (SAE : 10W30#)



⚠ WARNING

- If changing the oil by loosening the oil drain bolt, always clean the oil filter screen.

⚠ AVVERTENZA

- When changing the engine oil immediately after stopping the engine, be careful not to be burned the hot oil.
- When refueling, make sure not to enter the dirt into oil pouring port.
- If the oil overflows, wipe it clearly.
- Do not fill the oil past the level plate. It can cause damage to engine.
- Don't fill the low grade oil. Using it can cause damage to engine and parts. If the engine is stuck while traveling due to this, it may lead death or serious injury. Use only the genuine oil.
- Do not pour the 2 cycle engine oil. Using it can cause serious damage to engine. If the engine is stuck while traveling due to this, it may lead death or serious injury.
- If the tire is stained with oil while or after refueling, the vehicle may slip while traveling to cause roll over.
- Do not discard the engine oil other than specified place. It will bring environmental contamination, and be brought under the law.

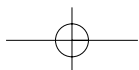
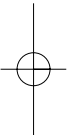

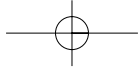

TRANSMISSION OIL INSPECTION

Start the engine and let it idle for a few minutes.

Stop the engine and put the motorcycle on its mainstand on level ground.

Check to see if transmission oil leaks out of the transmission case.

Use the recommended oil when you add.

RECOMMENDED OIL : SAE80W-90

TRANSMISSION OIL CAPACITY : 0.12 l

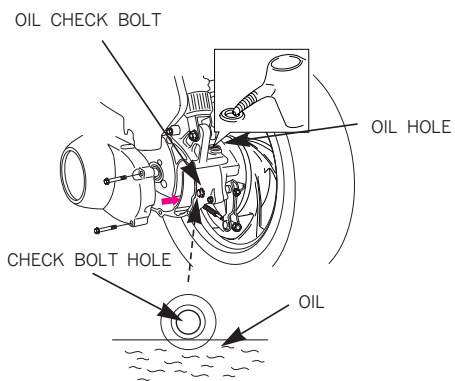

CAUTION

- Pay special attention not to leak out.
- When draining the oil, make sure that all of the oil is removed.
- The engine can be harmed if there is too much or not enough oil.
- Do not use low-quality oil. These oils can change quality overtime and can cause damage.

[SPECIFIED GENUINE OIL]
 Check to see if transmission oil leaks out of the transmission case.

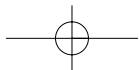
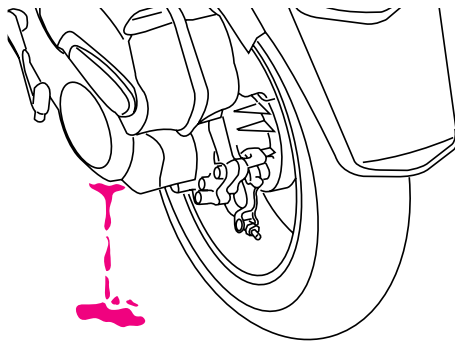

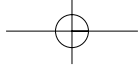

SPARK PLUG

If the electrode is stained or the clearance is not satisfactory, a satisfactory spark is not produced. Clean the electrode and make adjustment. To remove the spark plug cap, turn it around the plug. To remove the plug, use a plug wrench.

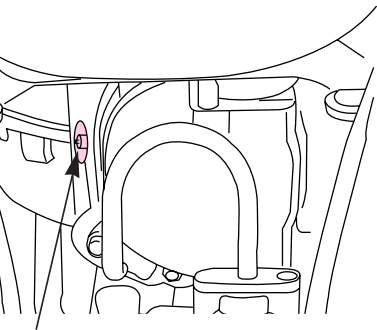

SPARK PLUG

- Clean plug with plug cleaner.
- Check electrode for wear and corrosion. If the ends become round, replace it with a new one.
- Check the plug gap using a feeler gauge.

PLUG GAP : 0.6~0.7mm

- Tighten with hands until the plug washer touches cylinder head.

STANDARD PLUG : CR6HSA

- If new plug is installed, turn 1/2 and tighten using a plug wrench. (Torque : 14kgf.m)
- If plug is reused, turn 1/3~1/4 and tighten.

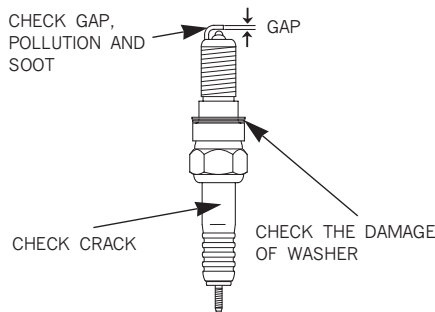

<HANDLING FOR POOR STARTING>

During cold season or when frequent short-distance traveling, the starting may be poor and even the engine will be OFF. This may be prevented by use of spark plug. The spark plug of this vehicle is equipped as standard when delivery. However, the starting will be poor if the vehicle is continuously driven under low speed.

CAUTION

- If plug of different maker or different heat value is used, it causes unsatisfactory engine starting, inadequate engine revolution and output deterioration.
- After driving, the spark plug become very hot. When inspecting, pay attention not to be burned.

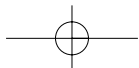
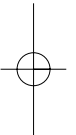

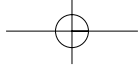

BATTERY INSPECTION

Remove 2 screws and remove the battery cover. If you can find the battery. If the battery terminal is polluted or in-rust, clean battery and clean it.

Remove battery terminal in rust with white sandpaper. Sandpaper should be cleaned with warm water.

In case of serious rust of battery terminal, disassemble the battery cord and grind it with wire brush or sandpaper.

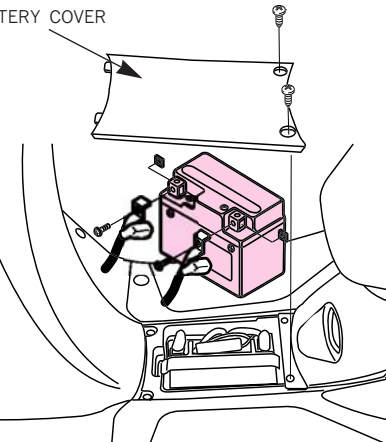

⚠ CAUTION

- Turn the ignition switch OFF before disconnecting the terminal from the battery.
- Disconnect the negative(-) terminal lead from the battery first. When connecting, connect the positive(+) terminal lead first. If you work in reverse order, short circuit will occur resulting in fire.
- Make sure that terminals do not contact with other adjacent parts when handling (+), (-) terminals. Contact with other parts may cause spark resulting in electrical equipment malfunction, fire and electric shock.
- Do not apply excessive impact. When handling the battery, stay away from flammable materials.
- If the electrolyte contact with terminal, it will be corroded earlier.
- The battery is shield type, so do not disassemble the pouring plug.
- When not using vehicle during a long time, take off the battery from the vehicle to keep from self-discharge and electric discharge. Put the battery in a well ventilated place after charging fully. In case it isn't available to take battery off from the vehicle, disconnect (-) terminal.

⚠ CAUTION

- When using the battery without cover, (+), (-) terminals may be connected to cause short circuit resulting in fire. When handling the battery, stay away from flammable materials.
- Your battery is a maintenance-free type so check or refilling of electrolyte will not be required. If there is any abnormal, contact to Daelim service center.
- If you reform the battery for car, battery will be improperly installed to cause short circuit resulting in fire.
- If the electrolyte gets into your eyes or on skin, it'll cause a serious injury.
- Do not discard the battery other than specified place. It will bring environmental contamination, and be brought under the law

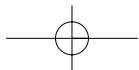
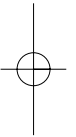

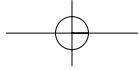

FUSE REPLACEMENT

Turn off the main switch to see if the fuse is blown. If the fuse is severed, exchange the fuse into a fuse with same capacity.(15A)

The fuse is installed in fuse holder around the battery.

To change a fuse, first take off fuse holder. Then, remove the disconnected fuse, and insert the reserved fuse with the same capacity.

FUSE HOLDER

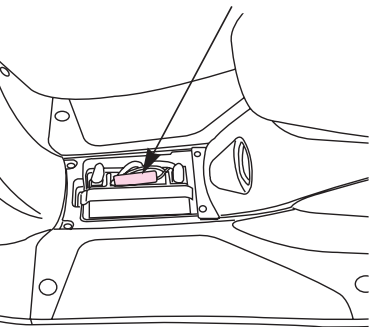

- If the fuse immediately becomes severed after being changed with the new one, check another problem of the electric system. Contact to Daelim service center.

<DISASSEMBLY>

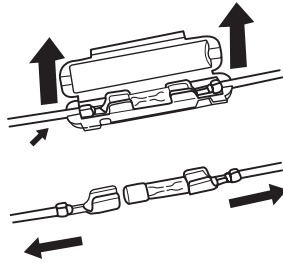

<ASSEMBLY>

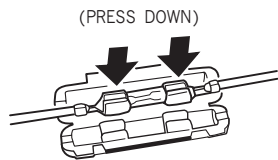

⚠ CAUTION

- Do not use screw driver or other metal parts to remove the fuse, as short circuit can be occurred to cause damage to electric system.
- Do not use a fuse having a larger voltage, as the wire can become overheated and damaged.
- When replacing any of the electrical parts (lights and gauges), be sure to replace them with the recommended parts. Using different parts can lead to the fuses burning out or damage to the battery.
- When washing the vehicle, take special care not to allow to be splashed in the area of the fuses.

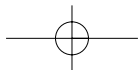
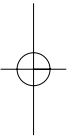

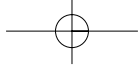

AIR CLEANER ELEMENT INSPECTION

REMOVAL

Loosen the 7 tapping screws and air cleaner case cover.

Inspect the air cleaner element.

If the air cleaner element is excessively dirt or damaged, replace it with a new one.

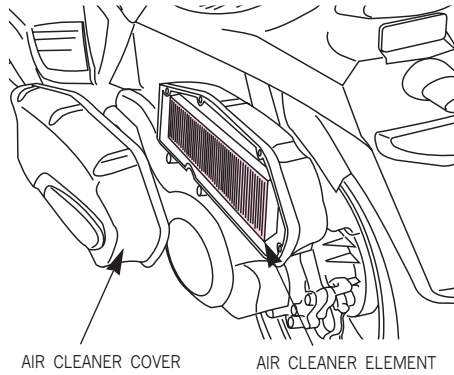

AIR CLEANER COVER

AIR CLEANER ELEMENT

CAUTION

- If the air cleaner element is inadequately assembled, dust and other waste materials can directly enter the engine. This results in increased cylinder wear and reduced power, and reduced durability of the engine.
- When washing the vehicle, be careful not to allow water to get into the air cleaner. Difficulties in starting the engine may result if this happens.
- If the engine start is failed during rain or after driving across water pool, check to see if the water is infiltrated in the air cleaner and clean it.
- Do not drive in the flooded area. If the water enters the air cleaner or engine, the vehicle may be subjected to the rear-end collision due to the power failure.

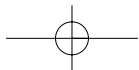
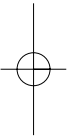

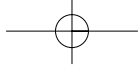

SIDE STAND INSPECTION

1. Lower the main stand and place vehicle in
 upright position on level ground.
 2. Check the spring for damage or loss of
 tension and the side stand assembly for
 freedom of movement.
 3. Check the side stand ignition cut-off
 system;
 4. Lower the side stand up.
 5. Start the engine.
 6. Lower the side stand. The engine
 should stop as you put the side stand
 down.
 If the side stand system does not
 operate as described, inspect it in the
 nearest authorized repair center.

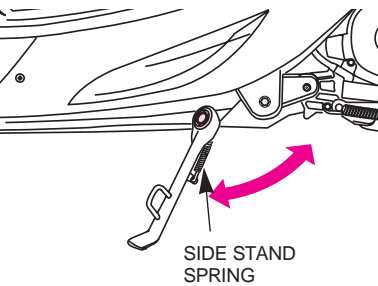

CABLE RUBBER PART

A rubber boots is assembled on the cable to
 protect the inner cable.
 Make sure that this part is placed firmly
 around the correct part of the cable. When
 washing the vehicle, do not directly spray
 water on to the rubber boots or scrub it
 with brush. Use a dry cloth to clean this
 area.

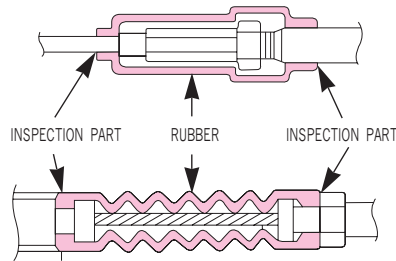

Check the installing condition of rubber
 boots daily. After adjusting the free play
 of throttle grip, never forget to place the
 rubber boots to the original position.

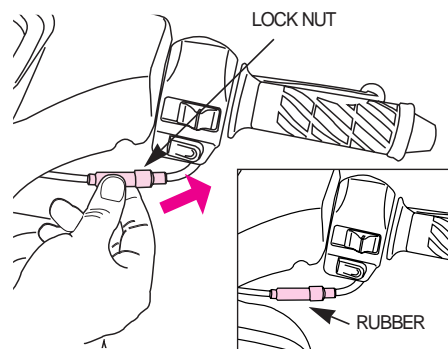

⚠ WARNING

- Infiltration of the foreign materials or water caused by damage of rubber boots (disengagement, tearing, etc.) may cause freezing in winter season resulting in faulty operation. It may lead death or serious injury by decreasing of sudden acceleration and braking force due to engine rpm.
- If any damage is found, replace with the new on immediately.

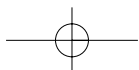
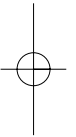

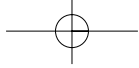

CLEANING

Be sure to stop the engine prior to washing.

Be careful not to allow water to enter the muffler during the washing. Water inside the muffler may cause an improper engine starting or rust occurrence.

Do not let water get inside the braking system during the washing, as water inside the brake system may weaken the braking power. Upon completion of washing, select a safe place where there is no traffic obstruction, and start the motorcycle.

Lightly apply the brake while driving at a low speed and check the braking power. If the braking power has been weakened, apply brake lightly while driving at a slow speed to dry up the braking system.

- Take precautions when waxing the vehicle. Excessive polish of the painted section and/or the resin part with compound wax might damage the painted section causing discoloration of the affected area.

CAUTION

- Do not wash your motorcycle right after use. When the motorcycle is still hot, water drops will evaporate faster and spot hot surfaces.
- Do not use high pressure water jets. Never aim the nozzle direct at wheel bearings, front fork seals, electric items, air inlets or exhaust pipe ends.
- Clean off stubborn dirt or exceeding grease from engine parts using a degreasing agent. Be sure to avoid contact with drive parts (chain, sprockets, etc) Rinse with warm water and dry all surfaces with chamois leather.

STORAGE

Extended storage, such as for winter, requires that you take certain steps to reduce the effects of deterioration from non-use of the motorcycle.

In addition, necessary repairs should be made BEFORE starting the motorcycle; otherwise, these repairs may be forgotten by the time the motorcycle is removed from storage.

- Empty the fuel tank into an approved gasoline container using a commercially available hand siphon or an equivalent method.
- If storage will last more than one month, carburetor draining is very important to assure proper performance after storage.

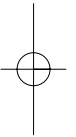
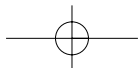

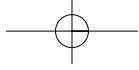

SAFE DRIVING

PREPARATION BEFORE DRIVING

Performing daily inspection

Putting on the protective gears (Helmet, glove, goggles, etc.)

Bringing the driver's licence

Determinating the path to the desired destination

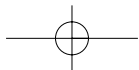
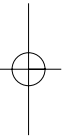

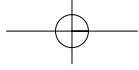

DRIVING METHOD

DRIVING POSITION

An appropriate driving position is most important thing to riding safely.

Eyes : Look at the front direction widely.

Shoulders : Relieve the tension.

Arms : Relieve the tension and bend arms to inside and let them act as the spring.

Hands : Grip the handle the position away from the inside end of the handle with distance of one finger to facilitate the operation of the switch and lever.

Wrist : Keep the state to act freely without applying excessive force to the shoulder and arms.

Knees : Press the fuel tank slightly.

Feet : Place the feet to face the front parallel and make the step bar be placed in the center of feet.

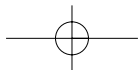
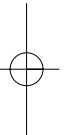
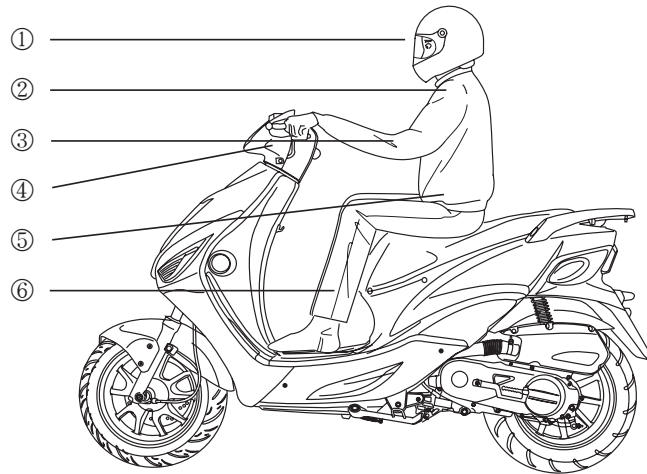

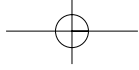

RIDING POSE OF FELLOW PASSENGER

Hands: Hold the rear grip.

Feet and knees: Put the feet on pillion step, and adhere the knees closely to body.

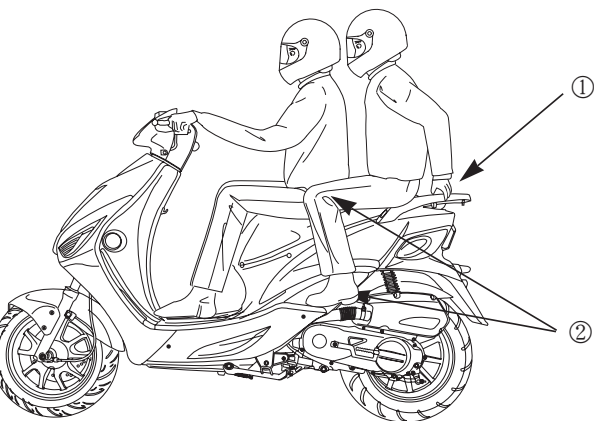

⚠ WARNING

- the fellow passenger doesn't hold the rear grip or put the step on the pillion step, it may lead death or serious injury due to falling from the vehicle as sudden start, stop or turning.
- Do not operate the throttle while setting the main stand. If the fellow passenger sit on and the rear wheel touch the ground, it may lead death or serious injury due to sudden start.

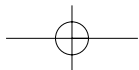
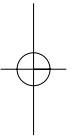

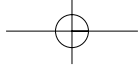

CAUTION WHEN DRIVING

Secure the safe distance.

Drive protectively.

Do not obstruct the traffic.

Do not drive on the pedestrian way or walkway.

Drive on the left driveway when passing away.

Make sure that you can apply the brake anytime.

Always apply the brake when stopping temporarily.

Do not drive excessively long distance and take enough break.

- If any abnormality is found, stop driving and contact service center to inspect the vehicle.
- Restart the vehicle after 2~3 min when it is turned over.
- Always turn on the headlight at night.

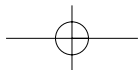
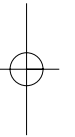

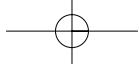

STARTING

Before starting always look around to avoid accident.

Get on the vehicle after pulling back the stand.

Start driving slowly after turning on the winker and releasing the brake while ensuring the safety around the vehicle.

CAUTION

Return the side stand to its original position. Keep driving without doing this may cause turnover accident.

Drive the vehicle only on the driveway. Driving on the walkway can cause accident. Also, if the wheel is transformed when advancing directly to the walkway, the vehicle can be overturned resulting in injury of the driver due to the driving instability.

Overspeed driving on the unpaved road can cause the vehicle to be overturned resulting in injury of the driver due to the driving instability.

Do not drive in the gravel road. If any gravel enters the wheel or engine case, the vehicle can be overturned resulting in injury of the driver.

If possible, do not drive close to the sea or on the road where calcium chloride is treated.

The muffler, external parts and welded parts can be corroded rapidly, and also in case of damage of the frame, the vehicle can be overturned resulting in injury of the driver.

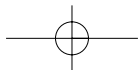
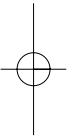
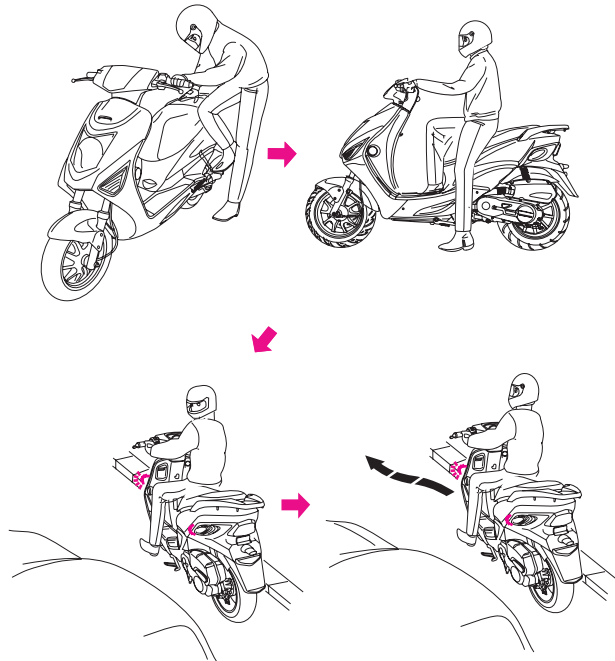

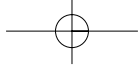

LEARNING METHOD

PRINCIPLE OF TURN

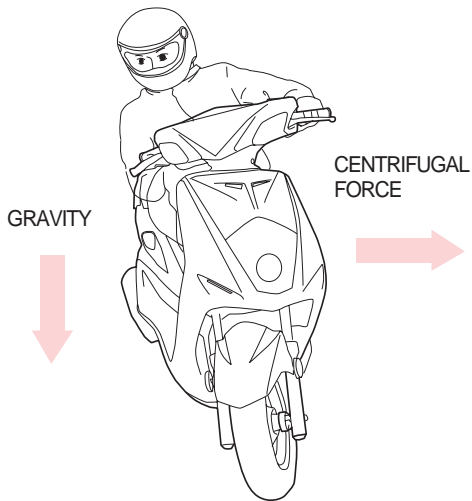

The basic principle of a turn is balancing using the centrifugal force which makes the vehicle go outside and the gravity which makes the vehicle fall inside.

EFFECT OF SPEED

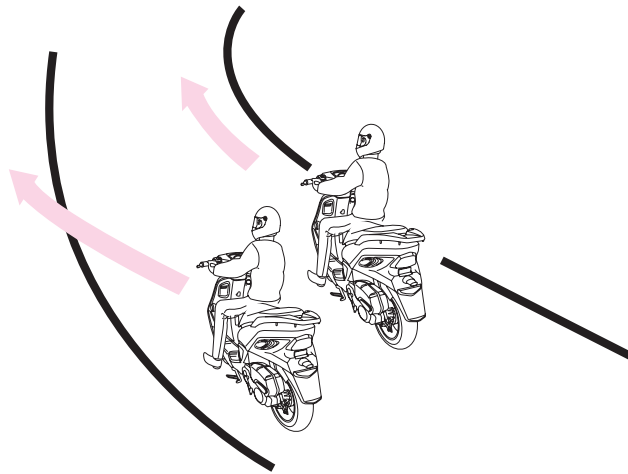

The centrifugal force increases in inverse proportion to the radius of a curve and in proportion to the square of the speed. Decelerate prior to entering the curved way to reduce the centrifugal force.

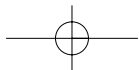
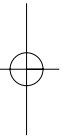

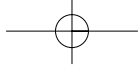

POSITIONS OF TURNING

basic principle of turn is balancing using combined force of centrifugal force and the gravity.

3 positions require straightening the head and keeping the motorcycle horizontally.

LEAN-WITH >

is a turning position with motorcycle and driver in a line. This position is the most natural and exact, so driver must learn thoroughly.

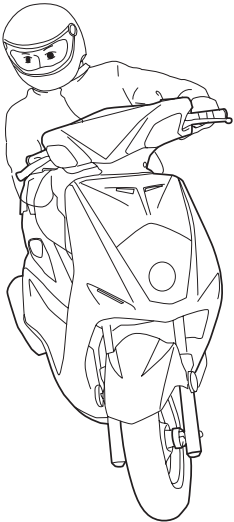

< LEAN-IN >

This is a turning position with driver leaned inside more than motorcycle. This position is adequate to drive on the rained or slippery road because it has best road holding.

However, special attention is required because front visual field is poor when driver leans inside more than motorcycle.

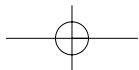
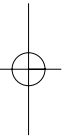
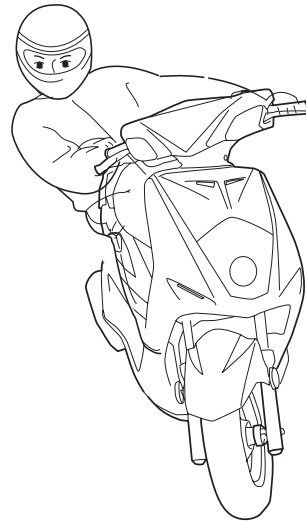

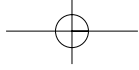

LEAN-OUT >

is a turning position with motorcycle leaned inside more than driver, which is opposite to the lean-in position. In this position, quick turn is well performed and driver can get a wide front visual field adequate to drive on the rained or slippery road because it has best road holding. However, special attention is required because there is danger of slipping on the slippery road.

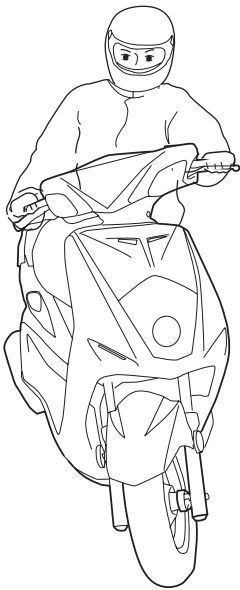

TURNING METHOD

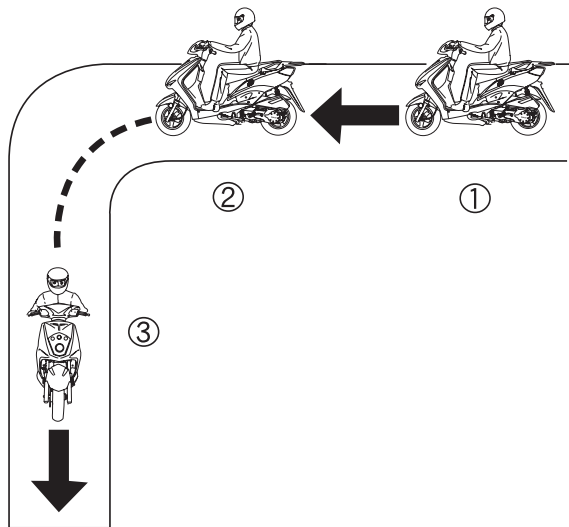

- ① Turn the throttle grip to its original position and decelerate using both front and rear brakes.
- ② Lean the vehicle toward inside of turn circle while driving slowly at constant speed.
- ③ Accelerate gradually.

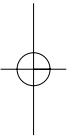
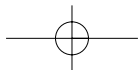

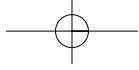

CAUTION WHEN TURNING

Do not drive inside of large truck's turn circle.

< DEAD ANGLE ZONE >

Dead angle zone is the sight range which cannot be identified by driver and increases in proportion to the width of the vehicle.

< DISTANCE BETWEEN THE FRONT AND REAR WHEEL TURN >

It is distance between path of the front and rear wheel and increases in proportion to the length of the vehicle.

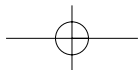
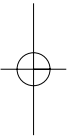
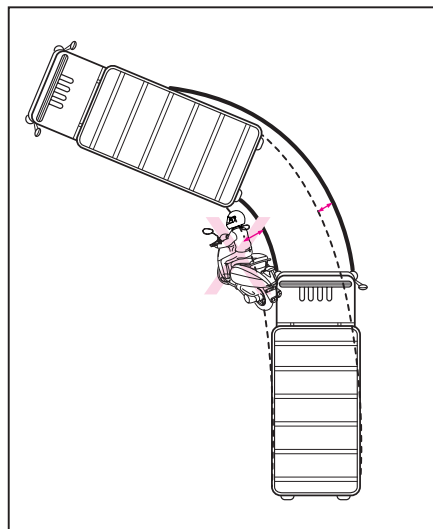
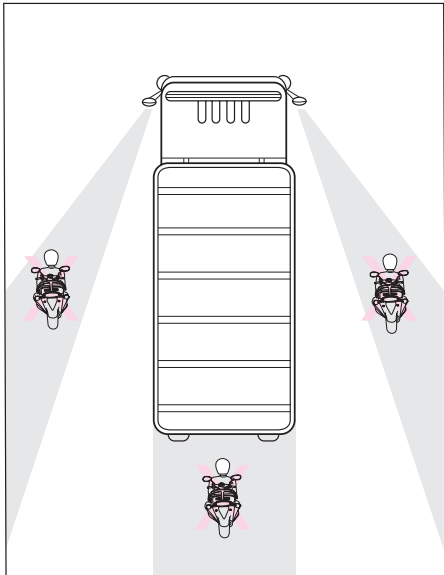

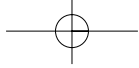

BRAKING METHOD

BASIC PRINCIPLE OF BRAKE (FRICTION FORCE)

Vehicle is braked using friction between road surface and tires.

Braking distance increases 1.5 times on wet road and 3 times on icy road because friction force of road surface is decreased.

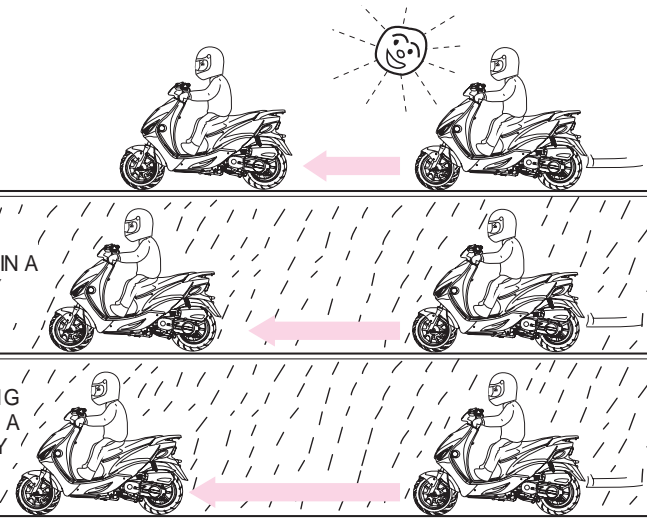

RESTRAINT OF BRAKE EFFECT (INERTIA)

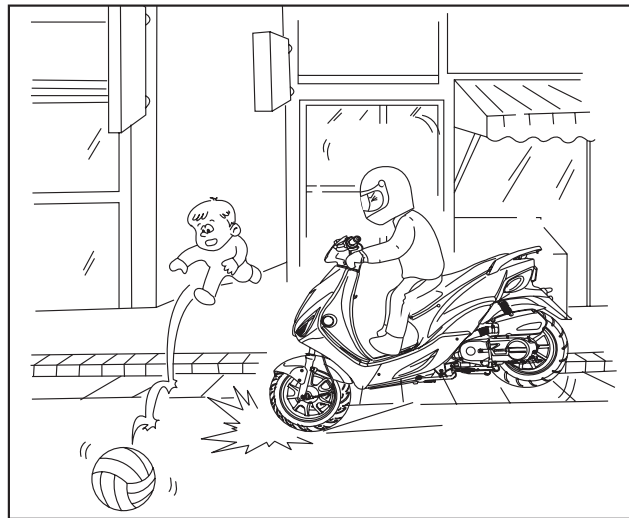

Due to the inertia, vehicle does not stop immediately after applying the brake.

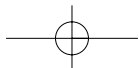

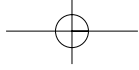

BRAKING METHOD

Turn the throttle grip to its original position and decelerate using the engine brake.
Direct the vehicle straight.
Brake using both front and rear brakes.

COMPARISON OF BRAKING DISTANCE

Vehicle speed : 50 km/h

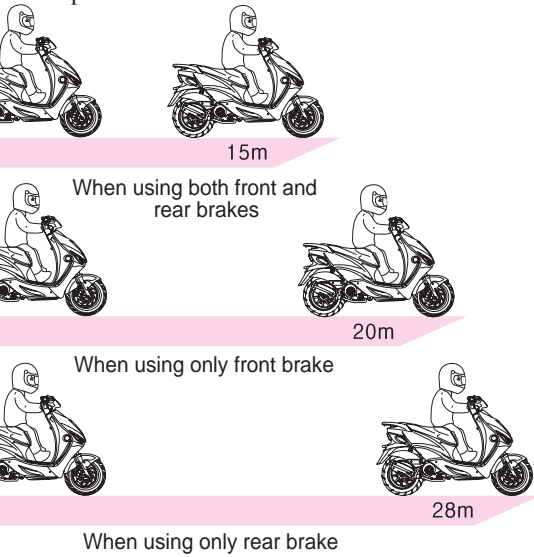

IMPACT WHEN COLLISION

Learn the proper braking method to prevent accident.

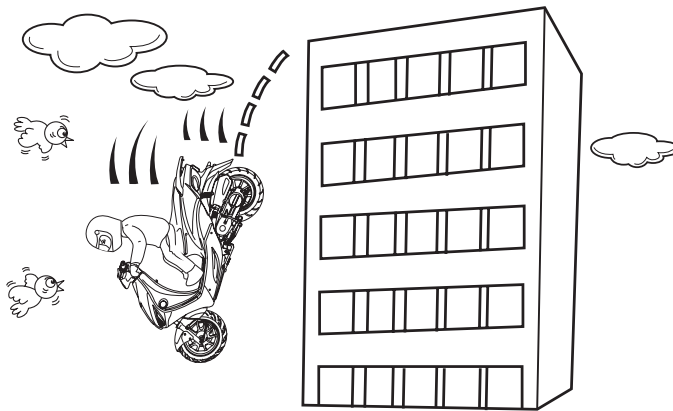

Impact increases in proportion to the speed and weight. The impact when collision to concrete wall at 50 km/h is same as one when falling from the height of 10m.

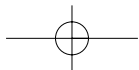
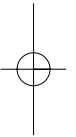

WIRING DIAGRAM

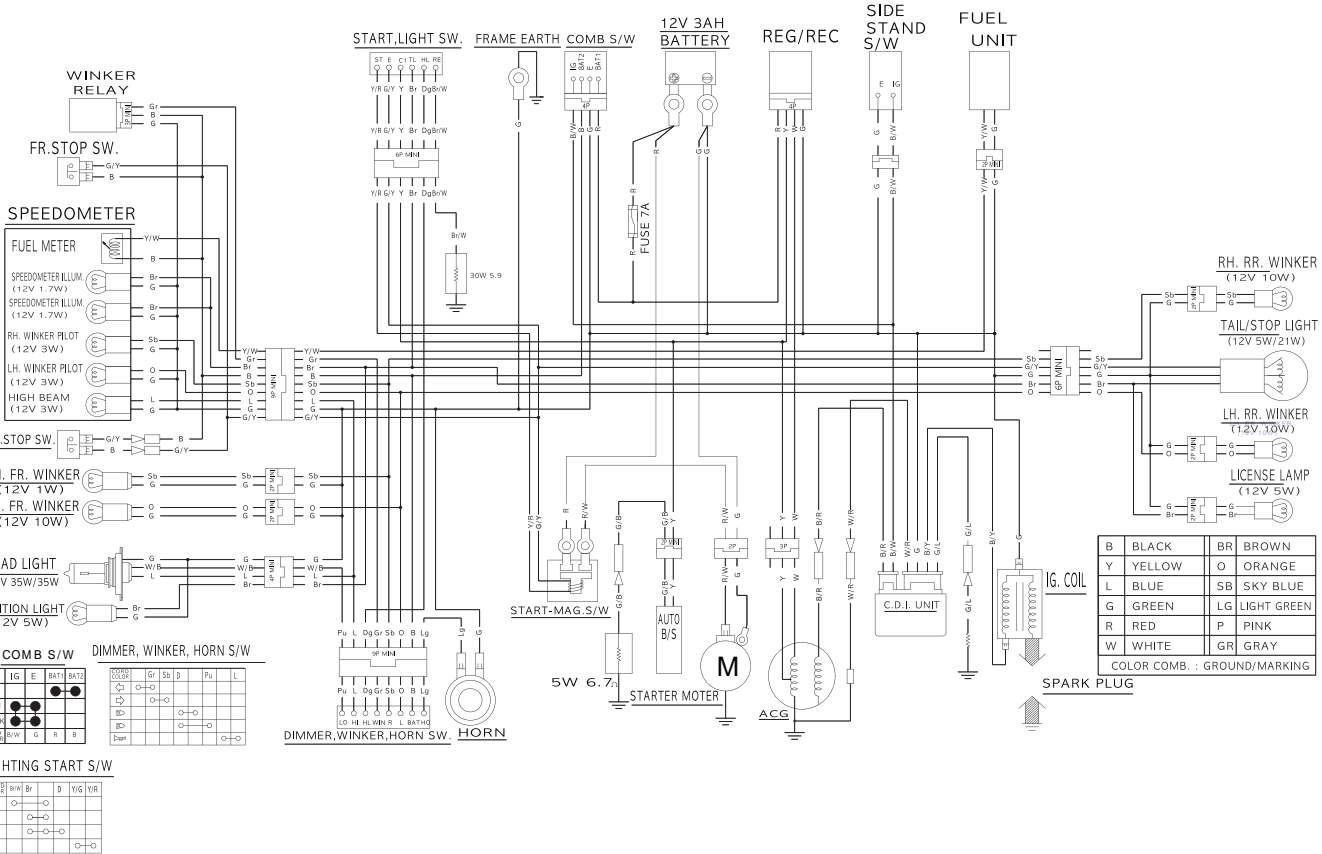

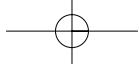

D:

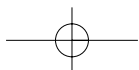
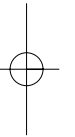
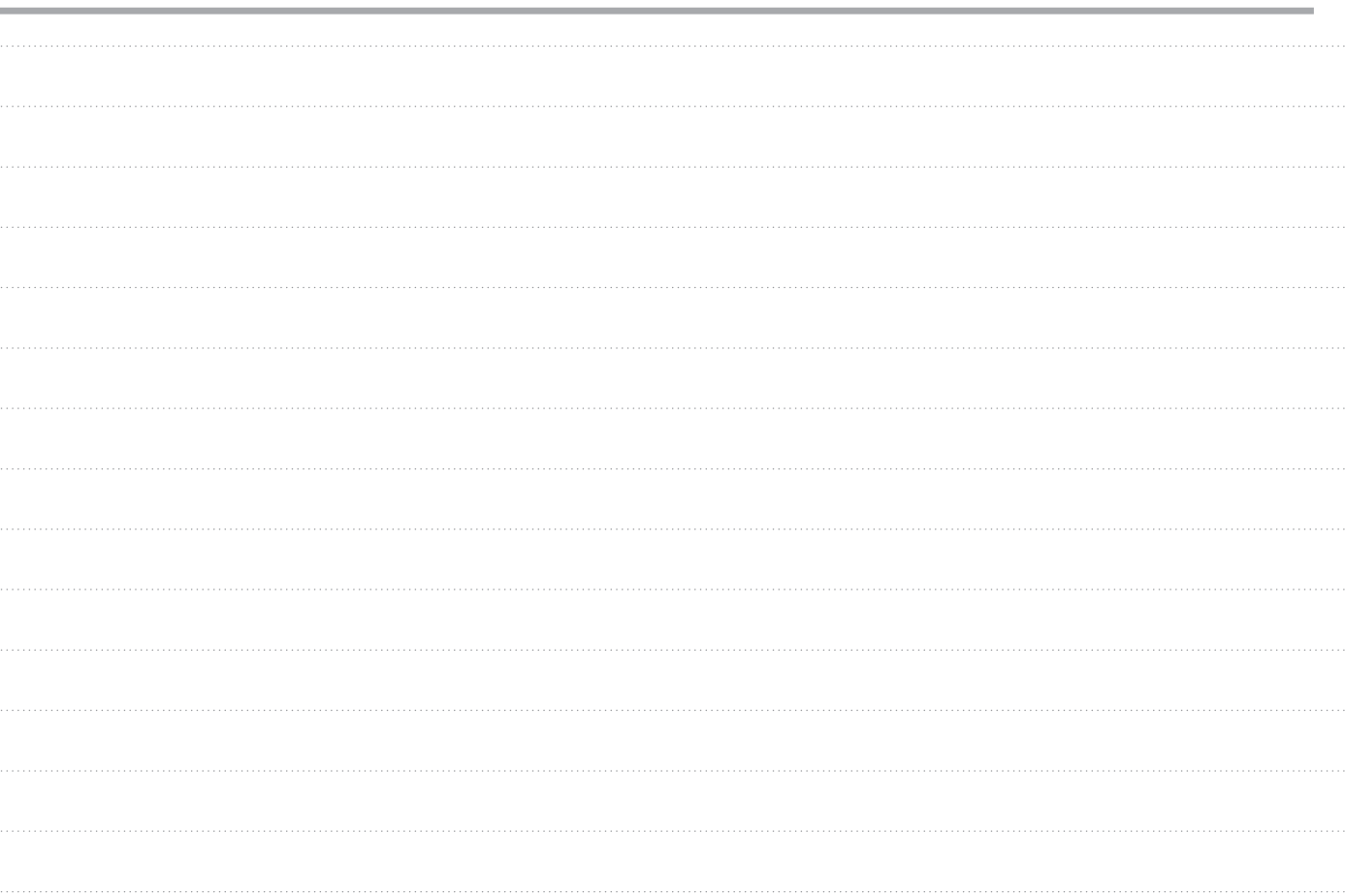

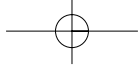

D:

A series of horizontal lines for writing, starting with a solid line followed by multiple dotted lines.

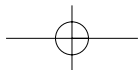
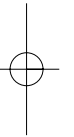

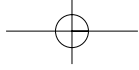

D:

A series of horizontal lines for writing, starting with a solid line followed by several dotted lines.

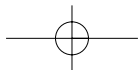

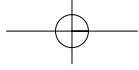

D:

A series of horizontal lines for writing, starting with a solid line followed by multiple dotted lines.

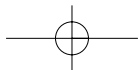
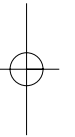

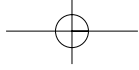

D:

A series of horizontal lines for writing, consisting of a solid top line, a dotted midline, and a solid bottom line.

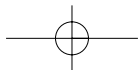
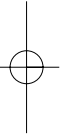

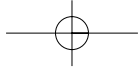

D:

A series of horizontal lines for writing, starting with a solid line followed by several dotted lines.

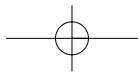
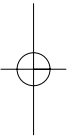

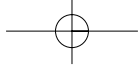

D:

A series of horizontal lines for writing, starting with a solid line followed by several dotted lines.

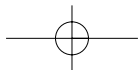
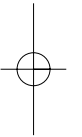



OWNER'S MANUAL

2009. 11 PRINTED
2009. 11 PUBLICATION

NO COPY

 **DAELIM MOTOR**

