

TXTRONIK1E06

*MANUAL DEL USUARIO
SERVICE MANUAL
MANUEL D'ENTRETIEN
LIBRETTO D'USO
BETRIEBSANLEITUNG*

GAS GAS

GAS GAS

TXTRIPDIKE06

USER MANUAL

GAS GAS thank you for the trust you have placed in us.

By choosing a new GAS GAS TXT Rookie 2006 you have become part of the great GAS GAS family and, as a user of the number one manufacturer of off-road motorbikes, you deserve to receive the best treatment we can offer you both in our post-sales relations and in the explanations we offer in this manual.

Our Rookie 2006 is designed for high-level trial competitions. In fact, it is the result of many years of competing and experimenting in this highly demanding discipline and of the many excellent results obtained by the great riders who have supplied the basic data to enable us to develop this excellent motorbike, a GAS GAS that has one key advantage – its remarkably light weight.

Congratulations for you will doubtless have no reason to regret your choice. With your riding skills, appropriate preparation and the relevant essential checks to maintain its highly reliable performance, you will be able to enjoy to the utmost your trial riding.

Thank you for your trust in us, and welcome to GAS GAS motorbikes.

GAS GAS MOTOS, S.A.

Important Warning

Read this Manual carefully. You will find it contains all the necessary information for your safety, and that of third persons, as well as guaranteeing the correct conservation and maintenance of the GAS GAS motorbike you have just bought.

You will find all the necessary instructions for the correct riding and control of this vehicle are set out below. Each message is preceded by a sign whose meaning is the following:



Be careful! This sign introduces all those rules and precautionary measures necessary to avoid slight or severe injuries, or even the death of the user should these instructions not be correctly followed.



Look out! This sign introduces special warnings to avoid damaging your motorbike. Should these warnings not be heeded, the guarantee may be automatically invalidated.



Various notes. These are the indications necessary for the optimal control and adjustment operations, together with those tasks of conservation and maintenance of the motorbike in order that you may obtain the greatest possible satisfaction from your vehicle.

The aim of this Manual is to help the user to minimise or avoid possible damage to people, property, the environment, and naturally to his/her new motorbike. For this reason, all the information presented here is based on data obtained from the latest models put on the market just before the publication of this Manual. However, GAS GAS Motos, S.A. reserves the right to make modifications without any prior warning being given to consumers and without incurring any additional obligations in so doing. Your local dealer will also provide you with any information as might be deemed necessary.

Contents

Acknowledgements to the purchaser	3	Chain tensor setting	15
Important warning	4	Cleaning the carburettor	16
Recommendations for the best working	6	Checking the Carburettor capacity	16
Quick Guide to Maintenance	7	Inlet Valves	17
Serial Number	8	Discs and Clutch Springs	17
Draining the Sump	8	Draining the Water Pump	18
Position of Fuel Tap	8	Checking Oil Levels	18
Filling of the Crankcase	9	Air Bleed	18
Position of the Kick-start Pedal	9	Clutch Fluid Circuit	19
Filling of the Radiator	9	Front and Rear Suspension	19 to 20
Greasing the Joints	10 to 12	Checking of Bearings and Rocker Arm	20 to 21
Tolerance of Throttle Cable	13	Shock Absorber Spring Pressure	21
Spark Plug Control	13	Rear Brake Fluid Tank	21
Carburetion	13	Brakes	22
Hand Control Settings	14	Controls	23
Cleaning of Air Filter	14	Tyre Pressures	23
Position of Chain Fixing Link	15	Guarantee manual	25 to 27

GAS GAS

Recommendations for the good working of your GAS GAS.

- Eight hours of running-in are recommended in order to guarantee the correct working of the engine.
- It is important to warm the engine to the optimum working temperature every time the motorbike is used.
- Synthetic or semi-synthetic 2-stroke oil should be used at 1.5% in the oil/petrol mix.

GAS GAS

RECOMMENDS THE USE OF OIL

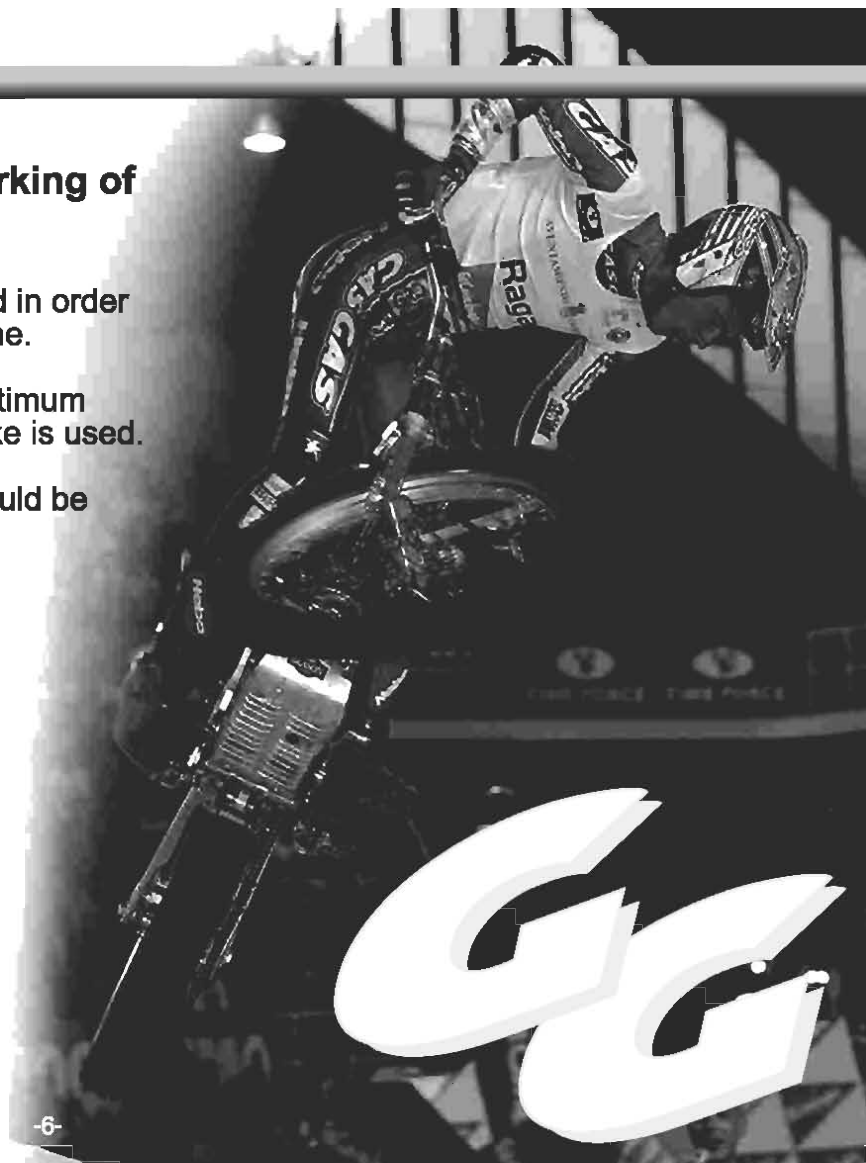

GG

Quick Guide to Maintenance

Cooling liquid type	Cooling fluid -30°C.
Crankcase oil	(10w40) 500 cc.
Spark plug	CHAMPION RN11YCC / NGK BPR5ES.
Electrode separation	0,6 mm.
Forks suspension oil	SAE 5 (Summer). SAE 2,5 (Winter).
Fork suspension oil quantity	310 cm ³ .
Length of Shock Absorber Spring	140 mm.
Front Wheel Pressure	Standard 0,450 bar. Competition 0,420 bar.
Rear Wheel Pressure	Standard 0,350 bar. Competition 0,300 bar.



The new GAS GAS TXT Rookie 2006 carries the appropriate certification plate whose details should coincide with those on the accompanying documentation and the frame number stamped on the steering arm.



The fuel tap should be in a vertical position for normal working. Forwards, reserve; downwards, the supply valve is open; and towards the rear, the valve is closed.

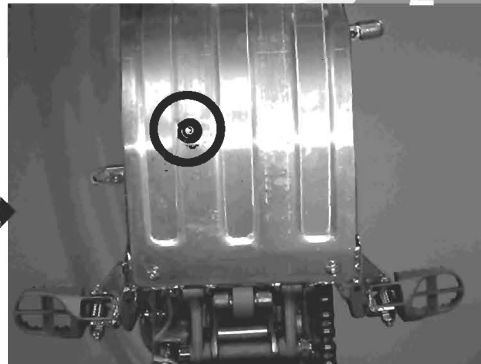

The engine crankcase drain cap is situated on the lower left-hand side. The drainage hole in the crankcase allows its easy emptying.

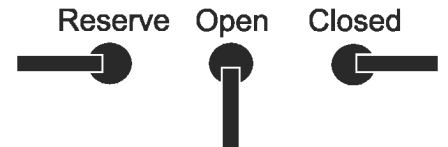



When topping up the oil, open the cap (A).

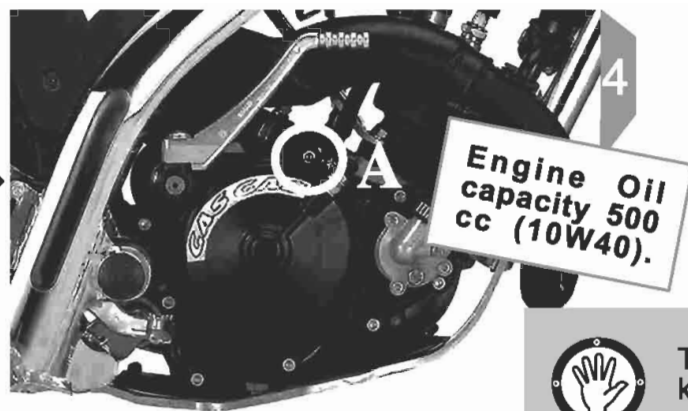

Engine Oil capacity 500 cc (10W40).



This is the position the kick-start should be in when not being used.

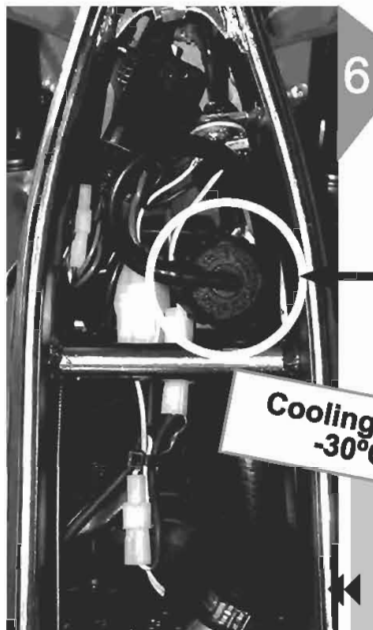

Cooling fluid -30°C





When filling the radiator, use cooling fluid designed for lightweight alloy motors.

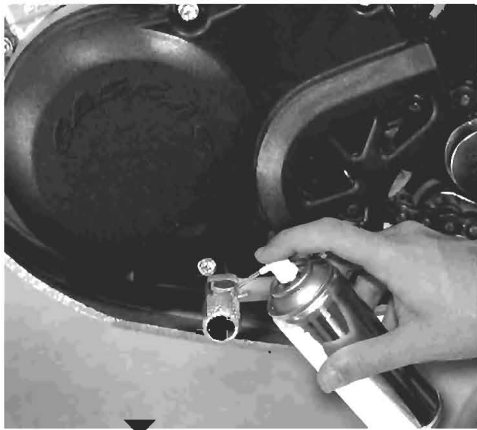

 With special oil it is necessary to lubricate:
1) The joints of the clutch and brake levers.



 2) The joint of the gear change pedal.

 3) Also the rear brake pedal (bearings).

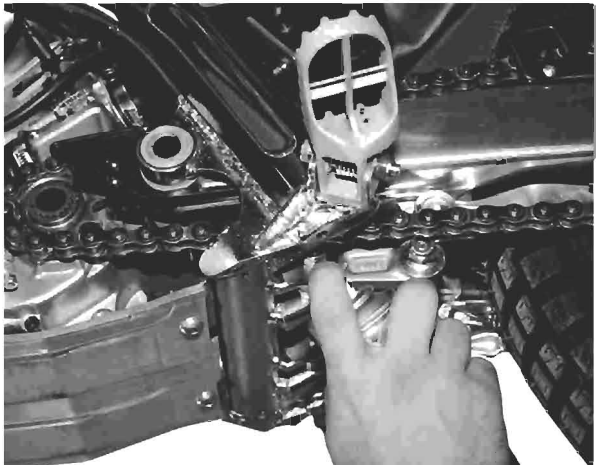



4) Grease the fixings and springs of the footrests.

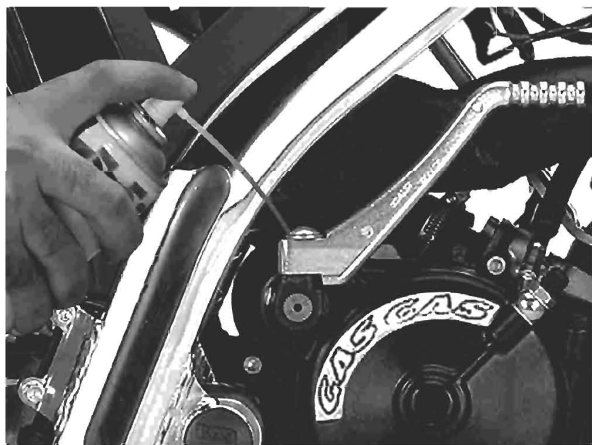

5) Grease the joint of the kick-start pedal of the engine.



6) The secondary chain should be cleaned and lubricated regularly given its constant friction and exposure to the elements.

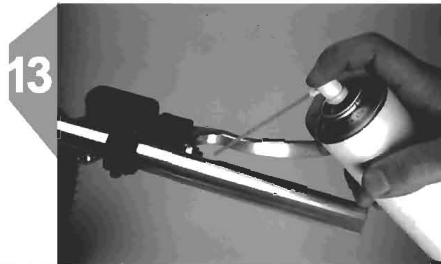

7) Grease the handlebar with a fine coating of oil to guarantee the smooth working of the throttle grip.



8) We also recommend the regular greasing of the spring of the chain tensor since it works under great pressure.

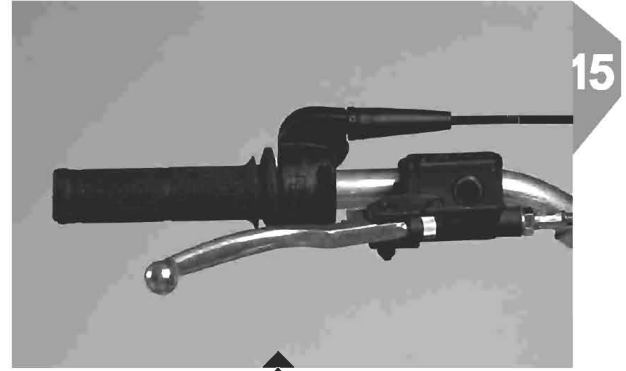

9) The throttle should be cleaned and oiled regularly especially after washing the motorbike with water at high pressure.



Controlling the tolerance on the throttle cable is done using the mechanism indicated with the hand in the photo.



16



18



It is necessary to periodically check the state of the spark plug. The sparking plug distance should be between 0.6 and 0.7mm.

0,6 ≈ 0,7 mm

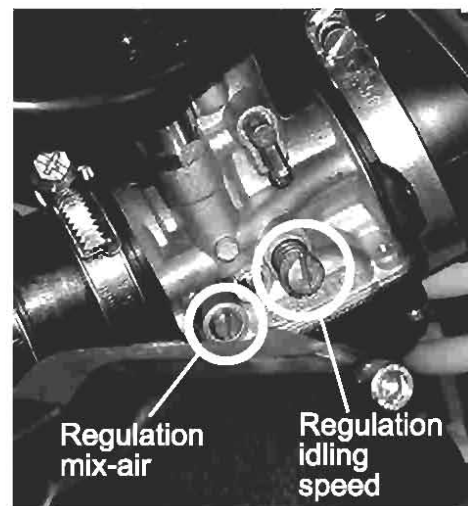
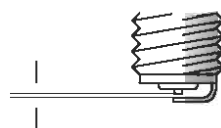

17



Adjusting the idling speed of the engine, and the flow of fuel into motor, can be done using the screws marked in the photograph.

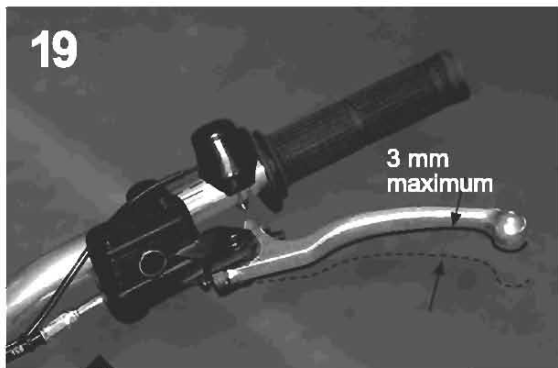

19

3 mm maximum



The clutch lever should be regulated to the necessary distance and the play on the lever should never be more than 3 mm. Do not ever override this.



As with the clutch, the front brake lever should be at the ideal distance for operation. In this case, the play should never be greater than 3 mm.

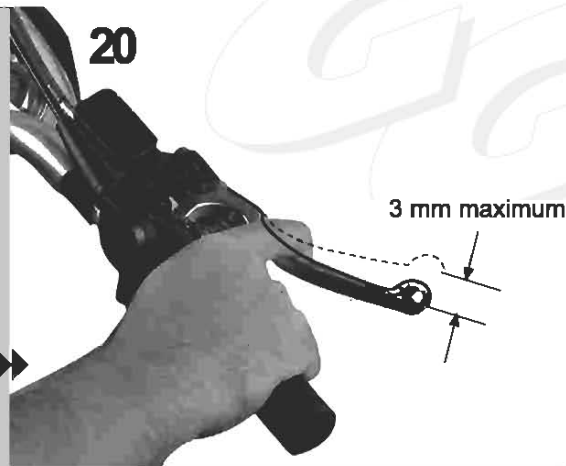

20

3 mm maximum



It is important to periodically check the air filter. Open the door set on the side of the motorbike as shown in the photo. Clean with water and detergent, then dry and lubricate with oil designed for filters. Ensure its correct collocation once clean. In the lower part of the filter chamber there is a leaf that acts as the escape valve for the liquids and/or other materials that may build up in the filter chamber. Check this valve is working properly.

21





To tense and centre the rear wheel, the hub is fitted with easily adjustable eccentrics.



22



The chain fixing link should be fitted so it faces against the direction of movement.



23



The tension on the chain should allow an oscillation of 1.5 cm where it passes through the tensor.



24



Dismantle and clean periodically the main nozzle after washing the bike, as well as cleaning the inside of the carburettor housing.



It is necessary to clean the carburettor very thoroughly. To do so use compressed air.

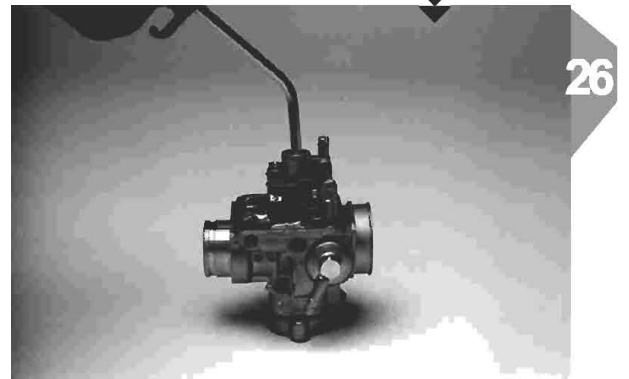

It is important to check the level of petrol within the carburettor. The float should be at 15 mm.

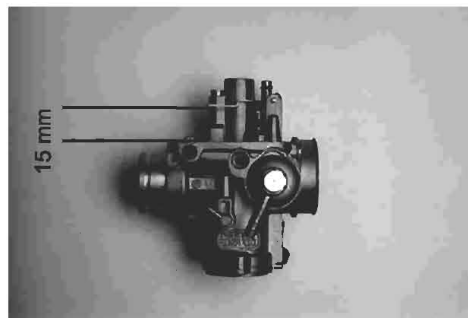



After many hours of use the clutch discs should be checked for possible wear. The minimum size for their correct working is 15 mm.



The springs that exert pressure on the clutch should have a length of between 28 and 29 mm.

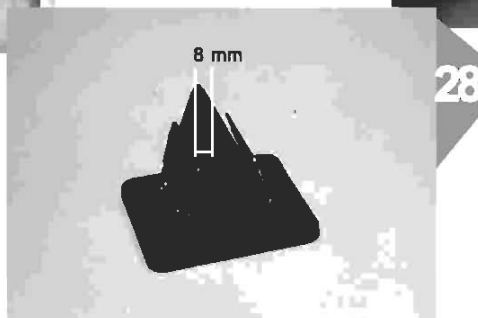
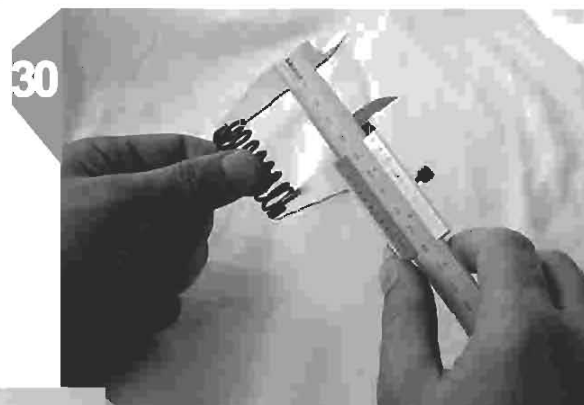

The distance between the leaves and the guides should be 8 mm.

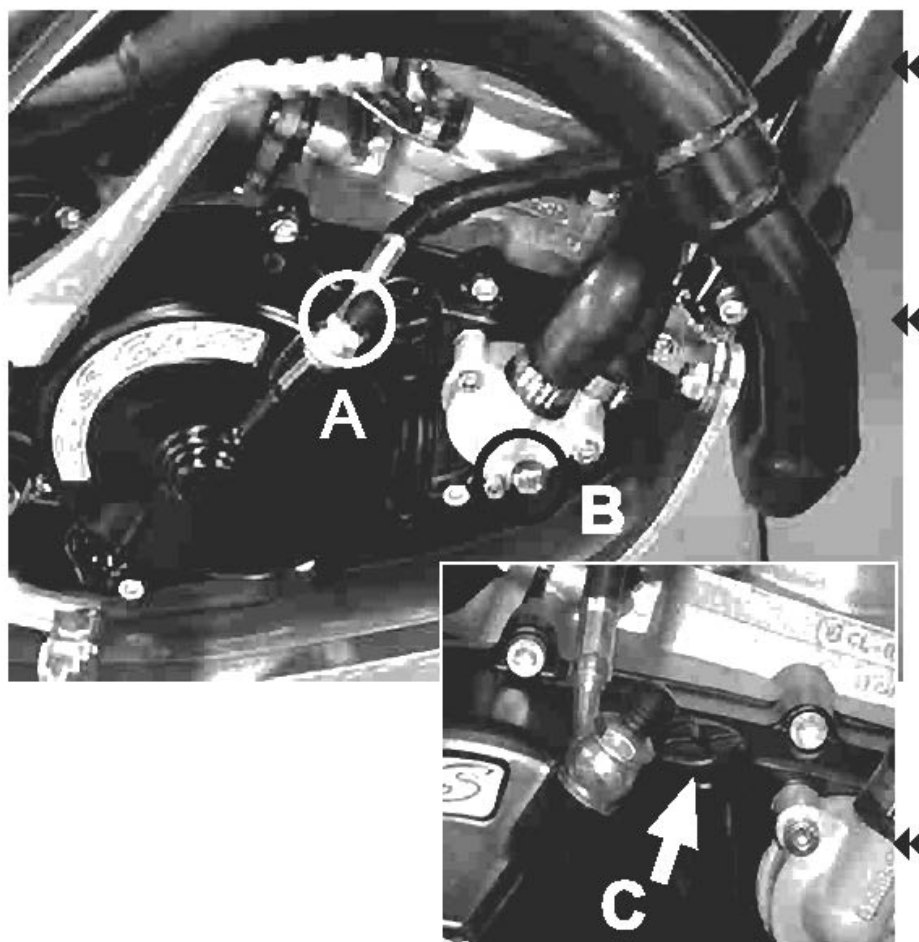

31



After any operation involving the dismantling or putting back together of the clutch operating circuit, any remaining air can be eliminated using the air bleed (A).

32



The circle indicates where the radiator should be drained (B).



To check the oil level, first make sure the motorbike is perpendicular to the ground. If the bike has been in use, wait a few minutes. To check the oil level, unscrew the cap (C) and examine the level of oil using the dip-stick. The level should be between the marked maximum and minimum levels. If it is too high, drain the excess. If it is too low, add the necessary quantity by opening the oil cap. Use the same type and make of lubricant as that which is already in the engine.



Check the level of clutch fluid periodically by looking through the transparent spy-hole mounted in the tank.



33



The suspension stems should have 310 cm³ of SAE5 oil each.



34

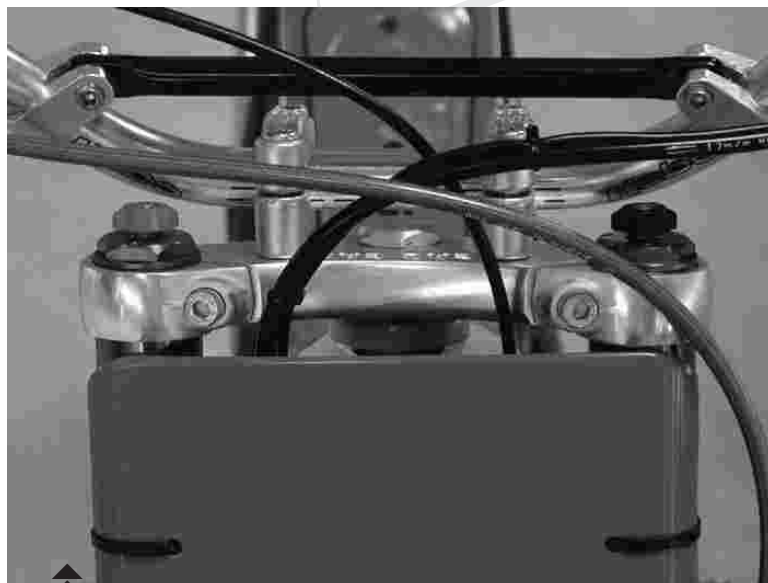

The front suspension is manually adjustable. To the right (extension), to the left (hydraulic compression).



The cap of the front suspension should not stand out more than 9.5mm from the upper washer.

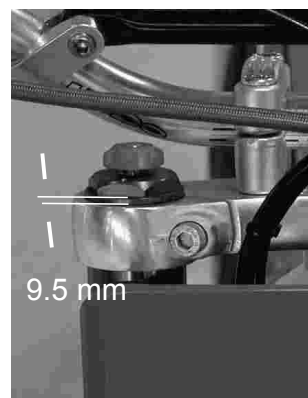

35

9.5 mm

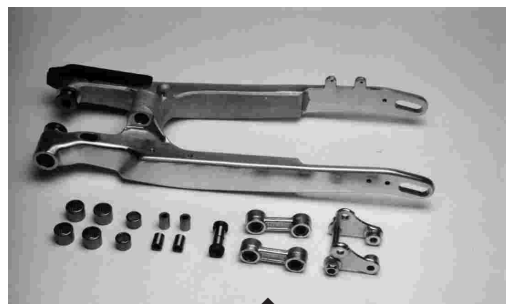

36



It is important to periodically dismantle and check the state of the bearings and the rocker supports.

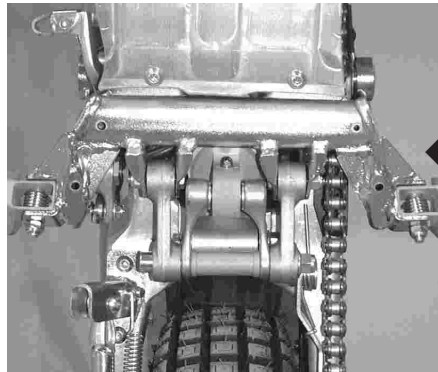

Periodically, the joints of the lower part of the rear suspension should be cleaned, the adjustments checked, and lubricated.

37

The pressure of the shock absorber spring can be adjusted by turning the cogs (A) using a key. The length of the spring should be 140 mm.



38

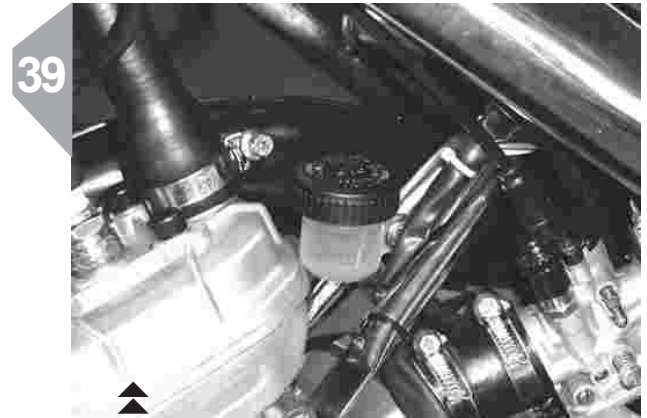

39

The rear brake fluid tank (B) is in the centre of the chassis.



The brake pads, both front and rear, should be checked for wear periodically, in order to enable you to brake effectively in any situation.



40



41



The level of brake fluid can be checked using the transparent observation panel in the tank.



42

To eliminate any air trapped in the brake circuit, the shoes are fitted with air bleeds.



The control panel only contains a motor cut out button.

43



Front tyre pressure:
0,450 bar - standard
0,420 bar - competition

Rear tyre pressure:
0,350 bar - standard
0,300 bar - competition

44



Check regularly tyre pressures in order to obtain the best road-holding possible.

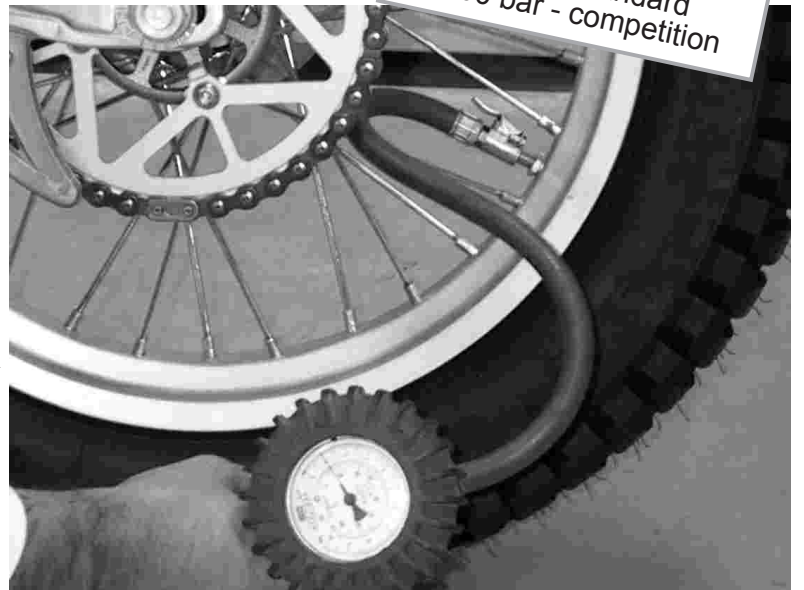



The fuel tank cap twists off. You are recommended to check regularly the state of the rubber seal in order to ensure a correct closing.



WARRANTY TERMS AND CONDITIONS

(According to Law decree 23/2003 on the 10th of July, covering Warranties on Consumer Item Sales).

Warranty terms of the manufacturer GASGAS Motos, S.A.

The company GAS GAS MOTOS, S.A. (hereafter referred to as "GG"), with this present document guarantees the consumer, the purchaser of a vehicle manufactured by GG, that both the materials and the manufacturing are free of defects in accordance with the highest standards of quality. Consequently, GG with this document guarantees the consumer (hereafter referred to as the "purchaser"), in accordance with the conditions set out below, the repair, free of charge, of any defect in materials or that might result from faulty manufacture that is detected in a new motorcycle within the period covered by this Warranty and with no limit on the number of kilometres covered or hours of use.

Warranty Period

The period covered by this Warranty will begin on the day of delivery of the vehicle to the purchaser by a GG authorised dealer, or in the case of demonstration models, on the date in which the vehicle is used for the first time. The seller will be responsible for any unwarranted faults that become apparent within the period established in the Law decree 23/2003 on the 10th of July covering Warranties on Consumer Goods Sold from the time of delivery and in accordance with the Directive 1999/44/EC for other members of the European Community. For countries outside the European Community, the Warranty Period will be determined by the existing regulations in those countries. Nevertheless, should the fault appear during the first six months after the delivery of the motorcycle, it will be presumed that the said fault existed at the time of delivery; from the end of the sixth month onwards, the purchaser must demonstrate that the unwarranted fault existed at the moment of delivery. During the first six months subsequent to the delivery of the repaired vehicle, the seller will be responsible for any unwarranted faults arising out of the repair.

Any defects detected in the product must be brought to the attention of a GG authorised dealer within the Warranty Period. If the last day of this period is a Sunday or an official holiday, the Warranty period will be extended such that the last day of the period covered will be the first working day after the Sunday or official holiday.

Those claims under Warranty for defects not brought to the attention of a GG authorised dealer before the end of the Warranty Period will be excluded.

Obligation of the purchaser

GG will have the right to reject any claims under Warranty in the event that:

- a) the purchaser has failed to submit the vehicle to any of the inspections and/or maintenance work required in the Users' Manual, or has exceeded the date set for such inspections or maintenance work. Also excluded from guarantee are those faults that appeared prior to the dates established for an inspection or maintenance work where the latter was not carried out, or was carried out later than the date established.
- b) an inspection, maintenance or repair has been performed on the vehicle by third parties not recognised or authorised by GG.
- c) any maintenance or repair has been carried out on the vehicle that violates the technical requirements, specifications and/or instructions indicated by the manufacturer.
- d) spare parts whose use has not been authorised by GG have been used during the course of maintenance work or repairs to the vehicle, or in the event that the vehicle has been used with fuels, lubricants or other liquids (including, amongst others, cleaning products) that have not been expressly mentioned in the specifications set out in the User's Manual.
- e) the vehicle has been altered or modified in any way or fitted with components other than those expressly authorised by GG as accepted components of the vehicle.
- f) the vehicle has been stored or transported in a way that is not in accordance to the corresponding technical requirements.
- g) the vehicle has been used for special purposes other than ordinary use, such as competition, races or record breaking attempts.
- h) the vehicle has been directly or indirectly damaged as a result of a fall or an accident.

Warranty exclusions

The following items are not covered by this Warranty:

- a) worn parts, including, without any limitation, spark plugs, batteries, petrol filters, oil filter elements, (secondary) chains, engine output pinions, rear sprockets, air filters, brake discs, brake pads, clutch plates and discs, bulbs, fuses, carbon brushes, footrest rubbers, tyres, inner tubes, cables and other rubber components.
- b) lubricants (for example, oil, grease, etc.) and working fluids (for example, battery liquid, coolant, etc.).
- c) inspection, adjustments and other maintenance tasks, as well as all kinds of cleaning work.
- d) damage to the paint-work and consequent corrosion due to external causes, such as stones, salt, industrial fumes and other environmental impact, or inadequate cleaning with inappropriate products.

- e) any damages caused as a result of the defects, as well as any expenses incurred either directly or indirectly as a consequence of the defects (for example, communication costs, accommodation expenses, car hire costs, public transport costs, breakdown truck fees, courier costs, etc.), as well as other financial losses (for example, those caused by the loss of the use of the vehicle, loss of income, time lost, etc.).
- f) any acoustic or aesthetic phenomenon that does not significantly affect the condition or use of the motorcycle (for example, small or hidden imperfections, noise or vibrations that are normal in use, etc.).
- g) phenomena that are the result of the ageing of the vehicle (for example, discolouring of painted or metallic coated surfaces).

Various

- 1.- GG shall have the prerogative to decide, at its own discretion, whether to repair or replace defective parts. Where parts are replaced, ownership of the parts removed shall pass to GG without any other consideration. The GG authorised dealer, to whom the making good of the defects has been entrusted, is not authorised to make any declarations that are binding on GG.
- 2.- In case of doubt regarding the existence of a defect, or a visual or material inspection is required, GG reserves the right to demand the return of the parts which are the object of a claim under Warranty, or to arrange an inspection of the defect by an expert from GG. Any additional obligations arising out of guarantees on parts replaced free of charge, or any other service rendered free of charge, are excluded from the effects of this present warranty. The Warranty on parts replaced within the Warranty Period will end at the expiry date for the Warranty Period of the product concerned.
- 3.- Should it prove to be the case that a defect can not be repaired, the purchaser guaranteed shall have the right to the cancellation of the contract (payment of compensation) or a partial refund of the purchase price (discount), instead of repairing the motorcycle.
- 4.- Any claims against Warranty by the purchaser under the terms of the sale contract with the corresponding authorised dealer shall not be affected by the terms of this present Warranty. Neither will this present Warranty affect those additional contractual rights acquired by the purchaser under the general commercial terms and conditions of the authorised dealer. However, such additional rights may only be exercised through claims against the authorised dealer.
- 5.- Should the purchaser resell the product within the Warranty Period, the duration and conditions of the present Warranty will remain unaltered, in such a way as that the rights to make claims under the present Warranty in accordance with the terms and conditions set out in this present document shall be transferred to the new owner of the motorcycle.



GASGAS

RECOMIENDA EL USO DE ACEITE:
RECOMMENDS THE USE OF OIL:
RECOMMANDE L'USAGE DE L'HUILE:
CONSIGLIA L'USO D'OLIO:
EMPFFIEHLT DEN GEBRAUCH VON ÖL:



PUO10638006

JUNIO / JUNE / JUIN / GIUGNO / JUNI 2006

C/ UNICEF nº 17 · Poligon Industrial Torremirona · 17190 Salt (Girona) SPAIN · Tel: +34 902 47 62 54 Fax: +34 902 47 61 60
E-mail: officegg@gasgasmotos.es / partsgg@gasgasmotos.es