

WILD HP 450-07

MANUAL DEL USUARIO

USER MANUAL

MANUEL D'ENTRETIEN

LIBRETTO D'USO

BETRIEBSANLEITUNG

GAS GAS

INTRODUCTION

GAS GAS thanks you for the trust you have placed in us.

By choosing the new WILD H.P. 450 you have just entered the great GAS GAS family and, as a user of the number one off-road motorbike manufacturer, you deserve the distinguished treatment that we wish to offer to you both in our after-sale relationship and in the explanations that we provide in this manual

Our WILD H.P. is a sporting quad bike designed by and for competition. You will appreciate the high level of technical perfection and reliability as well as a meticulous design and high performance.

This manual will provide you with a solid basic knowledge of the characteristics and machine handling. It also contains important safety instructions and provides information about the special skills and techniques required to drive this machine as well as the basic maintenance and inspection processes.

Thank you for your confidence and welcome to GAS GAS motos SA.

GENERAL WARNINGS

Read this Manual carefully. It provides all the necessary information for your safety, and that of others, as well as guaranteeing the correct conservation and maintenance of the GAS GAS quadricycle you have just acquired.

READ THIS MANUAL COMPLETELY BEFORE USING THE MACHINE.

Important information about this manual

The information of special importance is signalled in this manual with the following notation:

WARNING

The WARNING symbol identifies special instructions or procedures that, if not correctly followed, could result in personal injury, or even death for the person using the vehicle, those in the proximity and those technicians responsible for its inspection and maintenance.

CAUTION

This caution symbol identifies special instructions or procedures that, if not strictly observed, could result in damage to or destruction of equipment.

NOTE

This symbol indicates points of particular interest for more efficient and convenient operation.

Inadequate driving skill could cause damage to the environment and conflict with other people. Responsible use of your quadricycle will ensure that these problems and conflicts do not occur

TO PROTECT THE FUTURE OF YOUR SPORT, MAKE SURE YOU USE YOUR QUADRICYCLE LEGALLY, WITH CONCERN FOR THE ENVIRONMENT, AND RESPECT THE RIGHTS OF OTHER PEOPLE.

Quad riding is a fantastic sport, and we hope you will enjoy it to the fullest.

This manual has been compiled with the data and specifications available at the time of printing. Any difference there may be regarding your vehicle will be due to improvements in production and in quality. GAS GAS Motos S.A. are constantly improving their vehicles so that you may enjoy them more.

WARNING

Hydrogen gas produced by the battery may explode if exposed to open flame or sparks.
Keep the area ventilated and free from naked flames.

CONTENT

- Presentation.....	3	Parking brake.....	22
- General warnings.....	4	Chain.....	22
- Contents.....	5	Throttle grip.....	23
- Specifications.....	7	Lights.....	23
- Information about your safety.....	8	Tyres.....	23
- Important information.....	10		
Identification number.....	10	- Using the QUAD.....	24
- Component location.....	12	Starting the engine.....	24
- The main parts of the QUAD.....	14	Changing gears.....	25
Ignition key.....	14	Starting the vehicle.....	26
Start.....	14	Stopping the engine.....	26
Lights.....	14	Running in engine.....	26
Emergency lights.....	15	Parking on slopes.....	27
Throttle grip.....	15		
Clutch lever.....	15	- Driving the QUAD. Practical recommendations.....	28
Front brake handle.....	16	Become familiar with your QUAD.....	28
Rear brake pedal.....	16	Drive with care and common sense.....	28
Steering lock.....	16	How to turn your QUAD.....	29
Shift pedal.....	17	Uphill.....	30
Fuel tank cap.....	17	Downhill.....	30
Seat.....	17	Crossing slopes.....	30
Battery.....	17	Going across shallow water.....	31
Front guard.....	18	Riding on rough terrain.....	31
Rear guard.....	18	Sliding and skidding.....	31
Footrest assembly.....	19		
		- Tuning.....	32
- Checks to make before		Tuning the front suspension.....	32
starting the machine.....	20	Tuning the rear suspension.....	33
Front and rear brakes.....	20		
Fuel.....	21		
Cooling system.....	22		

- Regular maintenance and adjustments.....	34
Maintenance chart.....	34
Clutch lever adjustment.....	38
Adjusting brake handle and pedal.....	35
Checking the brake fluid level.....	39
Level of rear brake fluid.....	37
Checking the front and rear brake pads.....	37
Changing wheels.....	38
Swing arm shaft.....	38
Adjusting and lubricating the chain guide.....	38
Checking the coolant level.....	39
The air filter.....	41
Spark plug.....	43
Inspecting and lubricating the cables.....	45
Replacing lights.....	45
Front side light.....	46
Rear lights.....	46
Gearbox.....	47
Adjusting front headlight.....	47
Engine oil.....	47
Idling adjustment.....	50
- Cleaning, lubrication and storage.....	50
Cleaning.....	50
Lubrication.....	51
Storage.....	52
- Instructions for multifunction.....	53
- Table of tightening torques.....	59
- Diagram of tightening torque locations.....	60
- Fault diagnosis.....	61
- Warranty manual.....	67

SPECIFICATIONS

ENGINE

Displacement:	443 cc
Type:	Single-cylinder, 4-stroke with 4-valve cylinder head.
Cooling system:	Liquid.
Bore x stroke:	95 x 62.6 mm.
Injection system:	
Ignition:	Integrated with injection system.
Clutch:	Hydraulic multi-disc .
Gear box:	5 speeds and reverse.
Transmission:	Primary with gears, secondary with chain.
Starter:	Electric engine and auxiliary pedal.

CHASSIS

Chassis:	Multi-tube twin-cradle frame, made from Cr-Mo steel (Chrome alloy).
Front suspension:	Trapezoidal arms with 2 multi-adjustable shock absorbers.
Rear suspension:	Aluminium alloy swing arm with no welding. Progressive system with single multi-adjustment shock absorber.
Front brake:	2 180 mm auto ventilated disc brakes with floating double-piston calliper.
Rear brake:	Self-ventilated 220 mm disc with floating two-piston calliper.
Rims:	Aluminium
Front tyres:	21 x 7.00 – 10"
Rear tyres:	20 x 11.00 – 9"
Kick-starter:	Forged aluminium
Engine, disc and chain sprocket shield:	Hardened aluminium plate and carbon fibre guard.

DIMENSIONS

Wheelbase:	1.280 mm
Overall width:	1.200 mm
Curb weight:	175 Kg
Fuel tank capacity:	18 litres

SAFETY INFORMATION

The QUAD is not a toy: driving it can be dangerous.

The QUAD is driven differently from other vehicles such as cars and motorbikes. Even during routine manoeuvres like turns, driving on slopes or over obstacles, collisions or tumbles can occur if the correct precautions are not taken.

WARNING

If these instructions are not heeded, you may suffer serious injury or even loss of life.

- Do not drive the QUAD before reading the following sections: "*Safety information*", "*Use of the QUAD*", and "*Main parts of the vehicle*". Even if you are an experienced QUAD driver, not all makes and models are equal and it is necessary to know the machine in depth before starting on your first outing.

- You are not allowed to carry a passenger, and the vehicle is not equipped for that purpose.

- Sit correctly with both hands on the handlebars, your feet on the footrests and your back straight up.

- Always control your speed according to your skills, the weather and ground conditions.

- Pay attention to surface changes and control your speed when you are not familiar with these conditions.

- Always perform the routine checks described in this manual before using the QUAD, to make sure it is in perfect operating condition,
- Riding a QUAD is not like driving any other vehicle, especially when cornering. Practise on flat, open ground free from obstacles and other vehicles.

Read the recommendations made by this manual in the section "*Use of the QUAD*".

- The same applies to steep climbs or descents. Start practicing with minimum slopes and raise the difficulty little by little. Advice about this is also included in the section mentioned above.

- In case the engine stalls, follow the procedure described in this manual. If the engine stalls and the vehicle starts rolling backwards, follow the special braking procedure described in this manual. Get off the vehicle to the higher on the slope than the vehicle. Remember that your safety comes before that of the machine, and it is important to keep this priority in mind.

- When traversing a slope, move your weight to the uphill side; read the manual regarding this. Avoid excessively slippery slopes or loose surfaces.

- Never try to overcome big obstacles, like rocks or trunks. This vehicle has not been designed for this purpose; you may damage the vehicle and/or cause injury to yourself.

- Do not try to make the vehicle slide sideways if you don't master this technique; this is a particularly dangerous manoeuvre. Like in the cases described above, do some testing on flat, wide, obstacle-free ground beforehand and follow the advice given in this manual. You must never lose control of the vehicle.

- This vehicle has been designed to go through water no deeper than 35 cm. Do not use the vehicle in fast moving water; carefully read the instructions regarding this type of terrain. Take into account that braking efficiency is diminished when the brakes are wet. When coming out of the water, brake several times so that they dry more quickly by friction.

- Always use the tyre size and type described in this manual.

WARNING
<ul style="list-style-type: none">- Always stop the engine before and during refuelling.- While refuelling, do not smoke, fuel is highly flammable and may explode under certain conditions. Keep the engine off at all times. Make sure the area is well ventilated and free from any source of flame or sparks; this includes any appliance with a pilot light. The fuel might catch fire causing burns. Avoid spilling fuel over the engine, exhaust or silencer.- When transporting a quad with a trailer, ensure it is always vertical.- Fuel is poisonous. In case of accidental ingestion, abundant vapour inhalation or contact with eyes, seek medical help immediately. If fuel comes in contact with your skin, wash it with soap and water. If fuel is spilled on clothes then change them.- Always ride your QUAD in well-ventilated areas. Do not start the engine or keep it running in enclosed areas. The exhaust vapour is poisonous and may lead to loss of consciousness or even death in a short time.

IMPORTANT INFORMATION

The vehicle leaves the factory with some elements not fitted, in order to make transportation easier. The dealer will make sure each element is correctly fitted and you will receive the QUAD ready for use. Thus, this paragraph is purely for your information.

A carburettor-adjustment kit is included; the adjustments must be performed by an expert and only when necessary. The carburettor is already tuned, so setting changes are not initially required.

A tool is also enclosed to adjust the chain and to centre the swing shaft. Do not lose it; it will be extremely useful.

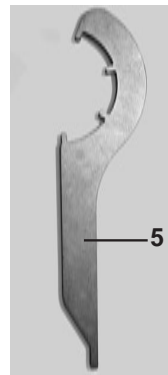

5. Chain and swing arm adjustment tool.

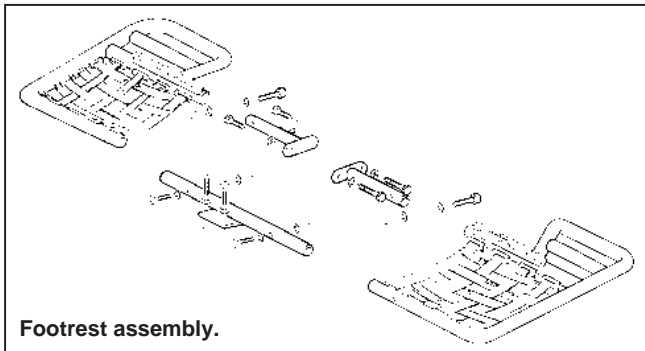

Footrest assembly.

IDENTIFICATION NUMBER

Write down your vehicle's identification number (serial number), the information on the model label and the key identification number in the spaces provided, to make paperwork easier should any spares be required or as a reference in case of vehicle loss.

Serial number

(B) is located printed on the front. Indicates the frame number with which the vehicle is registered.

--

SERIAL NUMBER

NOTE

The vehicle's serial number is used to identify your machine.

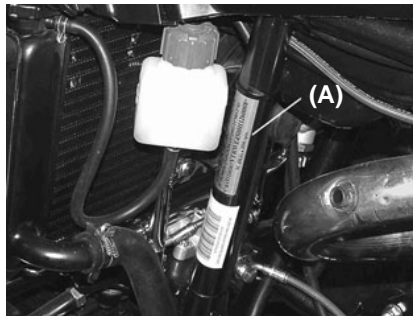
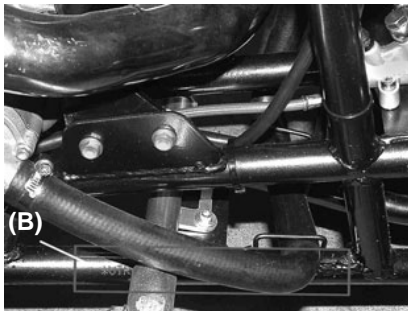

Quality approval plate

The QUAD is fitted with its own corresponding quality approval plate (A), with the serial number, also printed on the front of the vehicle. The data must coincide with that in the documents. We recommend noting the data in the following space provided.

HOMOLOGATION PLATE

Key identification number

The vehicle has two pairs of keys. The first (C) is used for the steering lock while the second (D), and most important, is the ignition key. The key identification number (C) appears where the keys are joined, and the key identification (D) is engraved on the key shaft itself. This number is used to order a new set of keys in case of loss.



KEY NUMBER

LOCATION OF COMPONENTS

GAS GAS WILD HP 450

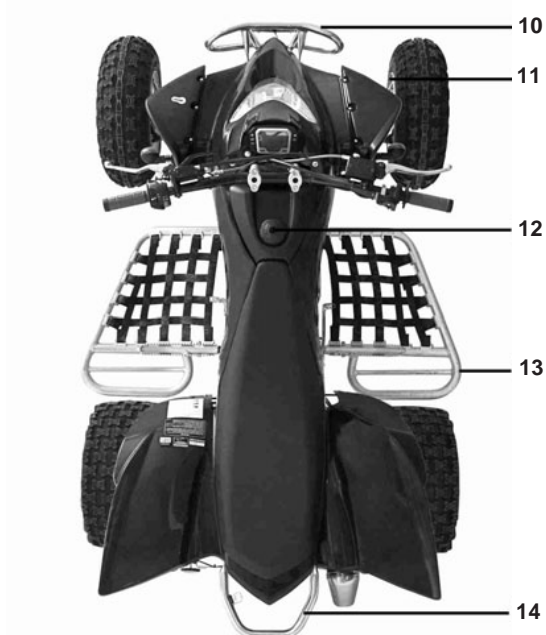
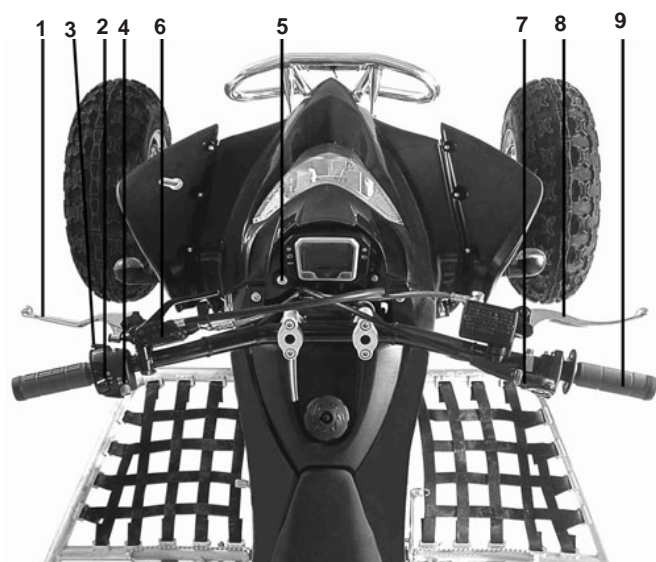

- 1- Clutch lever
- 2- Light switch
- 3- Flash beam
- 4- High beam switch
- 5- Ignition key
- 6- Parking brake
- 7- Starter control

- 8- Front brake lever
- 9- Throttle control
- 10- Front guard
- 11- Brake pads
- 12- Fuel tank cap
- 13- Footrest grids
- 14- Rear protection

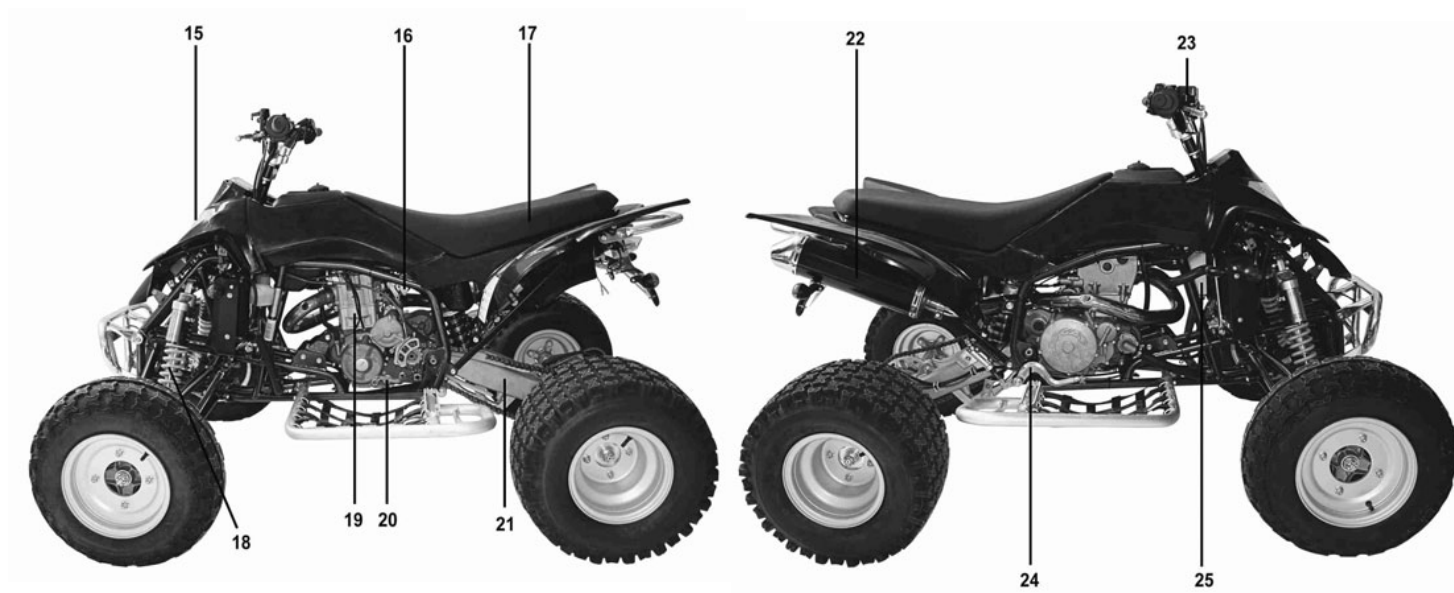

- 15- Front guard
- 16- Throttle housing
- 17- Seat
- 18- Front shock absorber
- 19- Engine
- 20- Shift pedal

- 21- Swing arm
- 22- Exhaust pipe
- 23- Front brake fluid tank
- 24- Brake pedal
- 25- Oil recovery tank

THE MAIN PARTS OF THE QUAD

IGNITION KEY

The ignition lock (A) is located on the front part of the handlebars. To turn the ignition ON, turn the key clockwise to the "ON" position. To turn the ignition OFF, turn the key anti-clockwise to the "OFF" position.



STARTER

The quad is fitted with an electrical starter motor and a manual starter by means of the pedal. The control (B) is located to the right of the handle bar. The pedal (C) is located on the right hand side of the quad in an initial rest position, pull until it is in operation position.

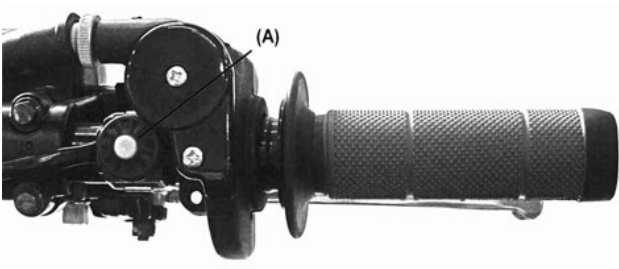

LIGHTS

NOTE

The headlights and rear lights will only work when the ignition key is in the ON position.

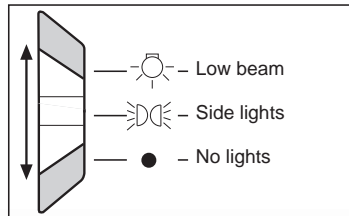

Switch (C) has three positions, initially in the "OFF" position.

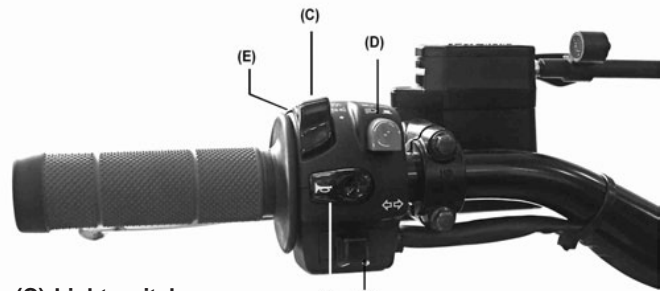

- (C). Light switch.
- (D). High-low beam switch.
- (E). Overtaking lights
- (F). Indicators.
- (G). Horn.

To turn on the low beam lights (☞) push the switch (C) to the position (☞). To turn on the high beam (☛) push the red button (D). The high beam indicator on the instrument panel will be turned on (☛). To turn off the lights push the switch to position (●).

Indicators **(F)** are located in the lower part of the same left hand side grip. Note that pushing the switch to the right turns on the right indicator, and to the left to operate the left indicator. On the same group we will find the horn button **(G)**.

DISTRESS LIGHTS

The button is located on the front part of the vehicle **(F)**, in front of the handlebars. This works even when the ignition is off.

NOTE

Regarding the use of this lights, follow the legal conditions of each country.



THROTTLE GRIP

Before starting the engine, check that the throttle works smoothly **(I)**. Make sure it slides smoothly back to idle when the grip is released. The grip has a return spring that puts the engine to idle and slows the QUAD down when the control is released.

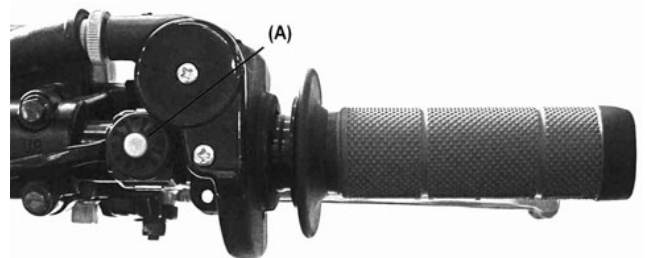

WARNING

If the throttle is not working properly, it may be difficult to accelerate or decelerate as desired. This could result in an accident. Check the correct operation of the throttle before starting the engine. If the throttle does not work smoothly then find the cause. Solve the problem before using the machine, or go to a specialised workshop.

CLUTCH LEVER

The clutch lever is located on the left side of the handlebar. It is used to engage or disengage the clutch **(J)**. To make the clutch work smoothly, the lever must be pulled quickly and released slowly.



FRONT BRAKE LEVER

The front brake lever **(A)** is located on the right side of the handlebars. Operate it to apply the front-wheel brakes.

**REAR BRAKE PEDAL**

The rear brake pedal **(B)** is located on the right hand side of the lower chassis. Operate it to apply the brake to the rear wheels.

**STEERING LOCK**

As its name suggests, this mechanism allows us to lock the steering.

The handlebars should be turned fully to the left, then the key inserted in the lock **(A)**. Turn the key to the left, press it in than turn it to the right and remove it.

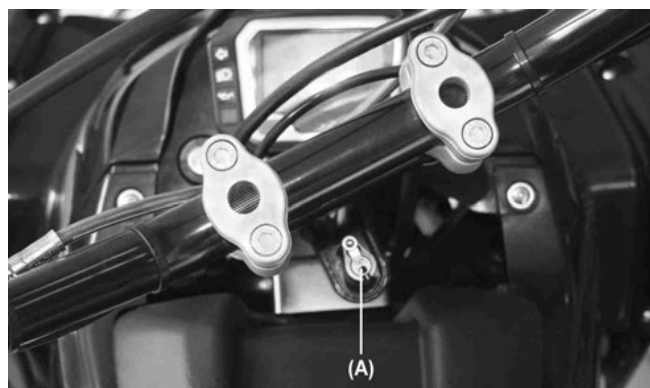

SHIFT PEDAL

The machine is fitted with a 5-speed gear box. The gearchange pedal (E) is on the left side of the engine and is used with the clutch when shifting gear.

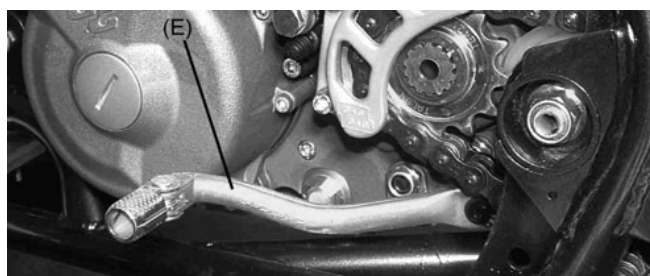

FUEL TANK CAP

To open the fuel tank cap turn it anticlockwise.

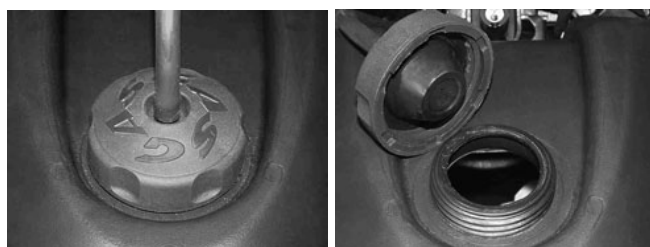

SEAT

To remove the seat, pull the closing tab of the seat (A) and raise it. Then pull in the same direction

NOTE

When putting the seat back in the normal position, ensure it is secured.

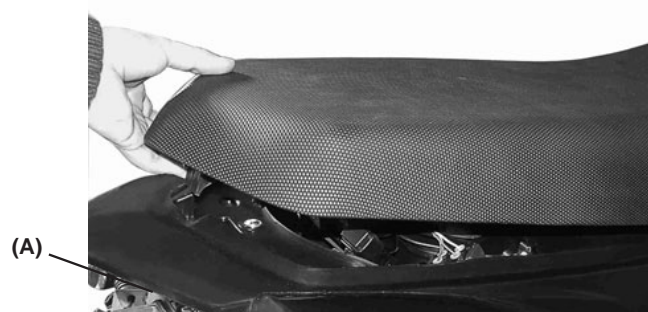

BATTERY

This battery is maintenance free and checking the fluid level is not required. It is advisable to check the charge of the battery periodically. The operating instructions for the battery are as follows:

1. Check the battery tension in open circuit status (disconnected).
2. In case the battery's tension is below 12.60 V, or if the storage period has exceeded 6 months, the battery has to be recharged following the instructions in paragraph 3.2. If the battery voltage is above 12.60 V, the battery can be installed on the vehicle without having to recharge it.
- 3.1. Constant voltage charge mode.
- Constant voltage = 14.40 – 14.7 V

- Initial charge current = 0.1 – 0.5 Cn
 - Charge duration = 6 hours minimum / 24 hours maximum.
- 3.2. Constant power charge mode.
- Maximum charge current = 0.1 Cn
 - Recommended charge time = 5 - 8 hours.
 - The product (charge current) X (charge duration) must be within the range: 0.5 – 0.8 Cn

NOTE

In the case that a different mode of charging is used to those established here, never exceed the maximum allowed currents nor the maximum charge duration of 24 hours.

CAUTION

Not using the standard manner of charging may seriously shorten the battery life.
Never exceed the standard charge.

CAUTION

Inverting the polarity of the battery terminals may cause battery charge problems and cause damage to the battery system.
The red terminal is positive (+) and the black terminal is negative (-).

FRONT GUARD

The front guard juts out from the QUAD assembly. In case of a frontal collision, the protection, attached directly to the frame, will absorb the impact and protect the steering and the rest of the vehicle from significant damage.

**REAR GUARD**

Likewise, the rear guard (D) also protrudes from the vehicle. This guard prevents the QUAD from falling over backwards, which might result in serious injuries.

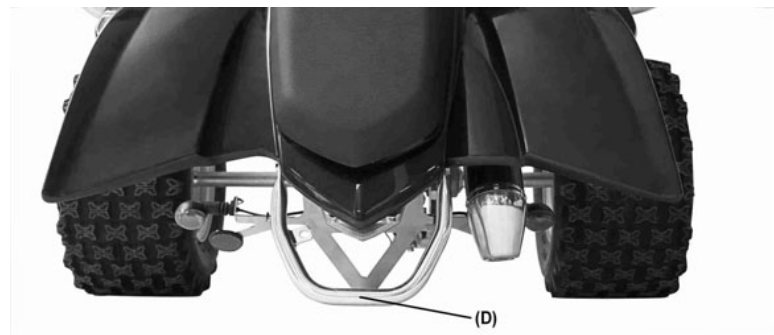

NOTE

In case of steep climbs, the rear guard will not prevent the machine from rolling over backwards, so be prudent in climbs and examine the terrain carefully.

FOOTREST ASSEMBLY**WARNING**

The footrests and foot guards are an essential protection system for safe driving of the QUAD. The quadricycle has large wheels that could easily trap a leg causing serious injuries.

The quad bike has a pair of foot rests (**E**), one on the right and the other on the left. Both footrests have a mesh. The whole assembly will protect feet and legs from the wheels in case of a loss of balance or if feet slip from the footrests. Width is provided for freedom of movement.



VERIFICATIONS TO BE MADE BEFORE STARTING THE VEHICLE**WARNING**

Always inspect the QUAD before use, to ensure it is safe to operate without any danger.
Always follow the inspection and maintenance procedures and programs described in this manual. Failure to inspect the machine increases the risk of accident or breakdown.

FRONT AND REAR BRAKES**WARNING**

Before driving, always check the brakes. Do not drive the QUAD there is any braking problem or if a loss in braking capacity is possible, this could result in an accident. If there is any problem that cannot be solved using the procedures described in this manual, go to a specialised workshop to have the QUAD checked.

Disc and disc pad wear is automatically compensated for and has no effect on the brake lever or pedal action. So there are no parts that require adjustment on the brakes except brake lever play and the brake pedal position and play.

Brake lever and pedal

Ensure that there is no play in the front brake lever (1). If so, check the condition of the brake pads and consult the "Adjustments and maintenance" section.

Check there is no free play in the front brake lever (2).

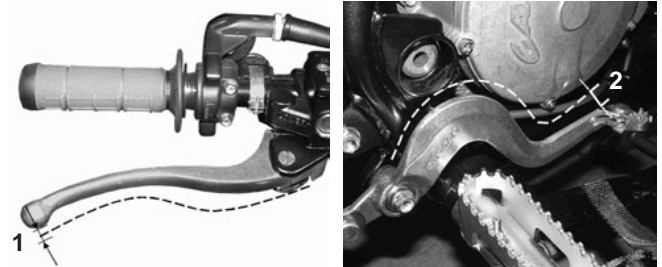

Check that the brake pedal height is correct. If not, have it adjusted at a specialised workshop.

Check the operation of the lever and pedal. They must move smoothly and must feel firm when the brakes are applied. Otherwise, have a specialised workshop inspect the vehicle.

Brake liquid level

Check the brake liquid level. Add liquid if necessary. (See the Maintenance section of the manual)

Recommended fluid D.O.T 3 or D.O.T 4

NOTE

The fluid issued at the manufacturers is D.O.T.4.

Brake liquid leaks

Check for brake fluid leaks in the brake line joints or fluid reservoirs. Apply the brakes firmly for about one minute. In case of a leaking, have a specialised workshop inspect the vehicle.

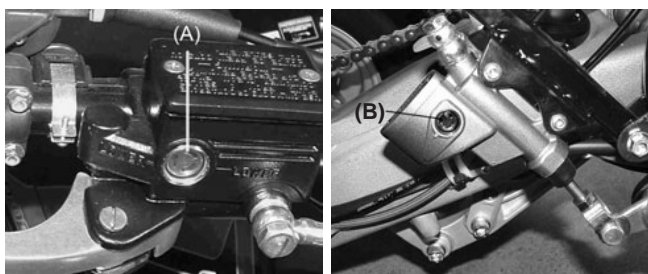

(A) AND (B). Front and rear brake fluid reservoirs.

Brake operation

Test the brakes by riding slowly, to make sure they work to perfection. If the brakes do not provide adequate braking power, check the brake pads for wear.

FUEL

The GAS GAS WILD 450 cc. has a four stroke engine and requires 98 octane, unleaded petrol.

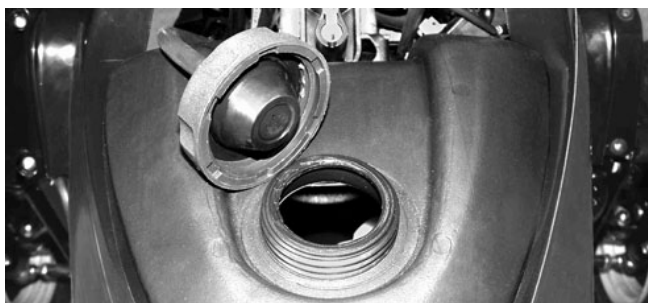

Always make sure there is enough fuel in the fuel tank.

NOTE

It is recommended not to let the fuel level run too low. If there is dirt at the bottom of the fuel tank, it could enter the engine and may damage it.

To open the fuel tank cap, pull upwards on the tab and then insert one of the two red keys that came with the GAS GAS quad.. Rotate to the right and pull on the cap with the key still in place, as shown in the above image.

Recommended fuel

CAUTION

Only use lead-free petrol. The use of leaded petrol will seriously damage internal components of the engine.

OCTANE RATING MEASUREMENT METHOD	MINIMUM OCTANE NUMBER
Antiknock Index (RON + MON) 2	90
Research Octane No. (RON)	98

WARNING

Gasoline is extremely flammable and can be explosive under certain conditions. Always stop the engine and do not smoke. Make sure the area is well ventilated and free from any source of flame or sparks; this includes any appliance with a pilot light.

COOLING SYSTEM

Radiator hose

Check the radiator hoses for cracks or deterioration, and connections for leaks.

Radiator

Check the radiator fins for obstruction by insects or mud. Clean off any obstructions with a stream of low-pressure water.

CAUTION

Using a high-pressure water source could damage the radiator fins and render it ineffective. Do not obstruct or deviate the radiator air intake by installing non-approved accessories. Interfering with the radiator could cause overheating and result in engine damage.

Coolant fluid

This absorbs excessive heat from the engine and transfers it to the air at the radiator. If the level of fluid has diminished constantly, the engine may overheat and become seriously damaged.

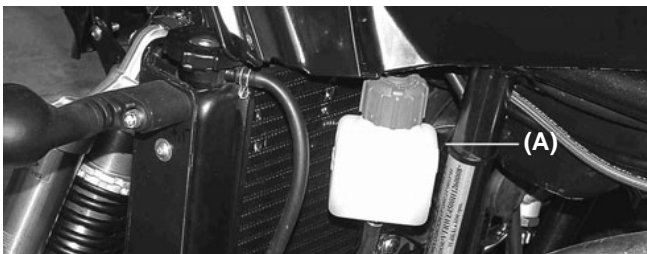

Check the cooling liquid level in the reservoir (A) with the cold engine (the liquid level will vary with engine temperature). The level is correct when it is between the two marks. If it falls below the lower mark, add antifreeze. Change the coolant every two years.

NOTE

The liquid must be between the two marks, not above the upper mark or below the lower.

PARKING BRAKE

The parking brake is located on the left of the handlebars. It is used to park and immobilise the vehicle when so required.

It acts directly on the rear brake calliper. To use it, pull the lever in the direction indicated by the arrow.

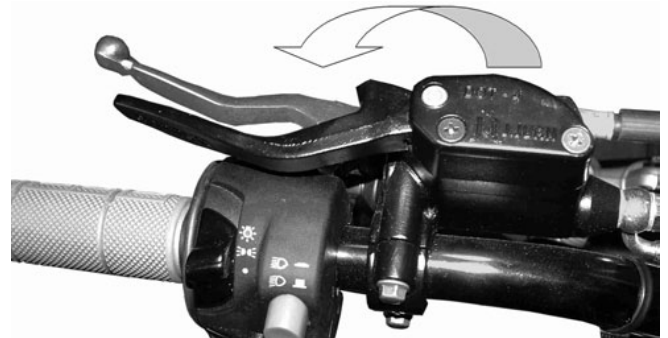

CHAIN

Check the overall condition of the chain and its tension before each run. Lubricate and adjust the chain as necessary (See section 12 *Maintenance*).

THROTTLE GRIP

Check the throttle grip for correct operation. It must accelerate smoothly and return to the idle position when released. If necessary, service the grip and grease the moving parts so that it works correctly.

LIGHTS

Check the headlight and the brake lights to make sure they are in perfect condition. If necessary, make any reparations necessary.

TYRES

Always use the recommended tyres.

WARNING			
The use of inadequate tyres or riding the vehicle with incorrect or unequal tyre pressures may lead to loss of control, with the subsequent risk of accident.			

	Manufacturer	Dimensions	Model
Front		21 x 7,00 - 10"	
Rear		20 x 11,00 - 9"	

The tyres must be inflated to the recommended pressures. Measure the tyre pressure with a low pressure gauge.

CAUTION	
Check and adjust the pressures when the tyres are cold. Pressures must be the same on both sides.	

	Recommended	Minimum	Max
Rear	0,400 bar/ 40 Kpa	0,370 bar/ 37 Kpa	0,430 bar/ 43 Kpa
Front	0,450 - 0,500 bar/ 45 - 50 Kpa	0,420 - 0,470 bar/ 42 - 47 Kpa	0,480 - 0,530 bar/ 48 - 53 Kpa

Tyre wear-out limit:

Check the manner in which tyre wear occurs. If the tyre is worn out at the centre, this means that the tyre pressure is too high.

If the tyre wears out at the edges, the tyre is a little flat. The tyre must be worn out equally over its surface. Replace the tyre when the groove depth is below 3mm.



Minimum distance from stud (H): 3 mm.

USING THE QUAD**WARNING**

Read the User's Manual carefully so as to become familiar with all of the controls. Loss of control may cause accidents or injuries.

STARTIN THE ENGINE**CAUTION**

Before starting the engine for the first time, consult the section "Running in the engine".

WARNING

In cold weather, make sure that all the cables work smoothly before using the QUAD. If the cables are frozen or do not work smoothly you may lose control of your QUAD and suffer an accident.

1- Apply the handlebar brake as indicated above.

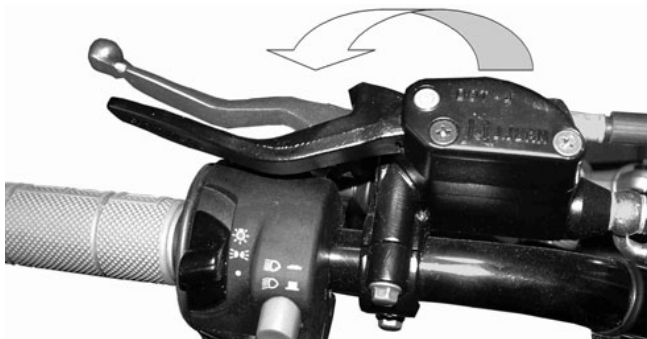
**WARNING**

- Always use the parking brake before you start the engine. QUAD might start move off unexpectedly if the brake is not on. This could lead to a loss of control or to a collision.
- Remember to release the parking brake before moving off. The brake will overheat if the QUAD is used without releasing it. The brake will loose efficiency and could cause an accident. It would also wear out prematurely.



- 2.- Turn the ignition key **(A)** clockwise to the ON position.
- 3.- Then the rider should be secured to the emergency stop system (see the recommendations in the section "The main parts of the vehicle/ emergency stop").
- 4 - Without using the throttle, press the electric start button.

NOTE

If the engine does not start, turn the key to the "OFF" position and wait some seconds before trying again. These attempts should be as short as possible, in order to preserve the battery charge

GEARBOX

This vehicle is fitted with a 5-speed gearbox. It is a sequential gearbox, which means that in order to reach third gear from first gear we have to go through second gear, that is, the gears go up or down gear by gear.

To engage first gear from neutral, pull in the clutch lever and push down on the shift pedal then release the pressure on the shift pedal and gently release the clutch lever. (In the next section the process of starting the vehicle is described in more detail).

CAUTION

When changing gears, press firmly on the shift pedal to ensure complete, positive shifting. Careless, incomplete shifts can cause the transmission to jump out of gear and lead to engine damage.

CAUTION

Do not run for a long time with the engine off, or tow the QUAD for long distances. Even in neutral, the lubrication system for the gearbox is only activated when the engine is on. Insufficient lubrication may lead to faults.

STARTING THE VEHICLE

1.- Operate the throttle twist-grip.

CAUTION

Release the throttle to change gear, otherwise the engine and transmission may be damaged.

- 2.- As we have already explained, the clutch must be activated to engage the first gear from neutral, then press on the shift pedal, release the clutch slowly and accelerate gradually.
- 3.- Once the desired speed has been achieved, release the throttle and, at the same time, activate the clutch lever rapidly.
- 4.- Change to second gear (be careful not to insert neutral).
- 5.- Activate the throttle partially and release the clutch lever gradually.
- 6.- Follow the same procedure to change into higher gears.

WARNING

Excessive acceleration or sudden release the clutch lever too quickly may result in an accident and may cause the vehicle to slide and turn over. Operate the throttle gradually and release the clutch gently.

To decelerate

To slow down or stop, release the throttle and apply the brakes evenly and gently. As the vehicle slows down, change into a lower gear. Before reducing a gear, wait for the engine speed to fall to the adequate level. Inappropriate use of the brakes or gear shift could cause the tyres to lose grip, resulting in a loss of control and risk of an accident.

WARNING

Make sure the engine's revs are low enough to change into a lower gear. If the revs are too high when changing into a lower gear, the wheels may stop spinning rapidly enough. This might lead to loss of control, with an accident or injury risk. It can also damage the engine and transmission.

STOPPING THE ENGINE

1.- Change into neutral.



2.-Rotate the ignition key anti-clockwise to the OFF position and the engine will stop automatically.

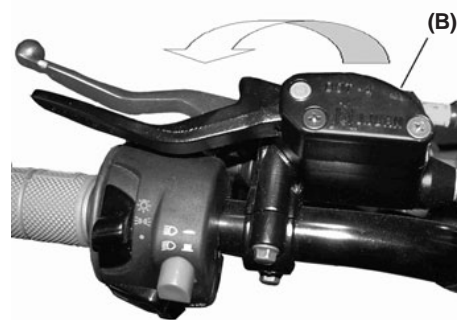

3.- Use the parking brake (B) to park the vehicle.

4- The key may be extracted from the ignition.

RUNNING IN THE ENGINE

The running-in process is a very important element in the life of your QUAD, and we recommend you to follow the instructions below carefully.

NOTE

The running-in period is a time (usually the first 20 hours of use) in which we must take into account several points for engine preparation.

During the first 10 hours we recommend not using more than half-throttle for long periods or in any situation that may cause engine overheating. On the other hand, short accelerations - for 3-4 seconds - are beneficial for the engine and will not be a problem. Each acceleration sequence must be followed by a resting period, so that the engine can release the heat it has generated.

During this 10-hour period, try not to run at constant speed, vary the speed from time to time.

During the following 10 hours (10-20), it is advisable not to use the engine at more than $\frac{3}{4}$ throttle during long periods.

WARNING

The kick-starter must NEVER be operated when the reverse gear is engaged.

PARKING ON SLOPES**WARNING**

Avoid parking on hills or inclined terrain, as the QUAD may move by itself, with corresponding risk of accident. If it is necessary to park on a hill, engage the first gear, apply the parking brake and block the front and rear wheels with rocks or other objects.

1. Use the brakes to stop the vehicle; once it has stopped, engage the first gear.
2. Without releasing the clutch lever, stop the engine. Now the clutch lever can be released.
3. With both the front and rear brakes pressed, activate the parking brake and slowly release the brake pedal.

DRIVING THE QUAD. Practical considerations**BECOME FAMILIAR WITH YOUR QUAD**

This QUAD is destined for experienced riders, to be used in recreational activities.

Even if you are an expert with other types of off-road vehicles and motorbikes, riding the QUAD requires special skills which can only be achieved through practice.

We recommend that you to familiarize yourself with your vehicle on flat ground with no obstacles, and without the presence of other drivers. Do not try difficult manoeuvres until you are totally familiarised with you QUAD.

A QUAD is not designed to jump obstacles, refrain from doing this as the vehicle could be seriously damaged.

WARNING

Do not drive the QUAD without first reading this manual. Ensure that you understand how to use the controls and pay special attention to the section "safety information".

DRIVE WITH CARE AND COMMON SENSE

As we have already noted, driving your QUAD requires special skills which can only be achieved through continuous practice over time. Take your time to learn the basic techniques before attempting more difficult manoeuvres.

WARNING

Never carry a passenger. Carrying a passenger could lead to an accident with the consequent injury risk for the driver and/or passenger. The quadricycle is fitted with an emergency-stop system in case the rider falls off, but it has not been designed to cope with passenger falls.

**THE WILD QUAD IS NOT APPROVED FOR CARRYING A PASSENGER.
ONLY THE DRIVER IS PERMITTED TO RIDE THE QUAD.**

Equipment

- Always wear an approved helmet of the correct size.
- You must also wear: eye protection, gloves, boots, long-sleeve shirt or jacket and long trousers.

WARNING

It is essential to wear the full equipment mentioned above, otherwise the risk of serious injuries or even death is increased.

Verifications before riding

For the due safety and care of the QUAD, always do the verifications before riding. They are explained in detail in the section "Verifications to be made before starting the vehicle."

While riding

Always ride with the footrests and protections secured, they will protect you from serious injuries in the legs and feet. Always keep feet on the foot rests while driving and both hands on the handles.

WARNING

As we have explained in this manual, the use of the footrests and guards is essential for your physical integrity.

Modifications

Do not modify this QUAD by fitting or using inadequate accessories. The parts and accessories added to this vehicle must be original GAS GAS parts or equivalent parts designed for use on this QUAD, and must be fitted and used according to the instructions. Fitting inadequate accessories or modifying the vehicle may provoke changes in the machine's handling, which, under certain conditions, might lead to an accident. In case of doubt, consult an authorised dealer.

Exhaust system

The temperature of the QUAD's exhaust system increases with use. To prevent burns, do not touch it. Park the QUAD in a specially reserved place or somewhere away from pedestrians or children.

HOW TO TURN WITH YOUR QUAD

At low speeds you will have no problem to turn with the handlebars. On the other hand, if speed increases the difficulty to turn will also increase. The back wheels are rigidly mounted on the same axle and turn at the same speed, so the QUAD will resist turning into corners unless the inside wheel loses some traction. A technique is required to turn, and it is important to learn the skill on flat terrain, with no obstacles and at a moderate speed. The speed may be increased as your skills increase.

When approaching the corner, slow down and start to turn the handlebars in the desired direction. Lean your body to the inner curve of the corner to compensate the inertia produced by speed. Use the throttle to keep a uniform speed all through the corner. This manoeuvre may be used to take the corner correctly. The picture shows the technique.



**1.- Turning to the right.
2.- Turning to the left.**



If the technique used is not correct, the QUAD will probably continue in a straight line. If it does not turn, stop and practise the procedure again.

If the vehicle starts to turn over towards the outside of the corner, reduce speed, compensate with the steering or lean even more to the inside. It could also be necessary to reduce your speed gradually and to turn the steering to the outside of the corner to avoid tumbling over.

CLIMBING HILLS

We recommend starting gradually on gradual slopes and increase the inclination as your skill improves. In any case, avoid loose or slippery surfaces or obstacles at any time, as we have already mentioned, the QUAD has not been designed to jump obstacles so it is advisable to avoid doing this.



It is important to transfer your weight to the front part of the QUAD during climbs. This can be done by leaning forward and moving the seating position back and, if slope is very steep, standing on the footrests and leaning forward a little.

WARNING

Do not accelerate or change gear suddenly. The QUAD could tumble over backwards. In this case the rear guard would not help, as the inertia would be considerable. Never go over the top of a climb at full speed. On the other side, there could be an obstacle, a steep descent, another vehicle or even a person.

While climbing a slope you discover that you have not correctly calculated your ability to reach the top, turn the QUAD while you still have some traction (if there is enough room) and descend.

If the vehicle starts rolling backwards, do not use the rear brake or try to insert a gear, the QUAD might easily tumble over backwards. Get off the vehicle immediately on the ascending side of the slope. Remember that your safety comes first.

DESCENTS

When descending a slope with the QUAD, transfer your weight to the back, to the uphill side of the slope. Move to the back of the seat and remain seated with your arms straight.



Select a short gear that allows the engine compression to act as the main brake. Braking incorrectly may lead to a loss of traction. See the example in the image.

TRAVERSING SLOPES

To cross a slope with your QUAD you must place your weight correctly to maintain correct balance. Before attempting to negotiate a slope make sure you have learnt the basic skills on flat ground. Avoid slippery sections and rough terrain that may cause you to lose balance.

When crossing the slope, keep your body inclined uphill. It might be necessary to correct direction on loose surfaces by turning the steering slightly uphill. When crossing slopes, do not perform tight turns up or downhill.

If the QUAD begins to turn over, gradually turn downhill if there is no obstacle in the way when stability is regained, turn once more in the required direction.

SHALLOW WATER

With the QUAD you can, at slow speed, cross shallow water up to 35 mm in depth. Before entering the water, choose carefully a path to cross. Choose a place with no sudden descents and avoid rocks and other obstacles that may make affect the stability of the QUAD or cause it to slip. Drive carefully and slowly.

WARNING
Do not cross fast waters or waters deeper than specified in this manual. Remember that the brakes will get wet and lose braking efficiency. Check the brakes after leaving the water. If necessary, operate the brakes a few times in order to dry them by friction.

NOTE

After crossing water with the QUAD, eliminate trapped water by unplugging the retention tube at the bottom of the air filter housing. Wash this in fresh water if the machine was in salt water or mud.

RIDING ON ROUGH TERRAIN

Take precautions when riding on rough terrain. Beware of any obstacle that may damage or destabilise the QUAD or even cause

an accident. Keep your feet firmly placed on the footrests at all times. Avoid jumping over obstacles with the vehicle as this could lead to loss of control and damage to the machine.

SLIDING AND SKIDDING

When riding over slippery or loose surface, use caution. An uncorrected unexpected slide could result in a serious accident. To reduce the tendency of the front wheels to slide on slippery surfaces, sometimes it is useful to put your body weight over them.

If the rear wheels start to slide sideways, control can usually be regained by turning the handlebars towards the slide, if there is enough space available. It is not recommended to accelerate or brake until a skid has been corrected.

With practice, after some time you can dominate the controlled-sliding technique. Before attempting to do so you must choose the ground carefully, as both stability and control are reduced. Note that it is best to avoid skidding manoeuvres on extremely slippery surfaces such as ice given that this could result in a total loss of control.

NOTE

Learn to control your slides safely by practising at low speed on flat ground with no inclination.

TUNING

TUNING THE FRONT SUSPENSION

Formed of two trapezoidal arms with 2 multi-adjustable shock absorbers
 To suit various riding conditions, the spring preload of the shock absorber can be adjusted or the spring can be replaced with an optional one. Also the damping force can be adjusted easily so changing oil viscosity is unnecessary.

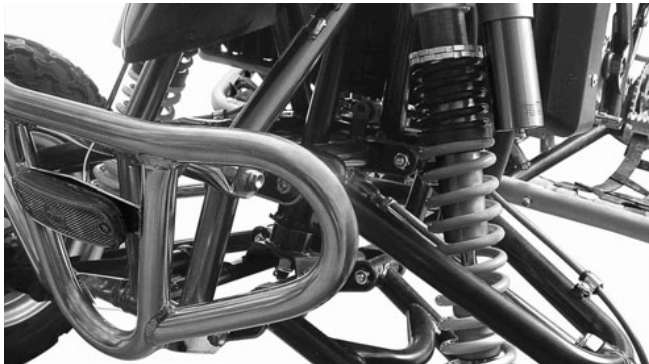

Adjusting the rebound

WARNING

Suspension parts will be hot during operation. Never touch the compression adjustment, the rebound adjustment nor the oil reservoir with bare hands nor with any other part of the body until the compression components have cooled down.



To adjust the rebound, turn the knob **(B)** on the lower part of the shock absorber by hand.

There is a possible 22 "Clicks" (adjustments) in total.
 The rebound is normally set to 7 "Clicks".

Turn the knob clockwise until the end, then it is completely closed. Turn the knob anti-clockwise 7 clicks, now it is at the standard setting. At 0 "clicks" the rebound is hard, oppositely, at 22 "clicks" the rebound would be very soft.

WARNING

Always adjust the right and left absorbers to the same level. Unequal adjustments will cause handling problems and loss of stability, with the subsequent risk of accident.

Adjusting the compression

To adjust the compression, turn the knob **(A)** on the upper part of the shock absorber by hand. Turning anti-clockwise to the limit will close it completely.

There are a possible 38 "Clicks" (adjustments) in total.
 The compression is normally set to 20 "Clicks".
 Fully hard compression is at 0 "clicks".
 Fully soft compression is at 38 "clicks".

TUNING THE REAR SUSPENSION

The back suspension is composed of an aluminium alloy swing arm with no welding. It is a progressive system using rods, with an adjustable shock absorber

Adjusting the rebound

To adjust, turn the screw **(A)** of the lower section of the shock absorber

The maximum number of 'clicks' is 50.
The standard adjustment is 25 'clicks'

Turn the knob clockwise until the end, then it is completely closed. Turn the knob anti-clockwise 25 clicks, now it is at the standard setting. At 0 "clicks" the rebound is hard, oppositely, at 50 "clicks" the rebound would be very soft.

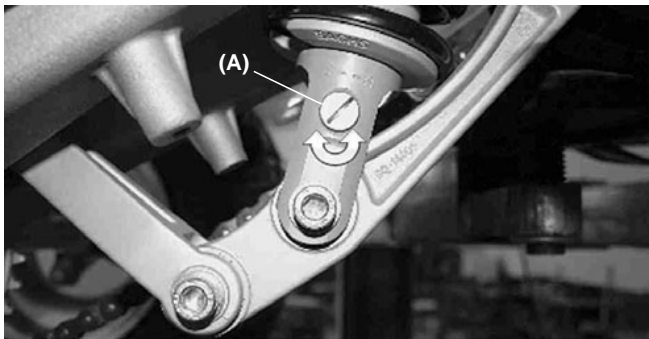

Adjusting the compression

To adjust this turn the screw **(B)** on the canister

The maximum number of 'clicks' is 20.
The standard adjustment is 10 'clicks'

Turn the screw clockwise to the end to stiffen the compression, then turn backwards to soften the compression.

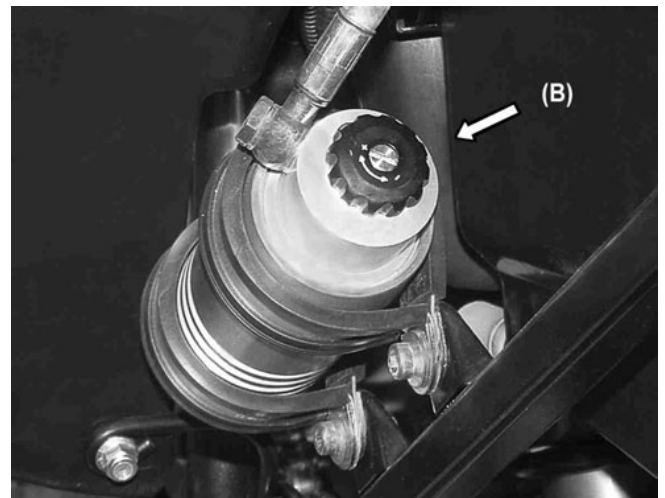

PERIODIC MAINTENANCE AND ADJUSTMENTS

MAINTENANCE CHART

The first revision must be performed by a specialised workshop at 500 km or after two fuel tanks. The following revisions must be made every 2000 km or three months.

		Checking	Fill	Change	Lubricate	Clean	Adjust	Tighten	If necessary.
BEFORE USING THE QUAD	Fuel tank level	●	●						●
	Front and rear brake fluid levels	●	●						●
	Brake lever and pedal play	●					●		●
	Brake pads	●		●					●
	Coolant Level	●	●						●
	Tyre wear	●		●					●
	Chain status	●			●				●
	Throttle grip	●			●				●
	Clutch lever play	●					●		●
	Lights	●		●					●
Switches	●							●	
AFTER USE	QUAD					●			●
	Shift pedal				●				●
	Brake lever and pedal				●				●
	Clutch lever				●				●
	Air filter				●				●
	Air filter housing				●	●			●
	Chain guide	●			●	●	●		●
	Cables				●				●
Radiator and tube connections	●							●	
Exhaust	●			●	●			●	
EVERY	Wheel bearings (10 outings)	●							●
	Bolts (see table for tightening torques)							●	
	Brake piston and dust guard (2 years)			●					
	Brake cylinder piston and dust guard (2 years)			●					
	Brake pipe (2 years)			●					

Regular inspections, adjustments and regular lubrication keep the machine in the best possible conditions of safety and efficiency. Safety is an obligation for the owner of the machine. The most important points related to inspections, adjustments and lubrication are described in the following pages.

WARNING

Do not perform any maintenance operation with the engine on. Moving elements might catch clothes or on a part of your body and cause injuries. The electric parts might produce sparks, provoke electric shocks or even fire. Before performing any maintenance operation, stop the engine, unless indicated otherwise. If you are not familiar with the maintenance of the vehicle it is better to go to a specialised workshop.

CLUTH LEVER ADJUSTMENT

Correct clutch lever play is 2-3 mm. Play increases with the clutch wear and thus requires adjustment. When there is too much play, first try to adjust the level of the clutch lever.

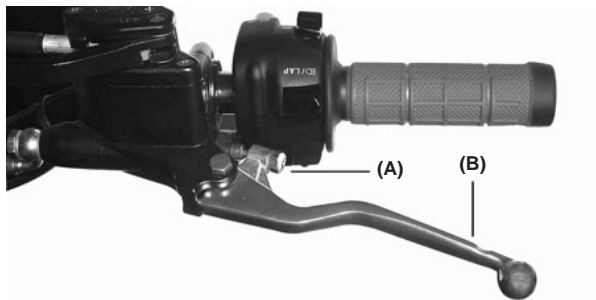

Tighten the adjustment bolt to obtain the optimal play. If the clutch lever adjustment is at its limit, play must be adjusted by using the clutch cylinder piston push rod.

ADJUSTING BRAKE LEVER AND BRAKE PEDAL

Disc and disc pad wear is automatically compensated for and has no effect on the brake lever or pedal action. Therefore, the only parts that require adjustment on the brakes are the brake lever play and the brake pedal position and play.

Brake lever

The lever free play will initially be directly related to the brake pad wear, that is, if some play is noticed before the adjustment, it would be a good idea to check the brake pads to see if they must be replaced.



The front brake handle (A) acts directly on the brake pump. There is no regulation of any kind.

It is possible that air might have entered the brake system. Purge the system in the following way:

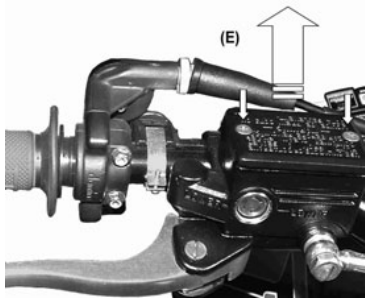

- Remove the brake fluid reservoir cap (E) to check the level.

- Remove the brake bleeder screw cap (F) (wheel interior) and attach a transparent tube to the end. Remove the front wheels before doing this.



- Operate the brake lever several times. Fluid starts coming out of the system through the tube. The transparent tube can be used to see if there is air, i.e. bubbles, in the system.
 - Once the system has been bled, refill the reservoir to the top.

Rear brake pedal

Check the brake operation and make sure it does not rub against any part of the QUAD. To adjust the pedal play, loosen the locknut, rotate the bolt, fit the lever in the required position and retighten the locknut.



When the brake pedal is in rest position, there should be a play of 10 mm. If not, then adjust this.

WARNING

If the brake pedal has a spongy feel when activated, it may be due to air in the pump or to a fault. It is dangerous to ride under these conditions, check the brakes immediately.

CHECKING THE BRAKE FLUID LEVEL

NOTE

Regularly check the brake fluid and periodically change it. It should also be changed if it is contaminated by water or dirt.

Fluid level inspection

Front: A small brake fluid reservoir is located to the left of the throttle grip. If we look at the reservoir carefully, a small transparent bubble is located on one of the flat sides that will allow us to check what is happening inside the brake fluid reservoir. If you have just purchased your quad, nothing can be seen through the bubble because the reservoir is full, the level will be seen when it is going down.

When the fluid level is too low, fill up:

- With a cross-tip screwdriver, unscrew the two screws on the recipient.
- Next, add liquid as required.
- Put the screws back in place and make sure the reservoir is tightly secured.

Rear



FLUID LEVEL FOR REAR BRAKES

The pump is located on the lower right side of the vehicle, attached to the rear brake pedal.

Check the brake fluid level through the spyhole **(A)**. the presence of bubbles means that the level has dropped, because of brake pad wear or leakage.

- To replace or top up brake fluid, remove the two screws of the upper cover and pull it upwards.
- Once the fluid is replaced, ensure that the cover is completely closed.

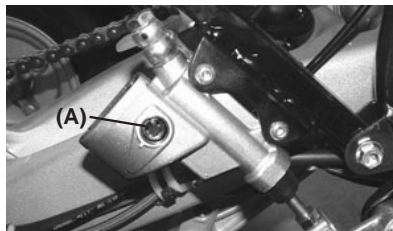

Recommended liquid

Use D.O.T 3 or D.O.T 4

CHECKING THE FRONT AND REAR BRAKE PADS

There are 3 brake callipers: One on the each of the front wheels (2); and 1 on the drive chain which brakes the rear wheels together. All operate in the same way and are checked in the same way.

As we can see in the picture, the brake calliper is formed by different parts. The pad is the part that rubs on the disk, thus, it is this element that wears down and must be checked.

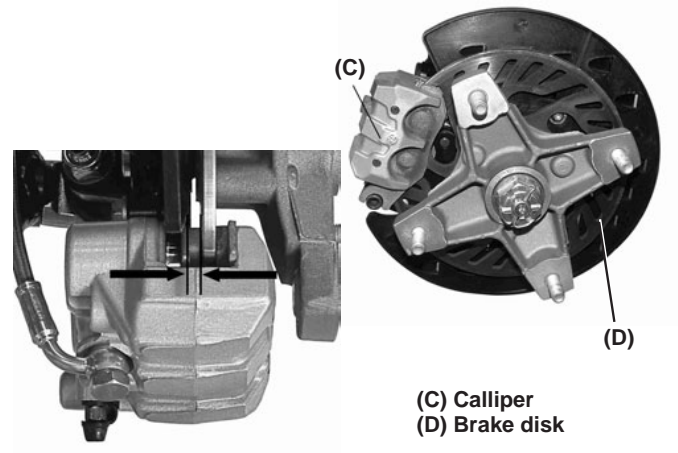

NOTE

Do not skip checking the brake pads, if the thickness is not checked they could cause damage to the brake calliper.

When the thickness of the pads are considerably reduced, visit a specialist and have the pads changed.

WHEEL CHANGES

We must change the wheels when they are worn out or after a puncture. The process is as follows:

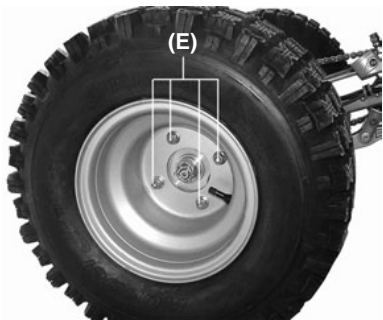

- Each wheel has four nuts (E) which we will remove with a no.15 wrench.
- Unscrew the nuts and remove the wheel from the axle.
- To put them back in place, follow the same procedure in reverse order.

SWING ARM SHAFT

It is very important that the rear wheel axle is well centred, otherwise, or if there is play, the bearing could be damaged.

- To adjust the axle nut, we will go to the rear end of the QUAD. - The nut is located at the right of the swing arm.
- Use the (F) spanner, which comes with your GAS GAS Quad to adjust the shaft.

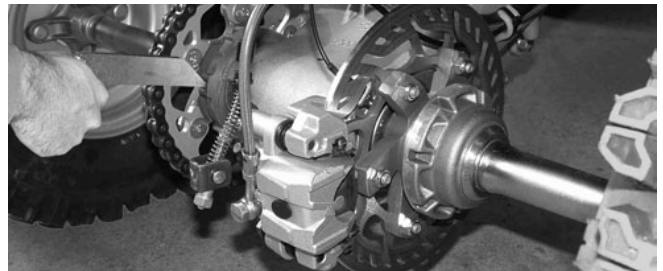

ADJUSTMENT AND LUBRICATION OF THE CHAIN GUIDE

The drive chain must be checked, adjusted, and lubricated in accordance with the Periodic Maintenance table in order to prevent excessive wear. If the chain is worn or badly adjusted (to tight or loose) then it may jump off the sprockets or break.

WARNING

A chain that breaks or jumps off the sprockets could snag on the engine sprocket or lock the rear wheel, severely damaging the motorcycle and causing it to go out of control.

Checking chain tension



The tightening of the chain and the swing arm at the chain guide must leave about a finger's width, if it is more or less, adjust to the correct measurement. Follow the procedure laid out below:

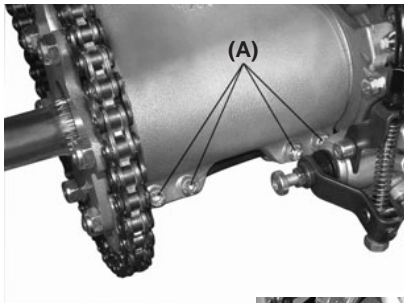

- Go to the rear of the QUAD. There are four bolts (A) on the swing arm.
- Unscrew the 4 screws.

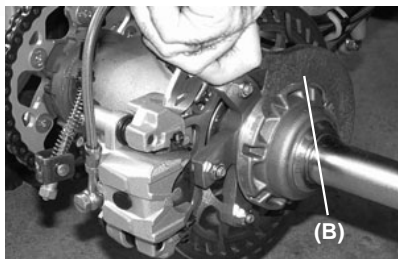

- With the spanner (B), that comes with your QUAD, adjust the chain correctly and then retighten the four bolts.

NOTE

Ensure that the bolts are tightened and that the chain tension is correct.

Inspection of the chain

Inspect the chain for damaged links, lost pins, unequal sprocket teeth or damaged teeth. If the drive chain is damaged, go to a specialised workshop and have it replaced.

Chain lubrication

Good chain maintenance is essential to ensure the correct operation.

Chain lubrication is one of the operations that must be performed frequently.

How often do you need to lubricate the chain?

- After riding on wet ground.
- When it has a dry appearance.
- After cleaning the motorbike.
- If the QUAD has not been used for a long time.

A high viscosity oil rather than low viscosity oil is better because it will stay on the chain longer providing lubrication.

Put oil on the sides of the chain pins so that it penetrates into these; remove excess oil.

CHECKING THE COOLANT LEVEL

The coolant absorbs excessive heat from the engine and transfers it to the air by the radiator. If the level of fluid has diminished constantly, the engine may overheat and become seriously damaged. Check the coolant level each day before riding the QUAD.

NOTE

The level should not go down in normal conditions. If liquid must be added often, revise the circuit for leaks and take the QUAD to a specialist.

WARNING

To avoid burns, do not remove the radiator cap or try to change the coolant when the engine is still hot. Wait for it to cool down.

Anti-freeze liquid information

To protect the cooling system aluminium parts (engine and radiator) from rust and corrosion, the use of corrosion and rust inhibitor chemicals in the coolant is essential. If coolant containing corrosion and rust inhibitor chemicals is not used, over a period of time, the radiator will rust. This will block the cooling hoses.

CAUTION
Use of incorrect coolant solutions will cause severe engine and cooling system damage. Use coolant containing corrosion inhibitors made specifically for aluminium engines and radiators in accordance with the instructions of the manufacturer.

WARNING
Coolant chemicals are harmful to the human body. Follow coolant manufacturer warnings and coolant handling instructions.

Soft or distilled water must be used with the inhibitor chemicals and the antifreeze in the cooling system.
If the lowest ambient temperature encountered falls below the freezing point of water, protect the cooling system against freezing.

Use a permanent type of anti-freeze (soft water and ethylene glycol plus corrosion and rust inhibitor chemicals for aluminium engines and radiators) in the cooling system.
For the coolant mixture ratio under extreme conditions, choose the mixture ratio listed on the container for the lowest ambient temperature.

Coolant Level

If a large quantity of liquid has been lost, check

the level of both containers. They are located together on the left side of the quad.

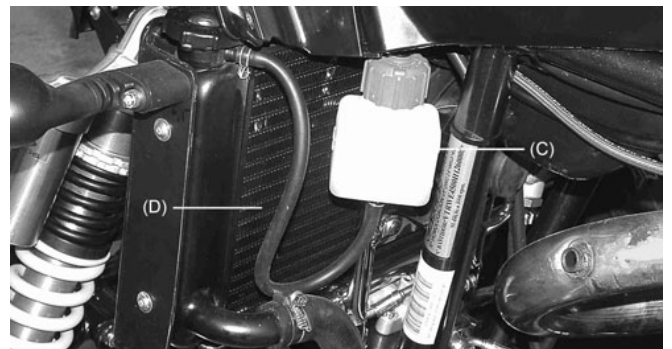

Normally, if the level in the reservoir (C) is below the mark then the radiator must be checked (D).

WARNING
Always perform these operations when the engine is cold, the liquids may be hot, and be ejected from the system under pressure, causing serious burns.

- Remove the cap and fill the radiator to the top.
- Remove the reservoir cap and fill it until the level is between the two marks.
- Start the engine and leave it idling for 15-20 seconds.
- Stop the engine and check the levels in the two containers, most likely it will have gone down because the engine has run out of liquid.
- Refill the containers if necessary.

Changing the coolant

- The coolant should be changed periodically to ensure long engine life.
- Wait for the engine to cool completely.
- Place the QUAD in a horizontal position.
- Remove the radiator cap.
- Place a container under the coolant drain plug, and drain the coolant from the radiator and engine by removing the drain plug **(B)** at the bottom of the water pump cover. Immediately wipe or wash off any coolant that spills on the frame, engine, or wheels.

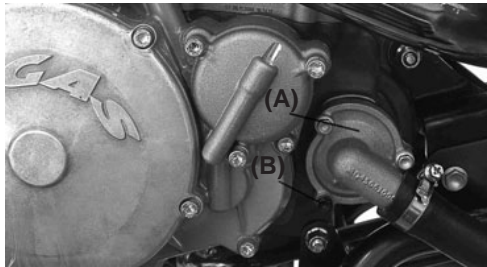

**(A). Water pump cap.
(B). Coolant drain plug**

WARNING

Coolant on tires will make them slippery and can cause an accident and injury.

- Inspection of the coolant. If white cotton-like patches appear in the liquid then this means that the aluminium elements of the cooling system are corroded. If the liquid is brown then this means that the steel or iron parts of the system are oxidized. In either case clean out the system.
- Check the cooling system for damage, loose joints, or leaks.
- Install the water pump cover drain plug and cylinder drain plug with

the specified torque shown in the table. Replace seals with new ones.

**Bolt torque (see tightening torque table)
Water pump plug: 9 Nm.**

- Fill the radiator up to the edge and install the radiator cap.
- Check the cooling system for leaks.
- Start the engine, warm up the engine, and then stop it.
- Check the coolant level after the engine cools down.

AIR FILTER

CAUTION

The air filter must ALWAYS be cleaned after using the QUAD. Otherwise, dirt may penetrate the engine and damage it seriously.

WARNING

An obstructed air filter will allow dirt to enter the carburettor and block the throttle open. This could lead to an accident.

An obstructed air filter restricts the air intake of the engine, increasing the petrol consumption and reducing the engine power as well as causing the destruction of the spark plug.

NOTE

There is an examination hose on the lower part of the air filter box. If dust or water have accumulated in this hose, empty it and clean the air filter element and the air filter housing.

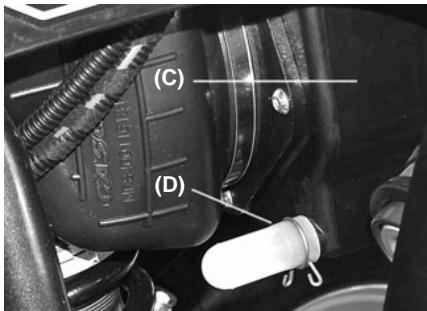

(C). Air filter housing.
(D). Inspection hose.

Cleaning process

WARNING

Clean the filter in a well-ventilated zone and ensure that there are no sources of naked flame or sparks near the work area (including the focus of a powerful light). Do not use petrol to clean the filter as this could result in an explosion.

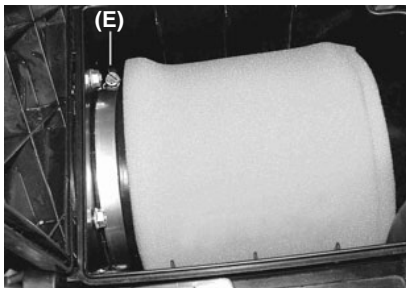

1. Raise the seat and unlock the metal safety locks. Then open the air filter cover.
2. Loosen the metal clamp (E) and remove the air filter from its housing.

3. Separate the foam and the cage that make up the air filter assembly.

NOTE

Do not twist the element when drying.



4. Submerge the filter in a container with degreasing liquid for cleaning filters. This liquid should clean the filter without damaging it.

5. Then drain it carefully and allow it to dry for a few minutes.



- Check the air filter for damage such as scraping, hardening, shrinkage...
If it is damaged then replace, otherwise dirt will enter the throttle body.

NOTE

The element must be damp but not dripping.

- When the element does not drip anymore, put it in a bath of lubricant and grease. We may avoid the use of a bath and soak the filter in the same liquid, the result is the same. Apply special air filter oil to the element foam. If there is no air filter oil available then use engine oil.
- Also clean the cage with a humid cloth as well as the filter housing.
- Make sure all the corners are clean before putting all the parts back in the filter housing.
- Grease all of the connections and bolts of the air filter and inlets.
- Place the filter into the cage and cover the filter lip with a thick layer of grease to ensure the correct seal and to prevent dirt from entering the carburettor.
- Re-install the air filter in the QUAD and make sure it is correctly secured.

CAUTION

Never allow the engine to run without the filter element installed. Otherwise non-filtered air would enter the engine and it may result in wear and possibly breakdown. On the other hand, using the engine without the filter element may cause blockage in the carburettor conduits decreasing the engine performance.

SPARK PLUG

The standard spark plug is shown in the table and is tightened to 11 Nm.



The plug must be periodically removed to check the gap and the ceramic insulation.

Standard spark plug

0.7-0.8 mm

The spark plug should be taken out periodically to check the electrode gap. If the plug is oily or has carbon build up on it the clean it with a sand blaster. Following abrasive particle cleaning, the spark plug should be cleaned with a wire brush or similar. Measure the distance between electrodes using a gauge and adjust in case that it is not correct by bending the outer electrode. If the spark plug electrodes are oxidised, damaged or the insulation is broken then replace the plug.

NOTE

Inspect every 30 hours. Replace every 60 hours.

To find the correct heat grade spark plug is being used, take it out and examine the insulation around the electrode. If the ceramic is light brown, the spark plug is correctly matched to engine temperature. If the ceramic is white, the plug should be replaced with the next coldest plug. If the ceramic is black, the plug should be replaced with the next hottest plug.

NOTE

If the engine output decreases, replace the spark plug to regain performance.

Spark plug maintenance

COMMENTS
If the standard spark plug is wet then replace it.
Standard
If the standard spark plug appears crystallized, or white, replace it.

CAUTION

Incorrect fitting of the spark plug or using an incorrect heat grade could cause serious engine damage that is not covered by the guarantee.

Always use spark plugs recommended by GAS GAS. Consult the dealers or a qualified mechanic to know which spark plug is better for your bike.

Removing the spark plug

To remove the spark plug, follow the following steps:

1. Remove the seat.
2. Remove the side panels from the fuel tank.
3. Remove the connector of the fuel pump (A).
4. Remove the three bolts (arrows) and remove the tank to one side without disconnecting the fuel pipe.
5. Remove the cap from the spark plug.

WARNING

When the injection pump pipes are removed, petrol may be spilled and cause a fire. Stop the engine before removing the tank. Keep naked flames and sparks away from the tank cap. Do not smoke.

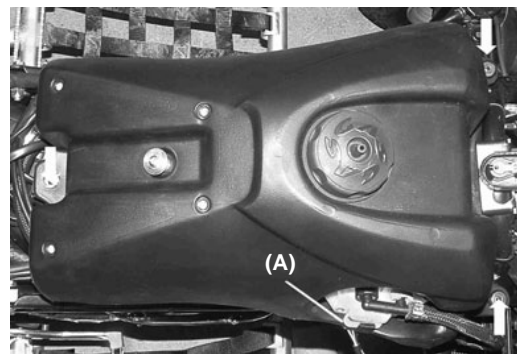

NOTE

The spark plug is protected by a cap. Keep this clean and dry.

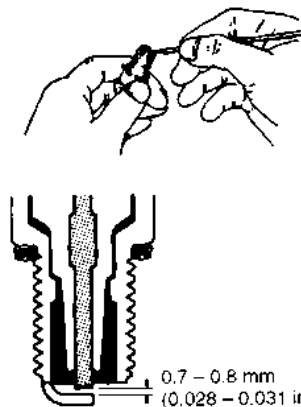

7. Take out the spark plug and clean carbon deposits from the spark plug with a small tip or a metallic brush. Readjust the gap in the plug between 0.7 and 0.8 mm. (0.028 – 0.031 in). Before removing the carbon deposits, check its colour; this colour tells us whether the standard plug is the best for our use.

INSPECTION AND LUBRICATION OF THE CABLES

WARNING

Inspect the cables regularly and replace them if damaged. When the outside protection is damaged, corrosion may occur. The cables may also be worn out or damaged. Control operation could be restricted, which may result in accidents and injuries.

Lubricate the cable interior and the cable ends. If the cables do not slide smoothly, have a specialised workshop replace them.

Recommended lubricant: Engine oil

REPLACING THE LIGHTS

Front headlight

WARNING

The bulb is hot when lit and immediately after turning off the lights. Wait for it to cool down before touching or removing it. It can burn or could cause a fire if it comes in contact with flammable material.

1. Remove the bolts (A) on both sides of the vehicle.

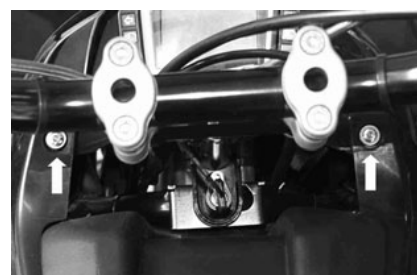

2. Remove the bolts (arrows) fastening the side panels to the front and the instrument panel.

3. Pull the front panel gently forwards until you can reach the light fittings (C) and remove the connectors of the bulb in question.

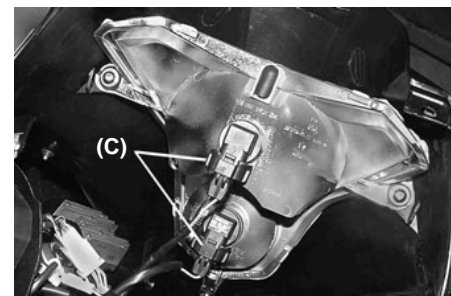



4. Turn the light fitting in the direction of the arrow and pull outwards.
5. Replace the bulb. To insert it, follow the above operations in reverse order.

FRONT SIDE LIGHT

1. The front side light uses two LED diodes instead of a bulb. The LED diodes cannot be replaced separately.
2. If the light is damaged it must be completely replaced.



3. To do this, remove the bolts (arrows).

REAR LIGHTS

1. The rear side light uses two LED diodes instead of a bulb. The LED diodes cannot be replaced separately.
2. If the light is damaged it must be completely replaced.
3. To do this, detach the connector and remove the bolts **(G)**.

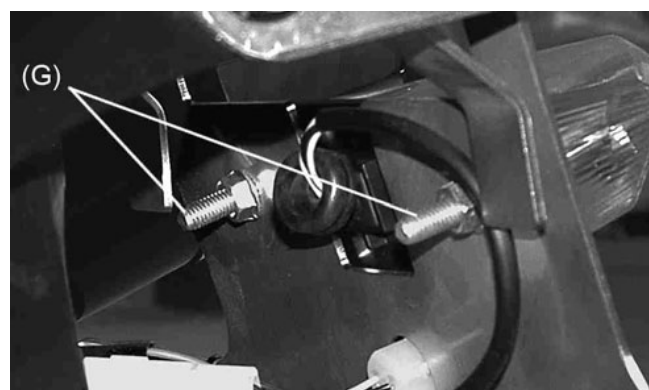

WARNING
Rear light and front side light with LED (will not fuse).

Indicators

- To remove the bulb, press it against the spring, turn it ¼5f anti-clockwise, extract and replace it with a new one.
- Put the lens back in place and make sure the assembly is well secured.



- Using a cross-tipped screwdriver, unscrew the screws (A), located on the rear, then extract the small lens.



ENGINE OIL, CHECKING THE OIL LEVEL

The oil must comply with the SAE 10W-50 standard, classification API SF or SG.

NOTE

If you are using the motorcycle in climates with extreme temperatures then choose the most suitable engine oil using the attached table as a guide.

TRANSMISSION

So that the transmission and clutch operate properly, maintain the oil level at the proper level and change it periodically. A QUAD with an insufficient, deteriorated or contaminated oil level will suffer premature wear and transmission damage.

ADJUSTING THE FRONT HEADLIGHT

To regulate the height of the front headlight, the vehicle should be on a totally flat horizontal surface. Then project the beam onto a vertical surface and adjust using the adjustment bolt.

Turning clockwise, the light beam will rise.
Turning anti-clockwise, the light beam will dip.

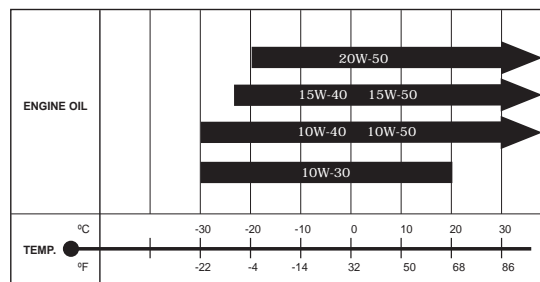

Oil level**NOTE**

- *To maintain the engine in perfect conditions, check the oil level and change it regularly.*
- *The engine oil increases in volume when it is hot. Check and adjust the level when the oil is cold.*

To check the oil level use the spyhole on the left side of the engine (arrow).

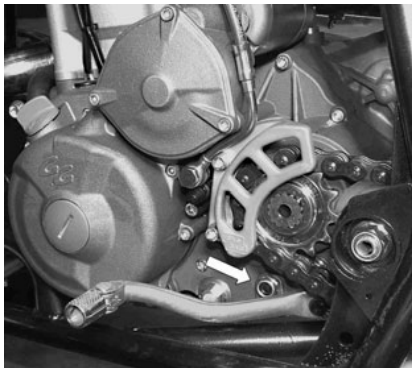
**Changing the oil and filter**

The oil should be changed when the engine is hot, since this helps the oil to go out through the drain located in the lowest part of the engine.

WARNING

The engine oil and the exhaust manifold can be very hot and cause burns.
Wait until the oil and the exhaust manifold are a little cooler.

WARNING

Engine oil is a health risk. Avoid any contact with this given that this could provoke irritation and, in the worst cases, skin cancer.

- Keep new or used oil away from the reach of children and animals.
- Clean clothes sleeves and pants.
- Wash yourself with soap if oil has been in contact with your skin.

To change the oil, follow the following steps:

2. **Remove the sump plug (C) (The bolt is located underneath the QUAD).**

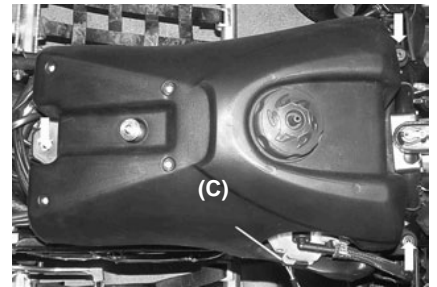
**CAUTION**

On removing the sump plug to drain the oil, you will find a copper washer. Replace this washer with a new one every time you change the oil.

Use a funnel when draining the engine oil

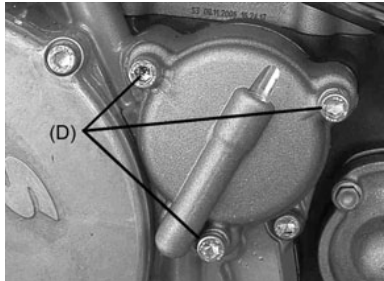

3. Remove the three screws of the filter cover. (D).

4. Remove the filter cover, pull the filter element to remove it (D) and replace it with a new one.

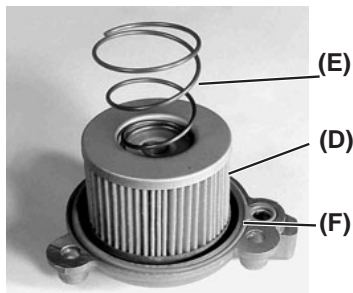

5. Before replacing the oil filter, make sure that the spring (E) and the o-ring (F) are in the correct position.

NOTE

Put used motor oil in an appropriate container for recycling.

WARNING

Using a filter with an incorrect design may cause engine malfunction. Use the genuine oil filter designed by GAS GAS or an equivalent for your QUAD.

WARNING

An error in the fitting of a new element may cause engine malfunction. The engine oil will not flow if a new element is not correctly fitted.

NOTE

Fit a new O-ring when the filter is being replaced.

9. Replace the filter cover and put the screws that secure the cover, but without tightening them too hard (do not exceed the recommended torque).

10. Replace the drain caps and screw them back on accordingly. Pour new oil through the dipstick hole. Approximately 1,800 ml or the required amount.

WARNING

The engine may be damaged if the oil is not used properly or the specifications recommended by GAS GAS MOTOS are not followed. Use the type of oil specified in the section on Petrol and Oil recommendations.

11. Start the engine and allow it to run some minutes. Check for oil leaking from the filter cover.

12. Check that the oil level is correct according to the oil level verification process.

IDLING REGULATION

The exhaust gasses are highly toxic. The task of regulating the idling must be carried out in open spaces or in suitably ventilated premises.



The throttle body has an idling regulation screw (arrow) that acts on the air channel in the by-pass.

The regulation of the mixture is controlled by the electronic control unit

NOTE

- **Turning the screw (arrow) clockwise will reduce the engine speed.**
- **Turning the screw (arrow) anti-clockwise will increase the engine speed.**

Turn the screw (arrow) until the engine reaches the required idling speed.

CLEANING, LUBRICATION AND STORAGE

CLEANING

Frequently cleaning your vehicle will not serve only to improve its aspect, but also to improve its overall performance and to preserve the duration of components.

Before washing the quad some precautions need to be taken to prevent water from entering some parts:

Exhaust	- Cover with a plastic bag secured with rubber bands.
Clutch and brake levers, handgrips, engine stop button.	- Cover with a plastic bag.
Air filter intake.	- Close up the opening with tape or stuff a cloth in it.
Spark plug cap and all filler caps.	- Ensure they are correctly secured.

- If the outside of the engine has too much grease on it, apply a degreaser with a brush. Do not apply this product to the chain, sprockets or wheel axles.

- Eliminate all dirt and the degreaser by washing them off with a garden hose. Reduce the water pressure to the minimum required for the job.

CAUTION
Excessive water pressure may penetrate the wheel bearings, brakes, transmission bushings and electric components, with resulting in damage.

Where to be most careful. Avoid applying high-pressure water to:

Brake calliper and brake pump piston below the fuel tank (if water enters the electric coil or in the spark plug hood, the quad will not start and the wet parts must be dried out), Front and rear hubs; suspension system; swing arm bearings.

- Wash all surfaces with hot water and neutral soap.
- Rinse the machine with clean water and dry all the surfaces with a soft and absorbing cloth.
- Clean the seat with a vinyl-lining cleaner so as to keep it soft and shiny.
- Apply automotive wax to all chromed and painted surfaces. Avoid using wax combined with cleaning products. Most of these products contain abrasive elements that might make the paint matt or destroy the finish. When finished, start the engine and leave it idling for some minutes.

WARNING

Wet brakes may lose efficiency, and represent an accident risk. Check the brakes after washing the quad and apply them several times at low speed, so that friction dries them out.

After washing the QUAD

- Remove the plastic bags and clean the air filter intake.
- Lubricate the locations listed in the lubrication section.
- Start the engine and let it heat for 5 minutes.

LUBRICATION

Lubricate the points shown here, with either motor oil or regular grease, periodically or whenever the vehicle has been exposed to wet conditions, and especially after using a high-pressure spray washer. Before lubricating each part, clean off any rusty spots with rust remover and wipe off any grease, oil, dirt, or grime.

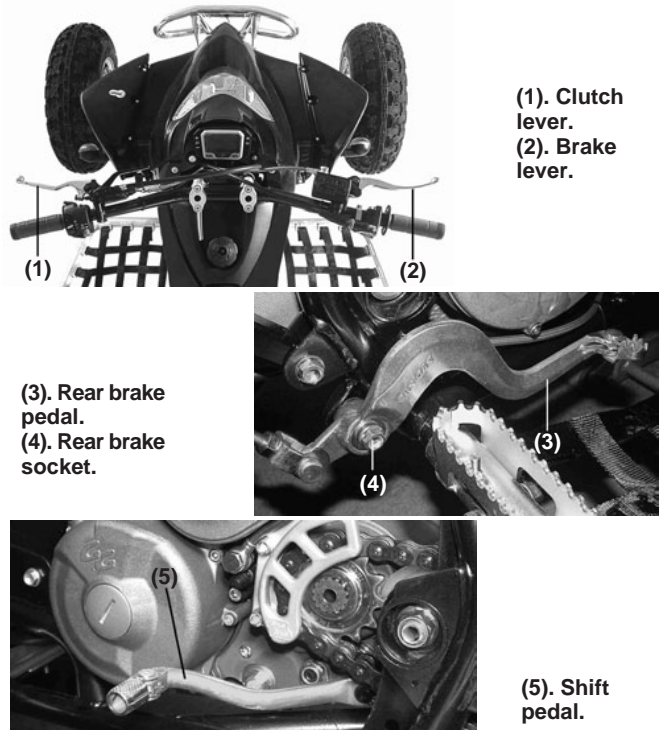

Use a spray with a tube to lubricate under pressure:

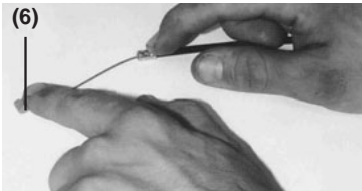
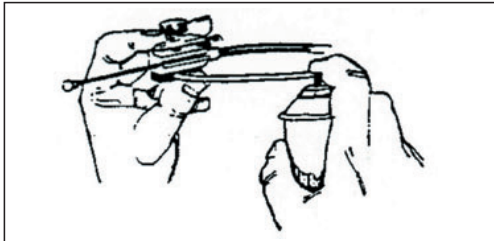

(6). Throttle cable.



(7). Chain.

Lubricate the chain after wet terrain or when the chain looks dry. A high viscosity oil rather than low viscosity oil is better because it will stay on the chain longer providing lubrication.

Put oil on the sides of the chain pins so that it penetrates into these; remove excess oil.

STORAGE

If you need to keep the QUAD for a long period of time (we consider that long is 60+ days) you must:

- Clean the entire vehicle thoroughly.
- Run the engine for about five minutes to warm the oil, shut it off and drain the transmission oil (See the section on transmission).
- Put in fresh transmission oil.
- Empty the fuel from the fuel tank, and empty the carburettor float bowl. (If left in for a long time, the fuel will deteriorate).
- Lubricate the drive chain and all the cables.
- Spray oil on all unpainted metal surfaces to prevent rusting. Avoid getting oil on rubber parts or in the brakes.
- Tie a plastic bag over the exhaust pipe to prevent moisture from entering.
- Set the QUAD on a box or stand so that both wheels are raised off the ground. (If this cannot be done, put boards under the front and rear wheels to keep dampness away from the tire rubber).
- Put a cover over the QUAD to keep dust and dirt from collecting on it.

To put the QUAD back into use after storage:

- Remove plastic bag from exhaust.
- Make sure the spark plug is tight.
- Fill the fuel tank with fuel.
- Check all the points listed in the "Daily Pre-ride Inspection Section".
- General lubrication

GAS GAS MULTIFUNCTION INSTRUCTIONS

The multifunction apparatus, which is waterproof, has 4-8 LED indicators on both sides of a central indicator screen. This central indicator screen, made of liquid crystal and with illumination, gives information about the rpm, speed, journey, kilometres travelled, time, average speed, maximum speed, length of time with motor running and total time. The data relative to the distance travelled and total time of use is stored in the memory, even when the apparatus is switched off. When the multifunction apparatus is not activated, it displays a clock. The wheel circumference value is adaptable, as is the measuring system (metric or imperial). The number and distribution of the LED indicators, and the amount of information on screen may vary according to model.

Panel



Panel description

1. RESET button
2. 2nd row of indicators
3. 1st row of indicators
4. Tachometer with bar graph
5. Tachometer scale
6. Fuel indicator bars (optional)
7. MODE button

Description of symbols

	Left indicator / Green
	Dipped headlights / Green
	Motor oil / Red
	Right indicator / Green
	Full headlights / Blue
	Neutral / Green (Optional)

Technical characteristics

FUNCTIONS	Symbol	TECHNICAL CHARACTERISTICS	INCREMENTS	PRECISION
Bar tachometer		500 -11,000 rpm	500 rpm	
Digital Tachometer	RPM	100 -19,900 rpm	100 rpm	
Gear change indicator	RPM	100 -19,900 rpm	100 rpm	
Maximum tachometer value		100 -19,900 rpm	100 rpm	
Speedometer		2.3 - 300 kmph (187.5 mph)	0.1 kmph or mph	$\pm 1\%$ o $\pm 0,1$ km/h / m/h
Maximum speed gauge	MAX	2.3 - 300 kmph (187.5 mph)	0.1 kmph or mph	$\pm 1\%$ o $\pm 0,1$ km/h / m/h
Average speed gauge	AVG	2.3 - 300 kmph (187.5 mph)	0.1 kmph or mph	$\pm 1\%$ o $\pm 0,1$ km/h / m/h
Trip counter 1 and 2	TRIP 1&2	0 – 999.9 km or 0 – 624.9 miles	0,01 km or miles	$\pm 0,1 \%$
Mileometer	ODO	0 -999,999 km or 0 – 624.999 miles	0.1 km or miles	$\pm 0,1\%$
Operation time	RT	0:00'00" - 99:59' 59"	1 second	± 50 PPM
Total time	TT	0:00' - 9999:59'	1 minute	± 50 PPM
Clock		0:00'00" - 23:59' 59"	1 second/1 minute	± 50 PPM

Initial voltage: 12v CC.

Speed sensor: Non-contact magnetic sensor.

Tachometer input: CDI (capacitor discharge ignition) or ignition coil signal.

Wheel circumference adjustment: 1 mm – 3.999 mm (1 mm increments).

Working temperature: -10 °C - + 80 °C (engine casing interior).

Fuel sensor resistance: 100Ω (only in models with fuel level indicator).

Functions

RPM: Bar

Tachometer with bar graph. The bar graph of the tachometer displays up to 11,000 rpm.

RPM: Digital Tachometer

The rpm is shown in the second row. The digital tachometer displays up to 19,900 rpm. The tachometer signal can be read from the CDI (Capacitor Discharge Ignition) or the ignition coil.

Gear change indicator according to rpm

This function permits setting an indicator for changing gear at a specific rpm level. The tachometer bar flashes when the rpm reaches the specific level and stops flashing when the gear is changed.

MAX RPM: Maximum tachometer value

It appears in the 2nd row. It shows the highest level reached by the tachometer since the last resetting of the data.

SPD: Speedometer

The speedometer information appears in the first line of the screen. It shows up to 300 km/h or 187.5 mph.

MAX: Maximum speed gauge

The MAX value appears in the 1st line. It shows the highest speed reached since the last resetting of the data.

AVG: Average driving speed

The AVG value appears in the 1st line. It calculates the average speed since the last RESET operation.

TRIP: Journey counter

This appears in the second line of the screen. The TRIP function contains the vehicle's accumulated mileage since the last RESET operation.

ODO: Mileometer

It shows the total mileage accumulated by the vehicle. The data is stored in the memory, even when the device is not running.

RT: Time of use controller

It calculates the total time in use since the last RESET operation. It starts counting from the moment that movement begins.

TT: Total time of use controller

It calculates the vehicle's total time in use. It starts counting from the moment that movement begins. The data is stored in the memory, even when the device is not running.

12/24 hour clock

It shows the time in either 12 or 24 hour formats.



Fuel level indicator (only vehicles with this function)

It has 7 bars showing the amount of fuel remaining in the fuel tank. The last bar flashes to indicate that the fuel level is too low.

Operation of the buttons

MODE BUTTON

1. Press the MODE button to switch from one function screen to another when the speed sensor detects no signal.

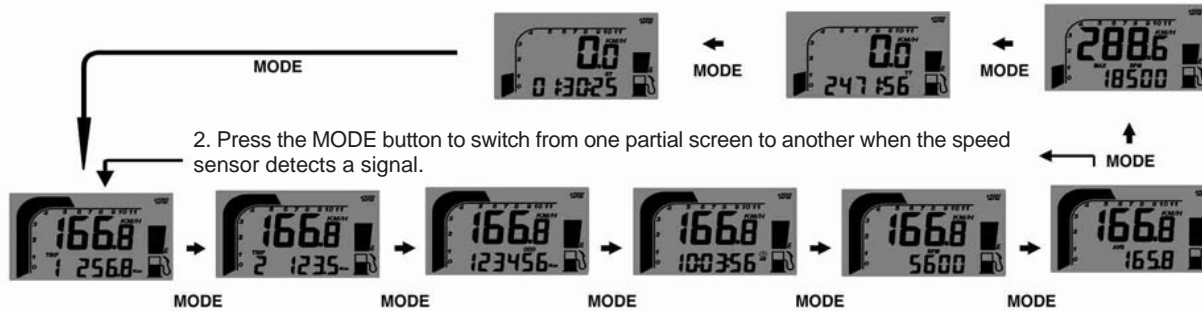

2. Press the MODE button to switch from one partial screen to another when the speed sensor detects a signal.

RESET BUTTON

1. Press the MODE button until you reach the screen, then press the RESET button for two seconds to return to zero the data stored in TRIP 2, MAX and MAX RPM separately.
2. Return the data in TRIP 1, AVG and RT at the same time. The data of the ODO, CLOCK and TT. cannot be returned to zero.

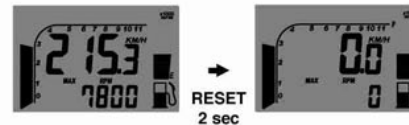

OPERATION OF THE GEAR CHANGE ACCORDING TO RPM

1. Press the MODE button to switch to the RPM screen; accelerate to the rpm which is desired for activating the gear change alert.
2. Press the RESET button to confirm and establish the gear change indicator according to the rpm.
3. The tachometer with bar graph and a LED will flash to indicate the need to change gear.
4. Use the steps 1 and 2 to readjust the gear change according to RPM

Multifunction and wheel circumference adjustment

The configuration operations include the 12/24 hour clock, the gear change according to rpm indicator, the number of engine revolutions by signal, the wheel circumference and the units of measurement. The configuration must be carried out step by step. The computer will return automatically to the main screen if no button is pressed in any adjustment screen for 75 seconds.

1. Press the MODE and RESET buttons to switch to the adjustment screen. In the adjustment screen, press the RESET button to increase the value of the flashing digits or to convert units, press the MODE button to confirm the configuration and move on to the next digit or the next adjustment screen to be configured. Press the MODE button for 2 seconds in any of the adjustment screens to end configuration and return to the main screen.
2. The screen shows 12 or 24 h, and the symbols XX XX-XX, and AM/PM if the 12h option has been selected.
3. When the RESET button is pressed the 12/24h system changes, and when MODE is pressed, the configuration concludes and the configuration of the clock digits opens.
4. Press the RESET button to increase the value of the flashing digit one by one; press the MODE button to confirm the configuration and pass on to the following digit.
5. Press the MODE button to switch to the adjustment screen of the gear change according to rpm, once the clock has been configured.
6. The screen will show RPM rXXX00. Press the RESET button to increase the value of the digit one by one; press the MODE button to confirm the configuration and pass on to the following digit.
7. Press the MODE button to switch to the adjustment screen for the engine revolution by signal, once the gear change according to rpm configuration is completed.
8. The screen will show SPC-X.X RPM, with 1.0 as the default value. There are 4 options 1.0, 2.0, 3.0 and 0.5. They correspond to the number of revolutions for each signal. For example, a value of 2.0 means that the motor turns over twice to produce a signal.
9. Press the RESET button to move between the four values. Press the MODE button to confirm the configuration and to move on to the wheel circumference adjustment screen.

10. When cXXXX appears on screen, the c stands for circumference and is followed by four digits by default; the flashing digit is the one to be changed.
11. Press the RESET button to increase the value of the flashing digit one by one; press the MODE button for 2 seconds to confirm the digit change and pass on to the following digit.

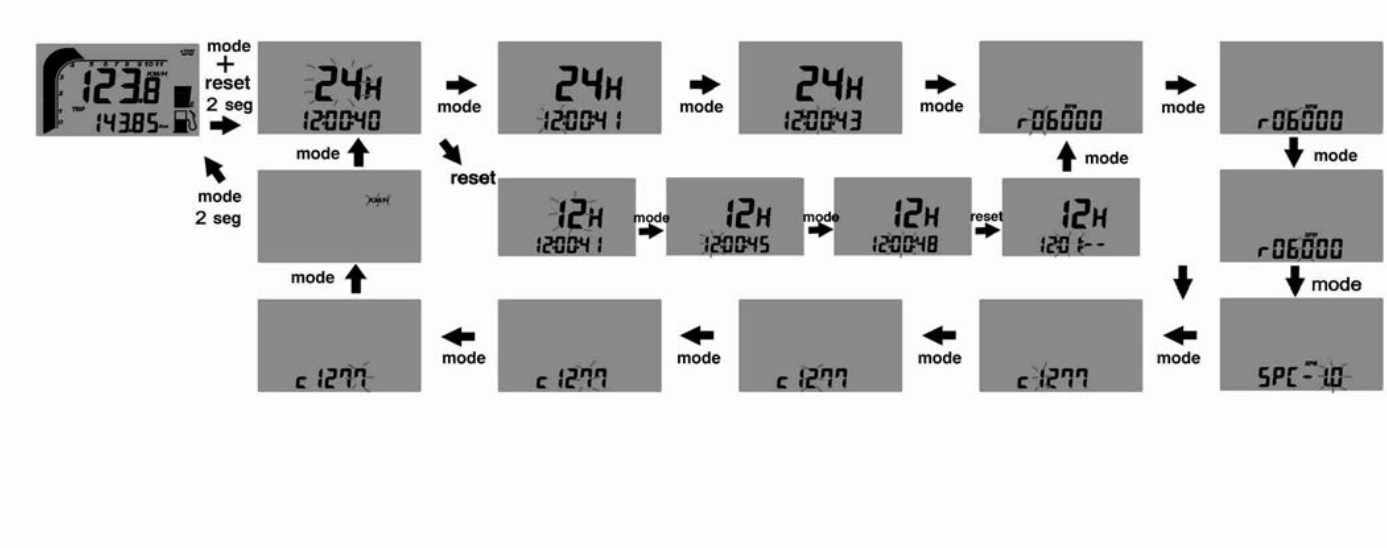

TIGHTENING TORQUE TABLE

Tighten all of the bolts and nuts using the correct spanners. If not correctly tightened then this could result in machine damage or even an accident.

	Part name	Nm	Kgm	Assembly number
E N G I N E	Crankshaft bolts	25	2.5	3
	Cylinder nut	34	3.5	3
	Engine drain plug	20	2.0	3
	Kick pedal bolt	20	2.0	8
	Kick pedal nut	25	2.5	8
	Shift pedal bolt	10	1.0	6
	Spark plug	11	1.0	3
	Water pump cover drain plug	9	0.9	3
	Engine bracket bolt	35	3.6	3
	Cylinder head brace	35	3.6	3
C H A S S I S	Calliper mounting bolts	25	2.6	1
	Disc plate mounting screws	10	2.5	1
	Rear brake pedal bolt	36	1.0	10
	Subframe support bolt	26	2.7	9
	Rear shock absorber bolt	39	4.0	7
	Rear disc wheel drive bolt	29	3.0	4
	Rocker arm bolt	81	8.3	7
	Piston bolt	81	8.3	7
	Steering stem	80	8.0	2
	Front trapezium	25	2.6	2
	Front socket	120	12.0	2
	Wheel bolts	15	1.6	1
	Rear axle	160	16.0	7
Rear sockets	165	16.6	7	

TIGHTENING TORQUE SCHEMA

The following is a diagram of the locations of the bolts numbered on the previous page. They are grouped by assembly.

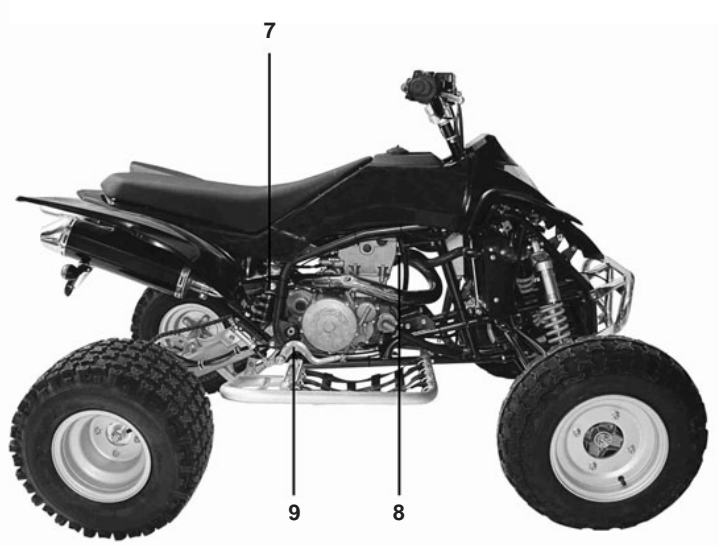
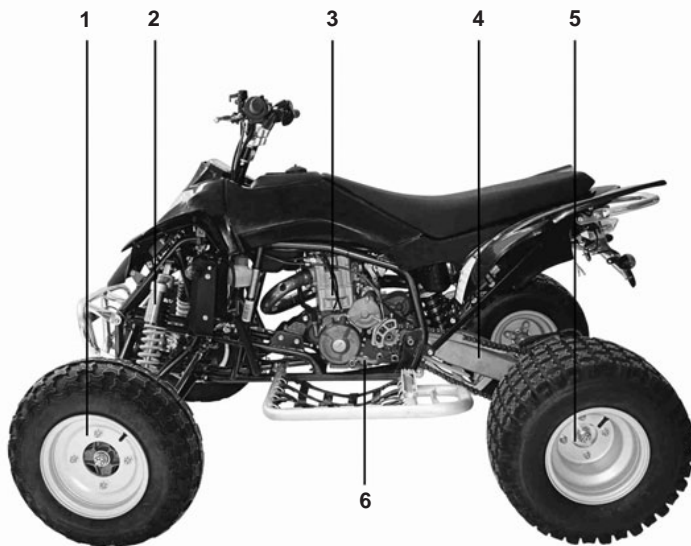

1. Ass. Front wheel
2. Ass. Front suspension
3. Ass. Engine
4. Ass. Transmission
5. Ass. Rear wheel

6. Ass. Shift pedal
7. Ass. Rear suspension
8. Ass. Chassis
9. Ass. Rear brake pedal

TROUBLE SHOOTING

NOTE

This is not an exhaustive list, it is meant simply as a rough guide to assist troubleshooting for some of the more common difficulties.

	FAULT	CAUSE	SOLUTION
1	The starter motor does not work	<ul style="list-style-type: none"> - The fuse for the starter relay is blown. - Battery discharged. - Low temperature. 	<ul style="list-style-type: none"> - Remove the seat and change the fuse of the starter relay. - Recharge the battery and investigate the causes for discharging, visit a qualified workshop. - Start engine with start pedal.
2	The engine does not rotate	<ul style="list-style-type: none"> - Crankshaft locked. - Cylinder/ piston/ crankpin journal seizure. - Transmission assembly seizure. 	<ul style="list-style-type: none"> - Go to a specialist workshop. - Go to a specialist workshop. - Go to a specialist workshop.
3	Engine rotates but does not start	<ul style="list-style-type: none"> - Fuel supply incorrect. - The QUAD has been out of operation for a longer period of time. - Spark plug soiled or humid - Engine flooded. 	<ul style="list-style-type: none"> - Check fuel pump relay by removing the seat; check fuel pump filter, located in the fuel tank, isn't blocked. - It is advisable to drain the old fuel from the tank. When the fuel tank is filled with new flammable fuel the engine starts immediately. - Dry the spark plug out or replace it. - To « unflood » the engine, full throttle, then operate the kick-start 5 to 10 times or operate the electric starter 2 times in 5 seconds. Then start the engine as described below. If the engine fails to start, unscrew the spark plug and dry it.

	FAULT	CAUSE	SOLUTION
3	Engine rotates but does not start	<ul style="list-style-type: none"> - The ECU pin connector, generator or coil oxidised or in bad condition. - Petrol / gas mixture incorrect (Trim Epprom). 	<ul style="list-style-type: none"> - Remove the seat and the fuel tank, clean the ECU pin connector and treat it using a contact spray. - Clean the petrol tank ventilation. Adjust the throttle body by-pass. Adjust the air filter conduit.
4	The engine starts but does not stop	<ul style="list-style-type: none"> - Air supply incorrect. - Fuel insufficient. 	<ul style="list-style-type: none"> - Clean the petrol tank ventilation. Adjust the injector mounting. Check the injector connection. Check the air filter conduit. - Fill the fuel tank with fuel.
5	The engine overheats	<ul style="list-style-type: none"> - Insufficient coolant in the circuit. - The radiator is soiled or partially obstructed. 	<ul style="list-style-type: none"> - Add coolant, verify the cooling system seal. - Clean the radiator fins or change.
6	The engine does not run smoothly	<ul style="list-style-type: none"> - Injection system maladjustment. (Trim Epprom). - Valve adjustment incorrect. 	<ul style="list-style-type: none"> - Adjust the injection system. Go to a specialist workshop. - Adjust the valve play. Go to a specialist workshop.
7	The engine is under powerful or accelerates badly.	<ul style="list-style-type: none"> - Fuel supply faulty. - Air filter obstruction. - Exhaust deteriorated with leaks. - Valve set too small. - Decompression maladjusted. 	<ul style="list-style-type: none"> - Clean and check fuel system. - Clean or change the air filter. - Check if the exhaust system is damaged, change the glass fibre in the silencer if necessary. - Adjust the valve play. Go to a specialist workshop. - Verify the operation of the system.
8	High oil consumption	<ul style="list-style-type: none"> - Piston-cylinder ring diameter tolerance excessive. - Engine oil level is too high. 	<ul style="list-style-type: none"> - Adjust the tolerance by changing the piston rings. - Correct the level of engine oil. Drain oil as necessary from the engine.

	FAULT	CAUSE	SOLUTION
8	High oil consumption	<ul style="list-style-type: none"> - The quality or viscosity of the oil is insufficient. 	<ul style="list-style-type: none"> - Empty the engine oil and fill with oil of the recommended viscosity.
9	Abnormal engine noise	<ul style="list-style-type: none"> - Ignition problems. - Valve adjustment play. - Over heating. 	<ul style="list-style-type: none"> - Go to a specialist workshop. - Adjust the valve play. Go to a specialist workshop. - See chapter 5.
10	Detonations in the exhaust	<ul style="list-style-type: none"> - Carbon in combustion chamber. - Injection system maladjustment. (Trim Epprom). - Incorrect or poor gasoline or wrong octane rating. - Incorrect or non-specified spark plug. - Exhaust system joints deteriorated. 	<ul style="list-style-type: none"> - Clean the combustion chamber. - Go to a specialist workshop. - Drain the petrol and fill with fresh or higher octane petrol. - Change spark plug for a new one or recommended one. - Check if the exhaust system is deteriorated. The seals must be in perfect condition, if not then they must be changed for new ones.
11	White fumes from the exhaust	<ul style="list-style-type: none"> - Cylinder head gasket leak (water leaking into cylinder). 	<ul style="list-style-type: none"> - Change the cylinder head gasket. Go to a specialist workshop.
12	Brown fumes from the exhaust	<ul style="list-style-type: none"> - Air filter obstruction. 	<ul style="list-style-type: none"> - Clean or change the air filter. Go to a specialist workshop.
13	Gears don't engage	<ul style="list-style-type: none"> - Clutch does not release. - Shift fork worn or locked. - Gear locked in transmission. - Shift lever damaged. - Selector position spring loose or broken. - Down shift selector mechanism spring broken. 	<ul style="list-style-type: none"> - Go to a specialist workshop. - Change the gear fork. - Go to a specialist workshop. - Change the gear lever. - Go to a specialist workshop. - Go to a specialist workshop.

	FAULT	CAUSE	SOLUTION
13	Gears don't engage	<ul style="list-style-type: none"> - The spring of the retro-selector is broken. - Cylinder change if broken. - Gear ratchet spring broken. 	<ul style="list-style-type: none"> - Go to a specialist workshop. - Go to a specialist workshop. - Go to a specialist workshop.
14	Gears jump	<ul style="list-style-type: none"> - Gear change fork damaged in the gears. - Gear teeth worn. - Gear nipple damaged. - Groove gear drum worn. - Gear change fork pivot worn. - Selector drum position spring broken. - Broken gears. 	<ul style="list-style-type: none"> - Change gear fork. Go to a specialist workshop. - Change. Go to a specialist workshop. - Change. Go to a specialist workshop. - Change. Go to a specialist workshop. - Change shaft. Go to a specialist workshop. - Change the spring. Go to a specialist workshop. - Go to a specialist workshop.
15	Clutch slipping	<ul style="list-style-type: none"> - No play in the clutch handle. - Clutch plate worn. - Clutch housing worn. - Clutch spring broken or weak. - Clutch plates worn. 	<ul style="list-style-type: none"> - Go to a specialist workshop. - Replace the clutch plate. Go to a specialist workshop. - Replace the clutch hub. Go to a specialist workshop. - Go to a specialist workshop. - Change the clutch disks. Go to a specialist workshop.
16	The QUAD is unstable.	<ul style="list-style-type: none"> - Steering stem nut loose. - Steering bearings damaged or worn. - Steering stem bent. 	<ul style="list-style-type: none"> - Adjust the steering stem, ensure that there is a pin underneath the bolt preventing it from loosening in any case. - Replace the steering bearing. - Change the steering stem. Go to a specialist workshop.

	FAULT	CAUSE	SOLUTION
17	Shock absorption too hard	<ul style="list-style-type: none"> - Compression maladjusted. - Excessive tyre pressure. 	<ul style="list-style-type: none"> - Rotate the control on the upper part of the front and rear shock absorbers to the left. Remember to evenly adjust both front shock absorbers. For more details, see "<i>suspension tuning</i>". - Verify tyre pressure.
18	Shock absorption too soft	<ul style="list-style-type: none"> - Rebound maladjusted. - Low tyre pressure. 	<ul style="list-style-type: none"> - We must hold the hydraulics when rotating the control on the lower part of the shock absorbers to the right. Ensure that the compression of the front shock absorbers are adjusted equally. See "<i>Suspension tuning</i>". - Verify tyre pressure.
19	The QUAD makes unusual noises	<ul style="list-style-type: none"> - Drive chain incorrectly adjusted. - Chain worn. - Rear sprocket worn. - Chain lubrication insufficient. - Rear wheels misaligned. - Brake disk worn. - Brake pads incorrect position or crystallised. 	<ul style="list-style-type: none"> - Adjust the chain. - Change the chain, rear sprocket and secondary transmission pinion. - Change the rear sprocket. - Lubricate using a correct chain lubricant. - Align the rear wheels. - Replace the brake disk. - Refit the pads or change them.
20	The QUAD makes unusual noises	<ul style="list-style-type: none"> - Cylinder damage. - Brackets, nuts, bolts not properly tightened. 	<ul style="list-style-type: none"> - Replace the damaged cylinder. - Verify and adjust to the correct tightening torques.
21	The handlebars vibrate	<ul style="list-style-type: none"> - Tyre deformation, swing arm or needle bearing worn. - Rim off-centre. - Different tyre pressures. - Wheel off-centre or deformed. - Wheels misaligned, due to fall. 	<ul style="list-style-type: none"> - Refill. - Release air from the wheels, fit the rims correctly, and inflate the tyres to the correct pressure. - Check tyre pressures and correct if necessary. - Inspect wheels and change if necessary. - Check front wheel convergence and divergence. Centre the swing arm shaft.

	FAULT	CAUSE	SOLUTION
21	The handlebars vibrate	<ul style="list-style-type: none"> - Handlebar bracket loose, steering shaft bolt loose. 	<ul style="list-style-type: none"> - Tighten the handlebar bracket and the steering shaft bolt to the correct tightening torques.
22	The QUAD pulls to one side	<ul style="list-style-type: none"> - Chassis twisted. - Steering incorrectly aligned. - Steering stem bent. - Rear wheel misaligned. - Possible violent shock to one of the steering joints. 	<ul style="list-style-type: none"> - Go to a specialist workshop. - Adjust the steering. Go to a specialist workshop. - Change steering stem. Go to a specialist workshop. - Check front wheel convergence and divergence. Centre the swing arm shaft. - Go to a specialist workshop.
23	The brakes do not function correctly	<ul style="list-style-type: none"> - Brake pads worn. - Loss of brake fluid. - Brake fluid deteriorated. - Piston cylinder broken. - Brakes incorrectly adjusted. 	<ul style="list-style-type: none"> - Check the condition of the pads and change them if necessary. - Check the brake circuits. Change those that are damaged or broken. - Drain the brake fluid and put a new product, recommended by the maker. (See "Maintenance and periodic adjustments" for information on bleeding the brake fluid circuit). - Replace the piston cylinder. - Adjust the brakes.
24	The lights blow	<ul style="list-style-type: none"> - Voltage regulator faulty. 	<ul style="list-style-type: none"> - Remove the seat and the fuel tank then check connections, verify the voltage regulator and the fuses in the fuse box.
25	The lighting system does not work	<ul style="list-style-type: none"> - The fuse for the lighting circuit has blown 	<ul style="list-style-type: none"> - Remove the seat and check installation.

Warranty Manual (According to law 23/2003 of the 10 of July, regarding Consumer Goods Sales Guarantees.)

Manufacturer's guarantee regulations for GAS GAS Motos S.A.

The Company GAS GAS Motos S.A. (hereafter referred to as GG) hereby guarantees the final purchaser of a vehicle manufactured by GG that both materials and workmanship are free from defects according to the maximum quality standards. Consequently, GG hereby warrants to the final purchaser (hereinafter referred to as the "purchaser"), subject to the conditions stated below, to remove any defects in material or production detected in a new motorcycle free of charge within the agreed period of warranty without any limitation whatsoever in terms of the number of kilometres travelled or the number of operating hours.

Period of warranty

The period of warranty shall commence on the day of delivery of the vehicle by a licensed GG dealer to the purchaser, or in the case of demonstration models, on the date on which the vehicle is put into operation for the first time.

The vendor will respond to any conformity faults that appear within the period established by the Law 23/2003 of the 10th of July regarding Consumer Goods Sales Guarantees from the delivery of goods and in accord with the directive 1999/44/CE for the remainder of the European Community Member States. For those countries outside of the European Community the guarantee will be regulated by the relevant current legislation. However, if the conformity fault appears during the first six months following delivery of the motorcycle, it will be assumed that this fault existed when the motorcycle was delivered; from the sixth month, the purchaser must show that the fault existed at the moment the goods were delivered.

During the six months following the delivery of the repaired goods, the vendor will respond to the faults requiring repairs.

Any defect detected in the product must be brought to the attention of the authorized GG dealer within the period of the guarantee. If the last day of the warranty period is a Sunday or public holiday, the warranty period shall be extended in such a way that the last day of the warranty period is the next working day following the respective Sunday or public holiday.

Warranty claims shall be excluded for any defects not brought to the attention of a licensed GG dealer by the end of the warranty period.



Purchaser obligations.

GG shall be entitled to refuse to accept warranty claims if and to the extent that:

- a) The purchaser has failed to subject the vehicle to any of the inspections and/or maintenance work prescribed in the operating manual or has exceeded the date stated for such inspections or maintenance work, also excluding from the warranty defects that appear before the prescribed date of such inspection or maintenance work not performed or performed after the prescribed date.
- b) the inspection, maintenance and repair of the vehicle is carried out by third parties unauthorized or not recognised by GG.
- c) Any maintenance or repair work has been performed on the vehicle in violation of the technical requirements, specifications and instructions indicated by the manufacturer.
- d) Spare parts not released for use by GG have been used to perform maintenance or repair work on the vehicle, or if and to the extent that the vehicle has been operated using other fuels, lubricants or operating fluids (including but not limited to cleaning agents) other than those expressly stated in the specifications in the operating manual;
- e) The vehicle has been altered or modified in any way or equipped with other components than those expressly released by GG as admissible vehicle components.
- f) The vehicle has been stored or transported in a way that does not meet the corresponding technical requirements.
- g) The vehicle has been **used for extraordinary use such as** for competitions, races or attempts at any record whatsoever.
- h) The vehicle has suffered a fall or accident provoking the damage indirectly or directly.

Exclusions from the warranty

The following items will be excluded from the warranty:

- a) normal wear and tear on parts including, without limitation, spark plugs, batteries, fuel filters, oil filter elements, drive chains (secondary), engine pinions, rear sprockets, air filters, brake discs, brake pads, clutch discs, lamps, fuses, carbon brushes, footrest rubbers, tires, tubes.
Any consequential harms caused by defects as well as incidental expenses directly or indirectly related to defects (e.g. communication charges, cost of board and lodging, cost of rental cars, public transport charges, cost of salvage and towing, packet service expenses, etc.) as well as other financial disadvantages (e.g. caused by loss of use of a motor vehicle, loss of earnings, loss of time, etc.).
- f) Any aesthetic or acoustic phenomena that does not significantly affect the serviceable condition of the motorcycle (e.g. hidden or minor blemishes, normal operating noise or vibrations).
- g) Phenomena due to the aging of the vehicle (e.g. fading of painted or metal-coated surfaces).

Miscellaneous

- 1)- GG shall be entitled to decide in its sole discretion whether to repair or to replace defective parts should the repair or replacement cost be disproportional. The ownership of parts replaced, if any, shall pass to GG, free of any consideration whatsoever. The licensed GG dealer entrusted with the removal of defects shall not be authorized to issue binding declarations on behalf of GG.
- 2.- In cases of doubt regarding the existence of a defect or if a visual inspection or material testing is required, GG shall be entitled to demand submission of the parts for which warranty claims are put forward or to order an examination of the defect by a GG expert. Any additional warranty obligations for parts replaced free of charge or for any service performed free of charge under the present warranty shall be excluded. The warranty of components replaced within the warranty period shall end at the date of expiry of the warranty period agreed for the original respective product.
- 3.- If any defect cannot be removed and substitution is judged disproportional by the manufacturer, the guaranteed purchaser shall be entitled to demand termination of the contract (payment of a compensation) or partial reimbursement for the purchasing price (discount) instead of repair of the motorcycle.
- 4.- The warranty claims of the purchaser under the contract of purchase and sale concluded with the respective licensed dealer shall not be affected by the present warranty. Neither shall the present warranty affect any additional contractual rights of the purchaser under the general business conditions of the licensed dealer. However, such additional rights are only valid with the licensed dealer.
- 5.-If the purchaser resells the product within the warranty period, the terms and conditions of the present warranty shall continue to exist in their present scope, the right to put forward claims under the present warranty according to the terms and conditions hereof will be passed on to the new owner of the motorcycle.
- 6.- When a used motorbike is sold by Gas Gas then the duration of the guarantee shall be one year from the delivery of the goods and the consumer cannot demand replacement of these goods.

