

GILERA WOULD LIKE TO THANK YOU

for choosing one of its products. We have prepared this manual to help you to get the very best from your scooter. Please read it carefully before riding the scooter for the first time. It contains information, tips and precautions for using your scooter. It also describes features, details and devices to assure you that you have made the right choice. We believe that if you follow our suggestions, you will soon get to know your new vehicle and it will serve you well for a long time to come. This booklet forms an integral part of the scooter; should the scooter be sold, it must be transferred to the new owner.

# Fuoco 500ie



The instructions given in this manual are intended to provide a clear, simple guide to using your scooter; this booklet also details routine maintenance procedures and regular checks that should be carried out on the vehicle at an **authorised Dealer or Service Centre**. The booklet also contains instructions for simple repairs. Any operations not specifically described in this manual require the use of special tools and/or particular technical knowledge: to carry out these operations refer to any **authorised Dealer of Service Centres**.



### **Personal safety**

Failure to completely observe these instructions will result in serious risk of personal injury.



### **Safeguarding the environment**

Sections marked with this symbol indicate the correct use of the vehicle to prevent damaging the environment.



### **Vehicle intactness**

The incomplete or non-observance of these regulations leads to the risk of serious damage to the vehicle and sometimes even the invalidity of the guarantee.

*The signs that you see on this page are very important. They are used to highlight those parts of the booklet that should be read with particular care. As you can see, each sign consists of a different graphic symbol, making it quick and easy to locate the various topics.*



# INDEX

**VEHICLE**..... 7

Dashboard..... 9

Analogue instrument panel..... 11

Clock..... 12

Digital lcd display..... 12

    Maintenance icons..... 13

    \*MODE\* button..... 13

Key switch..... 14

    Locking the steering wheel..... 14

    Releasing the steering wheel..... 15

Switch direction indicators..... 15

Horn button..... 16

Light switch..... 16

Emergency flashing light button..... 16

Start-up button..... 17

Engine stop button..... 17

Front suspension unlock-lock switch..... 17

The immobilizer system..... 18

    Keys..... 18

    Immobilizerdevice enabled indicator led..... 19

    Operation..... 19

    Programming the immobilizer system..... 20

Saddle opening remote control..... 21

    Remote control programming..... 22

Accessing the fuel tank..... 23

Power supply socket..... 24

The saddle..... 24

    Opening the saddle to access the helmet compartment by remote control..... 24

    Opening the saddle..... 25

Identification..... 26

Bag clip..... 26

**USE**..... 27

Checks..... 28

Refuelling..... 28

Tyre pressure..... 30

Shock absorbers adjustment..... 31

Running in..... 32

Starting up the engine..... 33

    Precautions..... 35

Difficult start up..... 35

Stopping the engine..... 36

anello antifurto..... 36

Stand..... 37

Automatic transmission..... 37

Safe driving..... 37

Front suspension locking system..... 40

**MAINTENANCE**..... 45

Engine oil level..... 46

    Engine oil level check..... 46

    Engine oil top-up..... 46

    Warning light (insufficient oil pressure)..... 46

    Engine oil change..... 47

Hub oil level..... 48

Tyres..... 50

Spark plug dismantlement..... 51

Removing the air filter..... 52

Air filter cleaning..... 52

Cooling fluid level..... 53

Checking the brake oil level..... 55

    Braking system fluid top up..... 55

Battery..... 57

    Use of a new battery..... 57

Long periods of inactivity..... 58

Fuses..... 58

Front light group..... 63

Headlight adjustment.....	64
Front direction indicators.....	67
Rear optical unit.....	68
Rear turn indicators.....	68
Number plate light.....	69
Helmet compartment lighting bulb.....	69
Rear-view mirrors.....	69
Front and rear disc brake.....	70
Puncture.....	71
Periods of inactivity.....	71
Cleaning the vehicle.....	72
<b>TECHNICAL DATA.....</b>	<b>77</b>
Kit equipment.....	82
<b>SPARE PARTS AND ACCESSORIES.....</b>	<b>83</b>
Warnings.....	84
<b>PROGRAMMED MAINTENANCE.....</b>	<b>87</b>
Scheduled maintenance table.....	88

# Fuoco 500ie



**GILERA®**



**Chap. 01  
Vehicle**

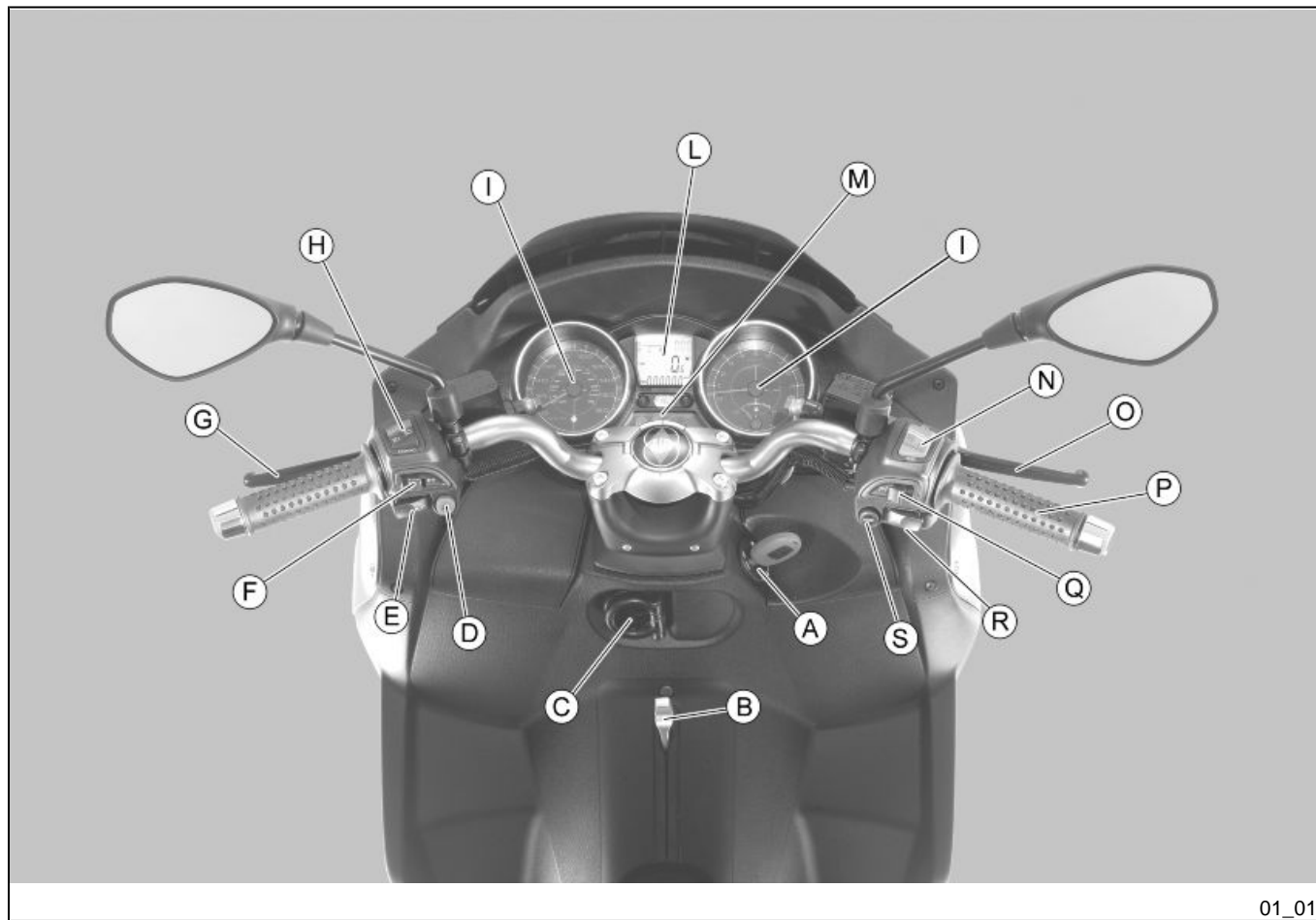



## Dashboard (01\_01)

**A** = Ignition key-switch

**B** = Hand brake

**C** = Bag hook

**D** = HAZARD button

**E** = Horn button

**F** = Turn indicator switch

**G** = Rear brake lever

**H** = Light switch + PASSING

**I** = Analogue instrument panel

**L** = Digital instrument panel

**M** = Warning light unit

**N** = RUN/OFF switch

**O** = Front brake lever

**P** = Throttle grip

**Q** = Front suspension locking-unlocking switch

**R** = Starter button

**S** = Mode button

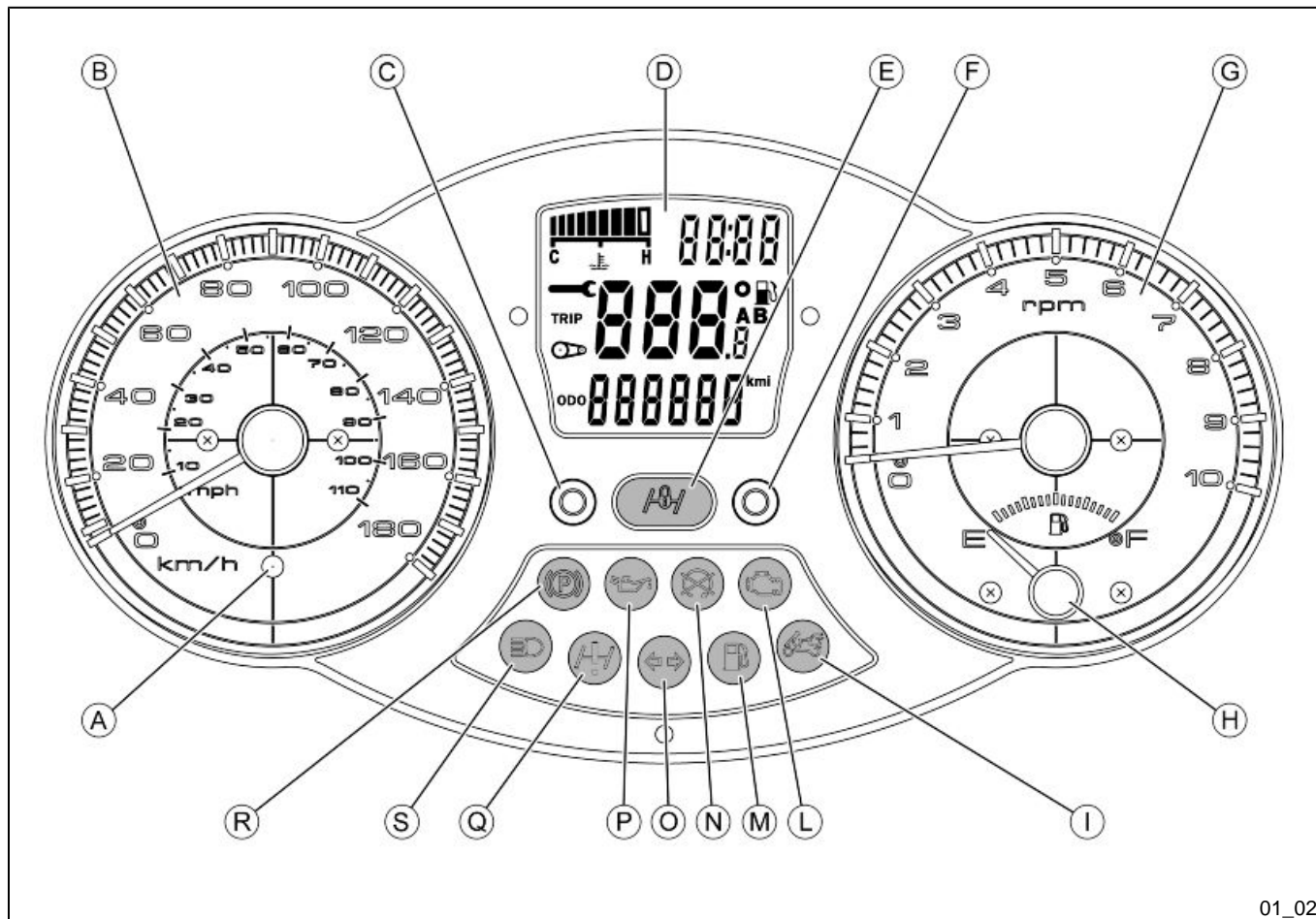

## **Analogue instrument panel (01\_02)**

**A** = Immobilizer / antitheft LED

**B**= Speedometer with twin scale (Km/h and Mph)

**C** = CLOCK switch

**D** = Digital display

**E** = Front suspension locking system warning light

**F**= SET switch

**G** = Rpm indicator

**H** = Fuel gauge

**I** = Warning light for helmet compartment courtesy light on

**L** = Engine control telltale light and injection system failure warning light

**M** = Low fuel warning light

**N** = Engine stop warning light

**O**= Turn indicator warning light

**P** = Low oil pressure warning light

**Q** = Front suspension locking system failure warning light

**R** = Warning light for parking brake engaged

**S** = High-beam warning light

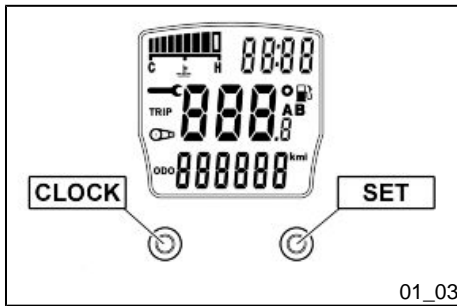

01\_03

### Clock (01\_03)

Pushing the «**CLOCK**» button for less than 1 second displays the following sequence:

- TIME
- DATE

To set the clock push and hold the «**CLOCK**» button longer than 3 seconds.

The numbers showing the hours will begin flashing.

Set the hour using the «**SET**» button. Push the «**CLOCK**» button again and the minutes numbers start flashing.

Set the minutes using the «**SET**» button. Push the «**CLOCK**» button again and the day numbers start flashing.

Set the day with the «**SET**» button. Push the «**CLOCK**» button again and the month numbers start flashing.

Set the month with the «**SET**» button. Push the «**CLOCK**» button again and the year numbers start flashing.

Set the year with the «**SET**» button. Press the «**CLOCK**» button again for 4 seconds to exit the adjustment menu.

During the reset process, not pressing any buttons for a period longer than 8 seconds ends the process automatically and the display shows the modified time.

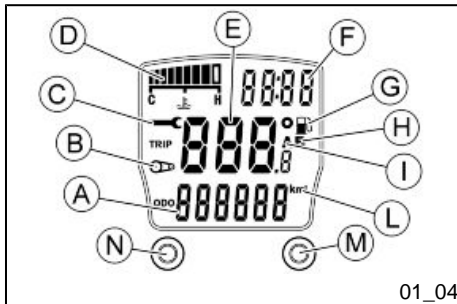

01\_04

### Digital lcd display (01\_04)

A = Total odometer gauge

B = «**BELT**» maintenance icon

C = «**SERVICE**» maintenance icon

D = Engine coolant temperature indicator

E = Trip odometer (A-B) and ambient temperature gauge (selected with the MODE button)

F = TIME-DATE indicator



01\_05

- G** = Low fuel warning light
- H** = Trip odometer gauge (**B**)
- I** = Trip odometer gauge (**A**)
- L** = Kilometre - mile indicator
- M** = «**SET**» button
- N** = «**CLOCK**» button

## Maintenance icons

The icons signal the user that scheduled maintenance operations should be carried out. A flashing «**SERVICE**» icon signals the need to carry out the scheduled maintenance service. A flashing «**BELT**» icon signals the driving belt needs replacing. In any case, vehicle maintenance must be carried out at the kilometre service intervals recommended in this booklet.

### WARNING

**REFER TO THE «SCHEDULED MAINTENANCE TABLE» FOR FURTHER MAINTENANCE OPERATIONS**

### \*MODE\* button (01\_05, 01\_06)

Pushing the "**MODE**" «**S**» button for less than a second displays the following sequence of functions:

1. Trip odometer «**A**»
2. Trip odometer «**B**»
3. Ambient temperature «°»

Push the "**MODE**" «**S**» button for longer than 3 seconds to zero set the trip odometer.

### UNIT OF MEASUREMENT SETTING

Press and hold the "**MODE**" «**S**» button for at least 3 seconds and at the same time turn the ignition key to "**on**".

The icons "**kmi**" and "**°E**" will start flashing.

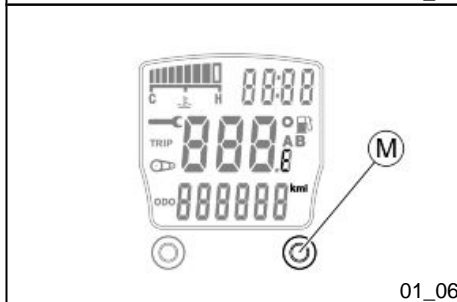

01\_06

"**Kmi**" represents the combination of "**km**" (kilometres) and "**mi**" (miles)

"**E**" represents the combination of "**C**" (degrees Celsius) and "**F**" (degrees Fahrenheit).

By pushing the "**MODE**" «**S**» button for less than a second, the icons "**km**" and "**mi**" are selected sequentially.

Push the "**SET**" button «**M**» to confirm the selection.

Now the ambient temperature icon "**C**" or "**F**" starts flashing.

By pushing the "**MODE**" «**S**» button for less than a second, the icons "**C**" and "**F**" are selected sequentially.

Push the "**SET**" button «**M**» to confirm the selection.

## Key switch (01\_07)

The key switch «**A**» is located on the front knee-guard panel near the bag hook.

### SWITCH POSITIONS

1. **LOCK** = Ignition disabled, extractable key, mechanical antitheft device enabled. The parking brake cannot be released when engaged and can be engaged when released.
2. «**OFF**» = Ignition disabled, extractable key, mechanical antitheft device disabled and enabled/disabled parking brake.
3. **ON** = Ready to start, non-extractable key, mechanical antitheft device disabled.
4. «**HELMET COMPARTMENT OPENING**» = Helmet compartment opening position. Press the key when in «**OFF**» or «**ON**» and turn it anticlockwise.
5. «**FUEL TANK COVER OPENING**» = Fuel tank cover opening position. Press the key when in «**OFF**» or «**ON**» and turn it clockwise.

## Locking the steering wheel (01\_08)

Turn the handlebar to the left as far as it will go; turn the key «**B**» to «**LOCK**» and remove it.

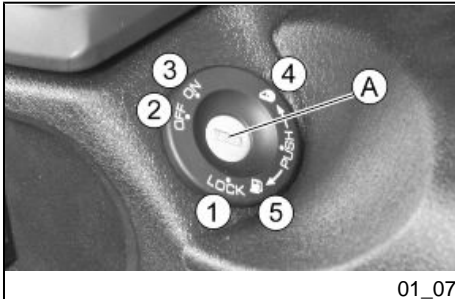

01\_07

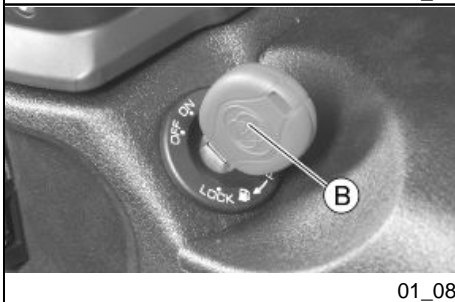

01\_08

**CAUTION**

**DO NOT TURN THE KEY TO «LOCK» OR «OFF» WHILE RIDING.**

**Releasing the steering wheel**

Reinsert the key «B» and turn it to «KEY OFF».

**CAUTION**

**DO NOT TURN THE KEY TO «LOCK» OR «OFF» WHILE RIDING.**

**Switch direction indicators (01\_09)**

Lever «F» towards «1» = left turn indicators switched on;

Lever «F» towards «2» = right turn indicators switched on;

The lever «F» automatically returns to «0 » and the turn indicators remain on; push the lever «F» to turn them off.

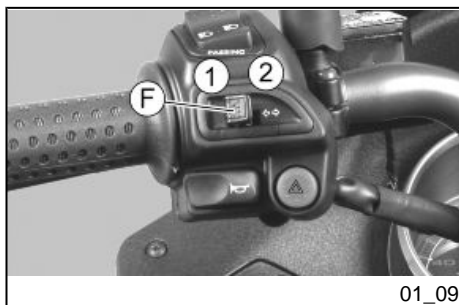

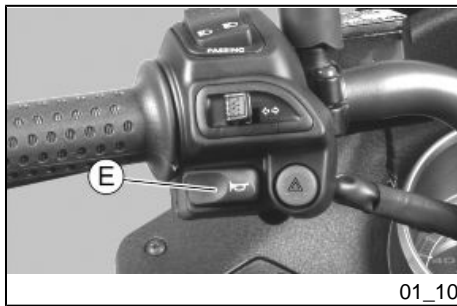

### Horn button (01\_10)

Push the button «E» to sound the horn.

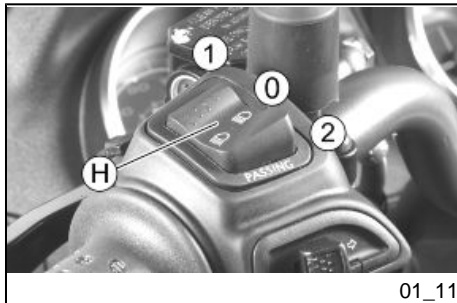

### Light switch (01\_11)

When the light switch «H» is set to «0», the low-beam light is on. When set to «1», the high-beam light is activated. If the light switch «H» is pressed when set to «2», the high-beam light is activated. The switch goes back to «0» automatically.

When the ignition key is set to «ON» and the vehicle is not running, only the tail light is on.

When the ignition key is set to «ON» and the vehicle is running, the low-beam lights will turn on two seconds after the ignition; when the high-beam lights turn on, the low-beam lights turn off.

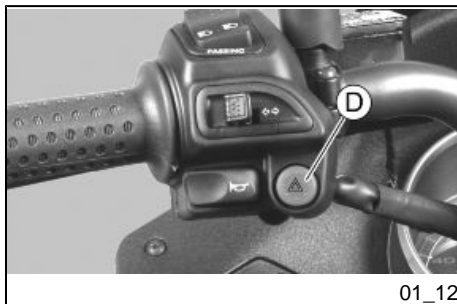

### Emergency flashing light button (01\_12)

It enables the activation of the 4 turn indicators simultaneously. The control «D» can be enabled only with the key set to «ON», but once enabled, it keeps functioning even if the key is set to «OFF» or «LOCK». To disable this function, simply turn the key switch to «ON».





01\_13

### Start-up button (01\_13)

To start the engine, press the starter button «R» after pulling one of the two brake levers.

If the rider is not on the vehicle, the suspension lock will start the engine at idling speed.



01\_14

### Engine stop button (01\_14)

The engine can be started when the emergency cut-off switch «N» is set to «1» **RUN**; if the emergency cut-off switch «N» is set to «0» **OFF**, the engine cannot be started or it shuts off if already running.

#### CAUTION



**DO NOT OPERATE THE ENGINE STOP SWITCH "N" WHILE RIDING UNLESS THERE IS AN EMERGENCY.**



01\_15

### Front suspension unlock-lock switch (01\_15)

The «Q» switch engages and disengages the front suspension locking system.

As the topic is so complex, find the instructions for using this control in the Use chapter.



01\_16

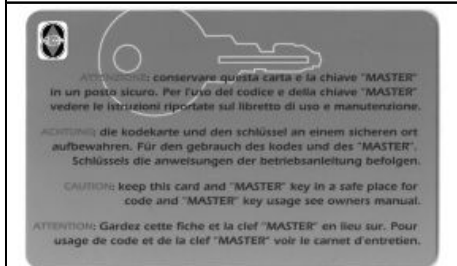

01\_17

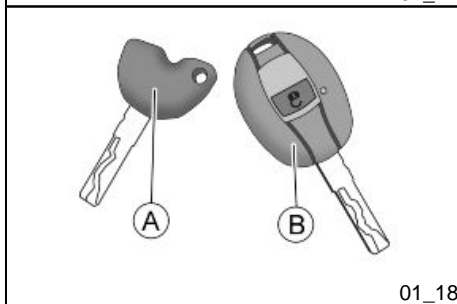

01\_18

## The immobilizer system

In order to enhance theft protection, the scooter is equipped with a «**PIAGGIO IMMOBILIZER**» electronic engine locking device that is activated automatically when the starter key is removed. Upon start-up, the «**PIAGGIO IMMOBILIZER**» system checks the starter key, and only if this key is recognised will the immobilizer system allow the scooter to be started.

### Keys (01\_16, 01\_17, 01\_18)

Two types of keys come with the vehicle.

The key «**A**» is the «**MASTER**» key.

Only a single copy of this key is supplied, which is necessary to program all your other keys and for your dealer to perform some maintenance operations. For this reason it is advised that it be used only in exceptional circumstances.

The key «**B**» (single copy supplied) is used for regular operations such as:

- Engine start-up.
- Remote control saddle opening.

Together with the two keys, you will be given a CODE CARD bearing the same code imprinted onto the two keys.

### WARNING



**LOSING THE RED KEY PREVENTS ANY REPAIRS OF THE "PIAGGIO IMMOBILIZER" SYSTEM AND THE ENGINE CONTROL UNIT.**

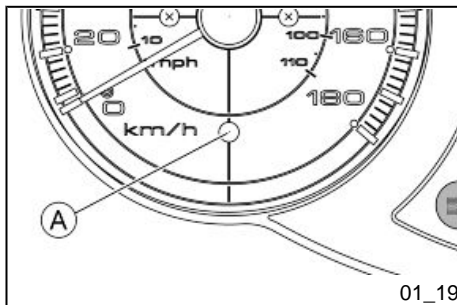

## WARNING



KEEP THE "CODE CARD" AND THE RED HANDGRIP KEY IN A SAFE PLACE (NOT ON YOUR VEHICLE).

### Immobilizerdevice enabled indicator led (01\_19)

Activation of the "PIAGGIO IMMOBILIZER" system is signalled by a flashing «A» indicator. In order to reduce battery discharge, the indicator LED turns off automatically after 48 hours of uninterrupted functioning. Should the system fail, different LED flashing patterns will provide the **Authorised Service Centre** with information on the type of fault detected.

### Operation

Each time the starter key «B» is removed while in the «OFF», or «LOCK» position, the protection system activates the engine lock. Turning the key to "ON" disables the engine lock, provided that the safety system recognises the code transmitted by the key. If the code is not recognised, turn the key first to "OFF" and then to "ON"; if lock persists, try again using the «A» MASTER key. If the engine cannot be started, contact an **Authorised Service Centre**, which is provided with the electronic equipment required to detect and repair the system.

When supplementary keys are required, remember that the programming must be performed on all the keys whether they are new or existing ones.

Contact an **Authorised Service Centre** and bring the «A» MASTER key and all «B» starter keys that you own.

The codes of keys not submitted for the new storage procedure are deleted from the memory. Any lost keys will therefore not be enabled to start the engine.

## WARNING



EACH KEY HAS ITS OWN AND UNIQUE CODE, WHICH MUST BE STORED BY THE SYSTEM CONTROL UNIT.

VIOLENT SHOCKS MAY AFFECT THE ELECTRONIC COMPONENTS OF THE KEY.

IF THE VEHICLE IS SOLD, THE MASTER-HANDGRIP KEY (AS WELL AS THE OTHER STARTER KEYS) AND THE "CODE CARD" MUST ALSO BE TRANSFERRED TO THE NEW OWNER.

### Programming the immobilizer system

Below is described the procedure to follow for programming the **PIAGGIO IMMOBILIZER** system and/or for storing other key codes. The programming procedure should be carried out with the engine stop switch set to «**RUN**».

#### START PROCEDURE

Insert the «**MASTER**» key into the switch (in "**OFF**" position), turning it to «**ON**» position. After 1 - 3 seconds, turn the key to "**OFF**" again and pull it out.

#### INTERMEDIATE STAGE

After extracting the «**MASTER**» key, insert, within ten seconds, the key that is going to be programmed and turn it immediately to «**ON**» position. After 1-3 seconds, turn the key to "**OFF**" again and pull it out. In this way, a maximum of 7 keys can be programmed by repeating the above procedure and keeping the indicated times.

#### FINAL STAGE

After extracting the key to be programmed, insert the «**MASTER**» key again and turn it to «**ON**» position (perform this operation within the ten seconds following the ex-

traction of the previous key). Leave it in this position for 1 to 3 seconds and return it to the «OFF» position.

### CORRECT PROGRAMMING CHECK PHASE

Insert the «MASTER» key, disabling the transponder (i.e., by tilting the key cap by 90°), and turn the key to «ON» position. Perform the engine start-up operation. Ensure that the engine does not start. Insert the programmed key and repeat the start-up operation. Check that engine starts.

### WARNING



**SHOULD YOU STAR THE ENGINE WITH THE MASTER KEY (WITH TRANSPONDER OFF) OR IN THE EVENT OF WRONG OPERATION DURING PROGRAMMING, REPEAT THE PROCEDURE FROM THE BEGINNING.**

### Saddle opening remote control (01\_20)

The scooter is fitted with a remote control to open the saddle. This remote control is supplied together with the keys and it has been programmed to control the opening device control unit at the manufacturing stage. If the remote control is lost, a new one can be requested and programmed at any **Authorised Service Centre**. The remote control is powered by inner batteries that get discharged after extended used; If the green LED turns on when the button is pressed, the remote control is working properly. You may need to replace the batteries if the remote control fails or if its range of operation is reduced. To separate the two halves of the remote control, insert the blade of a plain slot screwdriver at one point on the edge and slide it all around. When the remote control is open, remove the **two batteries** from the contact terminal. Install the two new **CR1616 3V** batteries with the positive pole facing the contact terminal.

Reassemble the remote control by pressing the two clip-on halves gently with your fingers.

To open the saddle without the remote control, follow the procedure described in the «Emergency Saddle Opening» section.

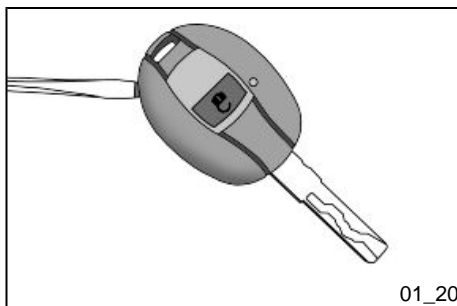

## Remote control programming

Follow these steps to program the remote controls:

1. Insert the remote control key to be programmed in the steering lock key block.
2. Turn the key to «ON», press the button on the remote control, release the button, turn the key back to «OFF» from the «ON» position, all within 4 seconds.
- 3 Wait 1 to 8 seconds.
4. Repeat steps 2 and 3 for 4 times without removing the key.

The control unit confirms the programming has been successfully executed by opening the saddle.

### WARNING



**TO STORE THE OTHER REMOTE CONTROLS TO MEMORY, (MAXIMUM 8), YOU NEED TO REPEAT THE WHOLE PROCEDURE AGAIN. FAILURE TO CARRY OUT THESE OPERATIONS WITHIN THE INDICATED TIMES WILL RESULT IN THE AUTOMATIC CANCELLATION OF THE PROCESS FOR PROGRAMMING THE REMOTE-CONTROLLED KEYS.**

### WARNING



**AVOID PRESSING THE REMOTE CONTROL BUTTON MORE THAN ONCE WHEN FAR AWAY FROM THE SCOOTER. THE SYNCHRONISM BETWEEN THE REMOTE CONTROL AND THE RECEIVER CAN BE IMPAIRED. SHOULD THIS BE THE CASE, REPEAT THE PROGRAMMING PROCEDURE. DO NOT KEEP THE REMOTE CONTROL IN PLACES WITH TEMPERATURES EXCEEDING 60° C THE BATTERY WILL RUN DOWN TOO QUICKLY.**

**WARNING**

**TO AVOID BATTERY DISCHARGE, THE SADDLE OPENING REMOTE CONTROL RADIO RECEIVER DEACTIVATES 7 DAYS AFTER THE LAST TIME THE VEHICLE WAS SHUT OFF.**

**JUST TURN THE KEY TO «ON» TO REACTIVATE THE RECEIVER.**

**Accessing the fuel tank (01\_21, 01\_22)**

To open the fuel tank cover, set the key to «OFF» or «ON», then press and turn it clockwise.

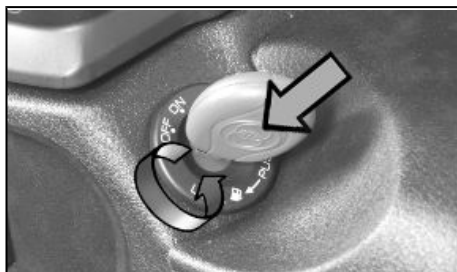

01\_21



01\_22

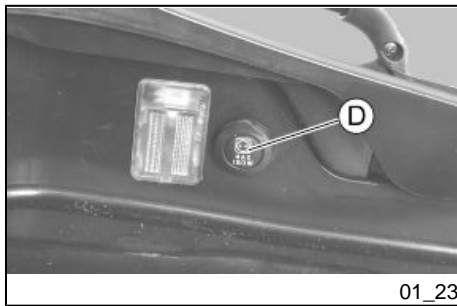

01\_23

## Power supply socket (01\_23)

There is a plug socket "D" inside the helmet compartment.

The plug socket may be used for external consumers (mobile phone, inspection light, etc.).

### CAUTION



**PROLONGED USE OF THE PLUG SOCKET MAY RESULT IN PARTIAL DISCHARGE OF THE BATTERY**

## Electric characteristic

### Plug socket

12 V - 180 W MAX



01\_24

## The saddle (01\_24, 01\_25)

The saddle is supplied with a protection cover which may be used in case of rain.

Lift the saddle and extract the cover from its housing, then extend it over the whole length of the saddle, starting from the front-end; do not over stretch the cover to avoid tearing the material; close the saddle.

### CAUTION



**DO NOT USE THE VEHICLE WITHOUT THE PROTECTION COVER.**

## **Opening the saddle to access the helmet compartment by remote control (01\_26)**

When the key is in «**LOCK**» or «**OFF**» position you can open the saddle using the remote control. The saddle cannot be opened only when the key is set to "ON".



**WARNING**

OBJECTS INAPPROPRIATELY ARRANGED INSIDE THE HELMET COMPARTMENT MAY DEFORM THE SADDLE CAUSING THE COURTESY LIGHT TO REMAIN ON AND THIS WILL DISCHARGE THE BATTERY. IN ANY CASE, THE WARNING LIGHT "I" ON THE INSTRUMENT PANEL SIGNALS IF THE LIGHT IS ON OR OFF.

**WARNING**

THE REMOTE CONTROL OPERATES WITHIN A DISTANCE OF ABOUT 3/5 METRES WITH FULLY CHARGED BATTERIES. WHEN YOU ARE NEAR THE SCOOTER, HANDLE THE REMOTE CONTROL CAREFULLY SO AS TO AVOID UNINTENTIONAL OPENING OF THE SADDLE. REFER TO THE «OPENING THE SADDLE WITH REMOTE CONTROL» SECTION TO REPLACE BATTERIES.

**Opening the saddle (01\_27)**

With the key set to «ON» or «OFF», press it and turn it anticlockwise.



01\_25

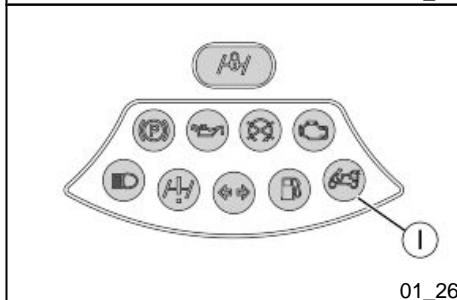

01\_26

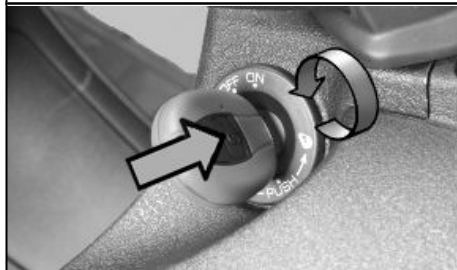

01\_27

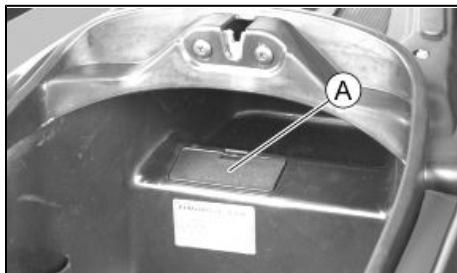

01\_28

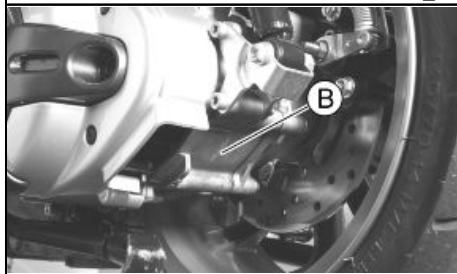

01\_29

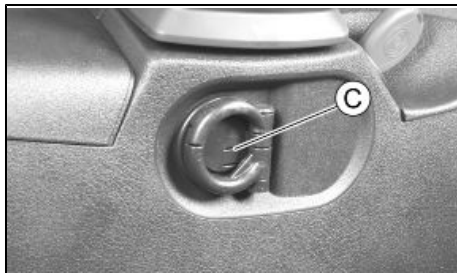

01\_30

## Identification (01\_28, 01\_29)

Identification registration numbers are made up of a prefix and a number stamped on the chassis and on the engine. These numbers must always be quoted when ordering spare parts. We recommend checking that the chassis registration number stamped on the vehicle corresponds with that on the vehicle documentation.

### CAUTION



**BE REMINDED THAT ALTERING IDENTIFICATION REGISTRATION NUMBERS CAN LEAD TO SERIOUS PENAL SANCTIONS (IMPOUNDING OF THE VEHICLE, ETC.).**

#### Chassis number

To read the chassis number, remove the lid «A» in the helmet compartment.

#### Engine number

The engine number «B» is stamped near the rear left shock absorber lower support.

## Bag clip (01\_30)

To use the bag hook «C» mounted on the counter shield, pull it slightly towards the back part of the vehicle.

# Fuoco 500ie



**GILERA®**



**Chap. 02**  
**Use**

## Checks

Before using the vehicle, check:

1. There is enough fuel in the fuel tank.
2. The correct fluid level for front and rear brakes.
3. That tyres are properly inflated.
4. The correct functioning of tail lights, headlamp, turn indicators, stop light and license plate light.
5. The correct functioning of front and rear brakes.
6. The oil level in the gearcase.
7. The engine oil level.
8. The coolant level.

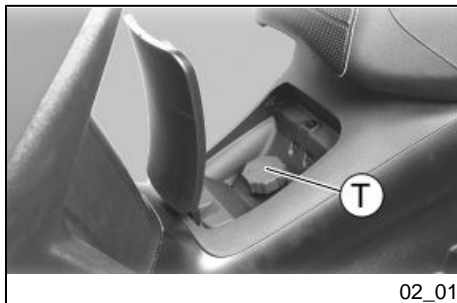

## Refuelling (02\_01, 02\_02)

**Fuel:** Open the access door to the fuel tank cap and remove the cap «**T**».

Recommended fuel: Unleaded petrol, min octane rating of 95. The instrument «**H**» indicates the fuel level and the warning light «**M**» indicates the reserve.

### WARNING



**SWITCH OFF THE ENGINE BEFORE REFUELLING WITH PETROL.**

**PETROL IS HIGHLY INFLAMMABLE.**

**DO NOT SMOKE AND KEEP OPEN FLAMES AT A DISTANCE: FIRE HAZARD.**

**DO NOT INHALE FUEL FUMES.**

**DO NOT ALLOW PETROL TO COME INTO CONTACT WITH HOT ENGINE OR ANY PLASTIC PARTS.**

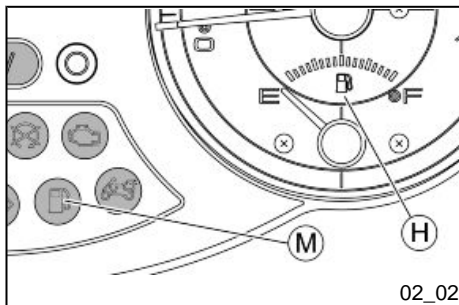

#### CAUTION



PETROL DAMAGES THE PLASTIC PARTS OF THE BODYWORK.

#### WARNING



DO NOT RIDE WITH THE FUEL TANK ALMOST EMPTY, LACK OF FUEL CAN DAMAGE THE CATALYTIC CONVERTER.

#### CAUTION



USING NON-RECOMMENDED PETROL REDUCES THE EFFICIENCY OF THE EXHAUST AND FUEL SUPPLY SYSTEMS.

#### CAUTION



DO NOT USE THE VEHICLE TO THE COMPLETE EXHAUSTION OF THE FUEL; IN THE EVENT THAT THIS SHOULD OCCUR, DO NOT ATTEMPT TO START THE ENGINE. TURN THE KEY SWITCH TO OFF AND TOP-UP THE TANK AS SOON AS POSSIBLE. FAILURE TO FOLLOW THESE GUIDELINES COULD DAMAGE THE FUEL PUMP AND/OR THE CATALYTIC CONVERTER.

#### WARNING



IT IS HIGHLY INADVISABLE TO REFUEL USING METHODS OTHER THAN NORMAL FUEL PUMPS. IF PETROL IS NOT COMPLETELY CLEAN, IT CAN DAMAGE THE FUEL SUPPLY SYSTEM FILTERS.

**CAUTION**

**USING OILS OTHER THAN THOSE RECOMMENDED CAN SHORTEN THE LIFE OF THE ENGINE.**

**Characteristic****Fuel tank (reserve)**

~ 12 l (~2 l)

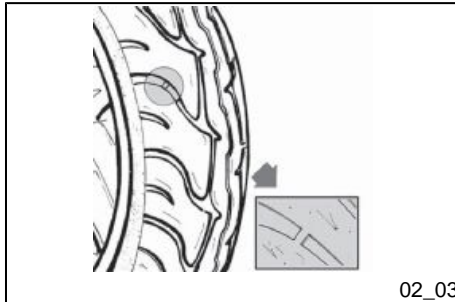

02\_03

**Tyre pressure (02\_03)**

Check the tyre pressure and wear periodically (roughly every 500 km). Tyres feature wear indicators; replace tyres as soon as these indicators become visible on the tyre tread. Also check that the tyres do not show signs of splitting at the side or irregular tread wear; if this occurs, go to an authorised workshop or at least to a workshop equipped to perform the replacement.

**CAUTION**

**TYRE PRESSURE SHOULD BE CHECKED WHEN TYRES ARE COLD. INCORRECT TYRE PRESSURE CAUSES ABNORMAL TYRE WEAR AND MAKES RIDING DANGEROUS.**

**TYRES MUST BE REPLACED WHEN THE TREAD REACHES THE WEAR LIMITS SET FORTH BY LAW.**

**TYRES**

Front tyre

Tubeless 120/70-12" 51S or 51P

Rear tyre	Tubeless 140/70 - 14" 68S or 68P reinf
-----------	---

### **TYRE INFLATION PRESSURE**

Front tyre pressure (with passenger)	1.6 bar (1.8 bar)
--------------------------------------	-------------------

Rear tyre pressure (with passenger)	2.4 bar (2.6 bar)
-------------------------------------	-------------------

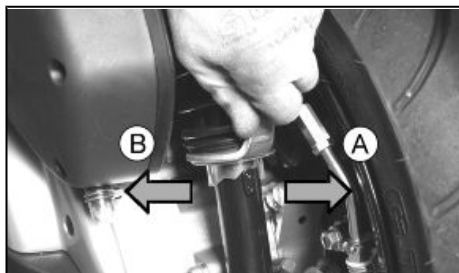

02\_04

### **Shock absorbers adjustment (02\_04, 02\_05)**

The preloading of the springs can be adjusted to 4 positions using the ring nut located in the lower part of the shock absorbers and the specific spanner supplied.

**Position 1:** minimum preload: driver only

**Position 2:** medium preloading: driver only

**Position 3:** medium preloading: rider and passenger

**Position 4:** maximum preloading: driver, passenger, and luggage.

In order to carry out this operation you will need to use the specific spanner in the kit. Spring preloading increases by turning the ring nut towards «A», but decreases if the ring nut is turned towards «B».

#### **CAUTION**



**RIDING THE VEHICLE WITH THE SPRING PRELOADING NOT CORRECTLY SET FOR THE RIDER AND POSSIBLE PASSENGER, COULD REDUCE THE COMFORT OF THE RIDE AND THE PRECISION OF THE STEERING.**

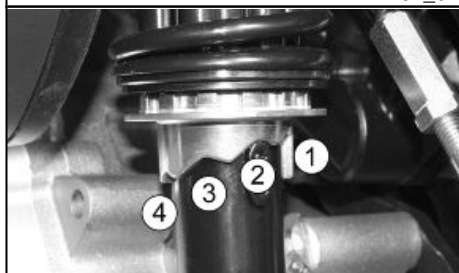

02\_05

**WARNING**



**WE RECOMMEND WEARING GLOVES WHILE CARRYING OUT THIS OPERATION IN ORDER TO AVOID INJURIES.**

**WARNING**



**WE STRONGLY RECOMMEND NOT TO ADJUST BOTH SHOCK ABSORBERS WITH DIFFERENT PRELOADING**

## **Running in**

**DURING THE FIRST 1000 KM DO NOT RIDE THE VEHICLE OVER 80% OF ITS MAX. SPEED. AVOID OPENING THE THROTTLE GRIP COMPLETELY OR KEEPING A CONSTANT SPEED ALONG LONG SECTIONS OF ROAD. AFTER THE FIRST 1000 KM INCREASE SPEED PROGRESSIVELY, IF POSSIBLE, UNTIL THE MAXIMUM PERFORMANCE IS OBTAINED.**

**CAUTION**



**IN ORDER TO AVOID DAMAGING THE VEHICLE, PLEASE COMPLY WITH THE RULES LISTED ABOVE.**



## Starting up the engine (02\_06, 02\_07, 02\_08)

The vehicle is supplied with an ignition cut-off system, activated by the emergency cut-off switch. The engine cannot be started if the ignition cut-off switch is in the **OFF position**

A running engine automatically switches off when the ignition cut-off switch is set to **OFF**.

The vehicle is equipped with automatic transmission with direct drive, so that starting is effected by turning the throttle grip to idle speed; to start-off from stationary position, progressively twist the throttle grip. The vehicle is equipped with an electrical fuel pump that switches on automatically as soon as the engine is started. The vehicle has a front suspension locking system; a sensor placed under the saddle will prevent the vehicle riding, but not its starting-up, if the rider is not seated in riding position.

To start-up the engine:

1. Rest the vehicle on its centre-stand, ensuring the rear wheel is not touching the ground.
2. Maintain the throttle grip "P" completely untwisted.
3. Insert the key into the ignition switch «A» and turn it onto the **ON** position.
4. Make sure that the «N» switch is set to the **RUN** position.
5. Pull either the front «O» or rear «G» brake lever, while pressing the starter button «R».

### WARNING



**THE AUTOMATIC TRANSMISSION MAKES THE REAR WHEEL TURN EVEN WHEN THE THROTTLE IS SLIGHTLY TWISTED. RELEASE THE BRAKE CAREFULLY AFTER STARTING, AND THEN ACCELERATE GRADUALLY.**

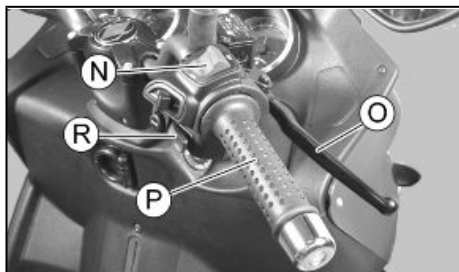

02\_06

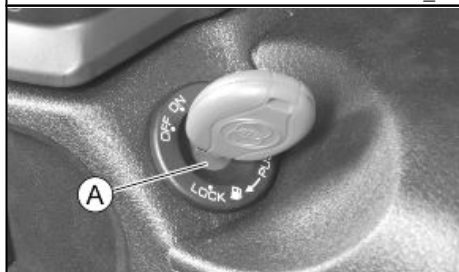

02\_07

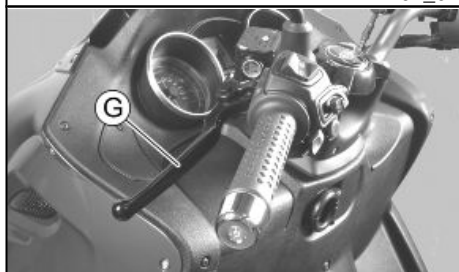

02\_08

**CAUTION**

**DO NOT START-UP THE ENGINE IN CLOSED AREAS BECAUSE EXHAUST GASES ARE TOXIC.**

**CAUTION**

**DUE TO THE HIGH TEMPERATURES THE CATALYTIC CONVERTER CAN REACH, ALWAYS TAKE CARE, WHEN PARKING THE SCOOTER, THAT THE EXHAUST DOES NOT COME INTO CONTACT WITH FLAMMABLE MATERIALS, TO AVOID SERIOUS BURNS.**

**CAUTION**

**DO NOT SWITCH OFF THE ENGINE WHILE THE VEHICLE IS MOVING. UN-BURNED FUEL COULD ENTER THE CATALYTIC CONVERTER AND BURN, CAUSING IT TO OVERHEAT AND POSSIBLY DESTROYING IT.**

**CAUTION**

**NEITHER PUSH THE STARTER BUTTON NOR TURN THE KEY SWITCH TO «ON» WHEN THE TANK IS EMPTY SINCE THE START-UP SYSTEM MAY GET DAMAGED.**

**WARNING**

**NEVER TRY TO START-UP THE ENGINE WITH THE THROTTLE GRIP TWISTED. THIS MAY LEAD TO LOSING CONTROL OF THE VEHICLE AND TO ROLLOVER, WITH CONSEQUENT SERIOUS OR, IN SOME CASES, LETHAL INJURIES.**

**Precautions****CAUTION**

**NEVER STRESS THE ENGINE AT LOW TEMPERATURES IN ORDER TO AVOID POSSIBLE DAMAGE. BE CAREFUL NEVER TO EXCEED THE MAXIMUM SPEED WHILE RUNNING DOWNHILL, IN ORDER TO AVOID DAMAGING THE ENGINE. IN ANY CASE, IN ORDER TO PRESERVE THE ENGINE FROM PROLONGED EXCESSIVE REVOLUTIONS, THE REVOLUTION LIMITER WILL BE ACTIVATED IF THE ENGINE SPEED EXCEEDS THE ESTABLISHED THRESHOLD.**

**WARNING**

**AFTER A LONG DISTANCE COVERED AT THE MAXIMUM SPEED, DO NOT STOP THE ENGINE IMMEDIATELY, BUT LET IT RUN AT IDLE FOR A FEW SECONDS.**

**Difficult start up**

In the rare case of flooding the engine, to facilitate start-up, it is possible to try to put the vehicle into action with the gas hand grip partially or completely open. It is however necessary, once the engine is started, to take your vehicle to an **Authorised Service Centre** to determine the cause of this problem and to re-establish the vehicle proper functioning.

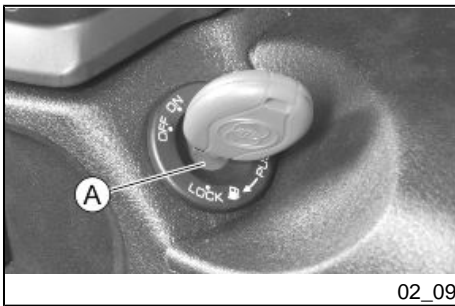

02\_09

## Stopping the engine (02\_09)

Fully untwist the throttle grip, then rotate the key in the switch «A » to «KEY OFF» (extractable key).

### CAUTION



**DUE TO THE HIGH TEMPERATURES THE CATALYTIC CONVERTER CAN REACH, ALWAYS TAKE CARE, WHEN PARKING THE SCOOTER, THAT THE EXHAUST DOES NOT COME INTO CONTACT WITH FLAMMABLE MATERIALS, TO AVOID SERIOUS BURNS.**

### CAUTION



**DO NOT SWITCH OFF THE ENGINE WHILE THE VEHICLE IS MOVING. UNBURNED FUEL COULD ENTER THE CATALYTIC CONVERTER AND BURN, CAUSING IT TO OVERHEAT AND POSSIBLY DESTROYING IT.**

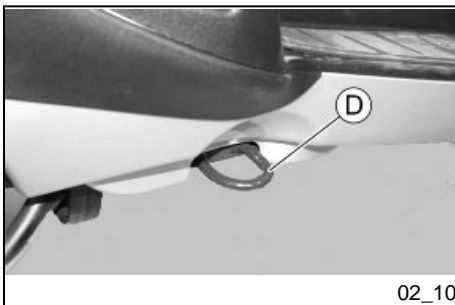

02\_10

## anello antifurto (02\_10)

The «D» ring on the right side of the vehicle is used to fasten the vehicle to an object using a scooter chain. Do not use the ring for other purposes.

### WARNING



**THIS ACCESSORY IS NOT A THEFT PREVENTION GUARANTEE, IT IS ONLY A DETERRENT.**

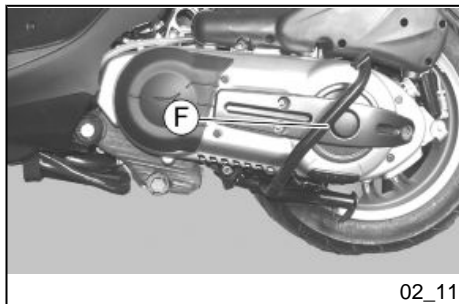

## Stand (02\_11)

Push with your foot on the centre stand's fork "F" while lifting the vehicle backward, holding onto the handlebar.

## Automatic transmission

To ensure simple, pleasurable riding, the vehicle is equipped with automatic transmission with regulator and centrifugal clutch. The system is designed to provide the best performance (acceleration and consumption) while riding on both flat roads and uphill.

If you have to stop on an uphill slope (traffic lights, traffic jam, etc.) **use only the brake to keep the vehicle still, leaving the engine running at idle speed. Using the engine to keep the vehicle still can cause the clutch to overheat, due to the friction of the clutch masses against the capstan. Besides, avoid accelerating with the hand brake engaged.** It is therefore recommended to avoid conditions of prolonged clutch slippage (besides those previously indicated) like driving uphill fully laden on steep slopes or starting off with driver and passenger at slopes greater than 25%.

Observe the following precautions if the clutch overheats:

1. Do not continue riding in such conditions.
2. Let the clutch cool down with the engine at idle speed for a few minutes.

## Safe driving

Some simple tips are provided below that will enable you to use your vehicle on a daily basis, confidently and safely. Your skill and your mechanical knowledge are the basis

of safe riding. We recommend practising riding in traffic-free zones, in order to acquire a good knowledge of your vehicle.

1. Before riding off, remember to put on your helmet and fasten it correctly.
2. Reduce speed on rough roads and drive with care.
3. After riding on a long stretch of wet road without using the brakes, braking can be poor at the beginning. Given these conditions, it is a good idea to operate the brakes from time to time.
4. Avoid setting off by mounting the vehicle while it is resting on the support. In any case, the rear wheel should not be turning when it comes into contact with the ground, in order to avoid abrupt departures.
5. If driving over roads affected by sand, mud, snow mixed with salt, etc., we recommend cleaning the brake disc with a non-corrosive detergent frequently in order to prevent corrosive particles from building up in the holes, which may cause early brake pad wear.

#### CAUTION



**ALWAYS RIDE WITHIN YOUR LIMITS RIDING UNDER THE INFLUENCE OF ALCOHOL OR OTHER DRUGS AND CERTAIN MEDICATIONS IS EXTREMELY DANGEROUS.**

#### CAUTION



**IN ORDER TO PREVENT ANY ACCIDENTS RIDE VERY CAREFULLY AFTER ADDING ACCESSORIES AND WHILE CARRYING LUGGAGE. ADDING ACCESSORIES AND LUGGAGE CAN REDUCE THE VEHICLE'S STABILITY, PERFORMANCE AND SAFETY DURING USE.**

**WARNING**

**NEVER RIDE THE VEHICLE WITH ADDED ACCESSORIES (CASE AND/OR WINDSHIELD) FASTER THAN 120 KM/H. WITHOUT THESE ACCESSORIES THE VEHICLE MAY BE DRIVEN AT A HIGHER SPEED WITHIN THE LEGAL LIMITS. IF THERE ARE NOT-PIAGGO ACCESSORIES FITTED, OR AN ABNORMAL LOAD, OR IF THE VEHICLE IS NOT IN A GENERALLY GOOD CONDITION, OR WHENEVER WEATHER CONDITIONS DEMAND IT, SPEED SHOULD BE FURTHER REDUCED.**

**CAUTION**

**DO NOT ADJUST THE MIRRORS WHILE RIDING. THIS COULD CAUSE YOU TO LOOSE CONTROL OF THE VEHICLE.**

**CAUTION**

**ANY CHANGES TO THE VEHICLE PERFORMANCE AS WELL AS ALTERATIONS TO ORIGINAL STRUCTURAL PARTS IS STRICTLY FORBIDDEN BY LAW, AND RENDERS THE VEHICLE NO LONGER CONFORMING TO THE APPROVED TYPE AND DANGEROUS FOR RIDING.**

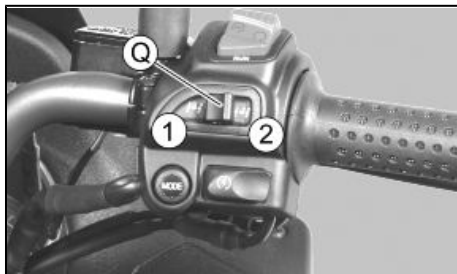

02\_12

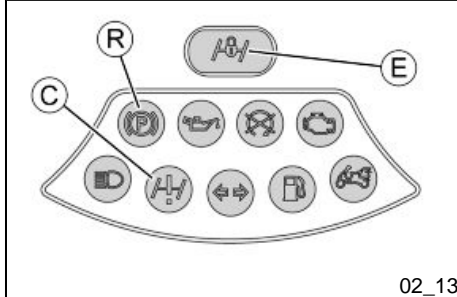

02\_13

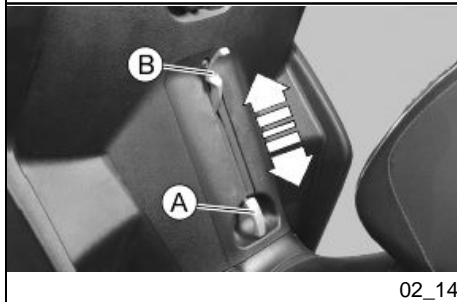

02\_14

## Front suspension locking system (02\_12, 02\_13, 02\_14, 02\_15, 02\_16, 02\_17)

The front suspension locking system simply prevents vehicle tilting when the «Q» switch is pressed.

The warning light «E» starts flashing when the key switch is set to «ON». This means that the system is enabled for locking activation.

When the «Q» switch is turned to «1», a continuous sound alarm signals that the locking system is engaged and, at the same time, the warning light «E» turns on steadily.

When the «Q» switch is turned to «2», an intermittent sound alarm signals that the locking system is disengaged and, at the same time, the warning light «E» starts flashing again. Warning light «E» turns off when riding starts. This means that the system allows for vehicle tilting.

Engaging tilt locking is possible only if the following conditions occur at the same time:

- Throttle completely untwisted
- Engine rpm below 2500 rpm
- Vehicle speed below 10 km/h
- Locking system WARNING light «C» off (the system has not detected failures)

If one of these conditions is not checked, the warning light «E» remains off and locking cannot be engaged (in normal riding conditions, the warning light «E» is off).

With engine on, system locked and warning light «E» on, the suspension locking system is disengaged automatically and the warning light «E» turns off when the throttle is twisted to start the ride.

For riders' safety, the vehicle has a **rider detection sensor** in the saddle which enables the system to prevent vehicle motion and suspension unlocking (in case of locked suspension) when the rider is not properly seated in riding position: in such case, the WARNING light «C» turns on steadily





02\_15

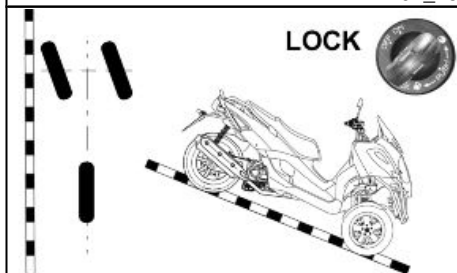

02\_16

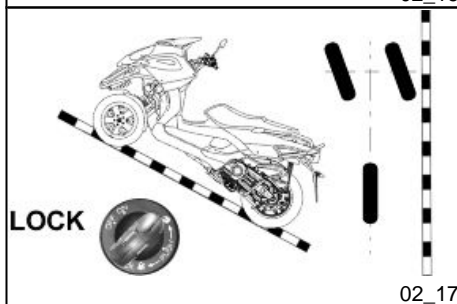

02\_17

**CAUTION**

THE RIDER DETECTION SENSOR IS LOCATED IN THE FRONT PART OF THE SADDLE. AVOID PLACING BAGS OR HEAVY OBJECTS ACCIDENTALLY ON THE SADDLE.

NOT OBSERVING THIS RULE MAY MOVE THE VEHICLE FORWARD AND RELEASE THE SUSPENSION LOCKING SYSTEM EVEN IF THE RIDER IS NOT SEATED, BY SIMPLY TWISTING THE THROTTLE. THE VEHICLE COULD FALL ACCIDENTALLY AS A CONSEQUENCE.

**WARNING**

EVERY TIME THE VEHICLE IS STOPPED, MAKE SURE THE FRONT SUSPENSION LOCKING SYSTEM IS ENGAGED. OTHERWISE, PLACE YOUR FEET ON THE GROUND TO KEEP THE VEHICLE UPRIGHT.

**WARNING**

AVOID USING THE LOCKING SYSTEM WHEN RIDING THE VEHICLE ALONG IRREGULAR ROADS OR ROADS WITH OBSTACLES (E.G. ROAD HUMPS, SIDEWALK, ETC.).

IN CASE OF ENGINE FAILURE (DISCHARGED BATTERY) AVOID PULLING THE VEHICLE WITH THE LOCKING SYSTEM ENGAGED.

WITH THE LOCKING SYSTEM ENGAGED AND THE ENGINE OFF, AVOID MOVING THE VEHICLE AT SPEEDS ABOVE 5 Km/h.

**WARNING**

**IF THE RIDER IS NOT SEATED ON THE SADDLE WHILE THE VEHICLE IS IN MOTION AND THE LOCKING SYSTEM IS ENGAGED, AVOID OPERATING THE THROTTLE CONTROL PURPOSELESSLY AS THIS MAY DAMAGE THE CATALYTIC CONVERTER.**

**CAUTION**

**DO NOT RIDE DOWNHILL WITH THE SUSPENSION LOCKING SYSTEM ENGAGED AND THE KEY SWITCH SET TO OFF.**

With the vehicle off and the suspension locking system engaged, it is possible to get off the vehicle without using the stand. For safety reasons, it is recommended to press the hand brake lever shown in the figure, moving it from position «A » to position «B».

When the hand brake «B» is engaged, warning light «R» on the instrument panel turns on.

When the hand brake is set to «B» and the key switch is turned to position «1», the safety system that prevents the hand brake from getting released is activated. To release the hand brake, turn the key switch to «2» or «3». If the switch is set to «1 », the hand brake can also be engaged.

**WARNING**

**IT IS PREFERABLE TO USE THE STAND IF THE VEHICLE STOPS ON A STEEP SLOPE.**

**ALWAYS OBSERVE THE CUSTOMARY SAFETY PRECAUTIONS FOR CASES WHEN THE VEHICLE STOPS ON A STEEP SLOPE. TURN THE WHEELS SO**

**THAT THE POTENTIAL MOVEMENT CAUSED BY THE SLOPE TAKES THAT WHEEL AGAINST THE SIDEWALK. WITH THE STEERING LOCK ENGAGED, MANOEUVRE SO THAT THE SIDEWALK IS TO THE RIGHT WHEN YOUR VEHICLE IS PARKED UPHILL AND TO THE LEFT WHEN PARKED DOWNHILL.**

If the WARNING light «C» turns on (flashes), it means that there is a failure in the front suspension locking system. Therefore, it is necessary to contact an **Authorised Service Centre**. If the front suspension is locked, it can be unlocked by operating the «Q» switch twice quickly on the unlocking position «2». Once the suspension is unlocked, the vehicle can be normally used, except for the locking system which will be disengaged.

For some cases of failure, the vehicle speed is auto-limited to 30 Km/h. This automatic procedure is activated to enhance safety until the failure is eliminated.

Always contact an **Authorised Service Centre**.

If the continuous sound alarm is activated when the WARNING light «C» turns on (steadily), try to unlock the system by operating the «Q» switch twice quickly to the unlocking position «2». If it cannot be unlocked, contact an **Authorised Service Centre**.



# Fuoco 500ie



**GILERA®**



**Chap. 03  
Maintenance**

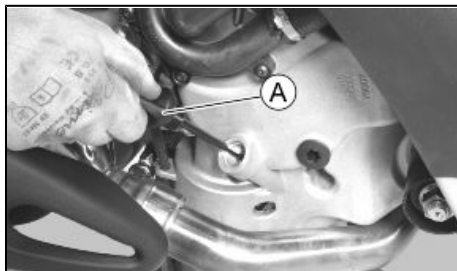

03\_01

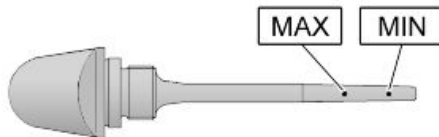

03\_02

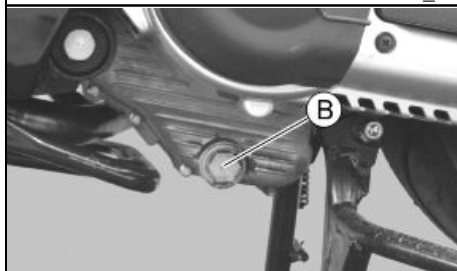

03\_03

## Engine oil level

In 4T engines, engine oil is used to lubricate the distribution elements, main bearings and thermal group. **An insufficient quantity of oil can cause serious damage to the engine itself.** In all four-stroke engines, a loss of efficiency in oil performance and consumption should be considered normal. Consumption can particularly reflect the conditions of use (i.e. when driving at "full acceleration" all the time, oil consumption increases). The replacement frequencies provided for by the maintenance programme are defined, depending on the total contents of oil in the engine and average consumption measured following standardised methods. **In order to prevent any problems, we recommend checking oil level more frequently than indicated in the Scheduled Maintenance table or before setting off on long journeys. The vehicle is, however, equipped with an oil pressure warning light on the instrument panel.**

### Engine oil level check (03\_01, 03\_02)

Every time the vehicle is used, visually inspect the level of the engine oil when the engine is cold (after **completely unscrewing** the oil cap/dipstick). The oil level should be somewhere between the MAX and MIN reference marks on the dipstick «A»; during the oil check, the vehicle must be resting on its centre stand on an even, horizontal surface.

If the check is carried out after the vehicle has been used, and therefore with a hot engine, the level line will be lower; in order to carry out a correct check, wait at least 10 minutes after the engine has been stopped so as to get the correct level.

### Engine oil top-up

Always check the oil level before carrying out top ups and add oil without exceeding the **MAX** level. Getting an oil level between the **MIN and MAX levels** requires ~ **400 cm<sup>3</sup>** of oil. An oil check-up and top-up should be carried out at any **Authorised Service Centre**, as indicated in the scheduled maintenance table.

### Warning light (insufficient oil pressure)

The vehicle is equipped with a warning light that lights up when the key is turned to the «ON». However, this light should switch off once the engine has been started. **If the light comes on while braking, at idle speed or while turning a corner, it is**

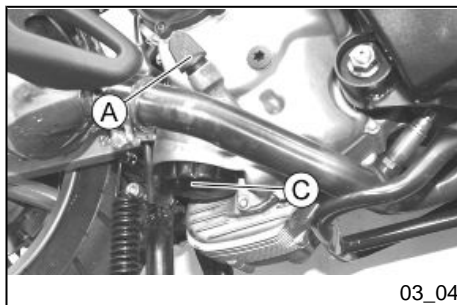

03\_04

necessary to check the oil level and top it up if required. If after having topped-up the oil, the warning light still comes on while braking, at idle speed or while turning a corner, it will be necessary to take your vehicle to an Authorised Service Centre.

### Engine oil change (03\_03, 03\_04)

The oil and the filter must be changed as indicated in the scheduled maintenance table at an **Authorised Service Centre**. The engine should be emptied by draining the oil via the drainage tap «**B**» of the mesh filter on the transmission side. In order to facilitate oil drainage, loosen the cap/dipstick «**A**». Unscrew and remove the oil cartridge filter «**C**». Install a new oil filter taking care to lubricate the sealing O-rings with engine oil. Since a certain quantity of oil still remains in the circuit, add approximately 1500 cm<sup>3</sup> of oil through cap «**A**». Then start up the scooter, leave it running for a few minutes and switch it off: after five minutes, check the level and if necessary, top-up **without exceeding the MAX. level**. The cartridge filter must be replaced at every oil change. For top-ups and oil changes, use new oil of the recommended type.

#### CAUTION



**RUNNING THE ENGINE WITH INSUFFICIENT LUBRICATION OR WITH INADEQUATE LUBRICANTS ACCELERATES THE WEAR AND TEAR OF THE MOVING PARTS AND CAN CAUSE IRRETRIEVABLE DAMAGE.**

**TOPPING UP THE ENGINE WITH AN EXCESSIVE AMOUNT OF OIL MAY CAUSE MALFUNCTION AND/OR A DROP IN PERFORMANCE OF THE VEHICLE.**

**USING OILS OTHER THAN THOSE RECOMMENDED CAN SHORTEN THE LIFE OF THE ENGINE.**

#### CAUTION



**USED OILS CONTAIN SUBSTANCES HARMFUL TO THE ENVIRONMENT. FOR OIL REPLACEMENT, CONTACT AN AUTHORISED SERVICE CENTRE, WHICH IS EQUIPPED TO DISPOSE OF USED OILS IN AN ENVIRONMENTALLY FRIENDLY AND LEGAL WAY.**

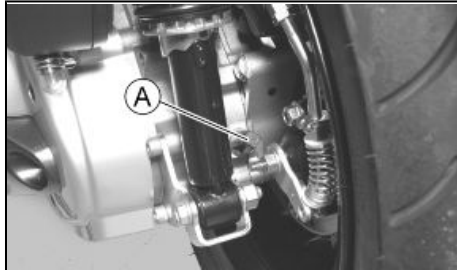

03\_05

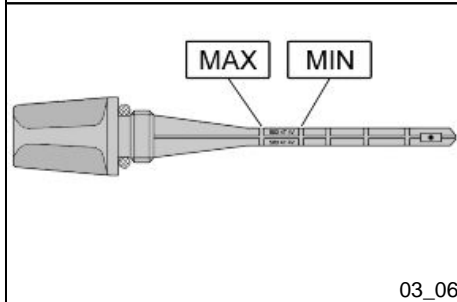

03\_06

## Recommended products

### AGIP CITY HI TEC 4T

#### *Engine oil*

SAE 5W-40, API SL, ACEA A3, JASO MA Synthetic oil

### Hub oil level (03\_05, 03\_06)

Check the oil in the rear hub. (oil content ~ 250 cc). To check the rear hub oil level, proceed as follows:

- 1) Rest the vehicle onto its centre stand, on level ground.
- 2) Unscrew the dipstick «A», dry it with a clean cloth and then reinsert it **screwing it fully into place**.
- 3) Pull out the dipstick to control that the oil level reaches the second notch from the bottom, as indicated by the arrow in figure, this is the correct level and must remain constant at all times.
- 4) Screw the dipstick back in, checking that it is correctly locked in place.

#### CAUTION



**RIDING THE VEHICLE WITH INSUFFICIENT HUB LUBRICATION OR WITH CONTAMINATED OR IMPROPER LUBRICANTS ACCELERATES THE WEAR AND TEAR OF THE MOVING PARTS AND CAN CAUSE SERIOUS DAMAGE.**

#### CAUTION



**USED OIL CAN HARM THE ENVIRONMENT. COLLECTION AND DISPOSAL SHOULD BE CARRIED OUT IN COMPLIANCE WITH CURRENT REGULATIONS.**



**CAUTION**

AN EXCESSIVE QUANTITY OF OIL CAN LEAD TO LEAKAGE, WHICH MAY CAUSE THE ENGINE AND THE WHEEL TO GET DIRTY.

**CAUTION**

WHEN REPLACING THE HUB OIL DO NOT LET THE OIL COME INTO CONTACT WITH THE REAR BRAKE DISC.

**CAUTION**

FOR OIL REPLACEMENT, CONTACT ANY AUTHORISED SERVICE CENTRE AS THEY ARE EQUIPPED TO DISPOSE OF USED OILS IN AN ENVIRONMENTALLY FRIENDLY AND LEGAL WAY.

**Recommended products**

**AGIP ROTRA 80W-90**

*Rear hub oil*

SAE 80W/90 Oil that exceeds the requirements of API GL3 specifications

**Characteristic**

**Transmission oil**

250 cm<sup>3</sup>

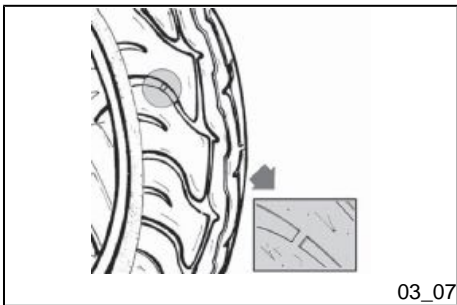

## Tyres (03\_07)

Check the tyre pressure and wear periodically (roughly every 500 km). Tyres feature wear indicators; replace tyres as soon as these indicators become visible on the tyre tread. Also check that the tyres do not show signs of splitting at the side or irregular tread wear; if this occurs, go to an authorised workshop or at least to a workshop equipped to perform the replacement.

### CAUTION



**TYRE PRESSURE SHOULD BE CHECKED WHEN TYRES ARE COLD. INCORRECT TYRE PRESSURE CAUSES ABNORMAL TYRE WEAR AND MAKES RIDING DANGEROUS.**

**TYRES MUST BE REPLACED WHEN THE TREAD REACHES THE WEAR LIMITS SET FORTH BY LAW.**

### WARNING



**THE WHEELS FITTED WITH TYRES SHOULD ALWAYS BE BALANCED. RIDING THE VEHICLE WITH VERY LOW TYRE PRESSURE OR WITH INCORRECTLY BALANCED TYRES CAN LEAD TO DANGEROUS STEERING VIBRATIONS.**

## TYRES

Front tyre	Tubeless 120/70-12" 51S or 51P
Rear tyre	Tubeless 140/70 - 14" 68S or 68P rein

## TYRE INFLATION PRESSURE

Front tyre pressure (with passenger)	1.6 bar (1.8 bar)
--------------------------------------	-------------------

Rear tyre pressure (with passenger)	2.4 bar (2.6 bar)
-------------------------------------	-------------------

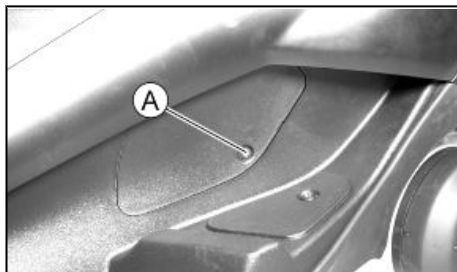

03\_08

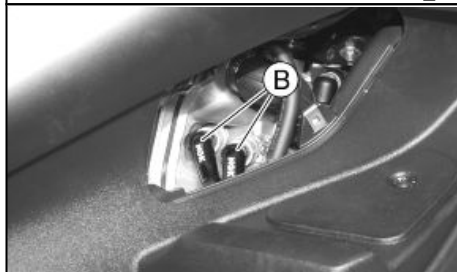

03\_09

### Spark plug dismantlement (03\_08, 03\_09)

This engine has two spark plugs.

Remove the port on the left-hand side panel of the vehicle by undoing the fixing screw «A» and using a small screwdriver in the rear notch shown in the figure, then proceed as follows:

1. Disconnect the spark plug HV wire caps «B».
2. Unscrew the spark plugs using the supplied spark plug wrench.
3. When refitting, place the spark plugs into the hole at the due inclination and tighten it by hand until it is finger tight;
4. Only use the wrench to lock it in place.
5. Place the «B» caps fully over the spark plugs.
6. Refit the port making sure the rear hook is inserted.

#### CAUTION



**SPARK PLUGS MUST BE REMOVED WHEN THE ENGINE IS COLD. SPARK PLUGS MAINTENANCE OPERATIONS ARE DESCRIBED IN THE SCHEDULED MAINTENANCE TABLE. USING NON-CONFORMING ELECTRONIC CENTRAL UNITS AND ELECTRONIC IGNITIONS OR SPARK PLUGS OTHER THAN THOSE PRESCRIBED MAY SERIOUSLY DAMAGE THE ENGINE.**

**N.B.**

THE USE OF SPARK PLUGS OTHER THAN THE INDICATED TYPE OR OF SHIELDLESS SPARK PLUG CAPS CAN CAUSE ELECTRICAL SYSTEM FAILURES.

**Characteristic****Spark plug**

NGK CR7EKB

**Electrode gap**

0.7 ÷ 0.9 mm

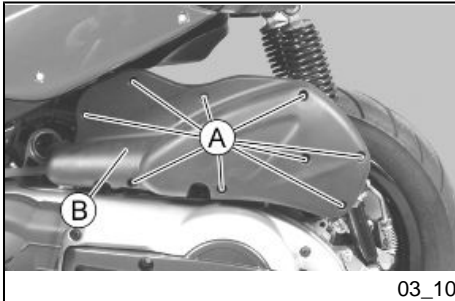
**Removing the air filter (03\_10)**

Proceed as follows:

Unscrew the nine fixing screws «A» and remove the air filter cover «B».

**Air filter cleaning**

1. Wash the sponge with water and neutral soap.
2. Dry it with a clean cloth and small blasts of compressed air.
3. Impregnate the sponge with a mixture of 50% petrol and 50% specified oil.
4. Gently squeeze the filter element, let it drip and then refit it.

**CAUTION**

**IF THE VEHICLE IS USED ON DUSTY ROADS IT IS NECESSARY TO CARRY OUT MAINTENANCE CONTROLS OF THE AIR FILTER TO AVOID DAMAGING THE ENGINE.**

**Recommended products****AGIP FILTER OIL**

*Oil for air filter sponge*

Mineral oil with specific additives for increased adhesiveness

**Cooling fluid level (03\_11, 03\_12, 03\_13, 03\_14)**

The engine cooling system operates by forcing circulation of fluid. The cooling circuit contains about 2 litres of coolant consisting of a mixture of 50% de-ionised water and glycol ethylene-based antifreeze solution with corrosion inhibitors. Recommended coolant: supplied with the vehicle, already mixed and ready for use. For proper functioning of the engine, the coolant temperature must be between the 4th and 7th lit segment, as indicated by the instrument «D» on the digital instrument panel. When the 9th segment lights up, the icon and all the segments start flashing; stop the engine, let it cool down and check the fluid level; if the level is OK, contact an **Authorised Service Centre**.

Check coolant when the engine is cold as indicated in the scheduled maintenance table.

- a) Rest the vehicle in vertical position on the stand and remove the screw of the expansion tank cap shown in the photo
- b) Remove the expansion tank cover "A", turning in anticlockwise direction.
- c) Look inside the expansion tank; the fluid level must always be between the min and the max level
- d) If the coolant level is near the minimum mark, top up when the engine is cold.



03\_11



03\_12

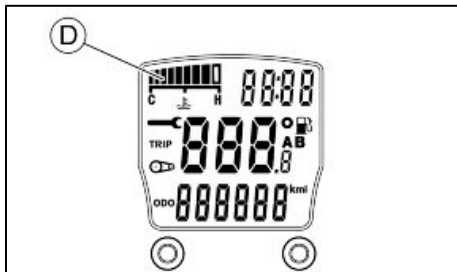

03\_13

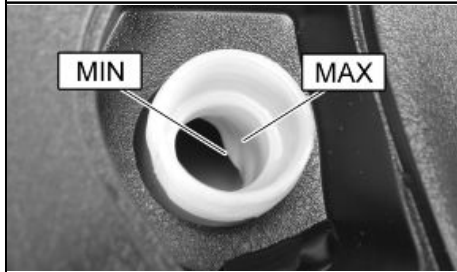

03\_14

If it is necessary to top up the coolant frequently, or if the expansion tank is completely dry, you should look for the cause in the cooling system. It is therefore essential to have the cooling system checked at an **Authorised Service Centre**. Replace coolant as indicated in the scheduled maintenance table. Take your vehicle to an **Authorised Service Centre** for this operation.

#### CAUTION



**THE RECOMMENDED COOLANT MUST BE USED FOR TOP-UPS TO AVOID DAMAGING THE ENGINE.**

#### N.B.

**SHOULD THE 9th SEGMENT OF THE COOLANT TEMPERATURE INDICATOR COME ON DURING A NON-DEMANDING RIDE, SHUT OFF THE ENGINE AND LET IT COOL DOWN. THEN CHECK THE COOLANT LEVEL; IF THE LEVEL IS OK, CONTACT AN AUTHORISED SERVICE CENTRE.**

#### WARNING



**IN ORDER TO AVOID BURNS, DO NOT UNSCREW THE EXPANSION TANK CAP WHILE THE ENGINE IS STILL HOT.**

#### WARNING



**IN ORDER TO AVOID HARMFUL FLUID LEAKS WHILE RIDING, IT IS IMPORTANT TO MAKE SURE THAT THE LEVEL NEVER EXCEEDS THE MAXIMUM VALUE.**

**IN ORDER TO GUARANTEE THE PROPER FUNCTION OF THE ENGINE, IT IS NECESSARY TO KEEP THE RADIATOR GRILLE CLEAN.**

## Recommended products

### **SPECIAL AGIP PERMANENT fluid**

*coolant*

Monoethylene glycol-based antifreeze fluid, CUNA NC 956-16

### **Checking the brake oil level (03\_15)**

The front and rear brake fluid reservoirs are both positioned on the handlebars. Proceed as follows:

1. Place the scooter on its centre stand and make sure the handlebar is centred;
2. Check the fluid through the specific sight glass «**C**».

A certain lowering of the level is caused by wear on the pads. Should the level appear to be below the minimum mark, please contact an **Authorised Service Centre or Dealer** in order to have braking system thoroughly checked.



03\_15

### **Braking system fluid top up (03\_16)**

Proceed as follows:

Undo the screws «**B**» and remove the fuel tank cap «**A**». Top-up using only the fluid specified, without exceeding the maximum level.

This procedure applies to the rear brake pump top-up operation; follow the same procedure for the front brake pump.

Under standard climatic conditions, replace fluid as indicated in the scheduled maintenance table.

This operation must be carried out by trained personnel; take your vehicle to an **authorised Service centre or Dealer**.

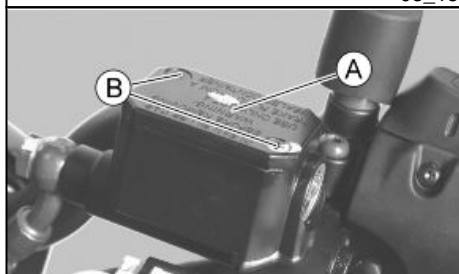

03\_16

**WARNING**

**ONLY USE DOT 4 CLASS BRAKE FLUIDS. COOLING SYSTEM FLUIDS ARE HIGHLY CORROSIVE. MAKE SURE THAT IT DOES NOT COME INTO CONTACT WITH THE PAINTWORK**

**CAUTION**

**AVOID CONTACT OF BRAKE FLUID WITH EYES, SKIN, AND CLOTHING. IN CASE OF CONTACT, RINSE WITH WATER. THE BRAKING CIRCUIT FLUID IS HYGROSCOPIC, THAT IS, IT ABSORBS HUMIDITY FROM THE SURROUNDING AIR. IF THE HUMIDITY IN THE BRAKING FLUID EXCEEDS A CERTAIN VALUE, IT WILL LEAD TO INEFFICIENT BRAKING. NEVER USE BRAKING FLUID KEPT IN CONTAINERS THAT HAVE ALREADY BEEN OPENED, OR PARTIALLY USED.**

**Recommended products****AGIP BRAKE 4**

*Brake fluid*

FMVSS DOT 4 Synthetic fluid



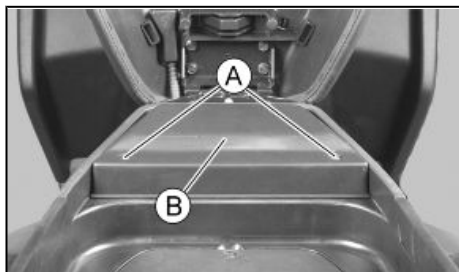

03\_17

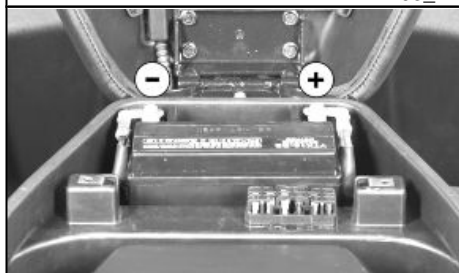

03\_18

## Battery (03\_17)

To access the battery, proceed as follows:

1. Place the scooter on its centre stand;
2. Open the saddle, following the previously described procedure;
3. Remove the two fasteners "A" and the cover "B".

### WARNING



**IN ORDER TO AVOID DAMAGING THE ELECTRICAL SYSTEM, NEVER DISCONNECT THE WIRING WHILE THE ENGINE IS RUNNING.**

## Use of a new battery (03\_18)

Make sure that the terminals are connected correctly.

### CAUTION



**DO NOT REVERSE THE POLARITY: RISK OF SHORT CIRCUIT AND DAMAGE TO THE ELECTRICAL SYSTEM.**

### WARNING



**SPENT BATTERIES ARE HARMFUL FOR THE ENVIRONMENT. COLLECTION AND DISPOSAL SHOULD BE CARRIED OUT IN COMPLIANCE WITH CURRENT REGULATIONS.**

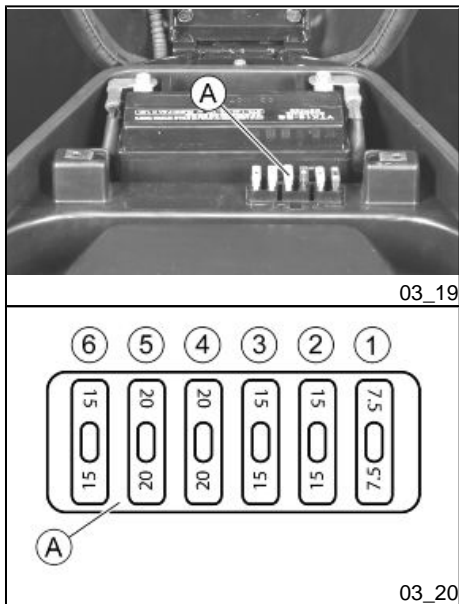

## Long periods of inactivity

If the vehicle has not been used for long periods, it is necessary to periodically recharge the battery, bearing in mind that the battery tends to go completely flat within around three months. The battery must be recharged with a current load equal to 1/10 of the battery rated capacity (~ 1A ), for a period not longer than 8 hours. For this operation contact an **Authorised Service Centre**. When refitting a removed battery, make sure that all terminals are properly connected.

## Fuses (03\_19, 03\_20, 03\_21, 03\_22, 03\_23)

The electrical system has twelve fuses divided into two fuse boxes to protect the different installation circuits. One of them is inside the battery compartment «A» and the other is at the internal side of the right footrest «B». To have access, loosen the screw «C» and remove the plastic cover. The chart shows the position and characteristics of the fuses in the vehicle.

### CAUTION



**BEFORE REPLACING THE BLOWN FUSE, FIND AND SOLVE THE FAILURE THAT CAUSED IT TO BLOW. NEVER TRY TO REPLACE THE FUSE WITH ANY OTHER MATERIAL (E.G., A PIECE OF ELECTRIC WIRE).**



03\_21



03\_22

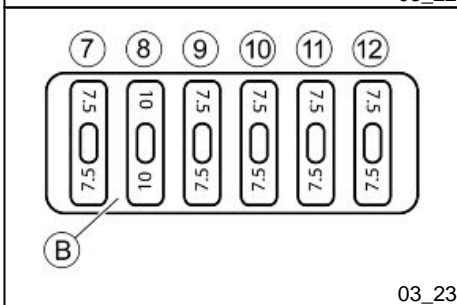

03\_23

## FUSE TABLE

Fuse No. 1	<b>Capacity: 7.5 A</b> <b>Protected circuits:</b> Injection ECU battery power
Fuse No. 2	<b>Capacity: 15 A</b> <b>Protected circuits:</b> Battery- powered injection loads, electrical fan
Fuse No. 3	<b>Capacity: 15 A</b> <b>Protected circuits:</b> Battery- powered saddle opening switch, glove-box lighting, light switch, turn indicator switch, antitheft installation, fuse No. 12
Fuse No. 4	<b>Capacity: 20A</b> <b>Protected circuits:</b> battery- powered ECU for parking control
Fuse No. 5	<b>Capacity: 20A</b> <b>Protected circuits:</b> battery- powered fuse No. 7, live fuses No. 8 - No. 9 - No.10 - No.11
Fuse No. 6	<b>Capacity: 15 A</b> <b>Protected circuits:</b> L.V. socket.
Fuse No. 7	<b>Capacity: 7.5 A</b>

	<b>Protected circuits:</b> Battery-powered instrument panel
Fuse No. 8	<b>Capacity: 10A</b> <b>Protected circuits:</b> Live stop, start-up and start-up enabling switch and start-up circuit.
Fuse No. 9	<b>Capacity: 7.5 A</b> <b>Protected circuits:</b> live passing and horn
Fuse No. 10	<b>Capacity: 7.5A</b> <b>Protected circuits:</b> Live injection ECU, immobilizer aerial, electric fan remote control, injection loads remote control
Fuse No. 11	<b>Capacity: 7.5A</b> <b>Protected circuits:</b> Live ECU parking lever, antitheft installation, instrument panel, headlight remote control, horn
Fuse No. 12	<b>Capacity: 7.5A</b> <b>Protected circuits:</b> Live turn indicator control, saddle opening switch, tail lights, panel lighting

### LIGHT BULBS TABLE

Low-beam bulb	<b>Type:</b> HALOGEN (H8) <b>Power:</b> 12V - 35W <b>Quantity:</b> 1 RHS + 1 LHS
High-beam light bulb	<b>Type:</b> HALOGEN (H8) <b>Power:</b> 12V - 35W <b>Quantity:</b> 1 RHS + 1 LHS
Helmet compartment light bulb	<b>Type:</b> FESTOON BULB <b>Power:</b> 12V - 5W <b>Quantity:</b> 1
Rear turn indicator light bulb	<b>Type:</b> WITH BULB <b>Power:</b> 12V - 10W <b>Quantity:</b> 1 RHS + 1 LHS
Rear tail light bulb	<b>Type:</b> WITH BULB <b>Power:</b> 12V - 5W <b>Quantity:</b> 1 RHS + 1 LHS
Stop light bulb	<b>Type:</b> WITH BULB <b>Power:</b> 12V - 10W <b>Quantity:</b> 1 RHS + 1 LHS
License plate light bulb	<b>Type:</b> ALL GLASS

	<b>Power:</b> 12V - 5W <b>Quantity:</b> 1
Front turn indicator bulb	<b>Type:</b> WITH BULB <b>Power:</b> 12V - 10W <b>Quantity:</b> 1 RHS + 1 LHS
Front tail light bulb	<b>Type:</b> ALL GLASS <b>Power:</b> 12V - 5W <b>Quantity:</b> 1
Instrument panel bulb	<b>Type:</b> ALL GLASS <b>Power:</b> 12V - 2W <b>Quantity:</b> 4



### Front light group (03\_24, 03\_25, 03\_26, 03\_27, 03\_28, 03\_29)

To access the tail light bulb:

- Insert a screwdriver in the notch on the side (see picture) of the Gilera emblem and remove it.
- Undo the screw «**A**» and the four screws «**B**».
- Push the two indicated tongues to unlock the tail lights and remove the rubber bulb holder

To replace it, slide off the bulb from the bulb holder and insert a new bulb.

To access the high-beam light bulbs and the low-beam light bulbs:

- Actuating on the inside of the front wheel housing, hold the high-beam light bulb holder «**C**» or the low-beam bulb holder «**D**» and then turn it anticlockwise.

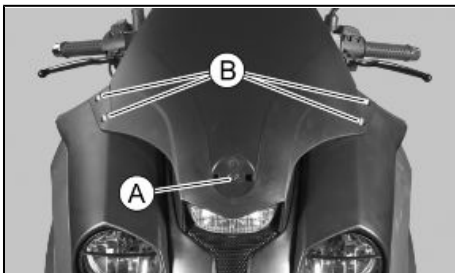

03\_25

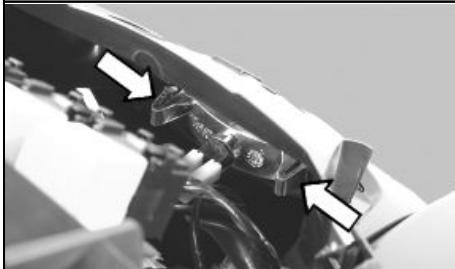

03\_26



03\_27

To replace it, disconnect the connector and insert a new bulb

#### WARNING



**HIGH AND LOW BEAM LIGHT ARE OF THE HALOGEN TYPE: DO NOT TOUCH WITH YOUR FINGERS TO AVOID DAMAGING THEIR FUNCTION.**

#### Headlight adjustment (03\_30, 03\_31, 03\_32, 03\_33, 03\_34)

Proceed as follows:

- Position the unloaded vehicle, in running order and with the tyres inflated to the prescribed pressure, onto a flat surface 10 m away from a half-lit white screen; make sure the vehicle axis is perpendicular to the screen.
- Remove the headlight assembly central cover.
- Turn on the headlight and check that the borderline of the projected light beam should be lower than 9/10 of the distance from the ground to the centre of the vehicle's headlight, and higher than 7/10.
- Otherwise, adjust the headlight.

#### N.B.

**THE ABOVE PROCEDURE COMPLIES WITH THE EUROPEAN STANDARDS REGARDING MAXIMUM AND MINIMUM HEIGHT OF LIGHT BEAMS. REFER TO THE STATUTORY REGULATIONS IN FORCE IN EVERY COUNTRY WHERE THE vehicle IS USED.**

To access the headlight adjusting screws:

- Unscrew the four screws «A» (two on each side) and remove the front cowl.
- Unscrew the five screws «B» and remove the side cover.

Each bulb has two light beam adjusting screws, one for horizontal adjustment «C» and one for the vertical adjustment «D». Adjust each headlamp at a time. In order to



do that, remove the connector from the other bulbs so that you can adjust one headlamp at a time.

**N.B.**

**THE HEADLAMPS CAN ONLY BE LIT WHEN THE ENGINE IS ON. ADJUST THE LIGHT BEAM IN A WELL VENTILATED PLACE.**



03\_28

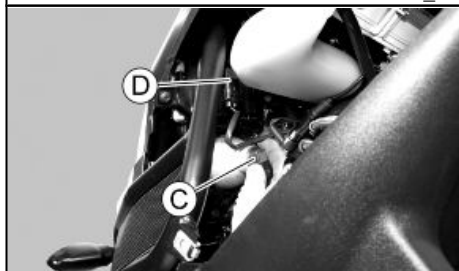

03\_29

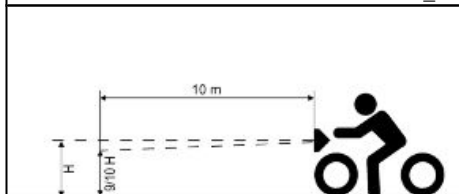

03\_30

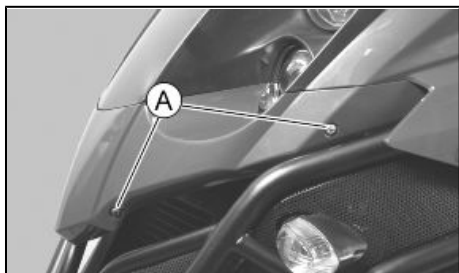

03\_31

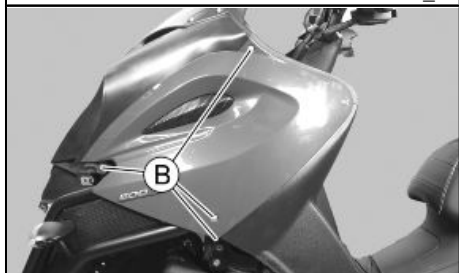

03\_32

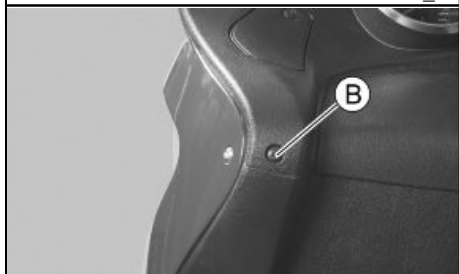

03\_33

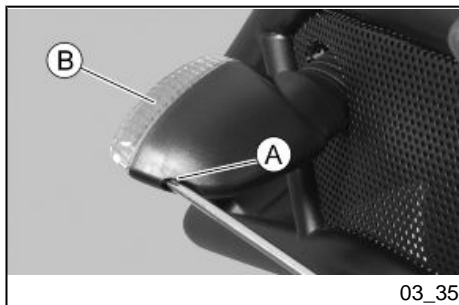
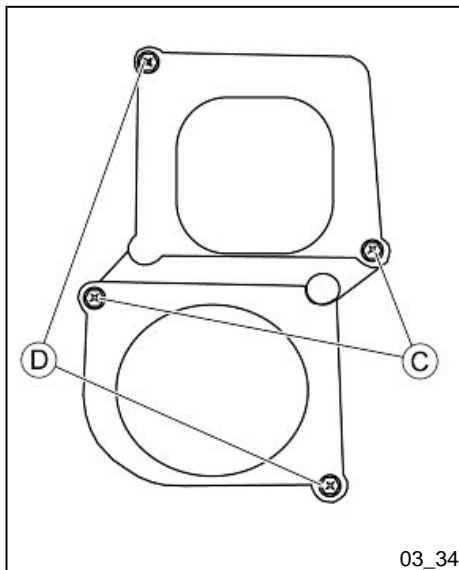

### Front direction indicators (03\_35)

To access the bulb, undo the screw «A» and remove the glass «B».

To replace the bulb, hold it and then turn it clockwise.

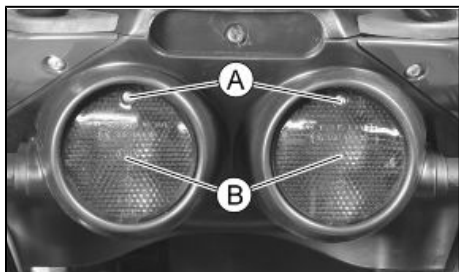

03\_36

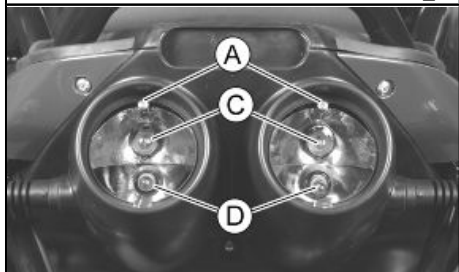

03\_37

### Rear optical unit (03\_36, 03\_37)

To access the rear light unit bulbs, undo the screw «A» and remove the glass «B». Now tighten the screw «A» in its seat.

To replace the stop light bulb «C», hold it and turn it anticlockwise.

To replace the rear tail light bulb «D», hold it and pull it outwards.

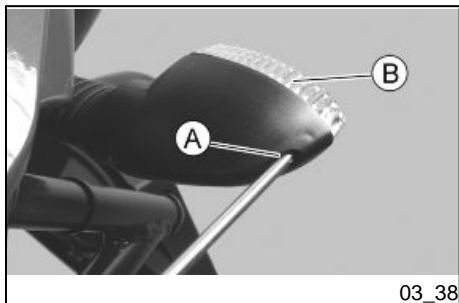

03\_38

### Rear turn indicators (03\_38)

To access the bulb, undo the screw «A» and remove the glass «B».

To replace the bulb, hold it and then turn it clockwise.

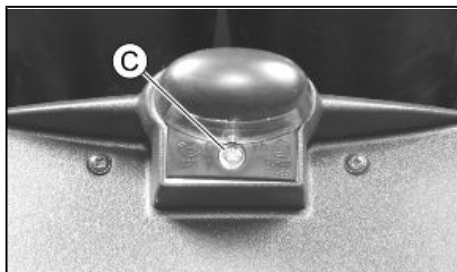

03\_39

### Number plate light (03\_39)

Remove the screw «C», then take out the bulb holder.

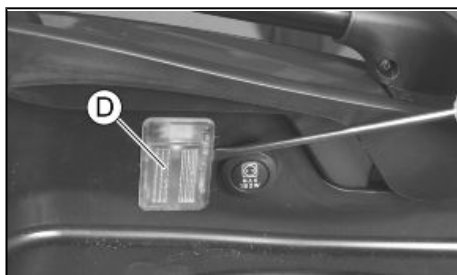

03\_40

### Helmet compartment lighting bulb (03\_40)

Open the rear boot and insert a small plain slot screwdriver in the lateral notch to detach the snap-on glass "D", then replace the bulb.

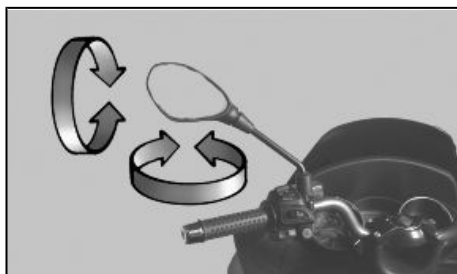

03\_41

### Rear-view mirrors (03\_41)

The mirrors can be set to the desired position by adjusting the mirror frame.

## Front and rear disc brake

The brake disc and pad wear is automatically compensated, therefore it has no effect on the functioning of the front and rear brakes. For this reason it is not necessary to adjust the brakes. An excessively elastic brake lever stroke may indicate the presence of air in the braking circuit or a failure in the braking system. In this case, mainly due to the importance of brakes to guarantee safe riding conditions, the vehicle should be taken to an **Authorised Service Centre or Dealer**.

### CAUTION



**THE BRAKING ACTION SHOULD BEGIN AFTER ABOUT 1/3 OF THE BRAKE LEVER STROKE.**

### CAUTION



**HAVE THE BRAKE PADS CHECKED BY THE DEALER ACCORDING TO THE CHECKS SPECIFIED IN THE SCHEDULED MAINTENANCE TABLE. HOWEVER, IN THE EVENT OF NOISES COMING FROM THE FRONT AND/OR REAR BRAKE SYSTEM DURING OPERATION, IT IS ADVISABLE TO HAVE THE BRAKE SYSTEM CHECKED BY A PIAGGIO DEALER OR AUTHORISED SERVICE CENTRE. AFTER REPLACING THE BRAKE PADS, DO NOT USE THE SCOOTER UNTIL YOU HAVE OPERATED THE BRAKE LEVER SEVERAL TIMES IN ORDER TO ALLOW THE PLUNGERS TO SETTLE AND THE LEVER STROKE TO BE SET TO THE CORRECT POSITION.**

### CAUTION



**THE PRESENCE OF SAND, MUD, SNOW MIXED WITH SALT, ETC. ON THE ROAD, CAN DRASTICALLY REDUCE THE DURATION OF THE BRAKE PADS. IN**

**ORDER TO AVOID THIS, WE RECOMMEND WASHING THE VEHICLE FREQUENTLY WHEN RIDING IN THESE ROAD CONDITIONS.**

## **Puncture**

The vehicle is equipped with tubeless tyres (without inner tube). In the event of a puncture, contrary to the situation with a tyre with inner tube, the tyre deflates more slowly, resulting in a greater steering safety. In the event of a puncture, it is admissible to make an emergency repair using an "inflate and repair" spray can. For a final repair, take your vehicle to an **Authorised Service Centre or Dealer**. The replacement of a tyre involves removing the wheel in question. Take your vehicle to an **Authorised Service Centre or Dealer** for these operations.

### **CAUTION**



**TO USE THE "INFLATE AND REPAIR" SPRAY PROPERLY FOLLOW THE INSTRUCTIONS ON THE PACKAGING.**

### **WARNING**



**THE WHEELS FITTED WITH TYRES SHOULD ALWAYS BE BALANCED. RIDING THE VEHICLE WITH VERY LOW TYRE PRESSURE OR WITH INCORRECTLY BALANCED TYRES CAN LEAD TO DANGEROUS STEERING VIBRATIONS.**

## **Periods of inactivity**

We recommend carrying out the following operations:

1. Clean the scooter thoroughly and then cover it with a canvas;

2. Be careful to rest the vehicle on its centre stand disabling the front suspension locking system;
3. With engine off and piston at the bottom dead centre, remove the spark plug, add 1÷2 cc of oil through the opening (adding more oil may damage the engine). Operate the starter button 1-2 times for roughly 1 second to turn the engine over slowly, then insert the spark plug again;
4. Empty all fuel; spread antirust grease on the unpainted metal parts; keep the wheels lifted above the ground by resting the chassis on two wooden wedges;
5. For the battery, follow the procedures described in the «Battery» section.

### **Recommended products**

#### **AGIP CITY HI TEC 4T**

##### *Engine oil*

SAE 5W-40, API SL, ACEA A3, JASO MA Synthetic oil

### **Cleaning the vehicle**

In order to soften the dirt and mud deposited on the painted surfaces, use a low pressure jet of water. Once softened, mud and dirt must be removed with a soft sponge for bodywork soaked in lots of water and "shampoo" (2-4% of car shampoo in water). Then rinse abundantly with water, and dry with a shammy cloth. For the outside of the engine, use petroleum, a brush and clean cloths. Petroleum can damage paintwork. Remember that any polishing with silicone wax must always be preceded by washing

#### **CAUTION**



**DETERGENTS CAN POLLUTE WATER. THE VEHICLE MUST BE WASHED AT A WASH STATION EQUIPPED WITH A SPECIAL WATER PURIFICATION SYSTEM.**



**CAUTION**

**PER IL LAVAGGIO DEL MOTORE E DEL VEICOLO É SCONSIGLIATO L'UTILIZZO DELL'IDROPULITRICE; NEL CASO CHE NON SIA POSSIBILE EFFETTUARE TALE OPERAZIONE IN UN ALTRO MODO, É NECESSARIO:**

- **USARE SOLAMENTE IL GETTO A VENTAGLIO.**
- **NON AVVICINARE LA LANCIA A MENO DI 2 FT (60 CM).**
- **NON USARE ACQUA A TEMPERATURE SUPERIORI A 100° F (40°C).**
- **NON UTILIZZARE IL GETTO AD ALTA PRESSIONE.**
- **NON UTILIZZARE IL LAVAGGIO A VAPORE.**
- **NON INDIRIZZARE IL GETTO DIRETTAMENTE VERSO: IL MOTORE, I CABLAGGI ELETTRICI, LE FERITOIE DI RAFFREDDAMENTO DEL COPERCHIO TRASMISSIONE E DEL COPERCHIO CHIOCCIOLA.**

**CAUTION**

**NEVER WASH THE SCOOTER IN DIRECT SUNLIGHT, ESPECIALLY IN SUMMER WHEN THE BODYWORK IS STILL HOT AS THE SHAMPOO COULD DAMAGE THE PAINTWORK IF IT DRIES BEFORE BEING RINSED OFF. NEVER USE CLOTHS SOAKED IN ALCOHOL, PETROL, DIESEL OIL OR KEROSENE FOR CLEANING THE PAINTED OR PLASTIC SURFACES, IN ORDER NOT TO DAMAGE THE LUSTRE FINISH OR ALTER THE MECHANICAL PROPERTIES. USING SILICONE-BASED WAX CAN DAMAGE THE PAINTED SURFACES, DEPENDING ON THE VEHICLE COLOUR (SATIN COLOURS). FOR FURTHER INFORMATION ON THIS MATTER, CONTACT AN AUTHORISED SERVICE CENTRE .**

## **STARTING FAILURE**

Emergency switch in «OFF»	Set the switch back to « <b>ON</b> »
Fuse blown	Replace the blown fuse and have the vehicle checked by an <b>Authorised Service Centre.</b>

## **IGNITION PROBLEM**

Faulty spark plug	Contact an <b>Authorised Service Centre.</b>
Faulty ignition / injection control unit.	Contact an <b>Authorised Service Centre.</b>
Faulty coil. Due to the presence of high voltage, this check should only be carried out by an expert.	Contact an <b>Authorised Service Centre.</b>

## **LACK OF COMPRESSION**

Loosen spark plug.	Screw in the spark plug tightly
Cylinder head loose, piston gas rings worn.	Contact an <b>Authorised Service Centre.</b>
Valve stuck	Contact an <b>Authorised Service Centre.</b>

## **HIGH CONSUMPTION AND LOW PERFORMANCE**

Air filter blocked or dirty.	Clean with water and shampoo and impregnate with petrol and specific oil (section «Removing the air filter»)
------------------------------	--

## **INSUFFICIENT BRAKING**

Greasy disc. Worn pads. Faulty braking system. Presence of air in the front and rear brake circuit.	Contact an <b>Authorised Service Centre</b> .
---	---

## **INEFFICIENT SUSPENSIONS**

Shock absorber fault, oil leak, end buffer damaged; shock absorber preloading incorrectly set	Contact an <b>Authorised Service Centre</b> .
---	---

## **IRREGULAR AUTOMATIC TRANSMISSION**

Variator rollers and/or driving belt damaged	Contact an <b>Authorised Service Centre</b> .
--	---

## **STAND DOES NOT RETURN TO POSITION**

Presence of dirt	Clean and grease
------------------	------------------



# Fuoco 500ie



**GILERA®**



**Chap. 04**  
**Technical data**

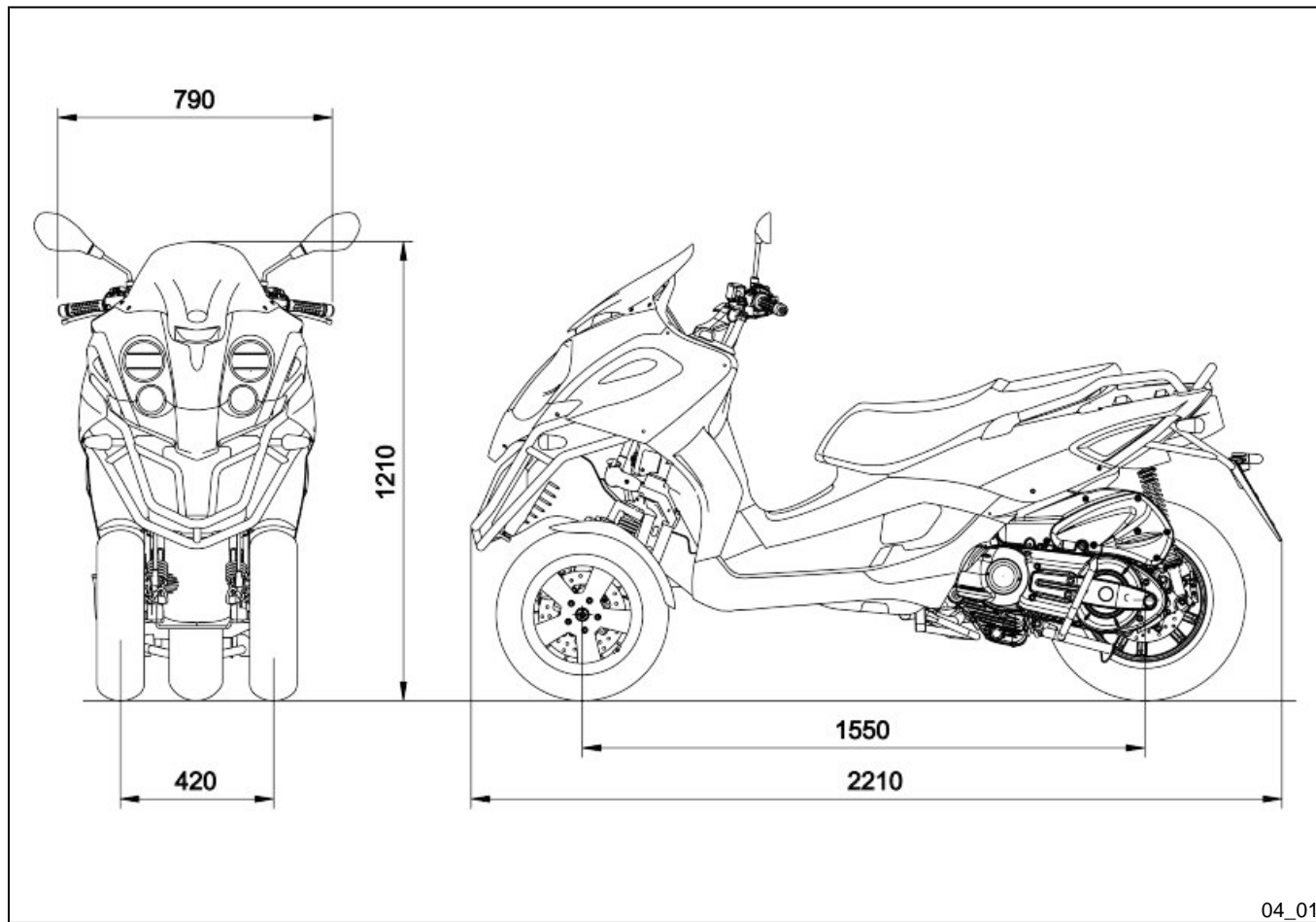

**ENGINE TECHNICAL DATA**

Type	Single-cylinder, 4-stroke
Cubic capacity	493 cm <sup>3</sup>
Bore x Stroke	94 x 71 mm
Compression ratio	10.5 ± 0.5 : 1
Engine idle speed	1,500 ± 100 rpm
Timing system	Four valves, single overhead camshaft, chain driven.
Valve clearance	Inlet: 0.15 mm Outlet: 0.15 mm
MAX. power	29.5 kW at 7,250 rpm
MAX Power for crossover version	25 kW
MAX torque	46.5 Nm at 5.250 rpm
Transmission	Automatic expandable pulley variator with torque server, V belt, dry self-ventilating automatic centrifugal clutch and transmission housing with forced air circulation.
Final reduction	Gear reduction unit in oil bath.
Lubrication	Engine lubrication with lobe pump (inside crankcase) controlled by a chain with double filter: mesh and paper.
Cooling	Forced coolant circulation system.
Start-up	Electric

Ignition	Highly efficient electronic inductive ignition, integrated with the injection system, with variable advance, separate HV coil and double spark plug.
Ignition advance	Three-dimensional map managed by control unit
Spark plug	NGK CR7EKB
Alternative spark plug	-
Fuel supply	Electronic injection with electric fuel pump.
Fuel	Unleaded petrol (95 RON)
exhaust muffler	Absorption-type exhaust muffler with catalytic converter and lambda probe.
Emission regulations	EURO 3

### **VEHICLE TECHNICAL DATA**

Chassis	Tubular and sheet steel
Front suspension	The tilt mechanism is composed of an articulated parallelogram suspension with die-cast aluminium control arms and two side headstocks plus shock absorbers with hydraulic locking system.
Rear suspension	Two double-acting shock absorbers, adjustable to four positions at preloading.



Front brake	Ø 240 mm double disk with hydraulic control activated by the handlebar right-hand lever.
Rear brake	disc brake, diameter 240 mm, with hydraulic servo operated from the handlebar with the left-hand lever.
Wheel rim type	Light alloy rims.
Front rim	12" x 3.00
Rear rim	14" x 4.50
Front tyre	Tubeless 120/70-12" 51S or 51P
Rear tyre	Tubeless 140/70 - 14" 68S or 68P reinf
Front tyre pressure (with passenger)	1.6 bar (1.8 bar)
Rear tyre pressure (with passenger)	2.4 bar (2.6 bar)
Kerb weight	253 ± 5 kg
Maximum weight allowed	445 kg
Battery	12 V / 14 Ah, SEALED BATTERY

### **CAPACITY**

Engine oil	1.7 l
Transmission oil	250 cm <sup>3</sup>
Cooling system fluid	~ 2 l
Fuel tank (reserve)	~ 12 l (~2 l)

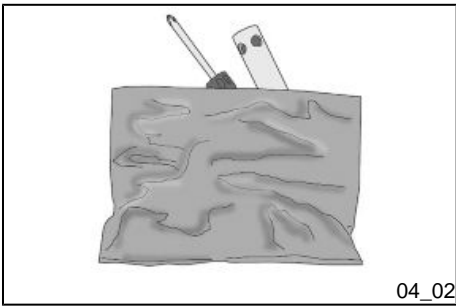

## Kit equipment (04\_02)

The toolkit comprises:

- One box-spanner.
- One twin screwdriver
- One special spanner for adjusting the rear shock absorbers
- One plastic clip for removing the fuses.

The tools are stored in the helmet compartment.

# Fuoco 500ie



**GILERA®**



**Chap. 05**  
**Spare parts and**  
**accessories**



05\_01

## Warnings (05\_01)

### WARNING



TO PREVENT ACCIDENTS AND TO GUARANTEE PROPER STABILITY, PERFORMANCE AND SAFETY, RIDE THE VEHICLE VERY CAREFULLY WHEN IT IS FITTED WITH ACCESSORIES OR WITH UNUSUAL LOADS.

### WARNING



IT IS ALSO RECOMMENDED THAT "ORIGINAL PIAGGIO SPARE PARTS" BE USED, AS THESE ARE THE ONLY ONES OFFERING YOU THE SAME QUALITY GUARANTEE AS THOSE INITIALLY FITTED ON THE SCOOTER. THE USE OF NON-ORIGINAL SPARE PARTS RENDERS THE WARRANTY VOID.

### WARNING



PIAGGIO MARKETS ITS OWN LINE OF ACCESSORIES THAT ARE RECOGNISED AND GUARANTEED FOR USE. IT IS THEREFORE ESSENTIAL, IN ORDER TO CHOOSE AND MOUNT THE ACCESSORIES CORRECTLY, TO CONTACT AN AUTHORISED DEALER OR SERVICE CENTRE. THE USE OF NON-ORIGINAL ACCESSORIES MAY AFFECT THE STABILITY AND OPERATION OF YOUR VEHICLE AND REDUCE SAFETY LEVELS WITH POTENTIAL RISKS FOR THE RIDER.

### WARNING



NEVER RIDE THE VEHICLE WITH ADDED ACCESSORIES (CASE AND/OR WINDSHIELD) FASTER THAN 120 KM/H. WITHOUT THESE ACCESSORIES THE VEHICLE MAY BE DRIVEN AT A HIGHER SPEED WITHIN THE LEGAL LIMITS. IF

**THERE ARE NOT-PIAGGO ACCESSORIES FITTED, OR AN ABNORMAL LOAD, OR IF THE VEHICLE IS NOT IN A GENERALLY GOOD CONDITION, OR WHENEVER WEATHER CONDITIONS DEMAND IT, SPEED SHOULD BE FURTHER REDUCED.**

**WARNING**



**BE EXTREMELY CAREFUL WHEN INSTALLING AND REMOVING THE MECHANICAL ANTITHEFT DEVICE ON THE VEHICLE (U-SHAPED PADLOCK, DISC BLOCK, ETC.).**

**MAINLY DUE TO THE PROXIMITY TO THE BRAKE PIPES, TRANSMISSIONS AND/OR ELECTRIC CABLES, AN INCORRECT INSTALLATION OR REMOVAL OF THE ANTITHEFT DEVICE AS WELL AS LEAVING IT ON BEFORE STARTING THE VEHICLE CAN SERIOUSLY DAMAGE ITS COMPONENTS AND AFFECT THE CORRECT FUNCTIONING OF THE VEHICLE AND HARM THE USER.**



# Fuoco 500ie



**GILERA®**



**Chap. 06  
Programmed  
maintenance**

## Scheduled maintenance table

Adequate maintenance is fundamental to ensuring long-lasting, optimum operation and performance of your vehicle.

To this end, a series of checks and maintenance operations (at the owner's expense) have been suggested, which are included in the summary table on the following page. Any minor faults should be reported without delay to an **Authorised Service Centre or Dealer** without waiting until the next scheduled service to solve it.

All scheduled maintenance services must be carried out at the specified times, even if the stated mileage has not yet been reached. Carrying out scheduled services on time is necessary to ensure your warranty remains valid. For any further information concerning Warranty procedures and "Scheduled Maintenance", please refer to the "Warranty Booklet".

### EVERY 2 YEARS

Coolant - change
------------------

Brake fluid - change
----------------------

Parking control unit software upgrading (if available)
--

### AFTER 1,000 KM

Safety locks - check
----------------------

Throttle lever - adjustment
-----------------------------

Engine oil - change
---------------------

Electrical system and battery - check
---------------------------------------

Coolant level - check
-----------------------

Brake fluid level - check
---------------------------



Engine oil - replacement

Brake pads - check condition and wear

Tyre pressure and wear - check

Vehicle and brake test - road test

Hub oil - change

Steering - Check

Parking control unit software upgrading (if available)

**AFTER 5,000 KM; 25,000 KM; 35,000 KM; 55,000 KM;  
65,000 KM**

Engine oil - level check/ top-up

Brake pads - check condition and wear

Centre stand - lubrication

Parking control unit software upgrading (if available)

**AFTER 10,000 KM; 50,000 KM; 70,000 KM**

Safety locks - check

Driving belt - replacement

Throttle lever - adjustment

Air filter - clean

Engine oil - change

Electrical system and battery - check

Coolant level - check

Brake fluid level - check

Engine oil - replacement

Brake pads - check condition and wear

Sliding block / variable speed rollers - change

Tyre pressure and wear - check

Vehicle and brake test - road test

Hub oil - check

Suspensions - check

Steering - Check

Centre stand - lubrication

Spark plugs - replacement

Tilt locking gripper control cable - adjustment

Parking control unit software upgrading (if available)

### **AFTER 15,000 KM; 45,000 KM; 75,000 KM**

Engine oil - level check/ top-up

Brake pads - check condition and wear

Centre stand - lubrication

Parking control unit software upgrading (if available)

## **AFTER 20,000 KM; 40,000 KM; 60,000 KM AND 80,000 KM**

Spark plugs - replacement
Driving belt - replacement
Throttle lever - adjustment
Air filter - check
Engine oil - change
Valve clearance - check
Electrical system and battery - check
Coolant level - check
Engine oil - replacement
Brake pads - check condition and wear
Sliding block / variable speed rollers - change
Tyre pressure and wear - check
Vehicle and brake test - road test
Hub oil - change
Suspensions - check
Steering - Check
Centre stand - lubrication
Brake fluid level - check
Tilt locking gripper control cable - adjustment
Parking control unit software upgrading (if available)

## **30,000 KM**

Safety locks - check

Driving Belt - replacement

Throttle lever - adjustment

Air filter - clean

Engine oil - change

Electrical system and battery - check

Coolant level - check

Brake fluid level - check

Engine oil - replacement

Hub oil - check

Brake pads - check condition and wear

Sliding block / variable speed rollers - change

Tyre pressure and wear - check

Vehicle and brake test - road test

Suspensions - check

Steering - Check

Centre stand - lubrication

Spark plugs - replacement

Tilt locking gripper control cable - adjustment

Parking control unit software upgrading (if available)

**RECOMMENDED PRODUCTS TABLE**

<b>Product</b>	<b>Description</b>	<b>Specifications</b>
AGIP ROTRA 80W-90	Rear hub oil	SAE 80W/90 Oil that exceeds the requirements of API GL3 specifications
AGIP GP 330	Grease for brake control levers, throttle, stand	White calcium complex soap-based spray grease with NLGI 2; ISO-L-XBCIB2
AGIP CITY HI TEC 4T	Oil to lubricate flexible transmissions (throttle control)	Oil for 4-stroke engines
AGIP BRAKE 4	Brake fluid	FMVSS DOT 4 Synthetic fluid
SPECIAL AGIP PERMANENT fluid	coolant	Monoethylene glycol-based antifreeze fluid, CUNA NC 956-16
AGIP FILTER OIL	Oil for air filter sponge	Mineral oil with specific additives for increased adhesiveness
AUTOSOL METAL POLISH	Muffler cleaning paste	Specific product for cleaning and polishing stainless steel mufflers.
AGIP CITY HI TEC 4T	Engine oil	SAE 5W-40, API SL, ACEA A3, JASO MA Synthetic oil
AGIP GREASE SM 2	Grease for the tone wheel revolving ring	Soap-based lithium grease containing NLGI 2 Molybdenum disulphide; ISO-L-XBCHB2, DIN KF2K-20
AGIP GREASE PV2	Grease for the steering bearings, pin seats and swinging arm	White anhydrous-calcium based grease to protect roller bearings; temperature range between -20 C and +120 C; NLGI 2; ISO-L-XBCIB2.



# TABLE OF CONTENTS

## **A**

Air filter: 52

## **B**

Battery: 57

Brake: 55, 70

## **C**

Clock: 12

## **D**

Disc brake: 70

Display: 12

## **E**

Engine oil: 46, 47

Engine stop: 17

## **F**

Fuel: 23

Fuses: 58

## **H**

Headlight: 64

Horn: 16

Hub oil: 48

## **I**

Identification: 26

Immobilizer: 18, 20

Instrument panel: 11

## **K**

Key switch: 14

Keys: 18

## **L**

Light switch: 16

## **M**

Maintenance: 13, 45, 87, 88

Mirrors: 69

## **S**

Saddle: 21, 24, 25

Scheduled maintenance: 88

Shock absorbers: 31

Spark plug: 51

Stand: 37

Start-up: 17

## **T**

Tank: 23

Technical Data: 77

Transmission: 37

Turn indicators: 68

Tyre pressure: 30

Tyres: 50



The descriptions and illustrations given in this publication are not binding. While the basic features as described and illustrated in this manual remain unchanged, PIAGGIO - GILERA reserves the right, at any time and without being required to update this publication beforehand, to make any changes to components, parts or accessory supplies, which it considers necessary to improve the product or which are required for manufacturing or construction reasons.

Not all versions shown in this publication are available in all Countries. The availability of individual versions should be confirmed with the official Piaggio sales network.

"© Copyright 2007 - PIAGGIO & C. S.p.A. Pontedera. All rights reserved. Reproduction of this publication in whole or in part is prohibited."

PIAGGIO & C. S.p.A. - After-Sales

V.le Rinaldo Piaggio, 23 - 56025 PONTEDERA (Pi)