

Official

HONDA

SHOP MANUAL

C70

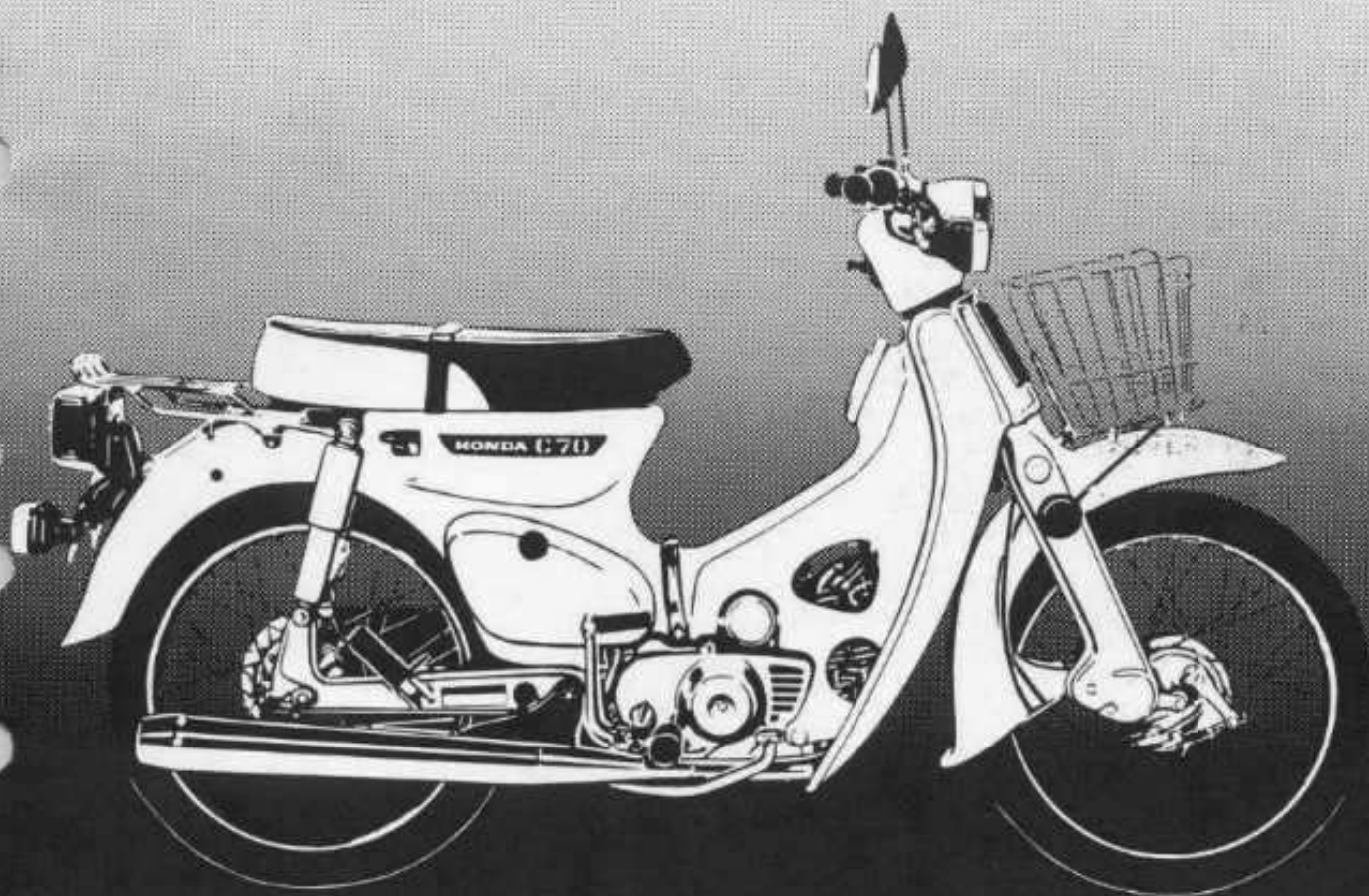

'80 ~ '82

IMPORTANT SAFETY NOTICE

 **WARNING** *Indicates a strong possibility of severe personal injury or loss of life if instructions are not followed.*

CAUTION: *Indicates a possibility of personal injury or equipment damage if instructions are not followed.*

Detailed descriptions of standard workshop procedures, safety principles, and service operations are not included. It is important to note that this manual contains *some* warnings and cautions against *some* specific service methods which could cause **PERSONAL INJURY** to service personnel or could damage a vehicle or render it unsafe. Please understand that those warnings could not cover all conceivable ways in which service, whether or not recommended by Honda might be done or of the possible hazardous consequences of each conceivable way, nor could Honda investigate all such ways. Anyone using service procedures or tools, whether or not recommended by HONDA *must satisfy himself thoroughly* that neither personal safety nor vehicle safety will be jeopardized by the service methods or tools selected.



HOW TO USE THIS MANUAL

Follow the Maintenance Schedule recommendations to ensure that the vehicle is always in peak operating condition. Performing the first scheduled maintenance is very important. It compensates for the initial wear that occurs during the break-in period.

Sections 1 through 3 apply to the whole motorcycle, while sections 4 through 17 describe parts of the motorcycle, grouped according to location.

Find the section you want on this page, then turn to the table of contents on page 1 of that section.

Most sections start with an assembly or system illustration and specifications, torque values, general instructions, tools and troubleshooting for the section. The subsequent pages give detailed procedures for the section.

If you don't know the source of the trouble, see section 18, TROUBLESHOOTING.

Refer to the addendum at the back of the shop manual for information on the 1982 C70.

ALL INFORMATION, ILLUSTRATIONS, DIRECTIONS AND SPECIFICATIONS INCLUDED IN THIS PUBLICATION ARE BASED ON THE LATEST PRODUCT INFORMATION AVAILABLE AT THE TIME OF APPROVAL FOR PRINTING. HONDA MOTOR CO., LTD. RESERVES THE RIGHT TO MAKE CHANGES AT ANY TIME WITHOUT NOTICE AND WITHOUT INCURRING ANY OBLIGATION WHATSOEVER. NO PART OF THIS PUBLICATION MAY BE REPRODUCED WITHOUT WRITTEN PERMISSION.

HONDA MOTOR CO., LTD.
Service Publications Office

	GENERAL INFORMATION	1
	LUBRICATION	2
	INSPECTION AND ADJUSTMENT	3
ENGINE	FUEL SYSTEM	4
	ENGINE REMOVAL/INSTALLATION	5
	CYLINDER HEAD/VALVE	6
	CYLINDER/PISTON	7
	CLUTCH	8
	GEARSHIFT LINKAGE	9
	TRANSMISSION/CRANKSHAFT	10
	CAM CHAIN TENSIONER	11
	CHASSIS	FRONT WHEEL/SUSPENSION
REAR WHEEL/SUSPENSION		13
BATTERY/CHARGING SYSTEM		14
IGNITION SYSTEM		15
ELECTRIC STARTER		16
SWITCHES		17
TROUBLESHOOTING		18
	WIRING DIAGRAM	19
	'82 C70 ADDENDUM	20



MODEL IDENTIFICATION

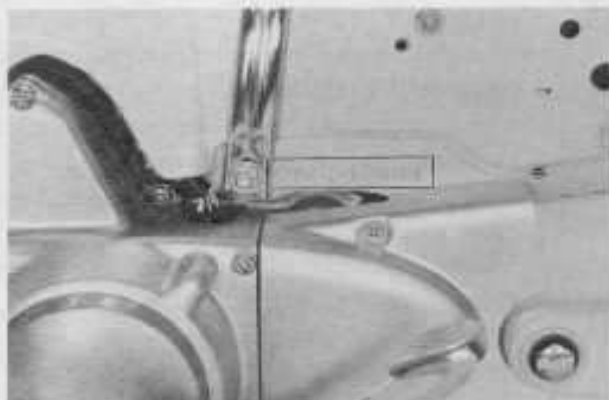
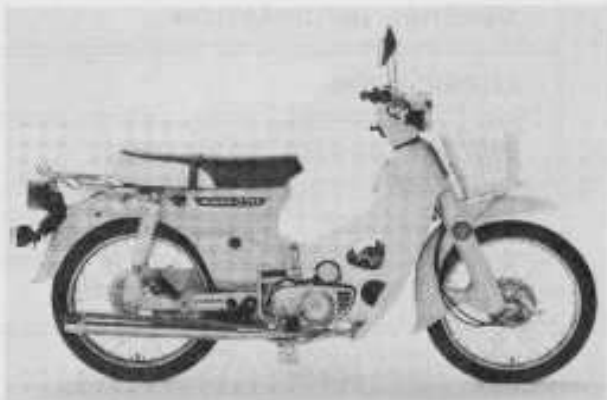

The frame serial number is stamped on the frame's left side behind the side cover.



The Vehicle Identification Number is on the Safety Certification Label on the frame's left side.

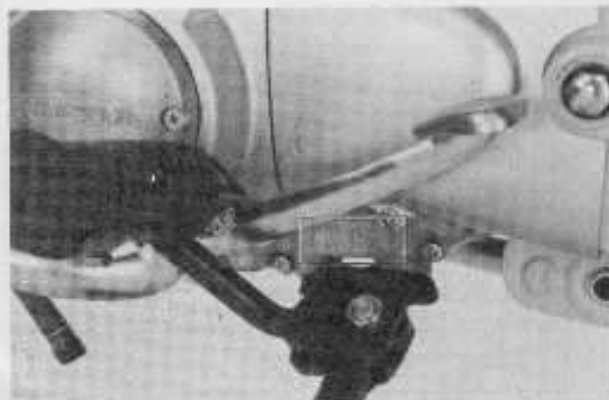

The engine serial number is stamped on the lower left crankcase.

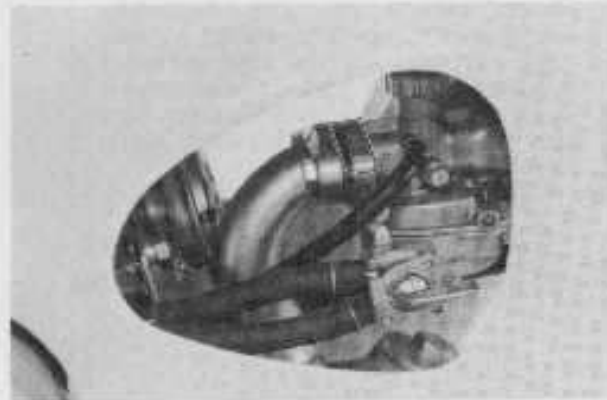

The carburetor identification number is stamped on top of the carburetor flange.



HONDA
C70

1. GENERAL INFORMATION

GENERAL SAFETY	1-1	CABLE & HARNESS ROUTING	1-6
SERVICE RULES	1-1	MAINTENANCE SCHEDULE	1-8
SPECIFICATIONS	1-2	EMISSION CONTROL SYSTEM	1-9
TORQUE VALUES	1-4		
TOOLS	1-5		

GENERAL SAFETY

WARNING

If the engine must be running to do some work, make sure the area is well-ventilated. Never run the engine in a closed area. The exhaust contains poisonous carbon monoxide gas.

WARNING

Gasoline is extremely flammable and is explosive under certain conditions. Do not smoke or allow flames or sparks in your working area.

WARNING

The battery electrolyte contains sulfuric acid. Protect your eyes, skin and clothing. In case of contact, flush thoroughly with water and call a doctor if electrolyte gets in your eyes.

WARNING

The battery generates hydrogen gas which can be highly explosive. Do not smoke or allow flames or sparks near the battery, especially while charging it.

SERVICE RULES

1. Use genuine HONDA or HONDA-recommended parts and lubricants or their equivalents. Parts that don't meet Honda's design specifications may damage the motorcycle.
2. Use the special tools designed for this product.
3. Use only metric tools when servicing this motorcycle. Metric bolts, nuts, and screws are not interchangeable with English fasteners. The use of incorrect tools and fasteners may damage the motorcycle.
4. Install new gaskets, O-rings, cotter pins, lock plates, etc. when reassembling.
5. When tightening bolts or nuts, begin with the larger-diameter or inner bolt first, and tighten to the specified torque values diagonally in 2-3 steps, unless a particular sequence is specified.
6. Clean parts in non-flammable or high flash point solvent upon disassembly. Lubricate any sliding surfaces before reassembly.
7. After reassembly, check all parts for proper installation and operation.



SPECIFICATIONS

	ITEM	
DIMENSIONS	Overall length	1,805 mm (71.1 in)
	Overall width	665 mm (26.2 in)
	Overall height	995 mm (39.2 in)
	Wheelbase	1,180 mm (46.5 in)
	Seat height	760 mm (29.9 in)
	Footpeg height	260 mm (10.2 in)
	Minimum ground clearance	130 mm (5.1 in)
	Dry weight	83.5 kg (184 lb)
FRAME	Type	Backbone
	Front suspension, travel	Leading-Link 55 mm (2.2 in)
	Rear suspension, travel	Swingarm 60 mm (2.4 in)
	Front tire size, pressure	2.25-17-4PR 2.0 kg/cm ² (28 psi)
	Rear tire size, pressure	2.50-17-6PR 2.8 kg/cm ² (40 psi)
	Front brake	Cable operated leading shoe
	Rear brake	Rod operated leading shoe
	Fuel capacity	4.0 lit (1.05 US gal, 0.88 Imp gal)
	Fuel reserve capacity	0.8 lit (0.21 US gal, 0.18 Imp gal)
	Caster angle	64°
	Trail	70 mm (2.8 in)
	ENGINE	Type
Cylinder arrangement		Single, inclined 80° from vertical
Bore and stroke		47.0 x 41.4 mm (1.85 x 1.63 in)
Displacement		72 cm ³ (4.4 cu in)
Compression ratio		8.8 : 1
Valve train		Chain driven overhead camshaft
Maximum horsepower		5.0 BHP/7,000 rpm
Maximum torque		0.56 kg-m/5,500 rpm
Oil capacity		0.7 lit (0.74 US qt, 0.62 Imp qt) after disassembly 0.6 lit (0.65 US qt, 0.53 Imp qt) after draining
Lubrication system		Forced pressure and wet sump
Air filtration		Paper
Cylinder compression		12.5 ± 0.5 kg/cm ² (178 ± 7 psi)
Intake valve Opens		0° BTDC
Closes		20° ABDC
Exhaust valve Opens		25° BBDC
Closes		5° ATDC
Valve clearance (Cold)		IN: 0.05 mm (0.002 in) EX: 0.05 mm (0.002 in)
Engine weight		18 kg (39.7 lb)
Idle speed	1,500 ± 100 rpm	
CARBURETION	Carburetor type	Piston valve, 14 mm (0.55 in) venturi bore
	Identification number	'80: PB32A '81: PB32C
	Pilot screw initial setting	See page 4-7
	Float level	10.7 mm (0.42 in)



	ITEM							
DRIVE TRAIN	Clutch	Wet multi-plate automatic centrifugal						
	Transmission	3-speed constant mesh						
	Primary reduction	4.058						
	Final reduction	2.571						
	Gear ratio I	3.272						
	Gear ratio II	1.722						
	Gear ratio III	1.190						
	Gearshift pattern	Left foot operated return system N-1-2-3						
ELECTRICAL	Ignition	Flywheel magneto						
	Point gap	0.3 - 0.4 mm (0.012-0.016 in)						
	Ignition timing "F" mark	15° BTDC, Static						
	Full advance	30° BTDC at 3,100 rpm						
	Starting system	Kick starter and starter motor						
	Generator	Flywheel A.C. generator 57 W/5,000 rpm						
	Battery capacity	6 V-11 AH						
	Spark plug	[CANADA]						
			For cold climate below 5°C, 41°F		STANDARD		For extended high speed operation	
			ND	NGK	ND	NGK	ND	NGK
		U20FS [U20FSR -L]	C6H [CR6HS]	U22FS [U22FSR -L]	C7HS [CR7HS]	U24FB [U24FSR -L]	C9H [CR8HS]	
	Spark plug gap	0.6 - 0.7 mm (0.024 - 0.028 in)						
	Fuse capacity	10 A						
LIGHTS	Headlight (high/low beam)	15/15 W						
	Tail/stoplight	5.3/25 W		3/32 cp				
	Turn signal	17 W		21 cp		SAE No. 1129		
	Speedometer	1.7 W		1 cp		SAE No. 51		
	Neutral indicator	1.7 W		1 cp		SAE No. 51		
	Turn signal indicator	1.7 W		1 cp		SAE No. 51		
	High beam indicator	1.7 W		1 cp		SAE No. 51		

TORQUE VALUES

ENGINE

Item	Q'ty	Thread dia. (mm)	Torque	
			kg-m	ft-lb
Cylinder head cover	4	6	0.9 - 1.2	7 - 9
Camshaft sprocket	3	5	0.5 - 0.9	4 - 7
Clutch lock nut	1	14	3.8 - 4.5	28 - 33
Final drive sprocket	2	6	1.0 - 1.4	7 - 10
Flywheel	1	10	5.5 - 6.5	40 - 47
Spark advancer	1	6	0.9 - 1.2	7 - 9

FRAME

Item	Q'ty	Thread dia. (mm)	Torque	
			kg-m	ft-lb
Steering stem nut	1	22	6.0 - 9.0	43 - 65
Handlebar setting nut	2	8	2.0 - 3.0	14 - 22
Steering lock	2	6	0.6 - 1.3	4 - 9
Front axle nut	1	10	3.0 - 4.0	22 - 29
Engine hanger bolt	2	8	2.5 - 3.5	18 - 25
Rear axle nut	1	12	4.0 - 5.0	29 - 36
Final driven sprocket	4	8	2.0 - 2.5	14 - 18
Rear brake torque link	2	8	1.0 - 2.0	7 - 14
Rear shock absorber	4	10	2.0 - 3.0	14 - 22
Foot peg	4	8	2.0 - 2.5	14 - 18
Swingarm pivot bolt	1	10	3.0 - 4.0	22 - 29
Front suspension pivot bolt	2	8	1.0 - 2.0	7 - 14
Front suspension stopper bolt	2	8	2.0 - 3.0	14 - 22
Front shock absorber upper bolt	2	8	2.5 - 3.5	18 - 25
Front turn signal stay	4		0.35 - 0.5	2.5 - 3.6

Torque specifications listed above are for the most important tightening points. If a torque specification is not listed, follow the standards given below.

STANDARD TORQUE VALUES

Item	Torque		Item	Torque	
	kg-m	ft-lb		kg-m	ft-lb
5 mm bolt, nut	0.45 - 0.6	3.3 - 4.3	5 mm screw	0.35 - 0.5	2.5 - 3.6
6 mm bolt, nut	0.8 - 1.2	6 - 9	6 mm screw	0.7 - 1.1	5 - 8
8 mm bolt, nut	1.8 - 2.5	13 - 18	6 mm flange bolt, nut	1.0 - 1.4	7 - 10
10 mm bolt, nut	3.0 - 4.0	22 - 29	8 mm flange bolt, nut	2.4 - 3.0	17 - 22
12 mm bolt, nut	5.0 - 6.0	36 - 43	10 mm flange bolt, nut	3.0 - 4.0	22 - 29



TOOLS

SPECIAL

Tool Name	Tool No.	Q'ty	Ref. page
Valve guide reamer	07984-0980000	1	6-8, 6-9
Flywheel holder	07922-1290000	1	14-7, 14-8
• Commercially available band strap wrench may be used.			
Ball race remover	17946-1790000 M9310-277-91774 (U.S.A. only)	1	12-18
Pin spanner, 36 mm	07902-0010000	1	12-17, 12-19
Valve guide driver	07942-1180100	1	6-9

COMMON

Tool Name	Tool No.	Q'ty	Alternate Tool	Tool No.	Ref. page
Float level gauge	07401-0010000	1			4-5
Valve guide remover 5.5 mm	07742-0010100	1	Valve guide remover	07942-3290100	6-9
Universal holder	07725-0010101	1	Clutch holder	07923-0400000	8-3, 8-6
Valve adjusting wrench, 8 x 9 mm	07708-0030100	1	Commercially available 8 x 9 mm offset box-end wrench		3-6
Valve adjusting wrench, B	07708-0030400 U.S.A. only, refer to S.T.N. No. 47	1			3-6
Lock nut wrench, 26 x 30 mm	07716-0020202	1	Commercial available		8-3
Extension bar	07716-0020500	1			8-3
Rotor puller	07733-0020001	1	Removing bolt	90015-360-000	14-7
Bearing driver handle, A	07749-0010000	1	Driver handle	07949-6110000 07949-3000000	12-9, 13-4, 13-9
Bearing driver outer, 32 x 35 mm	07746-0010100	1	Bearing driver attach.	07946-9370100	12-9
Bearing driver outer, 37 x 40 mm	07746-0010200	1	Bearing driver attach.	07945-0980000, 37 mm 07946-3000000, 40 mm	13-4
Bearing driver pilot, 10 mm	07746-0040100	1			12-9
Bearing driver pilot, 12 mm	07746-0040200	1			13-4
Bearing driver pilot, 17 mm	07746-0040400	1			13-9
Rear shock absorber compressor	07959-3290001	1			13-10, 13-11
Nipple spanner B, 4.5 x 5.1 mm	07701-0020200	1			3-18
Valve spring compressor	07757-0010000	1	Valve spring compressor	07957-3290001	6-5, 6-11
Lock nut wrench, 20 x 24 mm	07716-0020100	1			8-3, 8-6



CABLE & HARNESS ROUTING

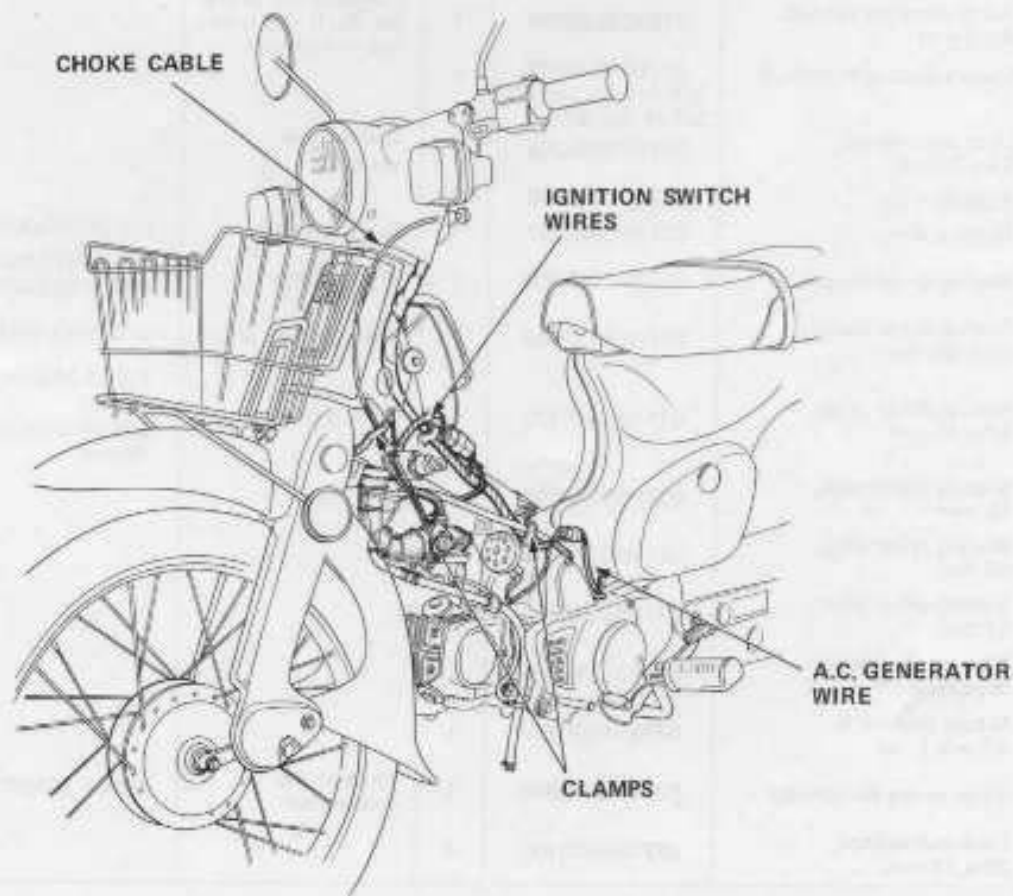
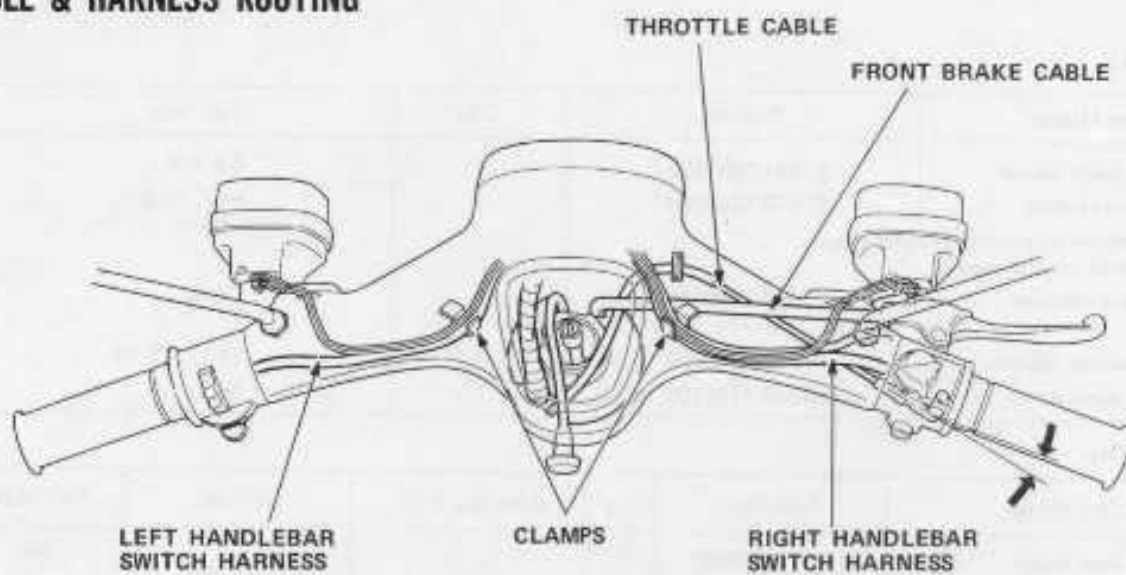

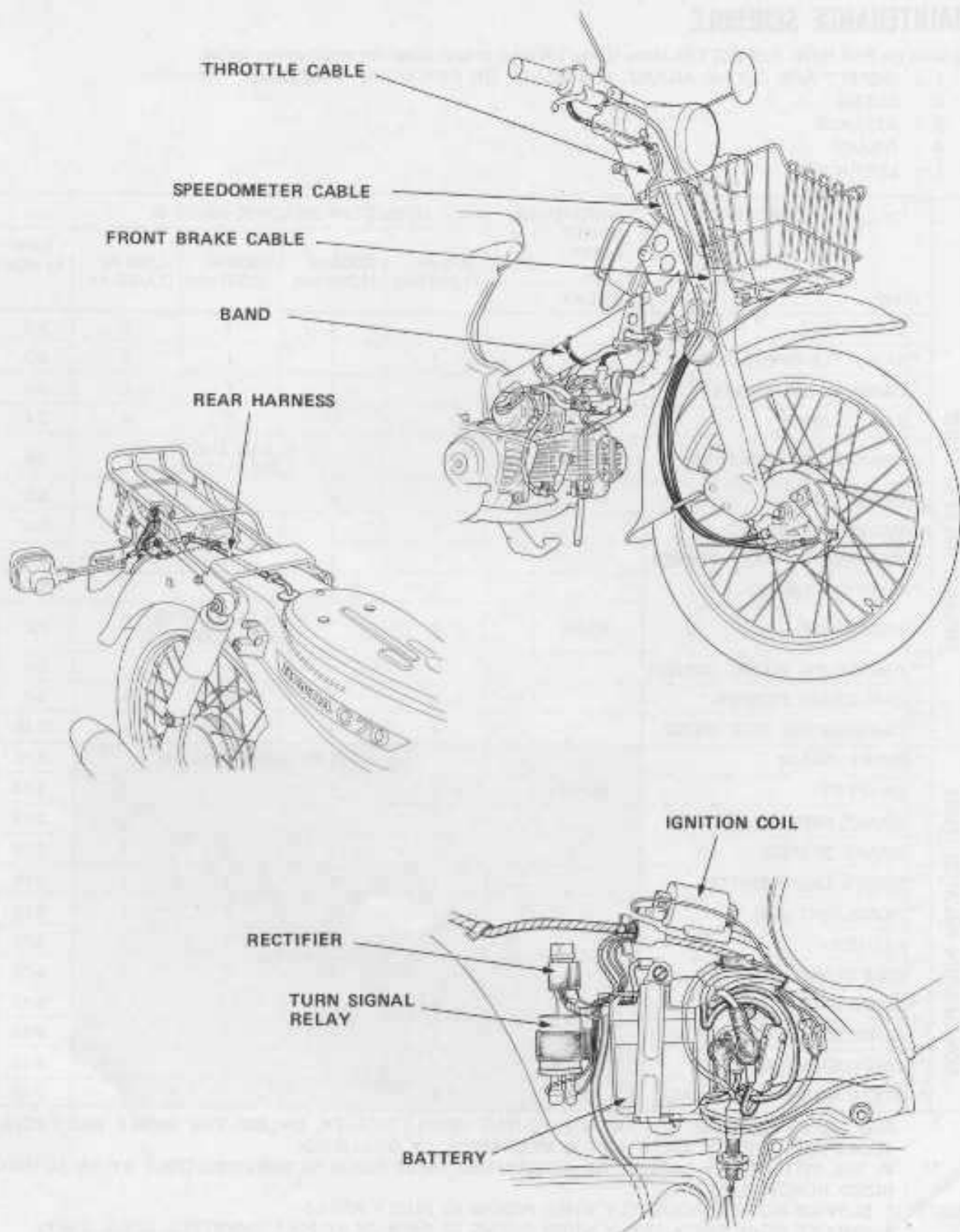

MAINTENANCE SCHEDULE

Perform the PRE-RIDE INSPECTION in the Owner's Manual at each scheduled maintenance period.

- I : INSPECT AND CLEAN, ADJUST, LUBRICATE, OR REPLACE IF NECESSARY.
 C : CLEAN
 R : REPLACE
 A : ADJUST
 L : LUBRICATE

ITEM	FREQUENCY	WHICHEVER COMES FIRST	ODOMETER READING (NOTE 3)				Refer to page	
			600 mi (1,000 km)	2,500 mi (4,000 km)	5,000 mi (8,000 km)	7,500 mi (12,000 km)		
EMISSION RELATED ITEMS	* FUEL LINES	EVERY		I	I	I	3-3	
	* THROTTLE OPERATION		I	I	I	I	3-3	
	* CARBURETOR CHOKE			I	I	I	3-4	
	AIR CLEANER		NOTE 1		C	C	R	3-4
	CRANKCASE BREATHER		NOTE 2		CLEAN EVERY 1,250 mi (2,000 km)			3-5
	SPARK PLUG				R	R	R	3-5
	* VALVE CLEARANCE			I	I	I	I	3-6
	* CONTACT BREAKER POINTS			I	I	R	I	3-7
	* IGNITION TIMING			I	I	I	I	3-8
	ENGINE OIL		YEAR	R	REPLACE EVERY 1,250 mi (2,000 km)			2-2
	* ENGINE OIL FILTER SCREEN					C		2-2
	* CAM CHAIN TENSION			A	A	A	A	3-9
	* CARBURETOR IDLE SPEED			I	I	I	I	3-10
NON-EMISSION RELATED ITEMS	DRIVE CHAIN		I, L EVERY 300 mi (500 km)				3-11	
	BATTERY	MONTH	I	I	I	I	3-13	
	BRAKE SHOE WEAR			I	I	I	3-13	
	BRAKE SYSTEM		I	I	I	I	3-14	
	* BRAKE LIGHT SWITCH		I	I	I	I	3-15	
	* HEADLIGHT AIM		I	I	I	I	3-15	
	CLUTCH		I	I	I	I	3-16	
	SIDE STAND			I	I	I	3-16	
	* SUSPENSION		I	I, L	I, L	I, L	3-17	
	* NUTS, BOLTS, FASTENERS		I	I	I	I	3-18	
	** WHEELS/SPOKES		I	I	I	I	3-18	
** STEERING HEAD BEARINGS		I			I	3-18		

* SHOULD BE SERVICED BY AN AUTHORIZED HONDA DEALER, UNLESS THE OWNER HAS PROPER TOOLS AND SERVICE DATA AND IS MECHANICALLY QUALIFIED.

** IN THE INTEREST OF SAFETY, WE RECOMMEND THESE ITEMS BE SERVICED ONLY BY AN AUTHORIZED HONDA DEALER.

NOTE: 1. SERVICE MORE FREQUENTLY WHEN RIDING IN DUSTY AREAS.

2. SERVICE MORE FREQUENTLY WHEN RIDING IN RAIN OR AT FULL THROTTLE. (U.S.A. ONLY)

3. FOR HIGHER ODOMETER READINGS, REPEAT AT THE FREQUENCY INTERVAL ESTABLISHED HERE.



EMISSION CONTROL SYSTEM

The C70 is equipped with lean carburetor settings and other systems to reduce carbon monoxide and hydrocarbon emissions.

EXHAUST SYSTEM

The exhaust emission control system is composed of lean carburetor settings, and no adjustments should be made except idle speed adjustment with the throttle stop screw.

The exhaust emission control system is separate from the crankcase emission control system.

CRANKCASE SYSTEM

The engine is equipped with a closed crankcase system to prevent discharging crankcase emissions into the atmosphere.

Blow-by gas is returned to the combustion chamber through the air cleaner and the carburetor.

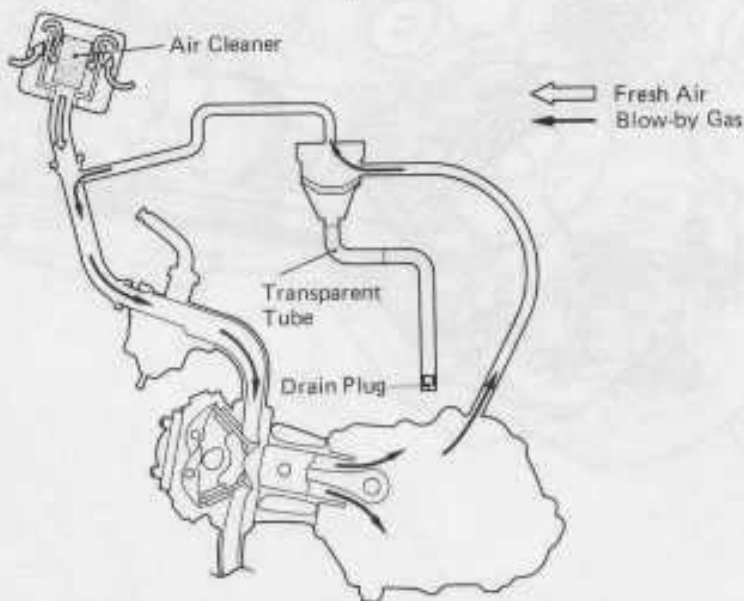

INFORMATION LABEL

The Emission Control Information Label is located on the swingarm left side.

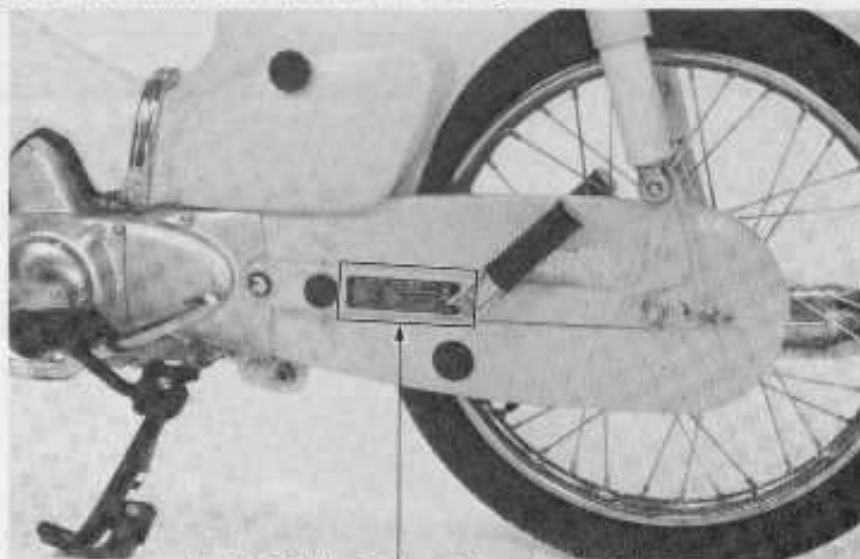

Vehicle Emission Control Information Label

ENGINE LUBRICATION SYSTEM

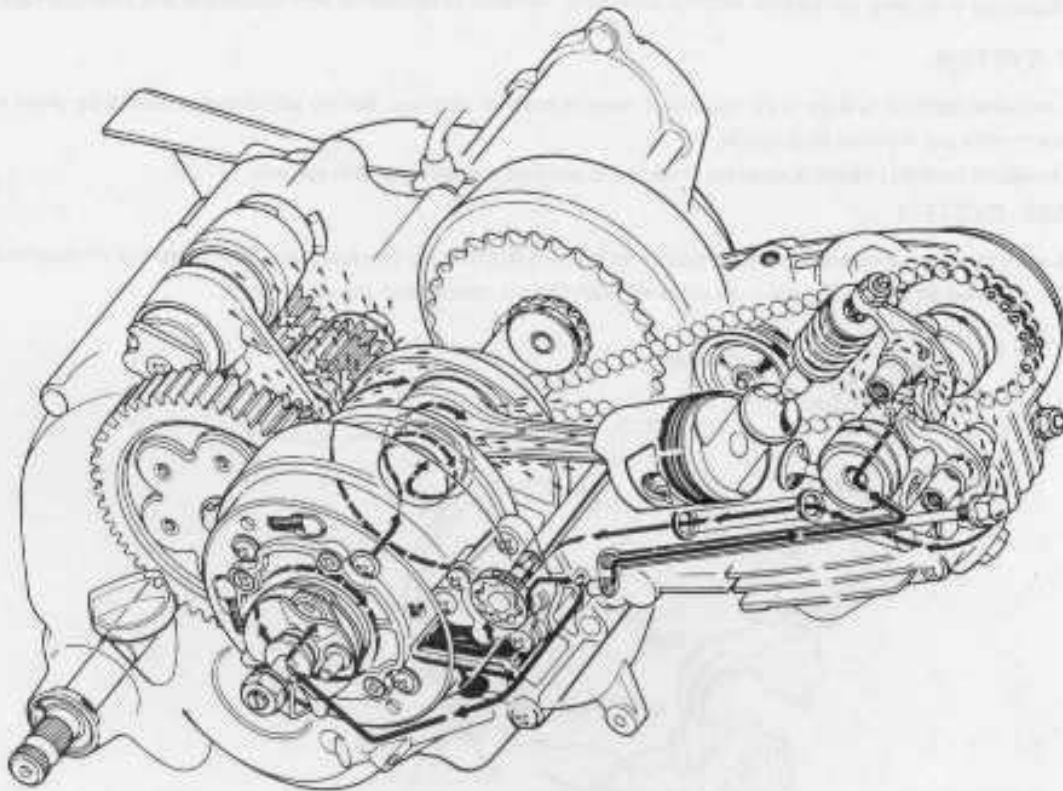



SERVICE INFORMATION	2-1	ENGINE OIL FILTER SCREEN CLEANING	2-2
TROUBLESHOOTING	2-1	CENTRIFUGAL OIL FILTER CLEANING	2-3
<ENGINE>		OIL PUMP	2-4
ENGINE OIL LEVEL	2-2	<CHASSIS>	
ENGINE OIL CHANGE	2-2	LUBRICATION POINTS	2-7

SERVICE INFORMATION

GENERAL INSTRUCTIONS

Oil filter screen and oil pump inspection and maintenance can be made without removing the engine.

SPECIFICATIONS

	STANDARD	SERVICE LIMIT
Engine oil capacity	Approximately 0.6 liter (0.65 US qt) at oil change 0.7 liter (0.74 US qt) at engine assembly	
Recommended oil	<p>HONDA 4-STROKE OIL SAE 10W-40 or equivalent. API service classification: SE</p> <p>Other viscosities may be used when the average temperature in your riding area is within the indicated range.</p> <p>Recommended oil viscosities</p>	
Oil pump	Tip clearance 0.15 mm (0.006 in) Body clearance 0.10 - 0.15 mm (0.004 - 0.006 in) End clearance 0.02 - 0.07 mm (0.001 - 0.003 in)	0.20 mm (0.008 in) 0.20 mm (0.008 in) 0.12 mm (0.005 in)

TROUBLESHOOTING

Oil level too low

1. External oil leaks
2. Worn valve guide or seal
3. Worn piston rings

Oil contamination

1. Oil not changed often enough
2. Head gasket faulty
3. Worn piston rings



<ENGINE>

ENGINE OIL LEVEL

Support the motorcycle upright on level ground. Check the oil level with the filler cap/dipstick. Do not screw in the cap when making this check. If the level is below the lower level on the dipstick, fill to the upper level mark with the recommended engine oil.

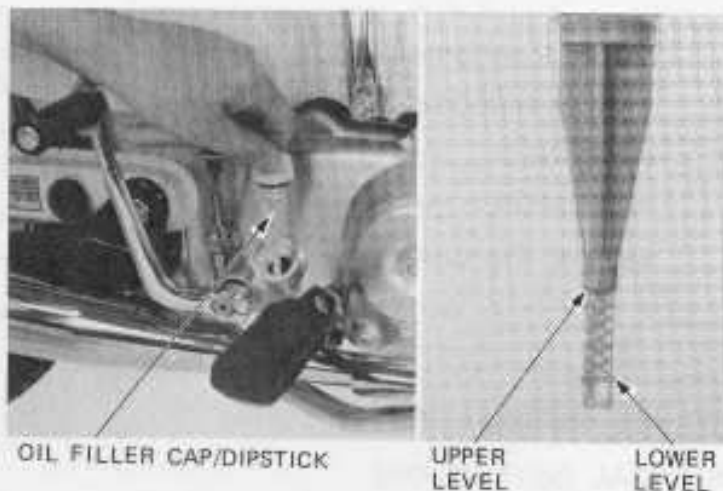

OIL FILLER CAP/DIPSTICK

UPPER
LEVELLOWER
LEVEL

ENGINE OIL CHANGE

NOTE

When changing the oil, drain the used oil from the crankcase while the engine is warm. This ensures complete and rapid draining.

Remove the oil filler cap/dipstick.

Place an oil drain pan under the engine, and remove the drain plug. When the oil has been completely drained, be sure that the drain plug sealing washer is in good condition and install the drain plug.

TORQUE: 2.0 – 2.5 kg-m (14 – 18 ft-lb)

Pour the recommended oil (page 2-1) slowly through the oil filter hole.

CAPACITY: 0.6 liter (0.65 US qt) at oil change

Install the oil filler cap/dipstick. Start the engine and let it idle 2-3 minutes. Stop the engine and check that the oil level is at the upper level mark on the dipstick with the motorcycle upright. Check that there are no oil leaks.



DRAIN PLUG

ENGINE OIL FILTER SCREEN
CLEANING

NOTE

Perform this maintenance with the engine oil drained.

Remove the front cover lower right mounting bolt. Remove the kick starter pedal and muffler. Support the motorcycle with a suitable stand and remove the footpegs/side stand assembly. Remove the right crankcase cover.



RIGHT CRANKCASE COVER

FRONT COVER
LOWER RIGHT
MOUNTING BOLT

MUFFLER

KICK STARTER PEDAL

FOOTPEGS/SIDE STAND



Remove and clean the oil filter screen.
Install the oil filter screen, right crankcase gasket and cover, kick starter pedal, muffler and footpegs/side stand assembly.
Fill the crankcase with the recommended engine oil.
Start the engine and let it idle for 2-3 minutes.
Stop the engine and check the oil level with the motorcycle upright.
Make sure that there are no oil leaks.

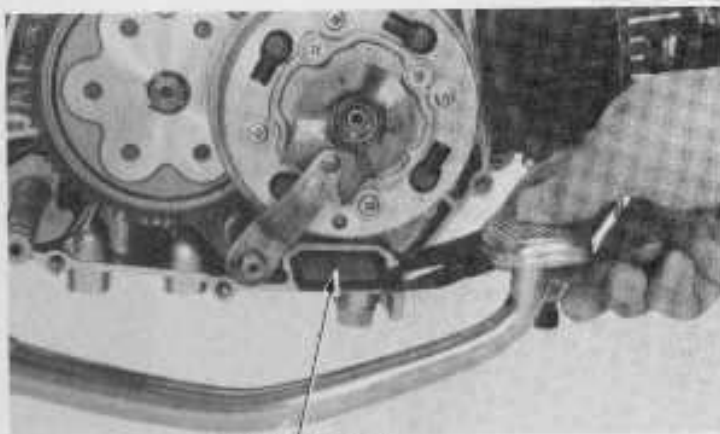

FILTER SCREEN

CENTRIFUGAL OIL FILTER CLEANING

Drain the engine oil (page 2-2).

Remove the right crankcase cover (page 2-2).
Remove the clutch lever, cam and outer cover.

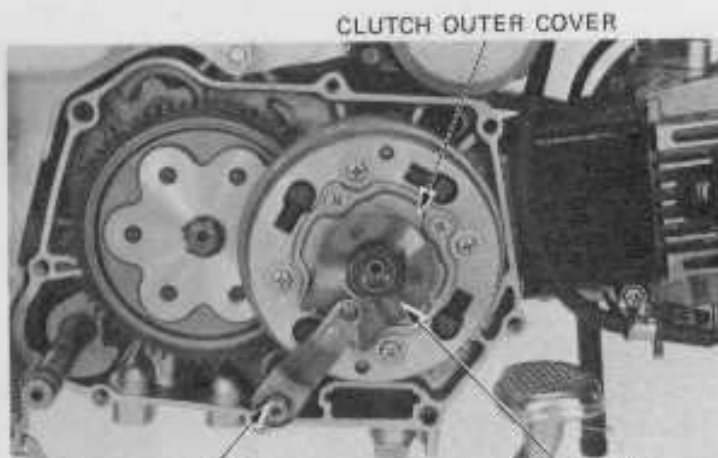

CLUTCH LEVER

CLUTCH CAM

Clean the clutch outer cover and inside of the clutch outer using a clean lint-free cloth.

NOTE

- Do not allow dust and dirt to enter the crankshaft oil passage.
- Do not use compressed air.

Install the clutch outer cover, cam and lever.
Install the right crankcase cover, kick starter pedal, muffler and foot pegs/side stand assembly.
Fill the crankcase with the recommended engine oil (page 2-2).

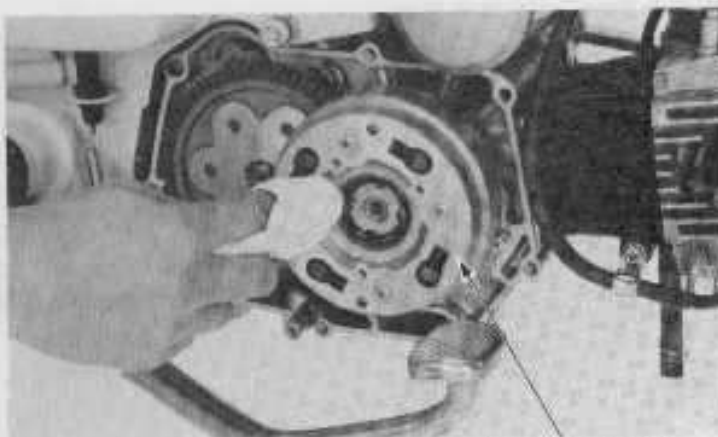

CLUTCH OUTER



OIL PUMP

REMOVAL

NOTE

The oil pump can be removed with the engine mounted in the frame.

Remove the oil drain plug and drain the oil from the engine (page 2-2). Remove the right crankcase cover (page 2-2).

Remove the clutch assembly (page 8-2).



Remove the three oil pump screws and oil pump.

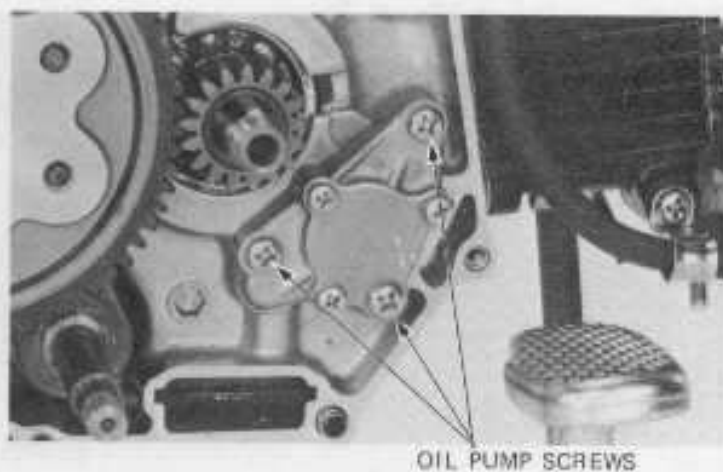

OIL PUMP SCREWS

INSPECTION

Remove the oil pump body cover.



PUMP BODY COVER



Measure the rotor tip clearance.
SERVICE LIMIT: 0.20 mm (0.008 in)

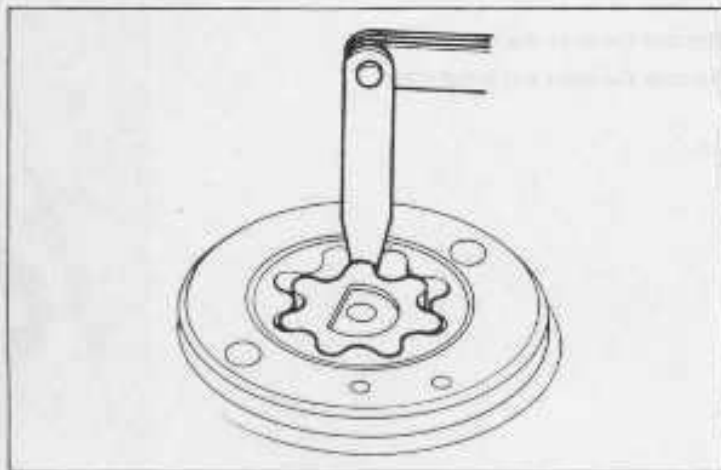

Measure the pump body clearance.
SERVICE LIMIT: 0.20 mm (0.008 in)

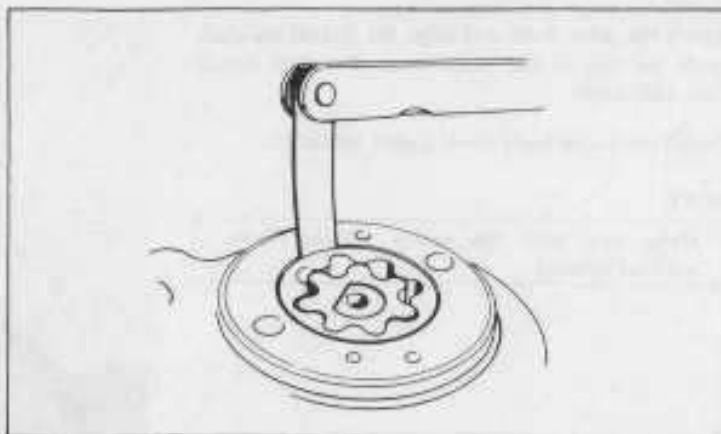

Measure the rotor and clearance.
SERVICE LIMIT: 0.12 mm (0.005 in)

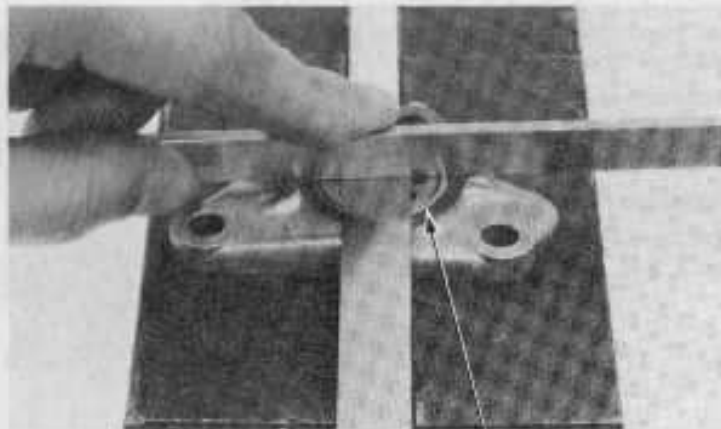

GASKET

DISASSEMBLY

Remove the drive shaft.

Remove the inner and outer rotors.

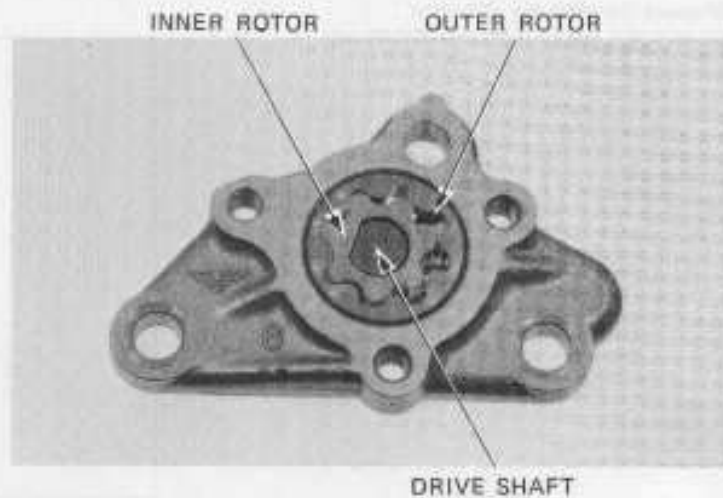

ASSEMBLY

Install the outer and inner rotors.

Insert the drive shaft and align the flat on the shaft with the flat in the inner rotor. The flats should face each other.

Install the pump body cover gasket and cover.

NOTE

Make sure that the pump rotates freely without binding.

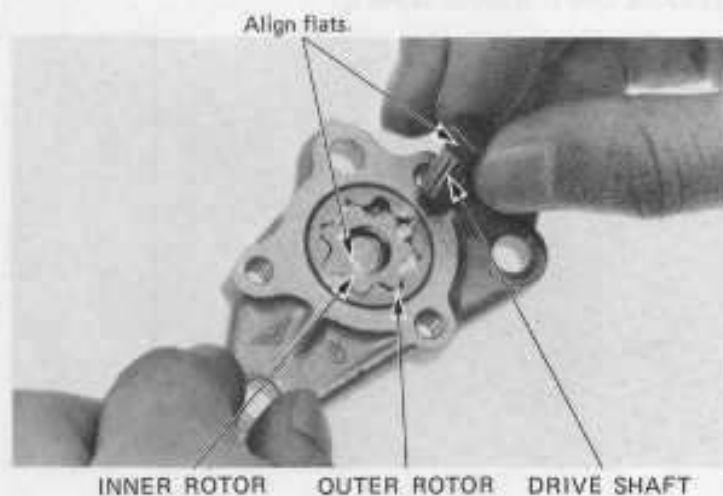

INSTALLATION

Install the oil pump with the gasket under it aligning the pump drive shaft with the slot in the cam chain guide spindle.

Install the clutch assembly (page 8-6).

Install the right crankcase cover, kick starter pedal, muffler and foot pegs/side stand assembly.

Adjust the clutch (page 3-16).

Fill the crankcase with the recommended engine oil (page 2-11).

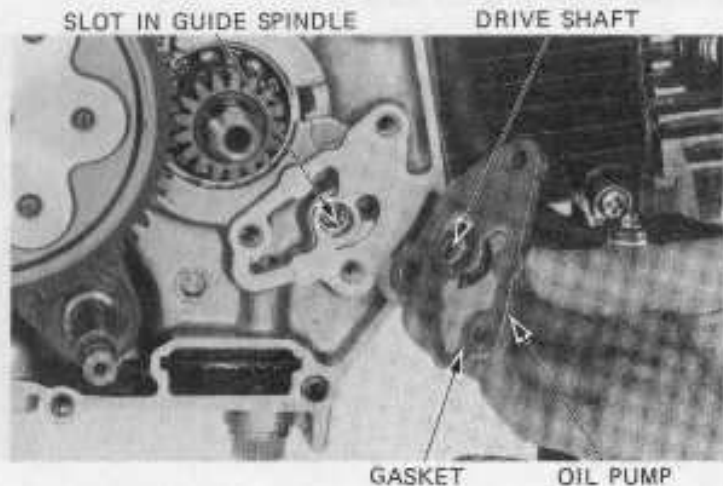



<CHASSIS> LUBRICATION POINTS

Use general purpose grease when not specified here.

Apply oil or grease to the other sliding surfaces not shown here.

CONTROL CABLE LUBRICATION

Periodically, disconnect the throttle, front brake and choke cables at their upper ends. Thoroughly lubricate the cables and their pivot points with a commercially available cable lubricant.

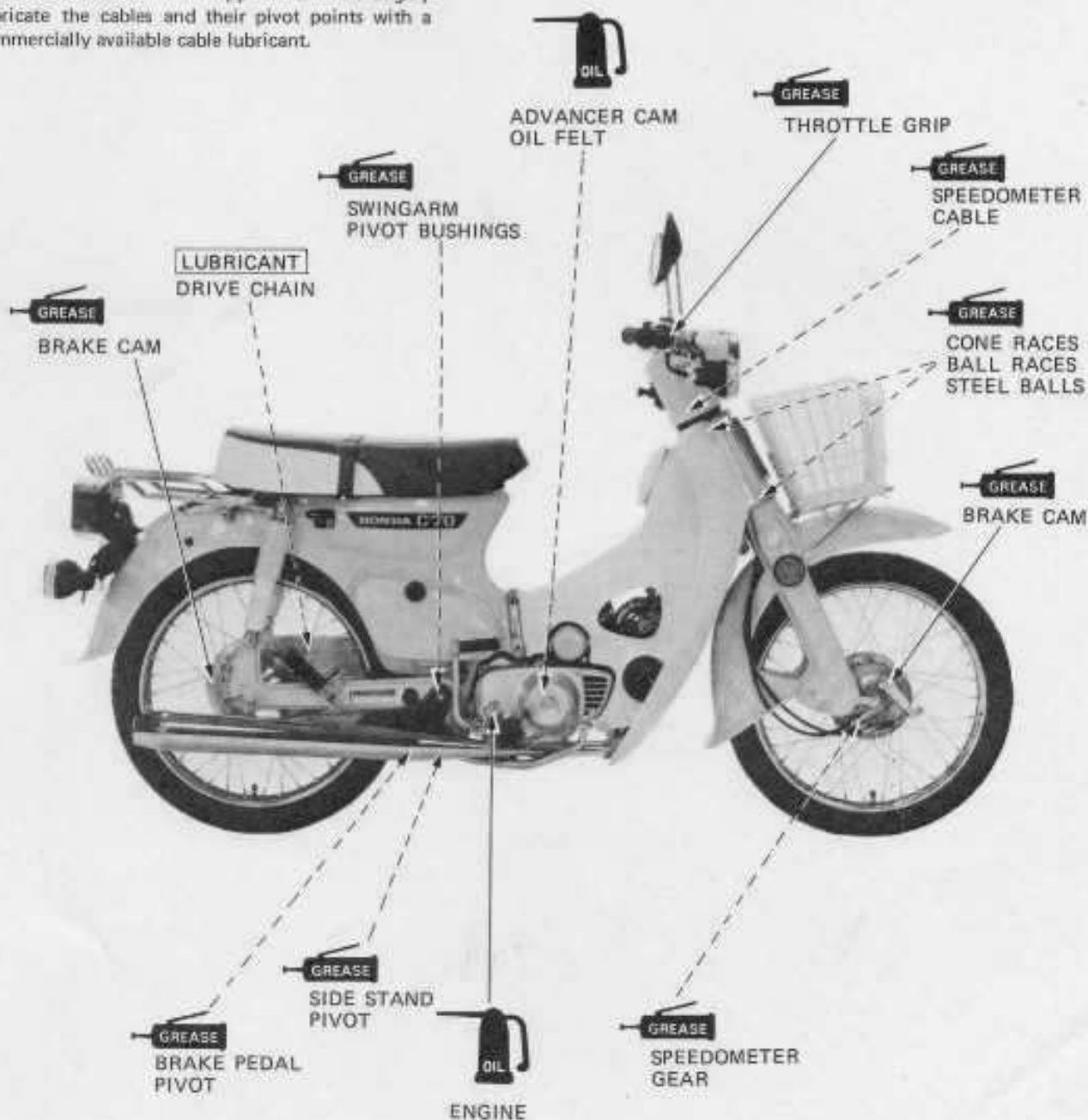



SERVICE INFORMATION	3-1	<CHASSIS>	
<ENGINE>		DRIVE CHAIN	3-11
FUEL LINES	3-3	BATTERY	3-13
THROTTLE OPERATION	3-3	BRAKE SHOE WEAR	3-13
CARBURETOR CHOKE	3-4	BRAKE SYSTEM	3-14
AIR CLEANER	3-4	BRAKE LIGHT SWITCH	3-15
CRANKCASE BREATHER (USA only)	3-5	HEADLIGHT AIM	3-15
SPARK PLUG	3-5	CLUTCH	3-16
VALVE CLEARANCE	3-6	SIDE STAND	3-16
CONTACT BREAKER POINTS	3-7	SUSPENSION	3-17
IGNITION TIMING	3-8	NUTS, BOLTS, FASTENERS	3-18
SPARK ADVANCER	3-9	WHEELS/SPOKES	3-18
CAM CHAIN TENSION	3-9	STEERING HEAD BEARING	3-18
CARBURETOR IDLE SPEED	3-10		
CYLINDER COMPRESSION	3-10		

SERVICE INFORMATION

GENERAL INSTRUCTIONS

- Engine oil See page 2-2
- Engine oil filter screen See page 2-2

TOOLS

Common

Valve adjusting wrench, 8 x 9 mm 07708-0030100 or commercially available 8 x 9 mm offset box end wrench

Valve adjuster B 07708-0030400

Spoke nipple spanner B, 4.5 x 5.1 mm 07701-0020200

SPECIFICATIONS

< Engine >

Throttle grip free play: 2-6 mm (1/8 - 1/4 in)

Spark plug: Recommended spark plug [] Canadian type

For cold climate (Below 5°C, 41°F)		Standard		For extended high speed riding	
ND	NGK	ND	NGK	ND	NGK
U20FS [U20FSR-L]	C6H [CR6HS]	U22FS [U22FSR-L]	C7HS [CR7HS]	U24FB [U24FSR-L]	C9H [CR8HS]

Plug gap 0.6 - 0.7 mm (0.024 - 0.028 in)

Valve clearance: Cold (Below 35°C, 95°F)

Intake/Exhaust 0.05 mm (0.002 in)



Contact breaker point gap:	0.3 – 0.4 mm (0.012 – 0.016 in)
Ignition timing:	
Initial, "F" mark	15° BTDC
Advance start	1,875 rpm
Full advance	30° BTDC at 2,900 rpm
Idle speed:	1,500 ± 100 rpm
Cylinder compression:	12.5 ± 0.5 kg/cm ² (178 ± 7 psi)

< Chassis >

Drive chain slack:	15 – 25 mm (5/8 – 1 in)
Front brake lever free play:	20 – 30 mm (3/4 – 1 1/4 in)
Rear brake pedal free play:	20 – 30 mm (3/4 – 1 1/4 in)
Tire:	

		Front	Rear
Tire size		2.25-17-4PR	2.50-17-6PR
Cold tire pressure kg/cm ² (psi)	Up to vehicle capacity load (135 kg, 300 lb)	2.0 (28)	2.8 (40)
	Up to 90 kg (200 lb) load	2.0 (28)	2.0 (28)

TORQUE VALUES

Rear axle sleeve nut:	4.0 – 5.0 kg-m (29 – 36 ft-lb)
Rear axle nut:	4.0 – 5.0 kg-m (29 – 36 ft-lb)



<ENGINE>

FUEL LINES

Check the fuel lines for deterioration, damage or leakage. Replace if necessary.



FUEL LINES

THROTTLE OPERATION

Check for smooth throttle grip full opening and automatic full closing in all steering positions. Check the throttle cable and replace it if it is deteriorated, kinked or damaged.

Lubricate the throttle cable (page 2-7) if throttle operation is not smooth.

Measure throttle grip free play at the throttle grip flange.

FREE PLAY: 2-6 mm (1/8-1/4 in)



Adjustment can be made at either end of the throttle cable.

Minor adjustments are made with the upper adjuster.

Adjust by loosening the lock nut and turning the adjuster. Tighten the lock nut.

Major adjustments are made at the lower adjuster on the carburetor after removing the front cover.

Remove the carburetor rubber cap.
Turn the adjuster to obtain the specified free play.

Recheck the throttle operation.

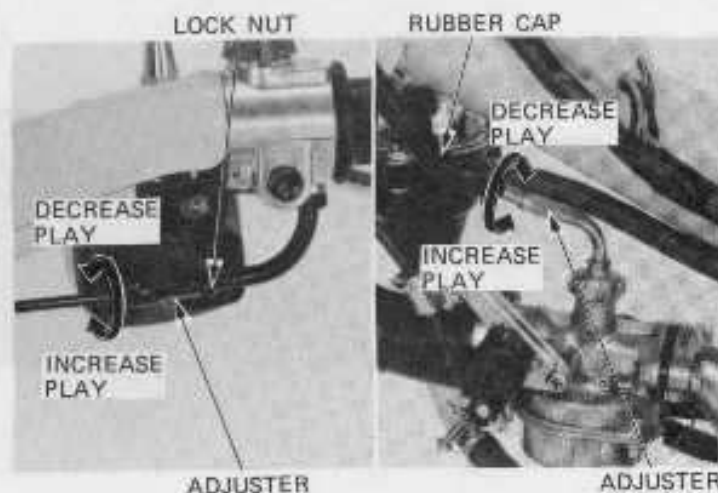

LOCK NUT

RUBBER CAP

DECREASE PLAY

INCREASE PLAY

ADJUSTER

DECREASE PLAY

INCREASE PLAY

ADJUSTER

CARBURETOR CHOKE

Check for smooth choke knob operating friction. The choke knob must move smoothly and stay where positioned.

Adjust by turning the friction adjuster nut under the rubber cap.

Pull the choke knob all the way out and make sure the choke valve is closed by moving the carburetor choke lever.

Adjustment:

Remove the front cover (page 5-2).

Loosen the cable clamp and pull the cable casing up just so the choke valve is fully closed. Push the choke knob in and be sure the choke valve is fully open by checking for 1-2mm (1/16-1/8 in) cable slack.

Install the front cover.

AIR CLEANER

Remove the air cleaner cover cap nut and cover. Remove the air cleaner element nut and element.

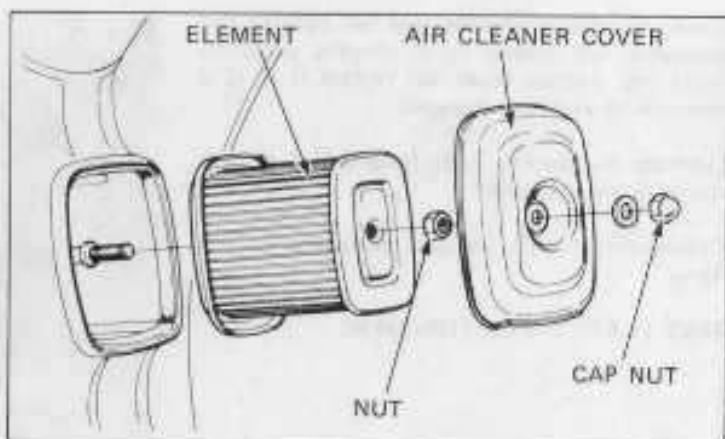
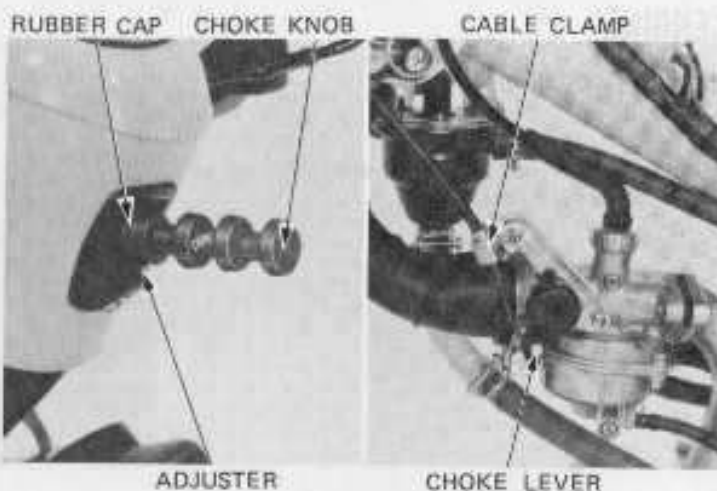

Clean the element by tapping it lightly to loosen dust. Blow away the remaining dust by applying compressed air from inside the element.

Replace the element if it is excessively dirty, torn or damaged.

Install the element and air cleaner cover.

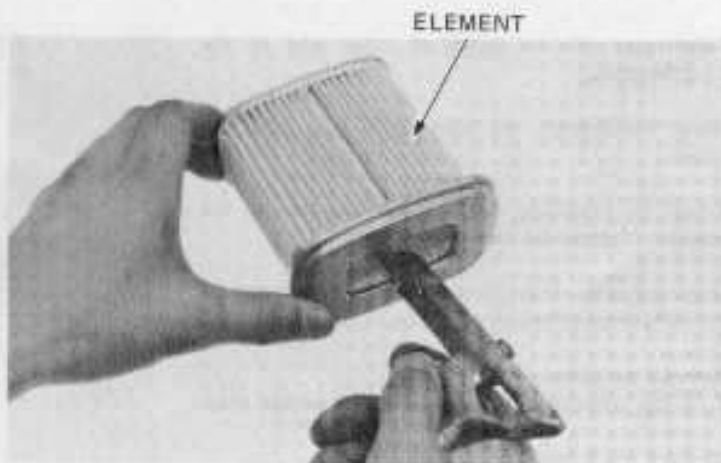



CRANKCASE BREATHER (USA only)

Remove the plug from the drain tube to drain deposits.

Install the drain plug.

NOTE

Service more frequently when ridden in rain or at full throttle, or if the deposit level can be seen in the drain tube transparent section.

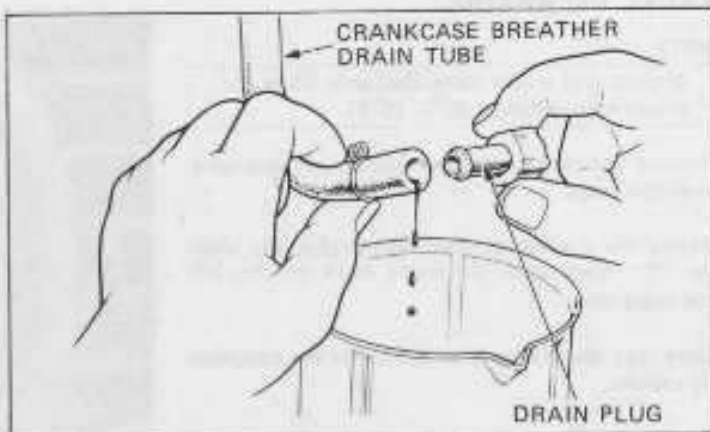

SPARK PLUG

Clean any dirt from around the spark plug base.

Disconnect the spark plug cap.

Remove and discard the spark plug.

Measure the new spark plug gap using a wire-type feeler gauge.

SPARK PLUG GAP: 0.6–0.7 mm (0.024–0.028 in)

Adjust by bending the side electrode carefully.

With the plug washer attached, thread the new spark plug in by hand to prevent cross-threading.

Tighten the spark plug another 1/2 turn with a spark plug wrench to compress the plug washer.

Connect the spark plug cap.

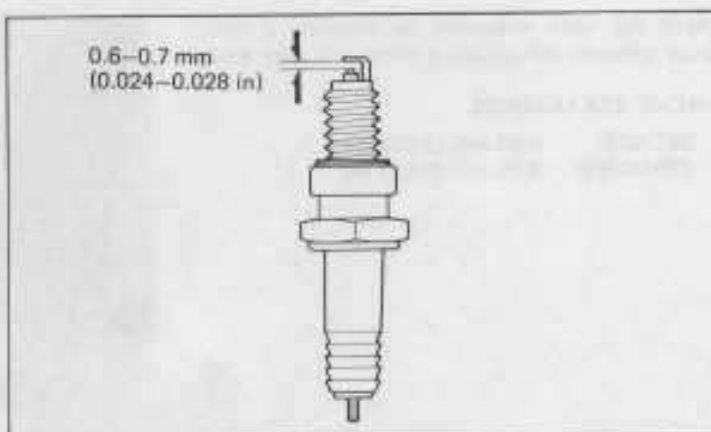

RECOMMENDED SPARK PLUG:

() Canadian type

Standard	NGK C7HS (CR7HS) ND U22FS (U22FSR-L)
For cold climate (Below 5°C, 41°F)	NGK C6H (CR6H) ND U20FS (U20FSR-L)
For extended high speed riding	NGK C9H (CR8HS) ND U24FB (U24FSR-L)



VALVE CLEARANCE

NOTE

Inspect and adjust valve clearance while the engine is cold (below 35°C, 95°F).

Remove the contact breaker point cover and valve inspection caps.

Rotate the crankshaft counterclockwise and align the "T" mark with the index mark on the left crankcase cover.

Make sure the piston is at T.D.C. on the compression stroke.



INDEX MARK

"T" MARK

Check the valve clearances by inserting a feeler gauge between the adjusting screw and valve stem.

VALVE CLEARANCES

INTAKE: 0.05 mm (0.002 in)
EXHAUST: 0.05 mm (0.002 in)



LOCK NUT

FEELER GAUGE

ADJUSTING SCREW

Adjust by loosening the lock nut and turning the adjusting screw until there is a slight drag on the feeler gauge.

Hold the adjusting screw and tighten the lock nut.

Recheck the valve clearance.

Install the contact breaker point cover and valve inspection caps.

VALVE ADJUSTING
WRENCH, 8 x 9mm

VALVE ADJUSTER B



CONTACT BREAKER POINTS

Remove the contact breaker point cover.

Clean the breaker point surfaces with an electrical contact cleaner to remove any oil film or dirt.

BREAKER POINTS

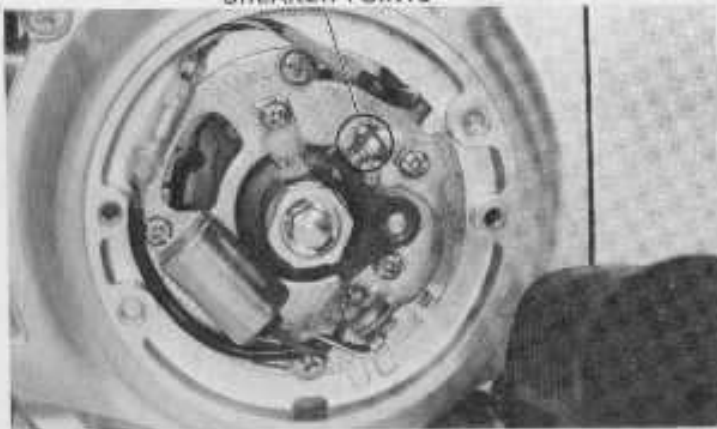

If the contact surfaces are level but grayish in color or are slightly pitted, file them lightly.

If the points have a noticeable transfer of metal from one surface to the other, have evidence of heavy arcing, or are worn at an angle, the point set should be replaced.

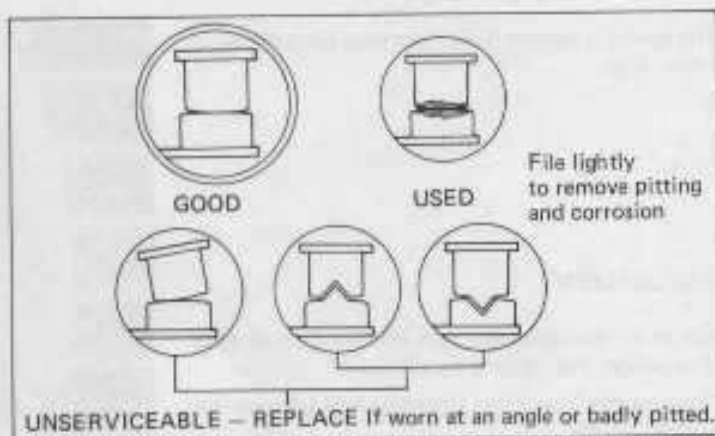

Rotate the crankshaft counterclockwise, and make sure that maximum point gap is 0.3–0.4 mm (0.012–0.016 in) with a feeler gauge.

If the point gap is incorrect, loosen the contact breaker plate locking screws and adjust the point gap.

Tighten the locking screws and recheck the point gap.

Install the contact breaker point cover.

LOCKING SCREWS

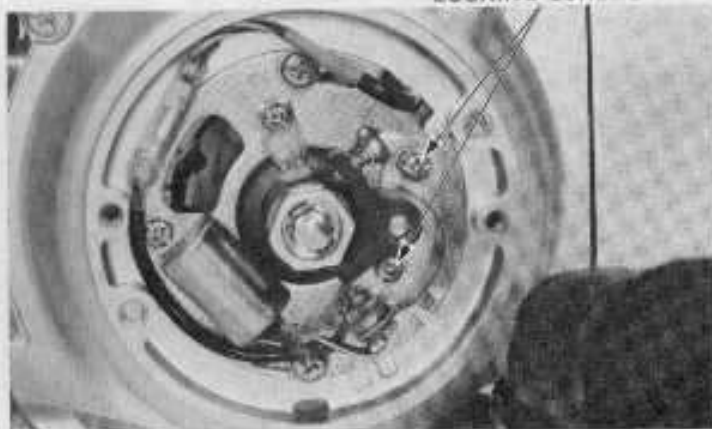



IGNITION TIMING

NOTE

Adjust the contact breaker point gap before this adjustment (page 3-7).

STATIC METHOD

Remove the contact breaker point cover.

Disconnect the Bk/W breaker terminal wire.

Connect a continuity light to the contact breaker terminal wire and to the positive (+) terminal of a fully charged battery.

Connect the negative (-) battery terminal to an engine ground.

Rotating the base plate counterclockwise will retard the ignition timing.

The timing is correct if the light goes out when both marks align.

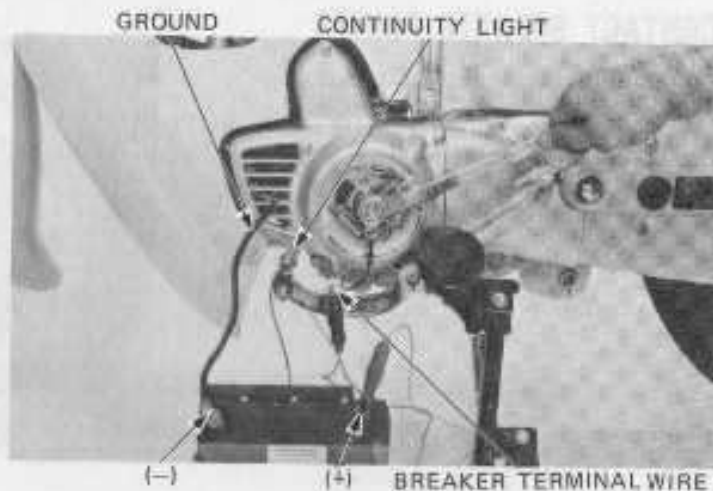

ADJUSTMENT

Adjust by loosening the two contact breaker base plate screws and rotating the plate.

Rotating the base plate clockwise will advance the ignition timing.

Rotating the base plate counterclockwise will retard the ignition timing.

Tighten the base plate screw and recheck the ignition timing and point gap.

Disconnect the light and battery.

Connect the Bk/W breaker terminal wire.

Install the contact breaker point cover.

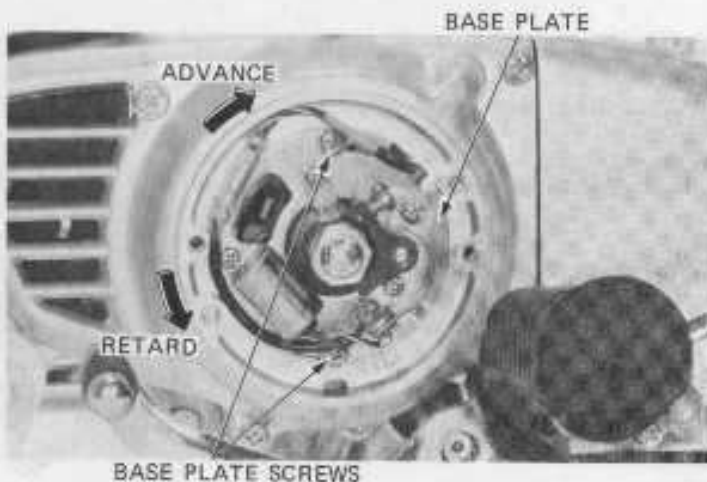
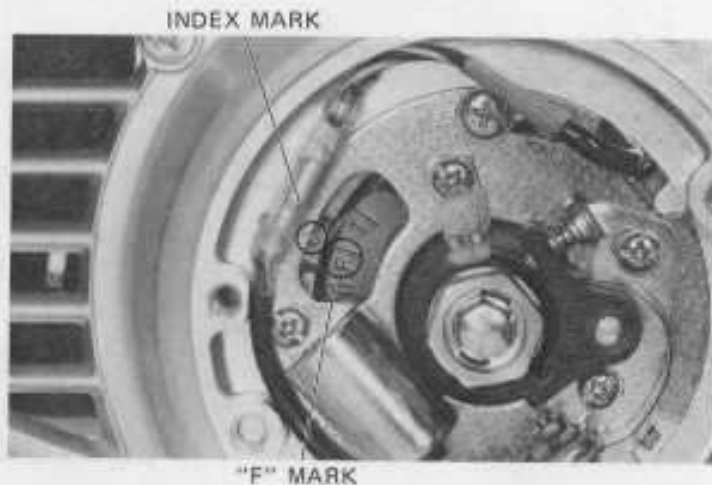



DYNAMIC METHOD (WITH A TIMING LIGHT)

NOTE

Adjust the contact breaker point gap before making this adjustment.

Remove the contact breaker point cover.

Connect a tachometer and timing light.

Start the engine and let it idle 2-3 minutes.
Adjust the idle speed if necessary.

IDLE SPEED: 1,500 ± 100 rpm

Aim the timing light at the timing mark.
The timing is correct if the "F" mark aligns with the index mark.

Adjust as described for the static method, if necessary.

Install the contact point cover.

SPARK ADVANCER

Remove the contact point cover.

Connect a timing light and tachometer.

Start the engine.

Bring engine speed to 3,100 rpm and check that the index mark is between the full advance marks.

Replace the advancer assembly if it is not functioning properly.

Install the contact breaker point cover.

CAM CHAIN TENSION

Start the engine and let it idle.

Loosen the cam chain tensioner lock nut and lock bolt.

The tensioner will automatically position itself to provide the correct tension.

If the chain is still noisy remove the tensioner plug.
Gradually screw in the tensioner adjusting screw until the cam chain is no longer noisy.
Install the tensioner plug.

Tighten the tensioner lock bolt and nut.

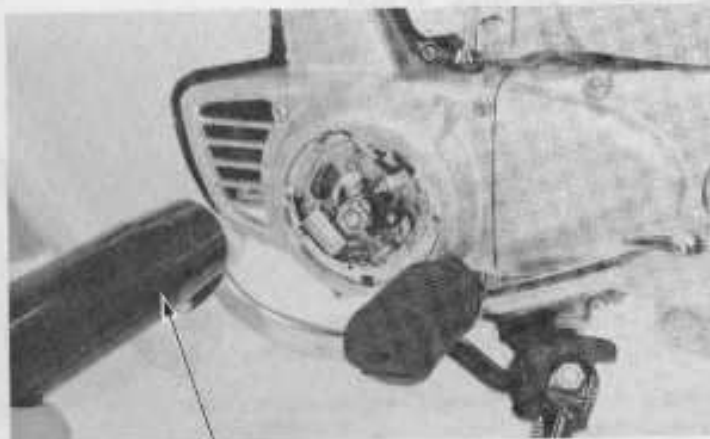

TIMING LIGHT

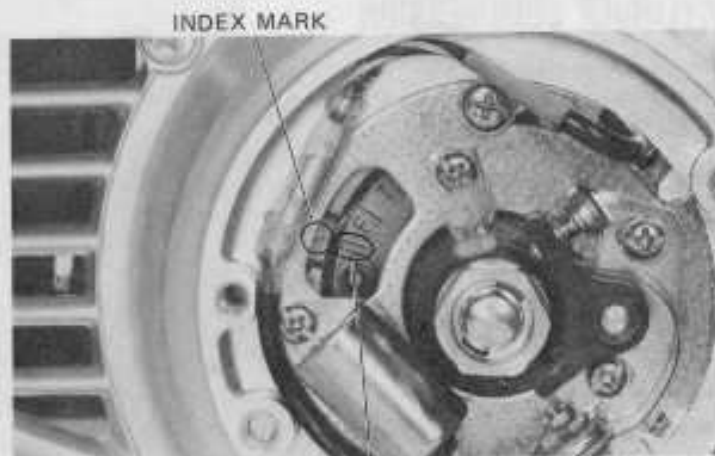

INDEX MARK

ADVANCE MARKS

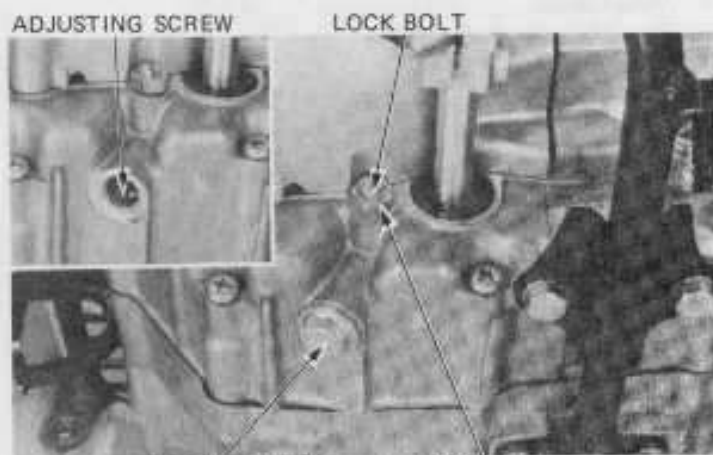

ADJUSTING SCREW

LOCK BOLT

TENSIONER PLUG

LOCK NUT



CARBURETOR IDLE SPEED

NOTE

- Inspect and adjust carburetor idle speed after all other engine adjustments are within specification.
- The engine must be warm for accurate idle inspection and adjustment. Ten minutes of stop and go riding is sufficient.

Connect a tachometer.

Warm up the engine, shift the transmission to NEUTRAL, and hold the motorcycle upright.

Inspect and adjust idle speed with the throttle stop screw, if necessary.

IDLE SPEED: $1,500 \pm 100$ rpm



THROTTLE STOP SCREW

CYLINDER COMPRESSION

Warm up the engine.

Stop the engine and remove the spark plug.
Insert the compression gauge.

Push the choke knob in.

Open the throttle grip fully.

Crank the engine with the starter motor.

NOTE

Crank the engine until the gauge reading stops rising. The maximum reading is usually reached within 4-7 seconds.

COMPRESSION PRESSURE: 12.5 ± 0.5 kg/cm²
(178 ± 7 psi)

Low compression can be caused by:

- Improper valve adjustment
- Valve leakage
- Blown cylinder head gasket
- Worn piston ring or cylinder

High compression can be caused by:

- Carbon deposits in combustion chamber or on the piston crown.



COMPRESSION GAUGE



<CHASSIS>
DRIVE CHAIN

INSPECTION

Place the vehicle on its side stand and shift the transmission into neutral.

Turn the ignition switch OFF.

Remove the drive chain inspection hole cap.

Move the drive chain up and down by hand and measure the amount of slack.

SLACK: 15–25 mm (5/8–1 in)

Adjust if necessary.

ADJUSTMENT

Remove the rear axle nut cotter pin and loosen the axle and sleeve nuts.

Turn the adjusting nuts on both sides an equal number of turns to obtain the specified chain slack.

CAUTION:

Be sure that the index mark on the chain adjuster aligns with the same graduation on both sides of the swingarm.

Tighten the sleeve and axle nuts and install a new cotter pin.

TORQUE:

SLEEVE NUT: 4.0 – 5.0 kg-m (29 – 36 ft-lb)

AXLE NUT: 4.0 – 5.0 kg-m (29 – 36 ft-lb)

Tighten the adjusting nuts.

Recheck drive chain slack and free wheel rotation.

Check brake pedal free play and adjust if necessary. Lubricate the drive chain with a commercially available drive chain lubricant through the inspection hole.

CLEANING

When the drive chain becomes extremely dirty, it should be removed and cleaned prior to lubrication as follows:

Remove the frame left side cover.

Remove the drive sprocket cover.

Remove the two lower chain case bolts and lower chain case.

Remove the upper chain case.

Remove the axle nut cotter pin and loosen the axle nut, sleeve nut and adjusting nuts.

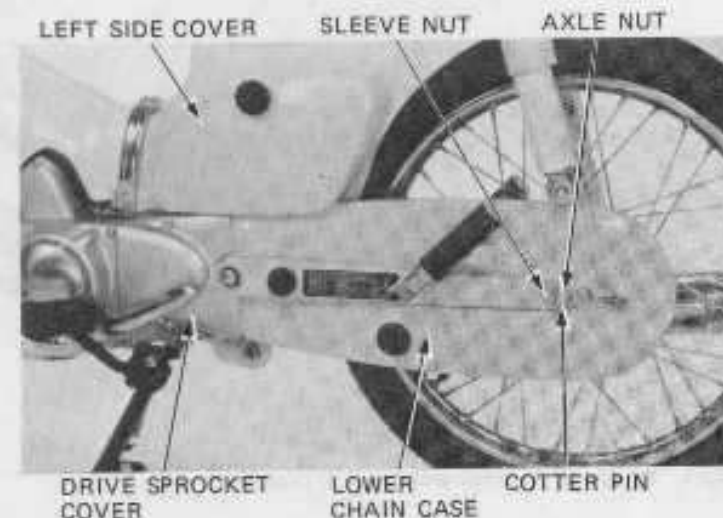
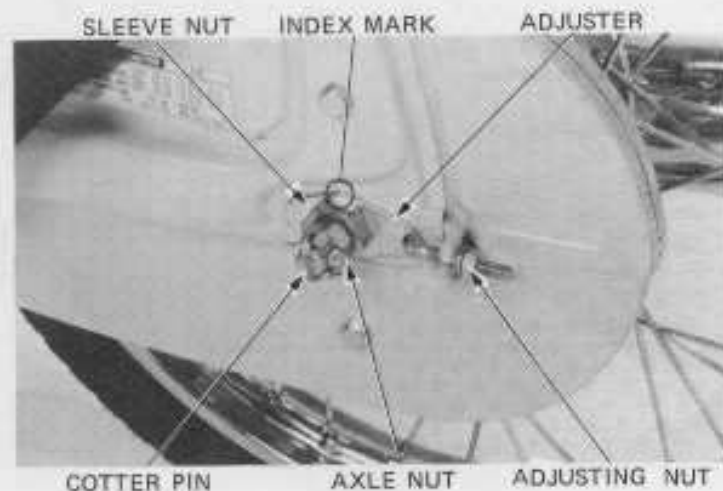
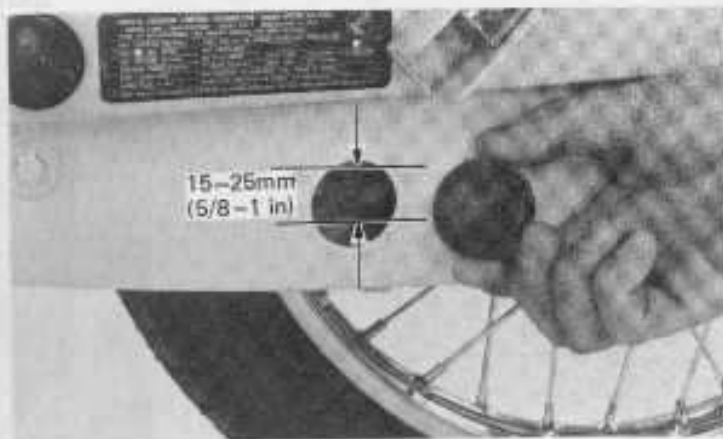



Remove the master link retaining clip and master link.

Remove the drive chain.

Clean the drive chain in non-flammable or high flash point solvent with a brush and allow it to dry.

Inspect the drive chain for wear or damage. Replace any chain that is excessively worn or damaged.

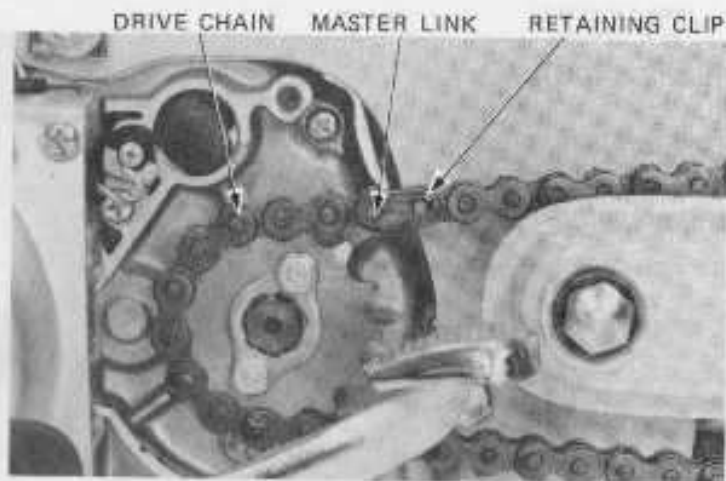

Inspect the drive and driven sprocket teeth for excessive wear or damage.

Replace if necessary.

NOTE

Never install a new drive chain on worn sprockets or a worn chain on new sprockets. Both chain and sprockets must be in good condition, or the replacement chain or sprockets will wear rapidly.

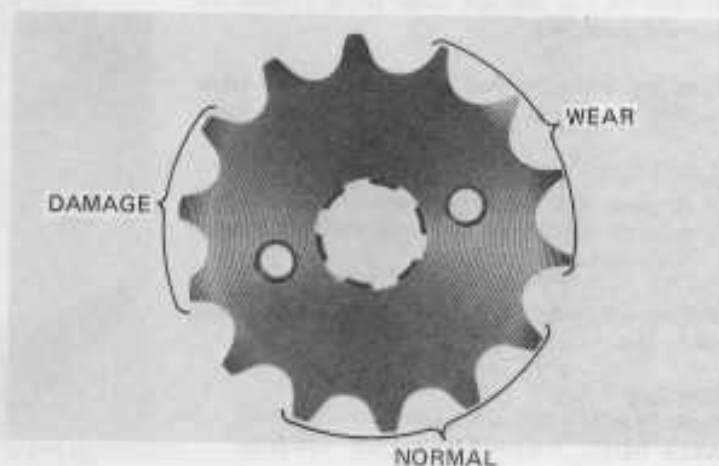

Lubricate the drive chain.

NOTE

Commercial aerosol type drive chain lubricant is recommended.

Install the drive chain.

NOTE

Note the direction of the master link retaining clip.

Install the upper and lower chain cases, drive sprocket cover and left side cover.

Adjust drive chain slack (page 3-11).

Check brake pedal free play and adjust, if necessary.

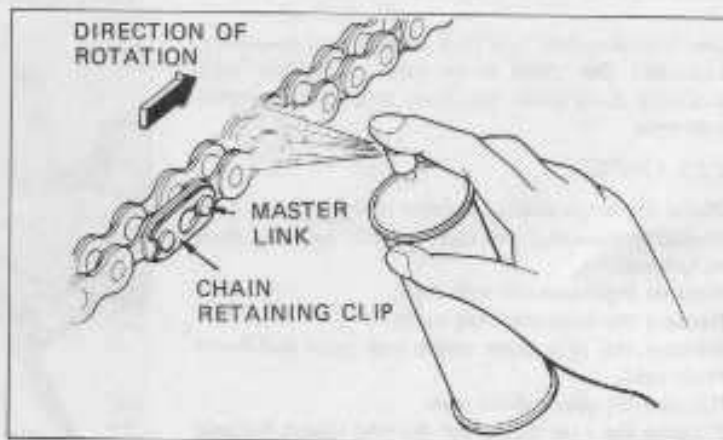



BATTERY

Remove the right side cover.

Disconnect the ground cable at the frame.

Disconnect the positive cable at the battery terminal.

Remove the battery holder plate.

Remove the battery.

Inspect the battery fluid level.

When the fluid level nears the lower level, refill with distilled water to the upper level.

NOTE

Add only distilled water. Tap water will shorten the service life of the battery.

WARNING

The battery electrolyte contains sulfuric acid. Protect your eyes, skin, and clothing. In case of contact, flush thoroughly with water and contact a doctor if electrolyte gets in your eyes.

Replace the battery, if sulfation forms or sediments accumulate on the bottom.



BRAKE SHOE WEAR

Replace the brake shoes if the arrow on the indicator plate aligns with the "Δ" mark on the brake panel when the brake is applied.

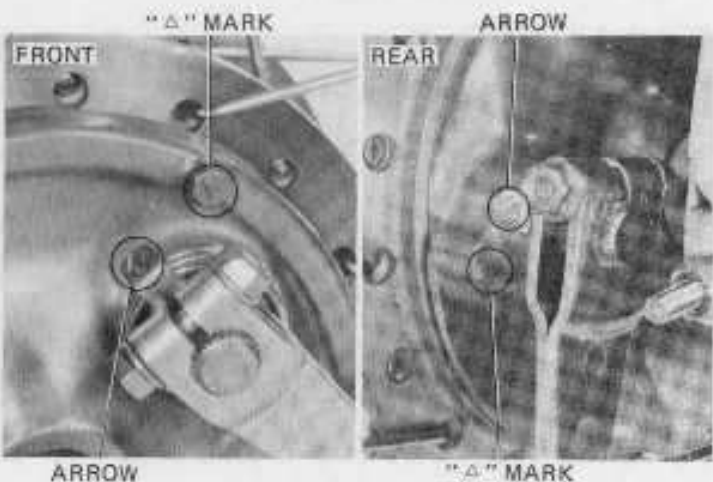

BRAKE SYSTEM

FRONT BRAKE LEVER FREE PLAY

Measure the front brake lever free play at the tip of the brake lever.

FREE PLAY: 20–30 mm (3/4–1 1/4 in)

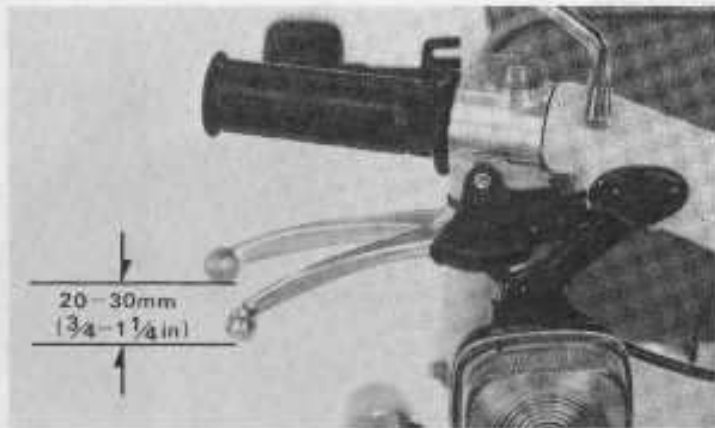

If adjustment is necessary, turn the adjusting nut until the correct free play is obtained.

NOTE

Make sure the cut-out on the adjusting nut is seated on the brake arm pin after making final free play adjustment.



ADJUSTING NUT

REAR BRAKE PEDAL FREE PLAY

Check the brake pedal free play.

FREE PLAY: 20–30 mm (3/4–1 1/4 in)

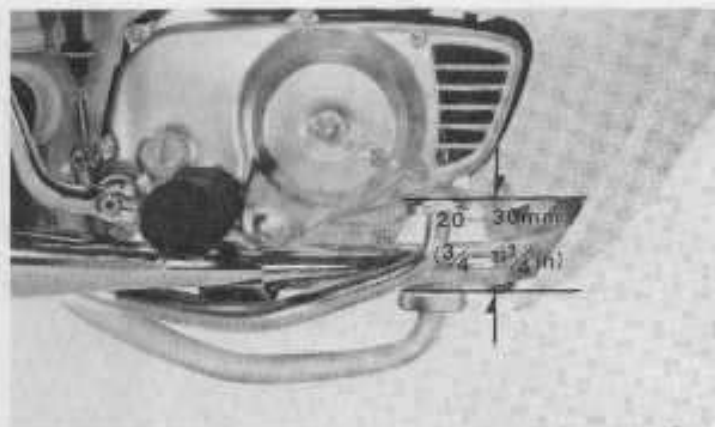



If adjustment is necessary, turn the adjusting nut until the correct free play is obtained.

NOTE

Make sure the cut-out on the adjusting nut is seated on the brake arm pin after making the final free play adjustment.

BRAKE LINKAGE

Check the brake cable, brake rod, brake pedal and brake lever for loose connections, excessive play, or damage.

Replace or repair if necessary.



ADJUSTING NUT

BRAKE LIGHT SWITCH

NOTE

Perform this adjustment after adjusting brake pedal free play.

Adjust the brake light switch so that the brake light will light when the brake pedal is depressed and the brake begins engagement.

NOTE

- Do not turn the switch body.
- The front brake light switch does not require adjustment.

Adjust by turning the switch adjusting nut.

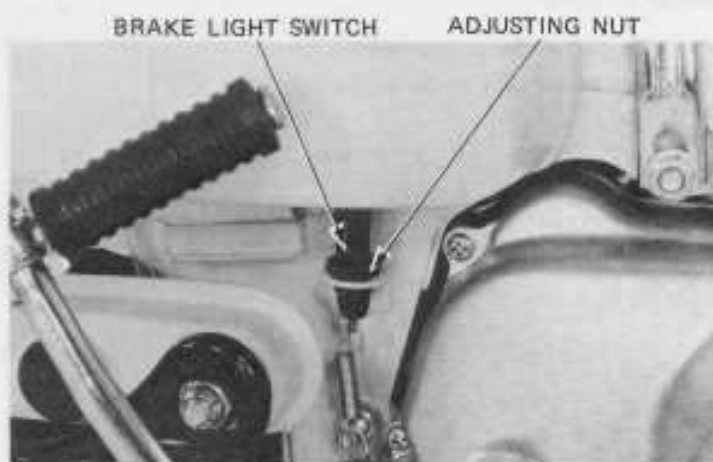

HEADLIGHT AIM

Adjust vertically by turning the vertical adjusting screw.

Turn the adjusting screw clockwise to direct the beam up.

Adjust horizontally by turning the horizontal adjusting screw.

Turn the adjusting screw clockwise to direct the beam toward the left side of the rider.

NOTE

Adjust the headlight beam as specified by local laws and regulations.

WARNING

An improperly adjusted headlight may blind oncoming drivers, or it may fail to light the road for a safe distance.



VERTICAL ADJUSTING SCREW

CLUTCH

Stop the engine.

Loosen the adjuster lock nut and turn the clutch adjuster clockwise one turn; do not turn excessively. Slowly turn the adjuster counterclockwise and stop when resistance is felt.

From this point, turn the adjuster clockwise 1/8 to 1/4 turn, and tighten the lock nut.

Check to see that the clutch is not slipping and is properly disengaging.

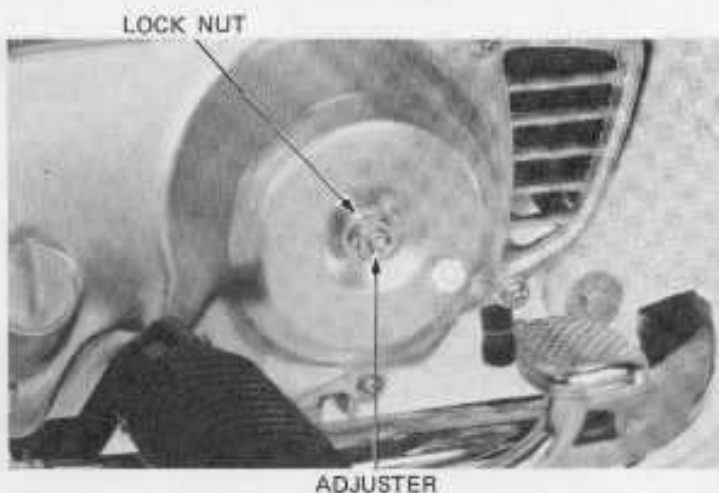

SIDE STAND

Check the rubber pad for deterioration or wear.

Replace if any wear exceeds to the wear line as shown.

NOTE

When replacing, use a rubber pad with the mark "BELOW 259 lbs ONLY".

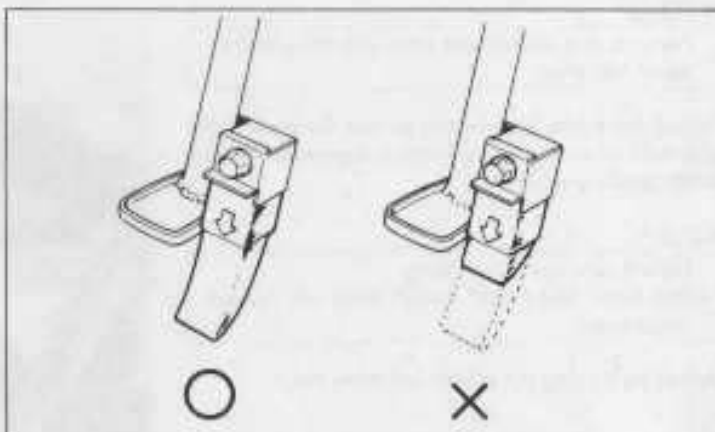

Check the side stand spring for damage and loss of tension, and the side stand assembly for freedom of movement and bending.

NOTE

Spring tension is correct if the measurements fall within 1.5–2.5 kg (3.3–5.5 lb) when pulling the side stand lower end with a spring scale.

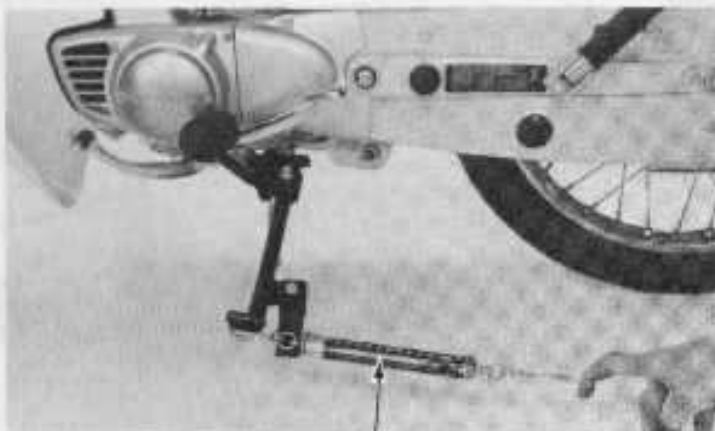

SPRING SCALE



SUSPENSION

WARNING

Do not ride a vehicle with faulty suspension. Loose, worn or damaged suspension parts impair vehicle stability and control.

FRONT

Check the action of the front forks.

Replace damaged components which cannot be repaired.

Tighten all nuts and bolts.



Lubricate the suspension arm pivots.



GREASE FITTINGS

REAR

Place the motorcycle on a support to raise the rear wheel off the ground.

Move the rear wheel sideways with force to see if the swingarm bushings are worn. Replace if excessively worn.

Check the shock absorbers for leaks or damage.

Tighten all rear suspension nuts and bolts.

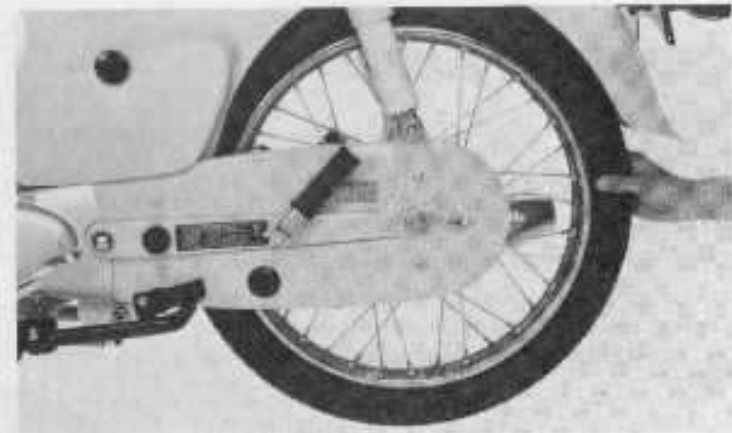



NUTS, BOLTS, FASTENERS

Check that all chassis nuts and bolts are tightened to correct torque values.

Check all cotter pins and safety clips.

WHEELS/SPOKES

NOTE

Tire pressure should be checked when tires are COLD.

RECOMMENDED TIRE PRESSURE AND TIRE SIZE:

		Front	Rear
Tire size		2.25-17-4PR	2.50-17-6PR
Cold tire pressure kg/cm ² (psi)	Up to vehicle capacity Load (135 kg, 300 lb)	2.0 (28)	2.8 (40)
	Up to 90 kg (200 lb) load	2.0 (28)	2.0 (28)

Check the tires for cuts, imbedded nails, or other sharp objects.

Check the front and rear wheels for trueness.

Measure the tread depth at the center of the tires.

Replace the tires if the tread depth reaches the following limit.

MINIMUM TREAD DEPTH:

FRONT: 1.5 mm (1/16 in)

REAR: 2.0 mm (3/32 in)

Retighten the wheel spokes periodically.

STEERING HEAD BEARINGS

NOTE

Check that the control cables do not interfere with handlebar rotation.

Raise the front wheel off the ground.

Check that the handlebar rotates freely.

If the handlebar moves unevenly, binds, or has vertical movement, adjust the steering head bearings by turning the steering head adjusting nut (page 12-18).

GAUGE

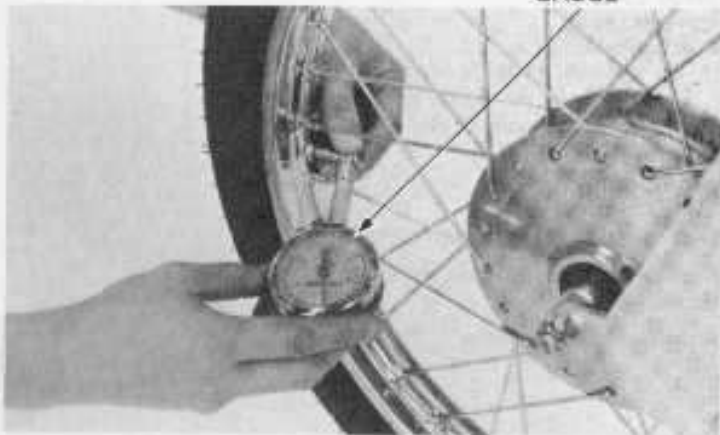

SPOKE NIPPLE SPANNER B, 4.5 x 5.1mm



HEAD BEARINGS



HONDA
C70

5/75/80 12/79

MEMO

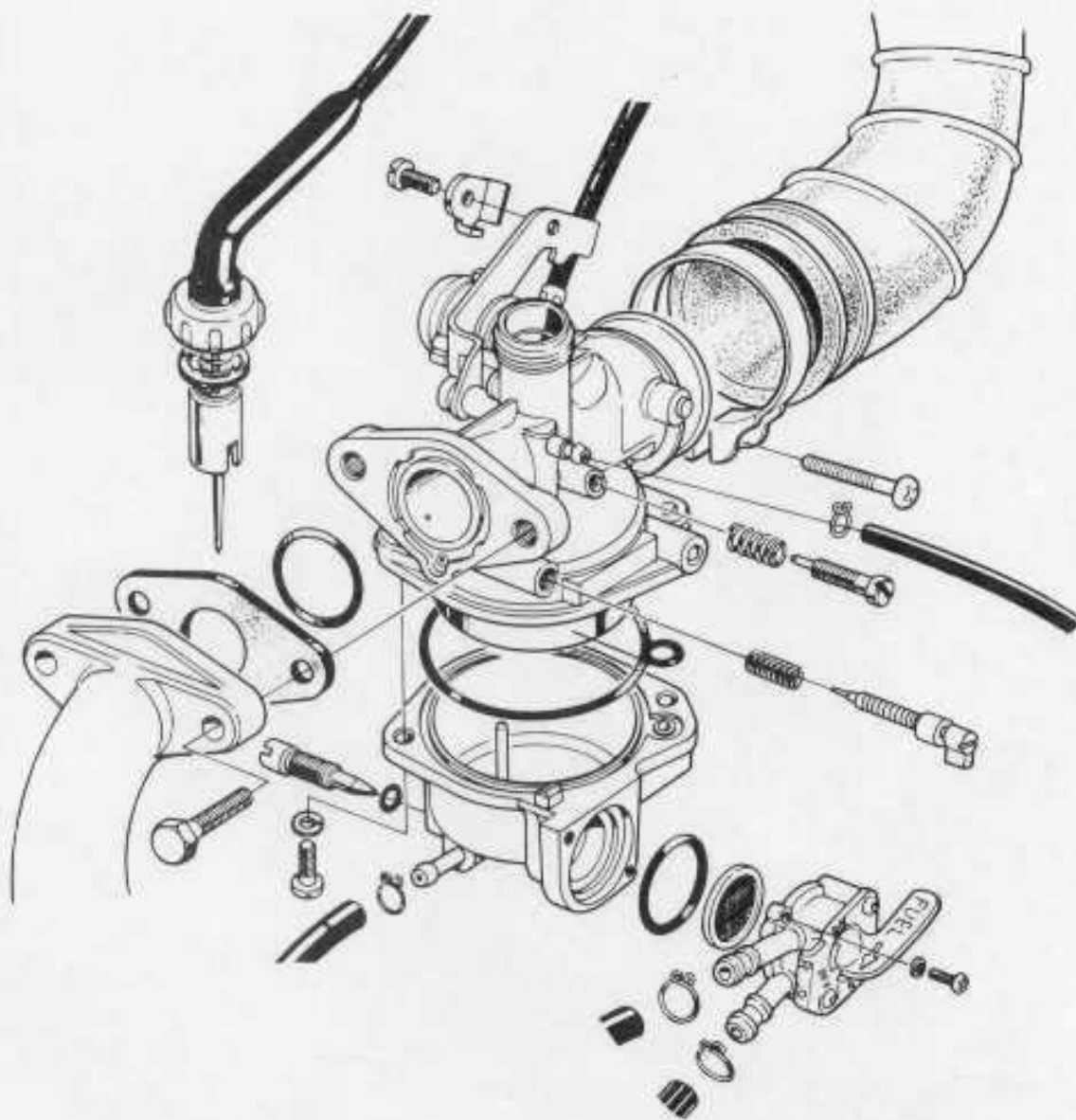



SERVICE INFORMATION	4-1	THROTTLE VALVE ASSEMBLY	4-5
TROUBLESHOOTING	4-1	CARBURETOR INSTALLATION	4-6
CARBURETOR REMOVAL	4-2	FUEL STRAINER	4-6
THROTTLE VALVE DISASSEMBLY	4-2	PILOT SCREW	4-7
FLOAT AND JETS	4-3	HIGH ALTITUDE ADJUSTMENT	4-8
CARBURETOR ASSEMBLY	4-4	FUEL TANK	4-9
FLOAT LEVEL	4-5		

SERVICE INFORMATION

GENERAL INSTRUCTIONS

- Use caution when working with gasoline. Always work in a well-ventilated area and away from sparks or open flames.
- When disassembling fuel system parts, note the locations of the O-rings. Replace them with new ones on reassembly.
- The float bowl has a drain plug that can be loosened to drain residual gasoline.

TOOL

Common

Float gauge 07401-0010000

SPECIFICATIONS

	1980	1981
Venturi dia.	14 mm (0.55 in)	←
Identification No.	PB32A	PB32C
Float level	10.7 mm (0.42 in)	←
Main jet	#90	#88
Slow jet	#35	←
Throttle valve	#2.5	←
Jet needle	72A	72C
Throttle grip free play	2 - 6 mm (1/8 - 1/4 in)	←
Pilot screw initial opening	See page 4-7	←

TROUBLESHOOTING

Engine cranks but won't start

1. No fuel in tank
2. No fuel to carburetor
3. Engine flooded with fuel
4. No spark at plug (ignition malfunction)
5. Air cleaner clogged
6. Intake air leak
7. Improper choke operation
8. Improper throttle operation

Hard starting or stalling after starting

1. Improper choke operation
2. Ignition malfunction
3. Carburetor malfunction
4. Fuel contaminated
5. Intake air leak
6. Idle speed incorrect

Rough idle

1. Ignition malfunction
2. Idle speed incorrect
3. Carburetor malfunction
4. Fuel contaminated

Misfiring during acceleration

1. Ignition malfunction

Backfiring

1. Ignition malfunction
2. Carburetor malfunction

Poor performance (drivesability) and poor fuel economy

1. Fuel system clogged
2. Ignition malfunction

Lean mixture

1. Clogged fuel jets
2. Faulty float valve
3. Float level low
4. Fuel cap vent blocked
5. Fuel strainer screen clogged
6. Restricted fuel line
7. Intake air leak
8. Air vent tube clogged

Rich mixture

1. Clogged air jets
2. Faulty float valve
3. Float valve too high
4. Choke stuck closed
5. Dirty air cleaner



CARBURETOR REMOVAL

Turn the fuel valve OFF.

Drain residual fuel into a container by loosening the drain screw.

Remove the fuel valve from the carburetor.

Loosen the choke cable clamp and disconnect the choke cable.

Loosen the air cleaner connecting tube band.

Remove the bolts securing the carburetor to the intake pipe.

Unscrew the carburetor top and pull the throttle valve out.

Remove the carburetor mounting bolts and carburetor.

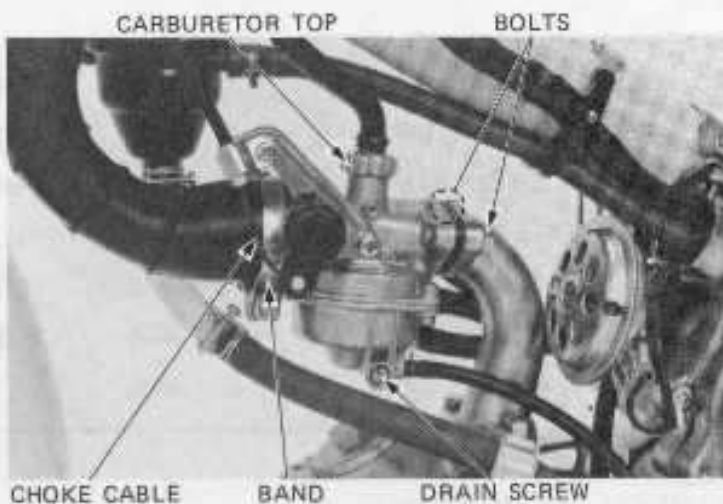

THROTTLE VALVE DISASSEMBLY

Remove the carburetor top and throttle valve.



THROTTLE VALVE

Compress the throttle valve spring and remove the throttle cable from the throttle valve groove.

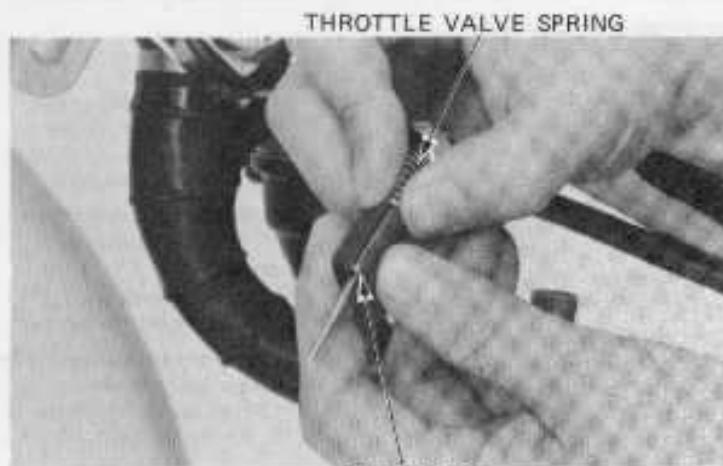

CABLE END



Remove the needle clip retainer.
Remove the jet needle and clip.
Inspect the throttle valve and jet needle for dirt, scratches or wear.

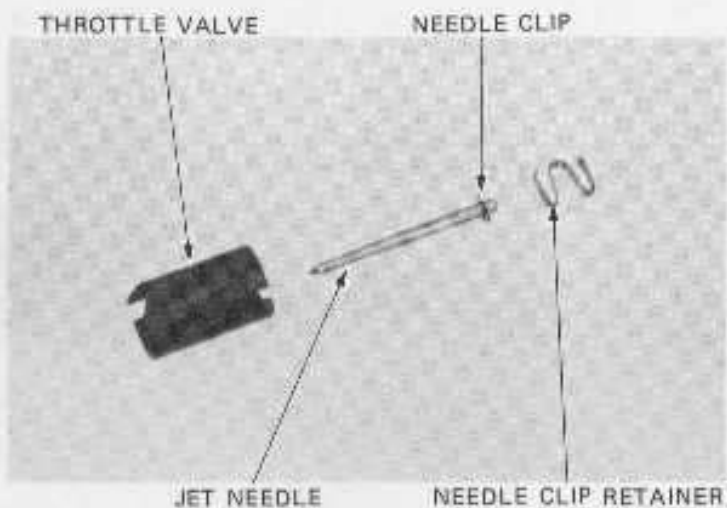

FLOAT AND JETS

Remove the float chamber and pull out the float pin.
Remove the float and float valve.

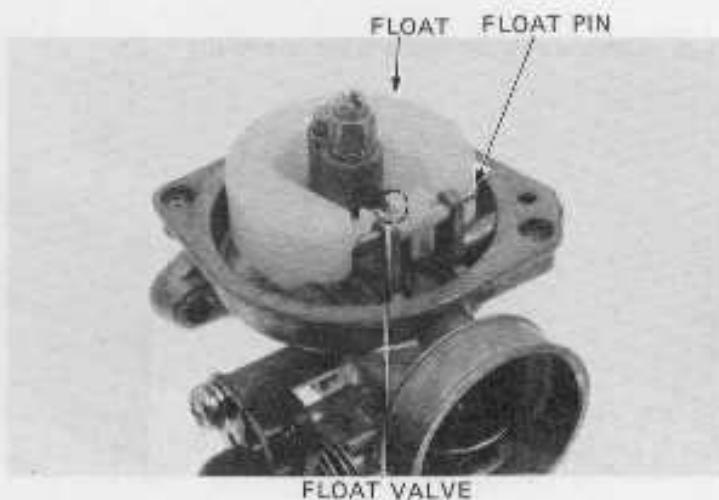

Inspect the float valve and seat for grooves, nicks or deposits.

Inspect the float valve operation.

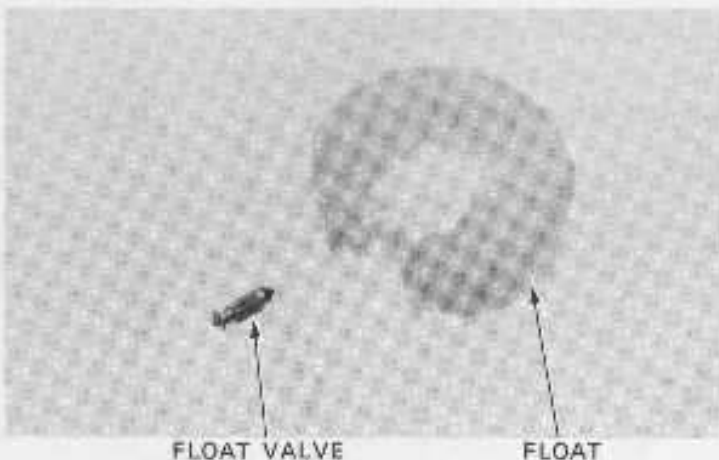

Remove the main jet, needle jet holder and needle jet.

NOTE

The slow air jet cannot be removed. It is a press fit.

NEEDLE JET HOLDER MAIN JET SLOW JET

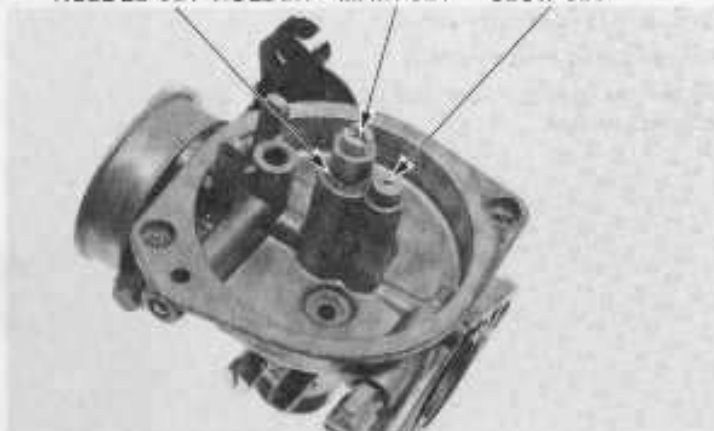

Blow all jets and body passages with compressed air.



CARBURETOR ASSEMBLY

Install the needle jet, needle jet holder and main jet.
Install the float and float valve together.

NOTE

Take care not to damage the jets when installing.

FLOAT NEEDLE JET HOLDER MAIN JET



FLOAT VALVE FLOAT PIN



FLOAT LEVEL

Remove the float chamber.

Measure the float level with the float tip just contacting the float valve.

FLOAT LEVEL: 10.7 mm (0.42 in)

Replace the float, if the float level is not within specification.

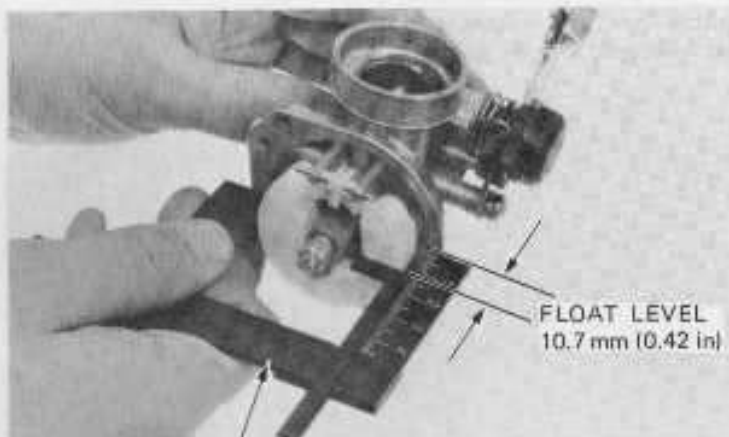

FLOAT LEVEL GAUGE
07401-0010000

FLOAT LEVEL
10.7 mm (0.42 in)

THROTTLE VALVE ASSEMBLY

Install the clip on the jet needle.

Install the jet needle into the throttle valve and clamp it with the needle clip retainer.

NOTE

Install the needle clip retainer so it rests on the throttle valve bottom.

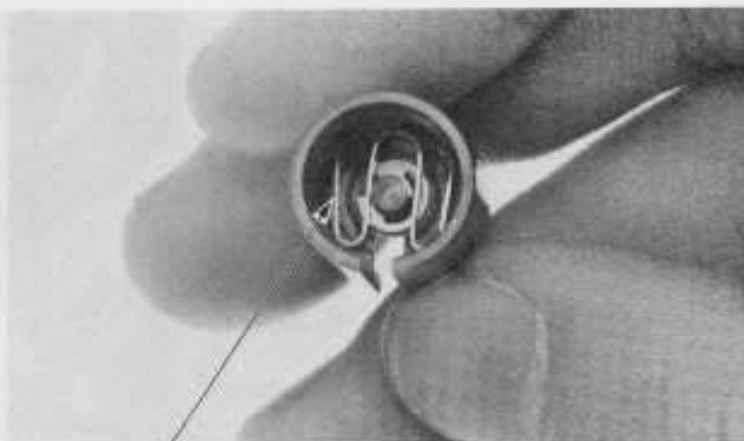

NEEDLE CLIP
RETAINER

THROTTLE VALVE
SPRING

Compress the throttle valve spring and install the cable into the valve.



CABLE END



Install the throttle valve with the throttle valve groove aligned with the throttle stop screw.

THROTTLE VALVE GROOVE

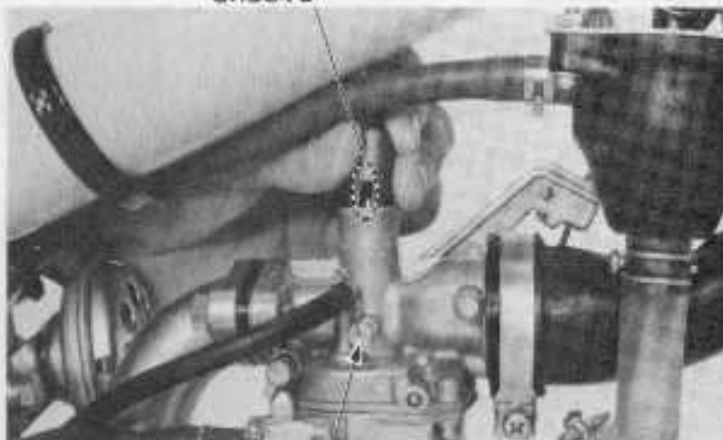

THROTTLE STOP SCREW

CARBURETOR INSTALLATION

The installation sequence is essentially the reverse of removal.

NOTE

- When installing the throttle valve, align the throttle valve groove with the throttle stop screw.
- Clamp the choke cable end on the cable clamp.

Perform the following inspections and adjustments.

- Throttle operation (page 3-3)
- Carburetor choke (page 3-4)
- Carburetor idle speed (page 3-10)



CHOKE CABLE CLAMP

FUEL STRAINER

Turn the fuel valve OFF.

Drain the carburetor by loosening the drain screw.

Remove the fuel valve, O-ring and strainer.

Clean the strainer.

Install the strainer, O-ring and fuel valve.

O-RING FUEL STRAINER

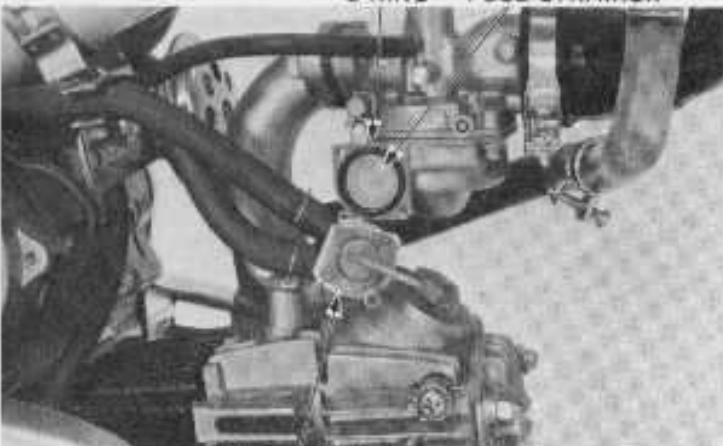

FUEL VALVE



PILOT SCREW

REMOVAL/INSTALLATION

NOTE

The pilot screw is factory pre-set and should not be removed unless the carburetor is overhauled.

Remove the carburetor.

Remove the float chamber.

Turn the pilot screw in and carefully count the number of turns before it seats lightly.

Make a note of this to use as a reference when installing the pilot screw.

CAUTION:

Damage to the pilot screw and seat will occur if the pilot screw is tightened against the seat.

Remove the pilot screw with the limiter cap attached.

CAUTION:

Any forcible attempt to remove the pilot screw limiter cap will break the screw.

Inspect the pilot screw for wear and replace if necessary.

Install the pilot screw and return it to its original position as noted during removal.

Perform pilot screw adjustment if a new pilot screw is installed.

NOTE

Do not install a limiter cap on a new pilot screw until after adjustment has been made (see below).

ADJUSTMENT

NOTE

The pilot screw is factory pre-set and no adjustment is necessary unless the pilot screw is replaced.

Turn the pilot screw clockwise until it seats lightly and back it out to the specification given. This is an initial setting prior to the final pilot screw adjustment.

INITIAL OPENING: 1980 - 2 turns out
1981 - 2 1/2 turns out

CAUTION:

Damage to the pilot screw and seat will occur if the pilot screw is tightened against the seat.

Warm the engine up to operating temperature.

Stop and go riding for 10 minutes is sufficient.

Connect a tachometer.

Adjust the idle speed with the throttle stop screw.

IDLE SPEED: 1,500 ± 100 rpm

Turn the pilot screw in or out to obtain the highest engine speed.

Readjust the idle speed to 1,500 ± 100 rpm, using the throttle stop screw.

PILOT SCREW WITH LIMITER CAP

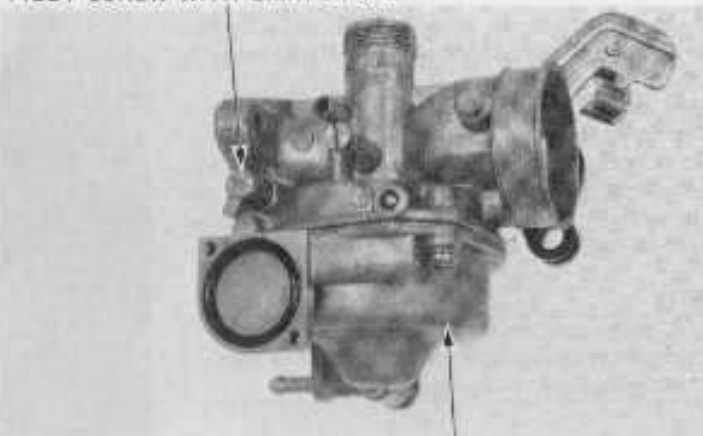

FLOAT CHAMBER



PILOT SCREW

LIMITER CAP INSTALLATION

If the pilot screw has been replaced, a new limiter cap must be installed after pilot screw adjustment is completed.

After adjustment, cement the limiter cap over the pilot screw, using LOCTITE® #601 or equivalent. The limiter cap should be placed against its stop, preventing further adjustment that would enrich the fuel mixture (limiter cap position permits clockwise rotation and prevents counterclockwise rotation).

NOTE

A pilot screw limiter cap must be installed. It prevents misadjustment that could cause poor performance and increase emissions.

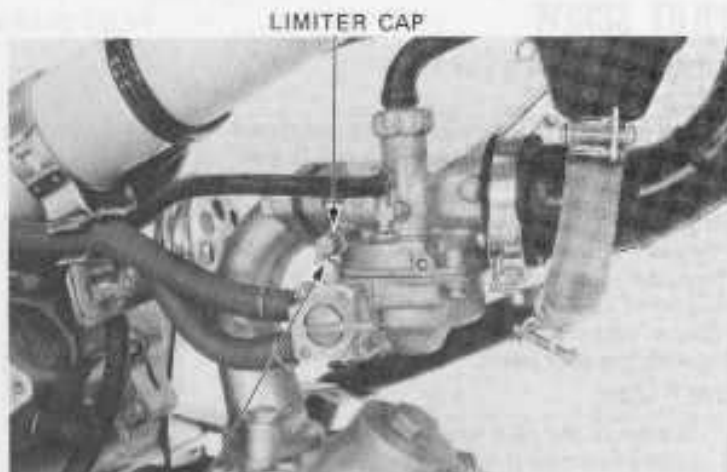

RICH SIDE

HIGH ALTITUDE ADJUSTMENT

For sustained high altitude operation (above 2,000 m/6,500 ft) install a #85 main jet and readjust idle speed.

Remove the carburetor from the engine and remove the float chamber.

Replace the standard main jet with the high altitude #85 main jet.

Assemble and install the carburetor.

Adjust idle speed to 1,500 ± 100 rpm, using the throttle stop screw.



MAIN JET

CAUTION:

Sustained operation at altitudes lower than 1,500 m (5,000 ft) with the high altitude main jet installed may cause engine overheating and damage. For sustained operation below 1,500 m (5,000 ft), reinstall the standard main jet and readjust idle speed.

	Standard 2,000 m (6,500 ft) max.	High altitude type 1,500 m (5,000 ft) min.
Main jet	1980: #90 1981: #88	#85
Idle speed	1,500 ± 100 rpm	←
Pilot screw opening	Factory pre-set	←



FUEL TANK

Turn the fuel valve to RES.

Loosen the drain screw and drain the fuel thoroughly.

Remove the right side cover and the battery.

Disconnect the fuel lines from the fuel tank.

WARNING

*Do not allow flames or sparks near gasoline.
Wipe up spilled gasoline at once.*

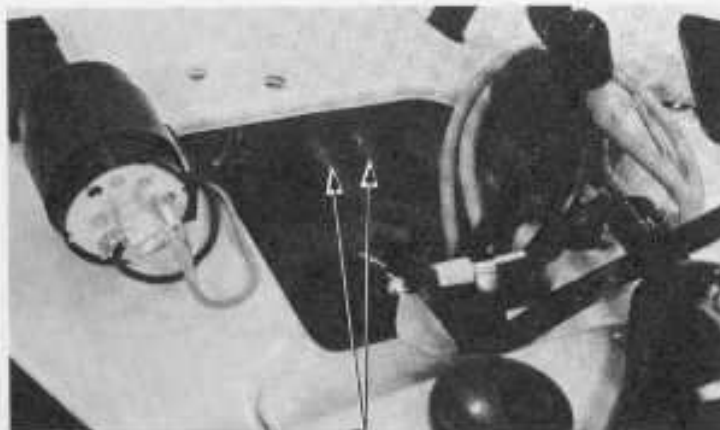

FUEL LINES

Remove the seat.

Remove the screw and bolt securing the fuel tank, then remove the fuel tank.

Install the fuel tank in the reverse order of removal.

Make sure there are no fuel leaks.

Check the vent holes of the filler cap for blockage.

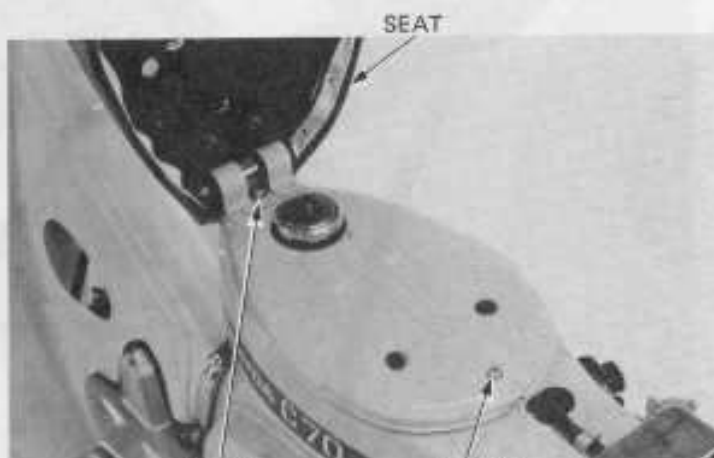

BOLT

SCREW

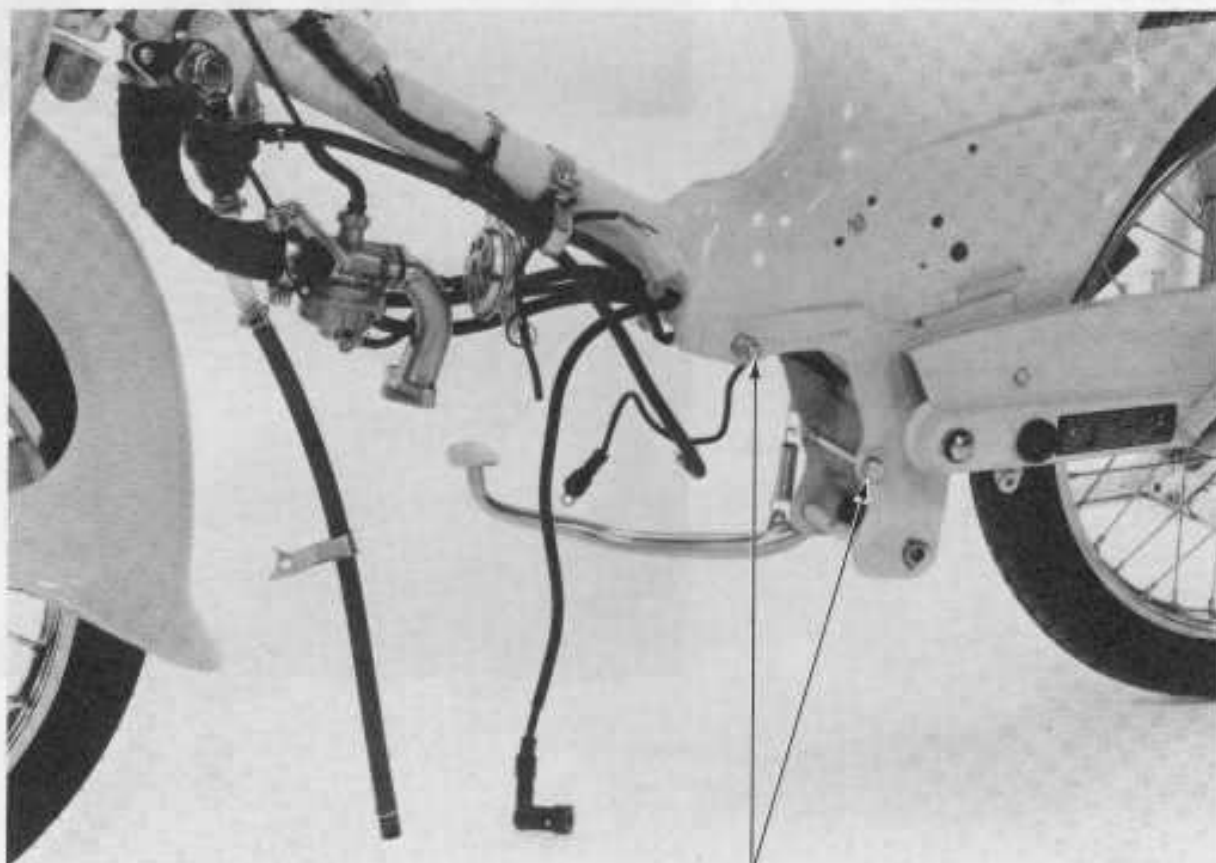

2.5-3.5 kg-m
(18-25 ft-lb)



SERVICE INFORMATION	5-1
ENGINE REMOVAL	5-2
ENGINE INSTALLATION	5-4

SERVICE INFORMATION

GENERAL INSTRUCTION

The following parts or components can be serviced with the engine installed in the frame.

- Clutch
- Gearshift linkage
- Oil pump
- Cylinder head
- Cylinder
- Piston
- A.C. generator
- Starter motor
- Carburetor

SPECIFICATIONS

Engine dry weight	18 kg (39.7 lb)
Oil capacity	0.7 lit (0.74 US qt, 0.62 Imp qt) at engine assembly 0.6 lit (0.65 US qt, 0.53 Imp qt) at change

TORQUE VALUES

Engine hanger bolts	2.5 - 3.5 kg-m (18 - 25 ft-lb)
Footpegs/side stand ass'y.	2.0 - 2.5 kg-m (14 - 18 ft-lb)

ENGINE REMOVAL

Drain the engine oil.
Remove the air cleaner cover and front cover band.
Remove the front cover.



Loosen the exhaust pipe setting nuts.
Remove the muffler mounting nuts and remove the muffler assembly.
Disconnect the starter cable.

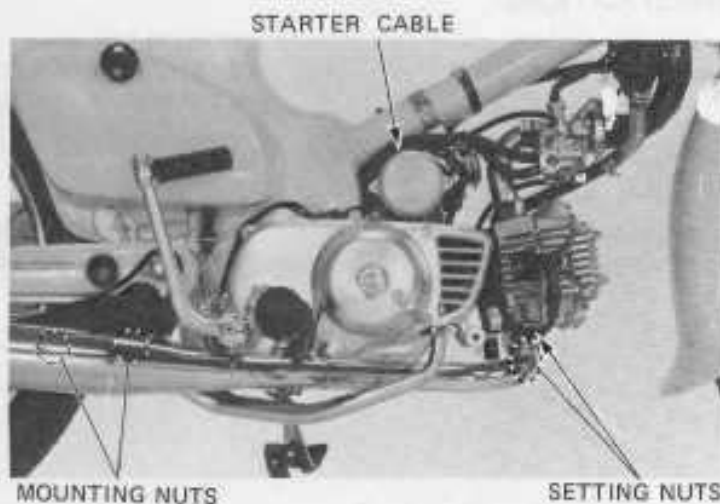

Support the motorcycle upright with a stand.
Remove the footpegs/side stand assembly.
Unhook the brake pedal return spring from the engine hanger bolt.

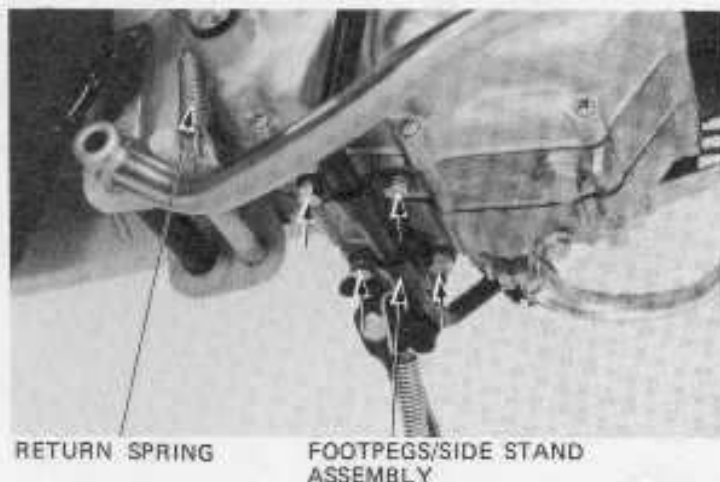



Remove the high tension wire from the spark plug and clamp.

Disconnect the intake pipe from the engine.

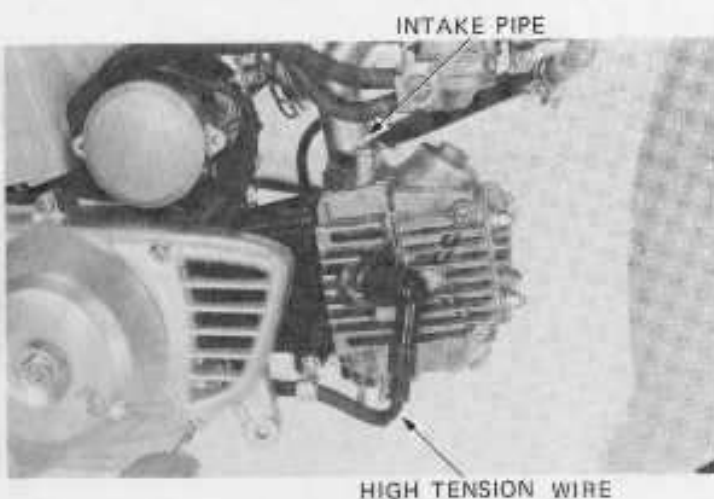

Remove the cotter pin and loosen the axle and sleeve nuts.

Loosen the drive chain adjusting nuts.

Remove the left side cover, engine sprocket cover and lower chain case.

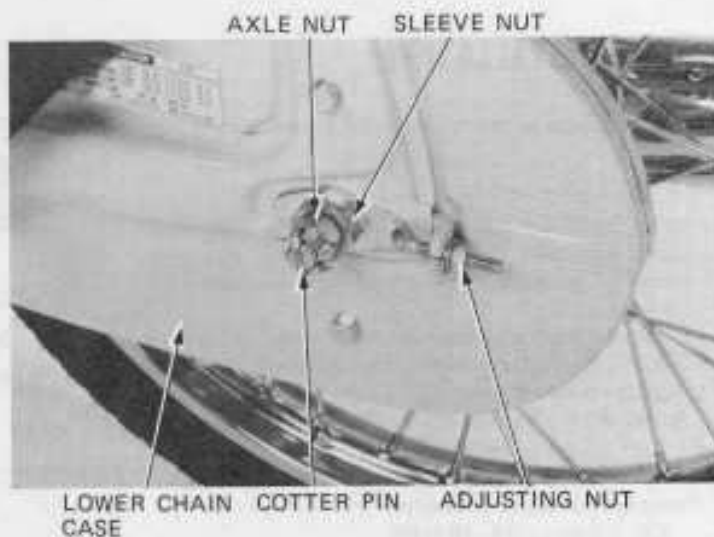

Remove the master link retaining clip and master link at the drive sprocket.

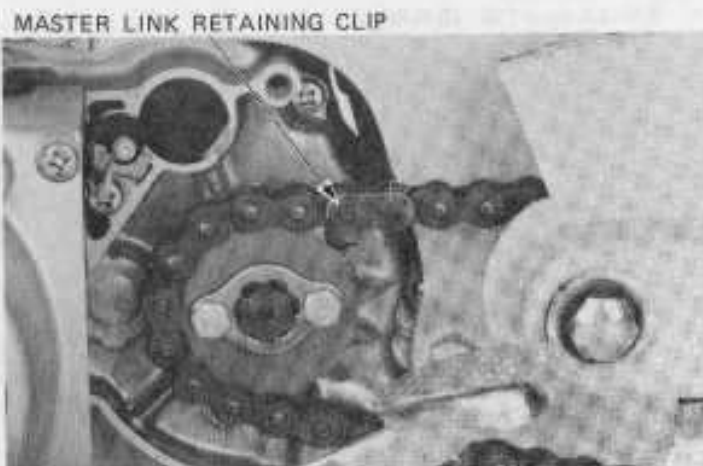



Disconnect the A.C. generator coupler.
Remove the breather hose from the separator and clamp.
Remove the two engine hanger bolts and remove the engine.

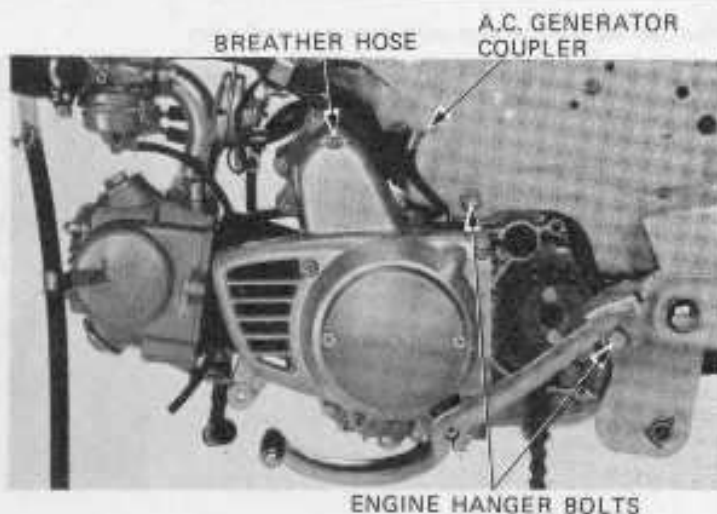

ENGINE INSTALLATION

Install the engine in the reverse order of removal.

NOTE

- When installing the drive chain master link, make sure that the retaining clip open end faces the opposite direction of normal chain rotation.
- Route the wires and cables properly (page 1-6).
- Fill the crankcase to the proper level with the recommended oil (page 2-2).
- Adjust the drive chain tension (page 3-11).

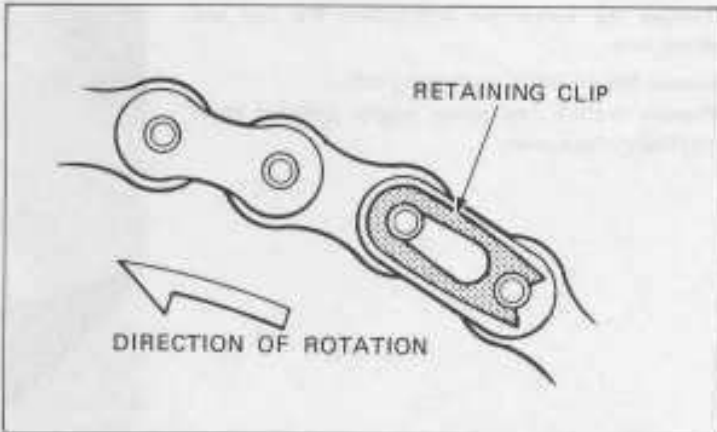

TORQUE VALUES:

- Footpegs/side stand assembly:
2.0–2.5 kg-m (14–18 ft-lb)
- Engine hanger bolts:
2.5–3.5 kg-m (18–25 ft-lb)

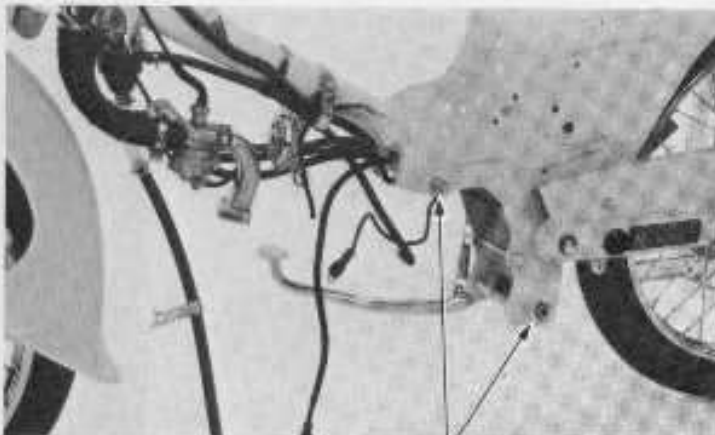

2.5–3.5 kg-m
(18–25 ft-lb)



MEMO



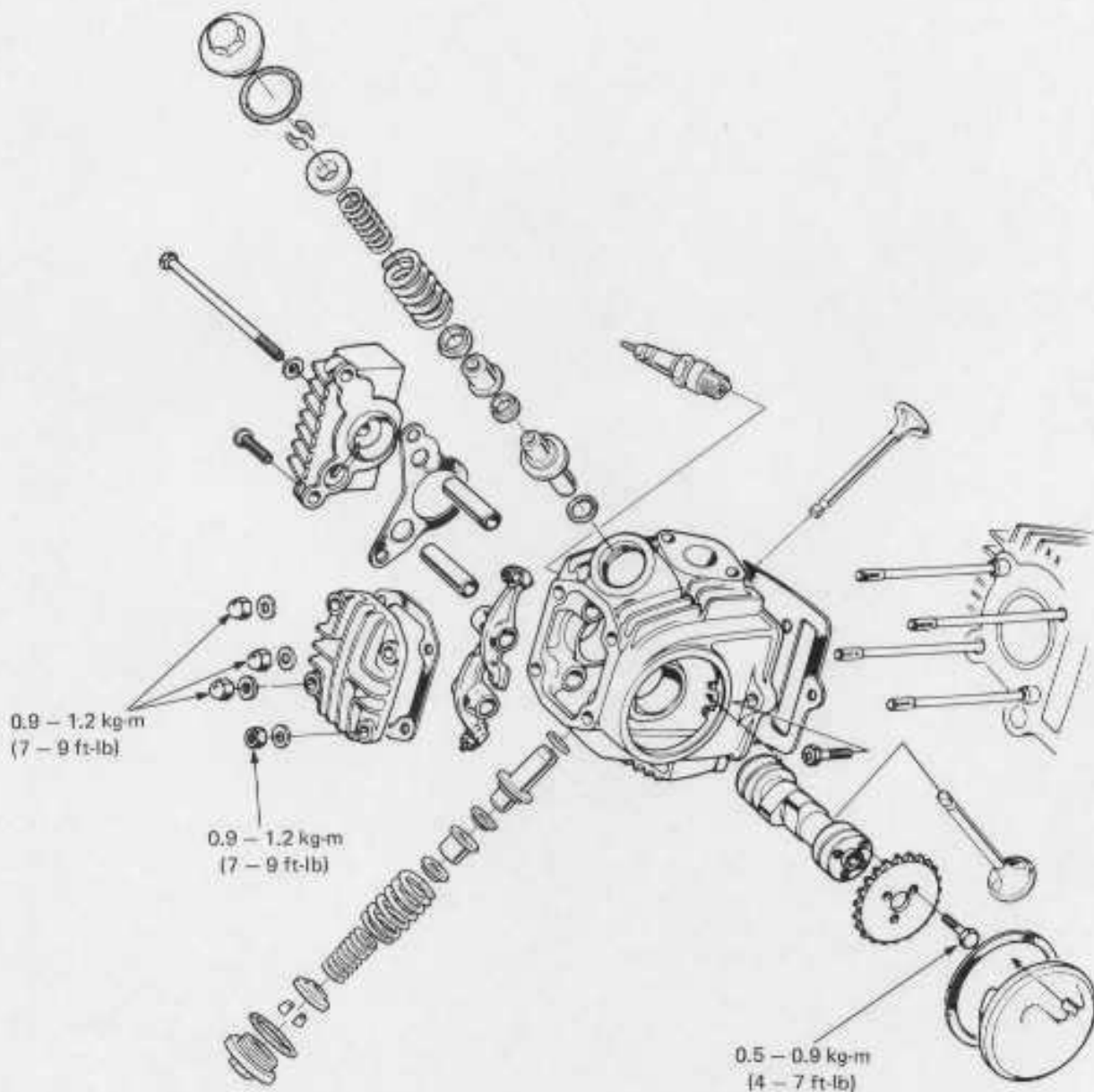

**HONDA**
C70

6. CYLINDER HEAD/VALVE

SERVICE INFORMATION	6-1	VALVE SEAT INSPECTION/ REFACING	6-10
TROUBLESHOOTING	6-2	CYLINDER HEAD ASSEMBLY	6-11
CYLINDER HEAD REMOVAL	6-3	CYLINDER HEAD INSTALLATION	6-13
CYLINDER HEAD DISASSEMBLY	6-4		
VALVE GUIDE REPLACEMENT	6-9		

SERVICE INFORMATION

GENERAL INSTRUCTIONS

- This section covers maintenance and inspection of the cylinder head, valves, camshaft and rocker arms. These services can be done with the engine installed.
- Camshaft and rocker arm lubricating oil is fed through oil passages. Be sure the passages are not clogged.
- During assembly, apply molybdenum disulfide grease to the camshaft bearings to provide initial lubrication.

TOOLS

Special

Valve Guide Reamer	07984-0980000
Valve Guide Driver	07942-1180100

Common

Valve Guide Remover, 5.5 mm	07742-0010100 or 07942-3290100
Valve Spring Compressor	07757-0010000 or 07957-3290001

TORQUE VALUES

Cylinder head	0.9 – 1.2 kg-m (7 – 9 ft-lb)
Cam chain sprocket	0.5 – 0.9 kg-m (4 – 7 ft-lb)

SPECIFICATIONS

			STANDARD	SERVICE LIMIT	
Compression pressure			12.5 ± 0.5 kg/cm ² (178 ± 7 psi)	—	
Camshaft	Cam height	IN.	26.07 mm (1.026 in)	25.69 mm (1.011 in)	
		EX.	26.07 mm (1.026 in)	25.69 mm (1.011 in)	
	Oil clearance		0.010 – 0.025 mm (0.0004 – 0.0010 in)	0.05 mm (0.002 in)	
	Side clearance		0.004 – 0.036 mm (0.0002 – 0.0014 in)	0.10 mm (0.004 in)	
Rocker arm shaft O.D.			9.978 – 9.989 mm (0.3928 – 0.3933 in)	9.91 mm (0.390 in)	
Rocker arm I.D.			10.000 – 10.015 mm (0.3937 – 0.3943 in)	10.10 mm (0.398 in)	
Valve spring	Free length	Inner	25.1 mm (0.99 in)	23.9 mm (0.94 in)	
		Outer	28.1 mm (1.11 in)	26.9 mm (1.06 in)	
	Preload/length		Inner	2.45 – 2.75 kg/22.7 mm (5.401 – 6.063 lbs/0.89 in)	2.3 kg/22.7 mm (5.07 lbs/0.89 in)
			Outer	6.65 – 7.75 kg/24.9 mm (14.661 – 17.086 lbs/0.98 in)	6.3 kg/24.9 mm (13.89 lbs/0.98 in)
Valve guide/ valve	Valve stem O.D.	IN.	5.455 – 5.465 mm (0.2148 – 0.2152 in)	5.400 mm (0.2126 in)	
		EX.	5.435 – 5.445 mm (0.2140 – 0.2144 in)	5.400 mm (0.2126 in)	
	Valve guide I.D.	IN.	5.475 – 5.485 mm (0.2156 – 0.2159 in)	5.500 mm (0.2165 in)	
		EX.	5.475 – 5.485 mm (0.2156 – 0.2159 in)	5.500 mm (0.2165 in)	
	Stem-to-guide clearance	IN.	0.010 – 0.030 mm (0.0004 – 0.0012 in)	0.08 mm (0.003 in)	
		EX.	0.030 – 0.050 mm (0.0012 – 0.0020 in)	0.10 mm (0.004 in)	
Valve seat width			1.0 mm (0.04 in)	1.6 mm (0.06 in)	
Cylinder head warpage			—	0.05 mm (0.002 in)	



TROUBLESHOOTING

Performance problems related to the cylinder head can usually be diagnosed by a compression test, or noise problems which can be traced to the top end with a sounding rod or stethoscope.

Low Compression

1. Valves
 - Incorrect valve adjustment
 - Burned or bent valves
 - Incorrect valve timing
 - Broken valve spring
2. Cylinder head
 - Leaking or damaged head gasket
 - Warped or cracked cylinder head
3. Cylinder and piston (Refer to Section 7)

Compression too High

1. Excessive carbon build-up on piston head or combustion chamber

Excessive Noise

1. Incorrect valve adjustment
2. Sticking valve or broken valve spring
3. Damaged or worn camshaft
4. Loose or worn cam chain
5. Worn or damaged cam chain tensioner
6. Worn cam sprocket teeth



CYLINDER HEAD REMOVAL

Remove the front cover.

Disconnect the intake pipe from the cylinder head.

Remove the contact point cover and turn the crankshaft counterclockwise to align the "T" mark with the index mark.

INDEX MARK



"T" MARK

Remove the muffler.

Remove the spark plug cap.

Remove the cylinder head left side cover by removing the through bolt from the right side.

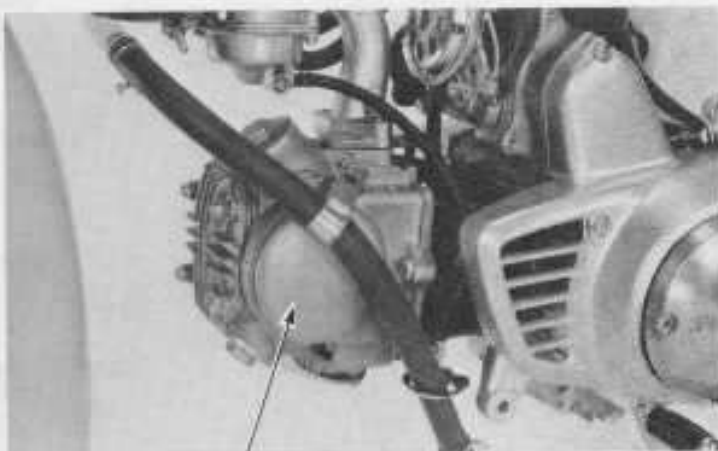

CYLINDER HEAD
LEFT SIDE COVER

Remove the camshaft sprocket.

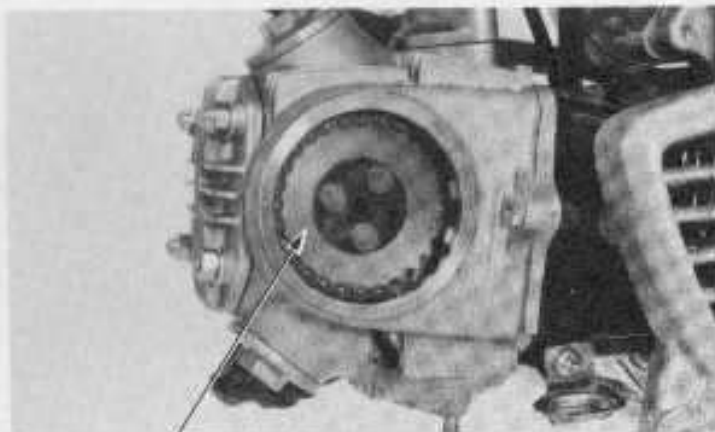

CAMSHAFT SPROCKET

Loosen the cylinder 6 mm bolt.

Remove the cylinder head 6 mm bolt and cylinder head cover.

Remove the cylinder head.

CYLINDER HEAD COVER

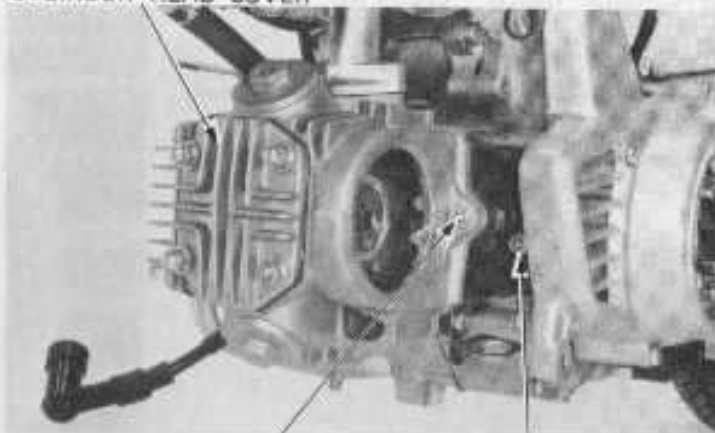

CYLINDER HEAD
6mm BOLT

CYLINDER
6mm BOLT

Remove the O-rings, cylinder head gasket and dowel pins.

DOWEL PINS



GASKET

O-RINGS

CYLINDER HEAD DISASSEMBLY

Remove the cylinder head right side cover and gasket.

Remove the valve inspection caps and O-rings.

VALVE INSPECTION CAPS

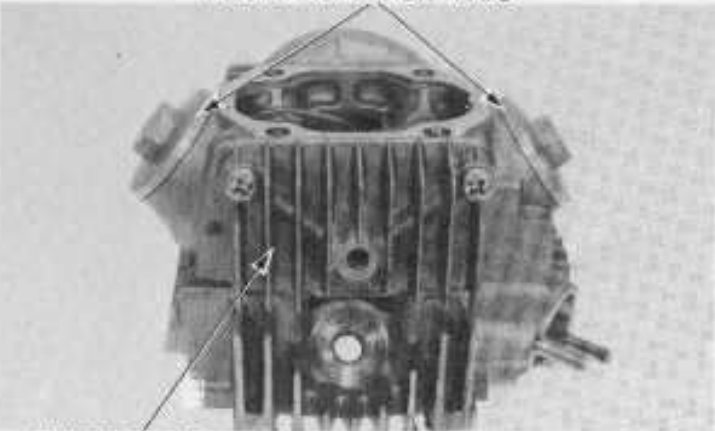

CYLINDER HEAD
RIGHT SIDE COVER



Screw an 8 mm bolt into the rocker arm shaft and pull the shaft out of the cylinder head.

Remove the rocker arms.

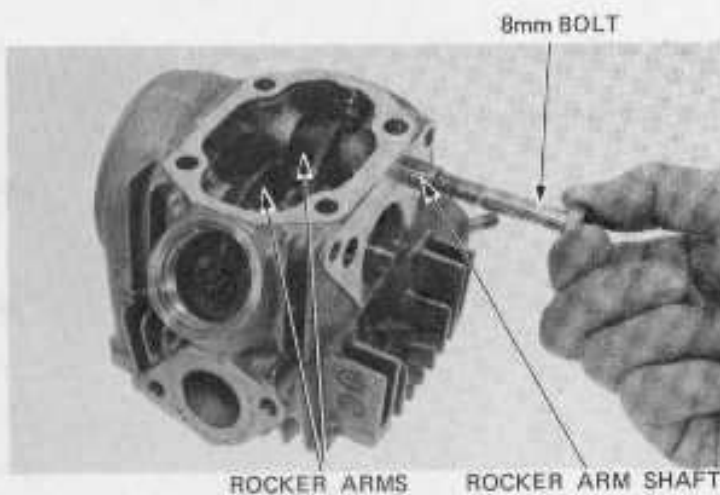

Remove the camshaft aligning the cam lobes with the cylinder head cutouts.



Remove the valve spring cotters, retainers, springs and valves.

CAUTION:

To prevent loss of tension, do not compress the valve springs more than necessary to remove the cotters.

Remove valve spring seats, stem seal caps and stem seals.

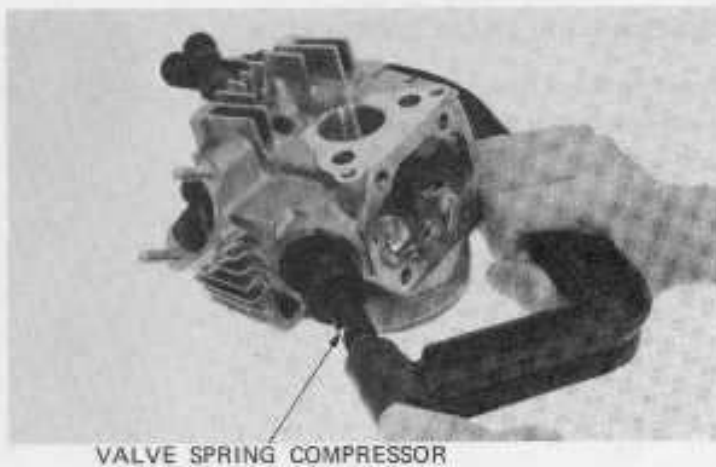



Remove carbon deposits from the combustion chamber.

Clean off the head gasket surface.

NOTE

- Avoid damaging the gasket surface.
- Gasket material will come off easier if soaked in solvent.

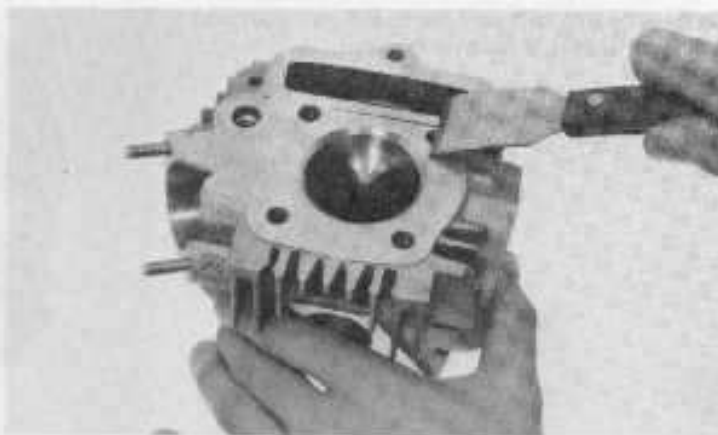
ROCKER ARM INSPECTION

Inspect the rocker arms for damage, wear or clogged oil holes.

Measure the I.D. of the rocker arm.

STANDARD: 10.000–10.015 mm
(0.3937–0.3943 in)

SERVICE LIMIT: 10.10 mm (0.398 in)

ROCKER ARM SHAFT INSPECTION

Inspect the rocker arm shaft for wear or damage.

Measure the O.D. of the rocker arm shaft.

STANDARD: 9.878–9.989 mm
(0.3928–0.3933 in)

SERVICE LIMIT: 9.91 mm (0.3902 in)





CAMSHAFT INSPECTION

Using a micrometer, measure the cam lobes.
Check for wear or damage.

STANDARD: 26.07 mm (1.026 in)
SERVICE LIMIT: 25.69 mm (1.011 in)



CAMSHAFT OIL CLEARANCE

Measure and record the camshaft journal O.D.
Measure and record the camshaft bearing I.D. in the
cylinder head.

Determine the camshaft bearing oil clearance.

STANDARD: 0.010–0.025 mm
(0.0002–0.0010 in)
SERVICE LIMIT: 0.05 mm (0.002 in)

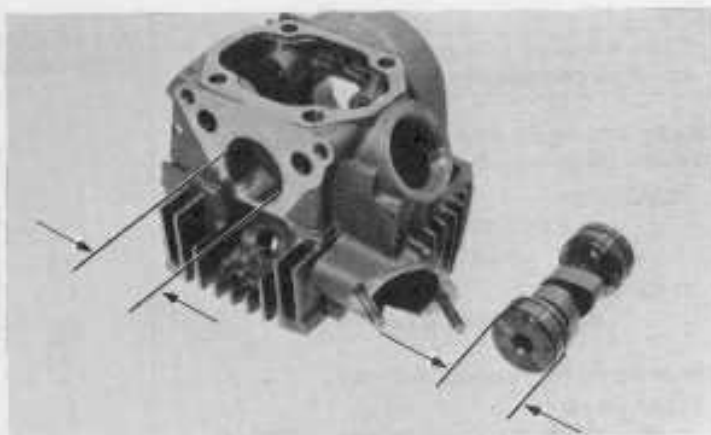

VALVE SPRING FREE LENGTH INSPECTION

Measure the length of the inner and outer valve
springs.

STANDARD:
Inner: 25.1 mm (0.99 in)
Outer: 28.1 mm (1.11 in)
SERVICE LIMIT:
Inner: 23.9 mm (0.94 in)
Outer: 26.9 mm (1.06 in)

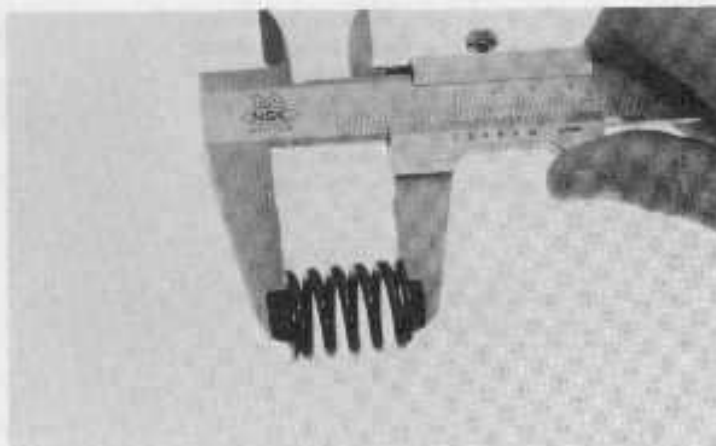

VALVE STEM-TO-GUIDE CLEARANCE

Inspect each valve for bending, burning, scratches or abnormal stem wear.

Check valve movement in the guide.

Measure and record each valve stem O.D.

STANDARD:

IN: 5.455–5.465 mm (0.2148–0.2152 in)

EX: 5.435–5.445 mm (0.2140–0.2144 in)

SERVICE LIMIT:

IN/EX: 5.40 mm (0.213 in)



NOTE

Ream the guide to remove any carbon build-up before checking clearance.

Measure and record each valve guide I.D. using a small hole gauge or inside micrometer.

STANDARD:

IN/EX: 5.475–5.485 mm
(0.2156–0.2159 in)

SERVICE LIMIT:

IN/EX: 5.50 mm (0.2165 in)

Determine the stem-to-guide clearance.

STANDARD:

IN: 0.010–0.030 mm (0.0004–0.0012 in)

EX: 0.030–0.050 mm (0.0012–0.0020 in)

SERVICE LIMIT: IN: 0.08 mm (0.003 in)

EX: 0.10 mm (0.004 in)

If the stem-to-guide clearance exceeds the service limits, determine if a new guide with standard dimensions would bring the clearance within tolerance. If so, replace the guides as necessary and ream to fit.

If the stem-to-guide clearance exceeds the service limits with new guides, replace the valves and guides.

NOTE

Reface the valve seats whenever the valve guides are replaced (page 6-10).

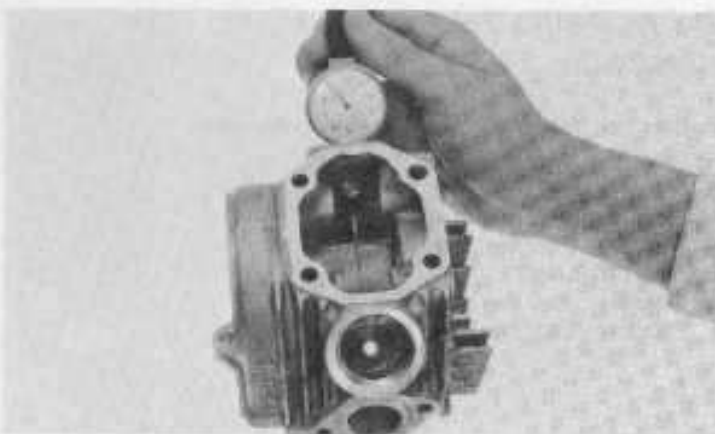
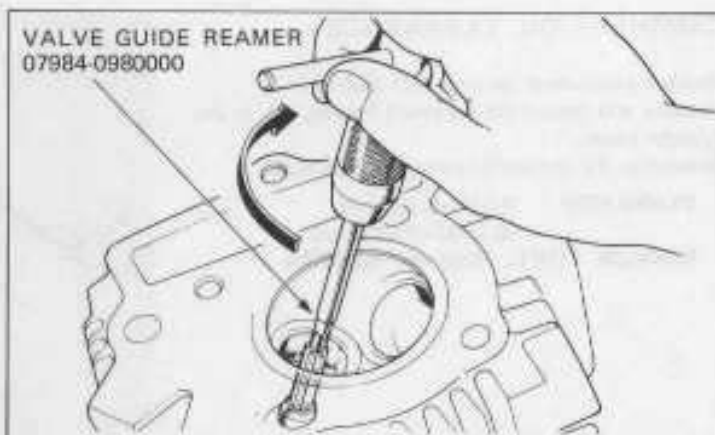



VALVE GUIDE REPLACEMENT

Support the cylinder head and drive the guide out from the port side.

NOTE

When driving out the valve guide, do not damage the head.



Install a new oversize valve guide from the top of the head.

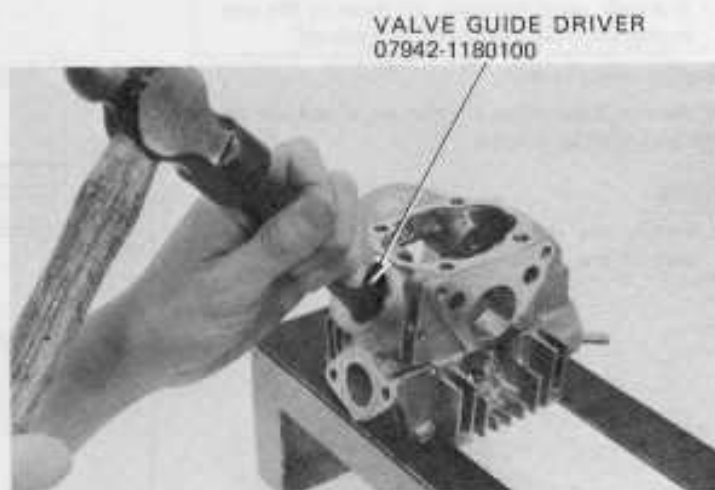

Ream the new valve guide after installation.

NOTE

- Use cutting oil on the reamer during this operation.
- Rotate the reamer when inserting and removing it.

Reface the valve seat (page 6-10).
Clean the cylinder head thoroughly to remove any metal particles.

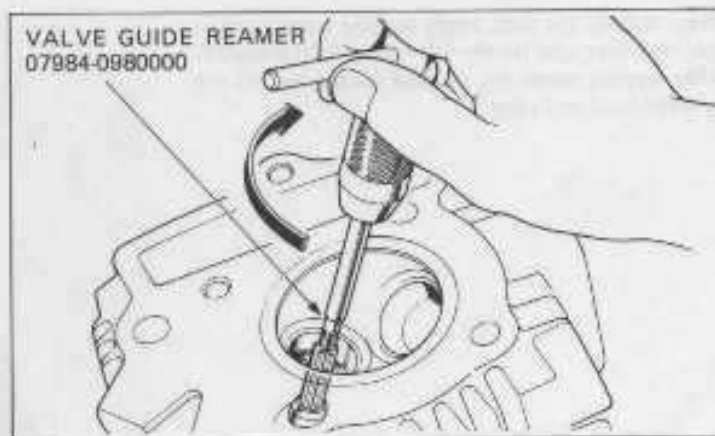



VALVE SEAT INSPECTION/REFACING

Clean both intake and exhaust valves thoroughly to remove carbon deposits. Apply a light coating of valve lapping compound to each valve face. Lap each valve and seat using a rubber hose or other hand-lapping tool.

NOTE

Take care not to allow the compound to enter between the valve stem and guide. After lapping, wash out the compound completely and apply a coat of engine oil to the valve face and seat.

Remove the valve and inspect the face.

CAUTION:

The valves cannot be ground. If the valve face is rough, worn unevenly, or contacts the seat improperly, the valve must be replaced.

Inspect the valve seat.

If the seat is too wide, too narrow, or has low spots, the seat must be ground.

NOTE

Follow the refacer manufacturer's operating instructions.

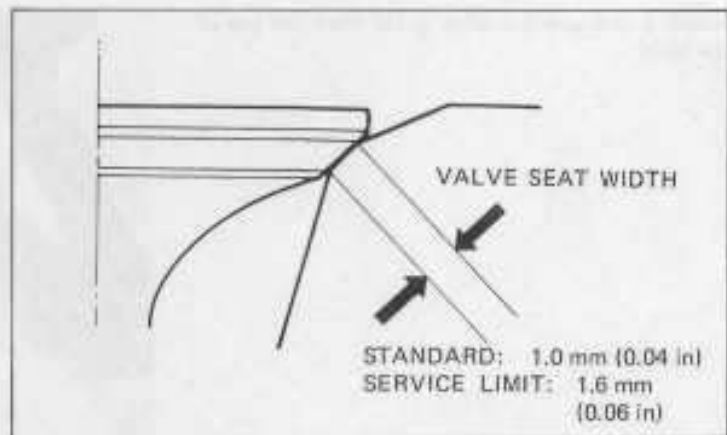
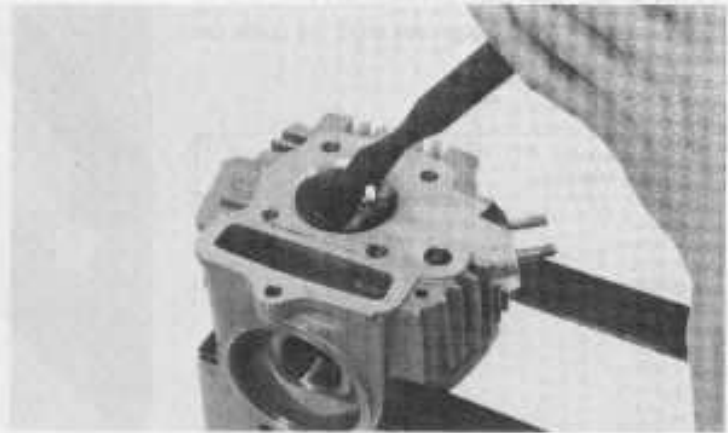

After cutting the seat, apply lapping compound to the valve face, and lap the valve using light pressure. After lapping, wash any residual compound off the cylinder head and valve.





CYLINDER HEAD ASSEMBLY

Install new valve stem seals.

Lubricate each valve stem with molybdenum disulfide grease and insert the valve into the valve guide.

NOTE

To avoid damage to the stem seal, turn the valve slowly when inserting.

Install the valve springs and retainers.

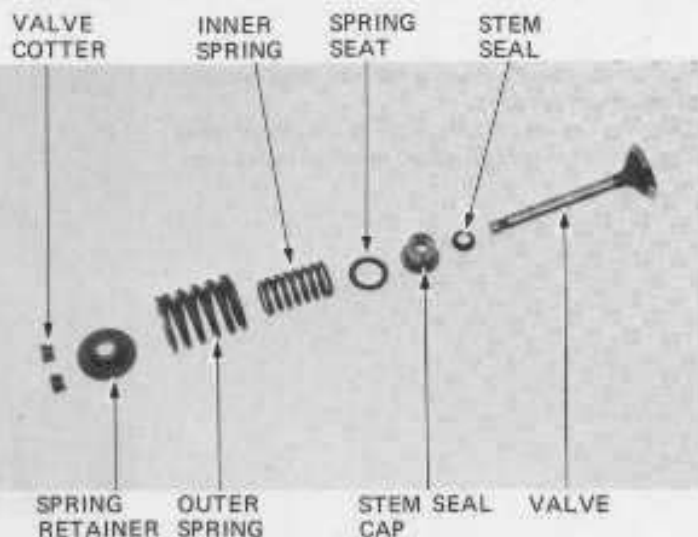

Install the valve cotters.

CAUTION:

To prevent tension loss, do not compress the valve spring more than necessary to install the valve cotters.



VALVE SPRING COMPRESSOR

Tap the valve stems gently with a soft hammer to firmly seat the valve cotters.

NOTE

Support the cylinder head above the work bench surface to prevent possible valve damage.

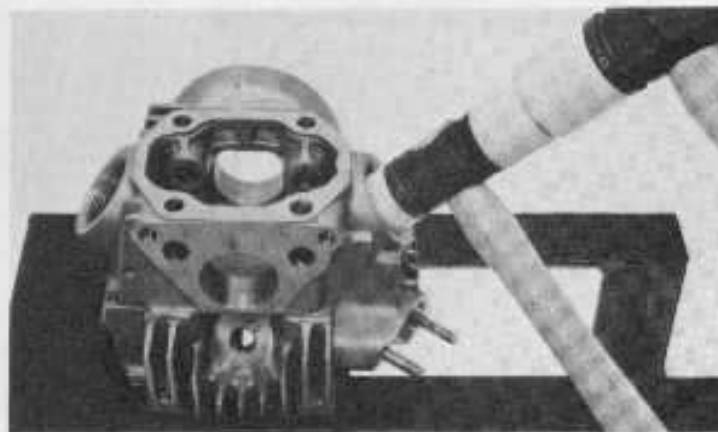

Install the camshaft aligning the cam lobes with the cylinder head cutouts.

Align the camshaft hole with the cylinder head index mark for easy camshaft sprocket installation.

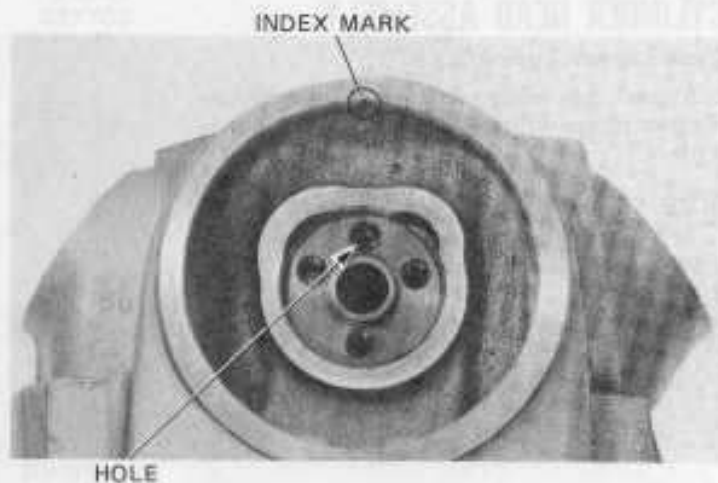

Apply a thin coat of engine oil to the rocker arm shafts.

Install the rocker arms and shafts with the threaded ends facing out.

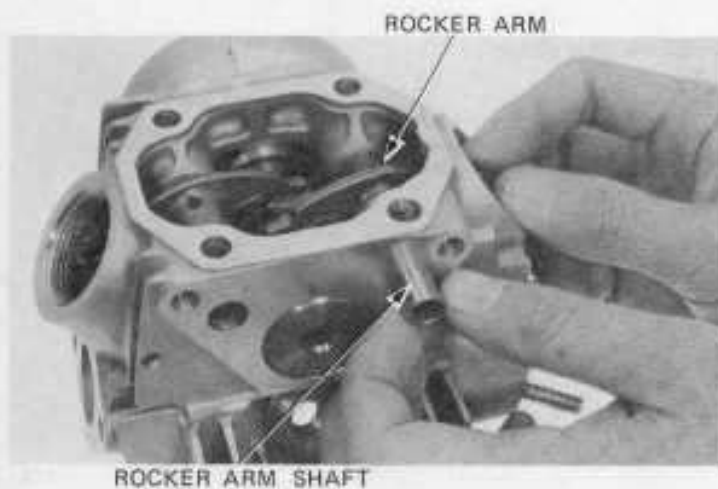

Install the cylinder head right side cover using a new gasket.

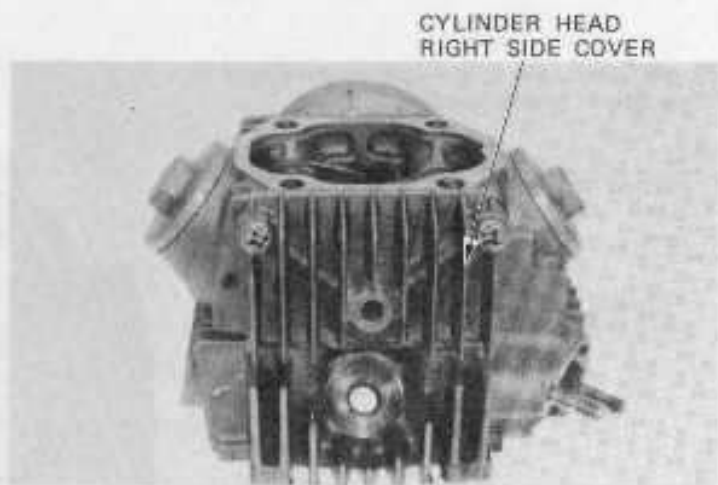



CYLINDER HEAD INSTALLATION

Install a new cylinder head gasket and new oil passage O-rings.



DOWEL PINS

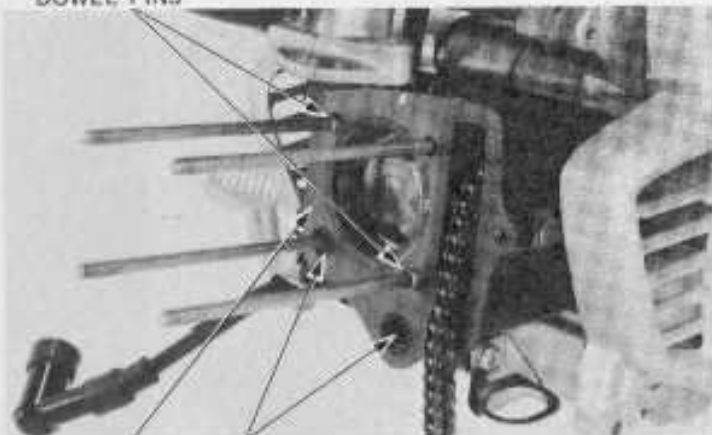

GASKET O-RINGS

Install the cylinder head.
Install the cylinder head cover with the arrow facing down (EX side).

NOTE

Be sure to install the sealing washers, copper washer, cap nuts and nut on the cylinder head cover as shown.

Tighten the nuts.
TORQUE: 0.9-1.2 kg-m (7-9 ft-lb)
Tighten the cylinder and head 6 mm bolts.

CAP NUTS

ARROW

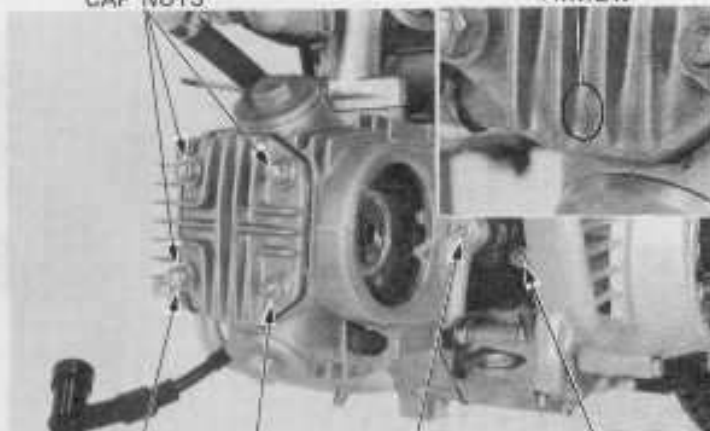

COPPER WASHER NUT HEAD 6mm BOLT CYLINDER 6mm BOLT

Turn the crankshaft counterclockwise and align the "T" and index marks.

Loosen the cam chain tensioner lock nut and adjusting bolt.

INDEX MARK

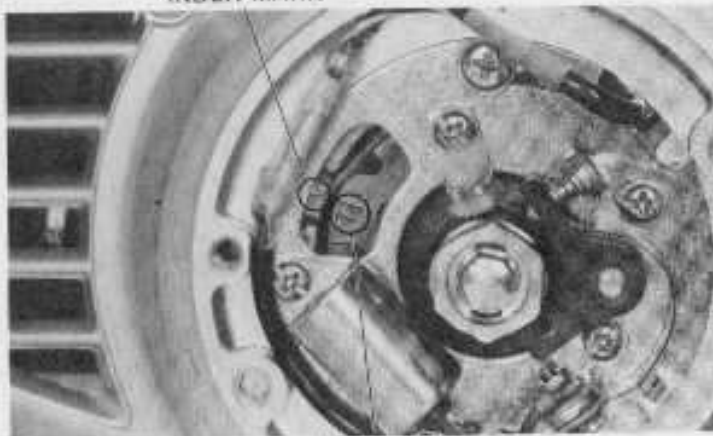

"T" MARK

Place the cam chain over the camshaft sprocket, aligning the sprocket o-mark with the cylinder head index mark.

Install the camshaft sprocket on the camshaft and tighten the sprocket bolts.

TORQUE: 0.5–0.9 kg-m (4–7 ft-lb)

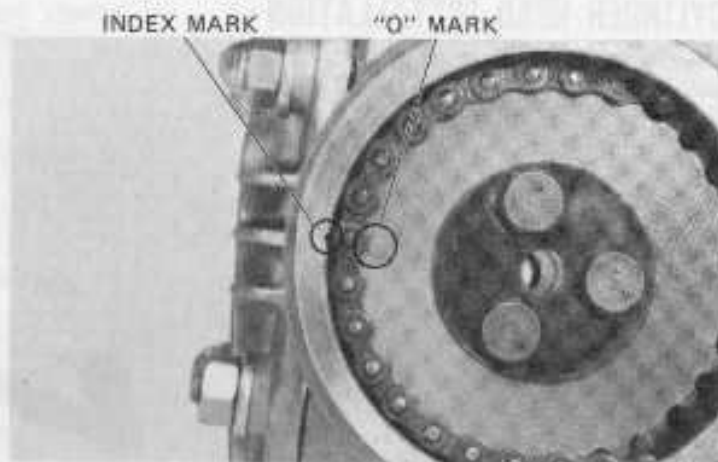

Install the cylinder head left side cover aligning the tang with the cylinder head notch.

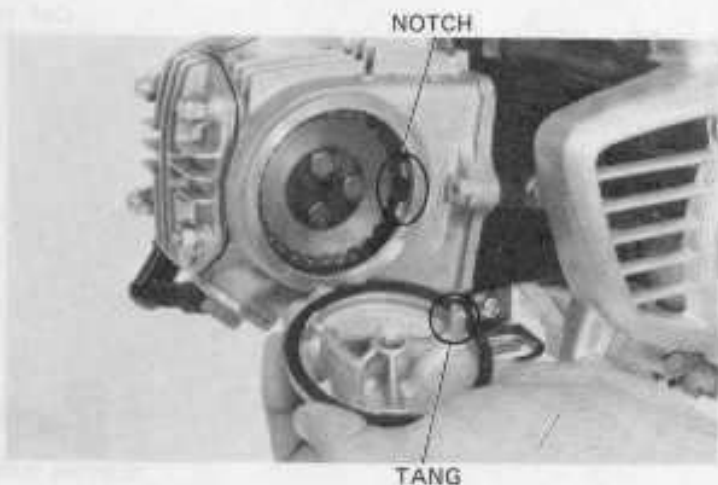

Install the muffler.

Install the spark plug cap.

Connect the intake pipe.

Adjust the valve clearance (page 3-6).

Install the contact point cover.

Adjust the cam chain tension (page 3-9).

Install the front cover.

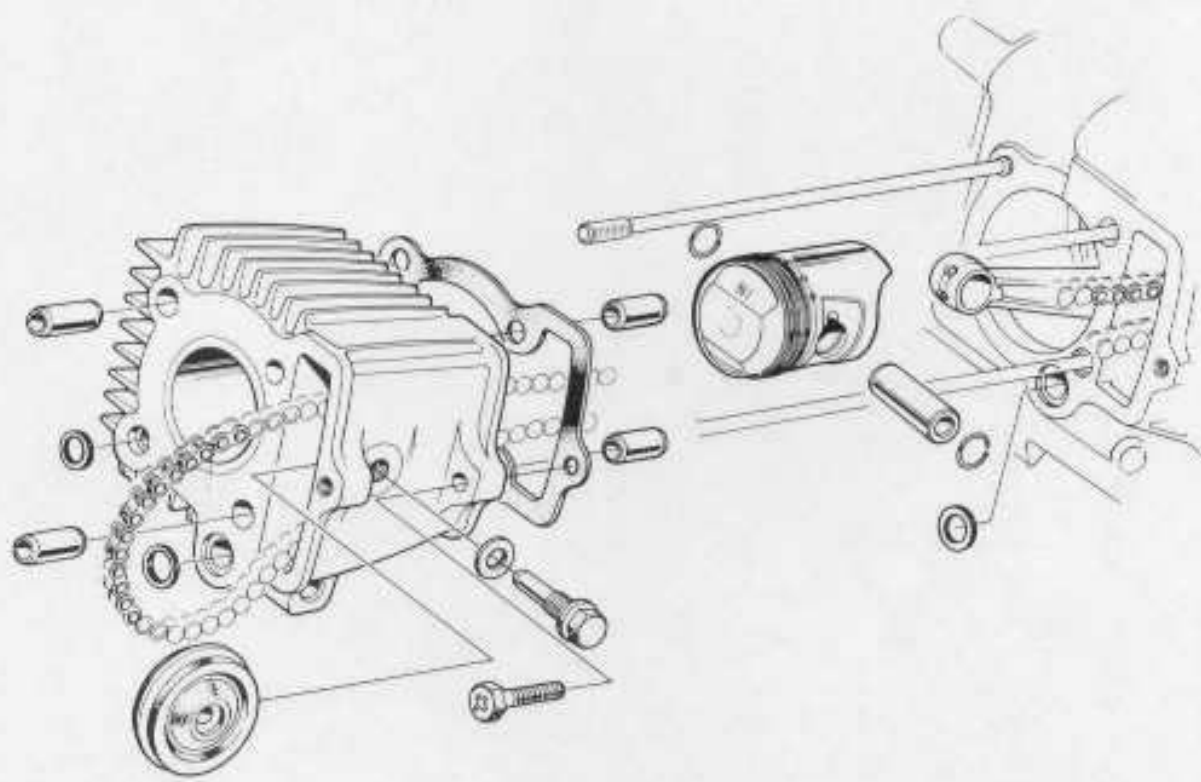



SERVICE INFORMATION	7-1	PISTON REMOVAL	7-3
TROUBLESHOOTING	7-1	PISTON INSTALLATION	7-6
CYLINDER REMOVAL	7-2	CYLINDER INSTALLATION	7-6

SERVICE INFORMATION

GENERAL INSTRUCTIONS

- Cylinder/piston maintenance and inspection can be performed with the engine installed.
- Camshaft and rocker arm lubricating oil is fed through cylinder oil passages. Be sure the passages are not clogged.

SPECIFICATIONS

ITEM		STANDARD		SERVICE LIMIT	
Cylinder	I.D.	47.005 – 47.015 mm (1.8506 – 1.8510 in)		47.05 mm (1.852 in)	
Piston, piston rings and piston pin	Piston ring-to-ring groove clearance	TOP	0.010 – 0.045 mm (0.0004 – 0.0018 in)	0.12 mm (0.005 in)	
		SECOND	0.010 – 0.045 mm (0.0004 – 0.0018 in)	0.12 mm (0.005 in)	
	Ring end gap	TOP	0.15 – 0.35 mm (0.006 – 0.014 in)	0.5 mm (0.02 in)	
		SECOND	0.15 – 0.35 mm (0.006 – 0.014 in)	0.5 mm (0.02 in)	
		OIL	0.30 – 0.90 mm (0.012 – 0.036 in)	—	
	Piston O.D.		46.98 – 47.00 mm (1.850 – 1.8504 in)		46.90 mm (1.847 in)
Piston pin bore		13.002 – 13.008 mm (0.5119 – 0.5121 in)		13.055 mm (0.5140 in)	
Connecting rod small end I.D.		13.013 – 13.043 mm (0.5123 – 0.5135 in)		13.1 mm (0.52 in)	
Piston pin O.D.		12.994 – 13.000 mm (0.5116 – 0.5118 in)		12.98 mm (0.511 in)	
Piston-to-piston pin clearance		0.002 – 0.014 mm (0.0001 – 0.0006 in)		0.075 mm (0.0030 in)	
Cylinder-to-piston clearance		0.005 – 0.035 mm (0.0002 – 0.0014 in)		0.15 mm (0.006 in)	

TROUBLESHOOTING

Compression low

1. Worn cylinder or piston rings

Excessive smoke

1. Worn cylinder or piston rings
2. Improper installation of piston rings
3. Scored or scratched piston or cylinder wall

Overheating

1. Excessive carbon build-up on the piston or combustion chamber wall

Knocking or abnormal noise

1. Worn piston and cylinder
2. Excessive carbon build-up



CYLINDER REMOVAL

- Remove the cylinder head (Section 6).
- Remove the 6 mm bolt.
- Remove the guide roller pin and guide roller.
- Remove the cylinder.

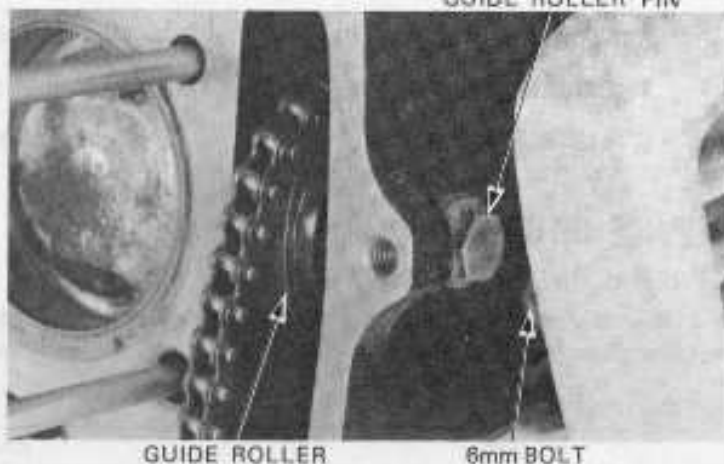

- Remove the O-ring, gasket and dowel pins.

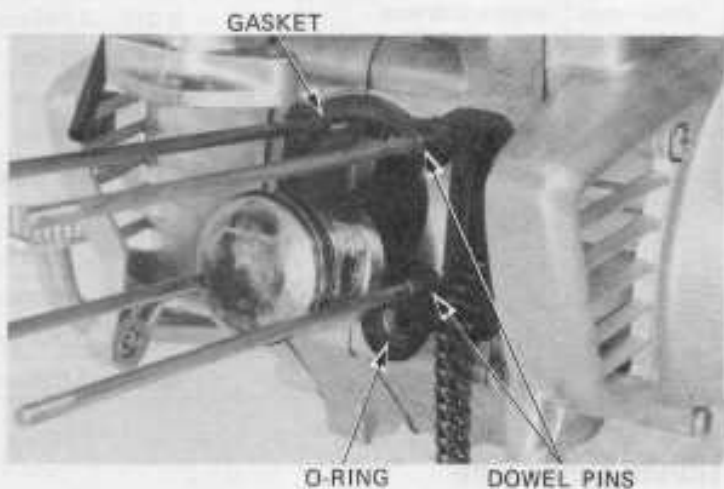

CYLINDER INSPECTION

Inspect the cylinder bore for wear or damage.
Measure the cylinder I.D. at three levels in X and Y axis.

STANDARD: 47.005–47.015 mm
(1.8506–1.8510 in)

SERVICE LIMIT: 47.05 mm (1.852 in)

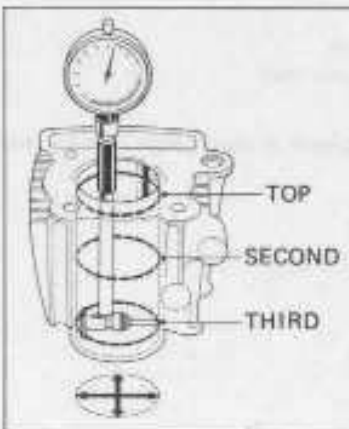



PISTON REMOVAL

Place a shop towel in crankcase to keep dirt and parts out.

Remove the piston pin clip with needle nose pliers.

Press the piston pin out.

Remove the piston.

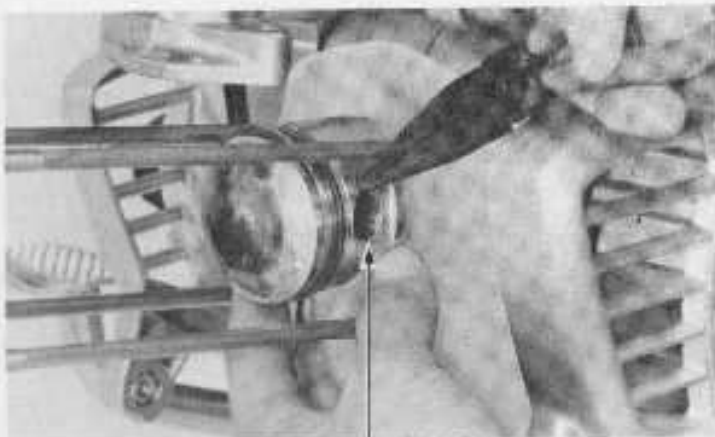

PISTON PIN CLIP

PISTON/PISTON RING INSPECTION

Measure the piston ring-to-groove clearance.

STANDARD: 0.010–0.045 mm
(0.0004–0.0018 in)

SERVICE LIMIT: 0.12 mm (0.005 in)

Remove the piston rings.

NOTE

Do not damage the piston rings during removal.

Inspect the piston for damage and cracks; ring grooves for wear.



Insert each piston ring into the cylinder, and measure the end gap.

STANDARD:

TOP/SECOND: 0.15–0.35 mm
(0.006–0.014 in)

OIL: 0.30–0.90 mm (0.012–0.036 in)

SERVICE LIMIT:

TOP/SECOND: 0.5 mm (0.02 in)

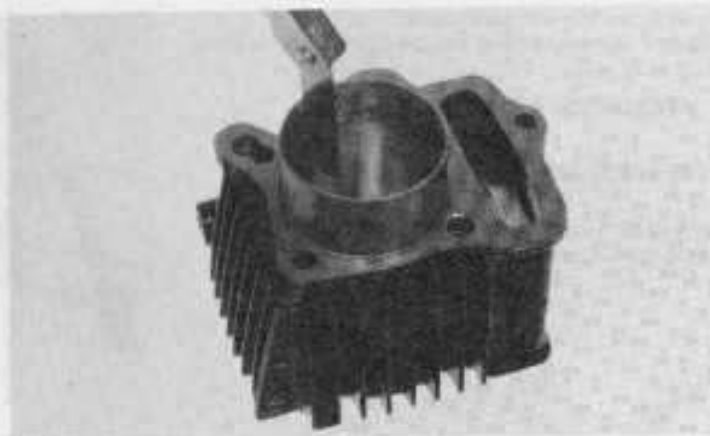



Measure the piston O.D. 10 mm (0.4 in) above the skirt's bottom.

STANDARD: 46.98–47.00 mm
(1.850–1.8504 in)

SERVICE LIMIT: 46.90 mm (1.847 in)

Calculate the cylinder-to-piston clearance.

STANDARD: 0.005–0.035 mm
(0.0002–0.0014 in)

SERVICE LIMIT: 0.15 mm (0.006 in)



Measure the piston pin hole I.D.

STANDARD: 13.002–13.008 mm
(0.5119–0.5121 in)

SERVICE LIMIT: 13.055 mm (0.514 in)

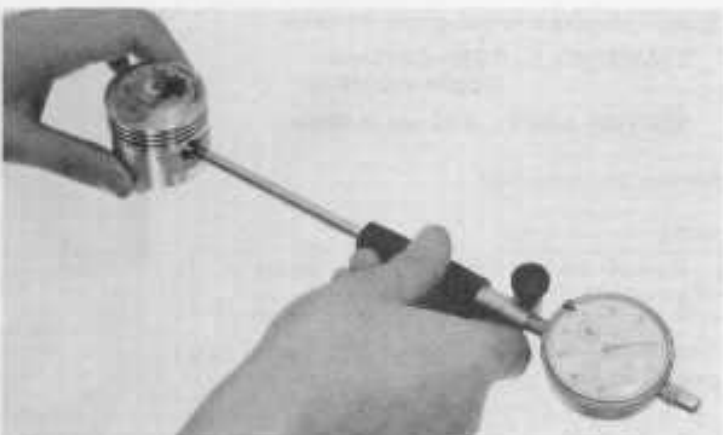

Remove the left crankcase cover.
Measure the connecting rod small end I.D. with a small hole gauge.

STANDARD: 13.013–13.043 mm
(0.5123–0.5135 in)

SERVICE LIMIT: 13.1 mm (0.52 in)

See section 10 for replacement procedure.
Install the left crankcase cover.

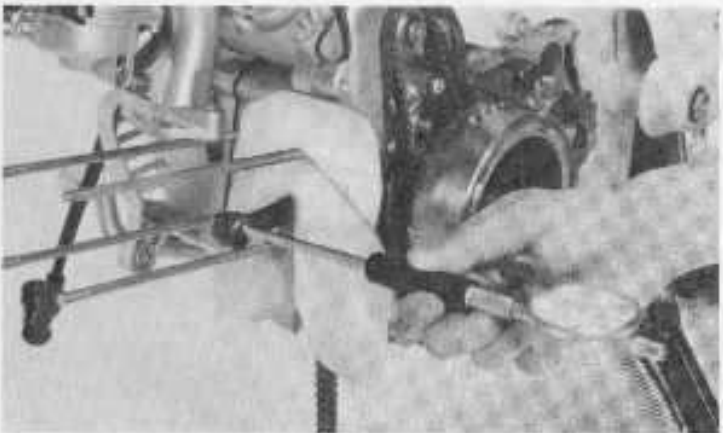



Measure the piston pin O.D.

STANDARD: 12.994–13.000 mm
(0.5116–0.5118 in)

SERVICE LIMIT: 12.98 mm (0.511 in)

Calculate the piston-to-piston pin clearance.

STANDARD: 0.002–0.014 mm
(0.0001–0.0006 in)

SERVICE LIMIT: 0.075 mm (0.0030 in)



PISTON RING INSTALLATION

Install the piston rings with the markings facing up.

NOTE

- After installation, the rings should rotate freely.
- Do not mix the top and second rings.

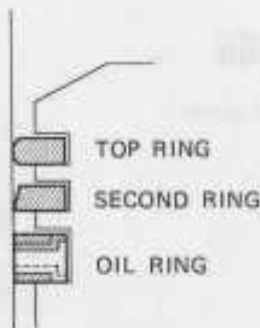

Space the piston ring end gaps 120° degrees apart.
Do not align the gaps in the oil rings.

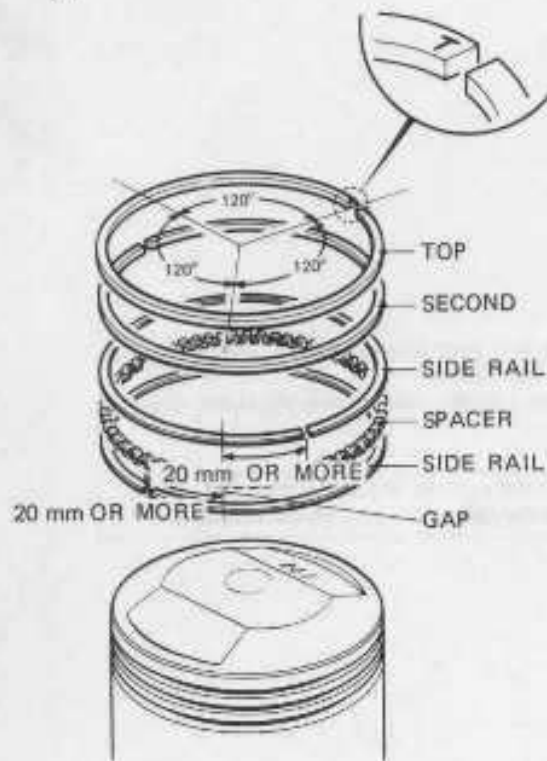

**CYLINDER/PISTON****PISTON INSTALLATION**

Apply molybdenum disulfide grease to the connecting rod small end.
Install the piston, piston pin and clip.

NOTE

- Install the piston with the "IN" mark facing the intake side.
- Do not align the piston pin clip end gap with the piston cutout.

**CYLINDER INSTALLATION**

Install the dowel pins, O-ring and gasket.

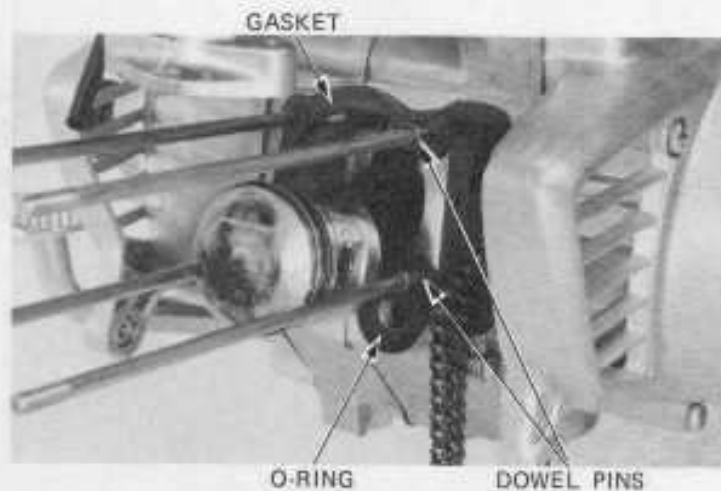

Apply a thin coat of engine oil to the piston rings and cylinder wall.
Install the cylinder, compressing the piston rings.

NOTE

When the cylinder is halfway over the piston, route the cam chain through the cylinder.





Install the cam chain guide roller and tighten the guide roller pin.

TORQUE: 0.9–1.4 kg-m (6.5–10 ft-lb)

Loosely install the 6 mm bolt.

Install the cylinder head (Section 6).

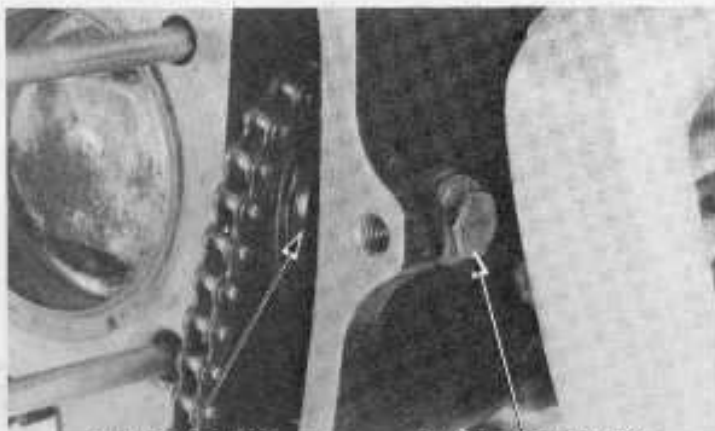

GUIDE ROLLER

GUIDE ROLLER PIN

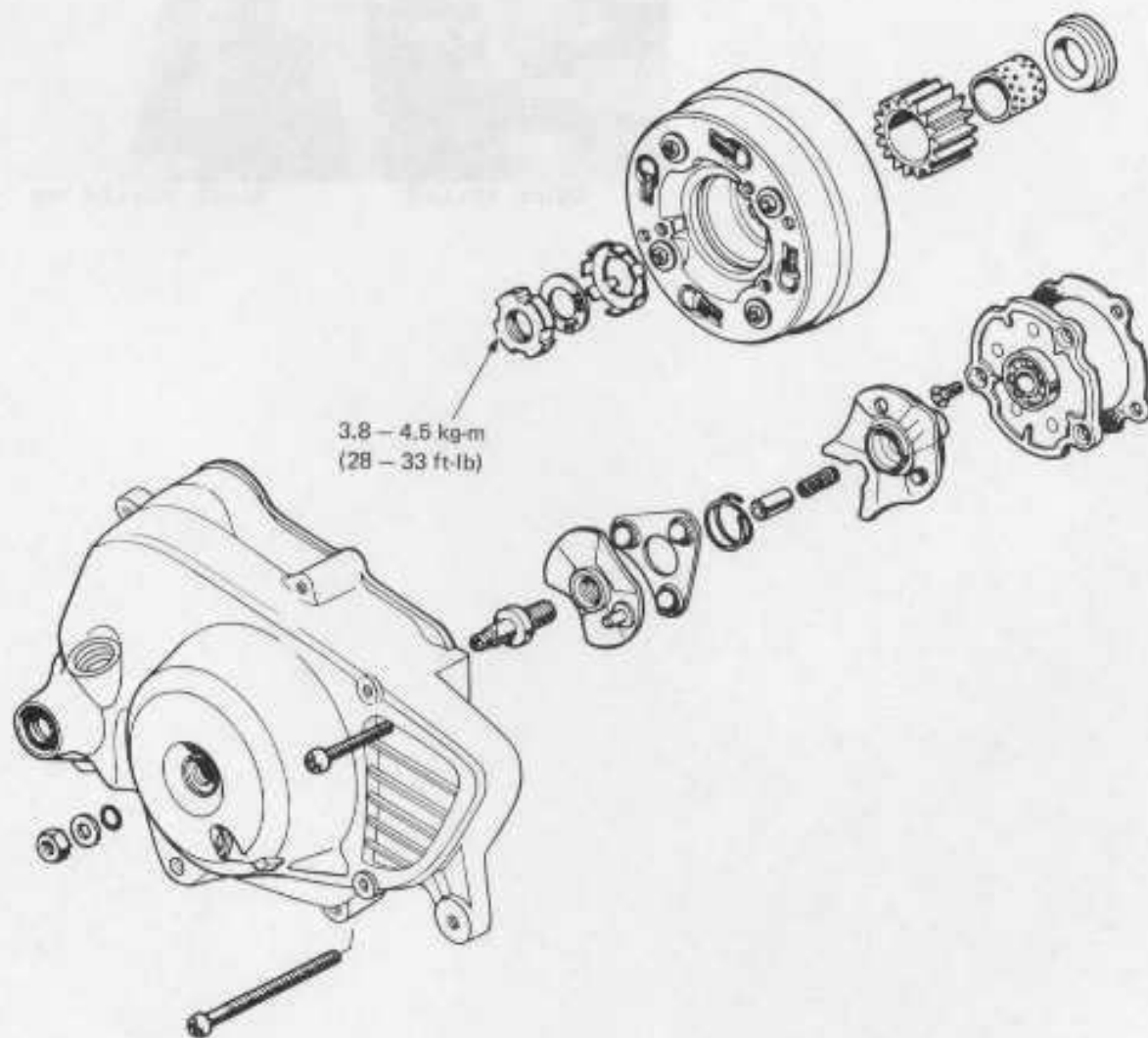

3.8 - 4.6 kg-m
(28 - 33 ft-lb)



SERVICE INFORMATION	8-1	CLUTCH DISASSEMBLY	8-3
TROUBLESHOOTING	8-1	CLUTCH ASSEMBLY	8-6
RIGHT CRANKCASE COVER REMOVAL	8-2	CLUTCH INSTALLATION	8-6
CLUTCH REMOVAL	8-2	RIGHT CRANKCASE COVER INSTALLATION	8-7

SERVICE INFORMATION

GENERAL INSTRUCTION

Clutch service can be done with the engine in the frame.

TOOLS

Common

Universal holder

07725-0010101 — N.A. IN U.S.A., Use commercially available band strap wrench.

Lock nut wrench, 20 x 24 mm

07716-0020100

Extension, 1/2 in drive x 3 in (75 mm)

07716-0020500 — Commercially available

TORQUE VALUE

Clutch lock nut

3.8 — 4.5 kg-m (28 — 33 ft-lb)

SPECIFICATIONS

ITEM		STANDARD	SERVICE LIMIT
Clutch	Spring free length	25.08 mm (0.987 in)	23.1 mm (0.91 in)
	Disc thickness	A 2.55 — 2.65 mm (0.100 — 0.104 in)	2.3 mm (0.09 in)
		B 3.35 — 3.45 mm (0.139 — 0.136 in)	3.0 mm (0.12 in)
	Plate warpage	—	0.2 mm (0.01 in)
	Clutch center guide O.D.	20.930 — 20.950 mm (0.8240 — 0.8248 in)	20.90 mm (0.823 in)
	Drive gear I.D.	21.000 — 21.021 mm (0.8268 — 0.8276 in)	21.05 mm (0.829 in)

TROUBLESHOOTING

Clutch slips

1. No free play
2. Discs worn
3. Springs weak

Clutch does not disengage

1. Plate warpage

Clutch drags when disengaged

1. Lifter mechanism damaged



RIGHT CRANKCASE COVER REMOVAL

Drain the engine oil thoroughly.
Support the motorcycle upright with a stand.

Remove the right crankcase cover (page 2-2).

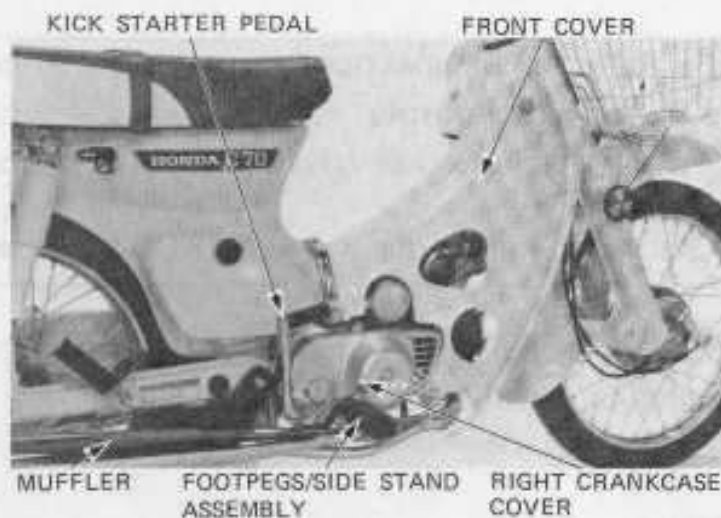

CLUTCH LIFTER REMOVAL

Remove the clutch lifter and clutch adjusting bolt.

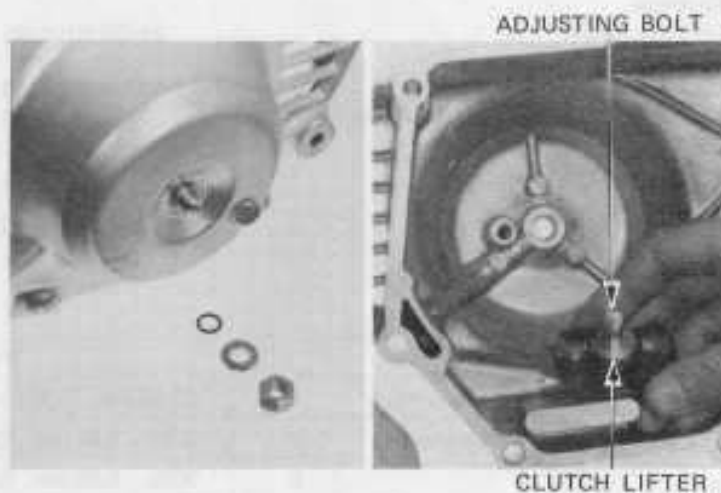

CLUTCH REMOVAL

Remove the clutch lever and clutch cam.
Remove the clutch outer cover.

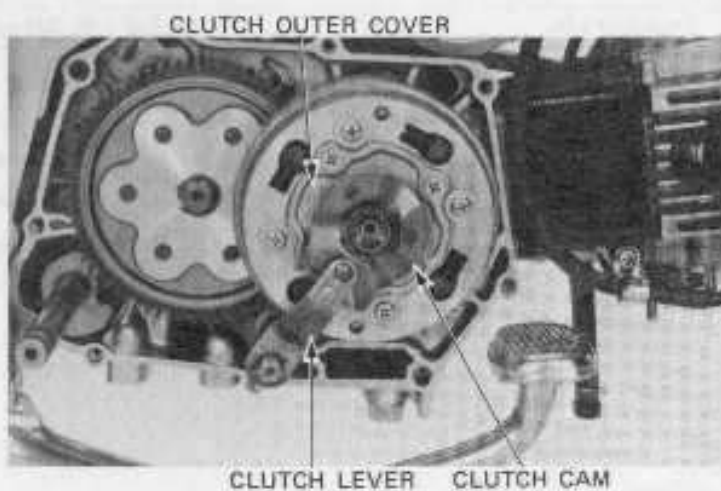



Straighten the lock washer tab.

LOCK WASHER TAB

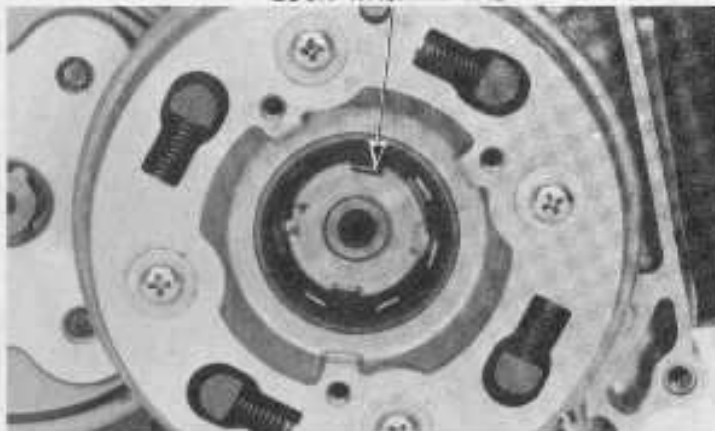

Remove the lock nut, washer and lock washer.
The clutch can now be removed as a unit.
Remove the drive gear and clutch center guide.

UNIVERSAL HOLDER

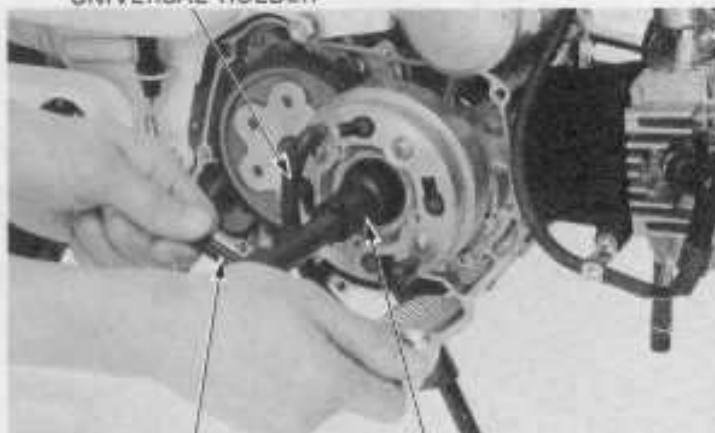

EXTENSION

LOCK NUT WRENCH,
20 x 24mm

CLUTCH DISASSEMBLY

Remove the set ring using a screwdriver.
Remove the clutch plates, discs, center, drive gear
outer and rollers.

SET RING





Remove the clutch damper springs.

Place a wood block under the drive plate.

Remove the 5 mm screws, loosening 2-3 turns at a time while pushing down on the clutch outer.



CLUTCH SPRING INSPECTION

Measure the spring free length.

STANDARD: 25.08 mm (0.987 in)

SERVICE LIMIT: 23.1 mm (0.91 in)

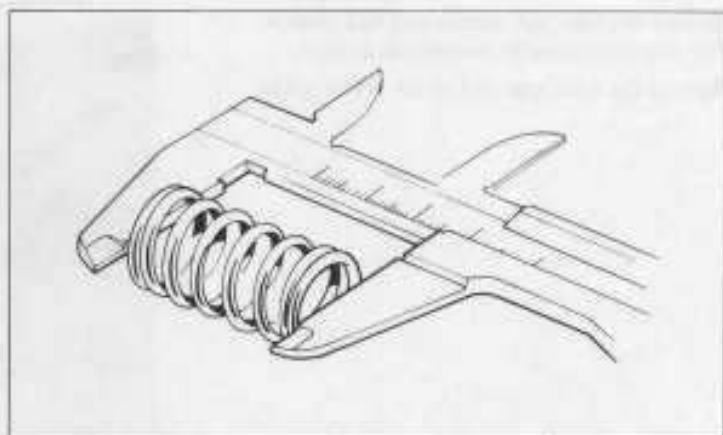

CLUTCH DISC INSPECTION

Replace the clutch discs if they show signs of scoring or discoloration.

Measure the disc thickness.

STANDARD:

DISC A: 2.55–2.65 mm (0.100–0.104 in)

DISC B: 3.35–3.45 mm (0.139–0.136 in)

SERVICE LIMIT: DISC A: 2.3 mm (0.09 in)

DISC B: 3.0 mm (0.12 in)





Check the rollers and plates for excessive wear.
Replace if necessary.

Check for plate warpage on a surface plate using a feeler gauge.

SERVICE LIMIT: 0.2 mm (0.01 in)

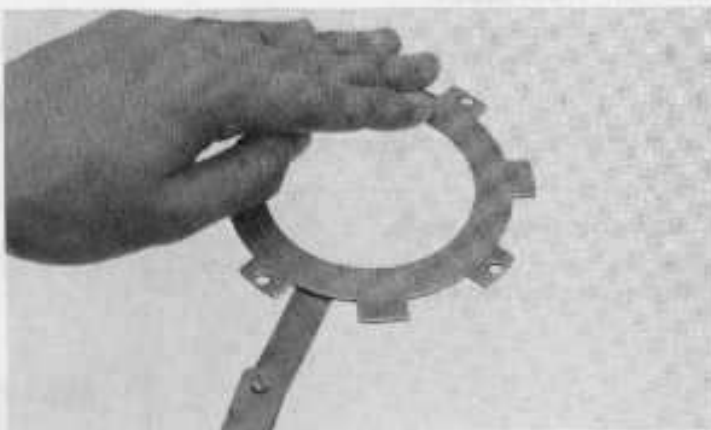

DRIVE GEAR INSPECTION

Check for wear or damage.
Measure the drive gear I.D.

STANDARD: 21.000–21.021 mm
(0.8268–0.8276 in)

SERVICE LIMIT: 21.05 mm (0.829 in)



CLUTCH CENTER GUIDE INSPECTION

Check for wear or damage.
Measure the clutch center guide O.D.

STANDARD: 20.930–20.950 mm
(0.8240–0.8248 in)

SERVICE LIMIT: 20.90 mm (0.823 in)

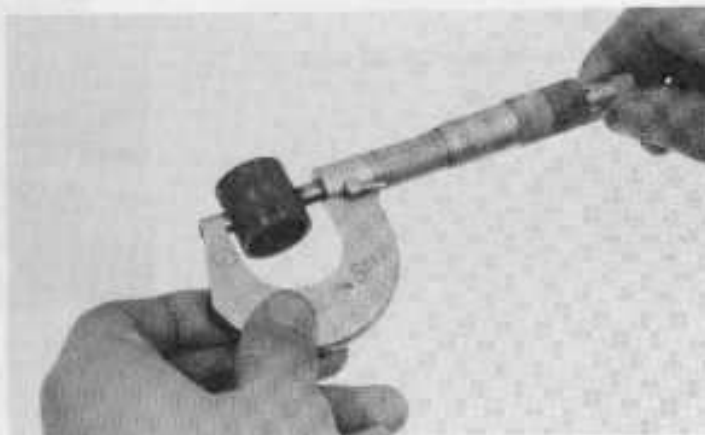



CLUTCH ASSEMBLY

Place the clutch springs on the drive plate and install the drive plate to the clutch outer.

NOTE

Tighten the screws in 2-3 steps in a crisscross pattern.

Install the clutch damper springs.

Install the rollers, drive gear outer, clutch center, discs and plates and secure with the set ring.

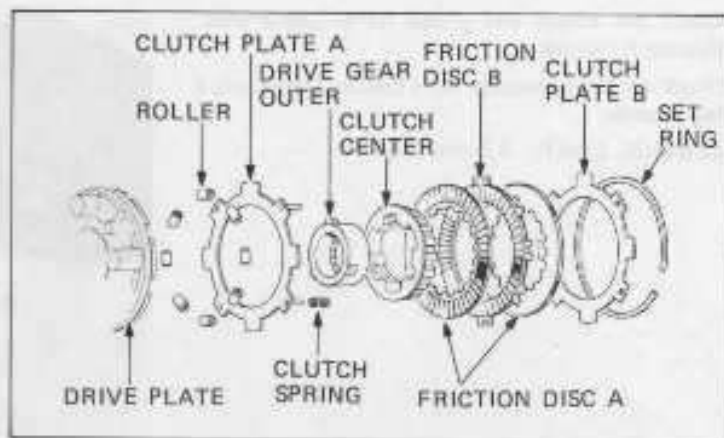

CLUTCH INSTALLATION

Install the clutch center guide and drive gear.

Install the clutch assembly.

Install the lock washer, plain washer and lock nut.

NOTE

Install the plain washer with the "OUTSIDE" mark facing out.



Tighten the lock nut.

TORQUE: 3.8–4.5 kg-m (28–33 ft-lb)

Bend the lock washer tab.

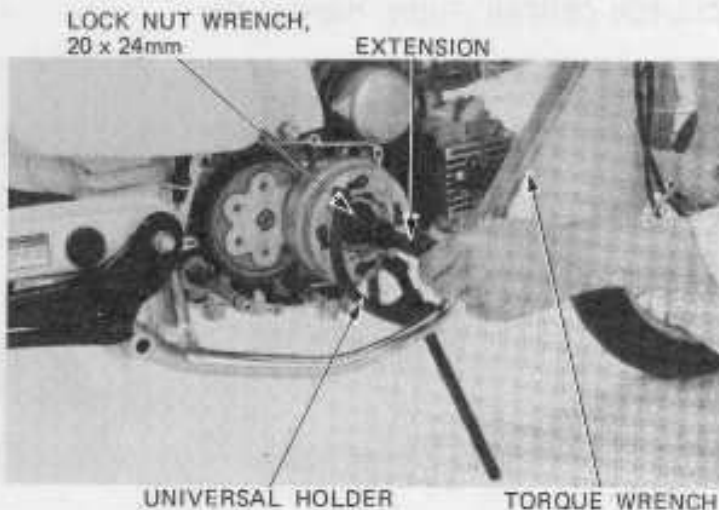



Install the clutch outer cover.
Install the clutch cam and lever.
Install the spring, oil through, clutch cam spring and ball retainer.

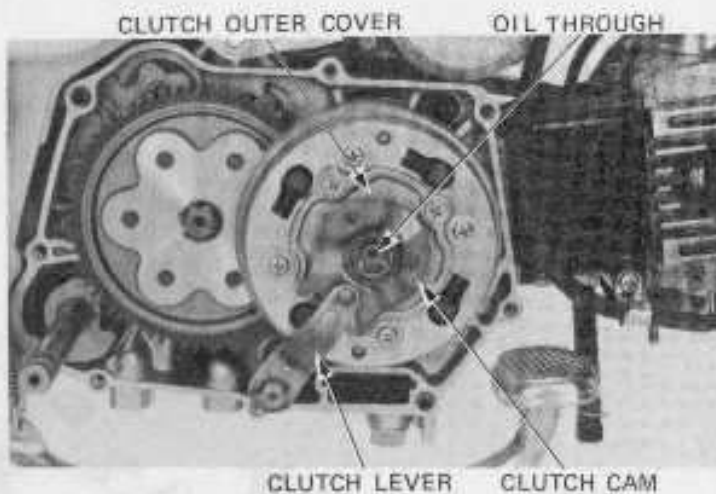

RIGHT CRANKCASE COVER INSTALLATION

Install the clutch adjusting bolt and lifter.

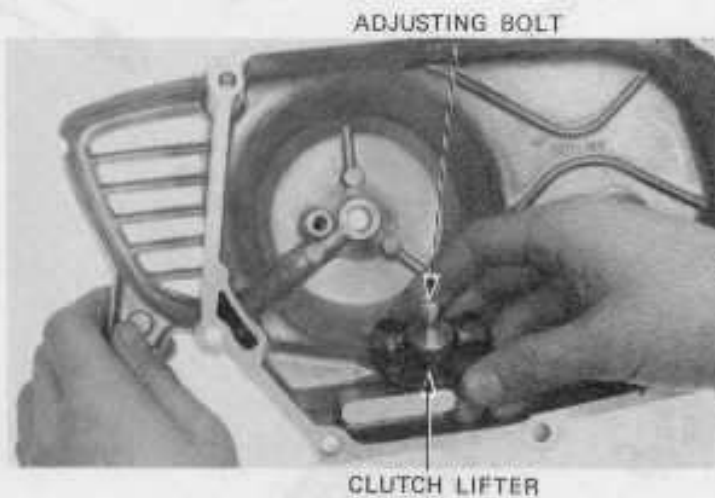

Install the O-ring, washer and lock nut.
Install the right crankcase cover.
Install the kick starter pedal, footpegs/side stand assembly, muffler and front cover.
Fill the crankcase to the proper level with the recommended oil (page 2-2).
Adjust the clutch (page 3-16).

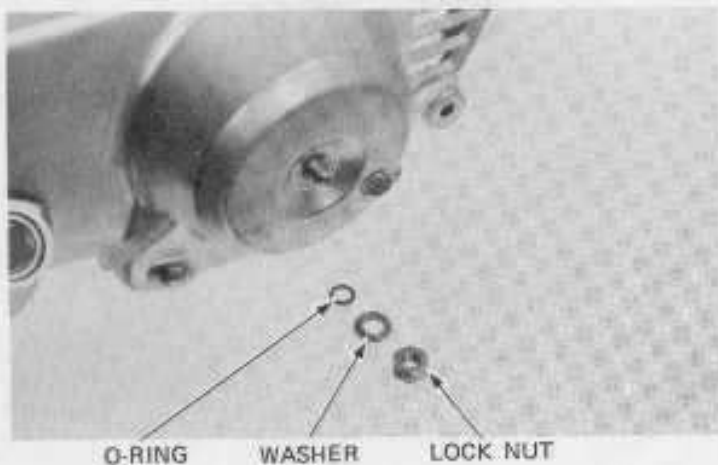

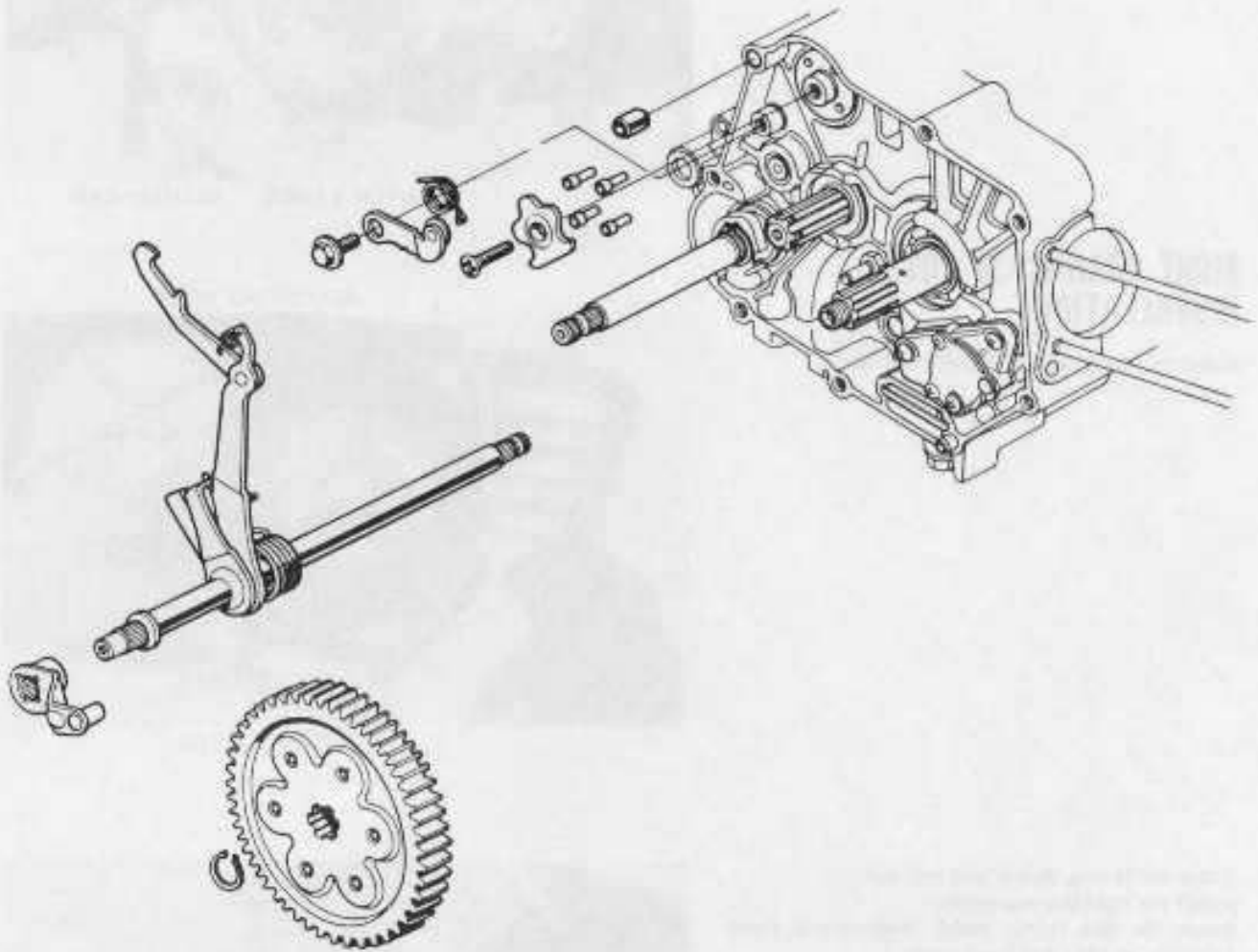



9. GEARSHIFT LINKAGE

SERVICE INFORMATION	9-1	GEARSHIFT LINKAGE INSTALLATION	9-2
TROUBLESHOOTING	9-1		
GEARSHIFT LINKAGE REMOVAL	9-2		

SERVICE INFORMATION

GENERAL INSTRUCTIONS

- The gearshift spindle and stopper arm can be serviced with the engine in the frame.
- If the shift forks, drum and transmission require servicing, remove the engine and separate the crankcase.

TROUBLESHOOTING

Hard shifting

1. Improper clutch adjustment
2. Shift forks bent
3. Shift shaft bent
4. Shift drum stopper bent
5. Shift drum cam groove bent

Transmission jumps out of gear

1. Gear dogs worn
2. Shift shaft bent
3. Shift drum stopper broken
4. Shift forks bent



GEARSHIFT LINKAGE REMOVAL

Drain the engine oil.

Remove the gearshift pedal.

GEARSHIFT PEDAL



Remove the right crankcase cover and clutch assembly (Section B).

Remove the snap ring and driven gear.

DRIVEN GEAR

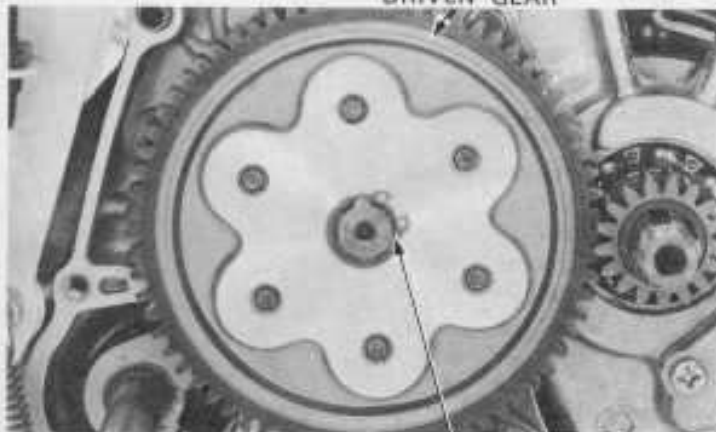

SNAP RING

Remove the drum stopper arm.

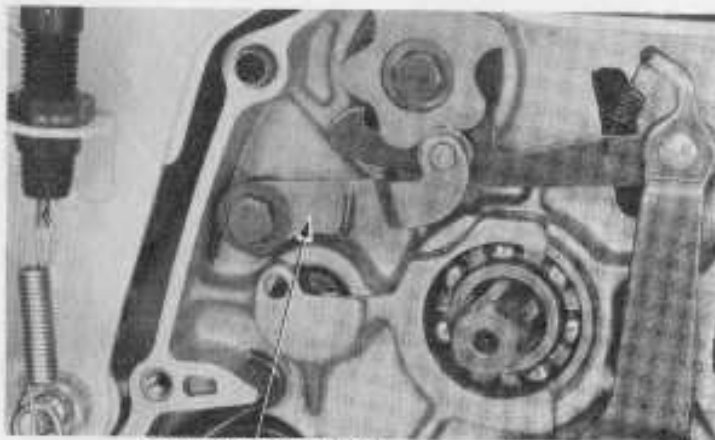

DRUM STOPPER ARM



Remove the drum stopper plate and pins.
Pull the gearshift spindle out of the crankcase.

DRUM STOPPER PLATE



GEARSHIFT LINKAGE INSTALLATION

Install the gearshift drum pins and drum stopper plate.

Install the gearshift spindle assembly.

DRUM STOPPER PLATE

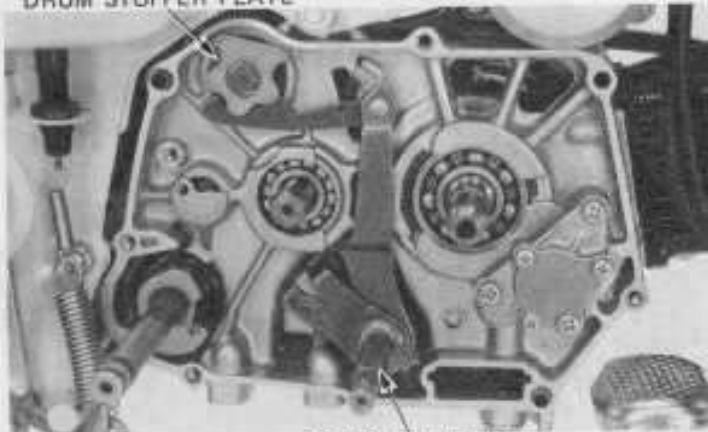

GEARSHIFT SPINDLE

Install the drum stopper arm as shown.
Tighten the pivot bolt.

Rotate the gearshift spindle and check the linkage
for smooth operation.

Install the clutch assembly and right crankcase
cover.

Install the gearshift pedal.

DRUM STOPPER ARM

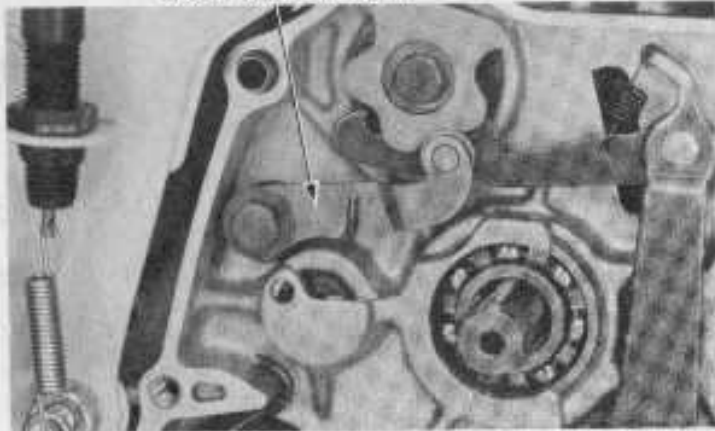

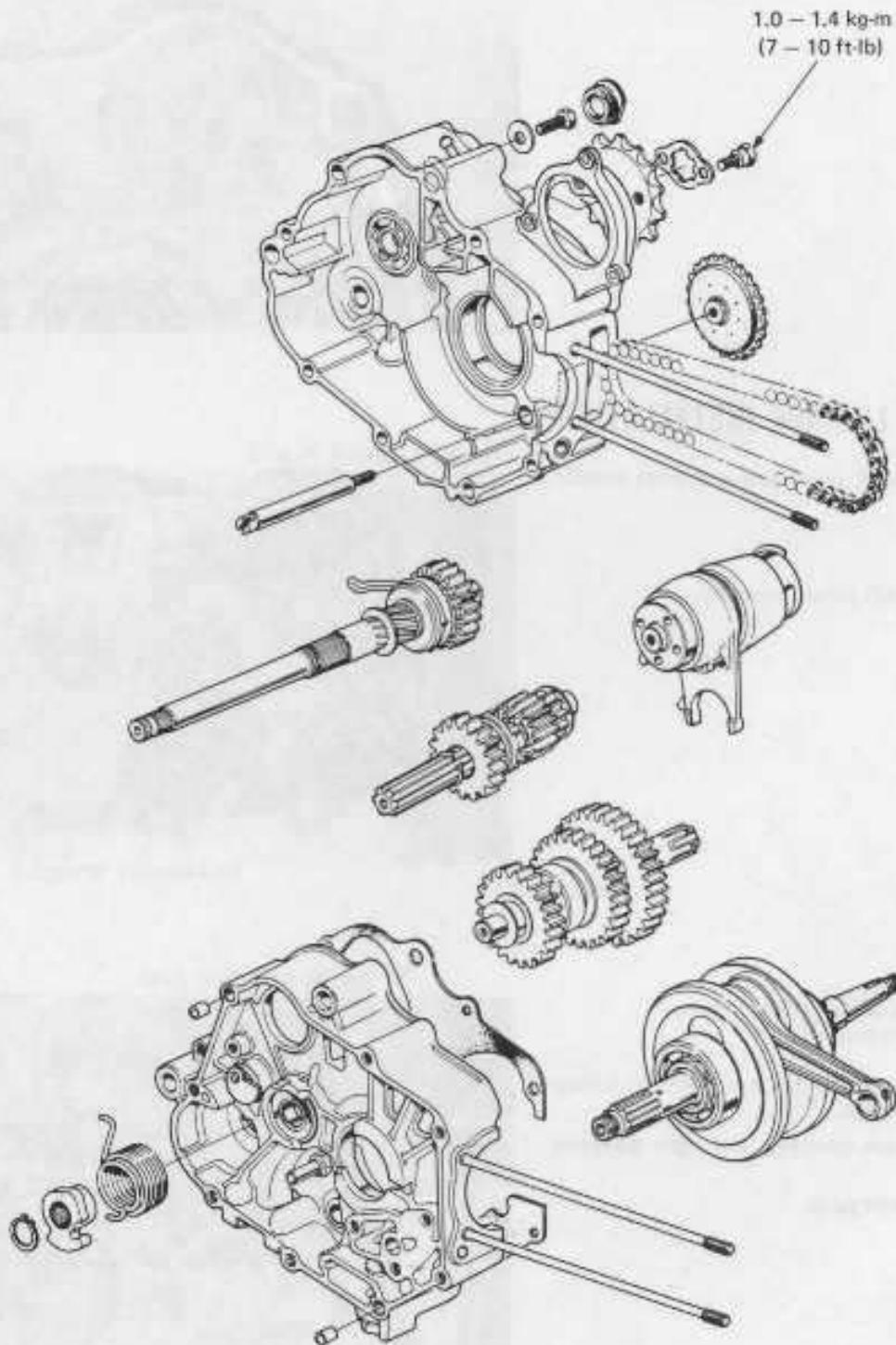



SERVICE INFORMATION	10-1	TRANSMISSION DISASSEMBLY	10-6
TROUBLESHOOTING	10-2	TRANSMISSION ASSEMBLY	10-9
CRANKCASE SEPARATION	10-3	CRANKCASE ASSEMBLY	10-10
CRANKSHAFT REMOVAL	10-4		

SERVICE INFORMATION

GENERAL INSTRUCTIONS

- The crankcase must be separated to service the crankshaft and transmission components.
- The following parts must be removed before separating the crankcase.

Cylinder head	Section 6
Cylinder and piston	Section 7
Clutch	Section 8
Gearshift linkage	Section 9
A.C. generator	Section 14

TORQUE VALUE

Final drive sprocket 1.0 – 1.4 kg-m (7 – 10 ft-lb)

SPECIFICATIONS

ITEM			STANDARD	SERVICE LIMIT
Transmission	Gear I.D.	M2	17.016 – 17.043 mm (0.6699 – 0.6710 in)	17.10 mm (0.673 in)
		C1	17.016 – 17.043 mm (0.6699 – 0.6710 in)	17.10 mm (0.673 in)
		C3	17.016 – 17.043 mm (0.6699 – 0.6710 in)	17.10 mm (0.673 in)
	Mainshaft O.D.		16.983 – 16.994 mm (0.6686 – 0.6691 in)	16.95 mm (0.667 in)
	Countershaft O.D.		16.966 – 16.984 mm (0.6680 – 0.6687 in)	16.95 mm (0.667 in)
	Shift drum O.D.		33.950 – 33.975 mm (1.3366 – 1.3376 in)	33.93 mm (1.336 in)
	Shift fork I.D.		34.000 – 34.025 mm (1.3386 – 1.3396 in)	34.07 mm (1.341 in)
	Shift fork pawl thickness		Left 4.86 – 4.94 mm (0.191 – 0.195 in)	4.6 mm (0.18 in)
		Right 5.86 – 5.94 mm (0.231 – 0.234 in)	5.6 mm (0.22 in)	
Crankshaft	Connecting rod big end side clearance		0.10 – 0.35 mm (0.004 – 0.014 in)	0.6 mm (0.02 in)
	Connecting rod big end radial clearance		0 – 0.012 mm (0 – 0.0005 in)	0.05 mm (0.002 in)
	Runout		_____	0.10 mm (0.004 in)
	Journal bearing play	Axial	_____	0.10 mm (0.004 in)
		Radial	_____	0.05 mm (0.002 in)



TROUBLESHOOTING

Hard to shift

1. Improper clutch adjustment
2. Shift fork bent
3. Shift shaft bent
4. Shift drum stopper arm bent

Transmission jumps out of gear

1. Gear dogs worn
2. Shift shaft bent
3. Shift drum stopper broken
4. Shift forks bent

Excessive noise

1. Excessive crankshaft journal bearing play
2. Excessive crankpin bearing play

SYMPTOM	CAUSE	CORRECTIVE ACTION
Hard to shift	Improper clutch adjustment	Adjust clutch
	Shift fork bent	Replace shift fork
	Shift shaft bent	Replace shift shaft
	Shift drum stopper arm bent	Replace shift drum stopper arm
Transmission jumps out of gear	Gear dogs worn	Replace gear dogs
	Shift shaft bent	Replace shift shaft
	Shift drum stopper broken	Replace shift drum stopper
	Shift forks bent	Replace shift forks
Excessive noise	Excessive crankshaft journal bearing play	Replace crankshaft
	Excessive crankpin bearing play	Replace crankpin



CRANKCASE SEPARATION

Remove the engine (Section 5).
Remove the cylinder head (Section 6).
Remove the cylinder and piston (Section 7).
Remove the clutch (Section 8).
Remove the gearshift linkage (Section 9).
Remove the starting motor (Section 16).
Remove the A.C. generator (Section 14).
Remove the crankshaft cover.
Remove the drive sprocket.

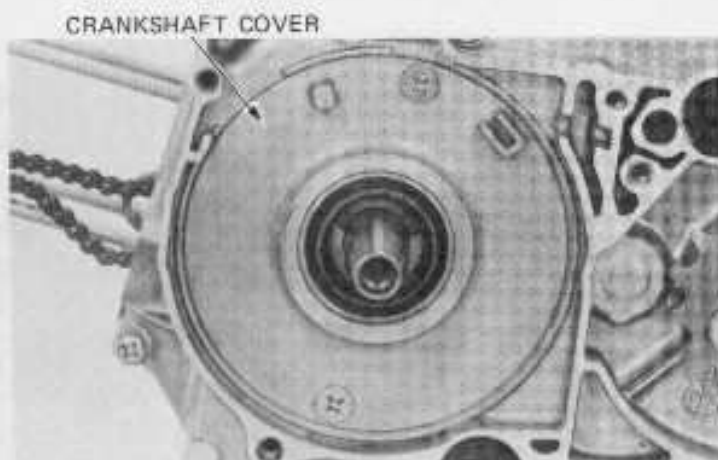

Remove the cam chain tensioner rod and tensioner.
Remove the rubber cap and shift drum mounting 6 mm bolt.
Remove the crankcase 6 mm screws.

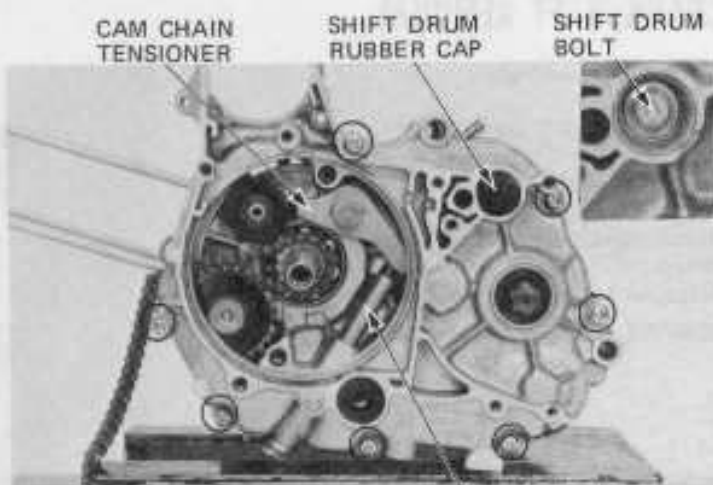

CAM CHAIN TENSIONER PUSH ROD

Place the engine with the left crankcase down.
Remove the snap ring then remove the retainer and kick starter spring.

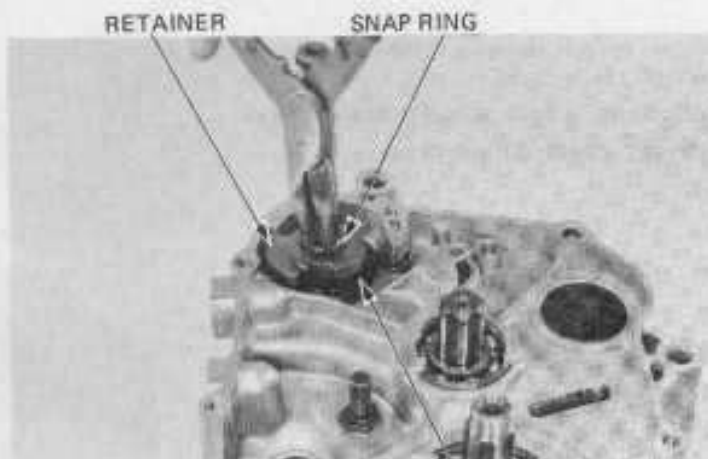

KICK STARTER SPRING



Separate the right crankcase from the left crankcase.
Remove the dowel pins and gasket.

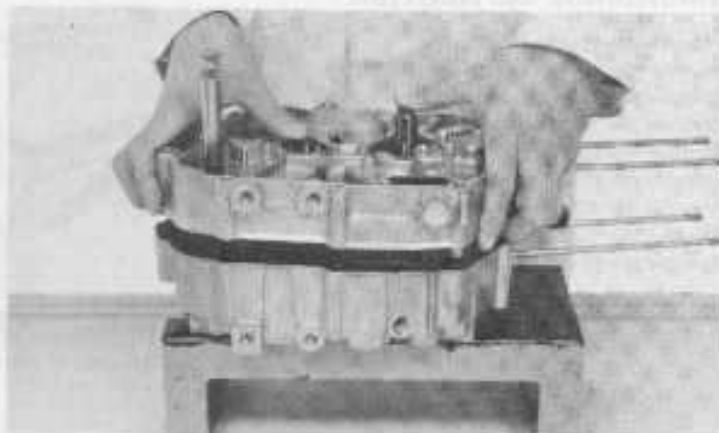

CRANKSHAFT REMOVAL

Remove the crankshaft.

CRANKSHAFT INSPECTION

Set the crankshaft on a stand or V blocks.
Set a dial indicator as shown.
Rotate the crankshaft two revolutions and read the runout.
Actual runout is 1/2 of Total Indicator Reading.
SERVICE LIMIT: 0.10 mm (0.004 in)

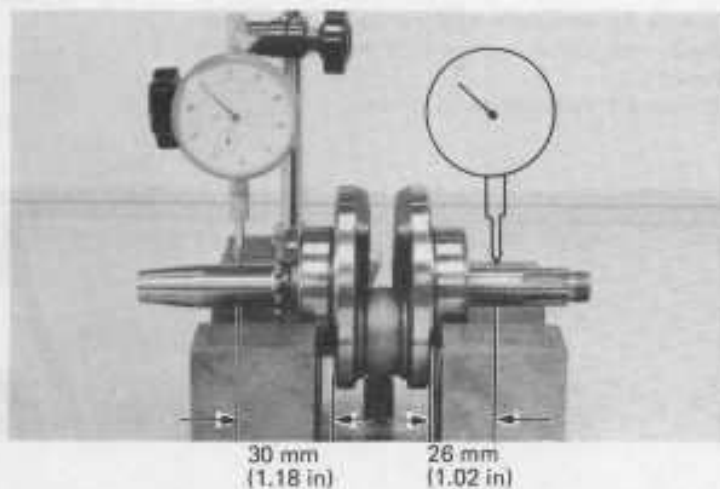

Measure the side clearance at the connecting rod big end with a feeler gauge.

STANDARD: 0.10–0.35 mm (0.004–0.014 in)
SERVICE LIMIT: 0.6 mm (0.02 in)





Measure the radial clearance at the connecting rod big end, at two points in the direction indicated by the arrows.

STANDARD: 0–0.012 mm (0–0.0005 in)

SERVICE LIMIT: 0.05 mm (0.002 in)

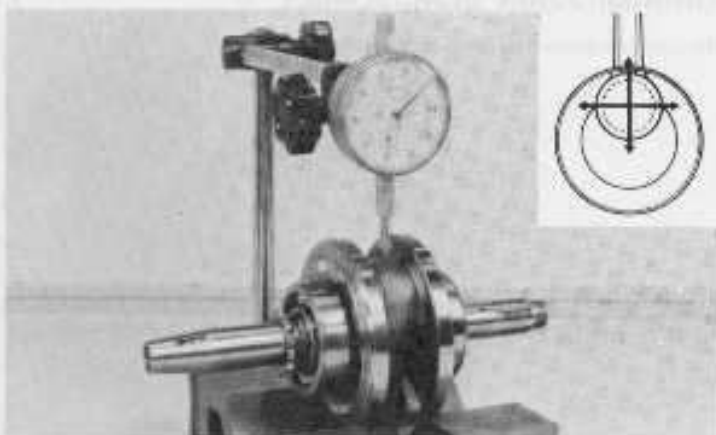

Spin the journal bearing by hand and replace it if noisy.

Check the journal bearing play.

SERVICE LIMIT:

AXIAL: 0.10 mm (0.004 in)

RADIAL: 0.05 mm (0.002 in)

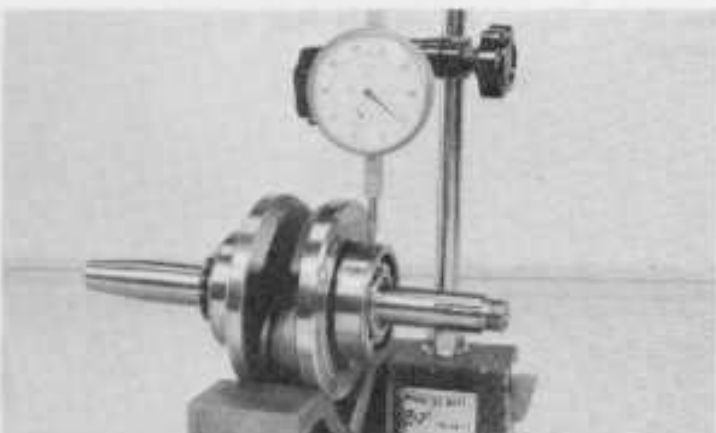

TIMING SPROCKET INSTALLATION

Install the sprocket, aligning any tooth bottom with the keyway-to-crankpin center line.





TRANSMISSION DISASSEMBLY

Remove the crankshaft and kick starter spindle.

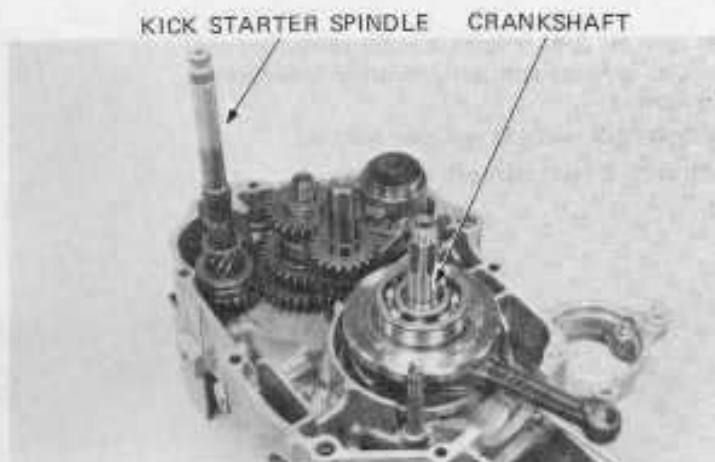

Remove the transmission and shift drum as an assembly.



KICK STARTER SPINDLE DISASSEMBLY

Remove the snap ring and disassemble the kick starter spindle.

Check the driven ratchet, pinion and spindle for excessive wear.





TRANSMISSION GEAR DISASSEMBLY

Disassemble the mainshaft and countershaft.
Inspect each gear for wear or damage.

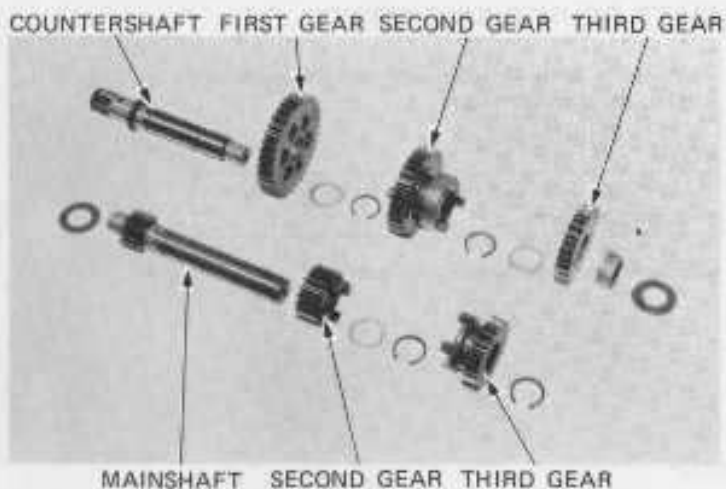

Measure each gear's I.D.

STANDARD: 17.016–17.043 mm
(0.6699–0.6710 in)

SERVICE LIMIT: 17.10 mm (0.673 in)



Measure the O.D. of the mainshaft and countershaft.

STANDARD:

MAINSHAFT: 16.983–16.994 mm
(0.6686–0.6691 in)

COUNTERSHAFT: 16.966–16.984 mm
(0.6680–0.6687 in)

SERVICE LIMIT: 16.95 mm (0.667 in)



SHIFT DRUM DISASSEMBLY

Remove the guide pin clips, pull out the guide pins and remove the shift forks.

NOTE

Mark the right and left shift forks to ensure correct assembly.

Check the guide pin for wear or damage.

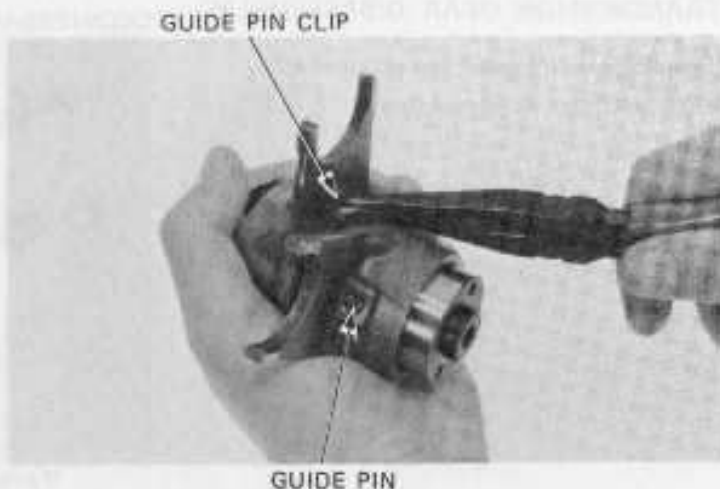

Check the shift fork for wear, bending or other damage.

Measure the shift fork I.D.

STANDARD: 34.000–34.025 mm
(1.3386–1.3396 in)

SERVICE LIMIT: 34.07 mm (1.341 in)



Measure the shift fork claw thickness.

STANDARD:

LEFT: 4.86–4.94 mm (0.191–0.195 in)

RIGHT: 5.86–5.94 mm (0.231–0.234 in)

SERVICE LIMIT:

LEFT: 4.6 mm (0.18 in)

RIGHT: 5.6 mm (0.22 in)





Check the shift drum for wear or damage.
Measure the shift drum O.D.

STANDARD: 33.950–33.975 mm
(1.3366–1.3376 in)

SERVICE LIMIT: 33.93 mm (1.336 in)



TRANSMISSION ASSEMBLY

Assemble the mainshaft and countershaft gears and secure with the snap rings.

NOTE

Lubricate each gear with engine oil after assembly.

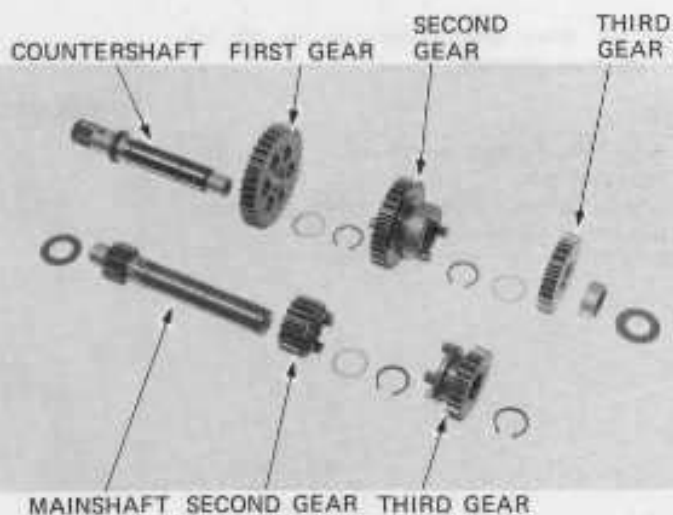

SHIFT DRUM ASSEMBLY

Install the shift forks on the shift drum.
Install the guide pins and secure with the clips.

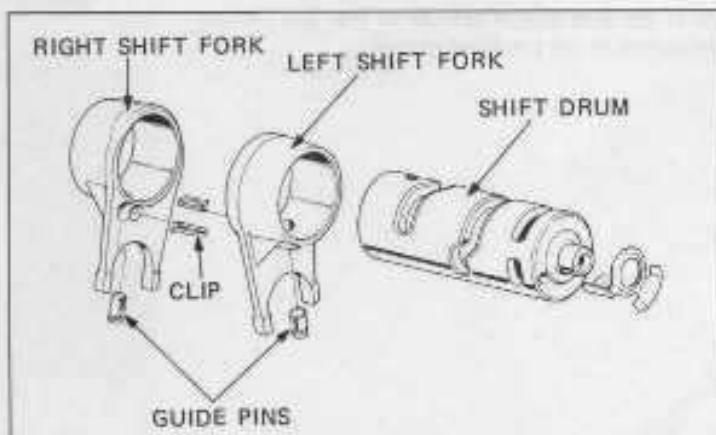



KICK STARTER SPINDLE ASSEMBLY

Assemble the kick starter as shown.

NOTE

Position the friction spring in the driven ratchet groove.

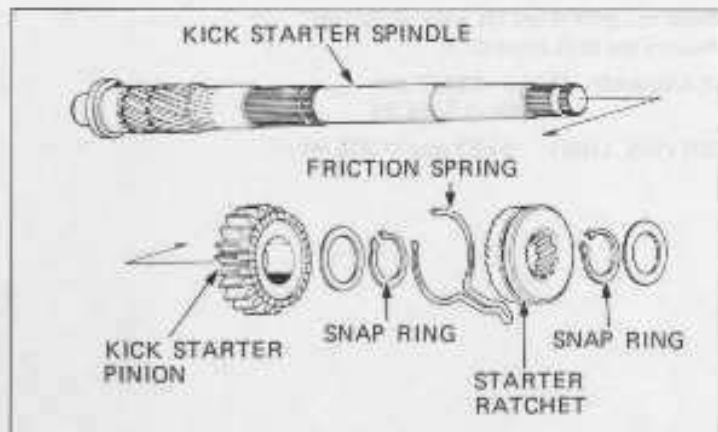

TRANSMISSION INSTALLATION

Install the drum and transmission in the left crankcase as an assembly.

NOTE

- Align the neutral switch rotor with the neutral switch.
- After installing, rotate the mainshaft to make sure that the gears rotate freely.

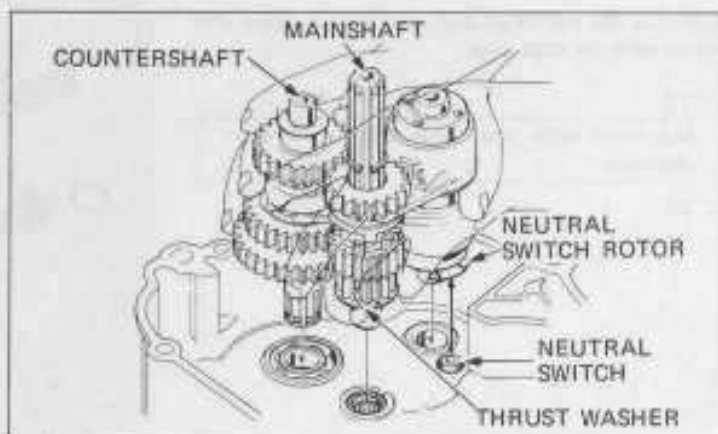

Install the kick starter spindle so that the friction spring rests in the crankcase groove.





CRANKCASE ASSEMBLY

- Install the crankshaft into the left crankcase.
- Install the dowel pins and gasket.
- Place the right crankcase onto the left crankcase and turn the crankcase assembly over.
- Install and tighten the crankcase screws.

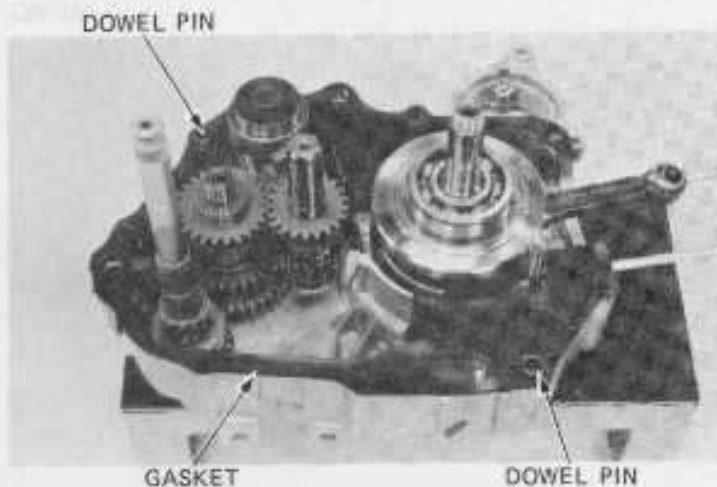

- Install the cam chain, tensioner and tensioner rod.
- Install the shift drum 6 mm mounting bolt and rubber cap.
- Install the final drive sprocket.
- TORQUE: 1.0–1.4 kg-m (7–10 ft-lb)**

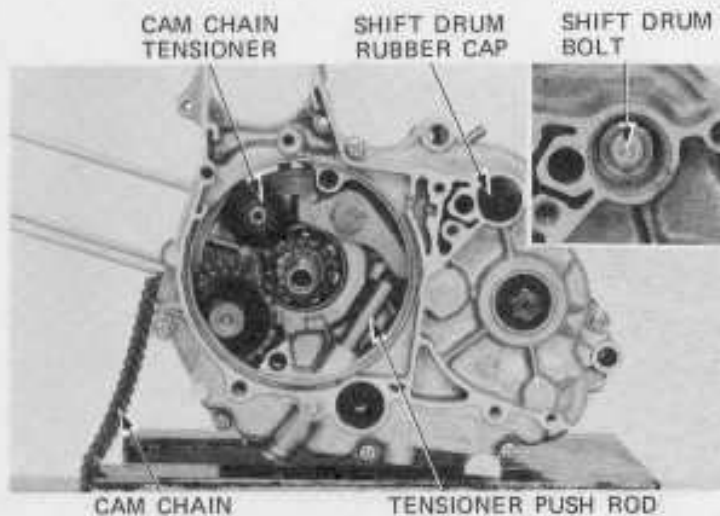

- Install the kick starter spring and retainer.
- Hook the spring ends in the retainer groove and over the crankcase projection.
- Install the snap ring.
- Install the A.C. generator (Section 14).
- Install the starter motor (Section 16).
- Install the gearshift linkage (Section 9).
- Install the clutch (Section 8).
- Install the cylinder and piston (Section 7).
- Install the cylinder head (Section 6).
- Install the engine (Section 5).

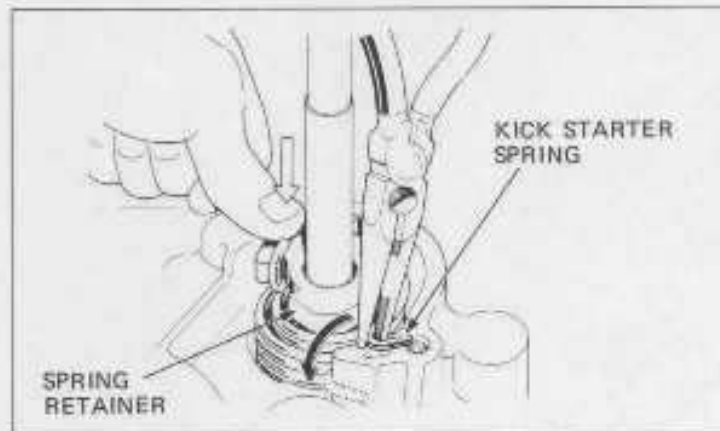



MEMO

TRAINING ASSEMBLY

1. The purpose of this training assembly is to provide the necessary information for the correct assembly of the engine components.

2. The following instructions should be followed carefully to ensure proper assembly and operation of the engine.



3. The following instructions should be followed carefully to ensure proper assembly and operation of the engine.

4. The following instructions should be followed carefully to ensure proper assembly and operation of the engine.

5. The following instructions should be followed carefully to ensure proper assembly and operation of the engine.

6. The following instructions should be followed carefully to ensure proper assembly and operation of the engine.



SERVICE INFORMATION	11-1	CAM CHAIN TENSIONER	
GENERAL INSTRUCTION		PUSH ROD	11-2
TROUBLESHOOTING	11-1	CAM CHAIN TENSIONER	11-3

SERVICE INFORMATION

GENERAL INSTRUCTION

The cam chain tensioner and push rod can be serviced with the engine in the frame.

TROUBLESHOOTING

Cam chain noise

1. Incorrect tensioner adjustment
2. Damaged spring
3. Worn or damaged sprocket
4. Worn or damaged chain

CAM CHAIN TENSIONER PUSH ROD

- Drain the engine oil.
- Loosen the lock nut and remove the lock bolt.
- Remove the sealing bolt and washer.
- Remove the adjusting bolt, springs and tensioner rod.
- Check the tensioner rod and spring for damage.

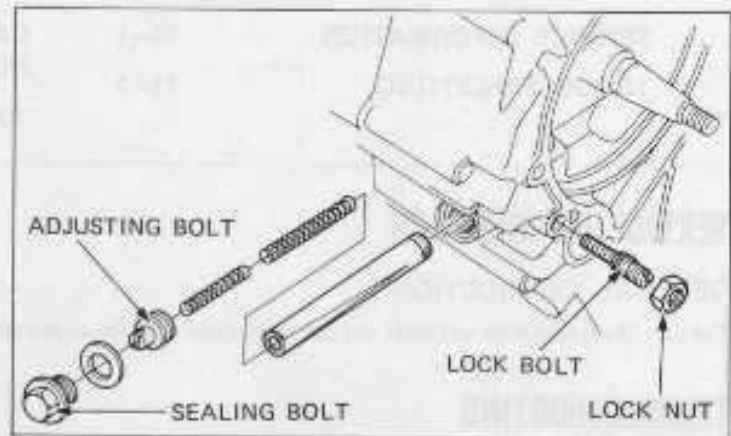

- Install the tensioner push rod with the taper facing lock bolt.

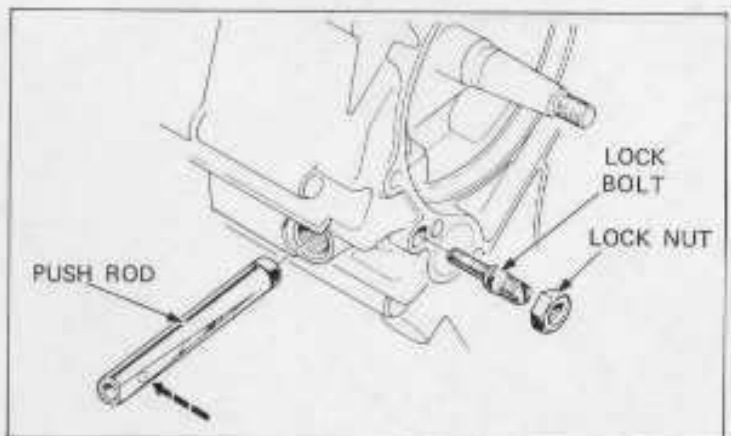

- Install the springs.
- Screw adjusting bolt into the crankcase.
- Install the sealing washer and bolt.

NOTE

The sealing bolt end must not contact the bottom of the adjusting bolt.

- Install lock bolt and lock nut.
- Tighten the lock nut.

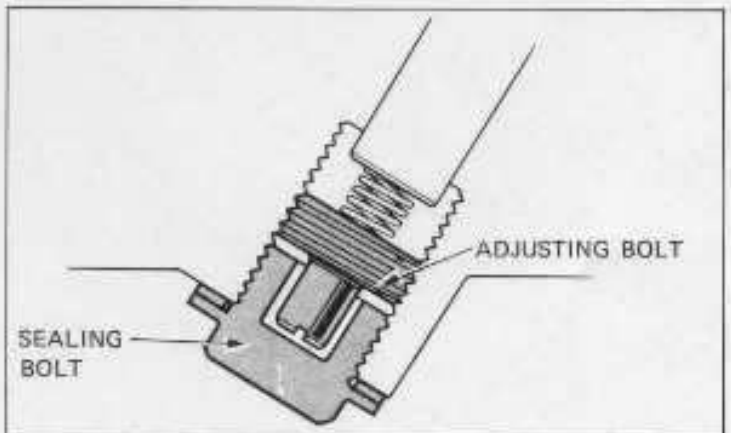



CAM CHAIN TENSIONER

Remove the A.C. generator and flywheel (Section 14).

Remove the starter chain guide.

Remove the starter chain protector.

Remove the starter sprockets and chain as a unit.

Remove the crankshaft cover.

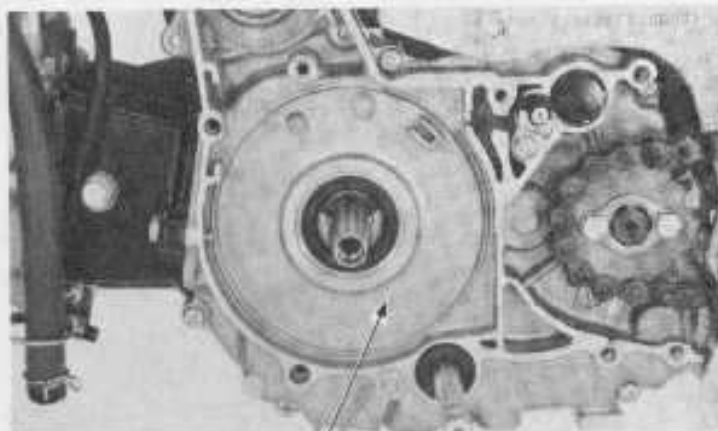

CRANKSHAFT COVER

Remove the tensioner push rod.

Remove the cam chain tensioner.

Check the tensioner sprocket for wear or damage.

Installation is the reverse of removal.

NOTE

Be sure to install O-rings on the crankshaft cover screw holes.

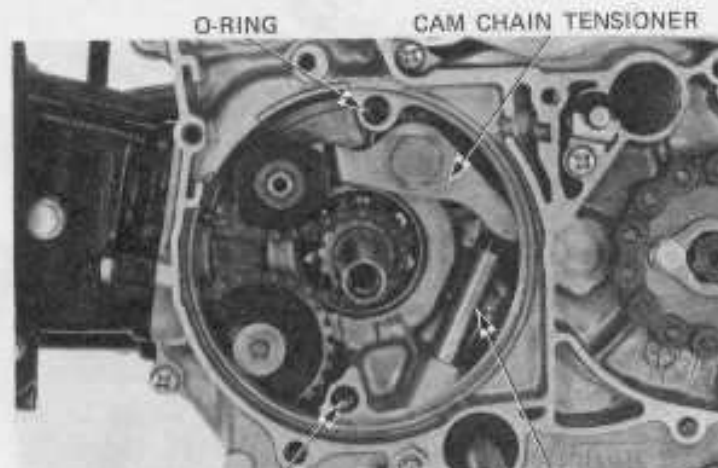

O-RING TENSIONER PUSH ROD

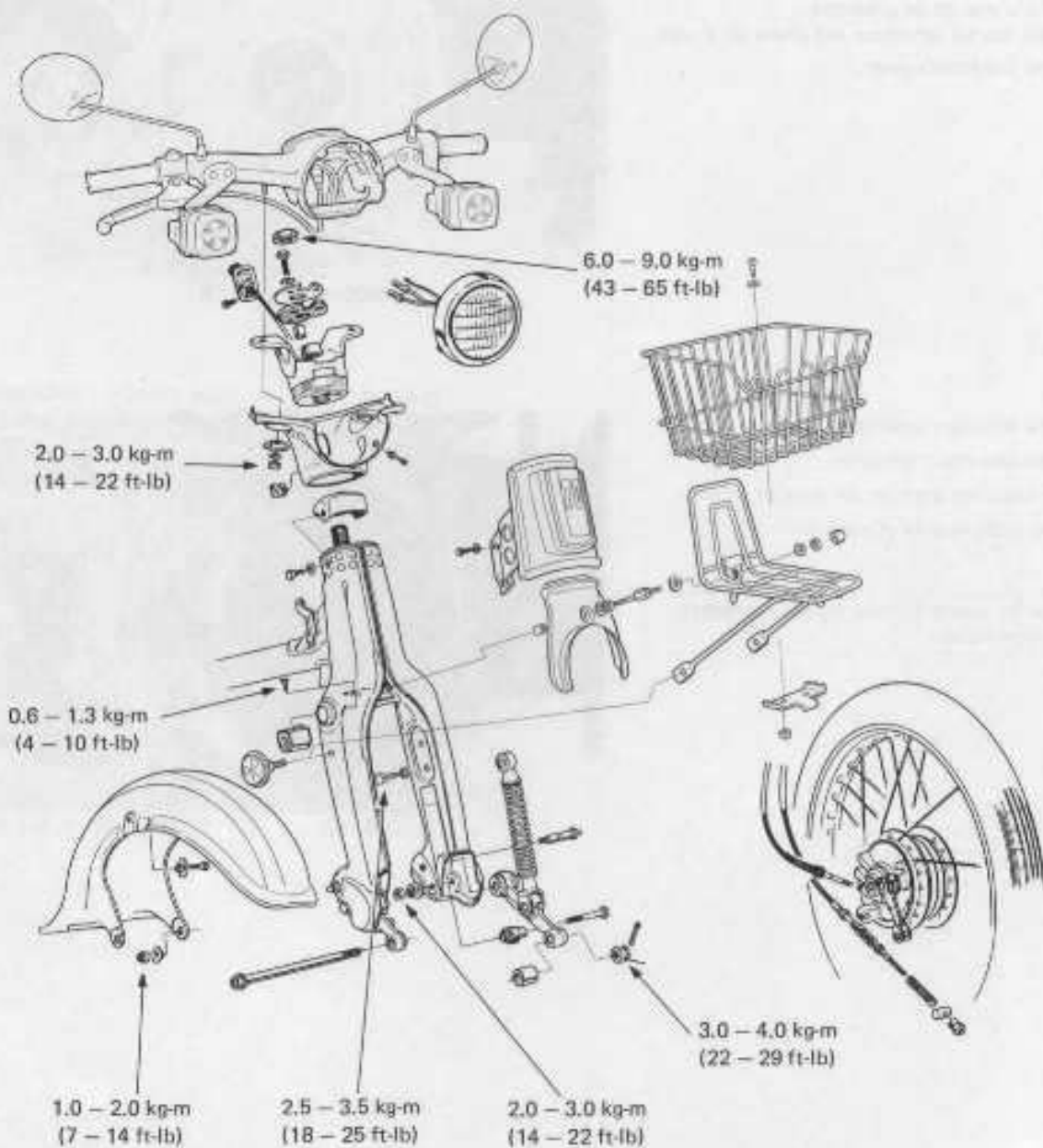



SERVICE INFORMATION	12-1	HANDLEBAR	12-5
TROUBLESHOOTING	12-2	FRONT WHEEL	12-8
HEADLIGHT	12-3	FRONT SHOCK ABSORBER	12-12
INSTRUMENTS	12-3	FRONT FORK/STEERING STEM	12-16

SERVICE INFORMATION

GENERAL INSTRUCTIONS

- A jack or other support is required to support the motorcycle.
- Route all cables and wires properly (page 1-6).

TOOLS

Special

Pin spanner

07902-0010000

Ball race remover

17946-1790000 – M9310-277-91774, U.S.A. only

Common

Bearing driver handle A

07749-0010000 – 07949-6110000

Bearing driver outer, 32 x 35 mm

07746-0010100] – 07946-9370100

Bearing driver pilot, 10 mm

07746-0040100

Lock nut wrench, 26 x 30 mm

07716-0020202

Extension bar, 1/2 in drive x 3 in (75 mm)

07716-0020500 – commercially available

TORQUE VALUES

Steering stem nut

6.0 – 9.0 kg-m (43 – 65 ft-lb)

Handlebar setting nut

2.0 – 3.0 kg-m (14 – 22 ft-lb)

Steering lock

0.6 – 1.3 kg-m (4 – 10 ft-lb)

Front axle nut

3.0 – 4.0 kg-m (22 – 29 ft-lb)

Front suspension pivot bolt

1.0 – 2.0 kg-m (7 – 14 ft-lb)

Front suspension stopper bolt

2.0 – 3.0 kg-m (14 – 22 ft-lb)

Front shock absorber upper bolt

2.5 – 3.5 kg-m (18 – 25 ft-lb)

SPECIFICATIONS

	STANDARD	SERVICE LIMIT
Wheel bearing play	_____	0.03 mm (0.001 in)
Front wheel runout	Radial	2.0 mm (0.08 in)
	Axial	2.0 mm (0.08 in)
Front axle runout	_____	0.2 mm (0.01 in)
Front brake drum I.D.	109.8 – 110.2 mm (4.32 – 4.34 in)	111 mm (4.4 in)
Front brake lining thickness	3.9 – 4.0 mm (0.154 – 0.158 in)	2.0 mm (0.08 in)
Front shock absorber spring free length	170.6 mm (6.72 in)	165.5 mm (6.52 in)
Suspension arm pivot bushing O.D.	13.96 – 13.98 mm (0.550 – 0.551 in)	13.55 mm (0.533 in)
Suspension arm pivot collar I.D.	14.00 – 14.10 mm (0.551 – 0.555 in)	14.47 mm (0.570 in)
Shock lower mount bushing O.D.	11.96 – 11.98 mm (0.471 – 0.472 in)	11.61 mm (0.457 in)
Shock lower mount collar I.D.	12.00 – 12.10 mm (0.472 – 0.476 in)	12.41 mm (0.489 in)

TROUBLESHOOTING

Hard steering

1. Steering stem bearing adjusting nut too tight
2. Faulty steering stem bearings
3. Damaged steering stem bearings
4. Insufficient tire pressure

Steers to one side or does not track straight

1. Faulty right or left shock absorber
2. Bent front fork arm
3. Bent front axle; wheel installed incorrectly

Front wheel wobble

1. Distorted rim
2. Worn front wheel bearings
3. Faulty tire
4. Axle not tightened properly
5. Worn front suspension arm bushing
6. Loose or bent spokes

Soft suspension

1. Weak shock absorber spring

Stiff suspension

1. Lack of grease in suspension arm bushings

Front suspension noise

1. Worn suspension arm bushings
2. Damaged rebound stopper
3. Loose shock absorber fasteners
4. Lack of grease in suspension arm bushings
5. Lack of grease in speedometer gear housing



HEADLIGHT

REMOVAL

Remove the headlight mounting screws.

Disconnect the headlight wire connectors and remove the headlight.



DISASSEMBLY/ASSEMBLY

Remove the horizontal and vertical adjusting screws from the rim.

Remove the clip and sealed beam unit retaining screw, and sealed beam unit.

Assembly is the reverse of disassembly. After assembly, adjust the headlight beam (page 3-15).

SEALED BEAM RETAINING SCREW



HORIZONTAL
ADJUSTING SCREW

VERTICAL
ADJUSTING SCREW

INSTRUMENTS

REMOVAL

Remove the headlight.

Remove the handlebar mounting nuts.





Raise the handlebar and remove the speedometer setting spring.

Disconnect the speedometer cable.

NOTE

Do not allow the cable nut to fall into the steering stem.

Disconnect the speedometer and indicator bulb wire connectors.

Remove the speedometer.

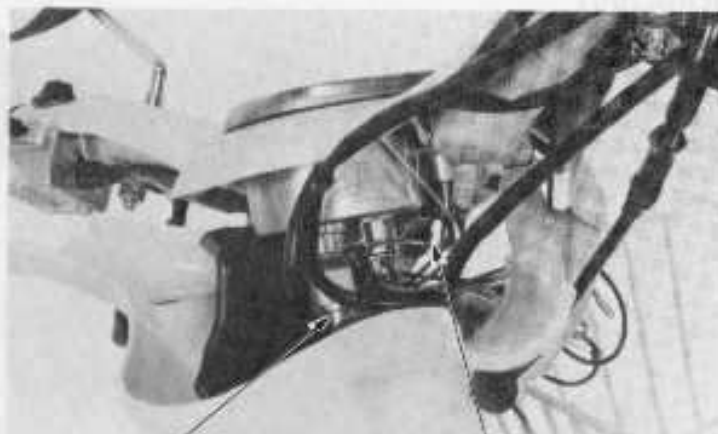

SPEEDOMETER CABLE

SETTING SPRING

Remove the bulbs.

NOTE

If a replacement bulb does not light, check the wiring for a short or open circuit, or for loose connections.

SPEEDOMETER LIGHT

HIGH BEAM INDICATOR

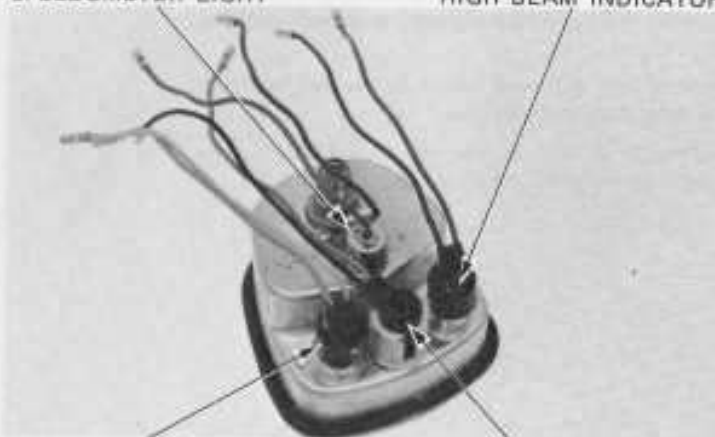

TURN SIGNAL INDICATOR

NEUTRAL INDICATOR

INSTALLATION

Install the speedometer with the setting spring.

Install the handlebar.



HANDLEBAR

REMOVAL

Remove the headlight.

Disconnect the speedometer wires.



Remove the right handlebar switch mounting screws.



Disconnect the throttle cable end and remove the throttle grip.





Remove the left handlebar switch mounting screws.
Remove the mirrors.



Remove the turn signals.
Remove the left grip.
Remove the handlebar mounting nuts.
Raise the handlebar and unclamp the wiring harnesses.
Remove the speedometer setting spring and speedometer.
Remove the handlebar assembly.



HANDLEBAR MOUNTING NUT

INSTALLATION

Install the left grip.
Install the speedometer into the handlebar with the setting spring.
Clamp the wiring harnesses into place.
Place the handlebar on its mount and connect the speedometer cable.
Install the handlebar mounting nuts.
TORQUE: 2.0–3.0 kg-m (14–22 ft-lb)
Install the mirrors.



HANDLEBAR MOUNTING NUT



Install the left handlebar switch mounting screws.
Apply grease to the throttle grip sliding surface.
Connect the throttle cable end to the throttle grip.



Align the right handlebar switch tang with the handlebar recess and install the switch.

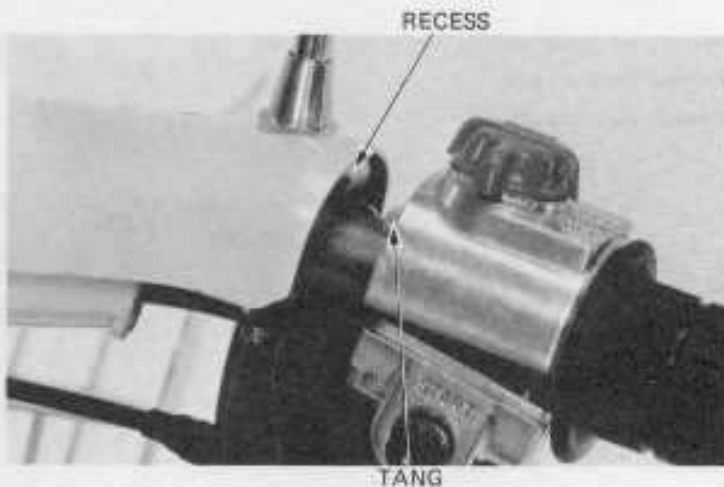

Install the headlight (page 12-3) and connect the speedometer wires.
Adjust throttle cable free play (page 3-3).

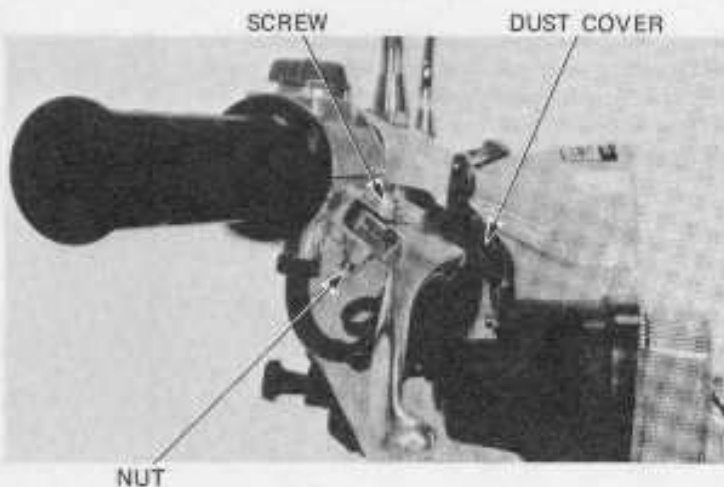



FRONT WHEEL

REMOVAL

Raise the front wheel off the ground by placing a support block under the engine.

Loosen the speedometer cable nut and remove the speedometer cable.

Remove the front brake adjusting nut and disconnect the brake cable from the brake arm.

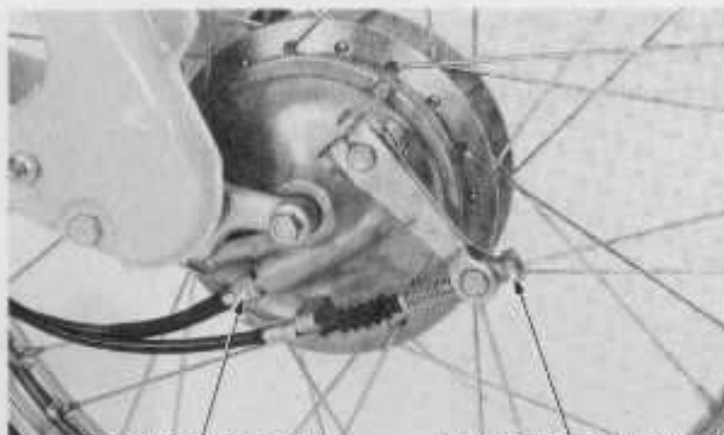

SPEEDOMETER CABLE

BRAKE ADJUSTING NUT

Remove the cotter pin and loosen the axle nut.

Remove the front axle.

Remove the front wheel.

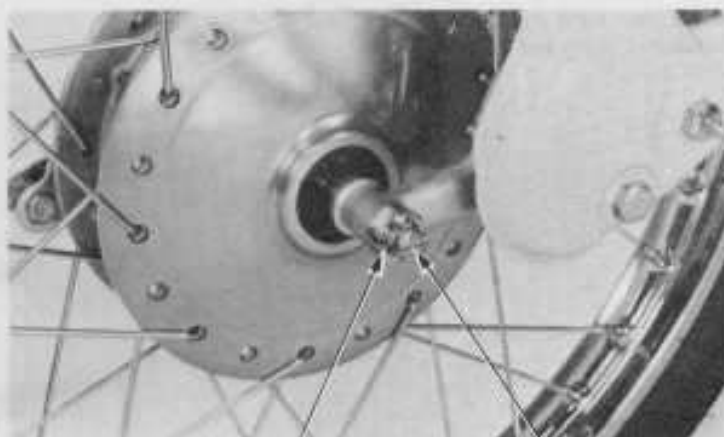

AXLE NUT

COTTER PIN

WHEEL BEARING INSPECTION

Check wheel bearing play by placing the wheel in a truing stand and spinning the wheel by hand. Replace the bearings with new ones if they are noisy or have excessive play.

SERVICE LIMIT: 0.03 mm (0.001 in)

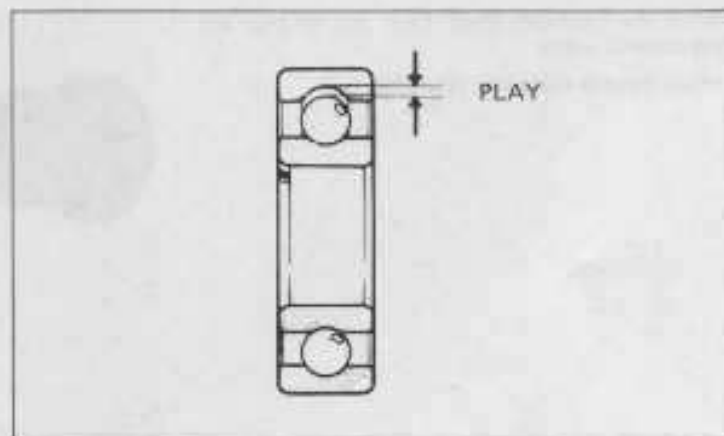



WHEEL BEARING REPLACEMENT

Remove the seal.

Remove the bearings and distance collar from the hub.

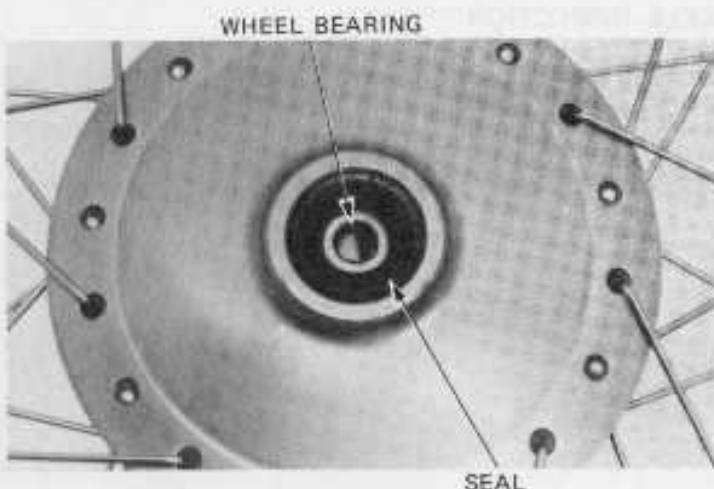

Pack the bearing with grease.
Drive in the right bearing first.
Press the distance collar into place.

NOTE

Be certain the distance collar is in position before installing the left bearing.

Drive in the left bearing.

NOTE

- Drive the bearings squarely.
- Drive the bearing into position, making sure that it is fully seated and that the sealed side is facing out.

Install the seal.

BEARING DRIVER HANDLE A - 07949-6110000
 BEARING DRIVER OUTER, 32 x 35 mm } - 07946-8370100
 BEARING DRIVER PILOT, 10 mm



WHEEL INSPECTION

Check the rim runout by placing the wheel in a truing stand. Spin the wheel slowly and read the runout using a dial indicator.

SERVICE LIMIT:

RADIAL RUNOUT: 2.0 mm (0.08 in)
 AXIAL RUNOUT: 2.0 mm (0.08 in)

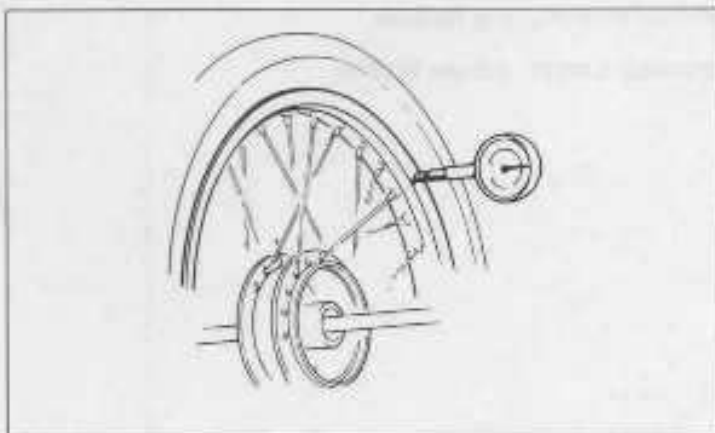



AXLE INSPECTION

Set the axle in V blocks and measure the runout. The actual runout is 1/2 of the total indicator reading.

SERVICE LIMIT: 0.2 mm (0.01 in)

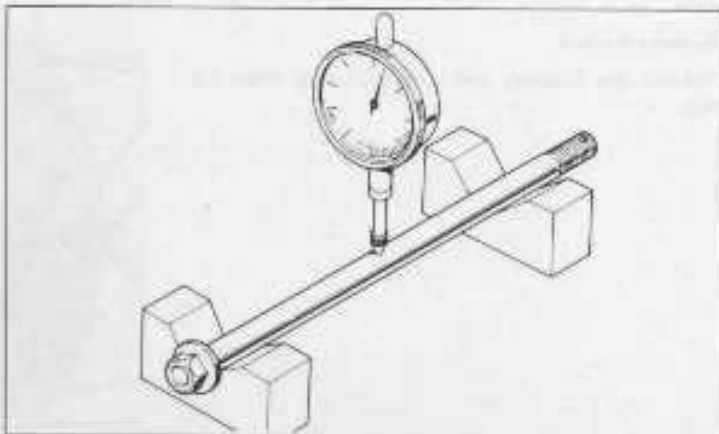

BRAKE DRUM I.D. INSPECTION

Measure the brake drum inside diameter.

SERVICE LIMIT: 111 mm (4.4 in)

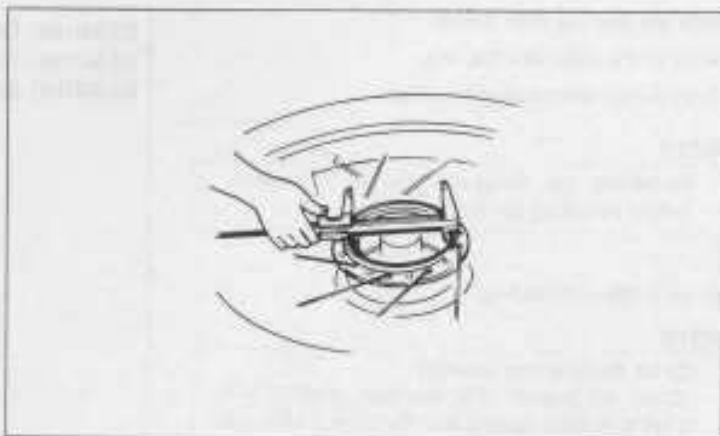

BRAKE LINING THICKNESS INSPECTION

Measure the brake lining thickness.

SERVICE LIMIT: 2.0 mm (0.08 in)

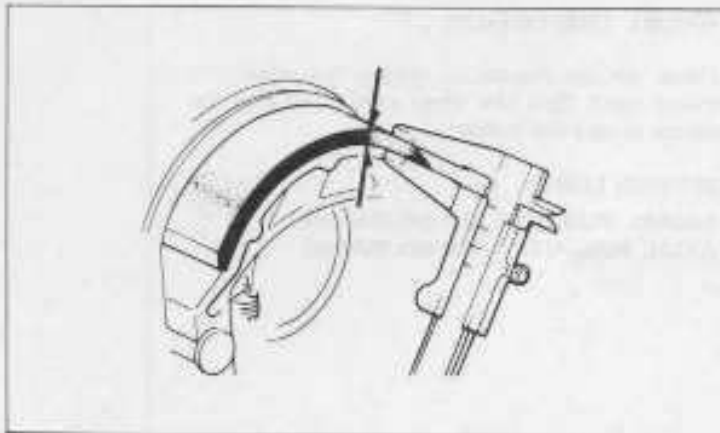



BRAKE PANEL DISASSEMBLY

Remove the brake arm, indicator plate and return spring.

Remove the brake shoes and brake cam.

Remove the speedometer gear.

Remove the seal.

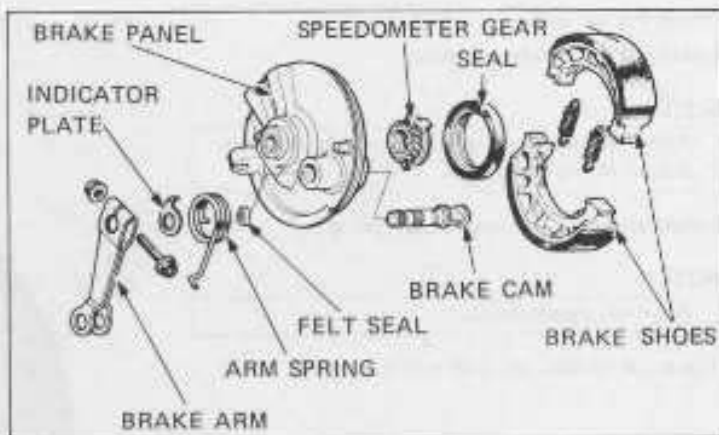

BRAKE PANEL ASSEMBLY

Apply grease to the speedometer gear and install the gear.

Install the seal.



Apply grease to the sliding surface of the brake cam. Install the brake cam.

Install the brake shoes and shoe springs.

WARNING

*Contaminated brake linings reduce stopping power.
Keep grease off the linings.*

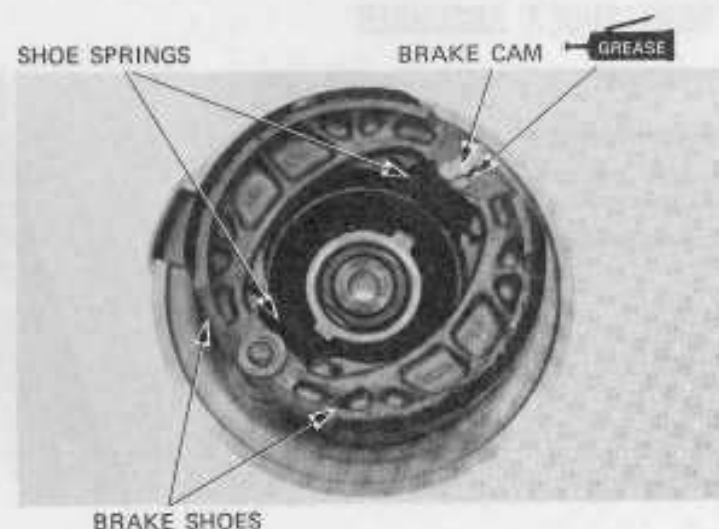



Install the felt seal.
Install the wear indicator plate.

NOTE

Align the indicator plate inner tab with the cutout of the brake cam.

Install the brake arm and return spring.

NOTE

Align the punch marks.

Tighten the brake arm bolt and nut.

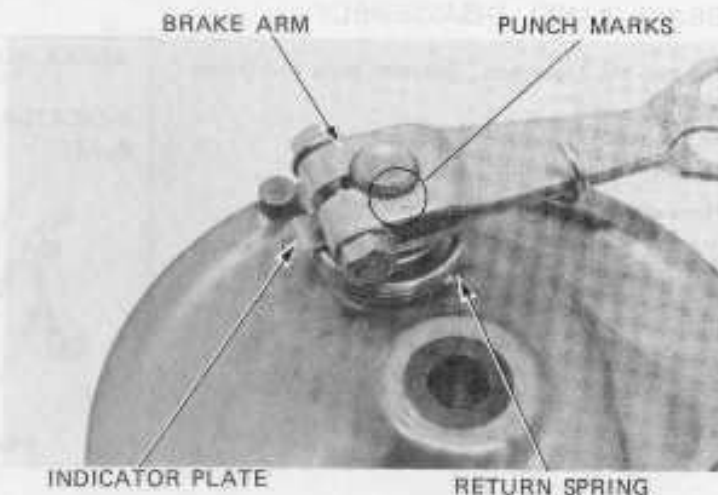
**INSTALLATION**

Install the front wheel between the fork legs.

NOTE

Make sure the tang on the right suspension arm is located in the groove of the brake panel.

Install the axle shaft from the right side.

Tighten the axle nut.

TORQUE: 3.0–4.0 kg-m (22–29 ft-lb)

Install a new cotter pin.

Connect the front brake and speedometer cables.

Adjust the front brake (page 3-14).

SPEEDOMETER CABLE

AXLE NUT

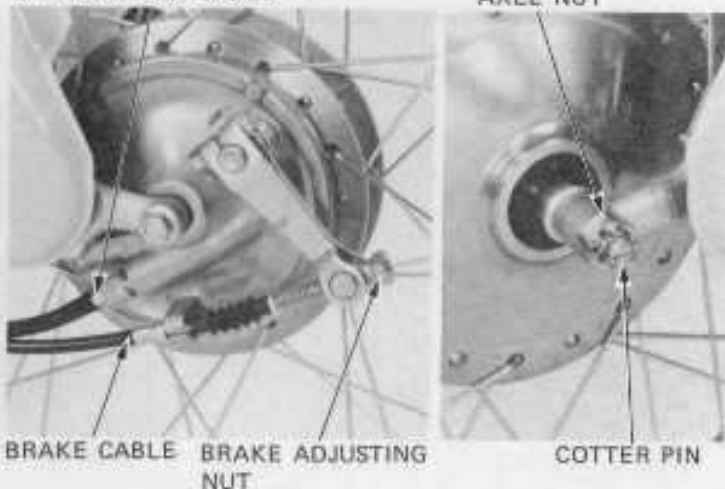

BRAKE CABLE

BRAKE ADJUSTING NUT

COTTER PIN

FRONT SHOCK ABSORBER**REMOVAL**

Remove the front wheel (page 12-8).

Remove the front shock absorber and rebound stopper mounting bolts and nuts.

Remove the shock absorbers.

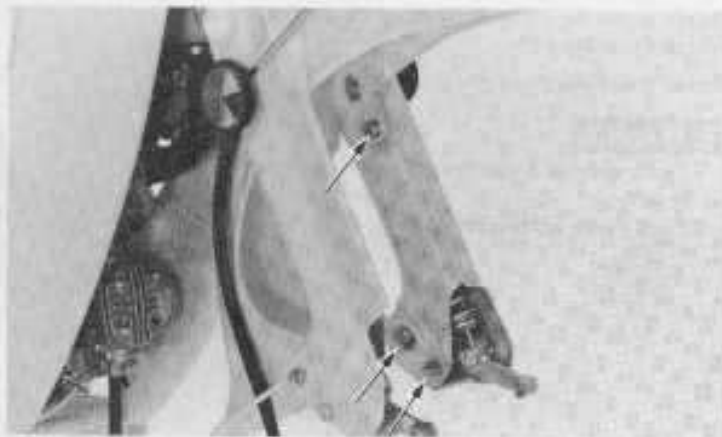



DISASSEMBLY

Remove the lower shock absorber mounting bolt and separate the suspension arm from the shock absorber.

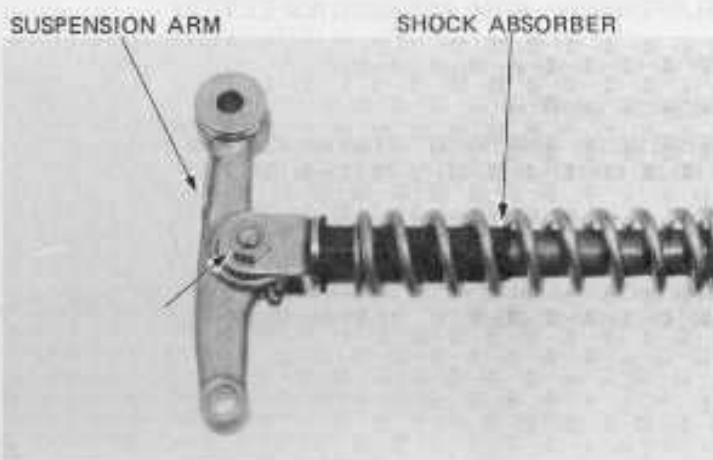

Remove the dust caps and disassemble the suspension arm.

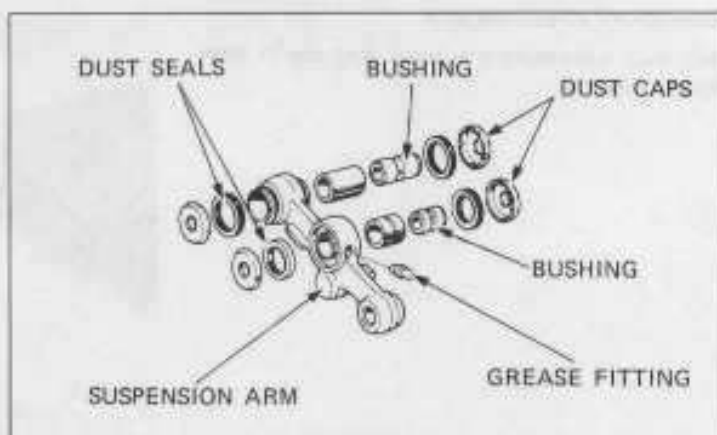

SHOCK ABSORBER INSPECTION

Inspect the shock body for oil leaks.

Measure the free length of spring.

SERVICE LIMIT: 165.5 mm (6.52 in)

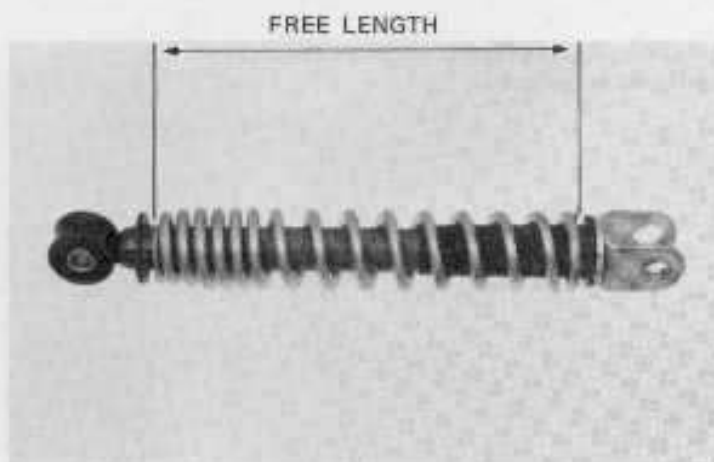

SUSPENSION ARM BUSHING INSPECTION

Measure the bushing outside diameter.

SERVICE LIMIT:

SUSPENSION ARM PIVOT: 13.55 mm (0.533 in)

SHOCK LOWER MOUNT: 11.61 mm (0.457 in)

Measure the bushing collar inside diameter.

SERVICE LIMIT:

SUSPENSION ARM PIVOT: 14.47 mm (0.570 in)

SHOCK LOWER MOUNT: 12.41 mm (0.489 in)

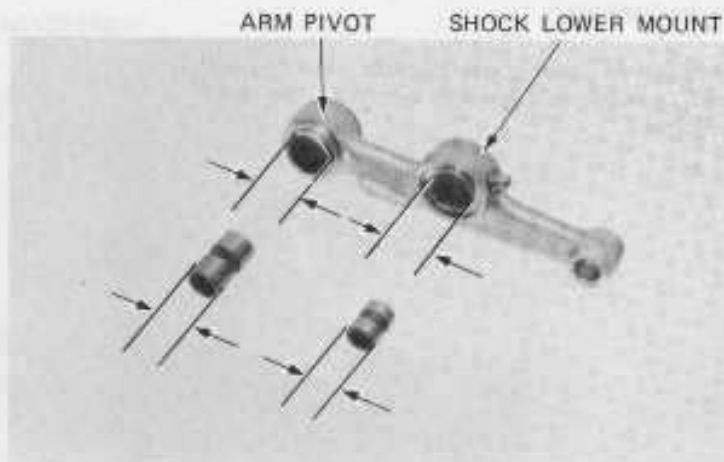

ASSEMBLY

Assemble the suspension arms.

Peen each suspension arm pivot dust cap in three places as shown.

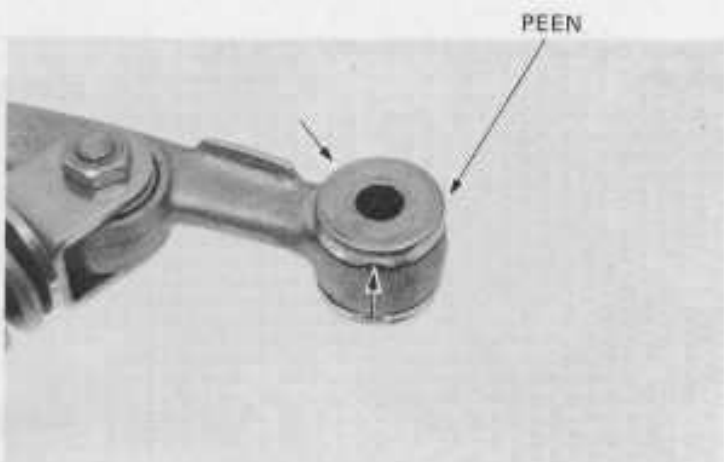

Install the suspension arm to the shock absorber and tighten the bolt and nut.

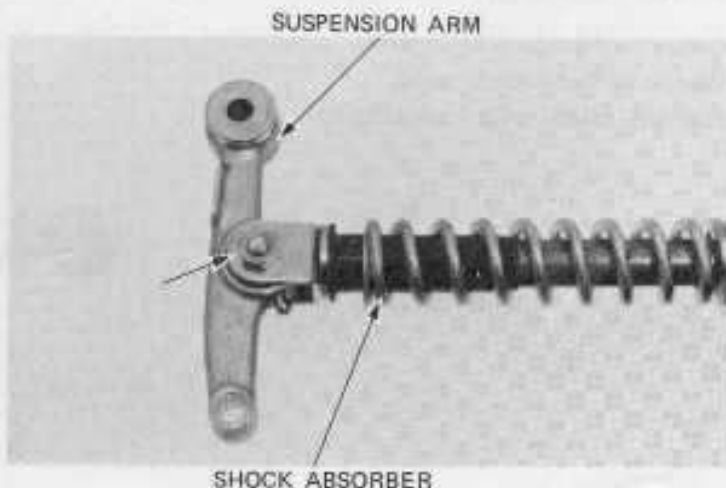



INSTALLATION

Install the shock absorbers.

TORQUE:

UPPER MOUNT BOLT:

2.5–3.5 kg-m (18–25 ft-lb)

SUSPENSION ARM PIVOT NUT:

1.0–2.0 kg-m (7–14 ft-lb)

Install the rebound stoppers.

TORQUE: 2.0–3.0 kg-m (14–22 ft-lb)

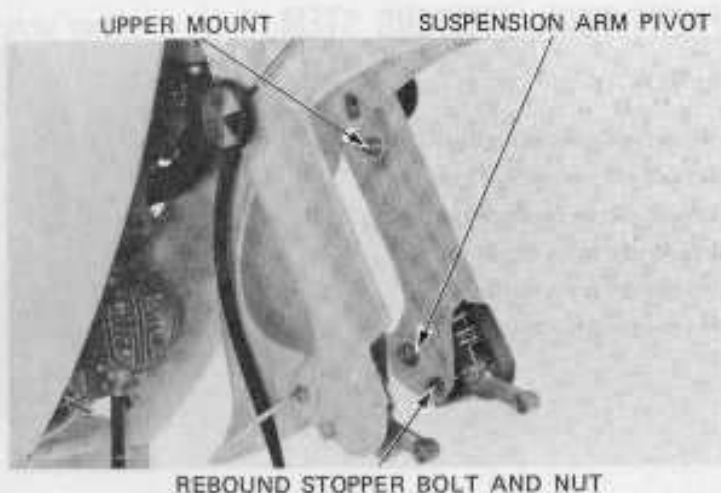

NOTE

Position the rebound stopper as shown.

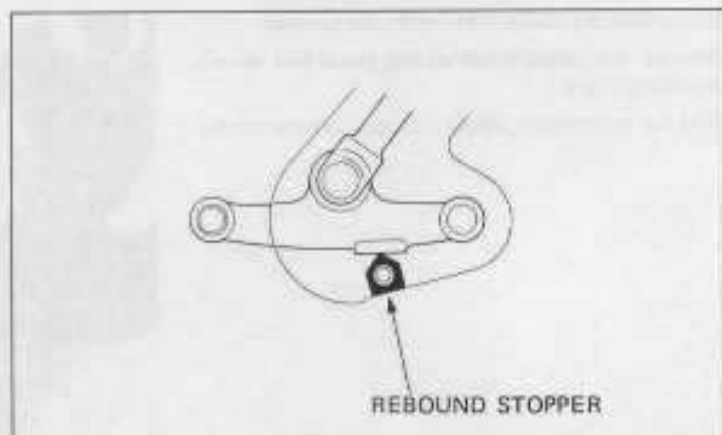

Install the front wheel (page 12-12).

Lubricate the suspension arm pivots.



FRONT FORK/STEERING STEM

REMOVAL

- Remove the handlebar (page 12-5).
- Remove the front wheel (page 12-8).
- Remove the shock absorbers (page 12-12).
- Remove the front fender.
- Remove the front carrier.
- Remove the front upper cover.

FRONT UPPER COVER

CARRIER



FRONT FENDER

Disconnect the choke cable at the carburetor.

Remove the choke knob setting screw and remove the choke cable.

Remove the throttle, brake and speedometer cables.



CHOKE CABLE



Remove the top bridge mounting bolts.

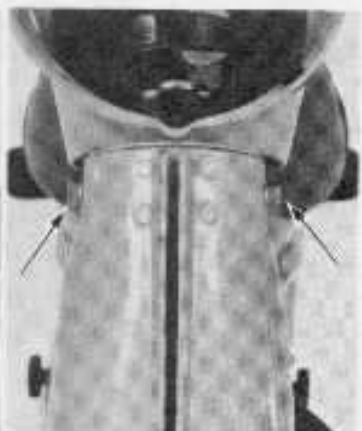



Remove the steering stem nut.

Remove the top bridge, mounts and handlebar lower cover.

LOCK NUT WRENCH, 26 x 30 mm
EXTENSION HANDLE AND BAR



Remove the bearing adjusting nut.

Remove the front fork, upper cone race and steel balls.

PIN SPANNER, 36 mm
07902-0010000

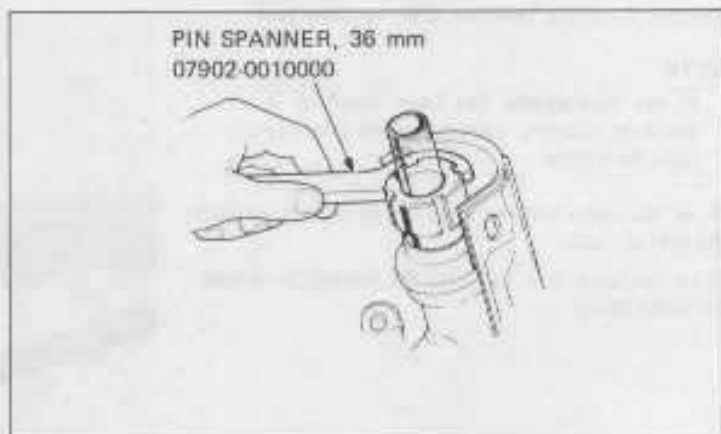

LOWER CONE RACE REPLACEMENT

Remove the lower cone race, dust seal and washer.

Install a new dust seal and washer.

Drive a new lower cone race over the stem.

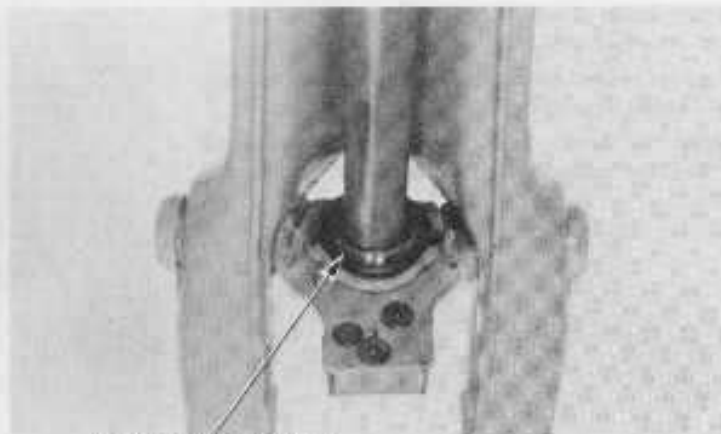

LOWER CONE RACE



BALL RACE REPLACEMENT

BALL RACE REMOVER
17946-1790000, USA ONLY M9310-277-91774

Remove the lower ball race with the special tool.



Remove the upper ball race with the same tool

NOTE

If the motorcycle has been involved in an accident, examine the area around the steering head for cracks.

Drive the upper ball race into the steering head with the special tools.

Drive the lower ball race into the steering head with the same tools.



Apply a coat of bearing grease to the upper ball race and install 21 steel balls.

Apply a coat of bearing grease to the lower ball race and install 21 steel balls.

Insert the steering stem into the steering head and install the upper cone race and bearing adjusting nut.

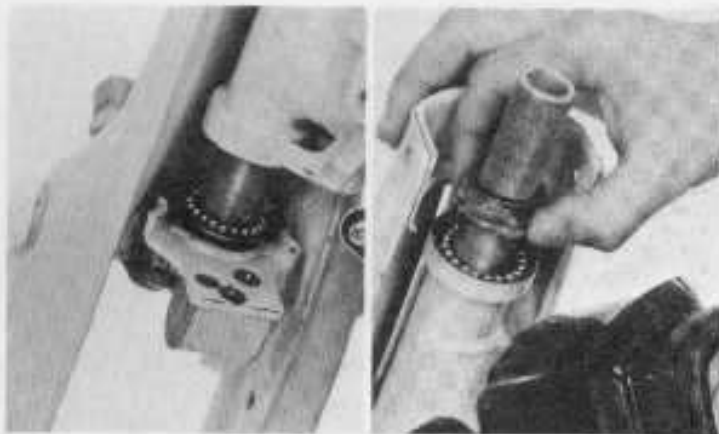



Tighten the adjusting nut until snug against the upper cone race.

Then, loosen it 1/8 turn.

Check that there is no vertical movement and that the stem rotates freely.

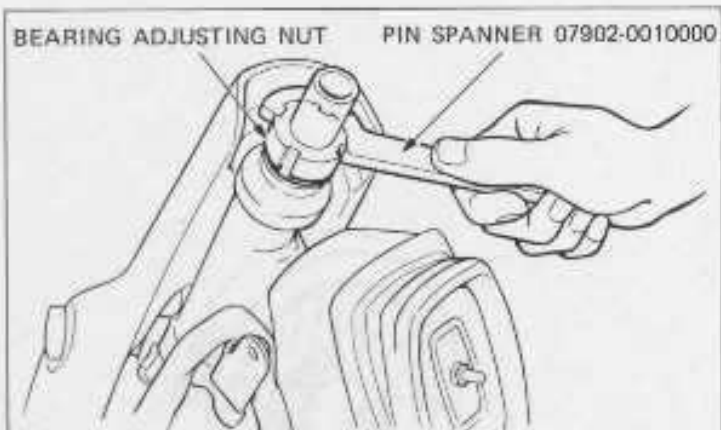

Install the handlebar lower cover, top bridge mounts and top bridge.

Tighten the steering stem nut.

TORQUE: 6.0–9.0 kg-m (43–65 ft-lb)

LOCK NUT WRENCH, 26 x 30 mm
EXTENSION BAR



Install the top bridge mount bolts.

Route the speedometer, choke and throttle cables (page 1-6).

Install the front upper cover, front carrier and front fender.

Install the following:

- Handlebar (page 12-6)
- Front wheel (page 12-12)
- Headlight (page 12-3)

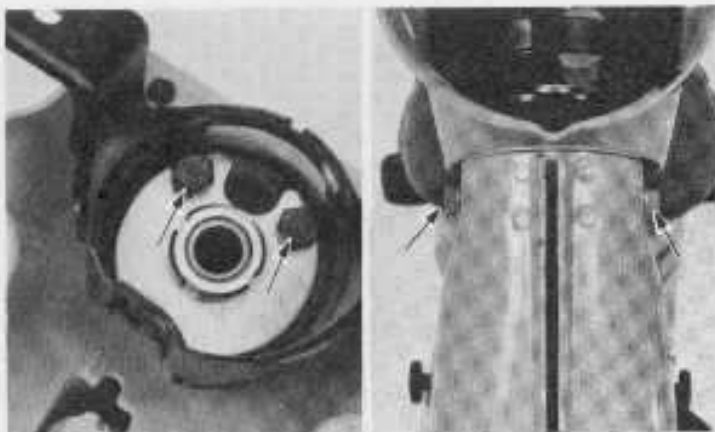

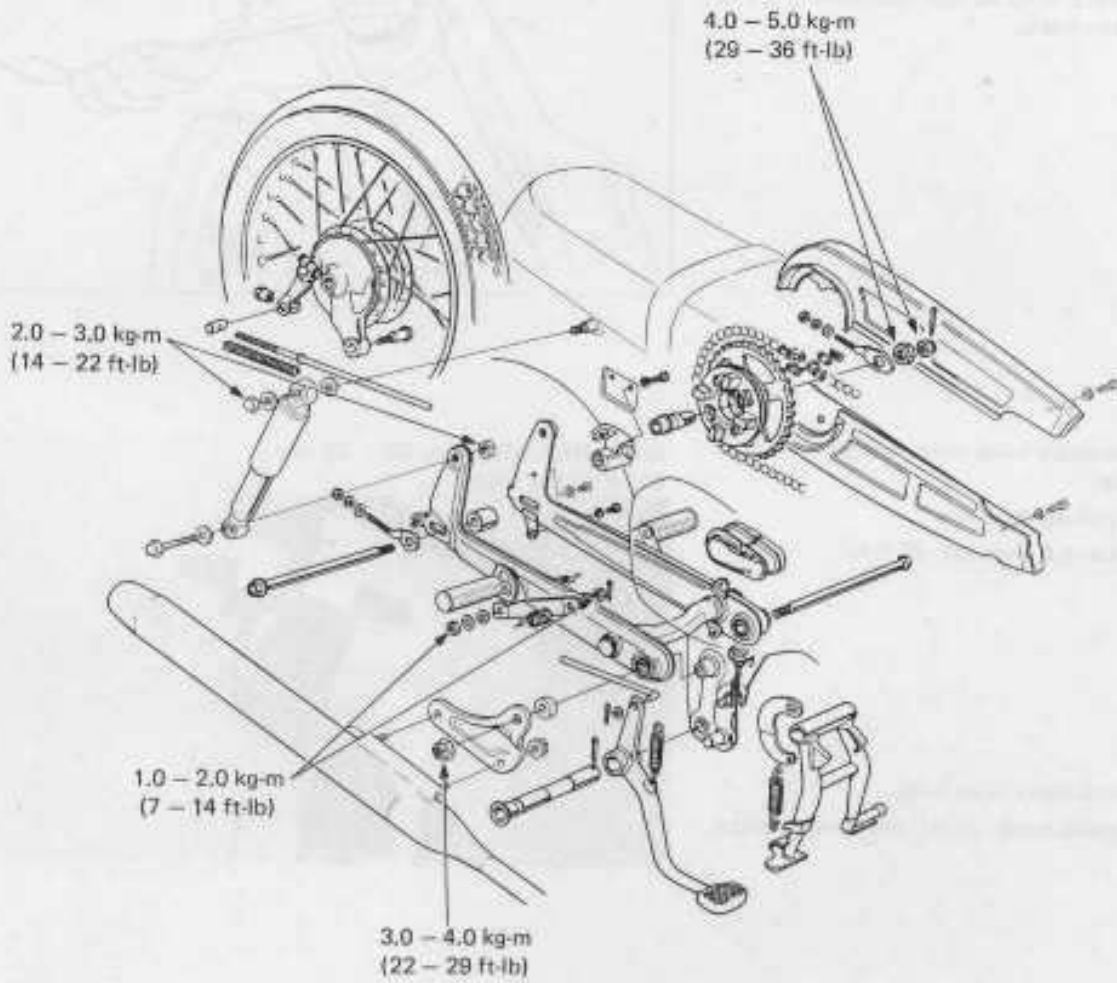



SERVICE INFORMATION	13-1	DRIVEN FLANGE	13-7
TROUBLESHOOTING	13-2	SHOCK ABSORBER	13-10
REAR WHEEL	13-3	SWINGARM	13-12

SERVICE INFORMATION

GENERAL INSTRUCTION

- A jack or other support is required to support the motorcycle.

TOOLS

Common

Bearing driver handle A	07749-0010000 - 07949-3000000
Bearing driver outer, 37 x 40 mm	07746-0010100 — { 07945-0980000, 37 mm 07946-3000000, 40 mm
Bearing driver pilot, 12 mm	07746-0040200
Bearing driver pilot, 17 mm	07746-0040400
Shock absorber compressor	07959-3290001

TORQUE VALUES

Rear brake torque link	1.0 - 2.0 kg-m (7 - 14 ft-lb)
Driven flange sleeve nut	4.0 - 5.0 kg-m (29 - 36 ft-lb)
Rear axle nut	4.0 - 5.0 kg-m (29 - 36 ft-lb)
Driven sprocket	2.0 - 2.5 kg-m (14 - 18 ft-lb)
Rear shock absorber	2.0 - 3.0 kg-m (14 - 22 ft-lb)
Swingarm pivot	3.0 - 4.0 kg-m (22 - 29 ft-lb)

SPECIFICATIONS

	STANDARD	SERVICE LIMIT
Rear axle runout	—————	0.2 mm (0.01 in)
Wheel bearing play	—————	0.03 mm (0.001 in)
Rear wheel runout	Radial	2.0 mm (0.08 in)
	Axial	2.0 mm (0.08 in)
Rear brake drum I.D.	109.8 - 110.2 mm (4.32 - 4.34 in)	111 mm (4.4 in)
Rear brake lining thickness	3.9 - 4.0 mm (0.15 - 0.16 in)	2.0 mm (0.08 in)
Rear shock absorber spring free length	219.3 mm (8.63 in)	210.5 mm (8.30 in)



TROUBLESHOOTING

Oscillation

1. Bent rim
2. Worn rear wheel bearing
3. Loose or bent spokes
4. Faulty tire
5. Loose axle
6. Tire pressure incorrect
7. Swingarm bushing worn

Soft suspension

1. Weak shock absorber springs
2. Shock absorber leakage

Hard suspension

1. Bent shock absorber
2. Lack of grease in swingarm bushings

Suspension noise

1. Shock case binding
2. Loose fasteners
3. Worn swingarm bushings



REAR WHEEL

REMOVAL

Raise the rear wheel off the ground by placing a support block under the motorcycle.

Remove the rear brake adjusting nut and disconnect the brake rod from the brake arm.

Disconnect the brake torque link from the brake panel.

Loosen the drive chain adjusting nuts.

BRAKE
ADJUSTING NUT

DRIVE CHAIN
ADJUSTING NUT



BRAKE ROD

BRAKE TORQUE LINK

Remove the cotter pin from the rear axle nut.

Remove the axle nut and pull out the axle.

Remove the wheel.



COTTER PIN

AXLE NUT

AXLE INSPECTION

Set the axle in V blocks and read the axle runout.

The actual axle runout is 1/2 of TIR (Total Indicator Reading).

SERVICE LIMIT: 0.2 mm (0.01 in)

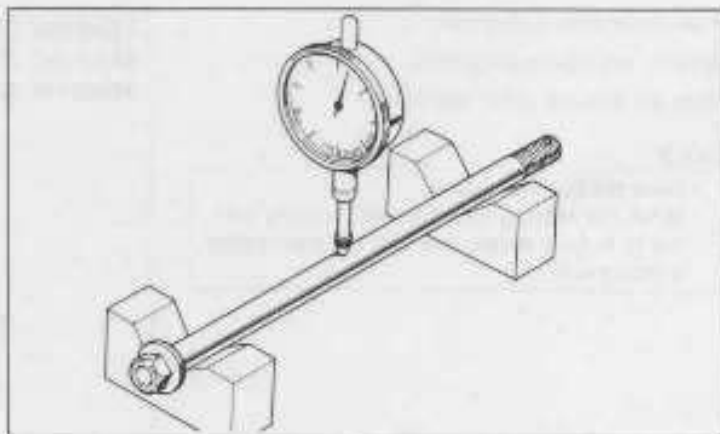



WHEEL BEARING INSPECTION

Check wheel bearing play by placing the wheel in a truing stand and spinning the wheel by hand. Replace the bearings with new ones if they are noisy or have excessive play.

SERVICE LIMIT: 0.03 mm (0.001 in)

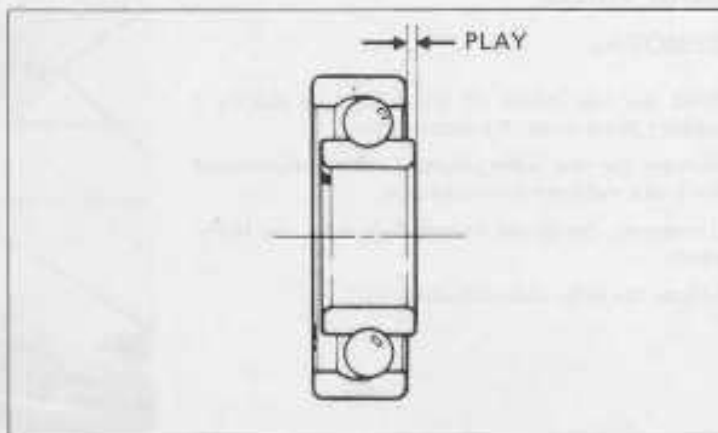

WHEEL BEARING REPLACEMENT

Remove the bearings and distance collar from the hub.



Pack the bearing with grease.

Drive in the right bearing first.

Press the distance collar into place.

NOTE

- Drive the bearing squarely.
- Drive the bearing into position, making sure the it is fully seated and that the sealed side is facing out.

BEARING DRIVER HANDLE A — 07949-3000000
 BEARING DRIVER OUTER, 37 x 40 mm } — 07945-0980000
 BEARING DRIVER PILOT, 12 mm }

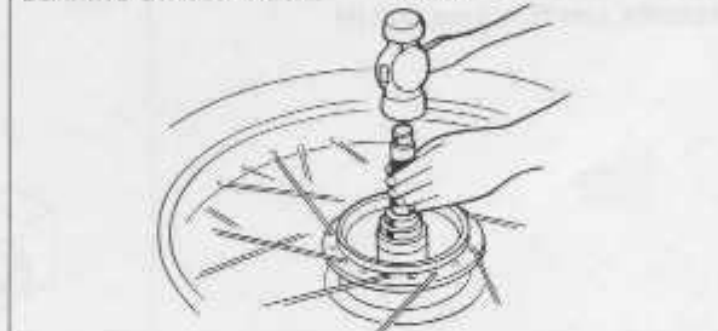



WHEEL INSPECTION

Check the rim runout by placing the wheel in a truing stand. Spin the wheel slowly and read the runout using a dial indicator.

SERVICE LIMIT:

RADIAL RUNOUT: 2.0 mm (0.08 in)

AXIAL RUNOUT: 2.0 mm (0.08 in)

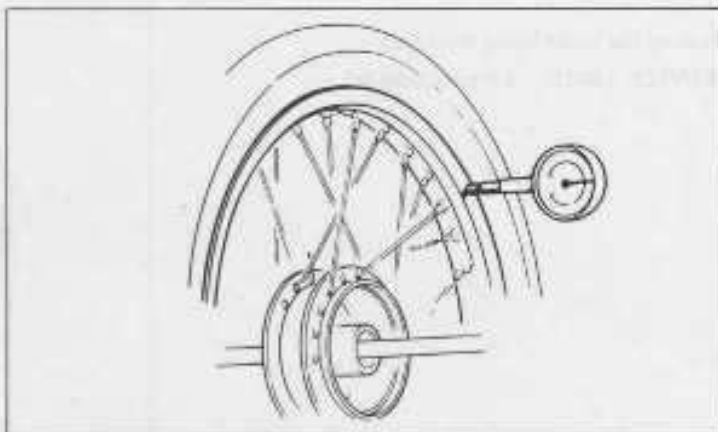

DAMPER RUBBER INSPECTION

Replace the damper rubbers if they are damaged or deteriorated.

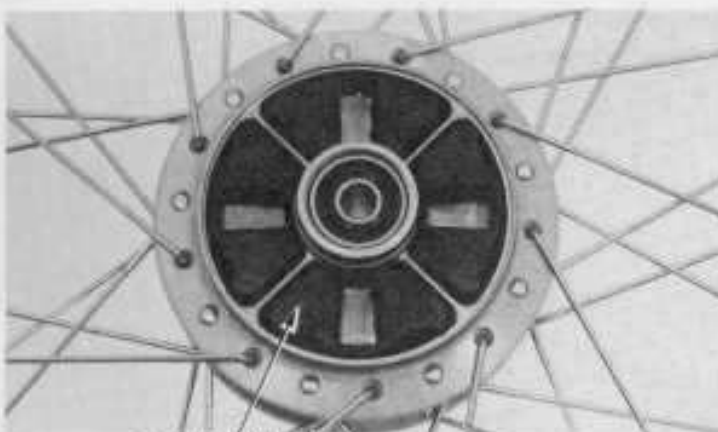

DAMPER RUBBER

BRAKE DRUM I.D. INSPECTION

Measure the brake drum inside diameter.

SERVICE LIMIT: 111 mm (4.4 in)

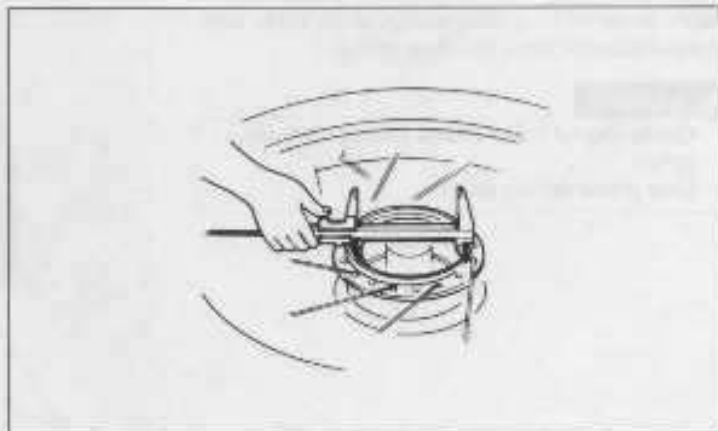

BRAKE LINING THICKNESS INSPECTION

Measure the brake lining thickness.

SERVICE LIMIT: 2.0 mm (0.08 in)

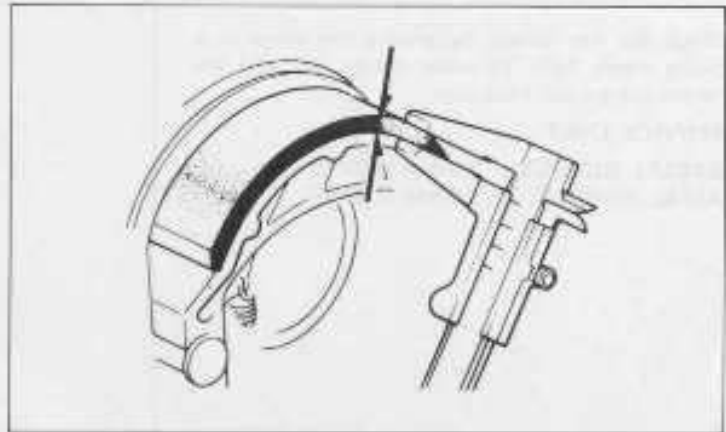

BRAKE SHOE REPLACEMENT

Remove the brake arm and indicator plate.
Remove the brake shoes and brake cam.

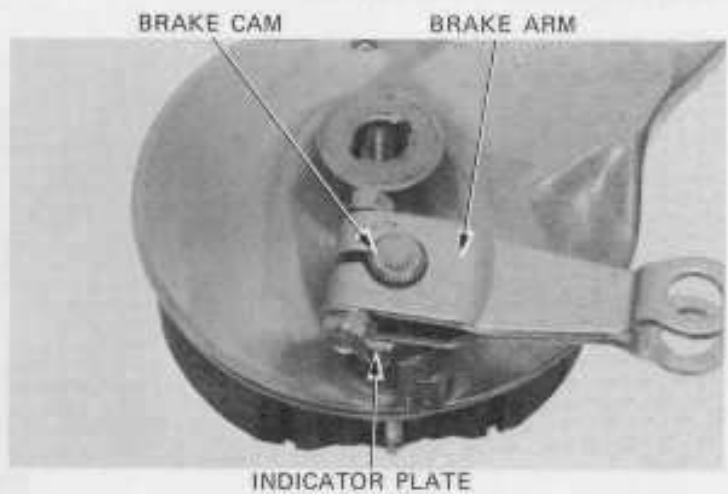

Apply grease to the sliding surface of the brake cam.
Install the brake shoes and shoe springs.

WARNING

*Contaminated brake linings reduce stopping power.
Keep grease off the linings.*





Install the felt seal.
Install the wear indicator plate.

NOTE

Align the indicator plate inner tab with the cutout of the brake cam.

Install the brake arm.

NOTE

Align the punch marks.

Tighten the brake arm bolt and nut.

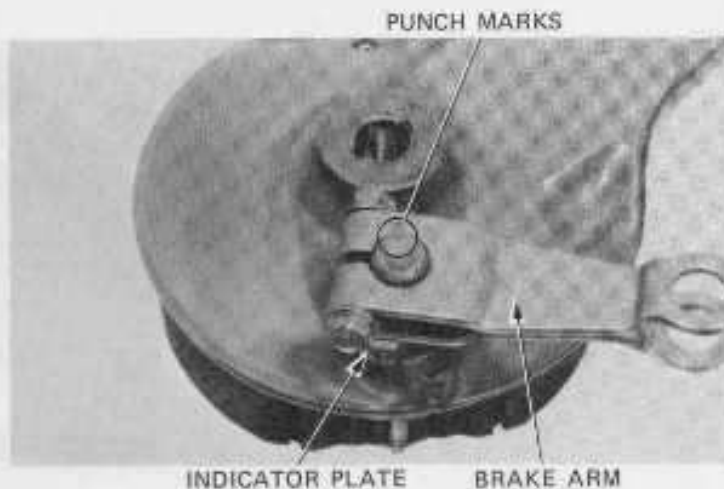
**INSTALLATION**

Install the rear wheel.
Insert the rear axle and install the axle nut.
Install the brake torque link and secure it with a new cotter pin.

TORQUE: 1.0–2.0 kg-m (7–14 ft-lb)

Connect the rear brake rod to the rear brake arm and install the brake adjusting nut.

Loosen the sleeve nut and adjust drive chain slack (page 3-11). Tighten the sleeve nut.

TORQUE: 4.0–5.0 kg-m (29–36 ft-lb)

Tighten the axle nut and install a new cotter pin.

TORQUE: 4.0–5.0 kg-m (29–36 ft-lb)

Tighten the drive chain adjusting nuts.

Adjust the rear brake (page 3-14).

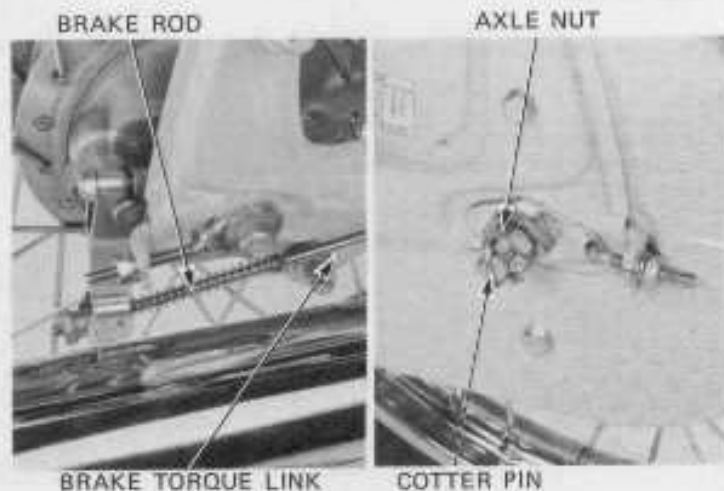
**DRIVEN FLANGE****REMOVAL**

Remove the rear wheel (page 13-3).
Remove the left side cover, drive sprocket cover, upper and lower drive chain cases.

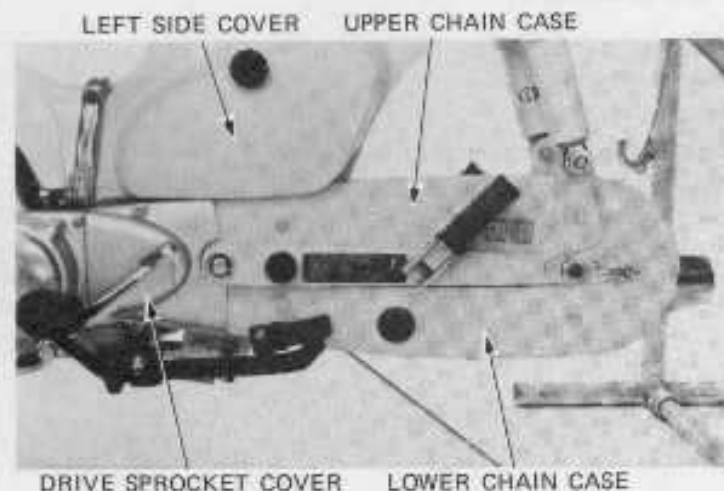

Remove the drive chain.
Remove the sleeve nut and driven flange.

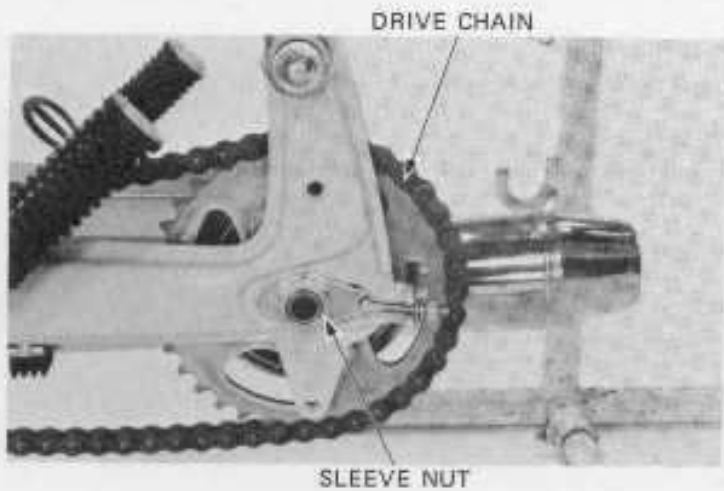

DRIVEN SPROCKET

• **INSPECTION**

Replace the sprocket if worn, bent or damaged.

NOTE

If the driven sprocket requires replacement, inspect the drive chain and drive sprocket (page 3-12).

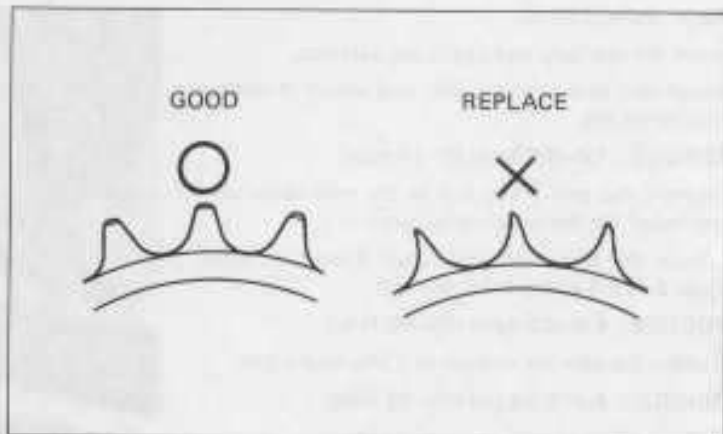

• **REPLACEMENT**

Straighten the lock plate tabs and remove the sprocket mounting bolts.

Remove the sprocket.

Install a new sprocket, lock plates and bolts.

Tighten the bolts and bend the lock plate tabs against the bolt heads.

TORQUE: 2.0–2.5 kg-m (14–18 ft-lb)





BEARING

• INSPECTION

Check the driven flange bearing play by spinning the bearing by hand. Replace the bearing with a new one if it is noisy or has excessive play.

SERVICE LIMIT: 0.03 mm (0.001 in)

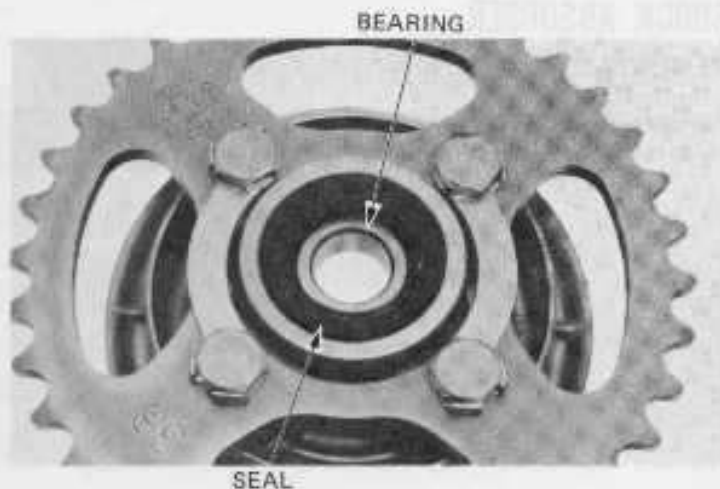

• REPLACEMENT

Remove the seal and bearing.

Pack the bearing with grease.

Drive in the bearing squarely until it seats fully.

Install the seal.

BEARING DRIVER HANDLE A — 07949-3000000



BEARING DRIVER OUTER, 37 x 40 mm — 07946-3000000
BEARING DRIVER PILOT, 17 mm

INSTALLATION

Install the driven flange and flange sleeve.

NOTE

Align the flats on the sleeve with the hole in the swingarm.

Install the left drive chain adjuster and sleeve nut.

Install the rear wheel (page 13-7).

Install and adjust the drive chain (page 3-11).

Adjust the rear brake (page 3-14).

Install the upper and lower chain case, drive sprocket cover and left side cover.

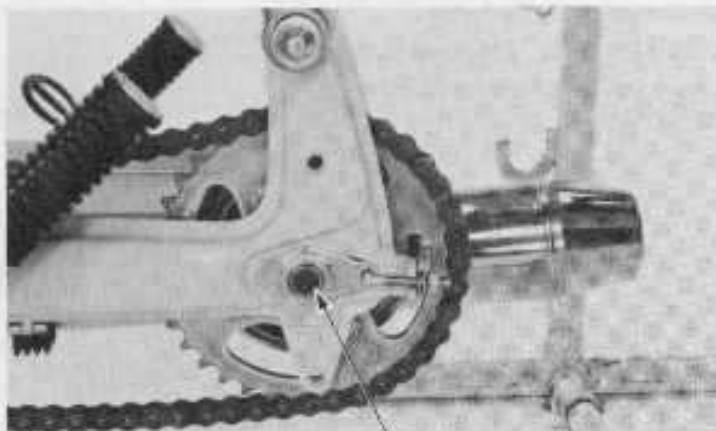



SHOCK ABSORBER

REMOVAL

Remove the upper and lower shock absorber mounting nuts and bolts, and remove the shock absorbers.



DISASSEMBLY

Compress the spring just enough to remove the lock nut.

Loosen the lock nut and remove the upper mount. Disassemble the unit.

SHOCK ABSORBER COMPRESSOR

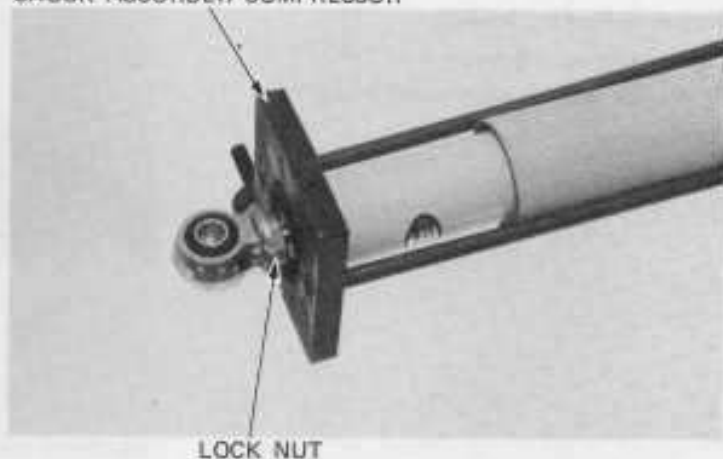

LOCK NUT

SPRING FREE LENGTH INSPECTION

Measure the spring free length.

SERVICE LIMIT: 210.5 mm (8.30 in)

Inspect the shock body for oil leaks.

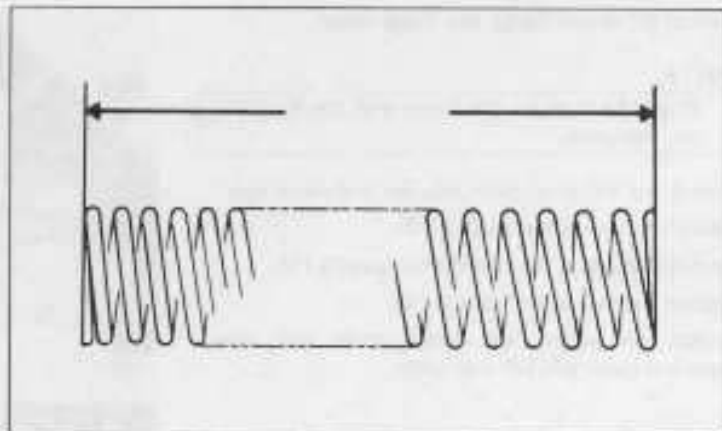



ASSEMBLY

Install the spring with the tight coils at the top.

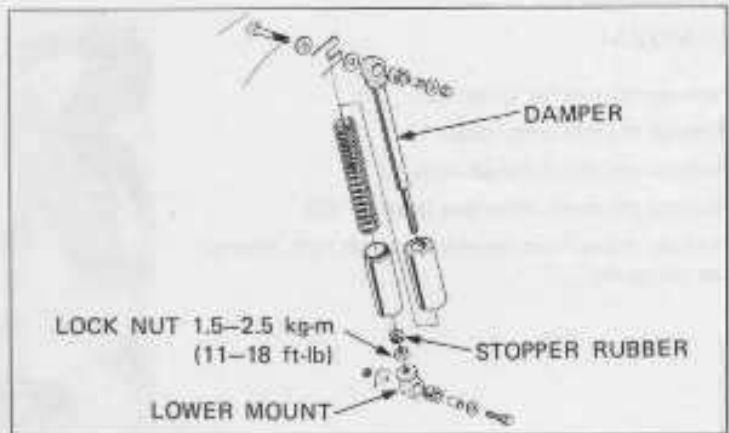

Apply a locking agent to the lock nut and install it.
Tighten the lock nut.

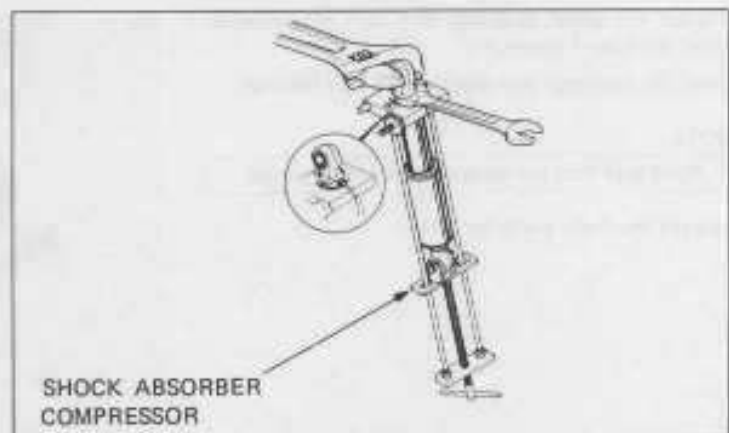

INSTALLATION

Tighten the shock absorber bolts and nuts.

TORQUE: 2.0-3.0 kg-m (14-22 ft-lb)

Check shock absorber operation after installation.



SWINGARM

REMOVAL

- Remove the muffler (page 5-2).
- Remove the rear wheel (page 13-3).
- Remove the driven flange (page 13-7).
- Remove the shock absorbers (page 13-10).
- Remove the self locking nut and pivot bolt. Remove the swingarm.

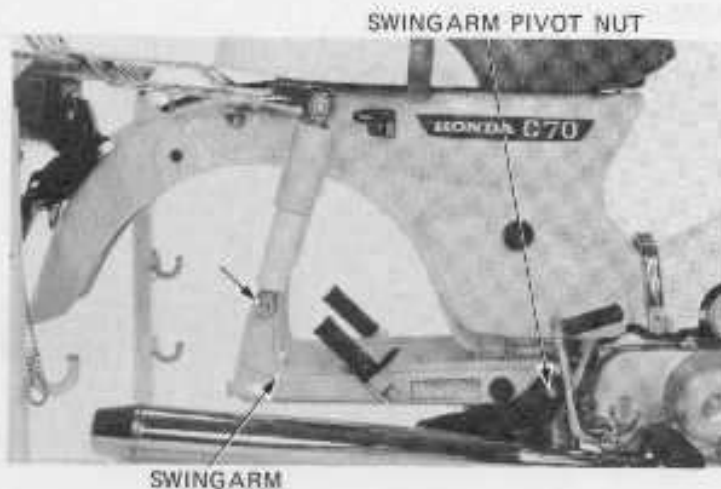

INSPECTION

- Inspect the pivot bushings and bolt for excessive wear. Replace if necessary.
- Drive the bushings into place with a soft hammer.

NOTE:

Make sure that the bushings are not damaged.

- Inspect the chain guide for wear.

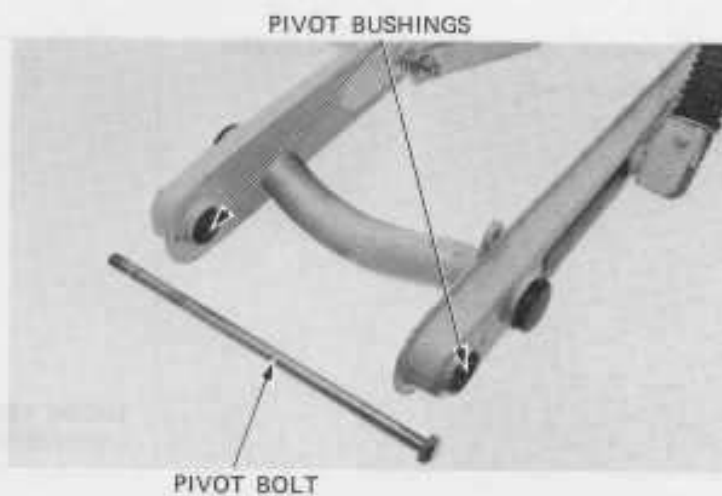

INSTALLATION

- Install the swingarm and pivot bolt.
- Install the muffler bracket and pivot self locking nut.

TORQUE: 2.5–3.5 kg-m (18–25 ft-lb)

- Install the shock absorbers (page 13-11).
- Install the driven flange (page 13-9).
- Install the rear wheel (page 13-7).
- Install the muffler.





MEMO



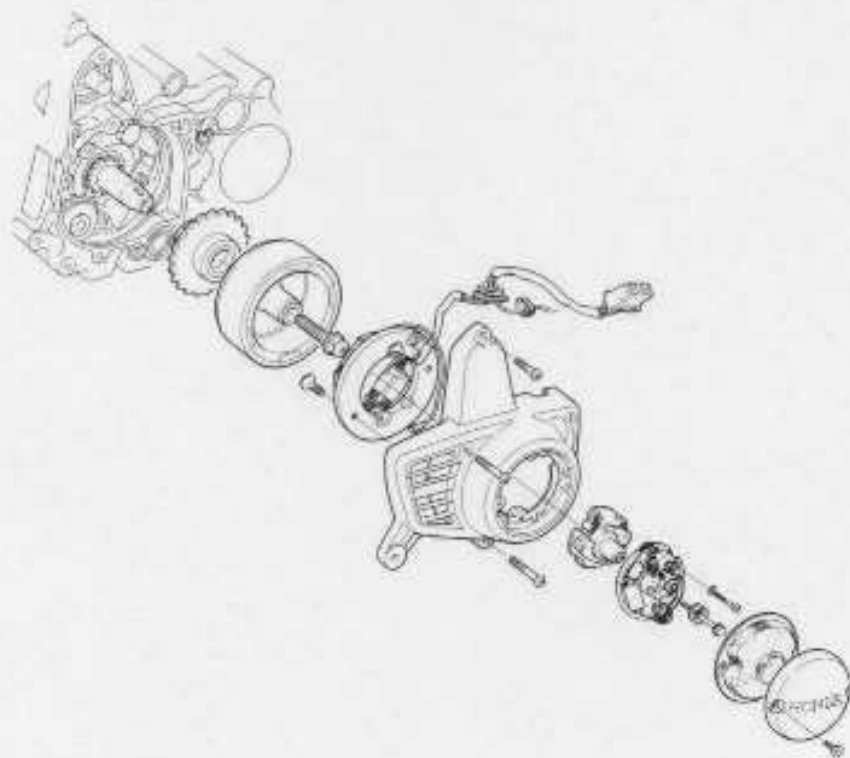
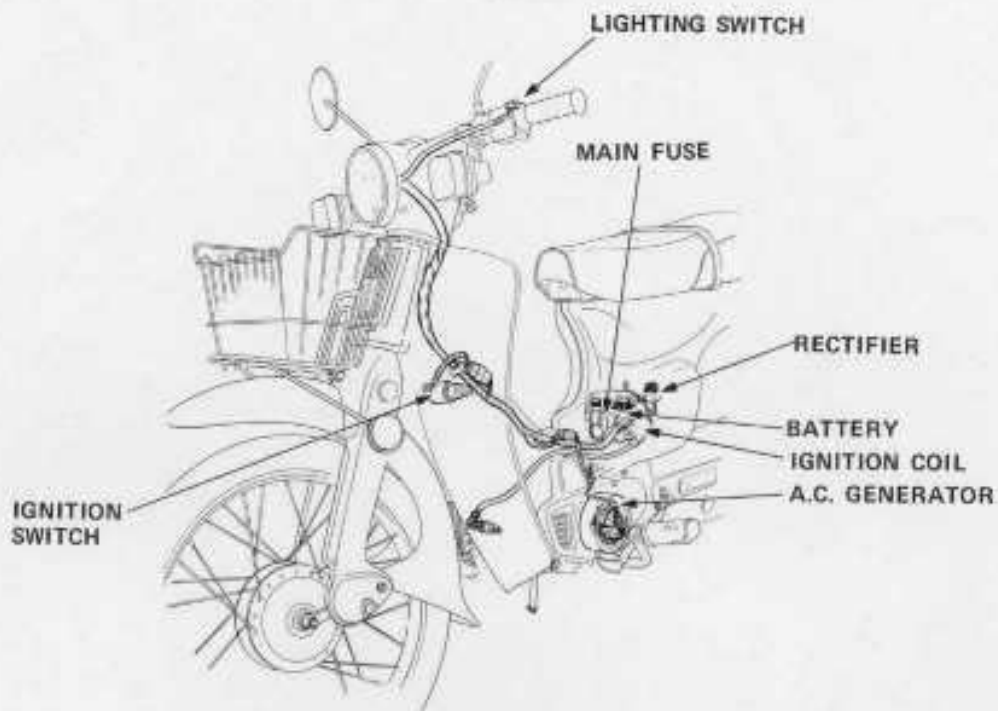



SERVICE INFORMATION	14-1	CHARGING SYSTEM	14-4
TROUBLESHOOTING	14-2	A.C. GENERATOR	14-5
BATTERY	14-3	RECTIFIER	14-8

SERVICE INFORMATION

GENERAL INSTRUCTIONS

- Battery fluid level should be checked regularly. Fill with distilled water only.
- Quick charge the battery only in an emergency. Slow-charging is preferred. Remove the battery from the motorcycle for charging. If the battery must be charged on the motorcycle, disconnect the battery cables.

WARNING

The battery generates hydrogen gas which can be highly explosive. Do not smoke or allow flames or sparks near the battery, especially while charging it.

- All charging system components can be tested on the motorcycle.

TOOLS

Special

Flywheel Holder

07922-1790000, U.S.A. only use commercially available band strap wrench

Common

Rotor Puller

07733-0020001 – Removing bolt; 90015-360-000

TORQUE VALUE

Generator rotor/flywheel bolt

5.5 – 6.5 kg-m (40 – 47 ft-lb)

SPECIFICATIONS

Battery	Capacity	6V 11 AH	
	Specific gravity	1.260 – 1.280/20°C (68°F)	
	Charging rate	1.4 amperes maximum	
A.C. generator	Capacity (headlight low beam on)	4,000 rpm	8,000 rpm
		0.9 A min.	2.3 A max.
Rectifier type	Silicon diode		

**TROUBLESHOOTING****No power — key turned on**

1. Dead battery
 - Low fluid level
 - Low specific gravity
 - Charging system failure
2. Disconnected battery cable
3. Main fuse burned out
4. Faulty ignition switch

Low power — key turned on

1. Weak battery
 - Low fluid level
 - Low specific gravity
 - Charging system failure
2. Loose battery connection

Low power — engine running

1. Battery undercharged
 - Low fluid level
 - One or more dead cells
2. Charging system failure

Intermittent power

1. Loose battery connection
2. Loose charging system connection
3. Loose starting system connection
4. Loose connection or short circuit in ignition system

Charging system failure

1. Loose, broken, or shorted wire or connection
2. Rectifier faulty
3. A.C. generator faulty



BATTERY

REMOVAL

- Remove the right side cover.
- Disconnect the ground cable at the frame.
- Disconnect the positive cable at the battery.
- Remove the battery holder plate bolt.
- Remove the battery.



TESTING SPECIFIC GRAVITY

Test each cell with a hydrometer.

SPECIFIC GRAVITY: (20°C, 68°F)

1.260 – 1.280	Fully charged
Below 1.250	Undercharged

NOTE

- The battery must be recharged if the specific gravity is below 1.230.
- The specific gravity varies with the temperature as shown in the table.
- Replace the battery if sulfation is evident or if the space below the cell plates is filled with sediment.

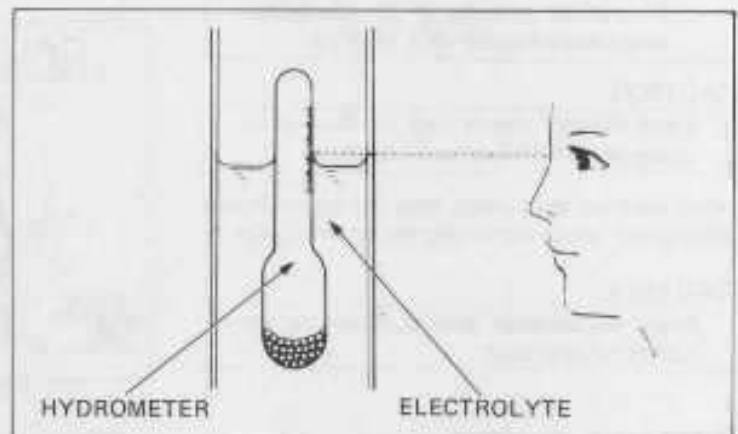

WARNING

*The battery contains sulfuric acid.
Avoid contact with skin, eyes, or clothing.
Antidote: Flush with water and get prompt
medical attention.*

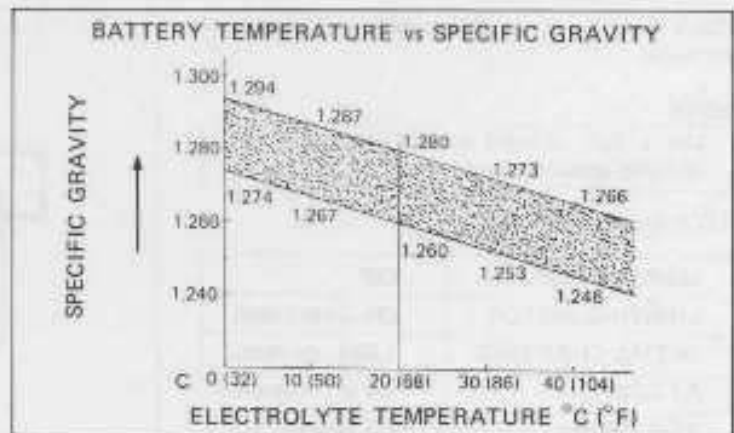



BATTERY/CHARGING SYSTEM

BATTERY CHARGING

Remove the battery cell caps.

Connect the charger positive (+) cable to the battery positive (+) terminal.

Connect the charger negative (-) cable to the battery negative (-) terminal.

CHARGING CURRENT: 1.4 amperes max.

Charge the battery until specific gravity is 1.260-1.280 at 20°C (68°F).

WARNING

- Before charging the battery, remove the cap from each cell.
- Keep flames and sparks away from a charging battery.
- Turn power ON/OFF at the charger, not at the battery terminals.
- Discontinue charging if the electrolyte temperature exceeds 45°C (113°F).

CAUTION:

Quick-charging should only be done in an emergency; slow-charging is preferred.

After installing the battery, coat the terminals with clean grease before connecting the battery cables.

CAUTION:

Route the breather tube as shown on the battery caution label.

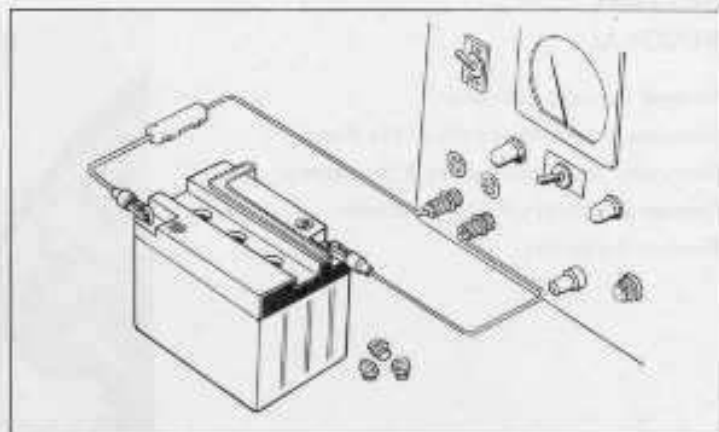

1980

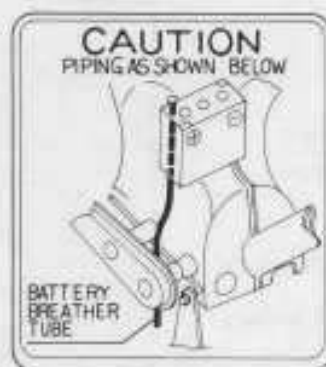

1981

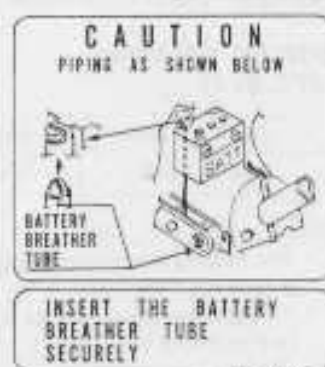

CHARGING SYSTEM

OUTPUT TEST

Warm up the engine before taking readings.

Check charging system output with a voltmeter and ammeter.

NOTE

Use a fully charged battery to check the charging system output.

TECHNICAL DATA:

MAIN SWITCH	ON
LIGHTING SWITCH	ON (Low beam)
INITIAL CHARGING	1,550 rpm max.
AT 4,000 rpm	0.9 amperes min.
AT 8,000 rpm	2.3 amperes/8.5 volts max.

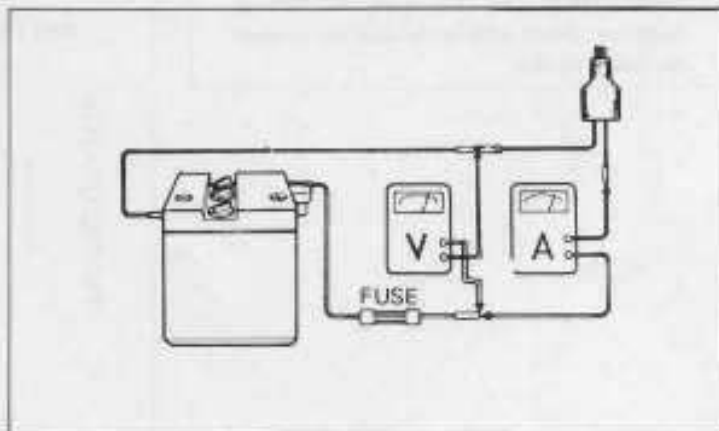



A.C. GENERATOR

STATOR REMOVAL

- Remove the gear shift pedal.
- Remove the drive sprocket cover.
- Disconnect the A.C. generator coupler.
- Remove the contact point cover, contact breaker base plate and spark advancer (page 15-4).
- Disconnect the neutral switch wire at the switch.
- Remove the left crankcase cover.

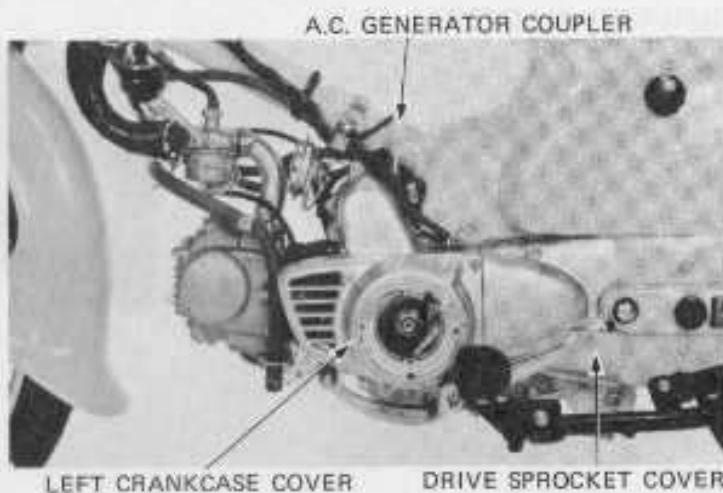

- Remove the two stator screws, wire protector and stator from the left crankcase cover.

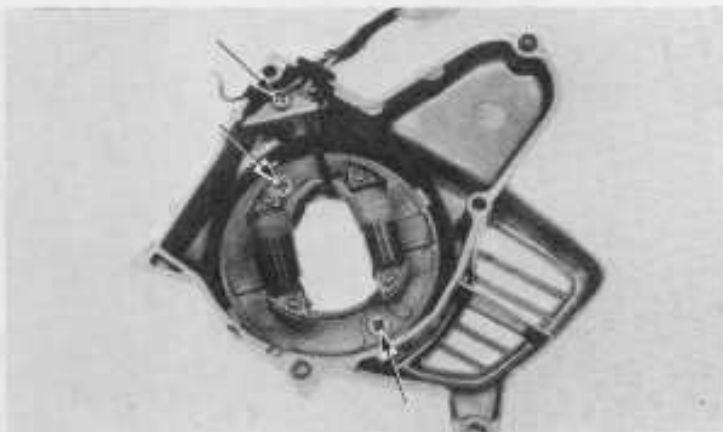

STATOR COIL CONTINUTY TEST

NOTE

It is not necessary to remove the stator to make this test.

- Check continuity between the yellow, white, black/white leads and stator ground with an ohmmeter on the R \times 1 scale. Replace the stator if there is no continuity.





GENERATOR ROTOR

• **REMOVAL**

Use the flywheel holder or band strap holder and block the flywheel to prevent the crankshaft from turning.

Remove the generator rotor bolt.

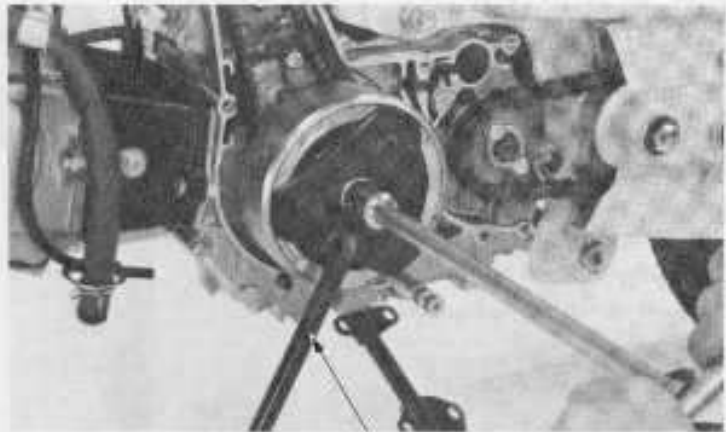

FLYWHEEL HOLDER 07922-1790000
U.S.A. ONLY - USE COMMERCIALY
AVAILABLE BAND STRAP WRENCH

Remove the generator rotor.

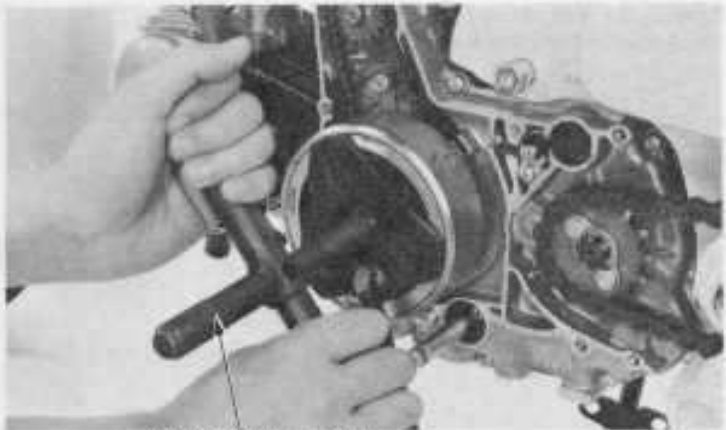

ROTOR PULLER OR
U.S.A. ONLY, REMOVING BOLT
90015-360-000

• **INSTALLATION**

Align the rotor keyway with the key on the crankshaft and install the generator rotor.



GENERATOR ROTOR



Tighten the generator rotor bolt.

TORQUE: 5.5–6.5 kg-m (40–47 ft-lb)

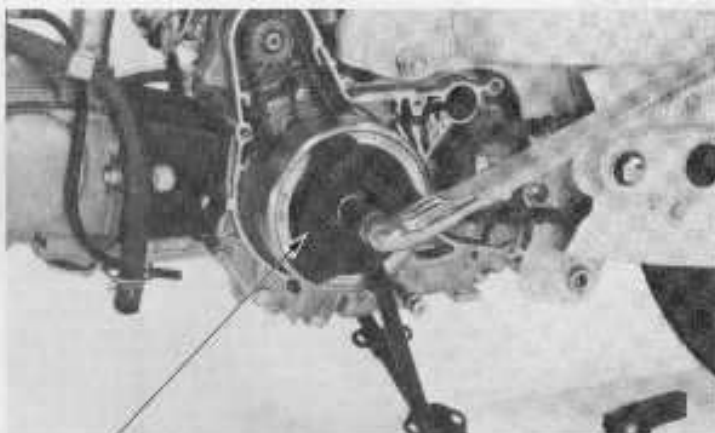

FLYWHEEL HOLDER 07922-179000 OR
U.S.A. ONLY – COMMERCIALY AVAILABLE
BAND STRAP WRENCH

STATOR INSTALLATION

Install the stator.

Route the generator leads properly.

Connect the neutral switch lead.

Install the left crankcase cover, drive sprocket cover and gearshift pedal.

Connect the generator wire coupler.

Install the right crankcase cover, footpegs/side stand and kick starter pedal.

Fill the crankcase with the recommended oil (page 2-2).

Adjust the ignition timing (page 3-9).

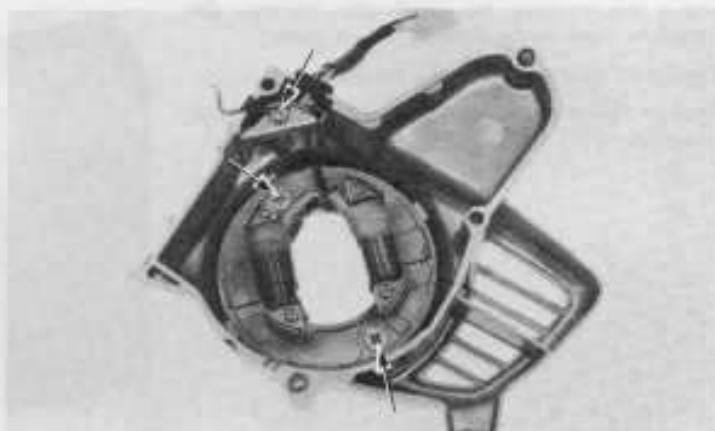



RECTIFIER

REMOVAL

Remove the right side cover.
Remove the rectifier.



INSPECTION

Check the rectifier for continuity between the terminals. Reverse the leads and check again. Continuity should exist in one direction only. Replace the rectifier if there is continuity in both directions.





MEMO



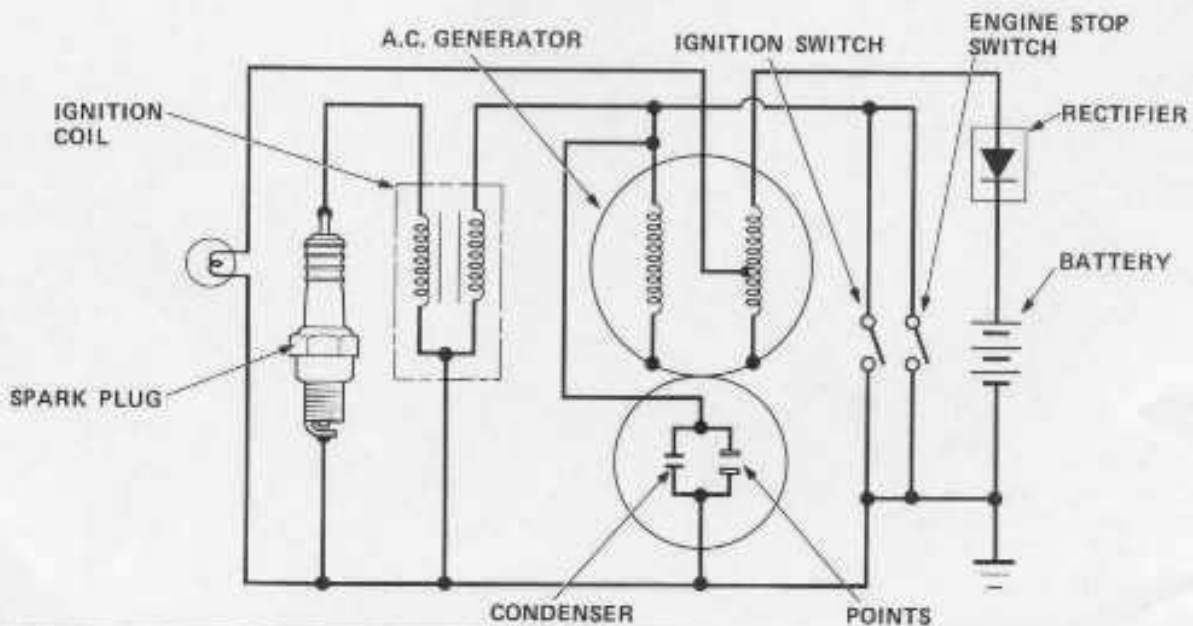
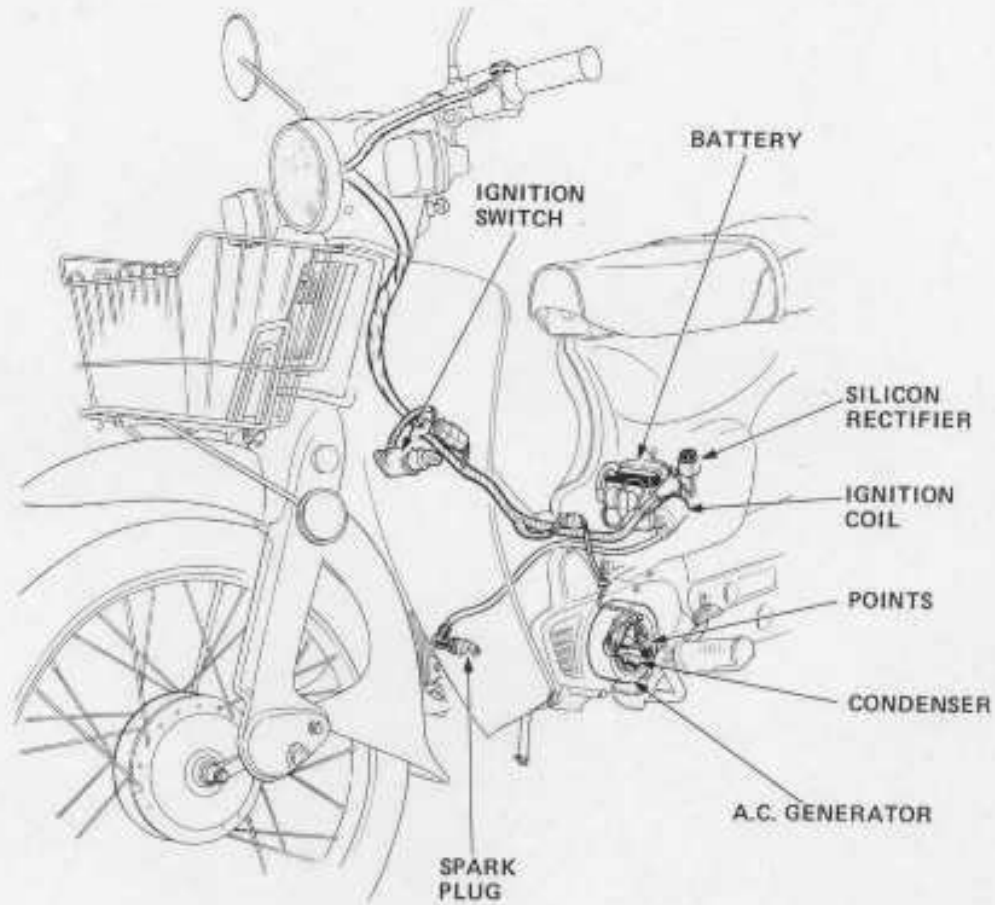



SERVICE INFORMATION	15-1	CONTACT BREAKER POINTS	15-3
TROUBLESHOOTING	15-1	SPARK ADVANCER	15-4
IGNITION COIL	15-2		

SERVICE INFORMATION

GENERAL INSTRUCTION

For spark plug information, see page 3-5.

TORQUE VALUE

Spark advancer

0.9 – 1.2 kg-m (7 – 9 ft-lb)

SPECIFICATIONS

[] : Canada Model

Spark plug	ND	Standard	U22FS	[U22FSR-L]
		For cold climate below 5°C (41°F)	U20FS	[U20FSR-L]
		For extended high speed riding	U24FB	[U24FSR-L]
	NGK	Standard	C7HS	[CR7HS]
		For cold climate below 5°C (41°F)	C6H	[CR6HS]
		For extended high speed riding	C9H	[CR8HS]
Spark plug gap		0.6 – 0.7 mm (0.024 – 0.028 in)		
Ignition timing		At idle	15° BTDC	
		Full advance	30° BTDC/3,100 rpm	
Condenser capacity		0.22 – 0.26 μF		
Contact breaker point gap		0.3 – 0.4 mm (0.012 – 0.016 in)		

TROUBLESHOOTING

Engine cranks but will not start

1. Engine stop switch OFF
2. No spark at plug
3. Improper ignition timing

No spark at plug

1. Engine stop switch OFF
2. Points not opening
3. Points burned, wet fouled or dirty
4. No primary current to points and coils
 - Loose or broken wire
 - Faulty ignition switch
5. Plug fouled
6. Faulty plug wire
7. Coil weak or inoperative
8. Faulty condenser

Engine starts but runs poorly

1. Ignition primary circuit
 - Points dirty or fouled
 - Incorrect point gap
 - Faulty ignition coil
 - Faulty condenser
 - Loose or bare wire
 - Intermittent short circuit
2. Ignition secondary circuit
 - Faulty plug
 - Faulty high tension wire
3. Improper ignition timing

Timing advance incorrect

1. Centrifugal advancer faulty



IGNITION COIL

REMOVAL

Remove the right and left side covers.
Remove the battery and starter relay switch.
Disconnect the wire leads.
Remove the coil by removing the attaching nut from the left side.



IGNITION COIL

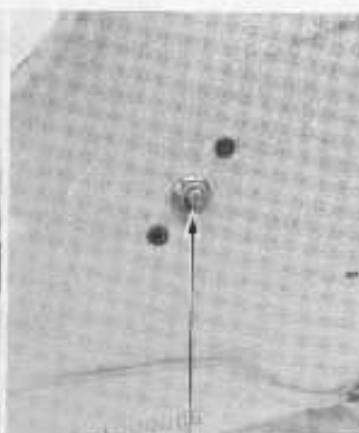

ATTACHING NUT

CONTINUITY TEST

Check for continuity as shown.
The coil is good if there is continuity.

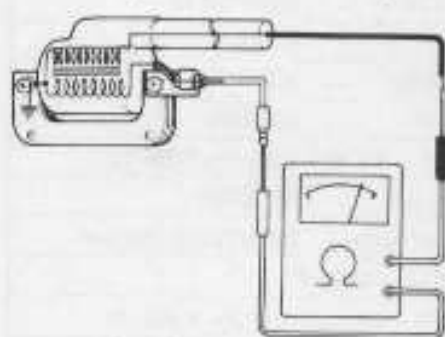

R × 1 Continuity

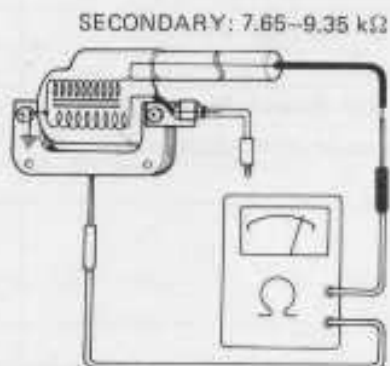

R × 1,000

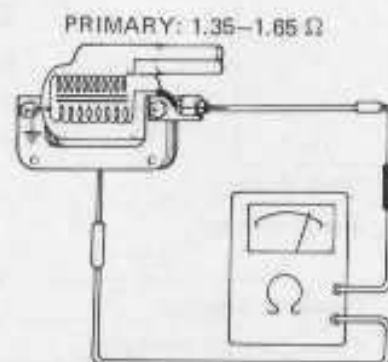

R × 1

PERFORMANCE TEST

Perform the 3-point spark test with a coil tester.

SERVICE LIMIT: 6 mm (1/4 in) min.

NOTE

Follow the coil tester manufacturer's instructions.

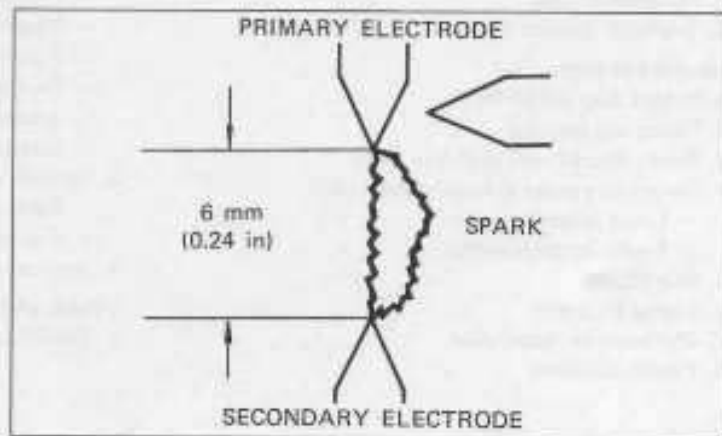



CONTACT BREAKER POINTS

REMOVAL

- Remove the contact breaker point cover.
- Disconnect the point wire lead.
- Remove the contact breaker assembly.

For contact breaker points inspection, see page 3-7.

NOTE

If the oil felt is dry, apply one or two drops of clean engine oil to it.

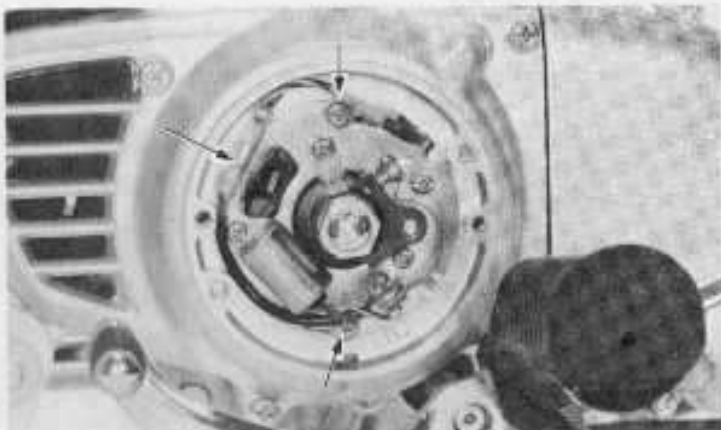

CONDENSER CAPACITY TEST

- Remove the condenser from the base plate.
- Discharge the condenser by grounding its terminal against its casing.

Measure the condenser capacity with a tester.

CAPACITY: 0.22–0.26 μ F

If it is out of specification, replace the condenser.

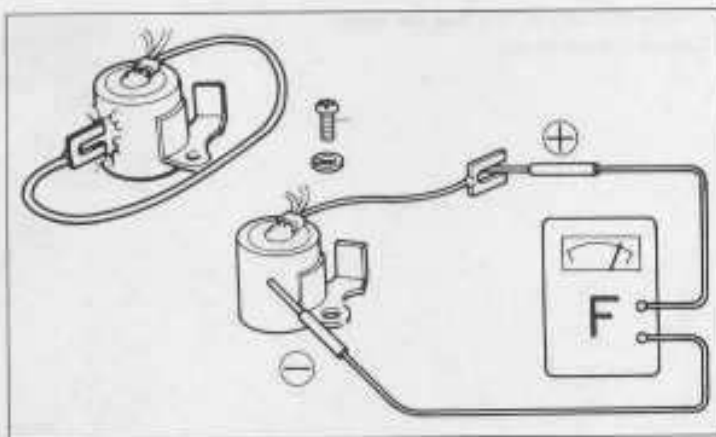

POINT REPLACEMENT

- Remove the point setting screws and bolt.
- Replace the contact point.

NOTE

Do not forget to install the bakelite washers to insulate the condenser/generator terminal from ground.

Install contact breaker assembly in the reverse order of removal.

Adjust the point gap and ignition timing.

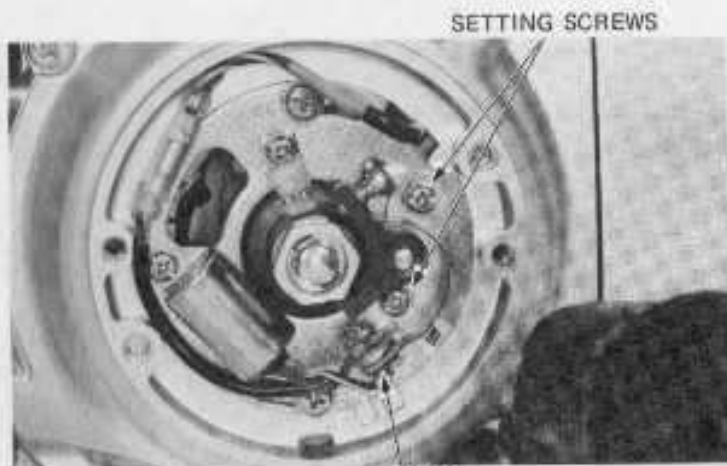

SPARK ADVANCER

For advancer function test, see page 3-9.

Remove the contact point cover and contact breaker assembly.

Check the spring for loss of tension and advancer pin for excessive wear if the advancer fails to return. Replace if necessary.

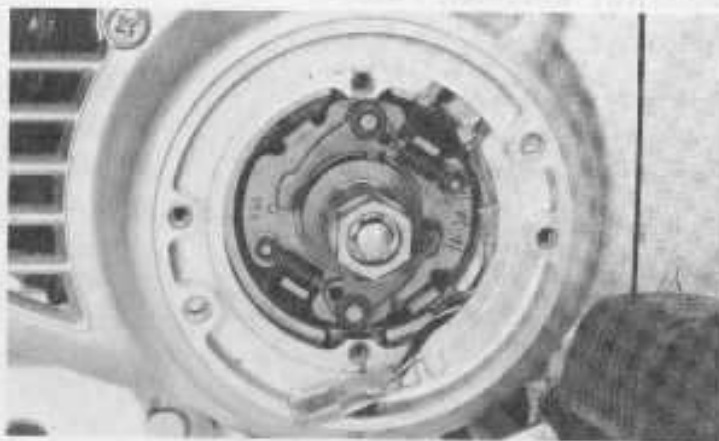

ADVANCER REPLACEMENT

Remove the bolt by holding the spacer.
Remove the advancer.



Install the advancer, aligning the slot with the flywheel pin.

Install the spacer and tighten the bolt.

TORQUE: 0.9–1.2 kg-m (7–9 ft-lb)

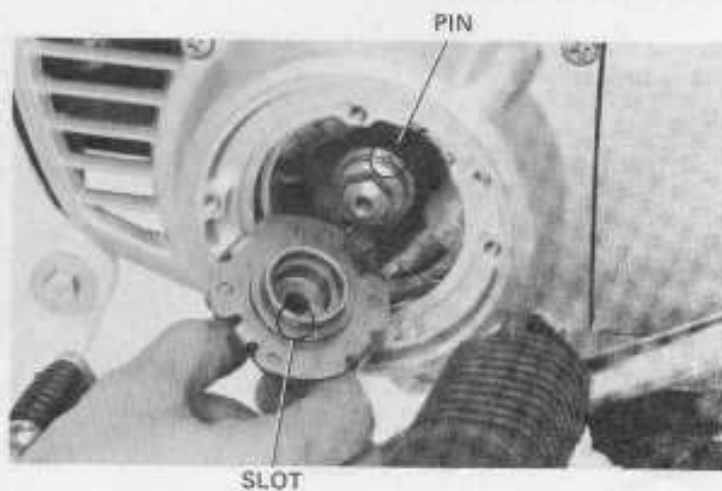



SERVICE INFORMATION	16-1	STARTER RELAY	16-5
TROUBLESHOOTING	16-1	STARTER CLUTCH/DRIVE CHAIN	16-5
STARTER MOTOR	16-2		

SERVICE INFORMATION

GENERAL INSTRUCTION

The starter motor can be removed with the engine in the frame.

SPECIFICATIONS

ITEM		Standard	Service Limit
Starter motor	Brush spring tension	400 g (14.1 oz)	300 g (10.6 oz)
	Brush length	12 mm (0.47 in)	4 mm (0.16 in)
Starter clutch driven sprocket O.D.		37.900 (1.4921 in)	36.76 mm (1.447 in)

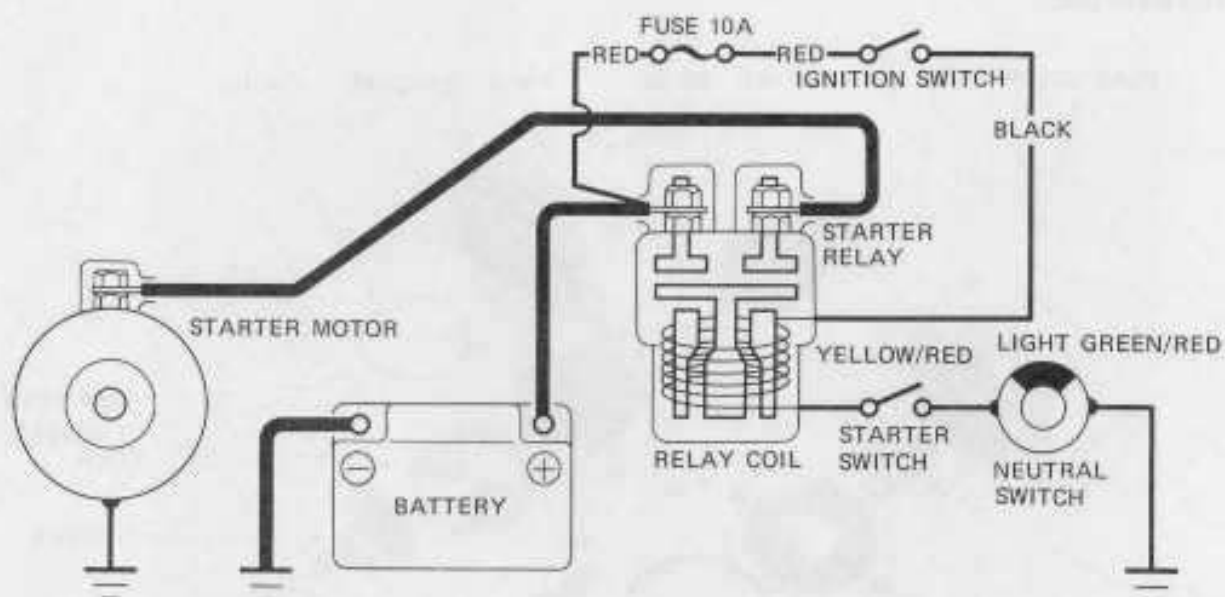

TROUBLESHOOTING

Starter motor will not turn

1. Battery discharged
2. Main fuse burned out
4. Faulty starter relay
5. Faulty starter switch
6. Faulty neutral switch
7. Loose or disconnected wire or cable
8. Faulty starter motor

Starter motor turns engine slowly

1. Low battery specific gravity
2. Excessive resistance in circuit
3. Binding in starter motor

Starter motor turns, but engine does not turn

1. Faulty starter clutch
2. Faulty starter motor gears
3. Faulty starter chain and sprockets

Starter motor and engine turns, but engine does not start

1. Faulty ignition system



STARTER MOTOR

REMOVAL

WARNING

With the ignition switch OFF, remove the battery negative cable at the frame before servicing the starter motor.

Remove the left crankcase cover.

Remove the starter drive sprocket snap ring.

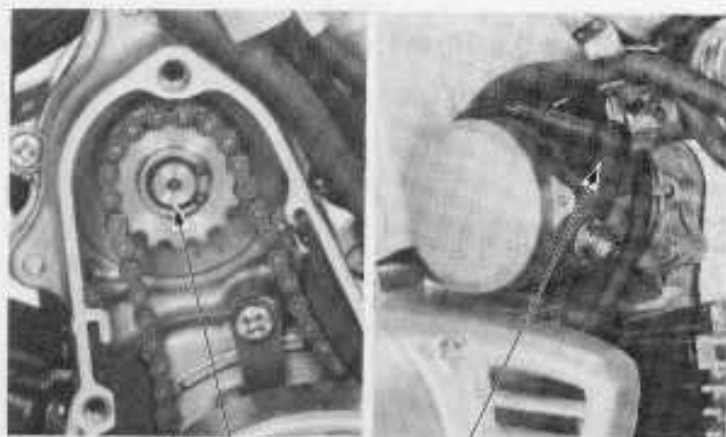

SNAP RING

STARTER CABLE

Disconnect the starter cable at the starter motor.

Remove the three starter motor mounting bolts.

Remove the starter motor.

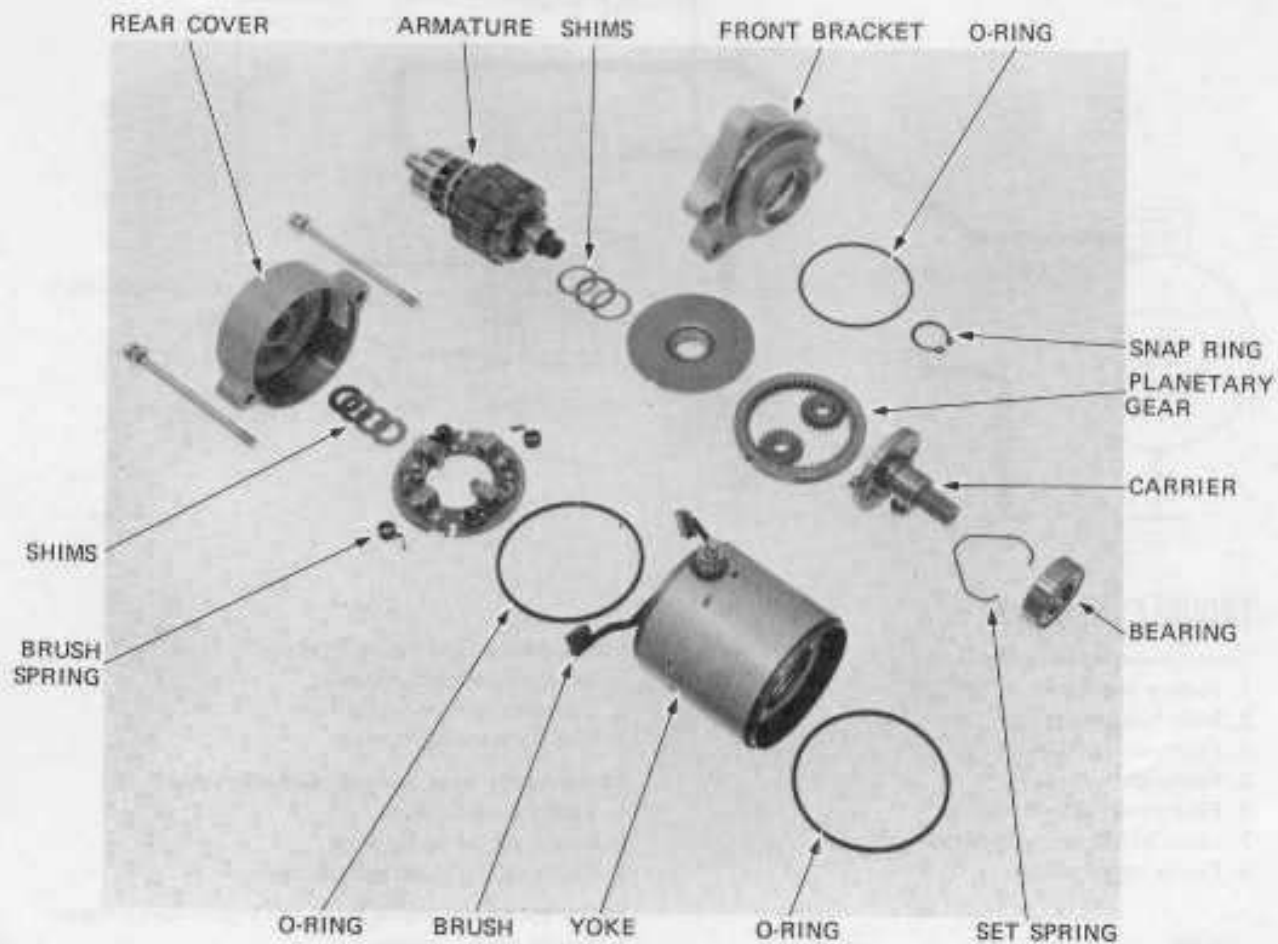



BRUSH INSPECTION

Remove the starter motor case screws and rear cover.

Inspect the brushes and measure the brush length.

SERVICE LIMIT: 4 mm (0.16 in)

Measure brush spring tension with a spring scale.

SERVICE LIMIT: 300 g (10.6 oz)

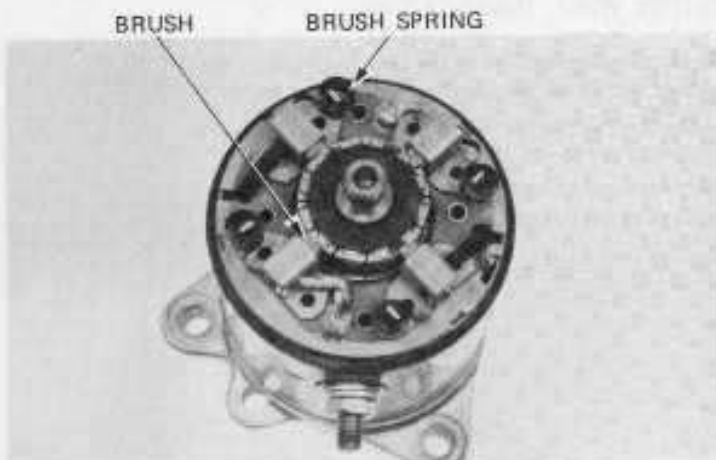

COMMUTATOR INSPECTION

Remove the armature.

NOTE

Record the location and number of shims.

Inspect the commutator bars for discoloration.

Bars discolored in pairs indicate grounded armature coils.

NOTE

Do not use emery cloth or sand paper on the commutator.

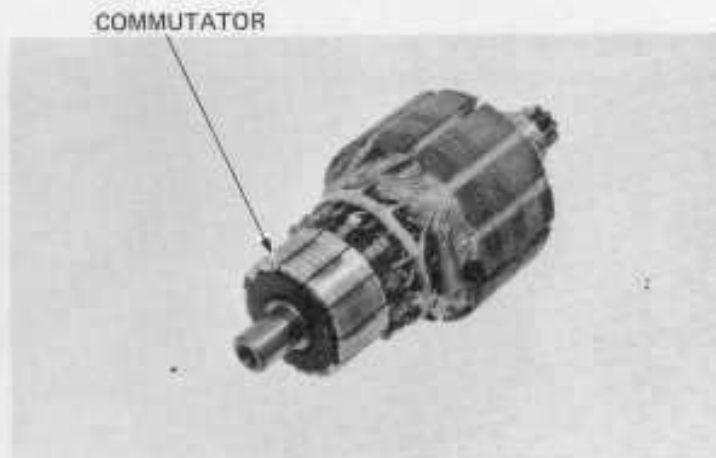

Check for continuity between pairs of commutator bars, and between commutator bars and armature shaft.

Commutator bar pairs: Continuity

Armature to shaft: No continuity





BRUSH WIRE INSPECTION

Check for continuity from the cable terminal to the brushes with black wire, and to the motor case.

Repair the brush wire if the wire is broken or if it is shorted to the motor case.

Cable terminal to motor case: No continuity

Cable terminal to brush: Continuity

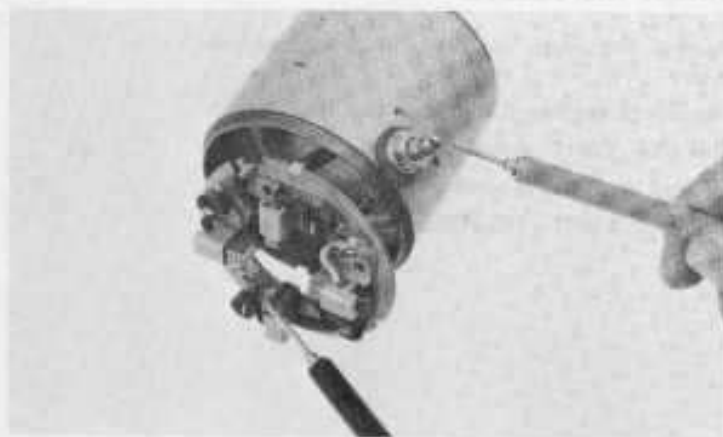

ASSEMBLY/INSTALLATION

Assemble the starter motor.

Align the case notch with the brush holder pin.

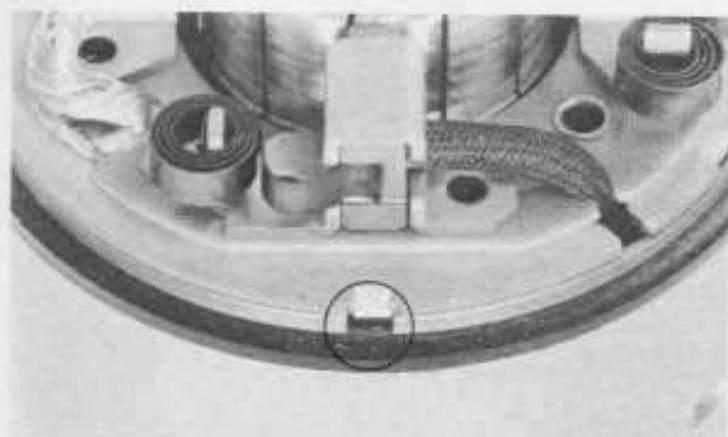

Install the rear cover aligning its slot with the brush holder pin.

Install the starter motor by reversing the removal procedure.

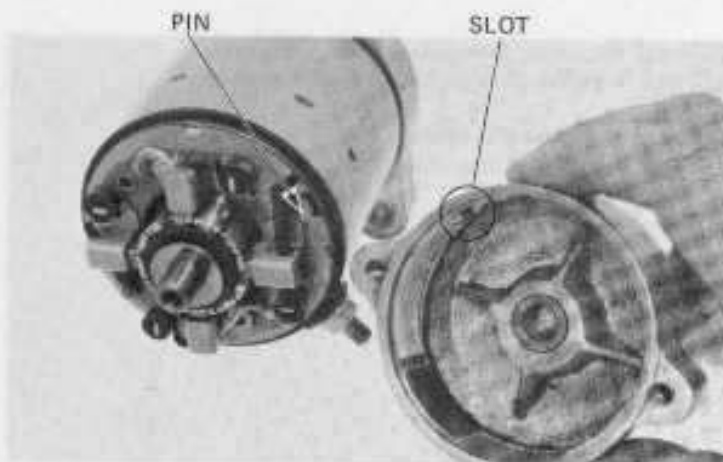



STARTER RELAY

INSPECTION

Depress the starter switch button with the ignition ON.

The coil is normal if the starter relay switch clicks.



Connect an ohmmeter to the starter relay switch cable terminals.

Connect a 6V battery to the switch wire leads.

The switch is normal if there is continuity.

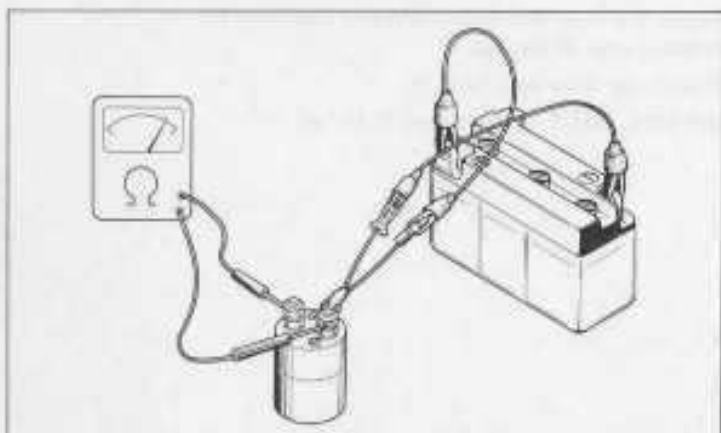

STARTER CLUTCH/DRIVE CHAIN

REMOVAL

Remove the A.C. generator rotor (Section 14).

Remove the starter chain guide and protector.

Remove the sprocket setting plate.

Remove the snap ring.

Remove the starter chain and sprockets.

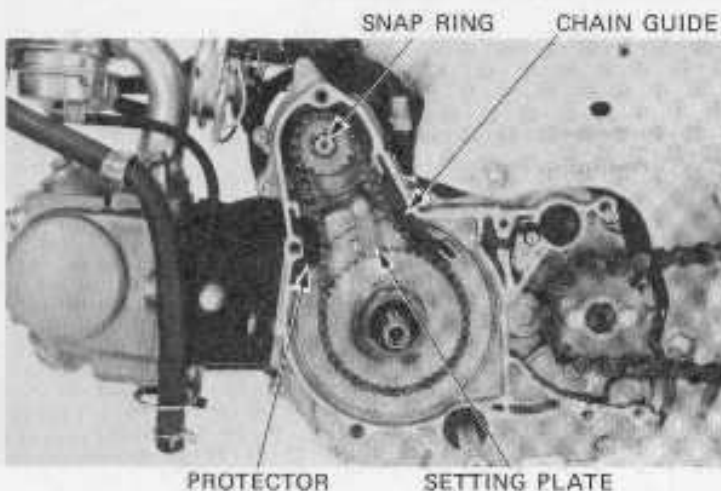



ELECTRIC STARTER

STARTER CLUTCH DISASSEMBLY

Remove the three screws.

Remove the starter clutch outer.

Remove the rollers, plungers and springs.

STARTER CLUTCH INSPECTION

Inspect the rollers for smooth operation.

Check the rollers for excessive wear.



Inspect the drive and driven sprockets and chain for excessive wear or damage.

Measure the drive sprocket O.D.

SERVICE LIMIT: 36.76 mm (1.447 in)



STARTER CLUTCH ASSEMBLY

Install the starter clutch outer.

NOTE

Stake the end of each screw against the groove in the clutch outer.

Install the springs, plungers and rollers.

INSTALLATION

Reverse the removal procedure.

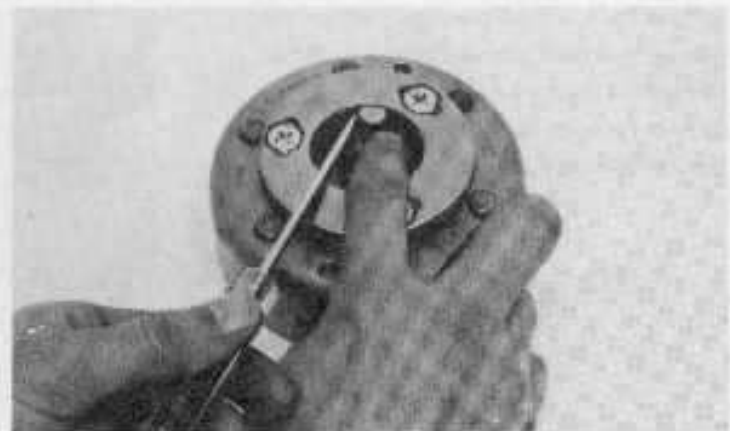



SERVICE INFORMATION	17-1	HANDLEBAR SWITCHES	17-3
BRAKE SWITCHES	17-2	IGNITION SWITCH	17-4
NEUTRAL SWITCH	17-2		

SERVICE INFORMATION

GENERAL INSTRUCTIONS

- Some wires have different colored bands around them near the connector. These are connected to other wires which correspond with the band color.
- All plastic plugs have locking tabs that must be released before disconnecting, and must be aligned when reconnecting.
- The following color codes are used throughout this section and on the wiring diagram (section 19).

B - Blue	G - Green	LG - Light Green	W - White
Bk - Black	Gr - Grey	O - Orange	Y - Yellow
Br - Brown	LB - Light Blue	R - Red	
- To isolate an electrical failure, check the continuity of the electrical path through the part. A continuity check can usually be made without removing the part from the motorcycle. Simply disconnect the wires and connect a continuity tester or volt-ohmmeter to the terminals or connections.
- A continuity tester is useful when checking to find out whether or not there is an electrical connection between two points. An ohmmeter is needed to measure the resistance of a circuit, as when there is a specific coil resistance involved, or when checking for high resistance caused by corroded connections.



BRAKE SWITCHES

FRONT BRAKE SWITCH

Remove the headlight.
Disconnect the G/Y and Bk leads of the front brake switch.

Check for continuity with the front brake applied.

Brake applied: Continuity

Brake not applied: No continuity

Replace the switch if necessary.

FRONT BRAKE SWITCH



G/Y LEAD



Bk LEAD

REAR BRAKE SWITCH

Remove the right side cover.
Disconnect the G/Y and Bk leads of the rear brake switch.

Check for continuity with the rear brake applied.

Brake applied: Continuity

Brake not applied: No continuity

Replace the switch if necessary.

REAR BRAKE SWITCH



Bk LEAD

G/Y LEAD

NEUTRAL SWITCH

Remove the left side cover and engine sprocket cover.

Check the switch for continuity between the switch terminal (wire removed) and ground with the transmission in neutral and with the transmission in any gear.

In neutral: Continuity

In gear: No continuity

Replace the neutral switch if necessary.

NEUTRAL SWITCH





HANDLEBAR SWITCHES

The handlebar cluster switches (light, turn signals, horn, engine stop, starter) must be replaced as an assembly.

Continuity tests for the components of the handlebar cluster switches follow:

Remove the headlight.

Continuity should exist between the color coded wires on each chart.



HEADLIGHT HI-LOW SWITCH

HI: B to Y
MIDDLE (N): Y to B to W
LO: Y to W

Headlight Hi-Low Switch

	Hi	Cl	Lo
Hi	○	○	
(N)	○	○	○
Lo		○	○
Color code	B	Y	W

TURN SIGNAL SWITCH

LEFT: O to Gr
OFF: No continuity
RIGHT: LB to Gr

Turn Signal Switch

	R	W	L
LEFT		○	○
OFF			
RIGHT	○	○	
Color code	LB	Gr	O

HORN BUTTON

LG to G with button depressed.
No continuity with button released.

Horn Button

	Ho	E
Color Code	LG	G

SWITCHES

HONDA
C70



STARTER BUTTON

Y/R to LG/R with button depressed.
No continuity with button released.

Starter Button

	ST	N
FREE		
PUSH	○	○
Color code	Y/R	LG/R

ENGINE STOP SWITCH

RUN: No continuity
OFF: Bk/W to G

Engine Stop Switch

	IG	E
OFF	○	○
RUN		
OFF	○	○
Color code	Bk/W	G

ENGINE STOP SWITCH

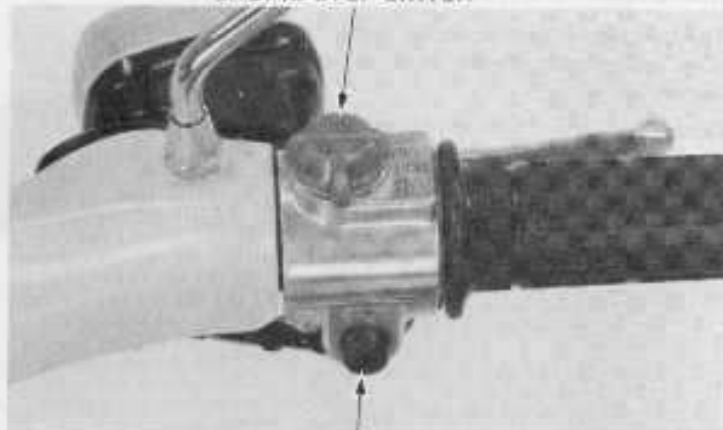

STARTER BUTTON

IGNITION SWITCH

Remove the front cover and disconnect the coupler.
Check the continuity of terminals in the ignition switch side coupler.

OFF: Bk/W to G
ON: Bk to R

	ST	BAT	IG	E
OFF			○	○
ON	○	○		
Color code	Bk	R	Bk/W	G

Replace the switch if necessary.

COUPLER



IGNITION SWITCH



ENGINE WILL NOT START OR IS HARD TO START	18-2	DIFFICULT SHIFTING	18-6
ENGINE LACKS POWER	18-3	ENGINE NOISE	18-6
POOR PERFORMANCE AT IDLE AND LOW SPEED	18-4	MOTORCYCLE PULLS TO ONE SIDE	18-7
POOR HIGH SPEED PERFORMANCE	18-5	FAULTY FRONT & REAR SHOCK ABSORBERS	18-7
SMOKING EXHAUST	18-6	FAULTY BRAKE	18-7
FAULTY CLUTCH	18-6	ELONGATED DRIVE CHAIN	18-7

ENGINE WILL NOT START OR IS HARD TO START

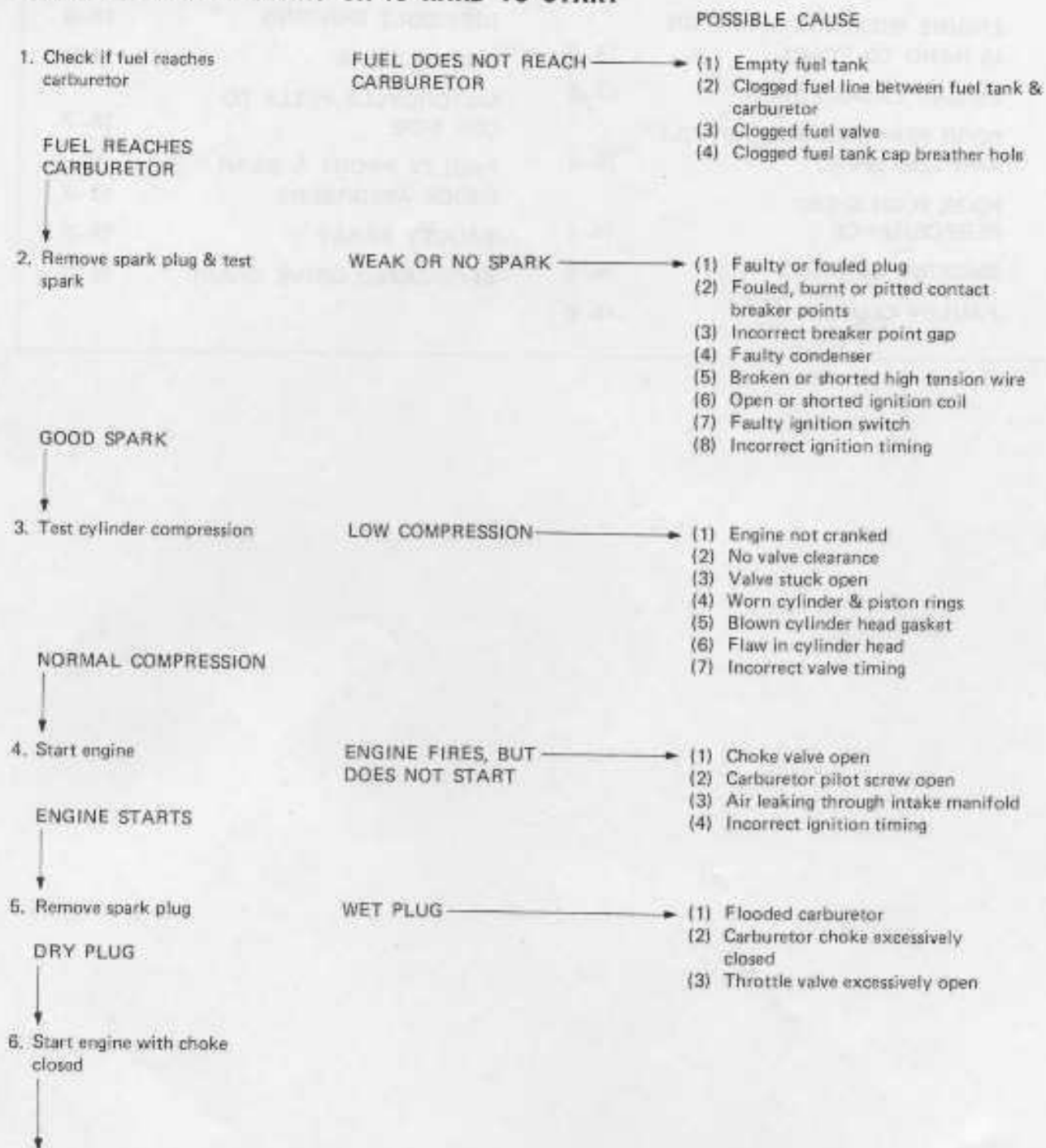



ENGINE LACKS POWER

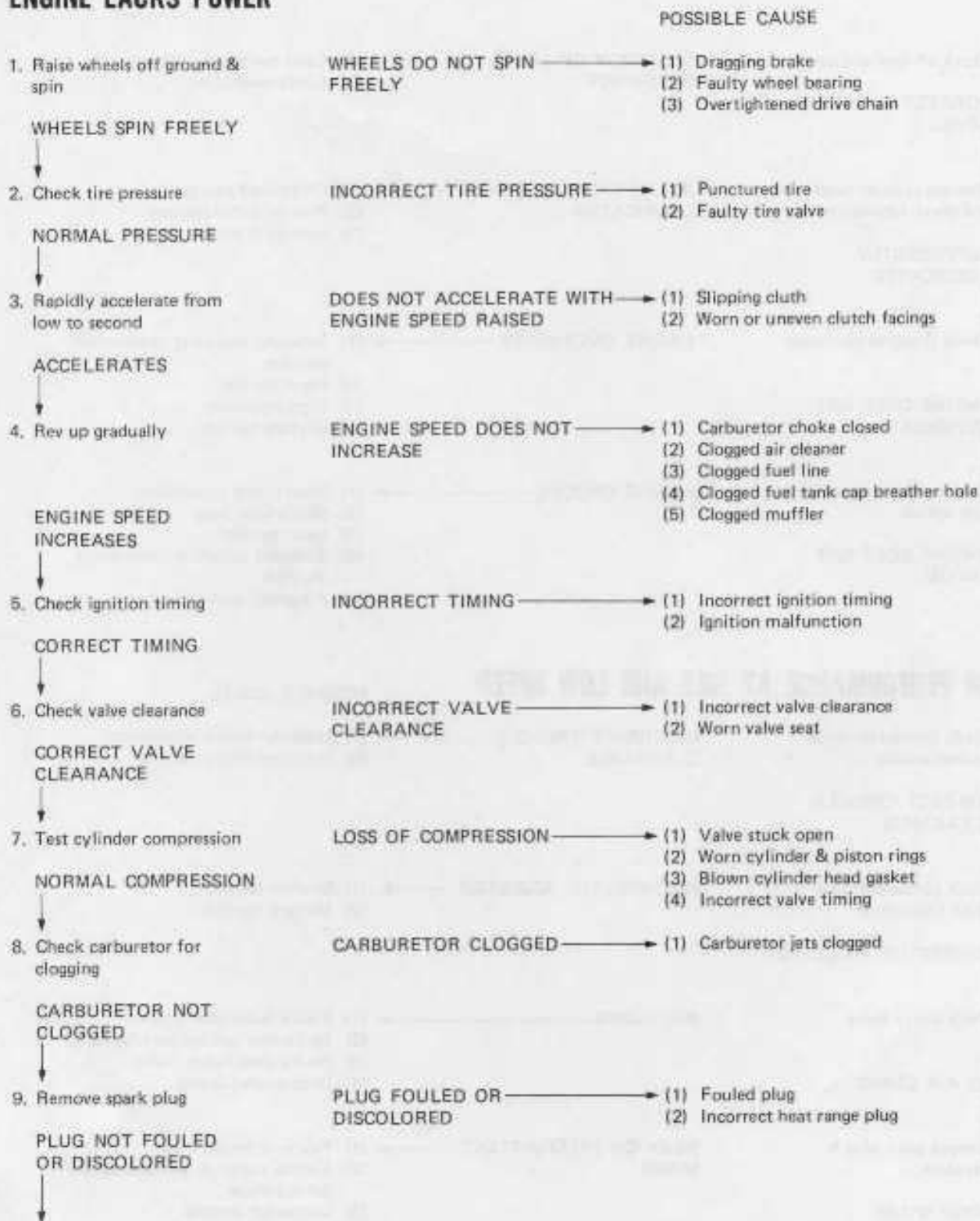

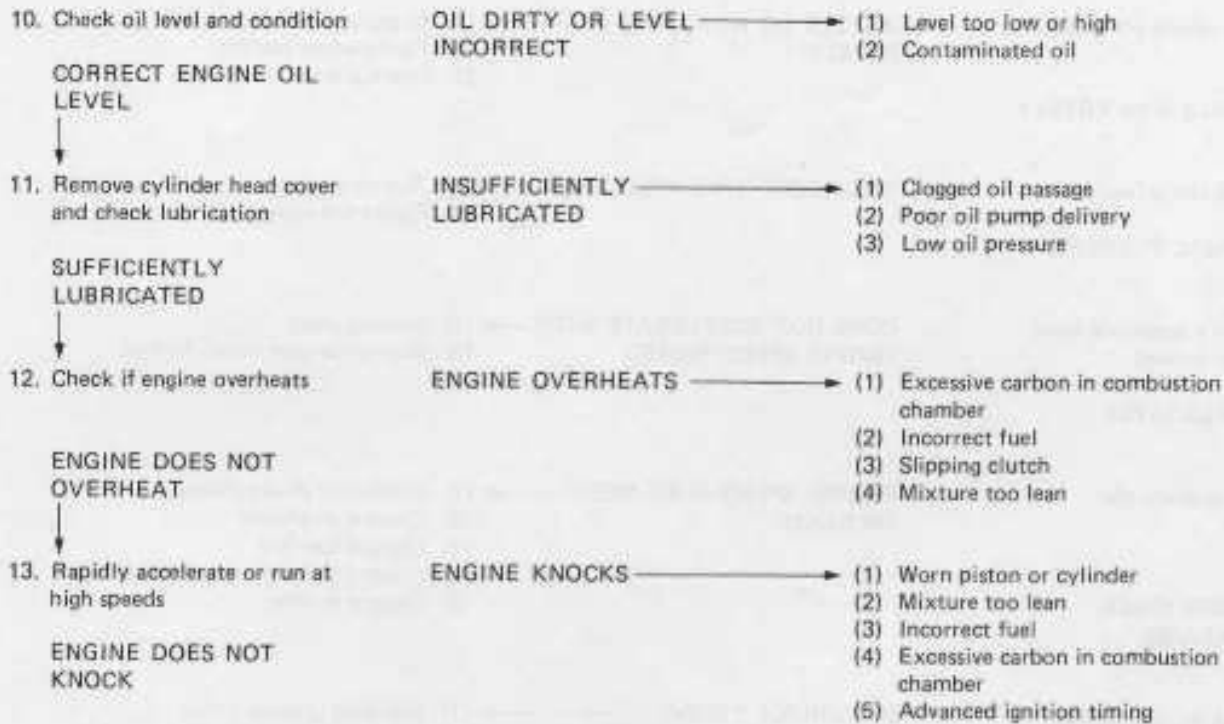

POOR PERFORMANCE AT IDLE AND LOW SPEED

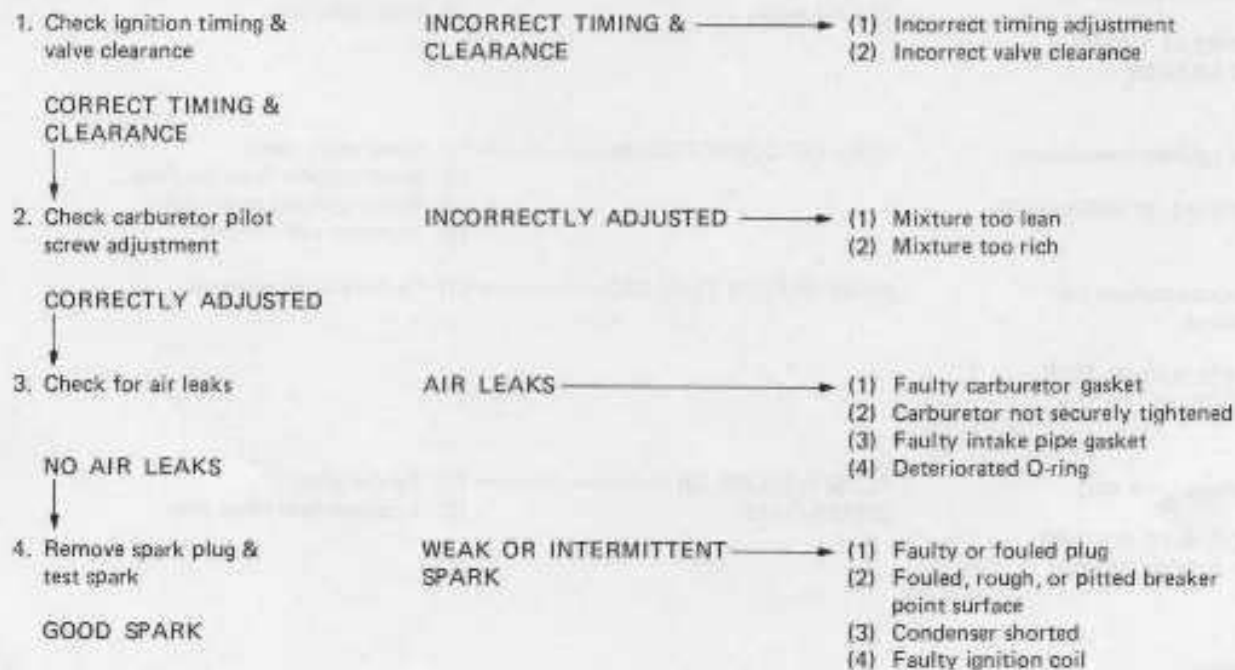



POOR HIGH SPEED PERFORMANCE

1. Check ignition timing & valve clearance

INCORRECT TIMING & CLEARANCE

POSSIBLE CAUSE

- (1) Incorrect timing adjustment
- (2) Incorrect valve clearance

CORRECT TIMING & CLEARANCE

2. Disconnect fuel tube at carburetor and check for clogging

RESTRICTED FUEL FLOW

- (1) Empty fuel tank
- (2) Clogged fuel tube
- (3) Clogged fuel tank cap breather hole

UNRESTRICTED FUEL FLOW

3. Check fuel filter, fuel valve, & carburetor jet for clogging

CLOGGED

- (1) Clogged jet
- (2) Clogged fuel filter
- (3) Clogged fuel valve

NOT CLOGGED

4. Replace carburetor main jet

CONDITION AGGRAVATED

- (1) Jet size too small
- (2) If condition improved with small jet:
 - a) Clogged air cleaner
 - b) Choke not opened fully

CONDITION IMPROVED

5. Check valve timing

INCORRECT

- (1) Incorrect valve timing adjustment

CORRECT

6. Check valve spring tension

WORN OR BROKEN SPRING

- (1) Faulty valve spring

SPRING TENSION CORRECT

SMOKING EXHAUST

1. Run motorcycle a long distance at high speed

BLACK SMOKE EMITTED

POSSIBLE CAUSE

- (1) Worn cylinder & piston rings
- (2) Oil level too high
- (3) Piston rings incorrectly installed
- (4) Faulty piston or cylinder
- (5) Flaws in cylinder head

THIN EXHAUST EMITTED

2. Return throttle grip quickly

WHITE SMOKE EMITTED

- (1) Worn intake valve guide or stem
- (2) Deteriorated valve guide O-ring

NO WHITE SMOKE EMITTED

3. Run motorcycle a long distance at low speed

WHITE SMOKE EMITTED

- (1) Worn exhaust valve guide & stem
- (2) Exhaust valve guide incorrectly seated
- (3) Worn exhaust valve stem seal

UNCOLORED EXHAUST

FAULTY CLUTCH

1. Properly adjust clutch

CLUTCH SLIPPING →

POSSIBLE CAUSE

- (1) Weak clutch spring
- (2) Worn or distorted clutch plate or friction disc

DIFFICULT SHIFTING

DIFFICULT SHIFTING →

POSSIBLE CAUSE

- (1) Broken gear shift arm spring
- (2) Broken shift fork
- (3) Sluggish movement of shift drum & fork
- (4) Broken shifting gear protrusion
- (5) Shift arm pawl disconnected from shift drum

PEDAL NOT RETURNED TO NEUTRAL →

- (1) Broken shift return spring
- (2) Shift shaft interfering with case or cover

GEARS JUMPING OUT OF POSITION →

- (1) Bent shifting gear or worn shift fork
- (2) Broken or weakened shift drum stopper spring

ENGINE NOISE

VALVE NOISE →

POSSIBLE CAUSE

- (1) Excessive valve clearance
- (2) Worn valve

PISTON SLAP →

- (1) Worn piston & cylinder
- (2) Excessive carbon in combustion chamber
- (3) Worn piston pin & connecting rod small end

CAM CHAIN NOISE →

- (1) Worn camshaft bearing
- (2) Worn camshaft sprocket teeth
- (3) Excessively elongated drive chain

CLUTCH CHATTER →

- (1) Excessive clearance between clutch plate & clutch outer
- (2) Weakened clutch damper spring

NOISY DRIVE & DRIVEN GEARS →

- (1) Worn or deteriorated driven gear damper
- (2) Worn gear teeth



MOTORCYCLE PULLS TO ONE SIDE

	POSSIBLE CAUSE
DIFFICULT STEERING IN BOTH DIRECTIONS →	(1) Overtightened steering head top thread nut (2) Broken steering steel balls (3) Bent steering stem
WHEEL WOBBLING →	(1) Excessive play in wheel bearing (2) Bent wheel rim (3) Loose spokes (4) Excessive play in swingarm pivot bushing (5) Frame bent (6) Drive chain adjusters unequally adjusted
MOTORCYCLE PULLS TO ONE SIDE →	(1) Unbalanced front & rear shock absorbers (2) Front & rear wheels not aligned (3) Bent front fork or swingarm

FAULTY FRONT & REAR SHOCK ABSORBERS

	POSSIBLE CAUSE
SOFT RIDE →	(1) Weak springs (2) Excessive load
HARD RIDE →	(1) Faulty front fork (2) Faulty rear shock absorber
NOISE IN SHOCK ABSORBER →	(1) Faulty stopper rubber (2) Faulty rear shock absorber

FAULTY BRAKE

	POSSIBLE CAUSE
INEFFECTIVE ADJUSTER →	(1) Worn brake lining, brake shoe cam or brake cam
SQUEAKING →	(1) Worn brake lining (2) Foreign particles on brake lining (3) Rough brake drum shoe contacting face (4) Worn brake panel bushing
INEFFECTIVE BRAKE →	(1) Faulty front brake cable (2) Brake shoe partially contacted (3) Mud or water in brake (4) Oil or grease on brake lining (5) Worn brake lining

ELONGATED DRIVE CHAIN

	POSSIBLE CAUSE
	(1) Incorrect adjustments (2) Not lubricated sufficiently enough (3) Worn sprockets



HONDA
C70

19. WIRING DIAGRAM

C70

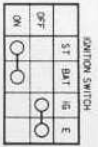
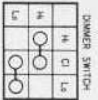
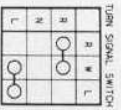
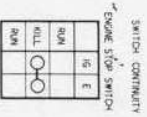
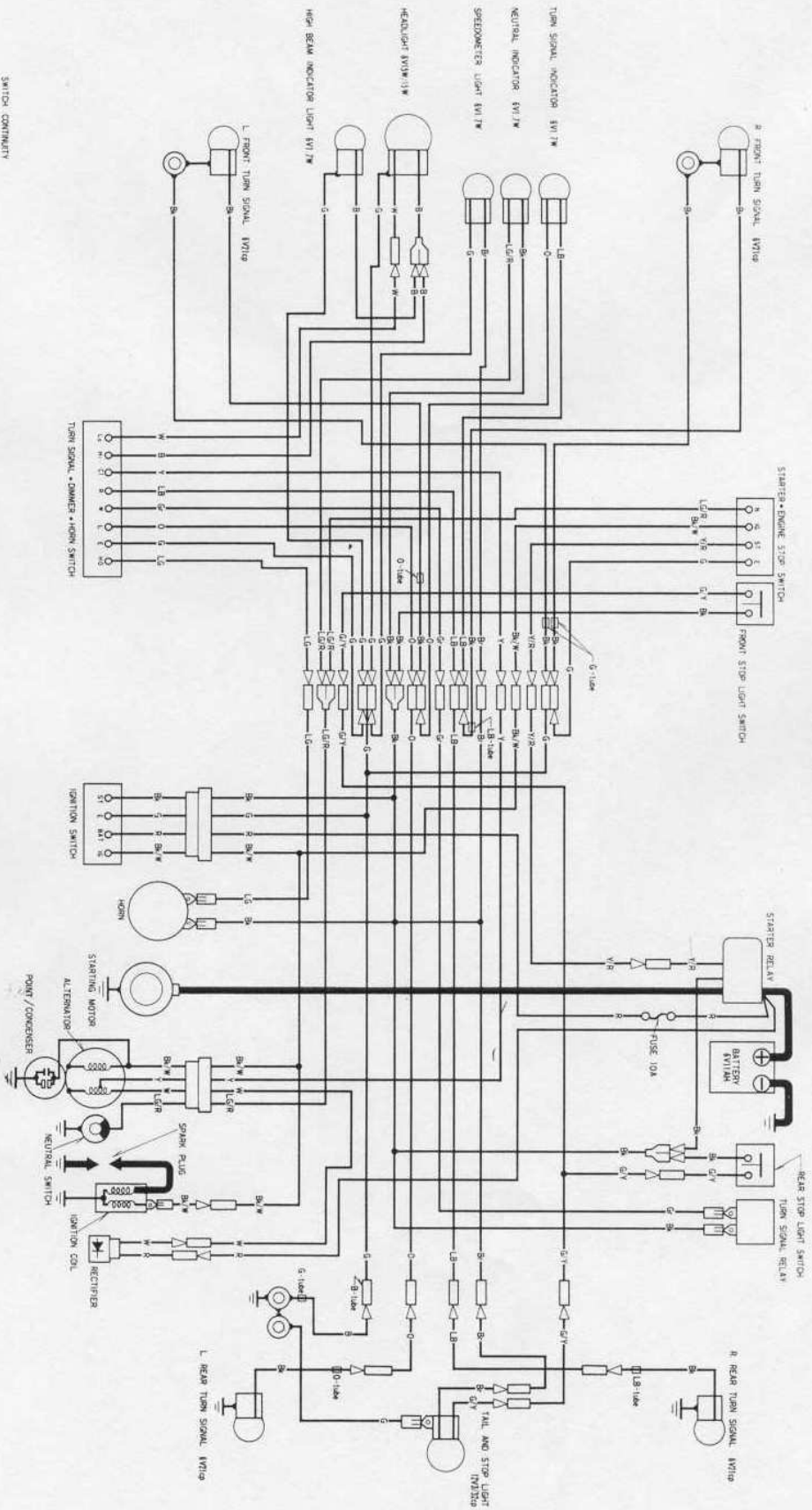

B	Black	Y	Yellow
Bk	Black	G	Green
W	White	Gr	Grey
LD	Light Green	LB	Light Blue
R	Red	O	Orange
G	Green	P	Pink

0030Z-174-6700



INTRODUCTION

This addendum contains information for the 1982 C70. Refer to the base shop manual for service information not included in this addendum.

ALL INFORMATION, ILLUSTRATIONS, DIRECTIONS AND SPECIFICATIONS INCLUDED IN THIS PUBLICATION ARE BASED ON THE LATEST PRODUCT INFORMATION AVAILABLE AT THE TIME OF APPROVAL FOR PRINTING. HONDA MOTOR CO., LTD. RESERVES THE RIGHT TO MAKE CHANGES AT ANY TIME WITHOUT NOTICE AND WITHOUT INCURRING ANY OBLIGATION WHATEVER.

NO PART OF THIS PUBLICATION MAY BE REPRODUCED WITHOUT WRITTEN PERMISSION.

HONDA MOTOR CO., LTD.
Service Publications Office

CONTENTS

1. GENERAL INFORMATION.....	20-2
2. LUBRICATION	20-6
3. INSPECTION AND ADJUSTMENT	20-6
4. FUEL SYSTEM.....	20-9
5. CYLINDER HEAD/VALVE	20-11
6. CLUTCH.....	20-12
7. TRANSMISSION	20-14
8. CAM CHAIN TENSIONER.....	20-14
9. FRONT WHEEL/SUSPENSION	20-17
10. REAR WHEEL/SUSPENSION	20-17
11. BATTERY/CHARGING SYSTEM	20-18
12. IGNITION SYSTEM.....	20-22
13. ELECTRIC STARTER	20-26
14. TECHNICAL FEATURES	20-27
15. TROUBLESHOOTING	20-28
16. WIRING DIAGRAM.....	20-31



1. GENERAL INFORMATION

SPECIFICATIONS

	ITEM	
DIMENSIONS	Overall length	1,800 mm (70.9 in)
	Overall width	660 mm (26.0 in)
	Overall height	1,010 mm (39.8 in)
	Minimum ground clearance	150 mm (5.9 in)
	Dry weight	82 kg (180.8 lb)
FRAME	Front suspension, travel	Bottom link 68 mm (2.7 in)
	Rear suspension, travel	Swingarm 61 mm (2.4 in)
	Caster angle	63°30'
	Trail	75 mm (2.95 in)
ENGINE	Maximum torque	0.6 kg-m (4.34 ft-lb)/6,000 rpm
	Oil capacity	0.8 liters (0.85 US qt, 0.71 Imp qt) after disassembly
	Intake valve	Opens 7.5° BTDC
		Closes 12.5° ABDC
	Exhaust valve	Opens 22.5° BBDC
	Closes 2.5° ATDC	
	Engine weight	20 kg (44.1 lb)
CARBURETION	Carb. identification number	PB15A
ELECTRICAL	Ignition	CDI
	Full advance	28.5° BTDC at 3,100 rpm
	Generator	Flywheel A.C. generator 84W/5,000 rpm
	Battery capacity	12V-5AH
	Spark plug	
Standard	U22FSR-U (ND), CR7HS (NGK)	
For cold climate below 5°C (41°F)	U20FSR-U (ND), CR6HS (NGK)	
For extended high speed riding	U24FSR-U (ND), CR8HS (NGK)	
LIGHTS	Headlight (high/low beam)	25/25W
	Turn signal	32/32 cp SAE No. 1073
	Speedometer	2W
	Neutral indicator	3.4W SAE No. 158
	Turn signal indicator	3.4W SAE No. 158
	High beam indicator	2W

**TORQUE VALUES****ENGINE**

Item	Q'ty	Thread dia. (mm)	Torque	
			kg-m	ft-lb
Camshaft sprocket	3	5	0.7-1.1	5-8
Final drive sprocket	2	6	1.1-1.5	8-11
Flywheel	1	10	3.0-3.8	22-28
Valve adjusting screw	2	5	0.7-1.1	5-8
Oil drain bolt	1	12	2.0-2.5	15-18
Fuel filter bolt	1	-	0.03-0.05	0.2-0.4

FRAME

Item	Q'ty	Thread dia. (mm)	Torque	
			kg-m	ft-lb
Top bridge side bolt	2	8	2.5-3.5	18-25
Steering lock	2	6	0.8-1.2	6-9
Engine hanger bolt	2	8	2.0-3.0	15-22
Rear axle sleeve nut	1	16	3.5-4.5	23-33
Rear brake torque link	2	8	1.8-2.5	11-18
Rear shock absorber	4	10	2.5-3.5	18-25
Swingarm pivot bolt	1	10	2.5-3.5	18-25
Front suspension pivot bolt	2	8	2.0-2.5	15-18
Front shock absorber upper bolt	2	8	2.0-2.5	15-18

TOOLS**SPECIAL**

Tool Name	Tool No.	Q'ty	Ref. page
Flywheel holder	07925-GB40000	1	20-20
Valve adjuster	07908-GB40000	1	20-8
Rotor puller	07933-4300000	1	20-20

CABLE AND HARNESS ROUTING

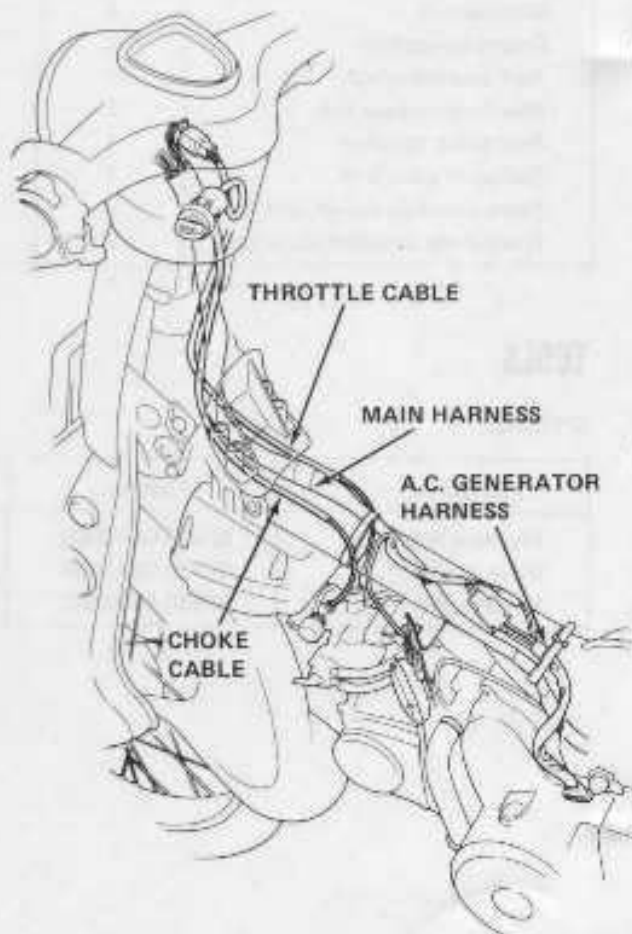
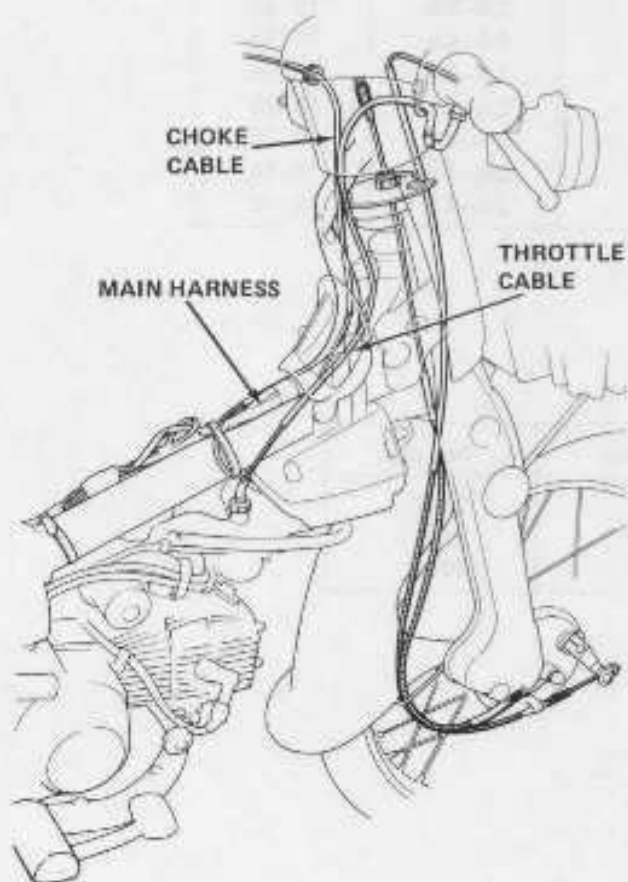
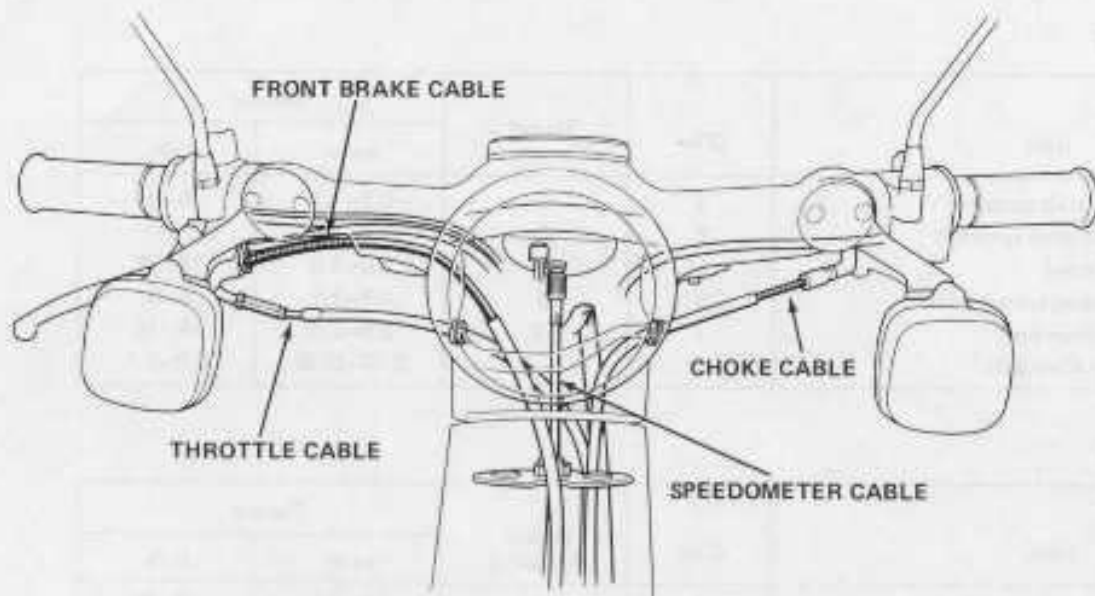



MAINTENANCE SCHEDULE

Perform the PRE-RIDE INSPECTION in the Owner's Manual at each scheduled maintenance period.

- I: Inspect and Clean, Adjust, Lubricate or Replace if necessary.
- C: Clean
- R: Replace
- A: Adjust
- L: Lubricate

ITEM	FREQUENCY	WHICHEVER COMES FIRST	ODOMETER READING (NOTE 3)				Refer to page
			800 mi (1,000 km)	2,500 mi (4,000 km)	5,000 mi (8,000 km)	7,500 mi (12,000 km)	
EMISSION RELATED ITEMS	* FUEL LINES			I	I	I	3-3
	* FUEL STRAINER		C	C	C	C	20-6
	* THROTTLE OPERATION		I	I	I	I	3-3
	* CARBURETOR CHOKE			I	I	I	20-6
	AIR CLEANER	NOTE (1)		C	C	R	20-7
	CRANKCASE BREATHER	NOTE (2)		CLEAN EVERY 1,250 mi (2,000 km)			3-5
	SPARK PLUG			R	R	R	20-23
	* VALVE CLEARANCE			I	I	I	20-8
	ENGINE OIL	YEAR		R	REPLACE EVERY 1,250 mi (2,000 km)		2-2, 20-6
	* ENGINE OIL FILTER SCREEN				C		2-2
	* CARBURETOR IDLE SPEED			I	I	I	3-10
NON-EMISSION RELATED ITEMS	DRIVE CHAIN			I, L EVERY 300 mi (500 km)			3-11
	BATTERY	MONTH		I	I	I	19-13
	BRAKE SHOE WEAR			I	I	I	3-13
	BRAKE SYSTEM			I	I	I	3-14
	* BRAKE LIGHT SWITCH			I	I	I	3-15
	* HEADLIGHT AIM			I	I	I	3-15
	CLUTCH			I	I	I	3-16
	SIDE STAND				I	I	3-16
	* SUSPENSION			I	I, L	I, L	3-17
	* NUTS, BOLTS, FASTENERS			I	I	I	3-18
	** WHEELS/SPOKES			I	I	I	3-18
** STEERING HEAD BEARING			I		I	3-18	

* Should be serviced by an authorized Honda dealer, unless the owner has proper tools and service data and is mechanically qualified.

** In the interest of safety, we recommend these items be serviced only by an authorized Honda dealer.

- NOTES: (1) Service more frequently when riding in dusty areas.
 (2) Service more frequently when riding in rain or at full throttle (U.S.A. only).
 (3) For higher odometer readings, repeat at the frequency interval established here.

2. LUBRICATION

OIL RECOMMENDATIONS

Use HONDA 4-STROKE OIL or equivalent.
API SERVICE CLASSIFICATION: SE or SF
VISCOSITY:
SAE 10W-40

Other viscosities shown in the chart may be used when the average temperature in your riding area is within the indicated range.

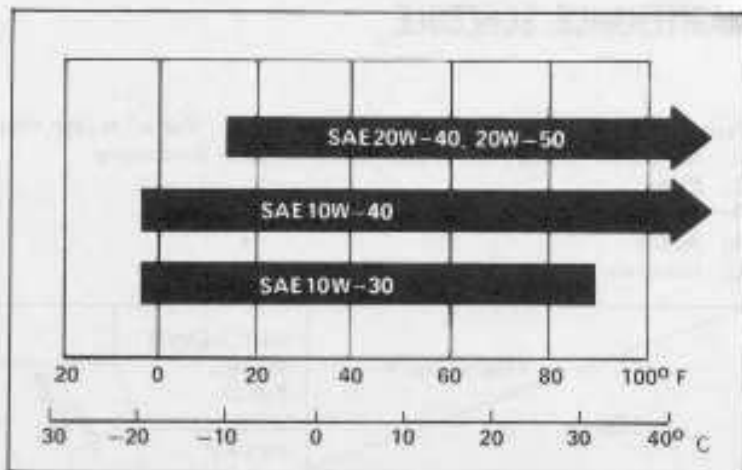

3. INSPECTION AND ADJUSTMENT

FUEL STRAINER

Turn the fuel valve OFF.

Loosen the carburetor drain screw and drain the fuel from the carburetor into a suitable container.

WARNING Gasoline is flammable and is explosive under certain conditions. Do not smoke or allow flames or sparks near the equipment while draining fuel.

Remove the fuel filter bolt and pull out the fuel filter and O-rings.

Wash the fuel filter in clean non-flammable or high flash point solvent.

Reinstall the fuel filter and new O-rings into the fuel valve. Hand tighten the fuel filter bolt making sure the new O-rings are in place. Then torque to specification:

TORQUE: 0.3–0.5 kg·m (2–4 ft·lb)

After installing, turn the fuel valve ON and check that there are no fuel leaks.

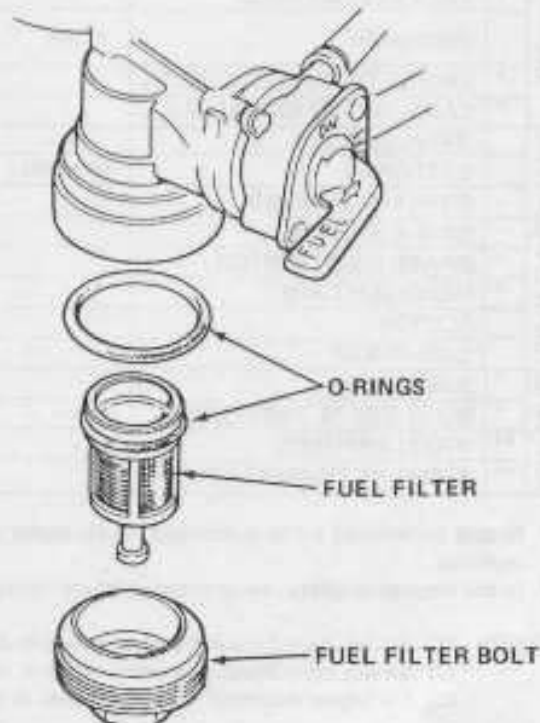



CARBURETOR CHOKE

Check for smooth choke lever operation.

The lever should stay where positioned. Move the choke lever all the way to the left and make sure the choke valve is closed by moving the choke lever at the carburetor.

ADJUSTMENT:

Remove the front cover.

Loosen the cable clamp and pull the cable casing up just until the choke valve is fully closed. Retighten the clamp. Move the choke lever all the way to the right and be sure the choke valve is fully open by checking for 1-2 mm (1/16-1/8 in) cable slack.

Install the front cover.



CHOKE LEVER



CHOKE LEVER

AIR CLEANER

Turn the handlebar all the way to the right.

Loosen the screws attaching the connecting tube and breather tube and disconnect the tubes.

Remove the screws attaching the air cleaner case. Pull out the case with the air cleaner element.

AIR CLEANER CASE

BREATHER TUBE



CONNECTING TUBE

Remove the air cleaner element.

Clean the element by tapping it lightly to loosen dust. Blow away any remaining dust by applying compressed air from the inside of the element.

Replace the element if it is excessively dirty, torn or damaged.

Install the element and connect the connecting tube.

Install the air cleaner case.

Connect the breather tube.

AIR CLEANER CASE

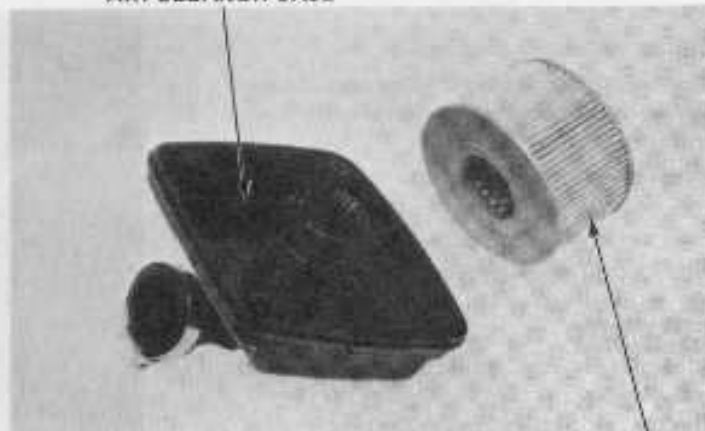

ELEMENT

VALVE CLEARANCE

NOTES:

- Inspect and adjust valve clearance while the engine is cold (below 35°C, 95°F).
- Note the location of the "T" mark.

To check the valve clearance, remove the crankshaft, timing mark hole and valve inspection caps.

Adjust clearance if necessary using valve adjuster 07908-GB40000 (see page 3-6).

Be sure to reinstall the caps.

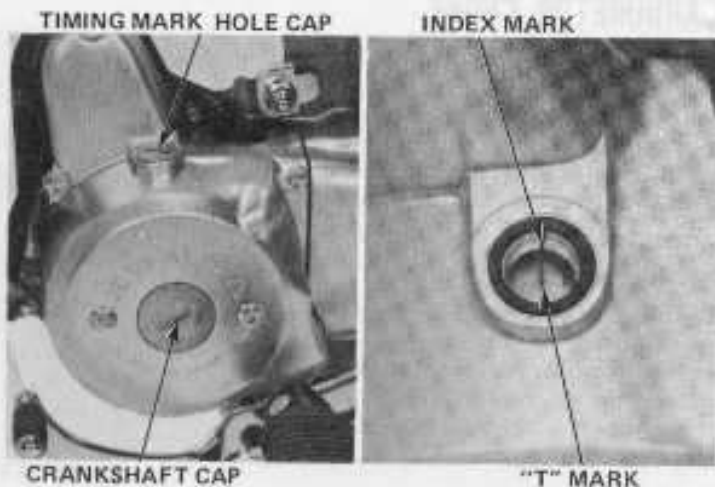

IGNITION TIMING

NOTE: The Capacitive Discharge Ignition system is factory pre-set and cannot be adjusted. To inspect the function of the CDI components, ignition timing inspection procedures are given here.

Remove the timing hole cap.

Connect a tachometer and timing light. Start the engine and allow it to idle (1,500 rpm). Check the ignition timing.

Timing is correct if the index mark aligns with the "F" mark at idle.

If the ignition timing is incorrect, check the CDI unit, exciter coil and pulse generator, and replace faulty parts. Refer to page 20-22, Ignition System.

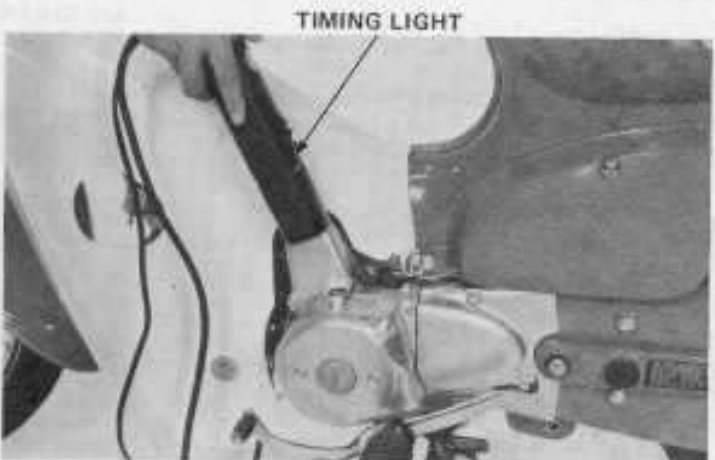

BATTERY

Remove the right side cover.

Inspect the battery fluid level.

When the fluid nears the lower level, loosen the bolt and open the battery bracket for access to the battery.

Remove the battery filler caps.

Carefully add distilled water to the upper level mark using a small syringe or plastic funnel.

NOTE: Add only distilled water. Tap water will shorten the service life of the battery.

WARNING The battery electrolyte contains sulfuric acid. Protect your eyes, skin, and clothing.

In case of contact, flush thoroughly with water and contact a doctor if electrolyte gets in your eyes.

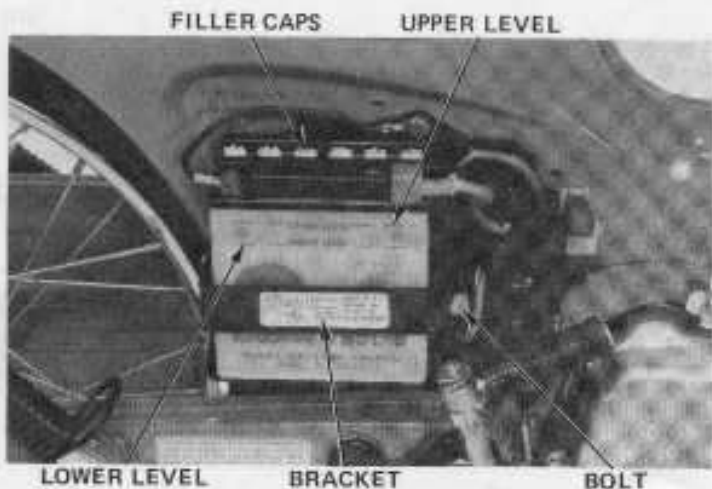



Replace the battery if sulfation or sediments have accumulated on the bottom.

CAUTION: When checking the battery electrolyte level or adding distilled water, make sure the breather tube is connected to the battery breather outlet elbow as shown.

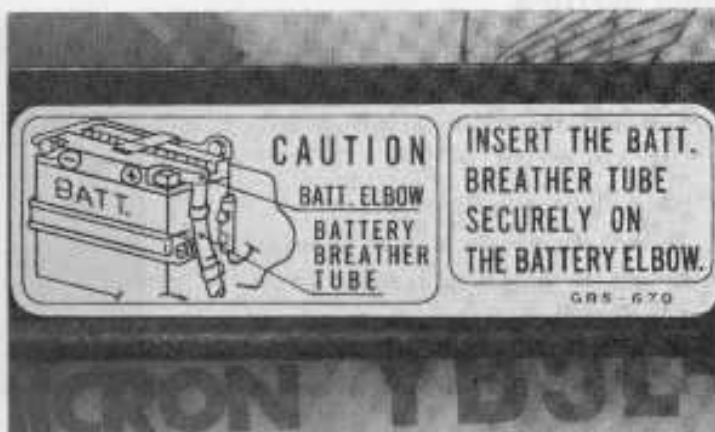

4. FUEL SYSTEM

SPECIFICATIONS

Carb identification no.	PB15A	
Main jet	Below 1,500 m (5,000 ft) # 75	Above 2,000 m (6,500 ft) # 72
Throttle valve	# 3.0	
Jet needle	OAA	

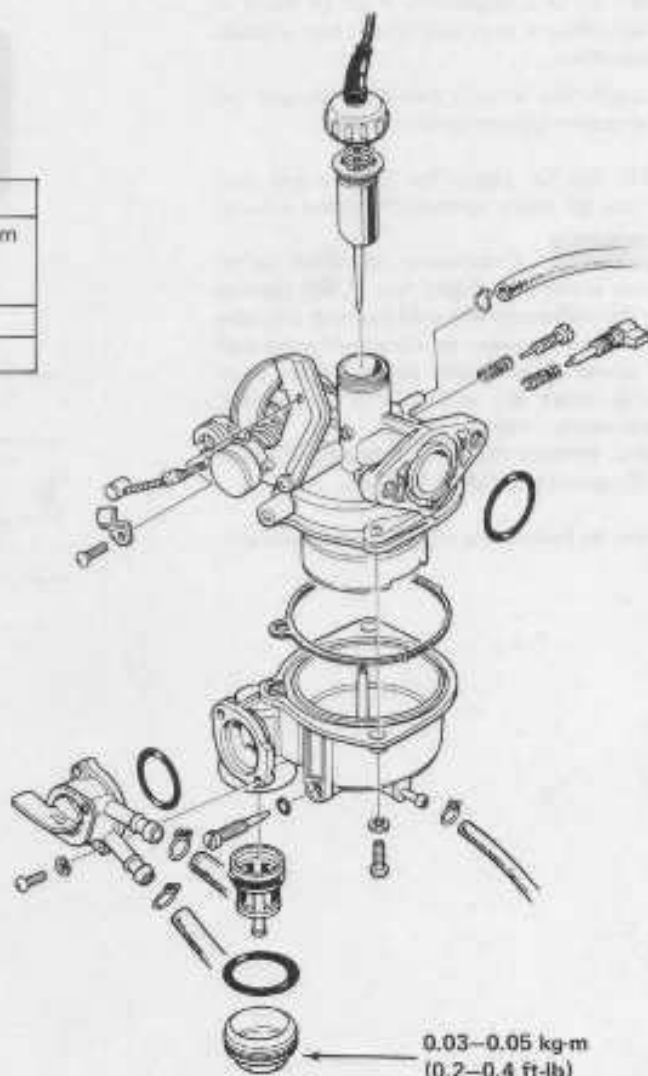

HIGH ALTITUDE

When the vehicle is to be operated continuously above 2,000 meters (6,500 feet) the carburetor must be adjusted to improve drivability and decrease exhaust emissions.

1. Remove the carburetor.
2. Remove the carburetor float chamber.
3. Remove the # 75 main jet and install the # 72 main jet.
4. Reassemble and install the carburetor.
5. Warm up the engine to operating temperature. (Stop and go driving for ten minutes is sufficient.)
6. Adjust the idle speed to $1,500 \pm 100$ rpm with the throttle stop screw.

NOTE: This adjustment must be made at high altitude to ensure proper high altitude operation.

7. Attach the Vehicle Emission Control Information Update label as shown.

NOTE: Do not attach the label to any part that can be easily removed from the vehicle.

WARNING Continuous operation at an altitude lower than 5,000 feet (1,500 meters) with the carburetor adjusted for high altitudes may cause the engine to idle roughly and stall and could cause engine damage from overheating. When the vehicle is to be operated continuously below 5,000 feet (1,500 meters), reinstall the # 75 main jet and adjust the idle speed to $1,500 \pm 100$ rpm.

Be sure to make these adjustments at low altitude.

MAIN JET



VEHICLE EMISSION CONTROL INFORMATION UPDATE
HONDA MOTOR CO., LTD.
THIS VEHICLE HAS BEEN ADJUSTED TO
IMPROVE EMISSION CONTROL PERFORMANCE
WHEN OPERATED AT HIGH ALTITUDE.
ALTITUDE PERFORMANCE ADJUSTMENT INSTRUCTIONS
ARE AVAILABLE AT YOUR AUTHORIZED HONDA DEALER.

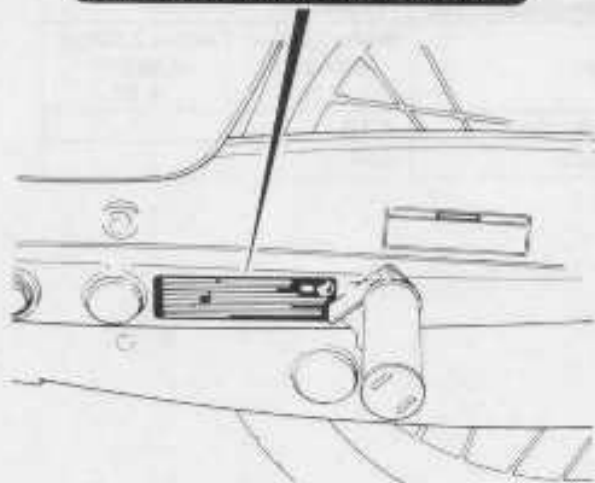



5. CYLINDER HEAD/VALVE

SPECIFICATIONS

			STANDARD	SERVICE LIMIT
Camshaft	Cam height	IN.	27.945 mm (1.1002 in)	27.55 mm (1.0846 in)
		EX.	26.076 mm (1.0266 in)	25.69 mm (1.0114 in)

CYLINDER HEAD

REMOVAL

Remove the front cover.

Disconnect the intake pipe from the cylinder head.

Remove the muffler and the spark plug cap.

Remove the cylinder head left side cover.

Remove the crankshaft cap and turn the crankshaft counterclockwise to align the "O" mark on the camshaft sprocket with the index mark.

Remove the camshaft sprocket.

Remove the cylinder head (page 6-4).

INSTALLATION

Install the cylinder head assembly (page 6-13).

Remove the cam chain tensioner push rod (page 20-14).

Turn the crankshaft counterclockwise and align the "T" mark with the index mark.

Place the cam chain over the camshaft sprocket, aligning the sprocket "O" mark with the cylinder head index mark.

Install the camshaft sprocket on the camshaft and tighten the sprocket bolts.

TORQUE: 0.7–1.1 kg-m (5–8 ft-lb)

Install the remaining removed parts (page 6-14).

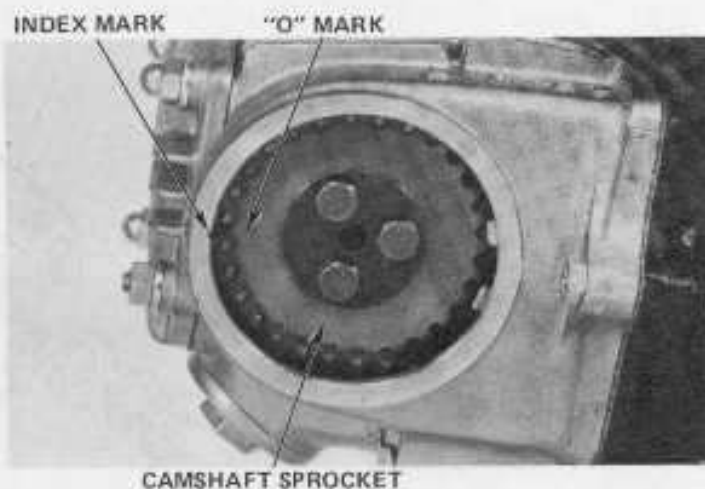

CAMSHAFT SPROCKET



"T" MARK

6. CLUTCH

SPECIFICATION

ITEM	STANDARD	SERVICE LIMIT
Clutch spring free length	19.1 mm (0.75 in)	17.5 mm (0.69 in)

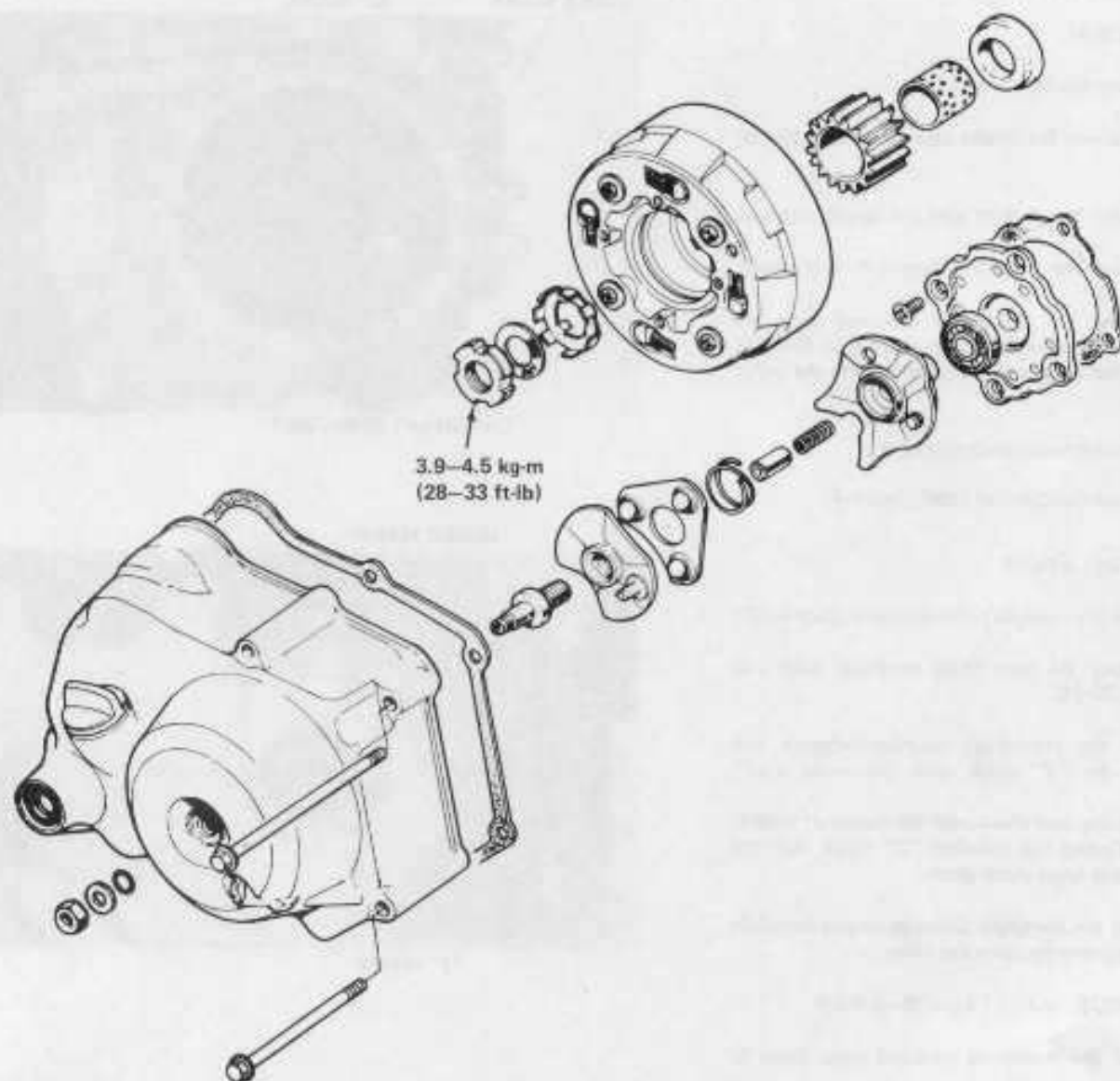



NOTE: For disassembly and inspection see page 8-3.

ASSEMBLY

Install the clutch weights on the clutch drive plate as shown.

Install the stop ring and the clutch springs.

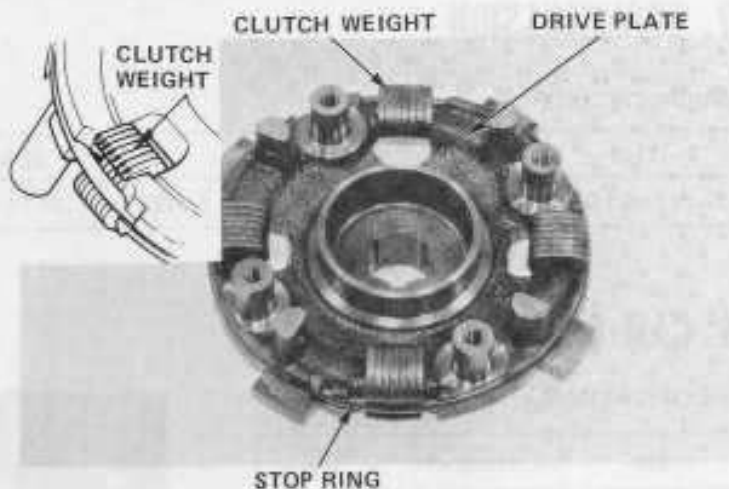

Install the drive plate in the clutch outer and tighten the screws in 2-3 steps in a crisscross pattern.

Install the clutch damper springs.

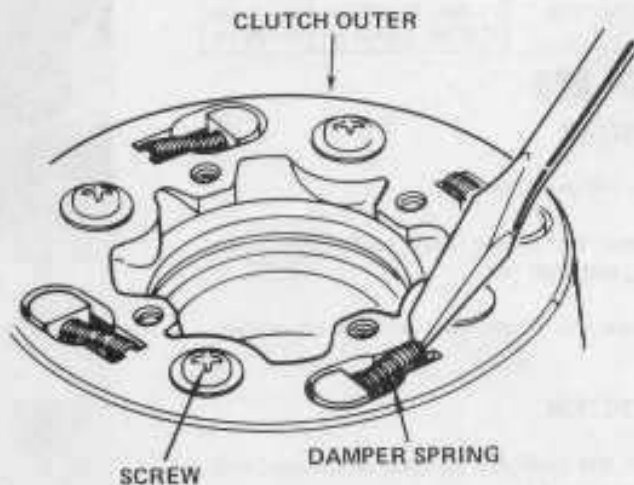

Install the drive gear outer and clutch center.

NOTE: Align the grooves in the clutch center with the bosses on the drive gear.

Install the clutch plates and discs and secure with the set ring.

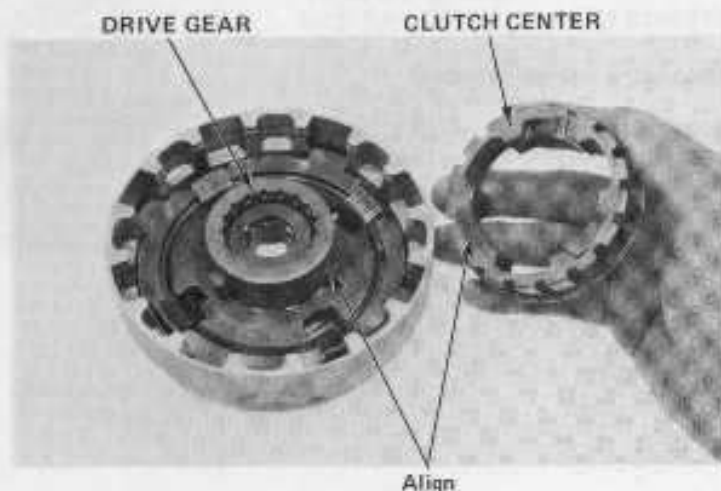

7. TRANSMISSION

SPECIFICATIONS

ITEM	STANDARD	SERVICE LIMIT
Shift fork I.D.	34.075–34.100 mm (1.3415–1.3425 in)	34.14 mm (1.344 in)

8. CAM CHAIN TENSIONER

SPECIFICATIONS

ITEM	STANDARD	SERVICE LIMIT
Spring free length	83 mm (3.3 in)	77 mm (3.0 in)
Push rod O.D.	11.985–12.000 mm (0.4718–0.4724 in)	11.94 mm (0.470 in)

PUSH ROD

REMOVAL

Drain the engine oil.

Remove the sealing bolt, washer, tensioner spring and push rod.

Remove the 6-mm bolt and sealing washer.

INSPECTION

Check the push rod for wear or damage, and measure the O.D.

STANDARD: 11.985–12.000 mm (0.4718–0.4724 in)

SERVICE LIMIT: 11.94 mm (0.470 in)

Measure the spring free length.

STANDARD: 83 mm (3.3 in)

SERVICE LIMIT: 77 mm (3.0 in)

Replace either part if its measurement does not fall within the limit.

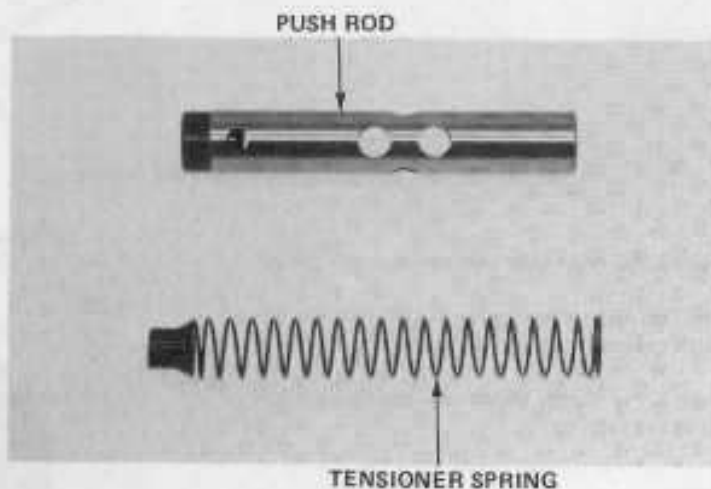
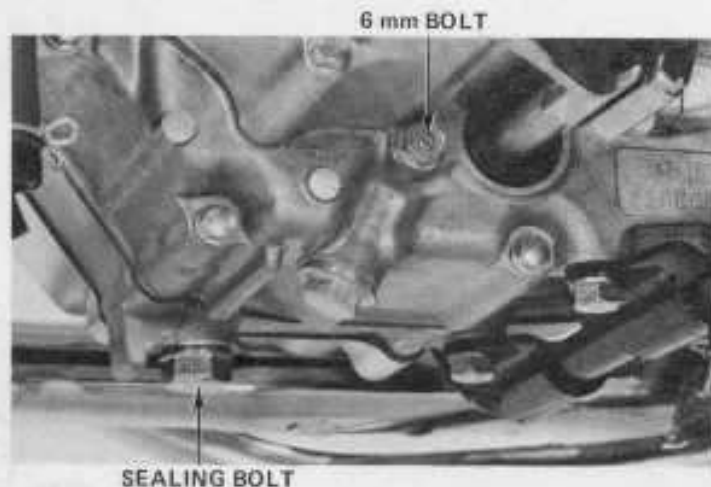



TENSIONER

REMOVAL

Remove the tensioner push rod (page 20-14).

Remove the A.C. generator and flywheel (page 20-19).

Remove the starter chain and sprockets (page 16-5).

Remove the crankshaft cover and the cam chain tensioner.

Check the tensioner sprocket for wear or damage.

CRANKSHAFT COVER



O-RING

TENSIONER/PUSH ROD

INSTALLATION

Install the cam chain tensioner.

Install the O-rings on the crankshaft cover screw holes and cover.

Install the crankshaft cover and tighten it with two screws.

O-RING BOLT CAM CHAIN TENSIONER

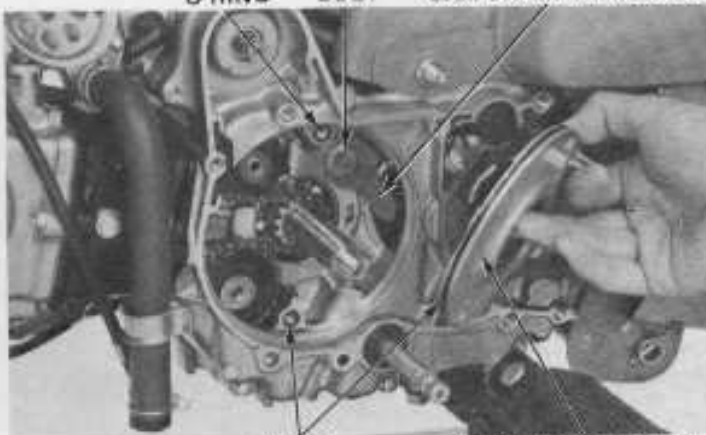

O-RING

CRANKSHAFT COVER

Install the starter chain and sprockets.

Install the flywheel and A.C. generator (page 20-19).

SNAP RING CHAIN GUIDE

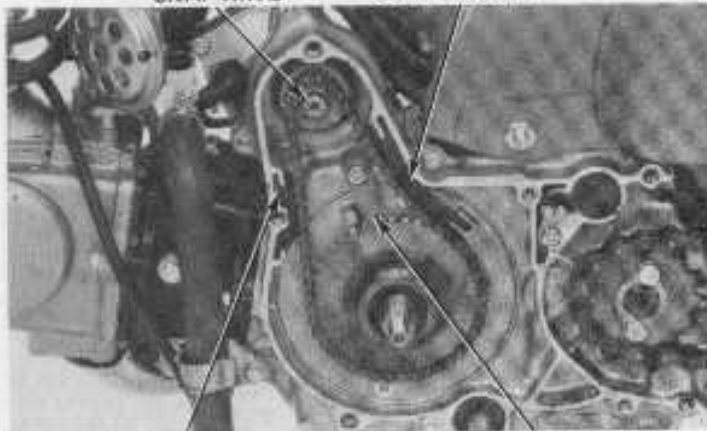

PROTECTOR

SETTING PLATE



Install the push rod, spring, washer and sealing bolt.

NOTE: Make sure the push rod valve is free from dust before installation.

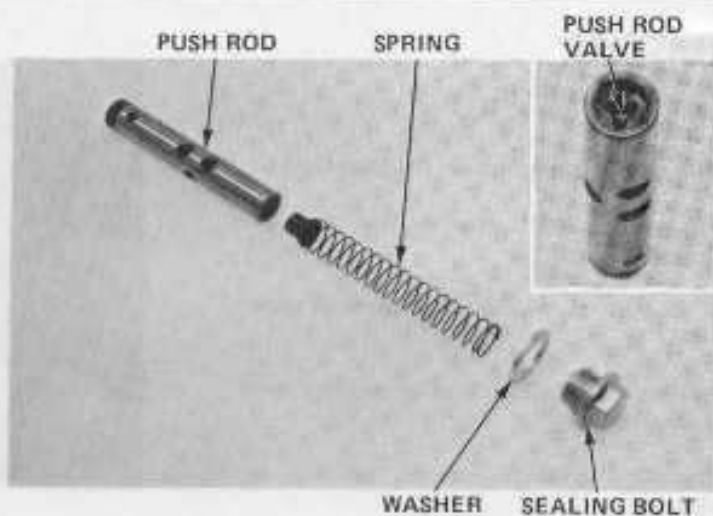

Torque the sealing bolt.

TORQUE: 2.0–2.5 kg-m (15–18 ft-lb)

Fill the crankcase with the recommended oil (page 20-4).

Pour clean engine oil through the 6 mm bolt hole until oil flows out of the hole.

Install the 6 x 18 mm bolt and sealing washer.

NOTE: Use the proper length bolt. A longer bolt may interfere with the push rod.

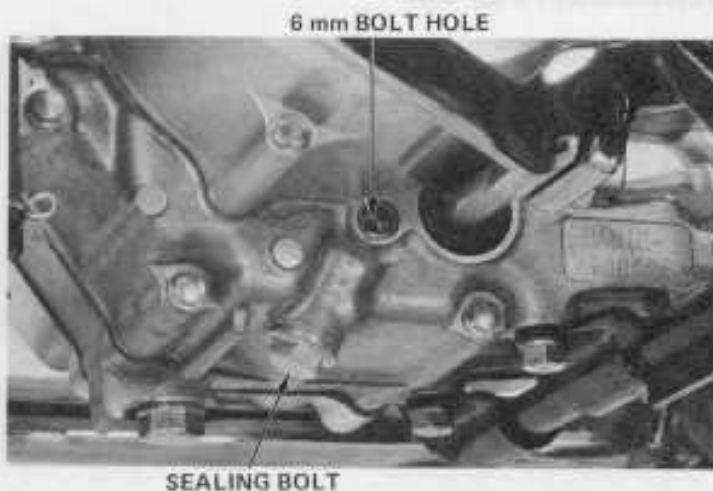



9. FRONT WHEEL/SUSPENSION

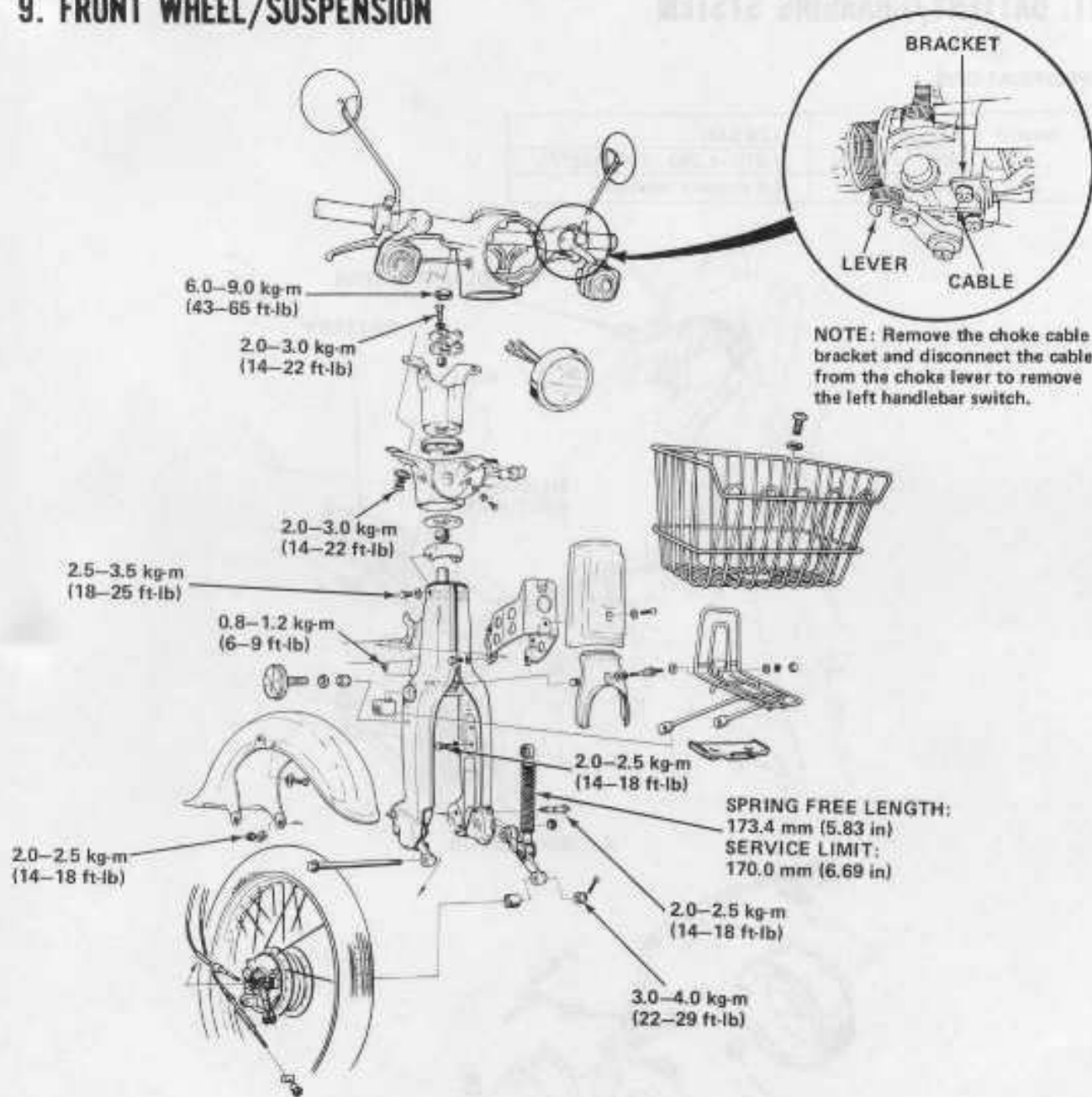

10. REAR WHEEL/SUSPENSION

SPECIFICATIONS

ITEM	STANDARD	SERVICE LIMIT
Shock absorber spring free length	229.1 mm (9.02 in)	224.5 mm (8.84 in)

11. BATTERY/CHARGING SYSTEM

SPECIFICATIONS

Battery	Capacity	12V 5AH
	Specific gravity	1.270-1.290 / 20°C (68°F)
	Charging rate	1.4 amperes maximum

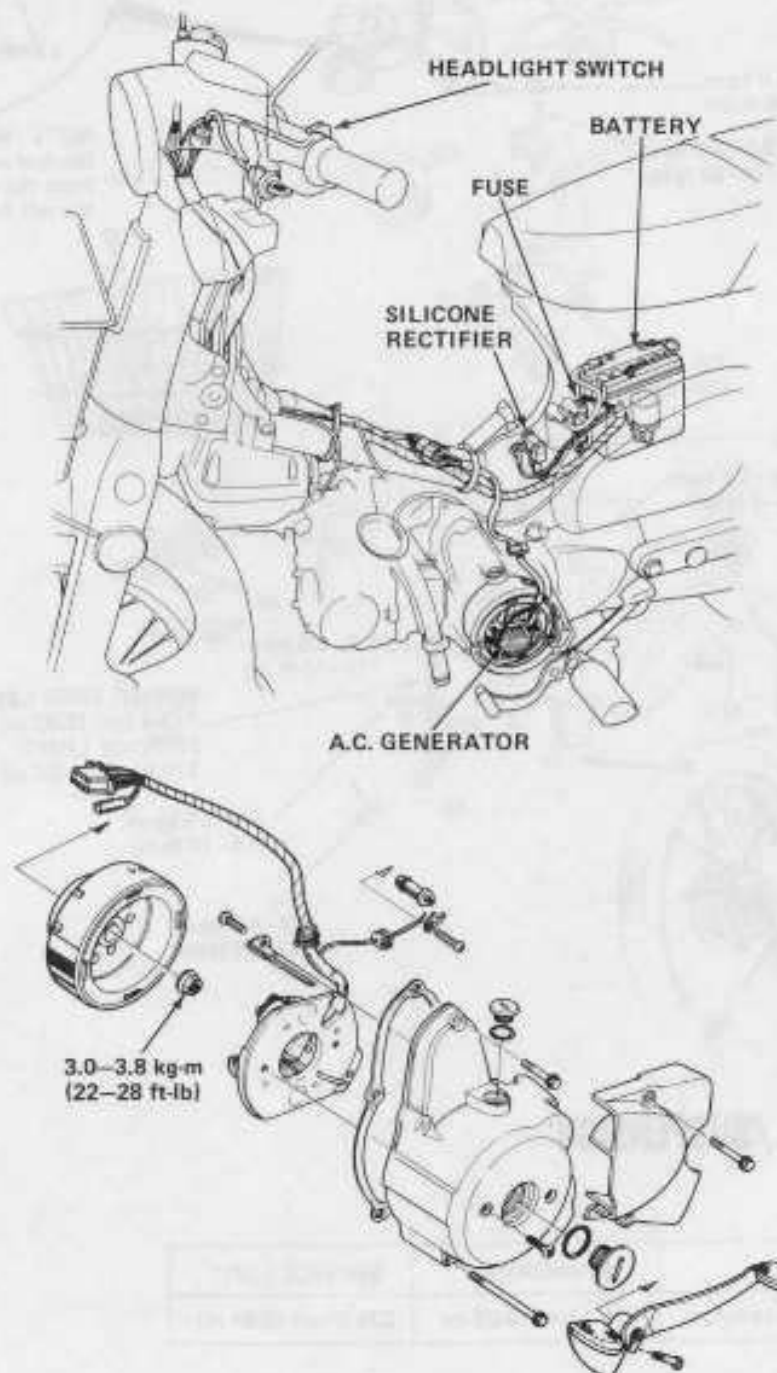



A.C. GENERATOR

INSPECTION

Remove the front cover.

Disconnect the A.C. generator coupler.

Measure the resistance between the terminals.

RESISTANCE:

White-Green: 0.3-0.6 Ohms

Yellow-Green: 0.2-0.6 Ohms

Replace the stator assembly if either resistance is not within range.

REMOVAL

Remove the front cover.

Remove the gearshift pedal and the drive sprocket cover.

Disconnect the A.C. generator coupler.

Disconnect the neutral switch lead from the switch terminal and remove the left crankcase cover.

Remove the wire protector.

A.C. GENERATOR COUPLER



DRIVE SPROCKET COVER



GEARSHIFT PEDAL

LEFT CRANKCASE COVER

NEUTRAL SWITCH

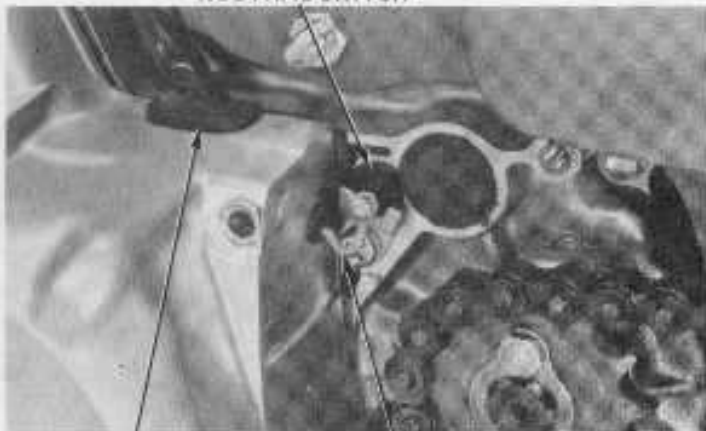

WIRE PROTECTOR

WIRE LEAD

Remove two stator screws and stator from the left crankcase cover.

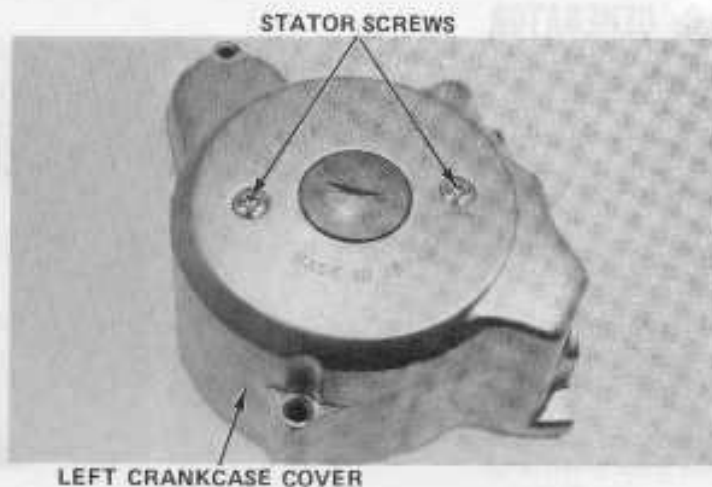

Use the flywheel holder or a band strap holder and secure the flywheel to prevent the crankshaft from turning.

Remove the generator rotor nut.

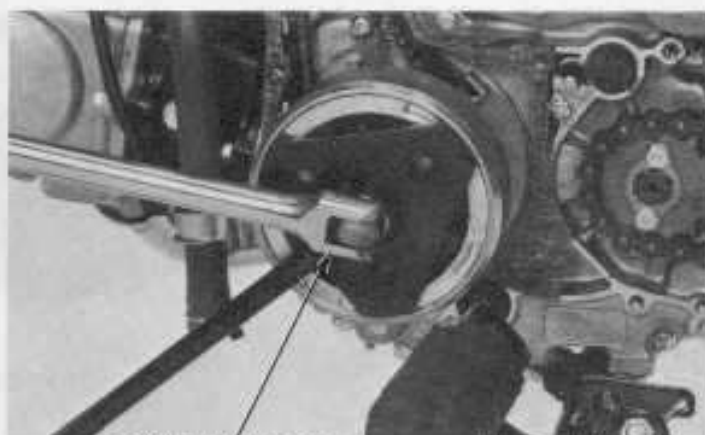

or commercially available
band strap holder

Remove the rotor.

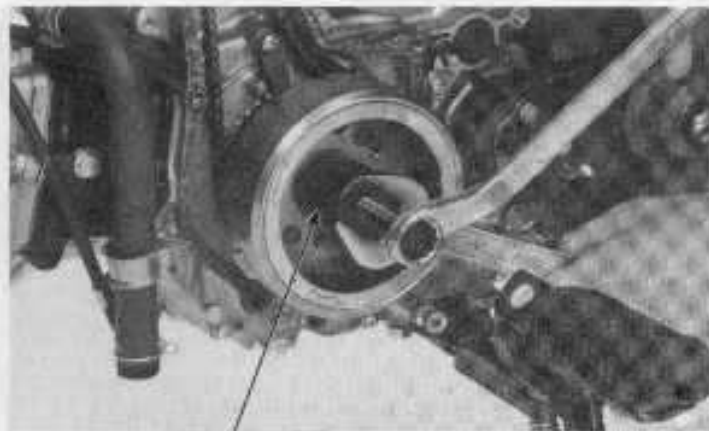



INSTALLATION

Align the rotor keyway with the key on the crankshaft and install the generator rotor.

Tighten the rotor nut.

TORQUE: 3.0–3.8 kg-m (22–28 ft-lb)

FLYWHEEL HOLDER



Install the stator on the left crankcase cover with the screws.

Route the generator leads properly and install the wire protector.

WIRE PROTECTOR

STATOR



Connect the neutral switch lead to the switch terminal.

Install the left crankcase cover, drive sprocket cover and gearshift pedal.

Connect the generator wire coupler.

Install the front cover.

NEUTRAL SWITCH



WIRE LEAD

12. IGNITION SYSTEM

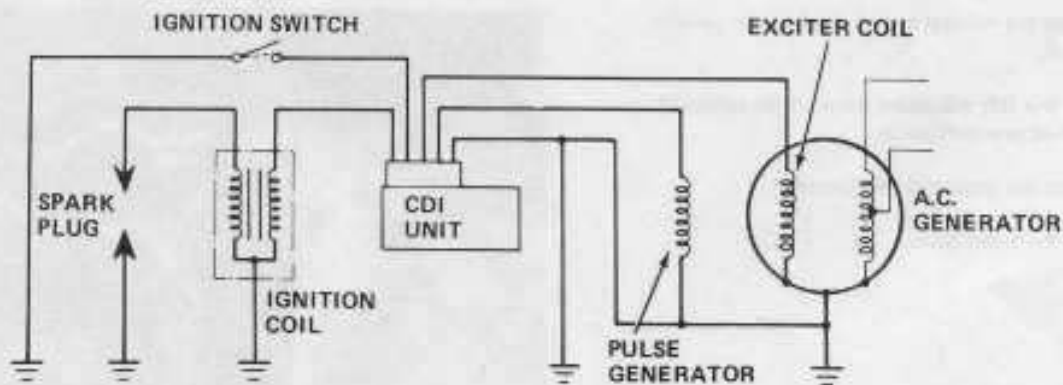
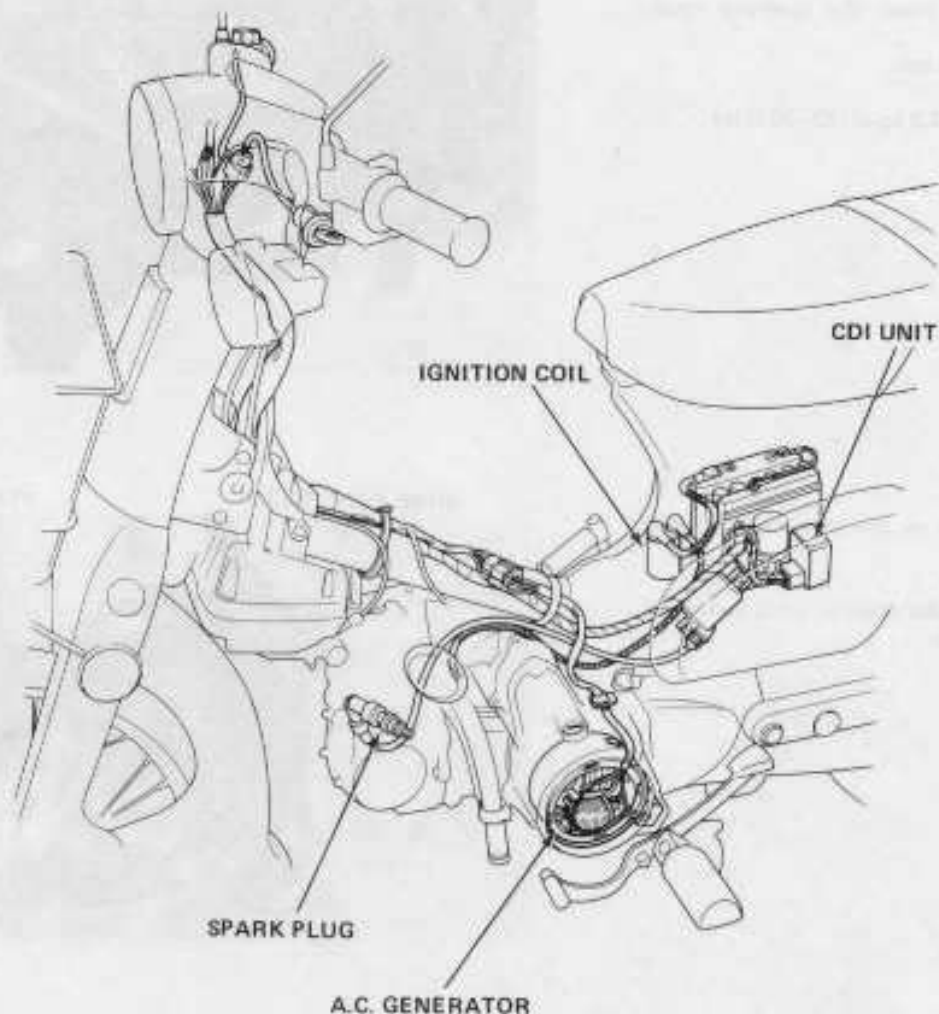



SPECIFICATIONS

Spark plug	Standard	U22FSR-U (ND), CR7HS (NGK)
	For cold climate below 5°C (41°F)	U20FSR-U (ND), CR6HS (NGK)
	For extended high speed riding	U24FSR-U (ND), CR8HS (NGK)
Spark plug gap		0.6–0.7 mm (0.024–0.028 in)
Ignition timing		"F" mark 15° BTDC at idle
		Full advance 30° BTDC/3,100 rpm

TROUBLESHOOTING

No Spark at Plug

1. Engine stop switch "OFF"
2. Poorly connected, broken or shorted wires
 - Between AC generator and ignition coil
 - Between CDI unit and engine stop-switch
 - Between CDI unit and ignition coil
 - Between ignition coil and plug
 - Between pulse generator and CDI unit
3. Faulty ignition coil
4. Faulty CDI unit
5. AC generator faulty
6. Faulty pulse generator

Engine Starts but Runs Poorly

1. Ignition primary circuit
 - Faulty ignition coil
 - Loose or bare wire
 - Faulty pulse generator
2. Secondary circuit
 - AC generator faulty
 - CDI unit faulty
 - Faulty pulse generator
 - Faulty spark advancer

IGNITION COIL

REMOVAL

Remove the battery.

Remove the battery box.

BATTERY BOX

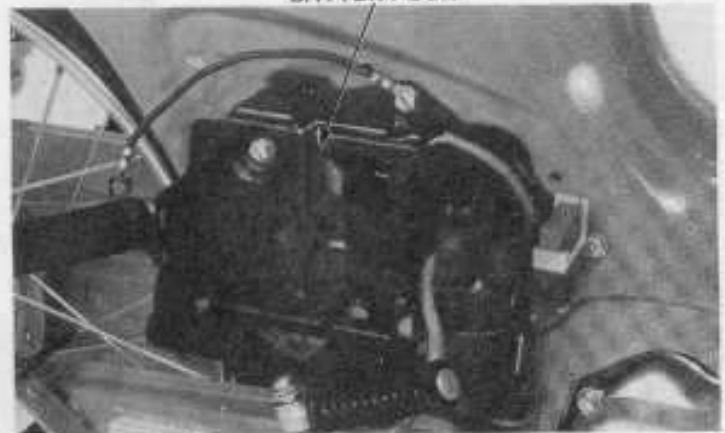

Remove the left side cover.

Remove the relay box attaching nut and bolt.

Remove the relay box.

Remove the ignition coil mounting nut and remove the ignition coil.

IGNITION COIL NUT

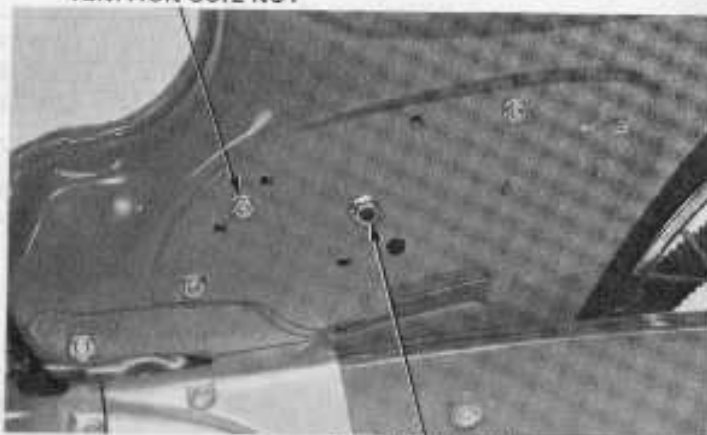

RELAY BOX NUT

INSPECTION

Measure the resistance of the primary and secondary coil.

PRIMARY: 0.2–0.3 Ohm
SECONDARY: 3.4–4.2 K ohm

Replace either coil if its resistance does not fall within the range.

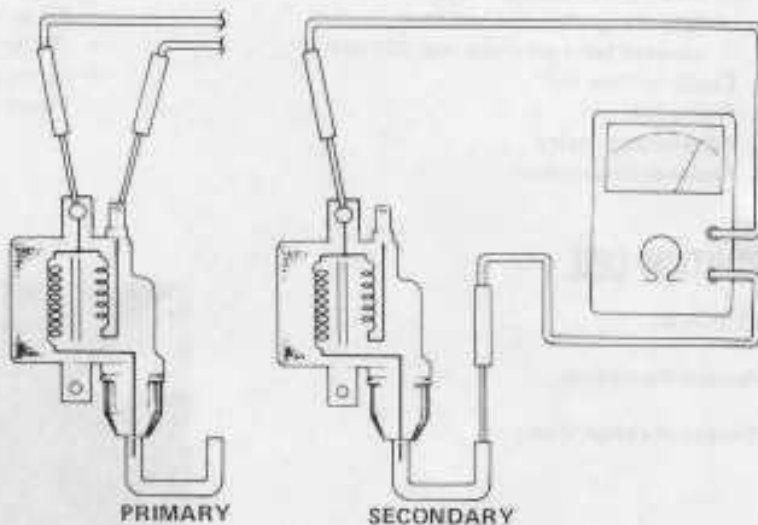

PRIMARY

SECONDARY

CDI UNIT

REMOVAL

Remove the battery and battery box.

Remove the CDI unit.

CDI UNIT

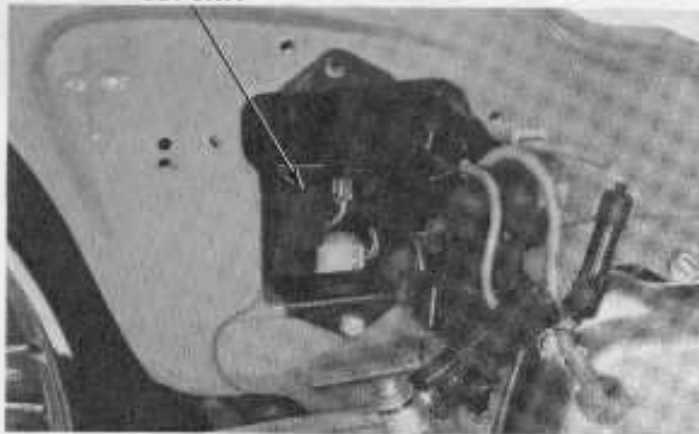



INSPECTION

Check the continuity of the CDI unit terminals.

Replace the CDI unit if the readings are not within the limits shown in the table.

NOTES:

- The CDI unit is fully transistorized.
- For accurate testing, it is necessary to use a specified electric tester. Use of an improper tester may give false readings.
- Use a SANWA ELECTRIC TESTER (P/N 07308-0020000) or KOWA ELECTRIC TESTER (TH-5H).

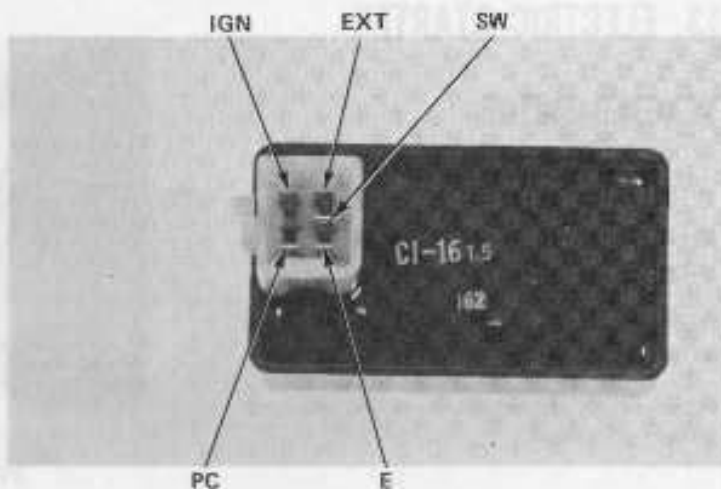

+ Probe - Probe	SW	EXT	PC	E	IGN
SW		∞	∞	∞	∞
EXT	0.1-20		∞	∞	∞
PC	40-100	20-800		10-500	∞
E	1-50	0.1-20	30-500		∞
IGN	∞	∞	∞	∞	

Range:
 SANWA: x K ohms
 KOWA: x 100 Ohms

EXCITER COIL/PULSE GENERATOR

INSPECTION

Remove the front cover.

Disconnect the A.C. generator wire coupler.

Measure the exciter coil resistance between the black/red wire terminal and the ground.

EXCITER COIL RESISTANCE:
150-700 Ohm

Measure the pulse generator coil resistance between the blue/white and the green wire terminals.

PULSE GENERATOR RESISTANCE:
50-170 Ohm

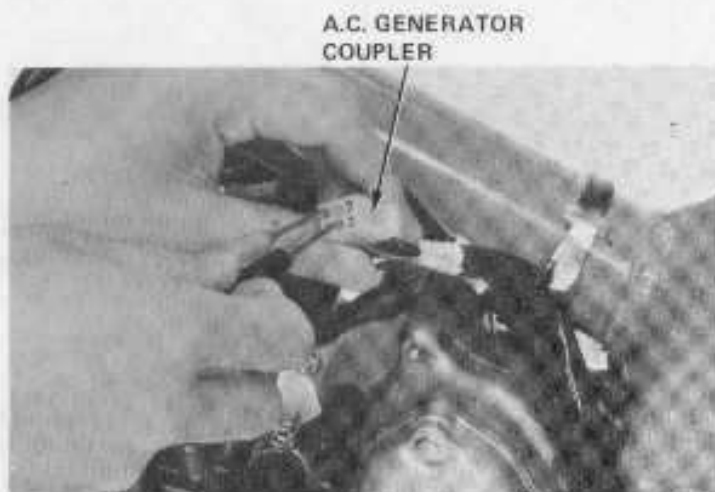



13. ELECTRIC STARTER

STARTER MOTOR

REMOVAL

Remove the starter drive sprocket snap ring (page 16-2).

Disconnect the starter cable at the motor terminal.

Remove the starter motor mounting bolts and remove the motor.





14. TECHNICAL FEATURES

The automatic chain tensioner consists of a push rod, a one-way valve and a tensioner spring. The push rod position is maintained by a constant amount of cam chain-splashed oil in the oil chamber. The amount of oil present is determined by a combined action of the valve and the tensioner spring.

When the tensioner spring pushes the rod up to remove chain slack, the one-way valve opens and allows oil collected in the rod to flow into the oil chamber.

When excess tension starts to move the push rod down, pressure from the oil in the chamber forces the valve closed so the position of the rod is maintained.

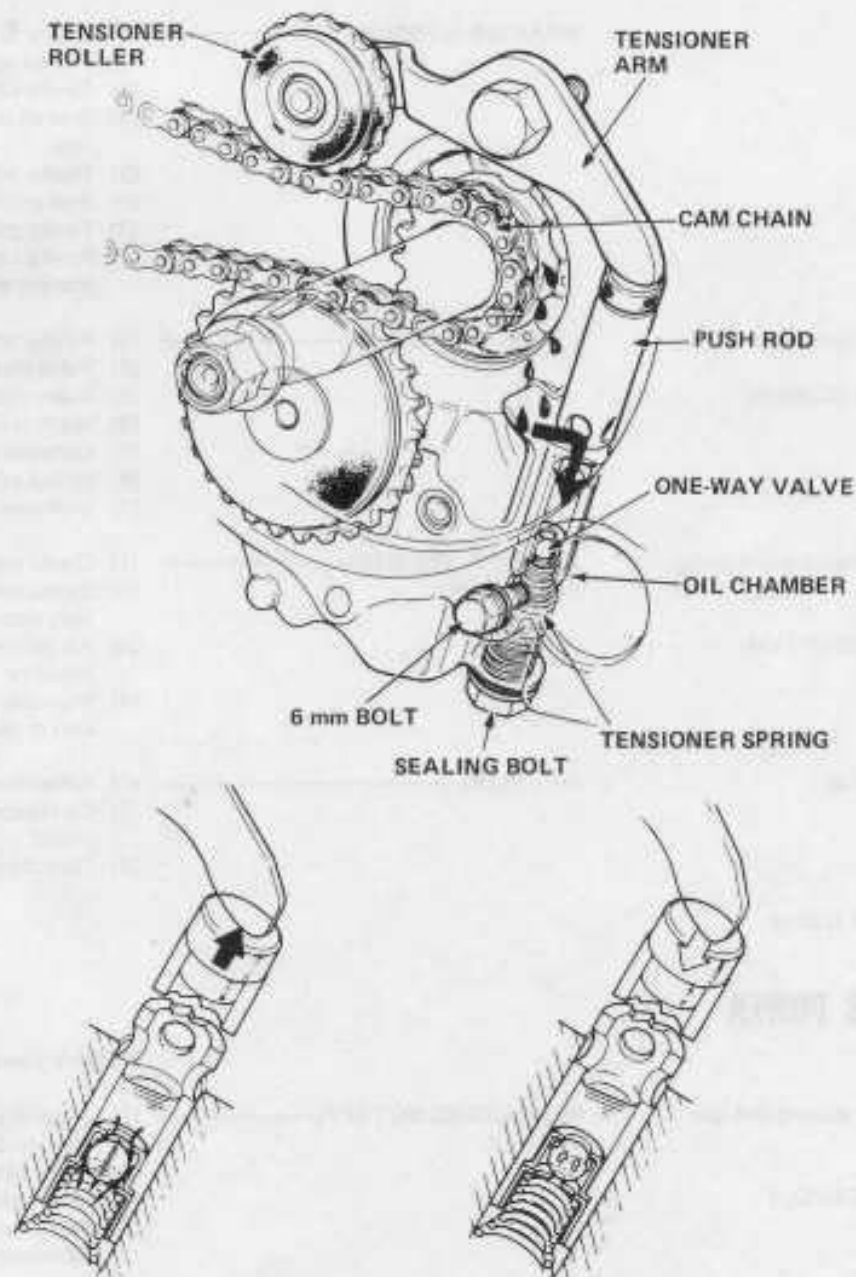

15. TROUBLESHOOTING

ENGINE DOES NOT START OR IS HARD TO START

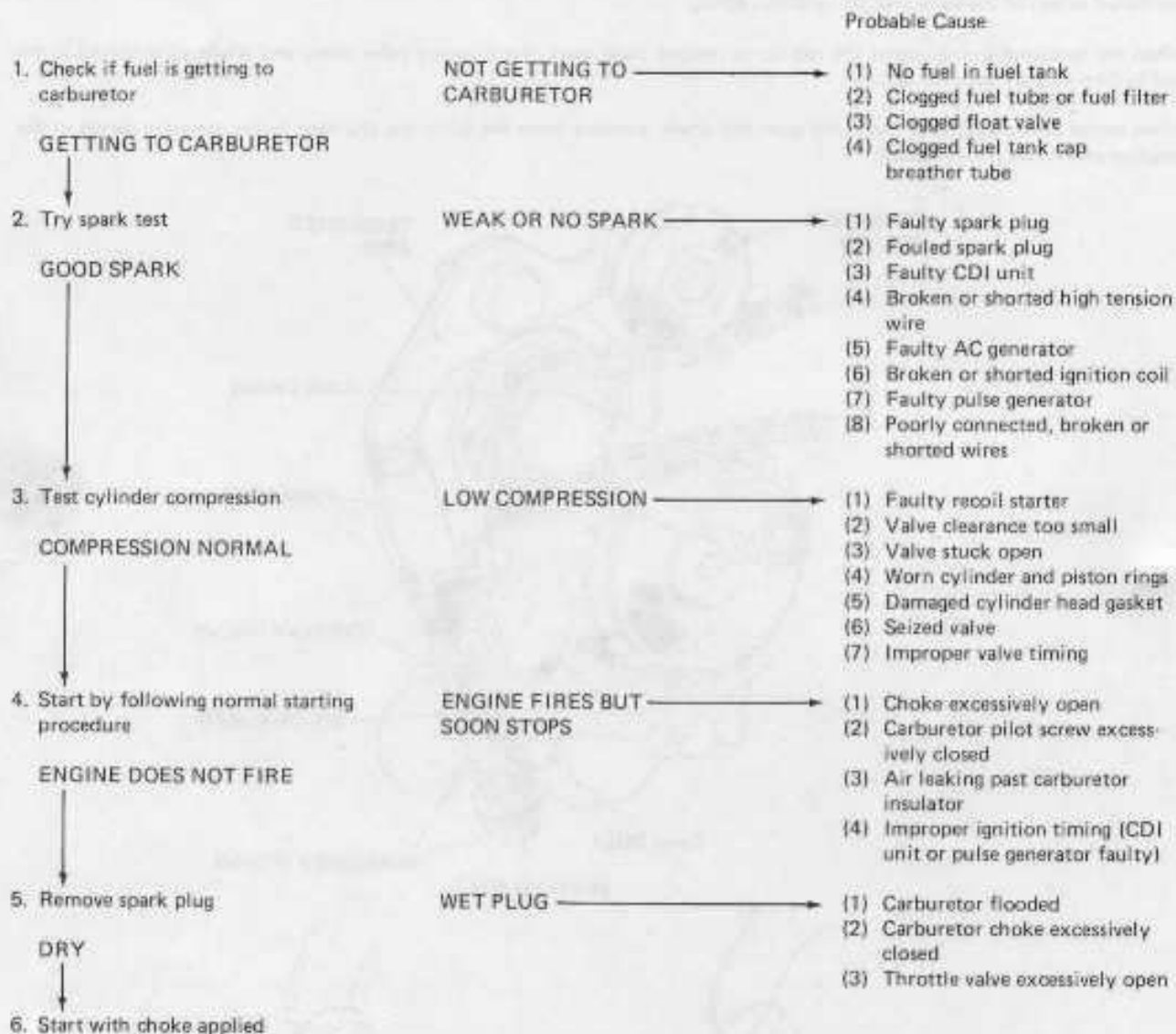

ENGINE LACKS POWER





2. Check tire pressure with tire gauge

PRESSURE NORMAL

3. Try rapid acceleration from low to second

ENGINE SPEED LOWERED WHEN CLUTCH IS RELEASED

4. Lightly accelerate engine

ENGINE SPEED INCREASED

5. Check ignition timing

CORRECT

6. Check valve clearance

CORRECT

7. Test cylinder compression using a compression gauge

NORMAL

8. Check carburetor for clogging

NOT CLOGGED

9. Remove spark plug

NOT FOULED OR DISCOLORED

10. Remove oil level gauge and check oil level

CORRECT

11. Remove cylinder head cover and inspect lubrication

VALVE TRAIN LUBRICATED PROPERLY

12. Check if engine overheats

NOT OVERHEATED

PRESSURE TOO LOW

- (1) Punctured tire
- (2) Faulty tire valve

ENGINE SPEED DOES NOT CHANGE WHEN CLUTCH IS RELEASED

- (1) Clutch slipping
- (2) Worn clutch disc/plate
- (3) Warped clutch disc/plate

ENGINE SPEED NOT INCREASED SUFFICIENTLY

- (1) Carburetor choke closed
- (2) Clogged air cleaner
- (3) Restricted fuel flow
- (4) Clogged fuel tank breather tube
- (5) Clogged muffler

INCORRECT

- (1) Faulty CDI unit
- (2) Faulty pulse generator
- (3) Faulty ignition advancer

INCORRECT

- (1) Improper valve adjustment
- (2) Worn valve seat

TOO LOW

- (1) Valve stuck open
- (2) Worn cylinder and piston rings
- (3) Leaking head gasket
- (4) Improper valve timing

CLOGGED

- (1) Carburetor not serviced frequently enough

FOULED OR DISCOLORED

- (1) Plug not serviced frequently enough
- (2) Use of plug with improper heat range

OIL LEVEL INCORRECT

- (1) Oil level too high
- (2) Oil level too low
- (3) Contaminated oil

VALVE TRAIN NOT LUBRICATED PROPERLY

- (1) Clogged oil passage
- (2) Clogged oil control orifice

OVERHEATED

- (1) Excessive carbon build-up in combustion chamber
- (2) Use of improper quality of fuel
- (3) Clutch slipping
- (4) Fuel-air mixture too lean

13. Accelerate or run at high speed
ENGINE DOES NOT KNOCK

ENGINE KNOCKS →

- (1) Worn piston and cylinder
- (2) Fuel-air mixture too lean
- (3) Use of improper grade of fuel
- (4) Excessive carbon build-up in combustion chamber
- (5) Ignition timing too advanced (Faulty CDI unit or advancer)

POOR PERFORMANCE AT LOW AND IDLE SPEED

1. Check ignition timing and valve clearance

CORRECT ↓

2. Check carburetor pilot screw adjustment

CORRECT ↓

3. Check if air is leaking past carburetor insulator

NOT LEAKING ↓

4. Try spark test

GOOD SPARK

INCORRECT →

INCORRECT →

LEAKING →

WEAK OR INTERMITTENT SPARK →

Probable Cause

- (1) Improper valve clearance
- (2) Improper ignition timing (Faulty CDI unit or spark advancer)

- (1) Fuel-air mixture too lean
- (2) Fuel-air mixture too rich

- (1) Deteriorated insulator O-ring
- (2) Loose carburetor

- (1) Faulty, carbon or wet fouled spark plug
- (2) Faulty CDI unit
- (3) AC generator faulty
- (4) Faulty ignition coil
- (5) Faulty pulse advancer

POOR PERFORMANCE AT HIGH SPEEDS

1. Check ignition timing and valve clearance

CORRECT ↓

2. Disconnect fuel tube at carburetor

FUEL FLOWS FREELY ↓

3. Remove carburetor and check for clogged jet

NOT CLOGGED ↓

4. Check valve timing

CORRECT ↓

5. Check valve spring tension

NOT WEAKENED

INCORRECT →

FUEL FLOW RESTRICTED →

CLOGGED →

INCORRECT →

WEAK →

Probable Cause

- (1) Improper valve clearance
- (2) Faulty CDI unit
- (3) Faulty pulse generator
- (4) Faulty advancer

- (1) Lack of fuel in tank
- (2) Clogged fuel line
- (3) Clogged fuel tank breather tube
- (4) Clogged fuel valve

- (1) Clean

- (1) Cam sprocket not installed properly

- (1) Faulty spring



16. WIRING DIAGRAM

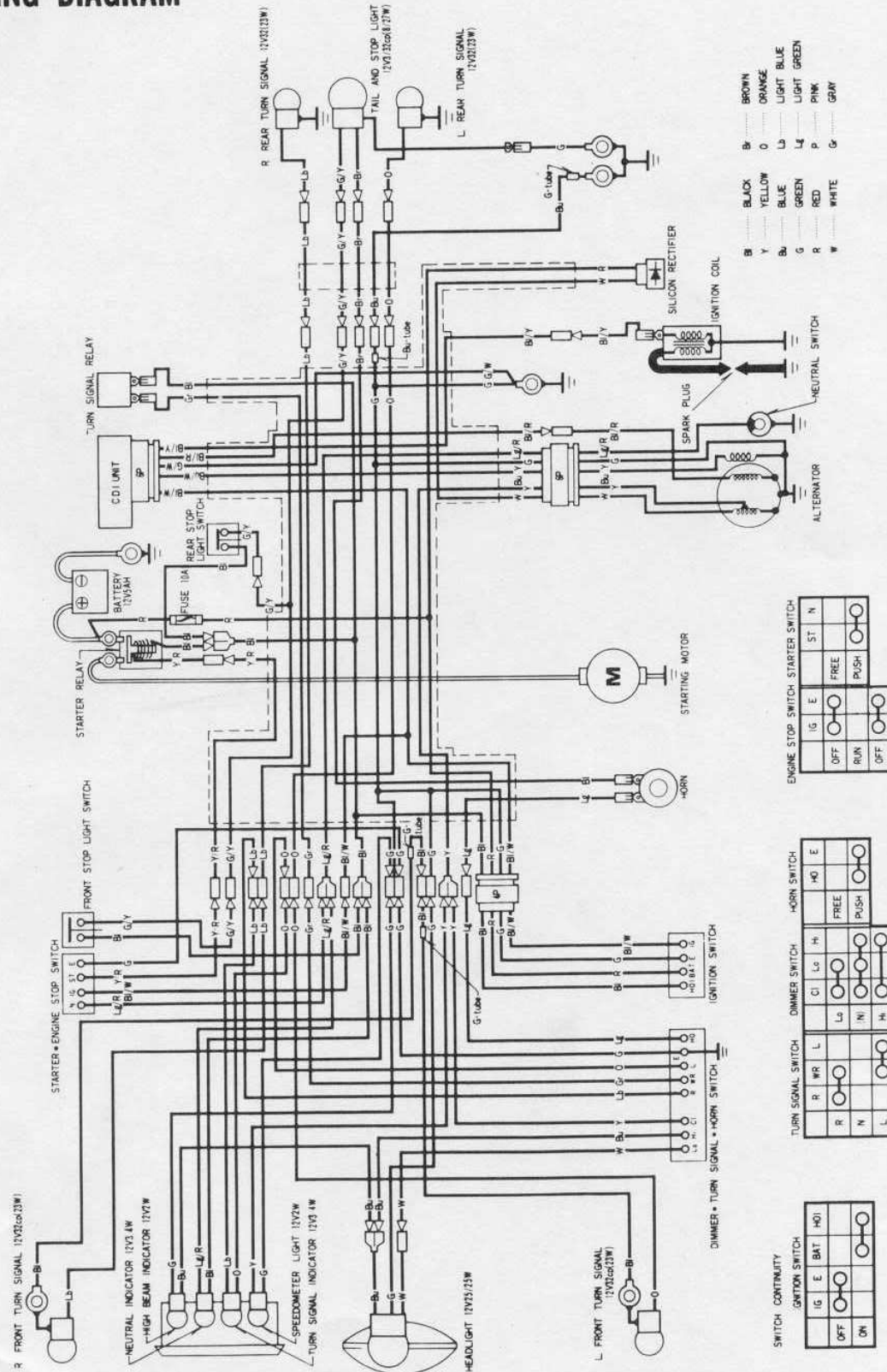

0030Z-GB5-6700

