

# SHOP MANUAL

**HONDA**

**100 · 125**

MODEL CB100.CL100.SL100  
CB125S.CD125S.SL125

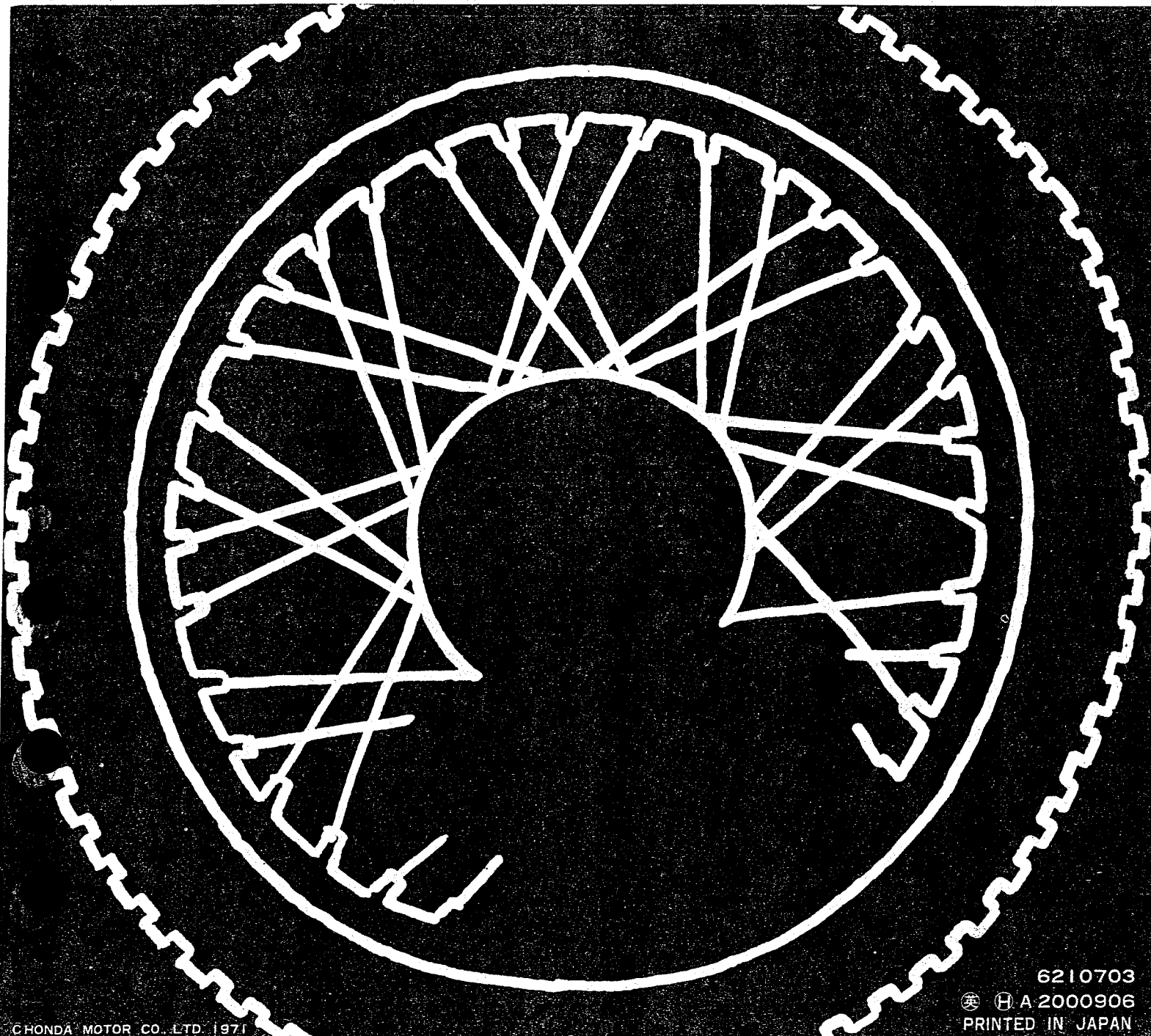

---

## FOREWORD

This Shop Manual is published as a guide to servicing the Honda 100•125. It provides the service technician with complete and proper servicing information. Further, the sales personnel will also gain the technical knowledge which is very beneficial in his work.

The manual is separated into five sections with the respective sections being further divided into disassembly, adjustment, and repair.

By closely following the instructions, the proper servicing can be performed with greater efficiency.

The information in this manual was in effect at the time of publication.

The information peculiar to TL125 is compiled at the back of this publication as a supplement.

# CONTENTS

<b>I. PROCEDURE OF PERFORMING THE WORK</b> .....	<b>1</b>
<b>SPECIAL TOOLS</b> .....	2
<b>II. MAINTENANCE OPERATIONS</b> .....	<b>5</b>
1. Tappet adjustment .....	5
2. Carburetor adjustment .....	5
3. Breaker point and ignition timing adjustment .....	6
4. Clutch adjustment .....	7
5. Spark plug inspection .....	7
6. Engine oil change .....	8
7. Oil filter cleaning .....	8
8. Cam chain adjustment .....	9
9. Fuel system inspection .....	9
10. Air cleaner element servicing .....	9
11. Brake adjustment .....	10
12. Drive chain adjustment .....	11
13. Battery electrolyte inspection .....	11
14. Front fork oil replacement .....	11
15. Cylinder compression check .....	12
<b>III. ENGINE</b> .....	<b>13</b>
1. Work which can be performed without removing the engine .....	14
2. Engine removal and installation .....	14
3. Cylinder, cylinder head and piston .....	15
4. Valve removal .....	20
5. Oil pump and oil filter .....	22
6. Clutch .....	25
7. Gear shift mechanism .....	27
8. Cam chain tensioner and A.C. generator .....	29
9. Crankshaft .....	30
10. Transmission and primary kick starter .....	32
11. Carburetor .....	35
<b>IV. CHASSIS</b> .....	<b>37</b>
1. Front brake and front wheel .....	37
2. Rear brake and rear wheel .....	40
3. Steering unit .....	43
4. Front suspension .....	45
5. Rear suspension .....	48
6. Frame body .....	50
<b>V. ELECTRICAL</b> .....	<b>53</b>
1. Generating system .....	53
2. Charging system .....	54
3. Ignition system .....	55
4. Battery .....	56
5. Auxiliary electrical equipment .....	58
<b>TROUBLE SHOOTING</b> .....	61
<b>PERIODICAL MAINTENANCE</b> .....	66
<b>TECHNICAL DATA</b> .....	67
<b>WIRING DIAGRAM</b> .....	68
<b>INDEX</b> .....	71

## SUPPLEMENT

● SERVICE TOOL .....	75	III ENGINE, CHASSIS AND	
I MAINTENANCE OPERATIONS .....	77	ELECTRICAL .....	85
1. Tappet clearance adjustment .....	77	● ENGINE .....	85
2. Carbretor adjustment .....	77	1. CLUTCH .....	85
3. Breaker point and ignition .....	77	2. TRANSMISSION .....	86
4. Oil filter cleaming .....	77	● CHASSIS .....	87
5. Engine oil change .....	78	1. Brake arm .....	87
6. Cam chain adjustment .....	78	2. Handle Bar .....	87
7. Fuel system inspection .....	78	3. Cables and read wires .....	87
8. Air cleaner maintenance .....	78	4. Front suspension .....	88
9. Clutch wire adjustment .....	79	A. Disassmbly notes .....	88
10. Drive chain adjustment .....	79	B. Inspection .....	89
11. Front Brake adjustment .....	80	C. Assembly .....	89
12. Rear Breke adjustment .....	80	● ELECTRICAL SYSTEM .....	90
13. Brake pedal height adjustment .....	81	1. A.C Generator .....	91
14. Gear change pedal height adjustment .....	81	A. Removal .....	92
15. Front suspension spring adjustment .....	81	B. Stator Inspection .....	92
16. Front fork oil change .....	81	● INSPECTION OF ELECTRICAL	
17. Cylinder compression inspection .....	82	ACCESSORIES .....	92
II ENGINE .....	83	TABLE OF OPTIONAL PARTS .....	93
1. IN-mortorcycle .....	83	SPECIFICATIONS .....	94
2. Engine removal and installation .....	83	MAINTENANCE SCHEDULE .....	95
A. Engine Romoval .....	83	TL125 WIRING DIAGRAM .....	96
B. Engine Installation Notes .....	84		

## I. PROCEDURE OF PERFORMING THE WORK

1. When performing an overhaul, all the parts which have been disassembled should be separated in their respective groups so that they will not become mixed.
2. All packings, gaskets and cotter pins which have been removed should be replaced with new items when reassembling. Any snap rings which are deformed should also be replaced.
3. All engine parts should be cleaned after disassembly. Metal surfaces which are subject to friction must be coated with oil.
4. The work should be performed with special tools for better results.
5. All nuts and bolts are normally torqued starting from those of large diameter and from inside to outside symmetrically.
6. Refer to torque values shown in the following table.

UNIT: kg-m (ft-lb)

Engine		Frame	
Item	Torque values	Item	Torque values
Cylinder head	1.8 ~ 2.0 (11.5 ~ 14.5)	Front axle nut	4.0 ~ 5.0 (29.0 ~ 36.0)
Spark advance	0.8 ~ 1.2 ( 5.8 ~ 8.7)	Rear axle nut	4.0 ~ 5.0 (29.0 ~ 36.0)
Cam sprocket	0.8 ~ 1.2 ( 5.8 ~ 8.7)	Rear fork pivot bolt	3.0 ~ 4.0 (21.7 ~ 29.0)
Cylinder mount bolt, 6 mm	1.2 ~ 1.8 ( 8.7 ~ 13.0)	Engine mounting bolt	2.0 ~ 2.5 (14.5 ~ 18.8)
Left crank case cover	0.8 ~ 1.2 ( 5.8 ~ 8.7)	Handle mounting bolt	0.9 ~ 1.1 (6.50 ~ 7.95)
A.C rotor	2.6 ~ 3.2 (18.8 ~ 23.2)	Steering stem nut	6.0 ~ 8.0 (43.3 ~ 57.8)
A.C generator mounting screw	0.8 ~ 1.2 ( 5.8 ~ 8.7)	Front cushion mounting bolt	4.0 ~ 5.0 (29.0 ~ 36.0)
Cam chain tensioner arm	0.8 ~ 1.2 ( 5.8 ~ 8.7)	Rear cushion mounting nut	3.0 ~ 4.0 (21.7 ~ 29.0)
Right crank case cover screw	0.8 ~ 1.2 ( 5.8 ~ 8.7)	Torque link mounting bolt	2.0 ~ 2.5 (14.5 ~ 18.0)
Oil filter cover screw	0.8 ~ 0.4 ( 2.2 ~ 2.9)	Top bridge lock nut	4.0 ~ 4.8 (29.0 ~ 34.7)
Oil filter (lock nut, 16 mm)	4.0 ~ 5.0 (29.0 ~ 36.0)	Final driven sprocket	2.0 ~ 2.5 (14.5 ~ 18.0)
Oil pump gear cover bolt	0.4 ~ 0.6 ( 2.9 ~ 4.4)	Seat mounting bolt	2.0 ~ 2.5 (14.5 ~ 18.0)
Clutch mounting bolt	0.8 ~ 1.2 ( 5.6 ~ 8.7)		
Gear shift drum stopper bolt	0.8 ~ 1.2 ( 5.6 ~ 8.7)		
Gear shift drum cam bolt	0.8 ~ 1.2 ( 5.6 ~ 8.7)		

### Standard parts

Bolt hex. 6 mm	0.8 ~ 1.2 kg/m (5.8 ~ 8.7)
Screw cross, 6 mm	0.8 ~ 1.2 kg/m (5.8 ~ 8.7)
Nut, 6 mm	0.8 ~ 1.2 kg/m (5.8 ~ 8.7)
Screw cross, 5 mm	0.3 ~ 0.4 kg/m (2.2 ~ 2.9)

## SPECIAL TOOLS



①



②



③



④



⑤

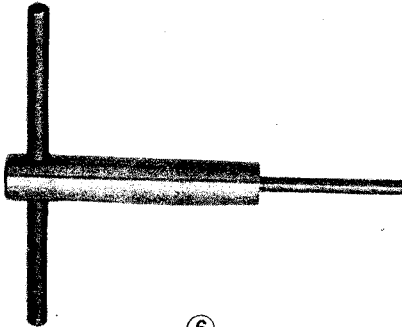

⑥



⑧



⑨

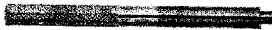

⑦

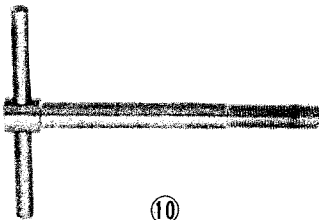

⑩

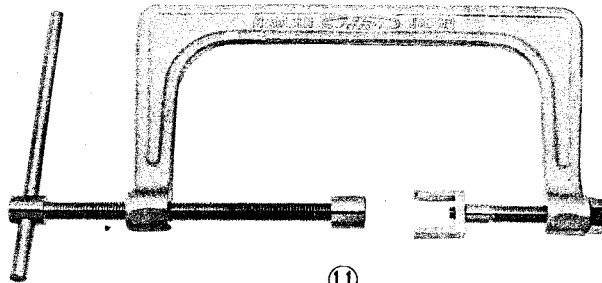

⑪

Ref. No.	Tool No.	Description
	07000-10701	Special Tool Set for CB100 and CL100
	07001-11001	Special Tool Set for SL100
1	* 07001-10701	Valve seat 90° cutter
2	* 07003-10701	Inlet valve seat top cutter
3	* 07004-10701	Exhaust valve seat top cutter
4	* 07005-10701	Inlet valve seat interior cutter
5	* 07006-10701	Exhaust valve seat interior cutter
6	07007-00101	Valve seat cutter holder 5.5mm
7	07046-21601	Valve guide driver
8	07022-20001	Drive sprocket holder
9	07072-20001	Pin spanner, 48 mm
10	07011-03001	Dynamo rotor puller
11	07031-10701	Valve spring compressor

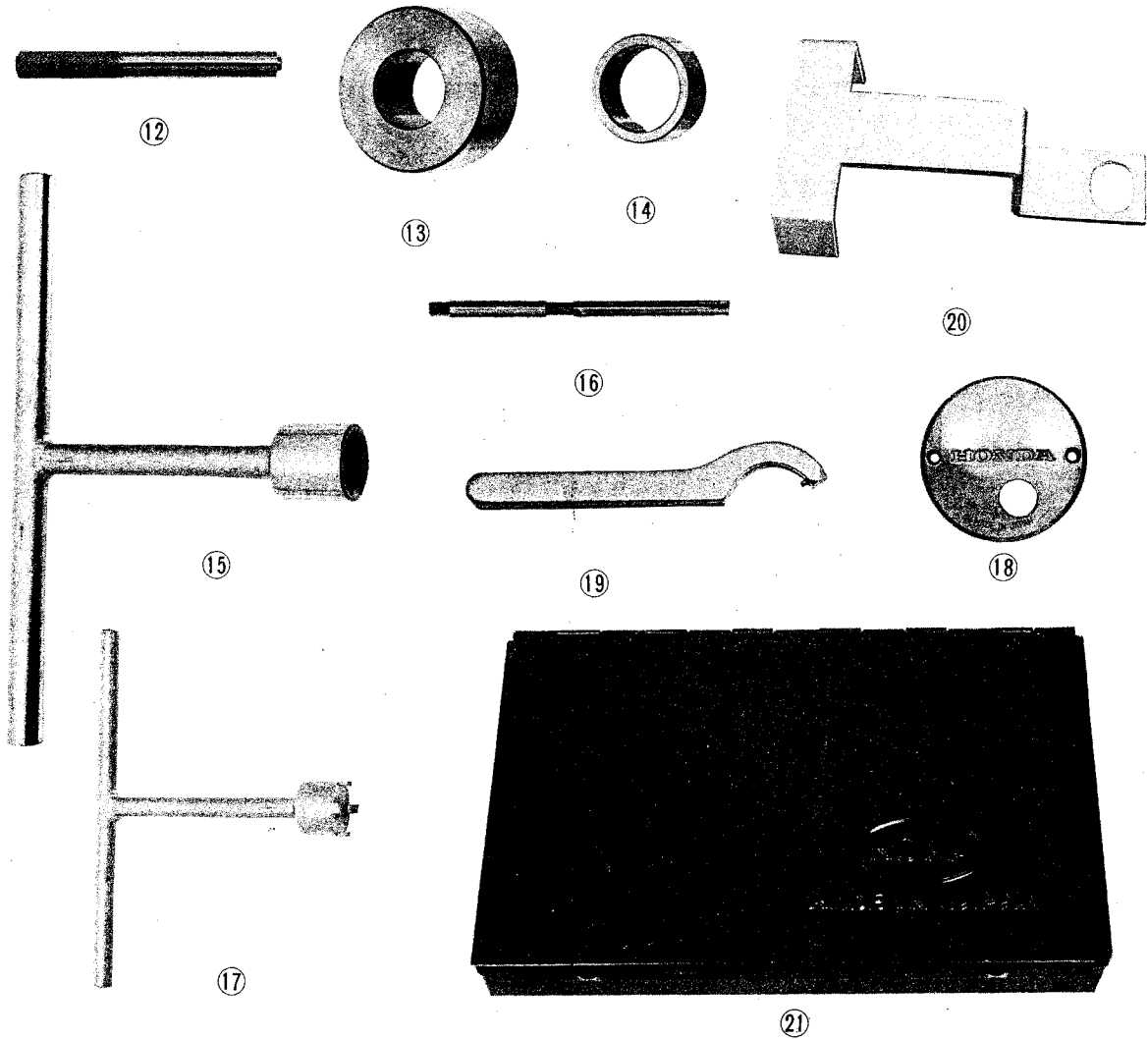

Ref. No.	Tool No.	Description
12	07047-04001	Valve guide remover
13	07054-02802	Front fork oil seal driving weight
14	* 07054-02803	Front fork oil seal driving guide (CB100, CL100)
15	07083-21601	Stem nut box wrench, 29 mm
16	07008-24001	Valve guide reamer
17	07086-28301	T-handle box wrench, 16 mm
18	* 07061-10701	Timing inspection cover
19	07071-25001	Main switch spanner
20	* 07024-10701	Clutch outer holder
21	07997-05101	Valve seat cutter case
	07790-29201	Tool case

\* These tools are newly made for use, the others are common to all series.

**SPECIAL TOOLS FOR CB125S, CD125S AND SL125**

<b>Tool No.</b>	<b>Description</b>
07000-32401	Special Tool Set for CB125S, CD125S and SL125
07001-32401	Valve seat 90° cutter
07003-32401	Inlet valve seat top cutter
07004-32401	Exhaust valve seat top cutter
07005-32401	Inlet valve seat interior cutter
07006-32401	Exhaust valve seat interior cutter

These tools described above are newly made for use, the others are common to 100 series.



## II. MAINTENANCE OPERATIONS

5

### 1. TAPPET ADJUSTMENT

The inspection and adjustment must be performed while the engine is cold.

- 1) Unscrew the two 8mm seat mounting bolts and remove the seat.
- 2) Remove the fuel tank.
- 3) Unscrew and remove the tappet hole caps.
- 4) Remove the dynamo cover.
- 5) Turn the crankshaft so that the "T" (timing) mark aligns with index mark on the stator and the piston is in the compression stroke. The piston in the compression stroke can be determined by feeling rocker arms for clearance. (Fig. 1)
- 6) Check tappet clearances with a thickness gauge and if it is necessary to adjust, loosen the lock nut and adjust the tappet adjust screw. (Fig. 2)

Tappet clearances: Intake 0.05mm (0.002 in.)  
Exhaust 0.05mm (0.002 in.)

When tightening the lock nut, exercise care so that the tappet clearance will not be disturbed. Recheck the tappet clearance.

### 2. CARBURETOR ADJUSTMENT

Warm up the engine before setting the engine idle speed and make the idle adjustment with the pilot air screw and throttle stop screw. (Fig. 3)

- 1) Adjust the throttle stop screw to give idle speed of 1,200 rpm. Use a tachometer when it is available.
- 2) Turn the pilot air screw in and out to locate the position where engine rpm is highest. Turning the screw in will provide a rich fuel mixture, turning the screw out will give a lean fuel mixture.
- 3) If engine rpm has increased by the adjustment of air screw, the engine rpm should be set to the proper idle speed by using the throttle stop screw.
- 4) Turn the pilot air screw in or out within the range of 1/8 to 1/4 turn to obtain the optimum idling condition.

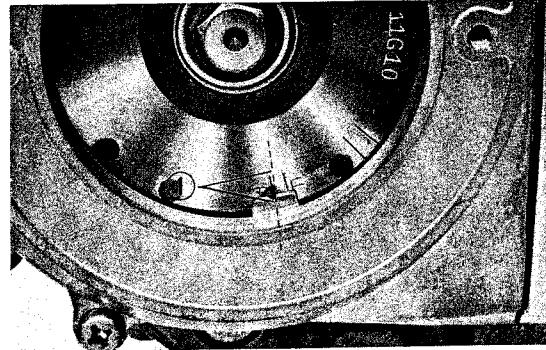

Fig. 1 ① "T" aligning mark

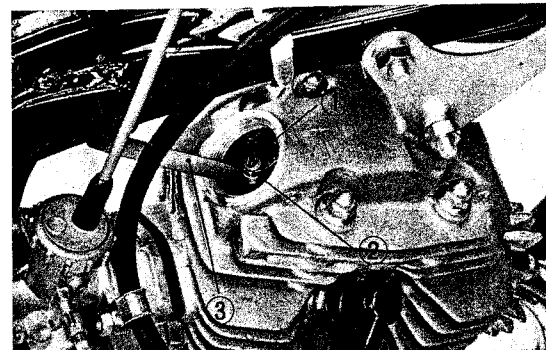

Fig. 2 Tappet adjustment  
① Lock nut ② Tappet adjust screw ③ Thickness gauge

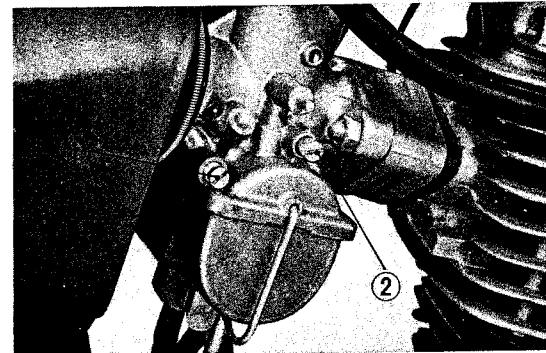

Fig. 3 Idling adjustment  
① Air screw ② Throttle stop screw

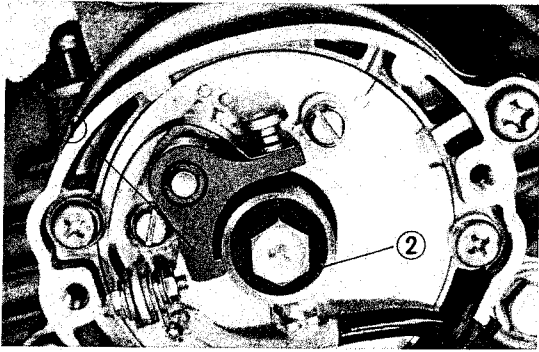

Fig. 4 ① Breaker arm slipper ② Cam

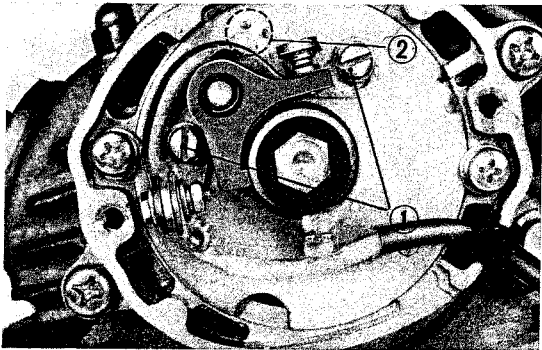

Fig. 5 ① Breaker arm retaining screws ② Adjusting position

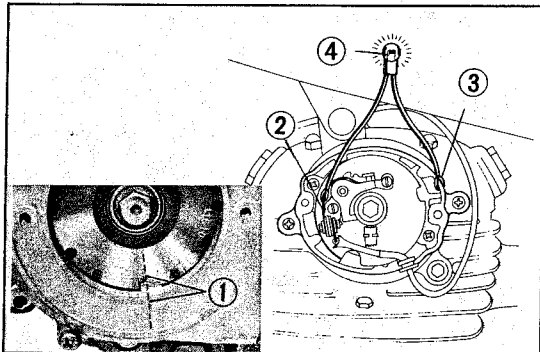

Fig. 6 ① "F" aligning mark ② Breaker arm spring  
③ Ground to earth ④ Bulb

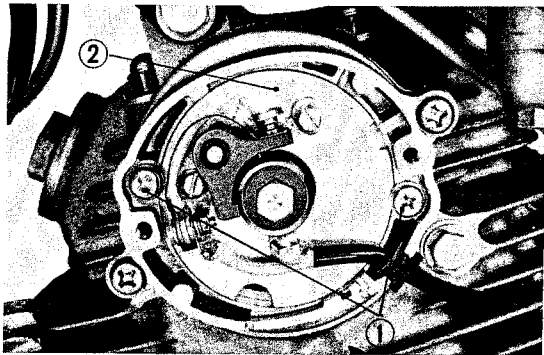

Fig. 7 ① Base plate mounting screw ② Base plate

### 3. BREAKER POINT AND IGNITION TIMING ADJUSTMENT

Adjust breaker point gap, before performing the ignition timing adjustment.

#### A. Breaker point gap

- 1) Remove the point and dynamo covers. Turn the crankshaft with the pin spanner provided as a service tool until the breaker arm slipper is on the highest point of cam lobe. (Fig. 4)
- 2) Measure point gap using a thickness gauge. The gap should be 0.3–0.4 mm (0.012–0.016 in.).
- 3) If it is necessary to make adjustment, loosen the breaker arm retaining screws, insert a screwdriver in the adjusting screw slot, and pry to adjust to the above value. Retighten the screw securely after setting is made. (Fig. 5)
- 4) Check the ignition. When the point contact surfaces are pitted or dirty, grind contacts with a point file or oil stone to remove transfer or contamination. If the metal build-up on the point is greater than 0.5 mm (0.02 in.), it should be replaced.

#### B. Ignition timing adjustment

- 1) Disconnect the contact breaker cord (green cord) at the connector and connect a 12V–3W lamp across the line. (Fig. 6)
- 2) Set the combination switch to "ON" position.
- 3) Turn the rotor slowly until the lamp goes out and check the position of "F" mark on the rotor against the index mark on the L. crankcase. If they are in line, the ignition timing is correct. (Fig. 6)
- 4) If ignition timing is required for adjustment, loosen two base plate mounting screws and move the base plate. Turning the base plate clockwise will retard the timing and counter clockwise will advance it. Tighten the screw after adjustment is made. (Fig. 7)

#### 4. CLUTCH ADJUSTMENT

Check the clutch free play at the end of the clutch lever. The play should be 1-2 cm (2/5-3/4 in.). (Fig. 8) If it is not within this range, adjust it in accordance with the following procedure.

- 1) Loosen the clutch cable adjuster lock nut and turn the adjuster clockwise to make the cable free. Then loosen the lock nut of the clutch adjuster on the right crankcase cover. Turn the adjuster screw counter clockwise until a slight drag is felt and return it by 1/8 to 1/4 turn. Tighten the lock nut securely. (Fig. 9)
- 2) Turn the adjuster in the cable counter clockwise to adjust the lever end play. (Fig. 10)
- 3) Check for proper adjustment by starting the engine, applying clutch, and operating gear change. If the clutch does not disengage, the engine will stall or the motorcycle will tend to creep.

If the clutch does not fully engage, the clutch will slip and the motorcycle will not accelerate in response to the acceleration of engine.

#### 5. SPARK PLUG INSPECTION

Remove the spark plug with a spark plug wrench and visually check conditions of electrodes and insulator.

The standard spark plugs equipped in the original engine are D-8ES (NGK) or X24ES (Nihon denso).

- 1) If the plug is carboned up, sooty or has a hard deposit from the chemical fuel additives, it should be cleaned with a spark plug cleaner or a wire brush.
- 2) Replace the plug if its insulator is cracked or chipped.
- 3) Check the gap between the electrodes with a thickness gauge and if necessary, adjust the ground electrode by bending. The standard clearance is 0.6-0.7 mm (0.025-0.028 in.). (Fig. 11)
- 4) Check the plug gasket before installation and replace if it is damaged.

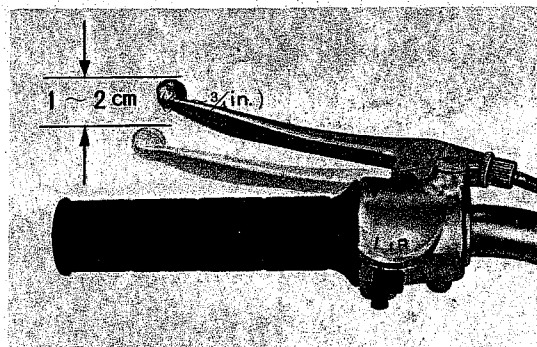

Fig. 8 Clutch lever play

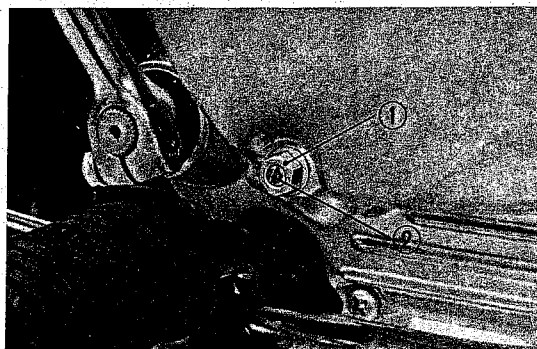

Fig. 9 Clutch adjustment  
① Lock nut ② Adjuster screw

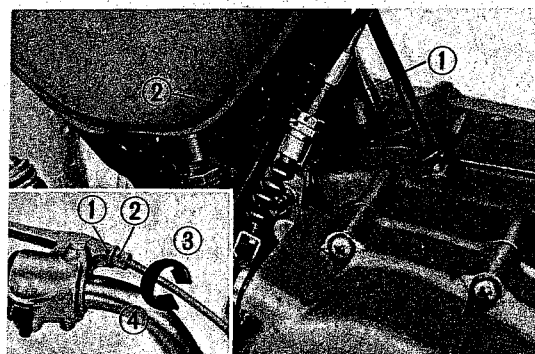

Fig. 10 ① Lock nut ② Adjuster ③ Increase ④ Decrease

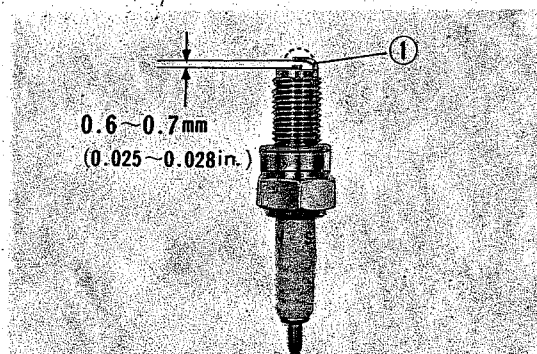

Fig. 11 ① Electrode

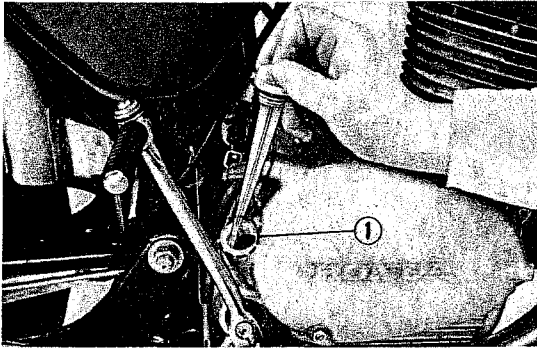

Fig. 12 ① Oil level gauge

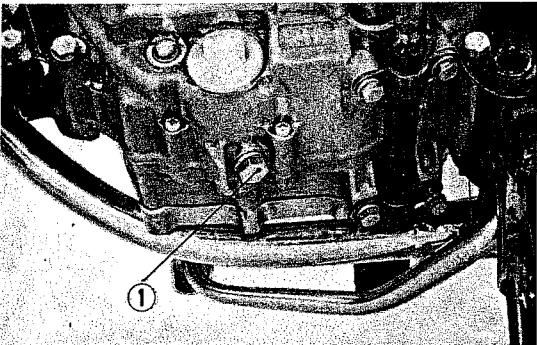

Fig. 13 ① Drain plug

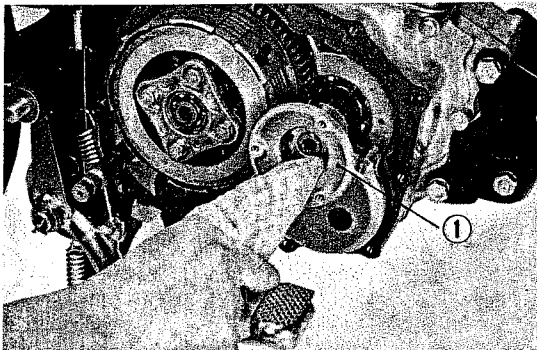

Fig. 14 ① Oil filter

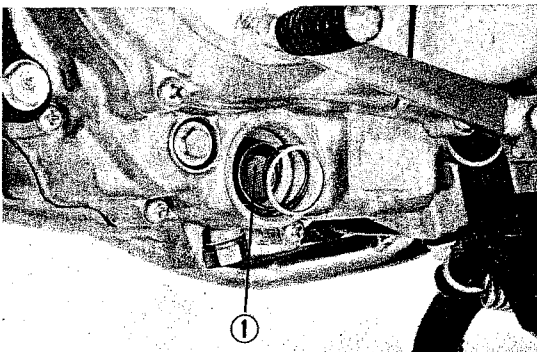

Fig. 15 ① Oil pump screen

## 6. ENGINE OIL CHANGE

The oil change is better performed while the engine is warm as this will expedite thorough draining of oil.

- 1) Remove the oil cap and remove the drain plug to drain oil. (Fig. 13)
- 2) When the oil is thoroughly drained, replace the drain plug.

Fill with a brand name oil SAE 10W-30, in the quantity of 1 lit. (1.05 qt.). Check the level by placing the dip stick in its hole, but not screwing it in. In this position, the level should be within the upper and lower marks. (Fig. 12)

## 7. OIL FILTER CLEANING

- 1) Remove the muffler.
- 2) Remove the step bar.
- 3) Remove the right crankcase cover.
- 4) Remove the centrifugal oil filter cap and clean inside. (Fig. 14)

### Oil Pump Screen Cleaning

Whenever the right crankcase cover is removed, check the oil pump screen to see if dirt is trapped. If it is dirty, remove the screen by taking off the cap. Clean the screen by blowing compressed air through it. (Fig. 15)

### 8. CAM CHAIN ADJUSTMENT

Perform the adjustment with the adjuster screw. Loosen the lock nut and turn the adjuster screw counter clockwise to decrease the slack in the cam chain. The procedure for adjustment is, first loosen the screw and then tighten until it becomes heavy. Tighten the lock nut after completing the adjustment. (Fig. 16)

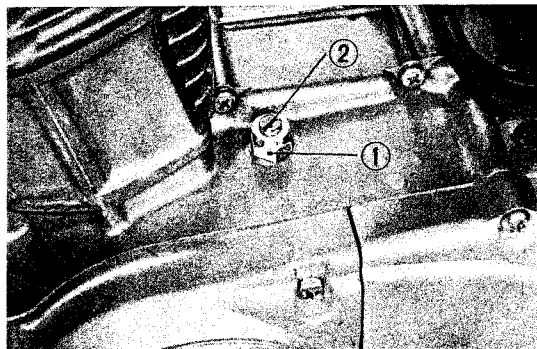

Fig. 16 ① Lock nut ② Adjuster screw

### 9. FUEL SYSTEM INSPECTION

Inspect the fuel tank, fuel cock, carburetor and fuel piping system for any fuel leaks. If fuel is spilled at any time during the replacement of fuel system component, it should be cleaned up immediately as it is a fire hazard.

### 10. AIR CLEANER ELEMENT SERVICING

- 1) Remove the right side cover.
- 2) Loosen air cleaner connecting clamp and the two mounting nuts to remove the air cleaner element. (Fig. 17)

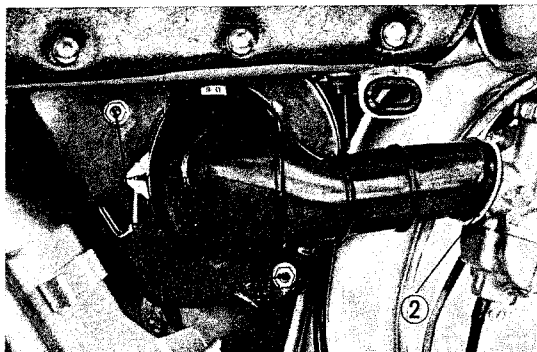

Fig. 17 ① Mounting nut ② Air cleaner connecting clamp

- 3) Wash the element in solvent and then allow to dry. Apply a small quantity of oil on the element before installation. (Fig. 18)

**Note:**

**Do not use gasoline to wash the filter element.**

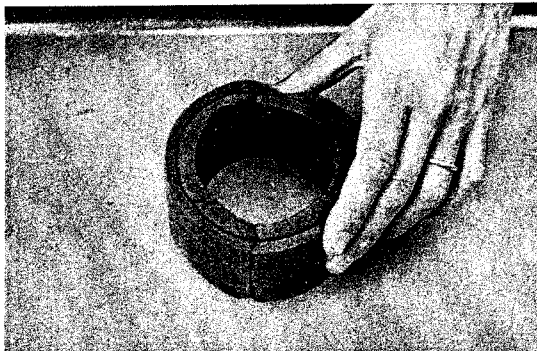

Fig. 18 ① Air cleaner element

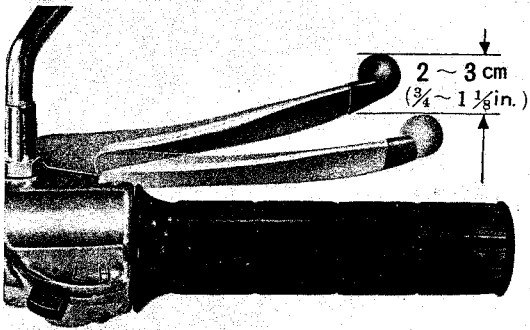

Fig. 19 Brake lever play

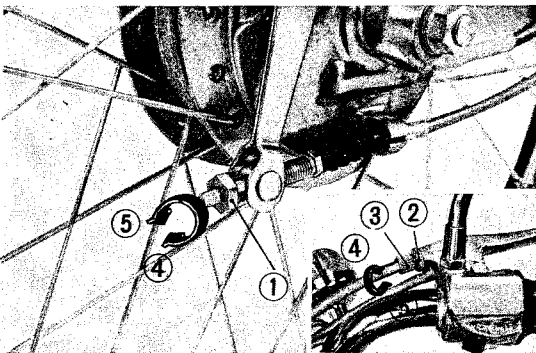

Fig. 20 ① Adjuster nut ② Lock nut ③ Adjuster nut ④ Decrease ⑤ Increase Fig. 20-A

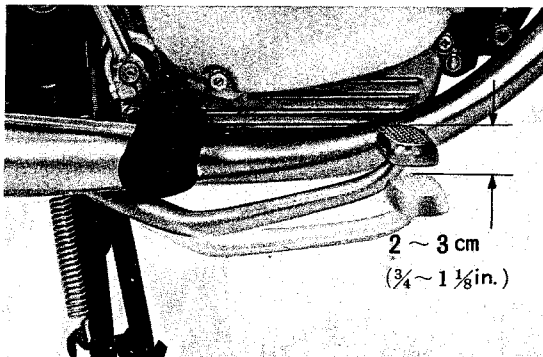

Fig. 21 Brake pedal play

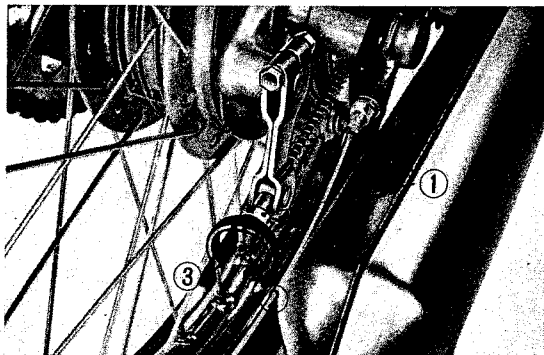

Fig. 22 ① Adjuster nut ② Decrease ③ Increase

## 11. BRAKE ADJUSTMENT

(Front wheel)

Check the brake free play at the end of the brake lever. The play should be 2-3 cm (3/4-1.1/8 in.). (Fig. 19) If it is not within this range, adjust it in accordance with the following procedure.

1) Turn the adjuster nut clockwise to reduce play in the brake lever. (Fig. 20)

2) Minor or fine adjustment can be made with adjuster nut on the clutch lever. (Fig. 20-A)

(Rear wheel)

Check the brake free play at the end of the brake pedal. The play should be 2-3 cm (3/4-1.1/8 in.). (Fig. 21) If it is not within this range, adjust it in accordance with the following procedure.

1) Turn the adjuster nut clockwise to reduce the amount of play in the brake pedal. (Fig. 21)

2) Minor or fine adjustment can be made with adjuster nut on the brake lever.

## 12. DRIVE CHAIN ADJUSTMENT

Adjust the chain slack to 1-2 cm (2/5-3/4 in.) with adjuster nuts after the axle nut is loosened. (Fig. 23)

**Note:**

Both right and left adjuster nuts should be turned equal amounts. This can be verified by the position of the adjuster indicator plate on both sides.

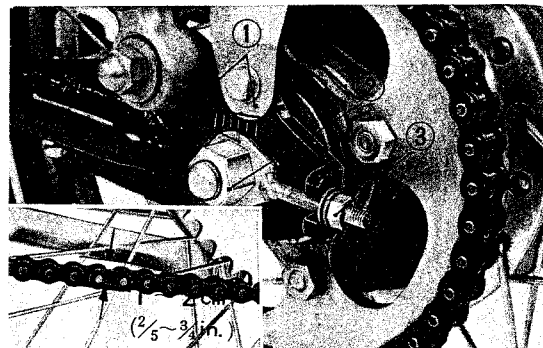

Fig. 23 ① Index mark and side scale ② Rear axle nut  
③ Adjuster nut

## 13. BATTERY ELECTROLYTE INSPECTION

Remove the left side cover and check the level of battery electrolyte to level indicator marks on battery case. (Fig. 24)

- 1) If the electrolyte level is low, remove the battery to refill it.
- 2) Add distilled water to bring electrolyte level to upper level marked on the case.

**Note:**

Over filling will cause electrolyte to overflow and result in corrosion around the battery compartment.

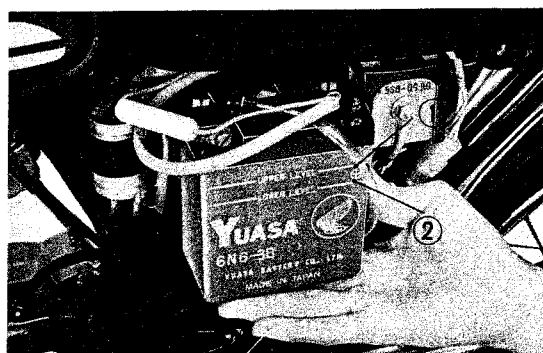

Fig. 24 ① Upper level ② Lower level

## 14. FRONT FORK OIL REPLACEMENT

- 1) Remove the fork bolts and remove the drain plug to drain oil. Actuate the fork for complete draining. (Fig. 25-26)

- 2) Flush out the interior using solvent.

**Note:**

Do not use gasoline for cleaning.

- 3) Reinstall the drain plug and tighten before refilling with new oil. (Fig. 26)

**Recommended oil: SAE 10W-40**

**Capacity:**

**CB100, CB125S 130-140cc (4.4-4.7 ozs)**

**CL100, CD125S 130-140cc (4.4-4.7 ozs)**

**SL100, SL125 180-190cc (6.1-7.2 ozs)**

- 4) Replace the fork bolt.

Torque to 4.0-5.0 kg-m (29.0-36.0 ft lbs).

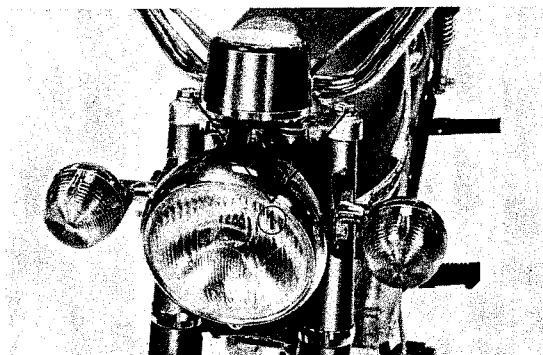

Fig. 25 ① Fork bolt

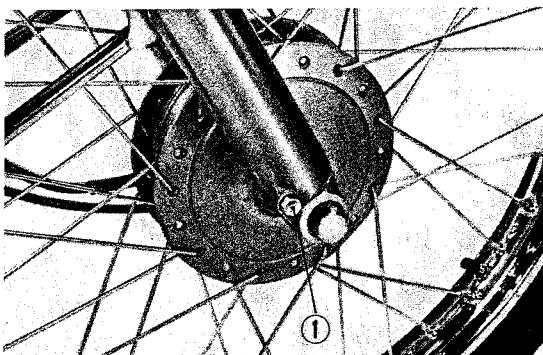

Fig. 26 ① Drain plug

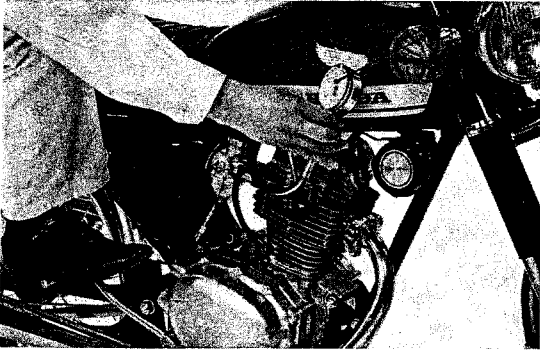

Fig. 27 ① Compression gauge

### 15. CYLINDER COMPRESSION CHECK

Low compression and pressure leak will cause unstable engine rpm and loss of power. Compression is checked with a cylinder compression gauge by the following procedure. (Fig. 27)

- 1) Remove the spark plug.
- 2) Insert the rubber tip of compression gauge into the spark plug hole and operate the kick starter while holding the throttle grip fully open.

#### Note:

Perform the check after warming up the engine.

- 3) The normal compression pressure is **12 kg/cm<sup>2</sup> (170 psi)**.

① Low compression is due to one of the following causes:

- Leaking valve.
- Defective or sticking piston rings.
- Blown cylinder head gasket.
- Improper tappet adjustment.

② Unusually high compression pressure is due to excessive carbon deposits on the combustion chamber or on the piston head.

Engine must be disassembled for complete inspection or repair in these cases.



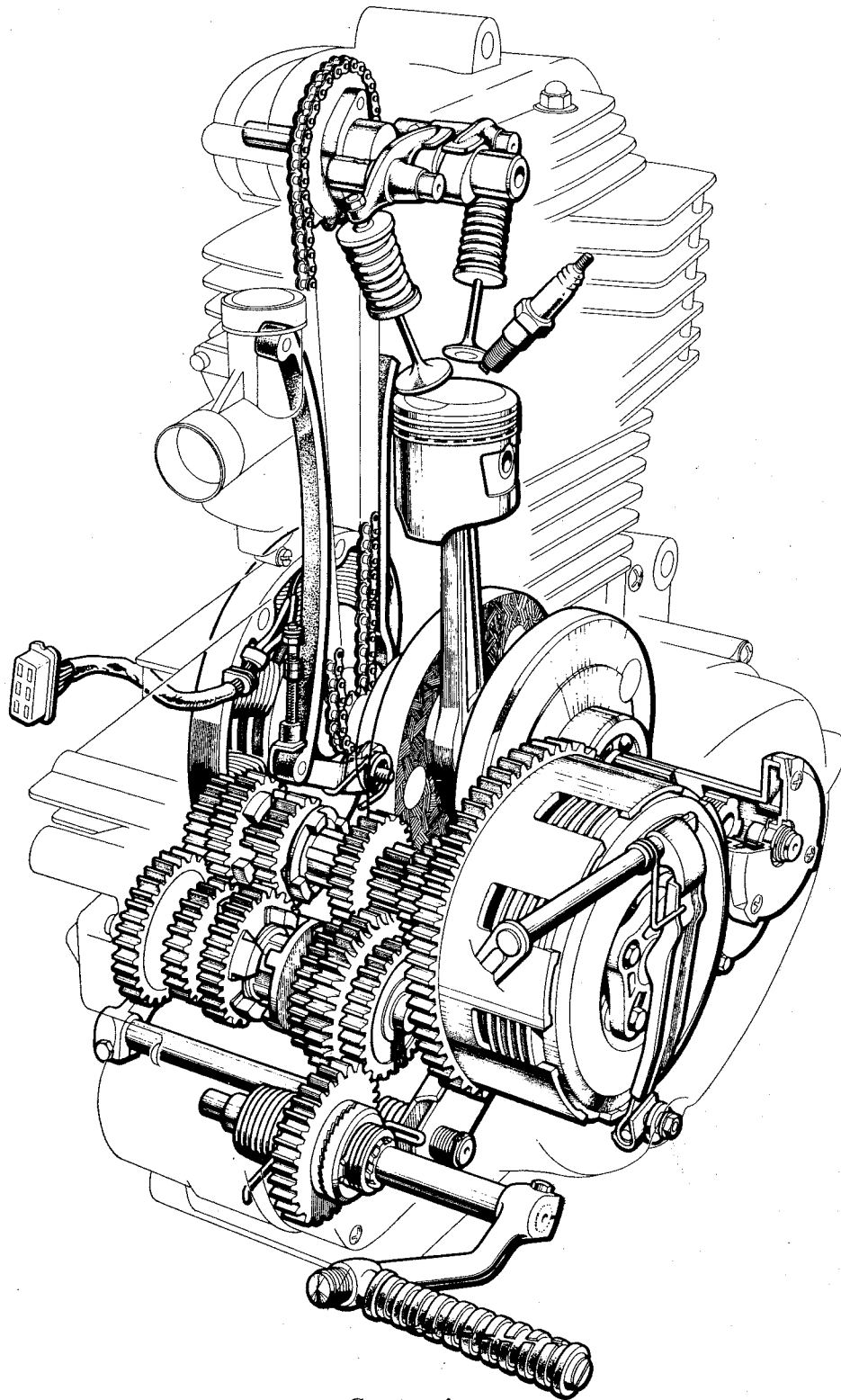

Construction

## 1. WORK WHICH CAN BE PERFORMED WITHOUT REMOVING THE ENGINE.

Work Item	Page
1) Oil pump, oil filter	22
2) Clutch	25
3) Gear shift mechanism	27

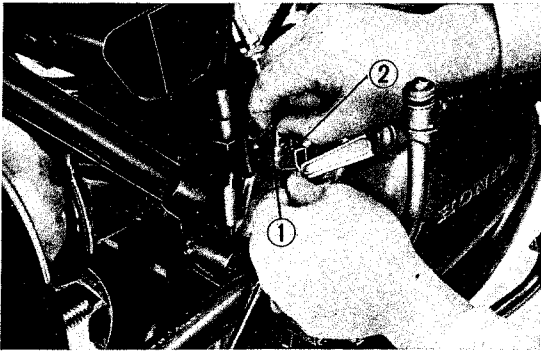

Fig. 28 ① Clutch cable ② Clutch lever

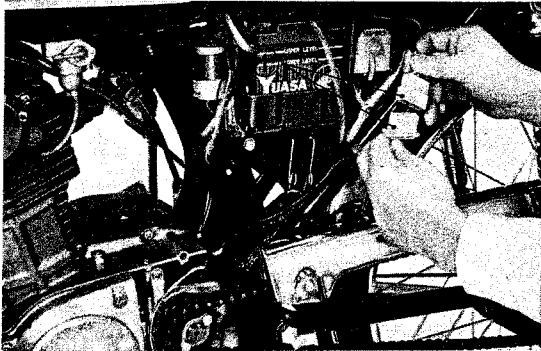

Fig. 29 ① Electrical coupler

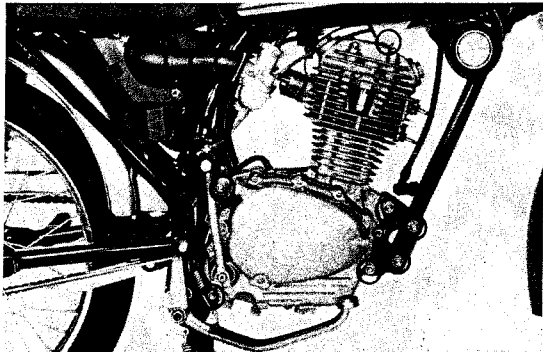

Fig. 30 ① Engine hanger bolts

## 2. ENGINE REMOVAL AND REINSTALLATION

### A. Engine Removal

- 1) Remove the exhaust pipe and muffler.
- 2) Remove four 8 mm step bar mounting bolts and remove the step bar.
- 3) Loosen the clutch cable lock nut, provide additional cable slack and then disconnect from the clutch lever. (Fig. 28)
- 4) Unscrew the two carburetor mounting bolts and separate the carburetor from the inlet pipe.
- 5) Remove the gear change pedal.
- 6) Remove the left rear crankcase cover.
- 7) Disconnect and remove the drive chain.
- 8) Disconnect the coupler from wire harness. (Fig. 29)
- 9) Remove nuts from the engine hanger bolts, raise engine toward the rear, and remove engine bolt while supporting the engine. (Fig. 30)

## B. Engine Reinstallation

- 1) Reinstall engine in the reverse order of removal.
- 2) To simplify installation, use the "T" handle screwdriver to hang the engine temporarily followed by installing the support bolt.
- 3) Temporarily install the exhaust pipe joint and muffler and then perform the final torquing.
- 4) When connecting drive chain, make sure that the chain joint clip is properly installed. (Fig. 31)

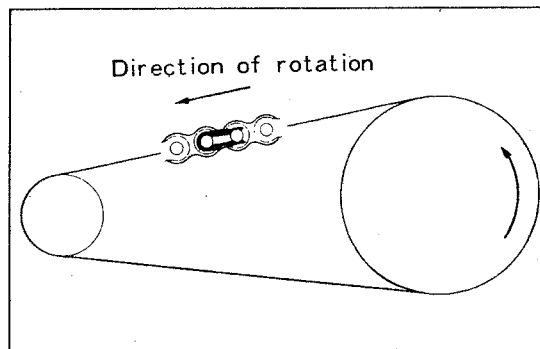

Fig. 31 Direction of rotation

## 3. CYLINDER, CYLINDER HEAD AND PISTON

### A. Disassembly

- 1) Remove two 5mm screws and disassemble the point cover.
- 2) Loosen two 5mm mounting screws and remove the contact breaker. (Fig. 32)
- 3) Loosen the 6mm mounting bolt and remove the governor. (Fig. 32)
- 4) Loosen two 6mm screws and remove the point base. (Fig. 32)
- 5) Position the piston at top-dead-center, loosen the cam sprocket mounting bolts and remove the cam sprocket from the cam chain. (Fig. 33)

Drop cam chain toward the side of the cylinder.

#### Note:

**Do not loosen the cylinder head bolts.**

- 6) Remove four 8mm cap nuts.
- 7) Align both the inlet and exhaust cams to the cutout on the cylinder head and then remove the camshaft from the cylinder. (Fig. 34)

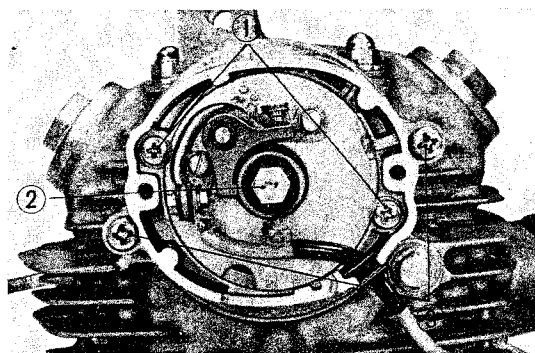

Fig. 32 ① 5mm screws ② 6mm bolt ③ 6mm screws

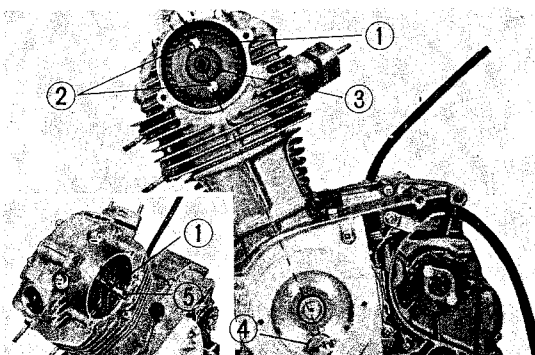

Fig. 33 ① Cam chain ② 6mm bolts ③ Cam sprocket  
④ "T" aligning mark ⑤ Cam shaft

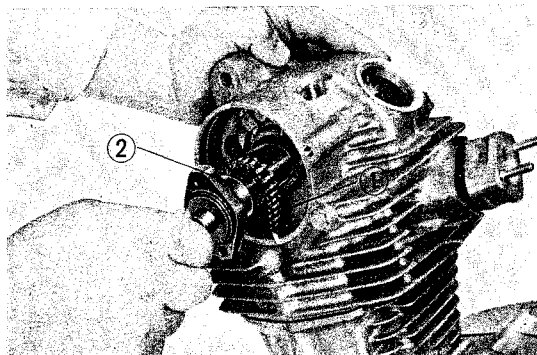

Fig. 34 Camshaft removal  
① Cam chain ② Camshaft

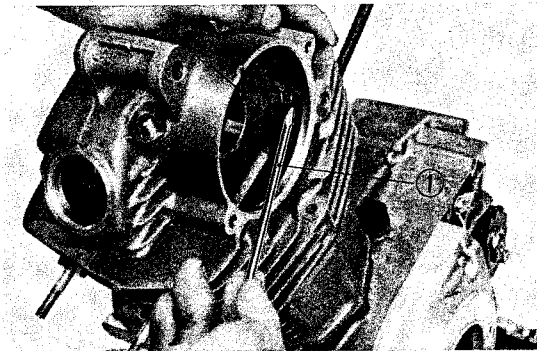

Fig. 35 ① Screwdriver ② Cam chain tensioner

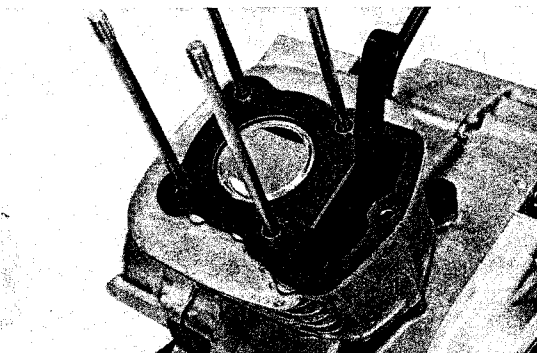

Fig. 36 Cylinder removal  
① Cylinder

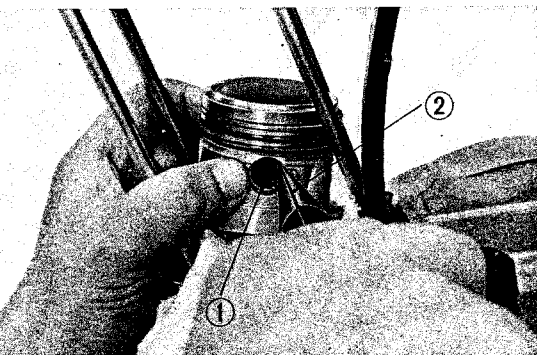

Fig. 37 Piston pin removal  
① Piston pin clip ② Long nose pliers

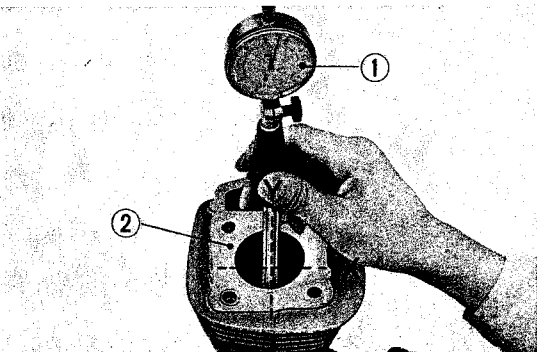

Fig. 38 Cylinder bore measurement  
① Cylinder gauge ② Cylinder

- 8) Remove the tensioner stopper bolt and then remove the cam chain tensioner from the cylinder head.
- 9) Lift off the cylinder head.

- 10) Remove the cam chain guide.
- 11) Lift and remove the cylinder. (Fig. 36)

**Note:**

If cylinder head is frozen on the cylinder or if it is difficult to remove, tap the cylinder base with a wooden hammer to loosen. Exercise care not to strike the cylinder with a hard blow as the cooling fins may be damaged.

- 12) Remove piston pin clip and piston pin, and then separate the piston from the connecting rod. (Fig. 37)

**Note:**

When removing the piston pin clip, exercise care not to drop the clip into the crankcase.

- 13) Remove the piston rings.

**B. Inspection**

- 1) Inspect the condition of the cylinder bore. Measure diameter of the cylinder bore in both the X and Y directions and at the top, center and bottom of the cylinder. (Fig. 38)

Item	Standard value	Serviceable limit	
Bore diameter	CB100 CL100 SL100	50.50-50.51mm (1.9881-1.9885 in.)	50.6mm max. (1.992 in.)
	CB125S CD125S SL125	56.00-56.01mm (2.2047-2.2051 in.)	56.1mm max. (2.2086 in.)

If the cylinder bore is less than 52.6 mm, rebore and hone the cylinder, and replace the piston with oversize piston and the standard clearance between the piston and the cylinder should be 0.01-0.05mm (0.0004-0.0020 in.) at the piston skirt. The oversize pistons are available in the oversize of 0.25, 0.50, 0.75 and 1.0mm (0.010, 0.020, 0.030 & 0.040 in.).

- 2) Piston diameter inspection  
Measure the piston at the skirt. (Fig. 39)

Item	Standard value	Serviceable limit	
Piston diameter	CB100 CL100 SL100	50.47-50.49mm (1.987-1.988 in.)	50.3mm (1.980 in.)
	CB125S CD125S SL125	55.97-55.99mm (2.2035-2.2043 in.)	55.80mm (2.1968 in.)

Replace if beyond the serviceable limit.

- 3) Measure the piston ring side clearance using a thickness gauge. Replace the piston ring or piston if beyond the serviceable limit.

Item	Standard value	Serviceable limit
Piston ring side clearance	0.025-0.030mm (0.0008-0.0011 in.)	0.7mm (0.0275 in.)

- 4) Piston ring gap

Insert the piston ring into the cylinder so that it is normal to the cylinder axis and then measure the ring gap using a thickness gauge. (Fig. 40)

Item	Standard value	Serviceable limit
Top and second rings	0.15-0.35mm (0.0059-0.0138 in.)	0.5mm max. (0.0197 in.)
Oil ring	0.15-0.04mm (0.0059-0.0158 in.)	0.5mm max. (0.0197 in.)

Replace if beyond the serviceable limit.

### C. Reassembly

- 1) Assemble the piston ring on the piston.

Note:

The ring marking located adjacent to the ring gap should be toward the top. (Fig. 41)

When installing new piston rings, roll the rings over their respective piston ring grooves to make sure that the ring side clearances are adequate. Rings should roll smoothly.

- 2) Install the piston. (Fig. 42)

Note:

Install the piston so that the IN marking on the piston head is toward the rear.

Replace all piston pin clips with new items.

- 3) Space the piston ring gaps equally apart (120°) and then install the cylinder.

Note:

Do not forget to install the two dowel pins in the mounting base.

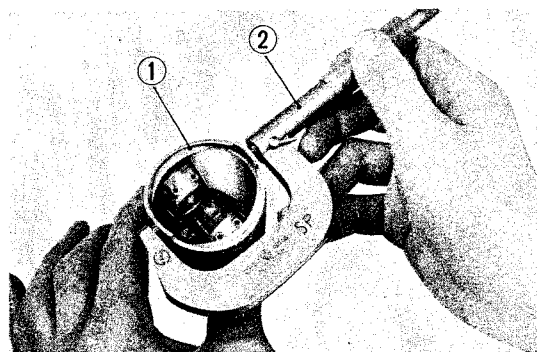

Fig. 39 Piston diameter measurement  
① Piston ② Micrometer

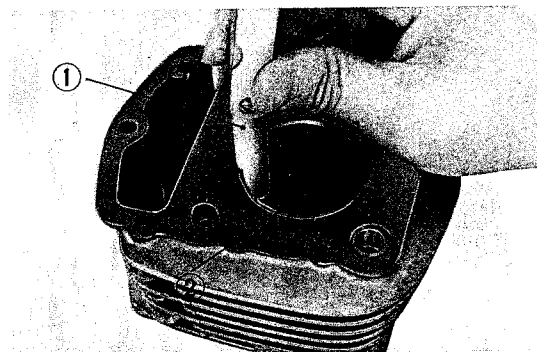

Fig. 40 Piston ring gap measurement  
① Thickness gauge ② Piston ring

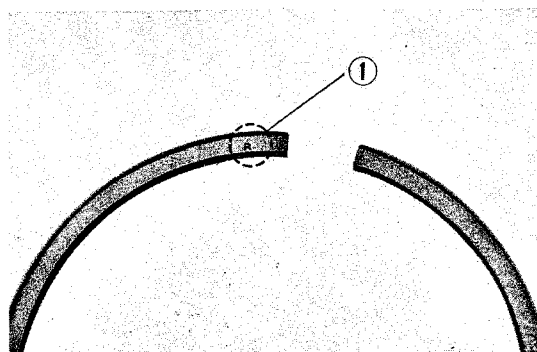

Fig. 41 ① Piston ring marking

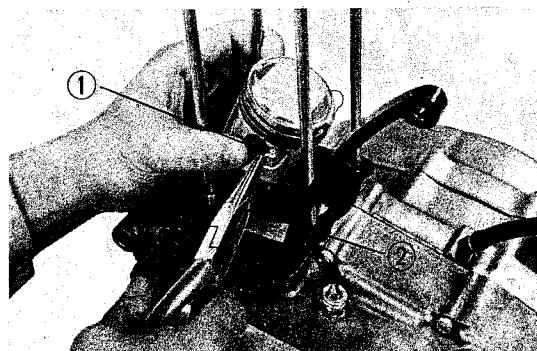

Fig. 42 Piston installation  
① Piston pin clips ② Long nose pliers

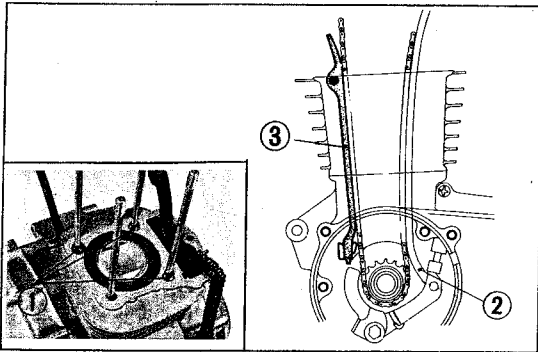

Fig. 43 ① Dowel pins ② Cam chain tensioner  
③ Cam chain guide

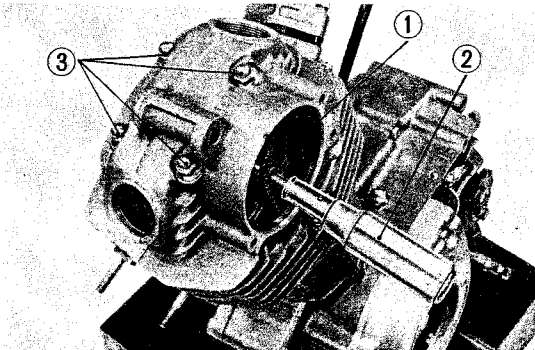

Fig. 44 ① Cam chain ② Screwdriver ③ 8mm cap nuts

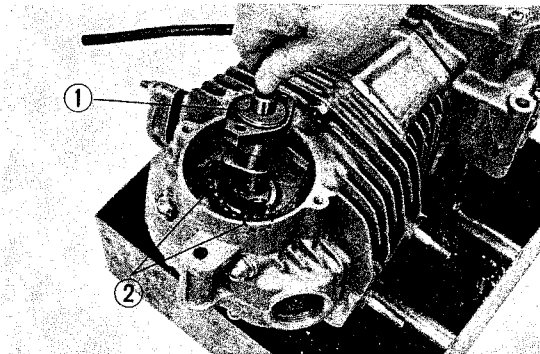

Fig. 45 Camshaft installation  
① Camshaft ② Cam lobe

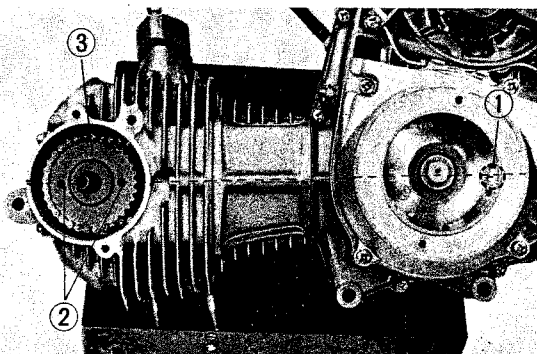

Fig. 46 Valve timing procedure  
① "T" mark ② Mounting holes ③ Cam sprocket

- 4) Reinstall the chain guide. (Fig. 43)
- 5) Reinstall the three dowel pins and O ring. (Fig. 43)

- 6) Assemble cam sprocket on the cam chain and then install the sub assembly on the cylinder head together with the cam chain tensioner.
- 7) Use a screwdriver to support the cam sprocket and then install the 8 mm cap nuts. (Fig. 44)  
Torque to 0.8-1.2 kg-m (5.8-8.7 ft. lbs).

- 8) Disassemble the cam chain from the cam sprocket and then reinstall the camshaft. (Fig. 45)

**Note:**

Align cam lobe to the cutout on the cylinder head and then install the camshaft. Rotate the camshaft one revolution to bring it to the top-dead-center position. This is determined by the cam sprocket mounting holes being perpendicular to the crankshaft.

- 9) Reinstall the cam sprocket.  
Install the cam sprocket after completing the valve timing. (Fig. 46)  
**(Valve timing procedure)**
  - a. Align the "T" mark on the crankshaft to the top-dead-center position.
  - b. Make the chain taut and install the cam sprocket with the mounting holes at the top.
  - c. Mount the sprocket with the two bolts.

- 10) Reinstall the breaker point base assembly using the oil seal guide.
- 11) Reinstall the spark advance. (Fig. 47)
- 12) Reinstall the contact breaker assembly.
- 13) Install the point cover.

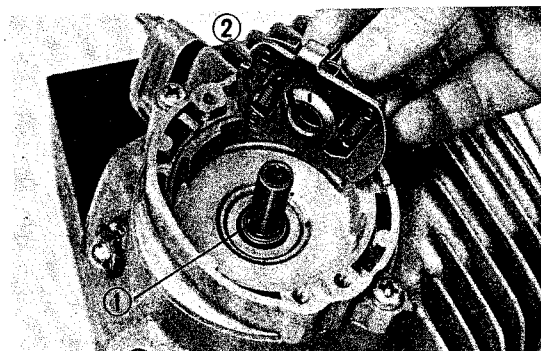

Fig. 47 Advance installation  
① Pin ② Pin hole

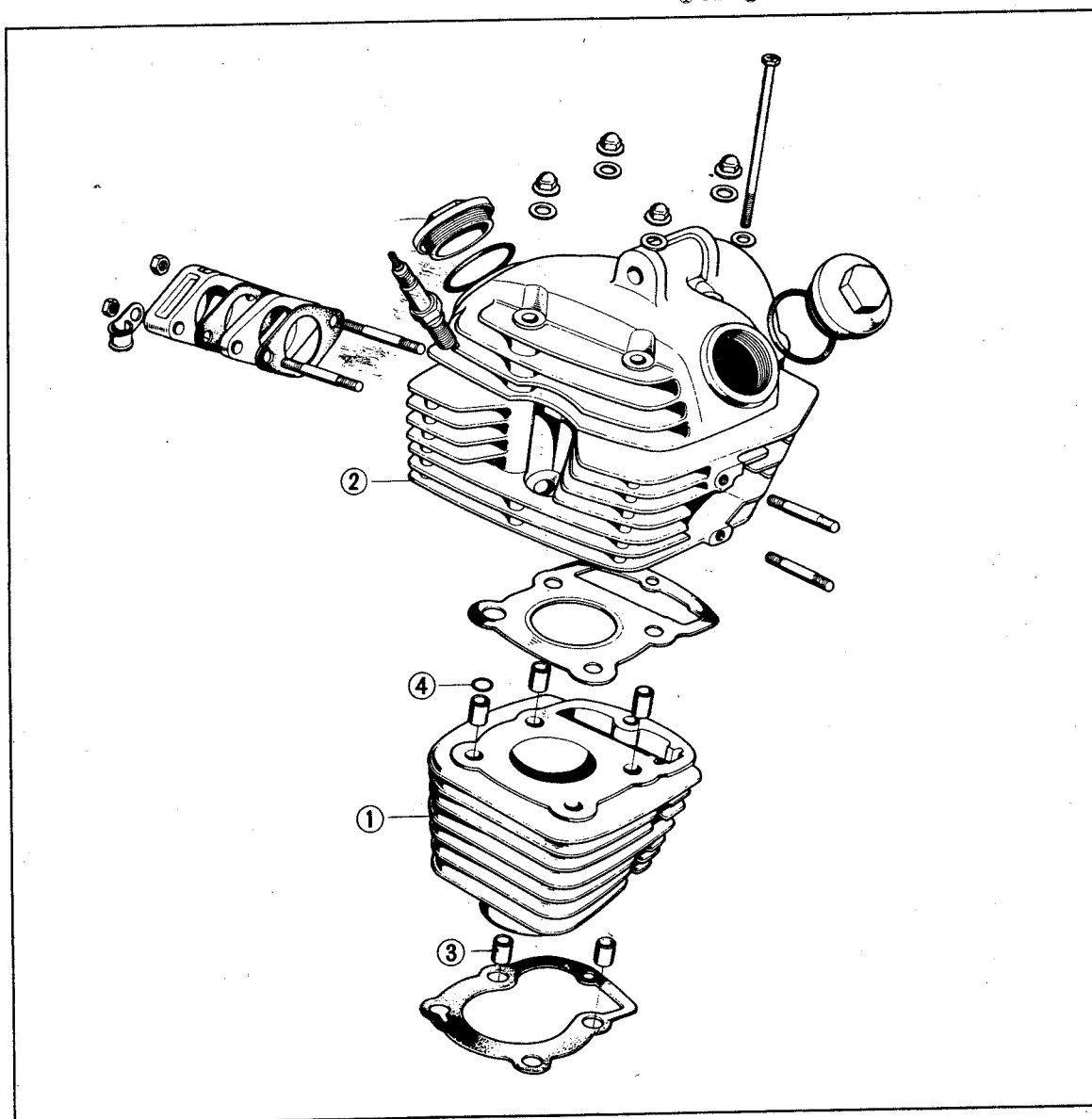
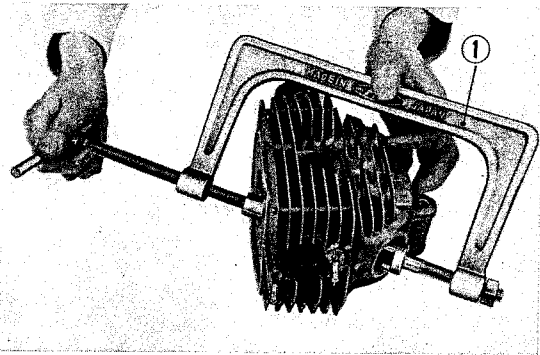
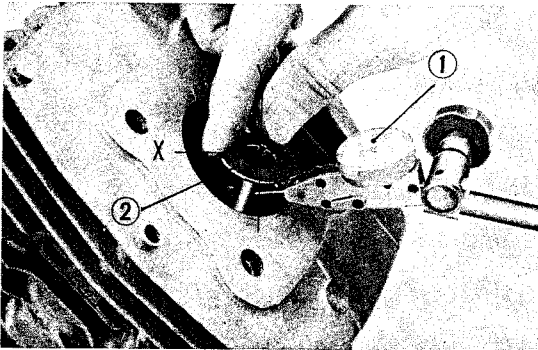

Fig. 48 ① Cylinder ② Cylinder head ③ Dowel pins ④ O ring



**Fig. 49 Valve removal**  
① Valve spring compressor (Tool No. 07031-10701)



**Fig. 50 Valve stem clearance measurement**  
① Dial gauge ② Valve

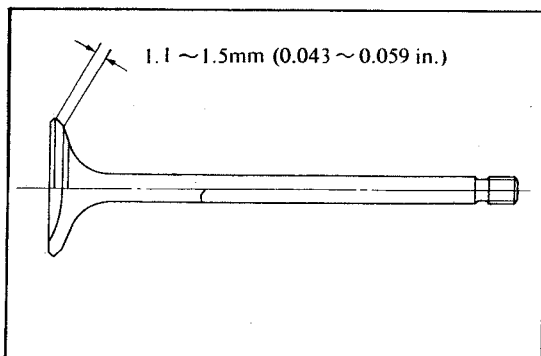

**Fig. 51 Valve face**

## 4. VALVE REMOVAL

### A. Disassembly

- 1) Remove the cylinder head in accordance with section 3. A.
- 2) Compress valve spring with a valve lifter and remove valve cotter and valve spring. The valve can then be removed. (Fig. 49)

### B. Inspection

- 1) Valve stem clearance is measured by raising the valve off its seat and measuring the amount of side play by applying the dial gauge against the valve head.

The play is measured along both the X and Y axes. (Fig. 50)

Exhaust valve with a TIR of greater than 0.08 mm (0.0032 in.) or inlet valve with TIR greater than 0.1 mm (0.004 in.) should have either the valve or guide replaced.

Item	Standard value	Serviceable limit
Valve stem diameter	IN 5.450-5.465mm (0.2145-0.2150 in.)	5.420mm min. (0.2130 in.)
	EX 5.430-5.445mm (0.2138-0.2146 in.)	5.400mm min. (0.2126 in.)

- 2) Valve guide replacement

Remove and reinstall valve guide using a valve guide driver (special tool No. 07046-21601). Use an oversize replacement valve guide. After replacing the valve guide, run a reamer through the valve guide to assure that the guide will be of standard diameter.

- 3) Valve face dimensional check

Apply thin coating of red lead or bluing on the valve face, press valve against the valve seat and rotate. Remove and check to see if there is a uniform width impression of the valve face. (Fig. 51)

Item	Standard value	Serviceable limit
Valve seat width	0.7mm (0.028 in.)	1.5mm max. (0.059 in.)



If there is uneven contact, the valve seat should be cut by first using the valve seat interior cutter followed by the top cutter and then finished with the 90° seat cutter. (Fig. 52)

#### 4) Valve lapping

Finally, lap the valve into the seat using a fine valve grinding compound. A uniform lap ring on the face of the valve indicates a good seating.

#### 5) Valve spring

Item	Standard value		Serviceable limit	
Free length	CB100 CL100 SL100	Outer	40.4mm (1.591 in.)	39.0mm (1.535 in. min.)
		Inner	35.7mm (1.406 in.)	34.5mm (1.358 in. min.)
	CB125S CD125S SL125	Outer	40.9mm (1.610 in.)	39.5mm (1.555 in. min.)
		Inner	33.5mm (1.318 in.)	32.0mm (1.259 in. min.)

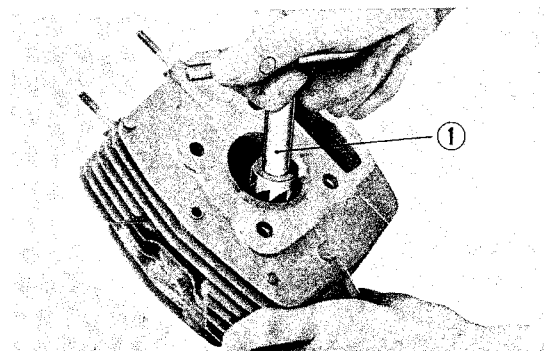

Fig. 52 Valve seat dressing  
① Valve seat 90° cutter (Tool No. 07001-10701)

### C. Reassembly

- 1) Clean all parts with solvent or kerosene and perform the reassembly in the reverse order of disassembly.
- 2) Reassemble the cylinder head in accordance with paragraph 3.C.

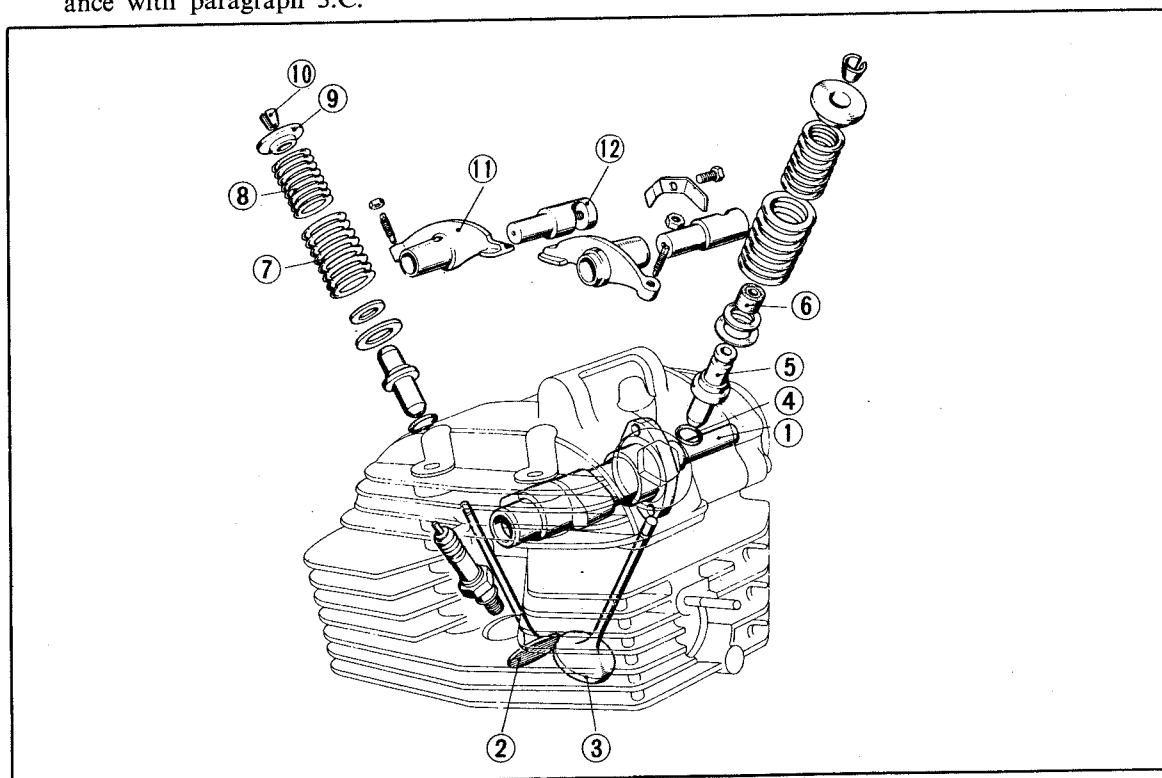

Fig. 53 ① Camshaft ② Inlet valve ③ Exhaust valve ④ O ring ⑤ Valve guide ⑥ Valve stem seal ⑦ Valve outer spring  
⑧ Valve inner spring ⑨ Valve spring retainers ⑩ Valve cutter ⑪ Valve rocker arm ⑫ Valve rocker arm shaft

## 5. OIL PUMP AND OIL FILTER

The oil pump is a trochoid type driven from the primary drive gear through the oil pump drive gear and supplies oil to all the rotating components.

The oil filter is mounted directly on the crankshaft. The impurities in the oil, due to its heavier weight, are deposited along the rib of the oil filter cap by centrifugal force and only the purified oil is allowed to be supplied to the various components of the engine.

Discharge volume . . . 2.4 l per min./10,000RPM

### Lubricating system

The oil in the crankcase is picked up by the oil pump and pressure fed through the right crankcase where it is diverted into two routes. In one direction, it is routed through the passage in the right crankcase cover, oil filter and to the crankshaft. The other direction, the oil is routed through the passage in the cylinder head stud, to the cylinder head and then to the camshafts and rocker arms.

From the right crankcase, the oil is also supplied under pressure to the transmission.

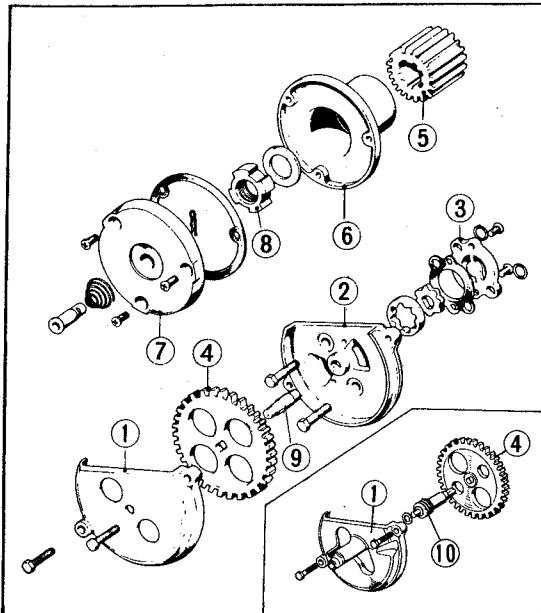

CB100, CL100, SL100 / CB125S, CD125S, SL125S

Fig. 54 ① Oil pump gear cover ② Oil pump body ③ Oil pump plate ④ Oil pump drive gear ⑤ Primary drive gear ⑥ Oil filter complete ⑦ Oil filter rotor cap ⑧ 18mm lock nut ⑨ Oil pump shaft ⑩ Pinion gear

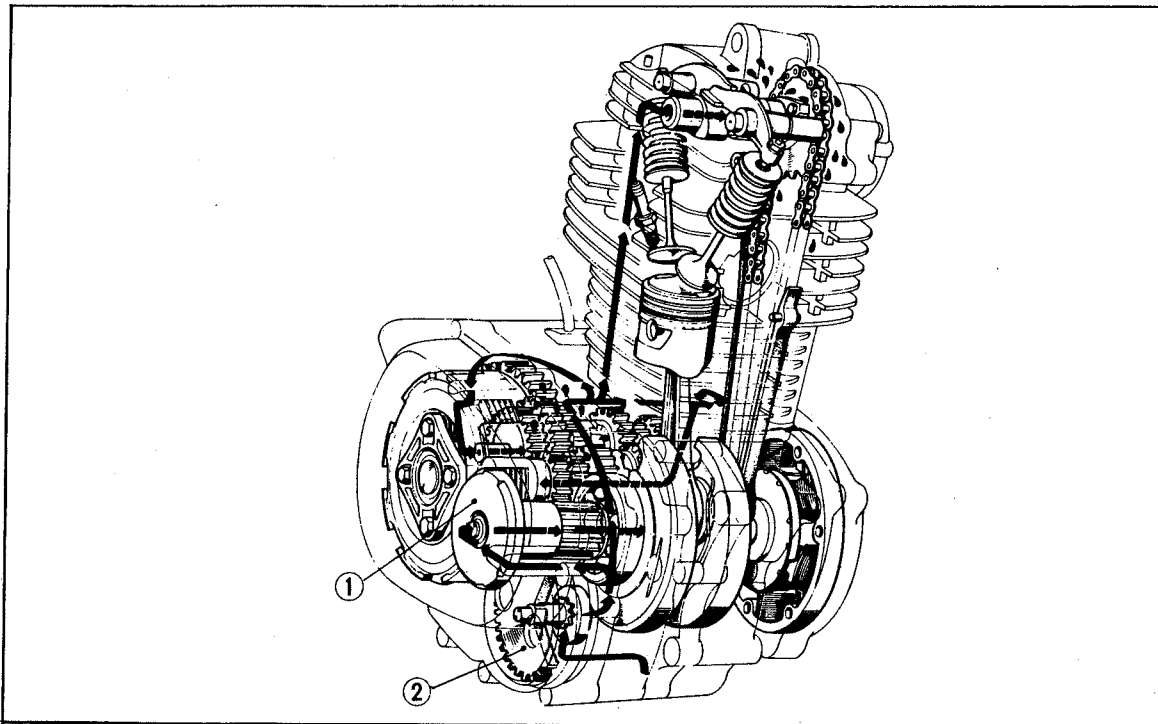
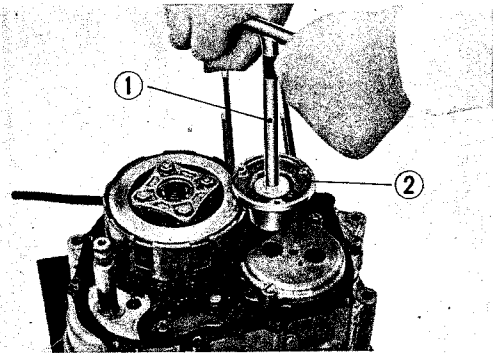

Fig. 55 Lubrication system  
① Oil filter ② Oil pump

### A. Disassembly

- 1) Remove the right crankcase cover.
- 2) Remove the oil filter rotor cover.
- 3) Unscrew the 6mm lock nut and remove the oil filter rotor. (Fig. 56)



**Fig. 56 Lock nut removal**  
 ① 16mm, T-handle box wrench (Tool No. 07086-28301)  
 ② Oil filter

- 4) Remove the oil pump gear cover.
- 5) (CB125S, CD125S, SL125)  
Remove the tachometer pinion gear.
- 6) Remove the oil pump drive gear. (Fig. 57)

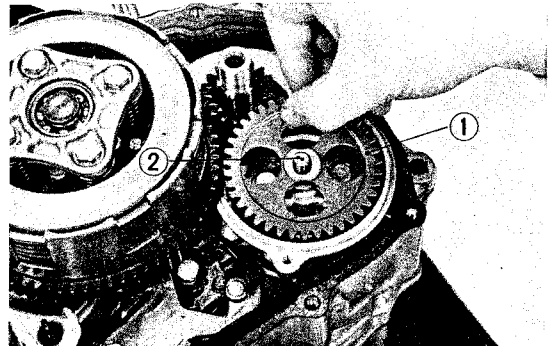

**Fig. 57 Oil pump drive gear removal**  
 ① Oil pump drive gear ② Shaft

- 7) Unscrew two 6mm oil pump body mounting bolts and then remove the pump body. (Fig. 58)

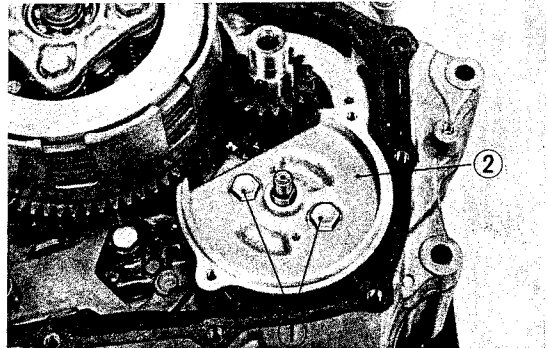

**Fig. 58 Oil pump body removal**  
 ① 6mm bolts ② Oil pump body

- 8) Pull out the oil pump shaft, loosen two 4mm pump outer rotor mounting screws and then remove the outer rotor. (Fig. 59)

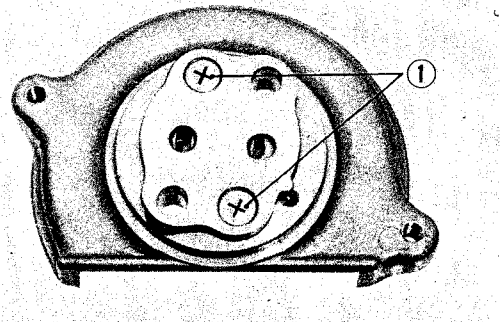

**Fig. 59 Oil pump disassembly**  
 ① 4mm screws

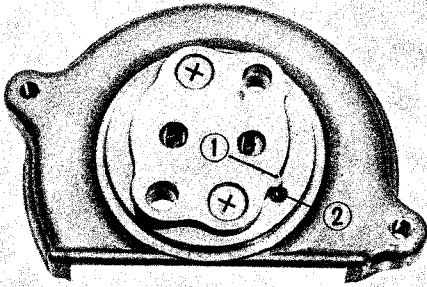

Fig. 60 ① Convex ② Concave

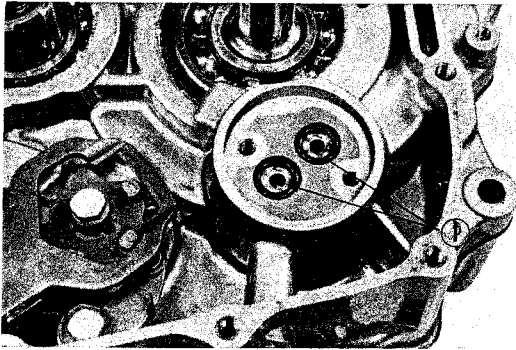

Fig. 61 ① O ring

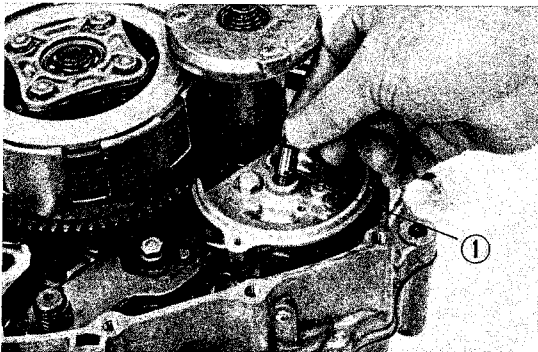

Fig. 62 ① Oil pump shaft

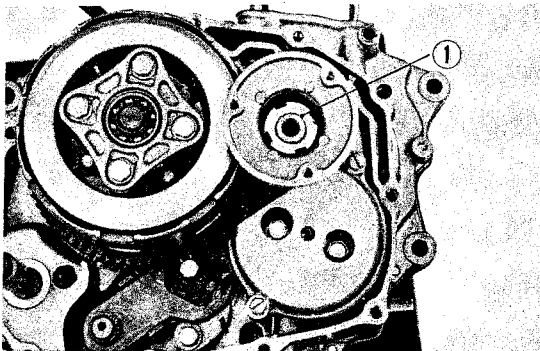

Fig. 63 Lock nut tightening  
① 16mm lock nut

### B. Reassembly

- 1) Perform the reassembly in the reverse order of disassembly. Align the concave part on the oil pump to the convex part on the oil pump plate and install (Fig. 60)

- 2) Reinstall the oil pump body.

**Note:**

**Do not forget to assemble two 2.4×9.4 "O" rings. (Fig. 61)**

- 3) Align oil pump shaft to the cutout on the inner rotor gear and then assemble. (Fig. 62) (CB125S, CD125S, SL125)  
Assemble the tachometer pinion gear.
- 4) Assemble the oil pump drive gears and install the pump gear cover with the 5mm mounting bolts.

- 5) Mount the oil filter rotor with the 16mm lock nut. (Fig. 63)  
Torque to 4.0–5.0 kg-m (29–36 ft-lbs).

**Note:**

- Do not forget to install the lock washer.**
- 6) Reinstall the right crankcase cover.

## 6. CLUTCH

The clutch is a multi-disc, wet type. The friction disc is bounded to heat dissipating center plate.

The clutch consists of five cork molded disc plates, four clutch plates and four clutch springs which are all assembled within the clutch outer.

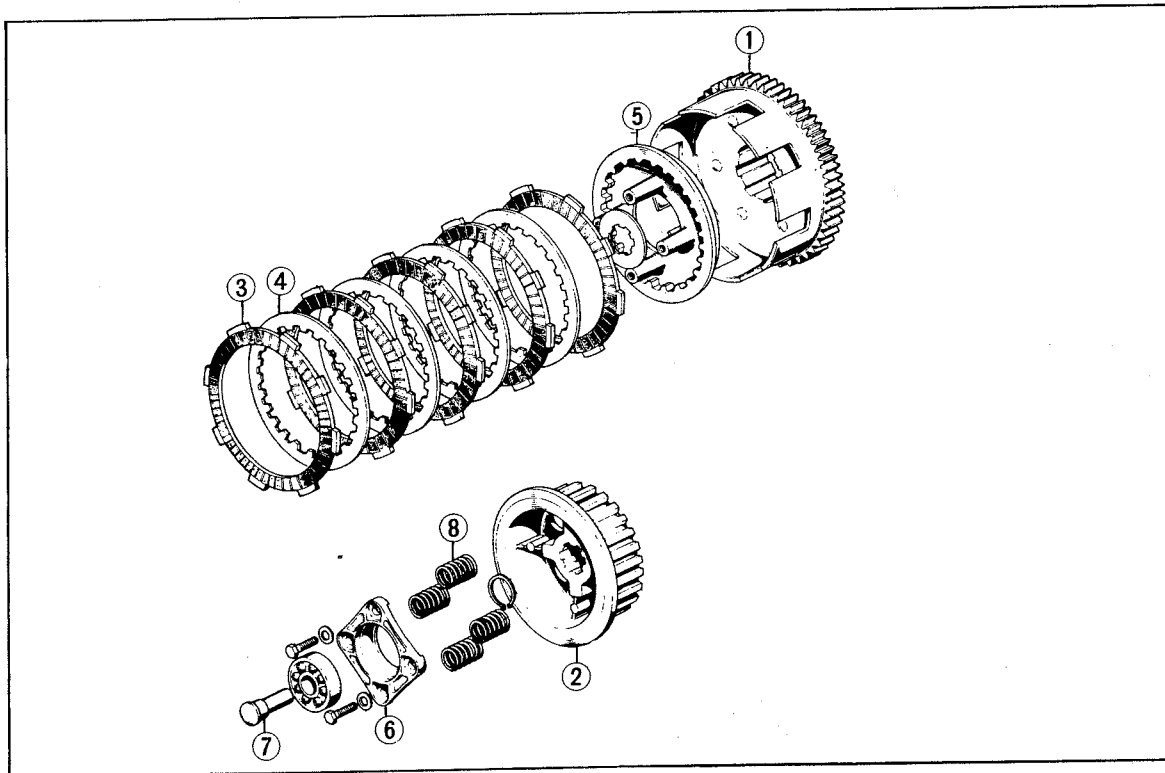

Fig. 64 ① Clutch outer complete ② Clutch center ③ Friction disc ④ Clutch plate ⑤ Clutch pressure plate ⑥ Clutch lifter plate  
⑦ Clutch lifter guide pin ⑧ Clutch spring

### A. Disassembly

- 1) Remove the right crankcase cover and the oil filter rotor in accordance with section 5.A.
- 2) Remove four 6mm bolts and remove the clutch lifter plate. (Fig. 65)

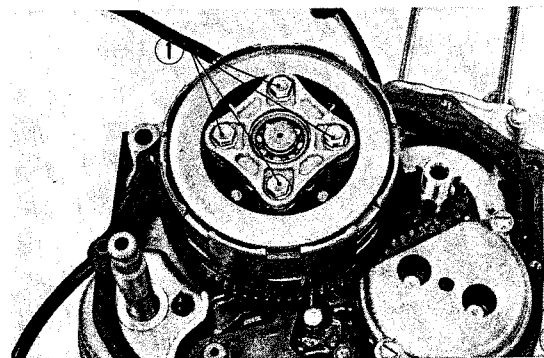
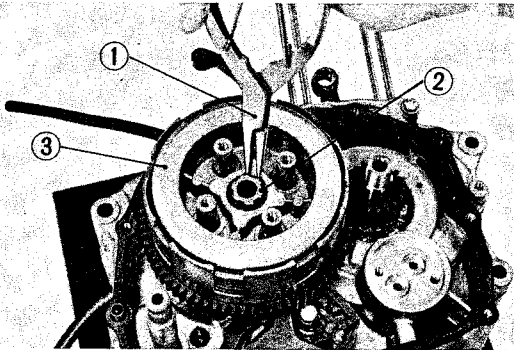
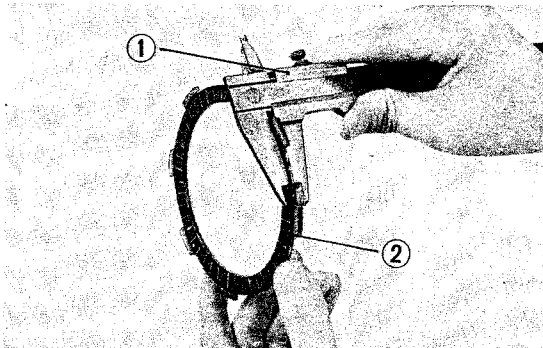

Fig. 65 Clutch removal  
① 6 mm. bolts



**Fig. 66 Clutch outer removal**  
 ① Special pliers ② 20 mm set ring ③ Clutch center



**Fig. 67** ① Vernier caliper gauge ② Clutch friction disc

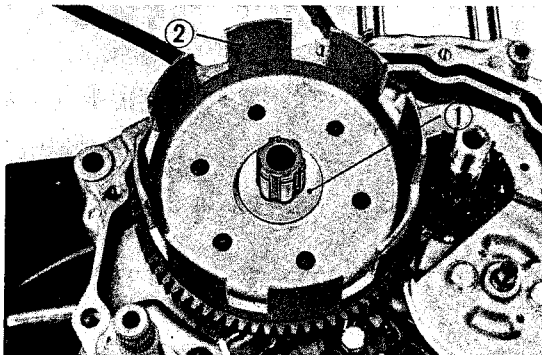

**Fig. 68 Spline washer installation**  
 ① 20 mm spline washer ② Clutch outer

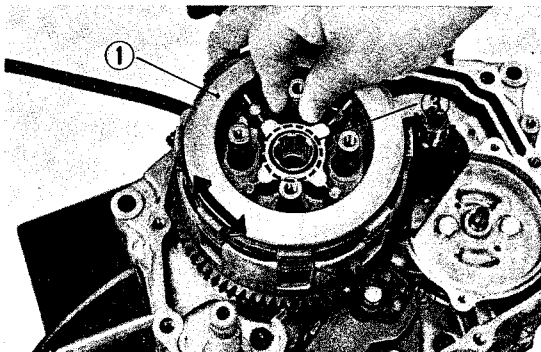

**Fig. 69 Clutch installation**  
 ① Clutch center ② Clutch friction disc ③ Splines

- 3) Unfasten the 20mm set ring and remove the clutch center together with the friction disc. (Fig. 66)
- 4) Remove the 20mm spline washer and then remove the clutch outer assembly.

#### B. Inspection

- 1) Clutch friction disc (Fig. 67)

Item	Standard value	Serviceable limit
Thickness	2.9mm (0.114 in.)	26mm (0.102 in.)

Replace the friction disc if beyond the serviceable limit.

- 2) Replace the worn or damaged clutch plate.

#### C. Reassembly

- 1) Install the clutch outer assembly and pressure plate. (Fig. 68)
- 2) Install the 20mm splined washer. (Fig. 68)

- 3) Assemble the friction discs and clutch plates alternately on the clutch center. Assemble the clutch plates and make the assembly after aligning the splines. (Fig. 69)

#### Note:

First, align the spline to the main shaft and then align the clutch outer spline while rotating the friction disc.

- 4) Install the 20mm set ring.
- 5) Assemble the clutch spring and install with the 6mm mounting bolts.  
Torque to **0.8–1.2kg-m (5.8–8.7 ft-lbs)**.

**Note:**

**Do not forget to install the clutch lifter guide pin.** (Fig. 70)

- 6) Assemble the oil filter rotor, and install the right crankcase cover in accordance with section 5.C.

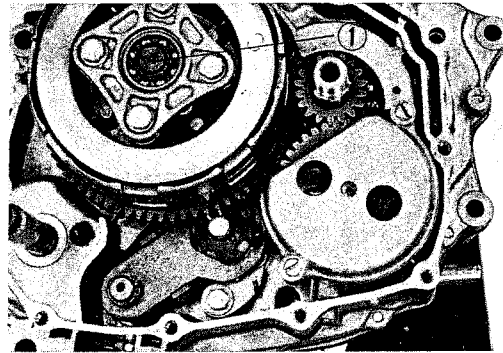

**Fig. 70** ① Clutch lifter guide pin

## 7. GEAR SHIFT MECHANISM

The gear shift mechanism consists of gear shift plate, gear shift drum, three gear shift forks, gear shift cam and the gear shift drum stopper bar. When the gear shift pedal is depressed, the gear shift cam drum rotates to perform the gear shifting. Also, a feature is incorporated into the system to prevent gear jumping during shifting.

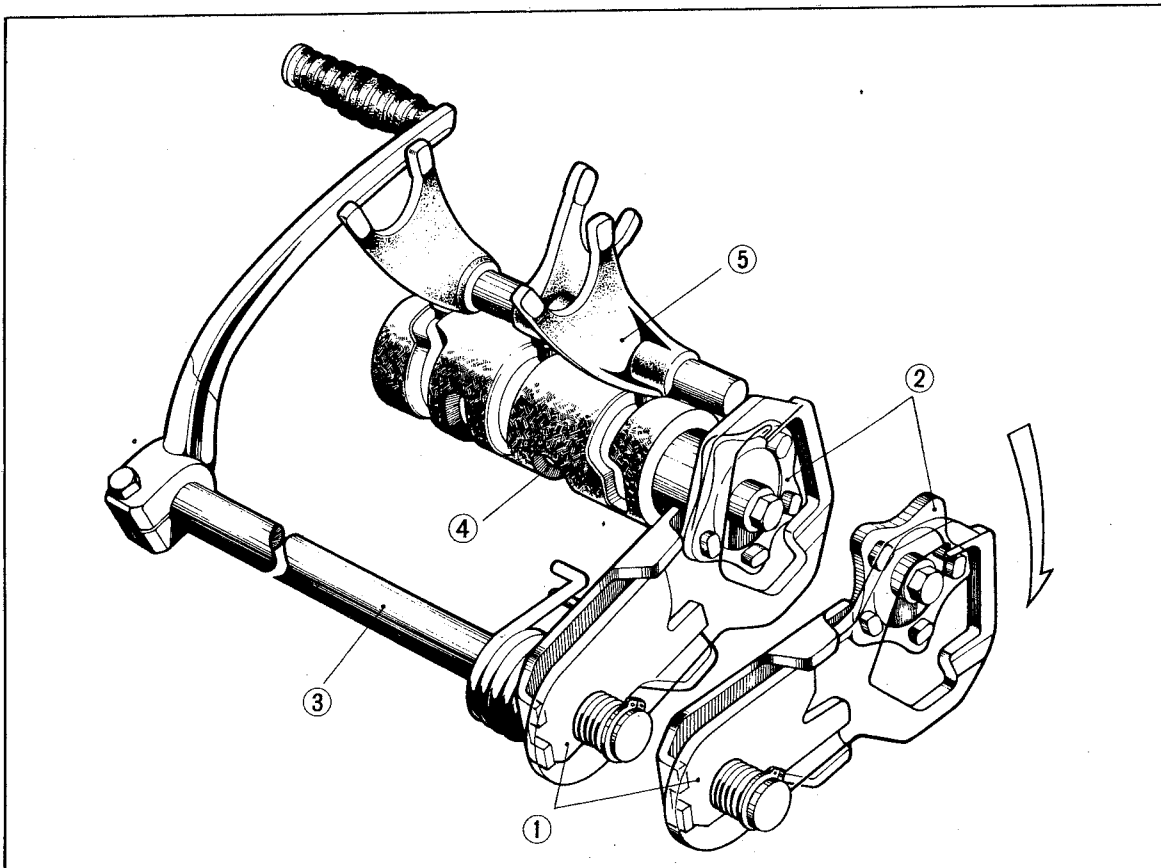

**Fig. 71** ① Gear shift plate ② Gear shift cam ③ Gear shift spindle ④ Gear shift drum ⑤ Gear shift fork

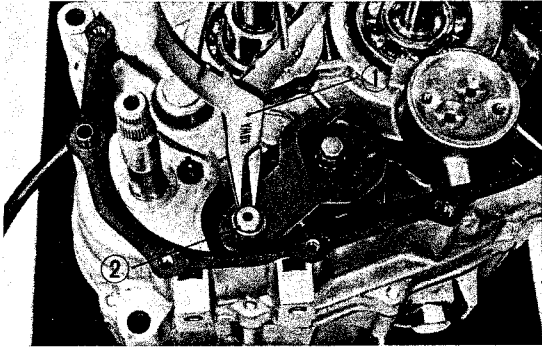

**Fig. 72 Circlip removal**  
 ① Special pliers ② Circlip

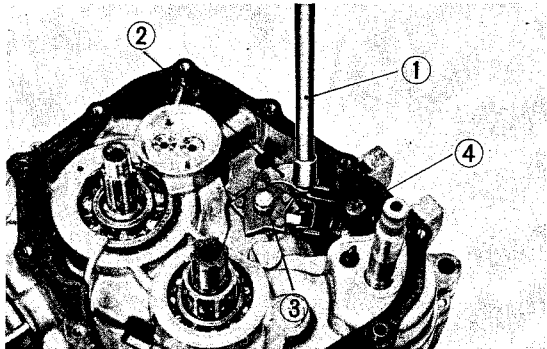

**Fig. 73** ① 6 mm, T-handle box wrench ② Gear shift drum stopper ③ Gear shift cam ④ Gear shift spindle

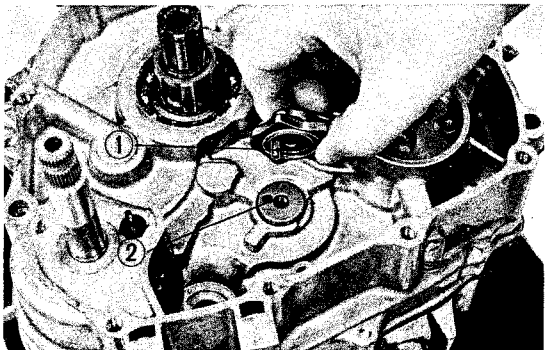

**Fig. 74 Pin alignment**  
 ① Cam pin ② Pin hole

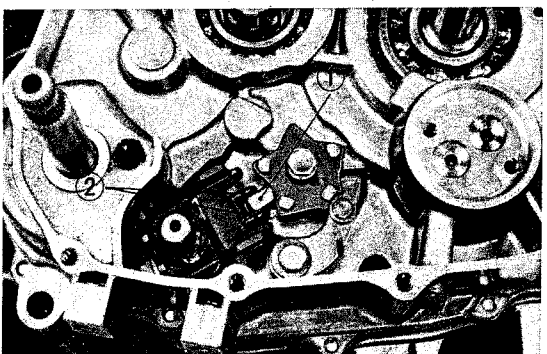

**Fig. 75 Spindle installation**  
 ① Boss ② Return spring

#### A. Disassembly

- 1) Remove the right crankcase cover and oil filter rotor in accordance with paragraph 5.A.
- 2) Remove the clutch in accordance with section 6.A.
- 3) By removing the circlip, the spring and gear shift plate can be disassembled. (Fig. 72)

- 4) Unscrew the 6mm gear shift drum stopper bolt and remove the drum stopper. (Fig. 73)
- 5) Unscrew the 6mm gear shift cam bolt and remove the shift cam. (Fig. 73)
- 6) Remove the gear shift pedal and then pull out the gear shift spindle. (Fig. 73)

#### B. Reassembly

- 1) Assemble the gear shift cam so that the cam pin is inserted into the hole in the drum. (Fig. 74)

- 2) Assemble the gear shift assembly. (Fig. 75)  
**Note:**

**Install gear shift return spring so that the end of the spring is hooked to the boss on the case.**

- 3) Install the gear shift drum stopper.
- 4) Install gear shift plate, assemble the spring and set into the case with the circlip.
- 5) Install the clutch in accordance with section 6.C.
- 6) Install the oil filter rotor and the right crankcase cover in accordance with section 5.B.



## 8. CAM CHAIN TENSIONER AND A.C. GENERATOR

A friction plate cam chain tensioner is utilized, and a plate spring supports the entire one side of the cam chain to control the slack in the chain. A chain guide is mounted on the opposite side to reduce the chain noise for a quiet operation. (Fig. 76) The description of the A.C. generator is found in the electrical system section.

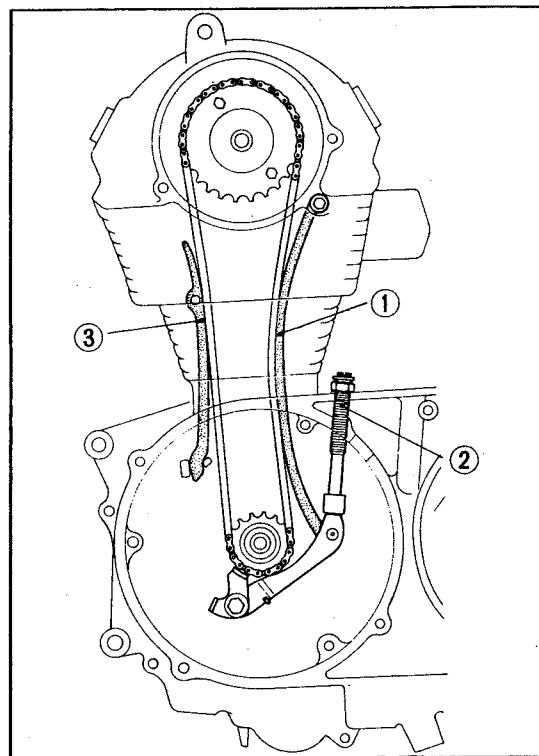

Fig. 76 ① Cam chain tensioner ② Adjusting bolt  
③ Cam chain guide

### A. Disassembly

- 1) Loosen four screws and remove the left crankcase cover.
- 2) Remove generator mounting bolts and remove the rotor assembly. (Fig. 77)
- 3) Loosen three 6mm A.C. generator mounting screws and remove the generator.
- 4) Remove the cam chain adjuster nut. (Fig. 78)
- 5) By removing the tensioner pivot bolt, the cam chain tensioner and the cam chain tensioner arm can be disassembled. (Fig. 78)
- 6) By removing the tensioner arm and push rod, the tensioner adjusting bolt can be pulled out. (Fig. 78)

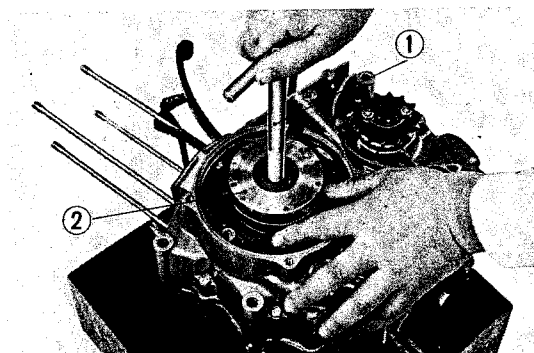

Fig. 77 **Rotor removal**  
① Dynamo rotor puller (Tool No. 07011-03001)  
② Dynamo rotor

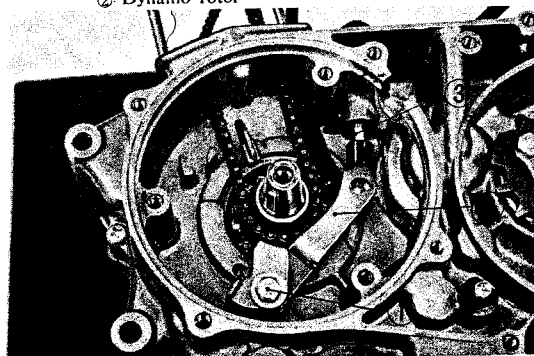

Fig. 78 ① Bolt ② Cam chain tensioner arm  
③ Adjusting bolt

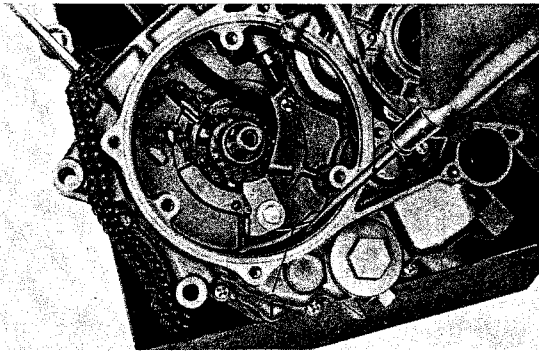

Fig. 79 Cam chain tensioner installation  
① Spring ② Screwdriver

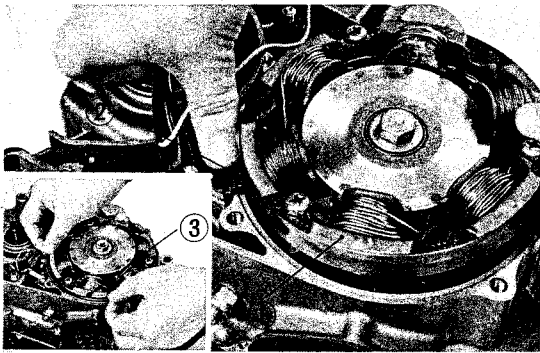

Fig. 80 Generator installation  
① Stator ② Cord grommet ③ O ring

## B. Reassembly

- 1) Install tensioner adjusting bolt from the outside of the case, install the case, and then install the tensioner arm rubber.
- 2) Assemble cam chain tensioner on the tensioner arm pin, hook the spring on the arm, and then install the tensioner arm adjusting bolt. (Fig. 79)

### Note:

To simplify work, hook the spring only on the tensioner arm and leave the other end unattached.

- 3) Install the rotor assembly.  
Torque to 2.6–3.2 kg-m (19.0–23.0 ft-lbs).
- 4) Mount the A.C. generator. First install the cord grommet, mount the generator, and then align the screw mounting holes. (Fig. 80)

### Note:

- Do not forget to install the 70×2.4 “O” ring
- 5) Install the left crankcase cover.

## 9. CRANKSHAFT

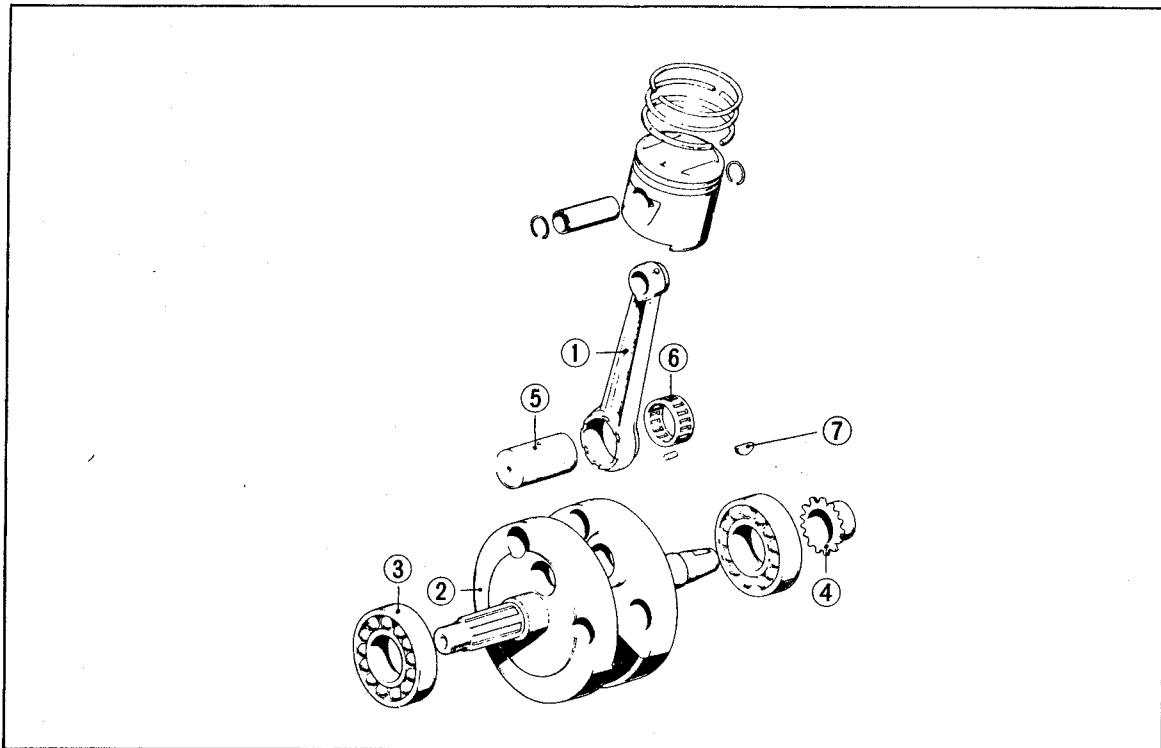

Fig. 81 ① Connecting rod ② Crank shaft ③ 6305 ball bearing ④ Timing sprocket ⑤ Crank pin ⑥ Retainer ⑦ Key

### A. Disassembly

- 1) Remove the cylinder head and cylinder in accordance with section 3.A.
- 2) Remove the right crankcase cover, oil filter and the oil pump in accordance with section 5.A.
- 3) Remove the clutch in accordance with section 6.A.
- 4) Remove the gear shift in accordance with section 7.A.
- 5) Remove the A.C. generator in accordance with section 8.A.
- 6) Remove the drive sprocket and unscrew eleven 6 mm crankcase mounting bolts (one screw on the inside is mounted on the right crankcase), tap the crankcase with a wooden hammer and separate the crankcase. (Fig. 82)
- 7) Support the right crankcase lightly and then gently tap the crankshaft on the right side to loosen and then separate it from the case. (Fig. 83)

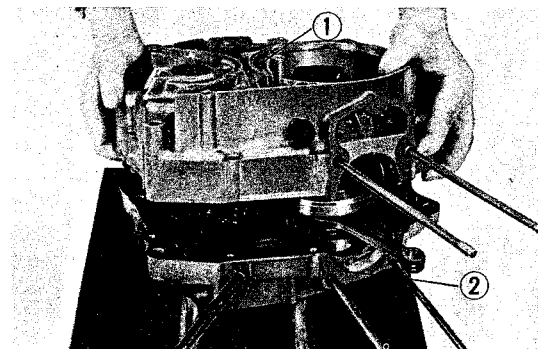

Fig. 82 Crankcase disassembly  
① L. crankcase ② R. crankcase

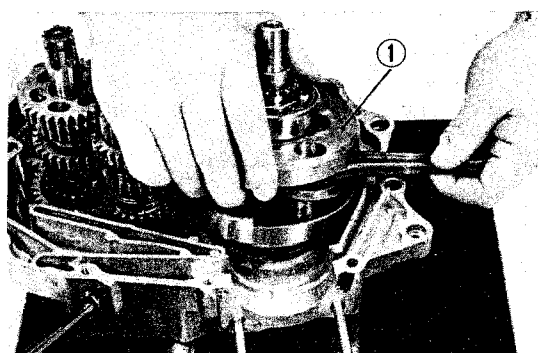

Fig. 83 Crankshaft disassembly  
① Crankshaft

### B. Inspection

- 1) Measure the runout of the crankshaft. Support the crankshaft at bearing with V block, and check the amount of runout using a dial gauge. (Fig. 84)

Item	Standard value	Serviceable limit
Crankshaft Right & left side	0.03mm (0.001 in.)	0.1mm (0.004 in.)

Replace if beyond the serviceable limit.

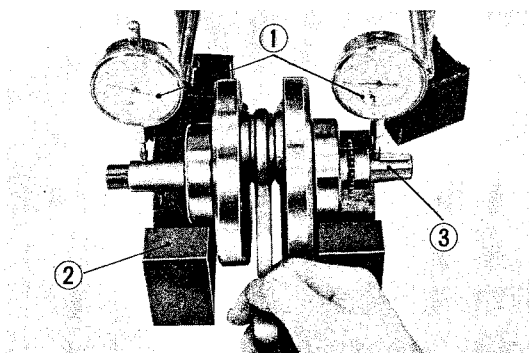

Fig. 84 Crankshaft runout measurement  
① Dial gauge ② V block

- 2) Check the clearance of the connecting rod large end. (Fig. 85)

Item	Standard value	Serviceable limit
Side clearance	0~0.01mm (0~0.0004 in.)	0.05mm (0.0020 in.)
Vertical clearance	0.10~0.35mm (0.004~0.014 in.)	0.8mm (0.032 in.)

Replace if beyond the serviceable limit.

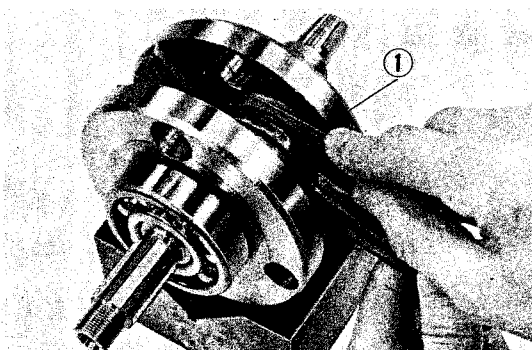

Fig. 85 Connecting rod large end clearance measurement  
① Thickness gauge

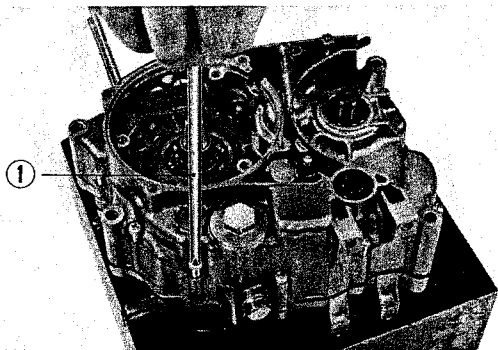

Fig. 86 Crankcase tightening  
① Screwdriver

### C. Reassembly

- 1) Assemble the crankshaft into the right crankcase.

**Note:**

Fit the crankshaft gently into the case. Forcibly handling or hammering may cause damage to ball bearings.

- 2) Install the left crankcase with the 6 mm attaching screws. (Fig. 86)

**Note:**

Exercise care not to cause the packing to shift or forget to install the two dowel pins.

## 10. TRANSMISSION AND PRIMARY KICK STARTER

The motorcycle of six models utilizes a five speed transmission. Since it incorporates a primary kick, the engine can be started with the gears engaged by disengaging the clutch. The kick gear will directly engage the crankshaft through the primary driven gear which rotates freely on the main shaft.

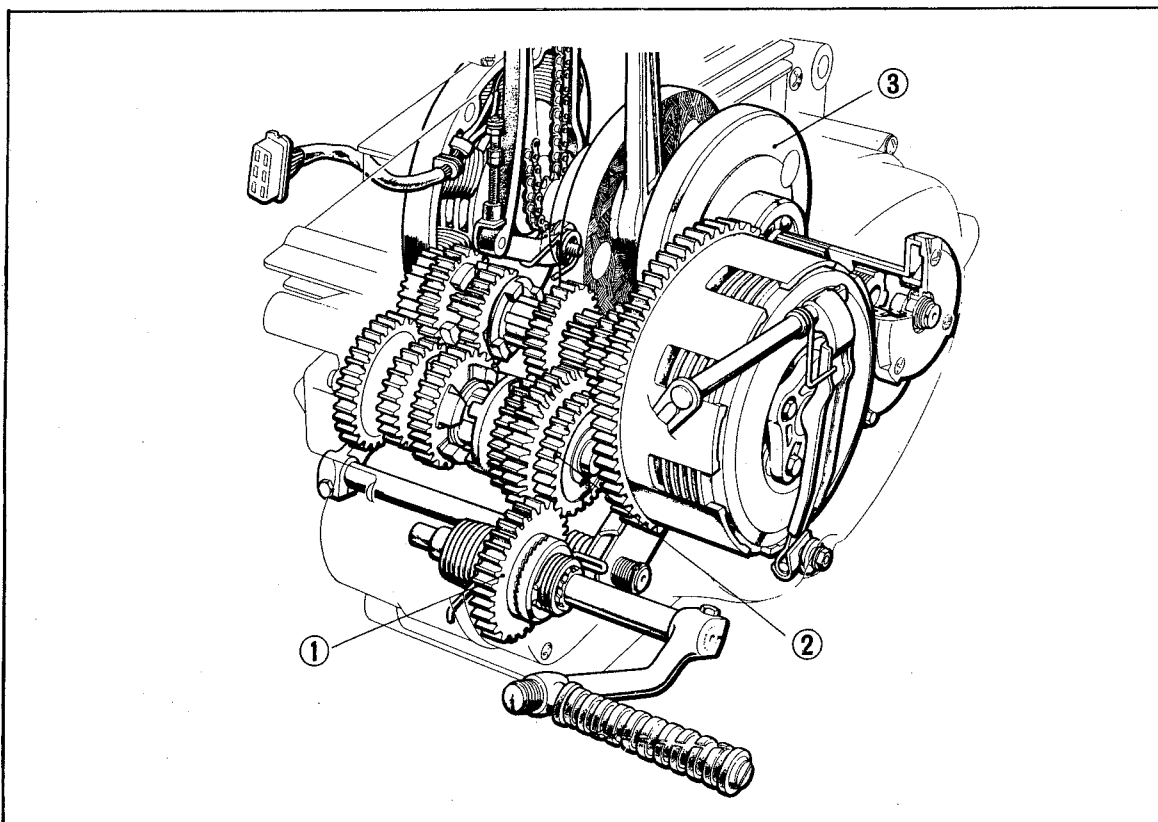

Fig. 87 ① Kick gear ② Primary starter idle gear ③ Crankshaft

### A. Disassembly

- 1) Remove the cylinder head and cylinder in accordance with section 3.A.
- 2) Remove the right crankcase cover, oil filter and the oil pump in accordance with section 5.A.
- 3) Remove the clutch in accordance with section 6.A.
- 4) Remove the gear shift in accordance with section 7.A.
- 5) Remove the A.C. generator in accordance with section 8.A.
- 6) Separate the case in accordance with section 9.A.
- 7) Remove the kick starter spindle.
- 8) Remove the main shaft, counter shaft and shift drum all at the same time.
- 9) The shift fork can be removed by extracting the shift fork guide shaft.
- 10) The kick gear can be removed together with the kick spindle and spring by extracting the circlip.

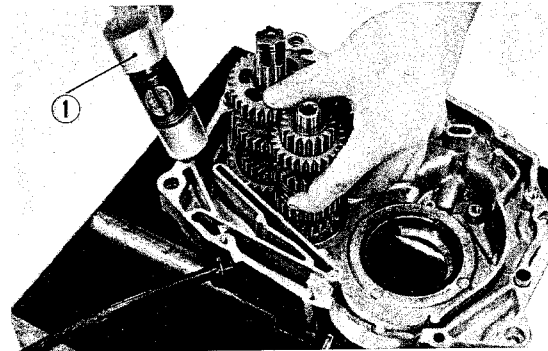

Fig. 88 Transmission gear removal  
① Wooden hammer

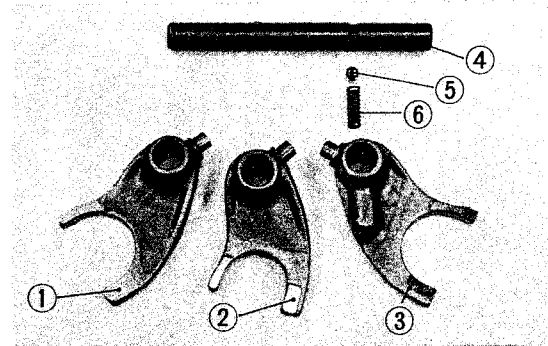

Fig. 89 ① R. shift fork ② Center shift fork ③ L. shift fork  
④ Shift fork guide shaft ⑤ 4x10 roller ⑥ Spring

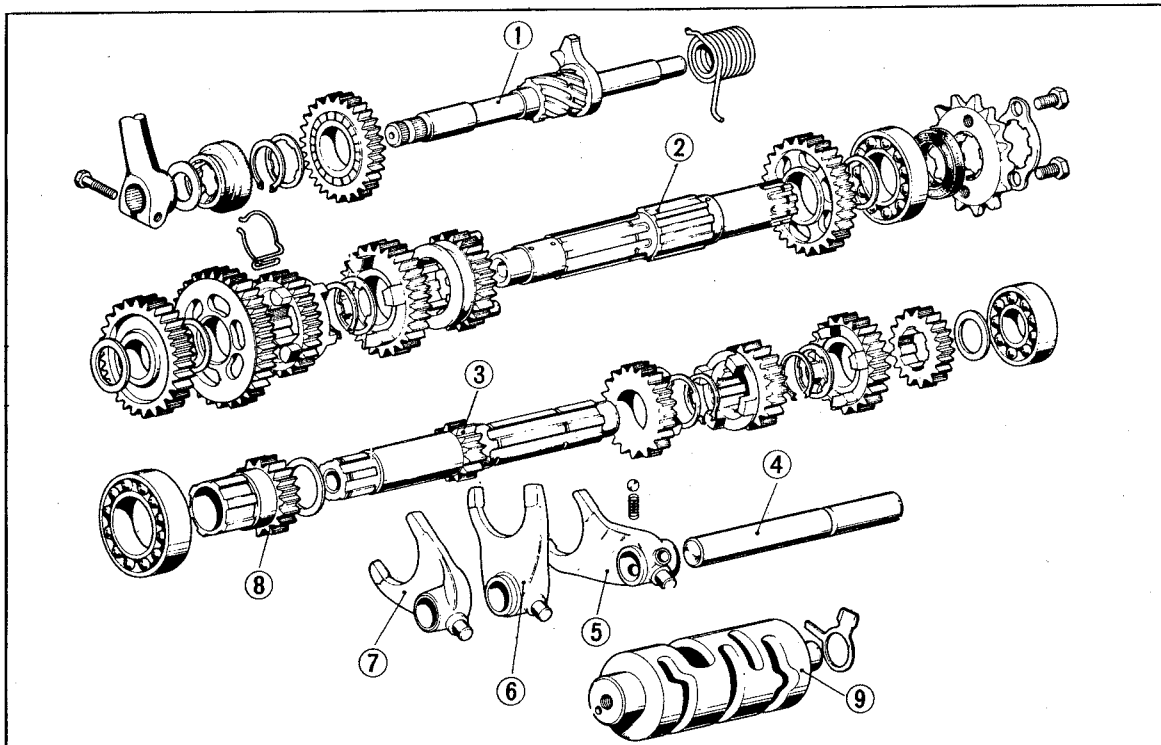

Fig. 90 ① Kick starter spindle ② Counter shaft ③ Main shaft ④ Gear shift fork guide shaft ⑤ L. shift fork ⑥ Center shift fork  
⑦ R. shift fork ⑧ Primary starter gear ⑨ Gear shift drum

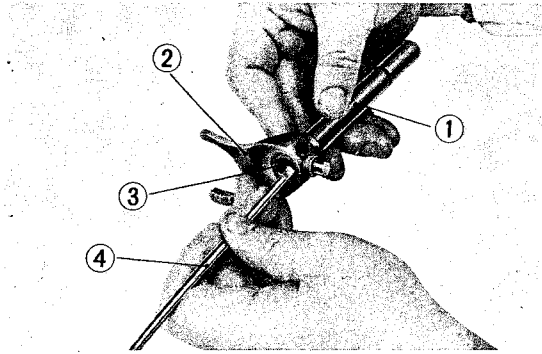

Fig. 91 ① Shift fork guide shaft ② L. shift fork ③ 4×10 roller ④ Screwdriver

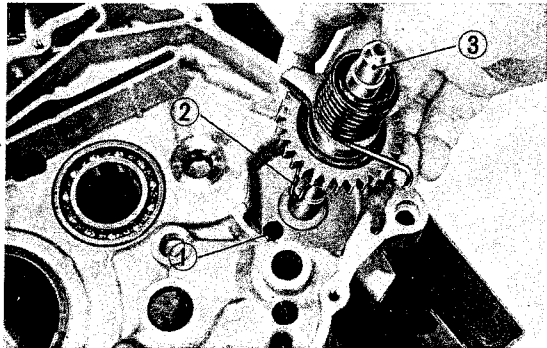

Fig. 92 Kick starter installation  
① Hole ② Spring ③ Kick starter spindle

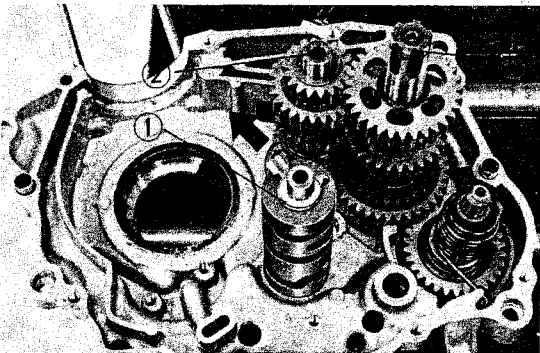

Fig. 93 Direction of drum installation  
① Gear shift drum ② Main shaft ③ Counter shaft

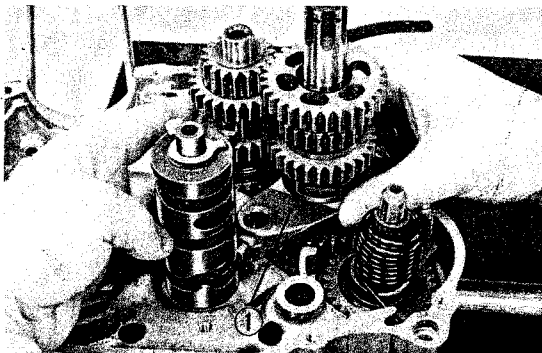

Fig. 94 ① R. shift fork

## B. Reassembly

1) Assemble right gear shift fork on the gear shift fork guide shaft. (Fig. 91)

### Note:

When installing the spring and 4×10 rollers on the guide shaft, use a thin screwdriver or other pointed tool to make the installation.

2) Assemble the kick starter spindle into the right crankcase. (Fig. 92)

### Note:

Insert one end of spring into the hole in the case and then hook the other end on the boss in the case.

3) Subassemble the main shaft and counter-shaft, and then assemble the subassembly into the case. (Fig.93)

4) Install the gear shift drum

### Note:

If neutral switch rotor is positioned in the direction of the cylinder installation, the installation of gear shift fork will be simplified.

5) Assemble the right shift fork into the counter shaft top gear, raise the gear and then assemble guide pin into guide groove on the drum. (Fig. 94)

- 6) Install the center shift fork in the same manner. (Fig. 95)

**Note:**

**Perform installation from the counter shaft end.**

- 7) Install the left gear shift fork, align the holes in the three shift forks and then insert the shaft in from the top.
- 8) Install the crankshaft.
- 9) When installing the left crankcase, make sure that the kick spindle shaft is perpendicular to the hole in the left crankcase. (Fig. 96)

## 11. CARBURETOR

### Float level adjustment

- 1) Set the carburetor on its side.
- 2) Raise the float lightly with the finger tip and locate the position of the float where the float arm and the float valve are either barely touching or provided with a clearance of **0.1 mm (0.003 in.)**
- 3) In this position, the height of the float above the carburetor body should be **24 mm (0.826 in.)** when measured at the side of the float. If adjustment is necessary, carefully bend the float arm. (Fig. 97)

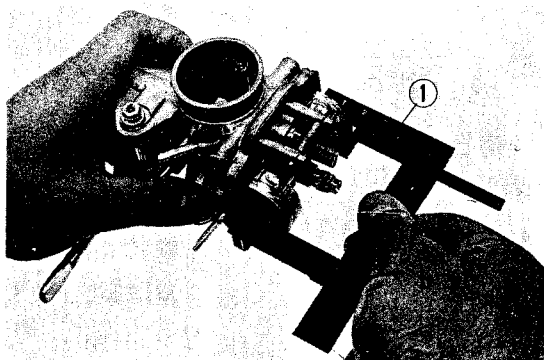

Fig. 97 ① Fuel level gauge

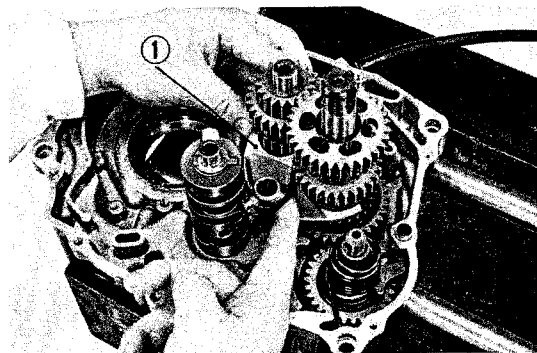

Fig. 95 ① Center shift fork

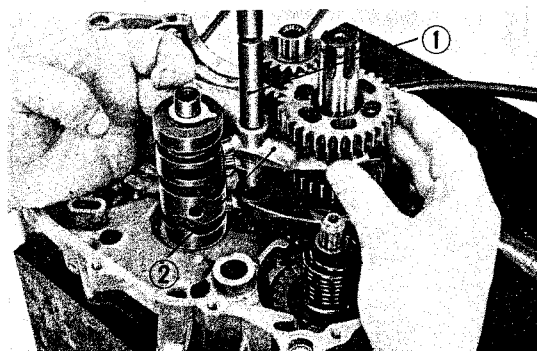

Fig. 96 ① Shift fork guide shaft ② L. shift fork

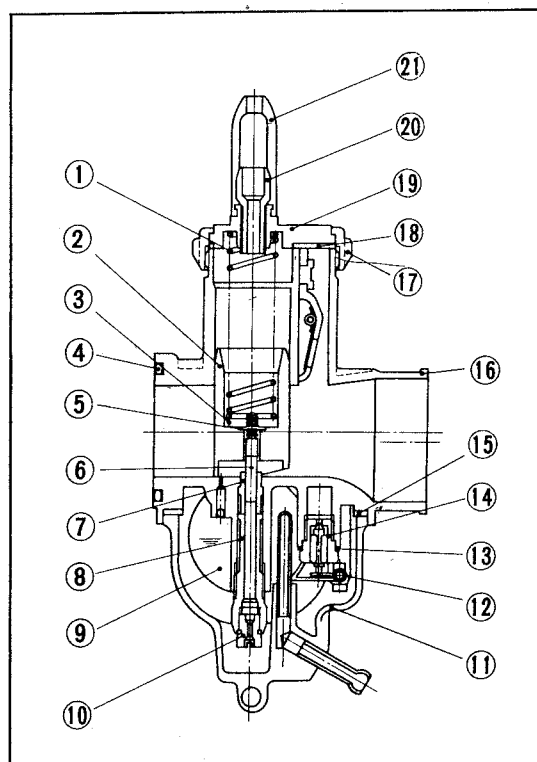

Fig. 98 ① Coil spring ② Throttle valve ③ Needle clip plate ④ O ring ⑤ Bar clip ⑥ Jet needle ⑦ Needle jet ⑧ Needle jet holder ⑨ Float ⑩ Main jet ⑪ Float chamber body ⑫ Arm pin ⑬ Valve seat ⑭ Slow jet ⑮ Float chamber washer ⑯ Body ⑰ Cap ⑱ Top washer ⑲ Top ⑳ Cable adjuster ㉑ Rubber cap

---

**CARBURETOR SETTING TABLE**

Item	CB100, CL100, SL100	CB125S, CD125S, SL125S
Main jet	# 110	# 105
Air jet	# 100	
Needle jet	2.6 $\phi$ ×3.8 $\phi$ length 10	
Needle jet holder	5.0 $\phi$	
Jet needle	2°30''×3 step 2.495 $\phi$	2°30''×5 step 2.495 $\phi$
Air screw	11/2±1/8	
Throttle valve	# 2.5 cutaway width 1.2 depth 0.2	# 2.5 cutaway width 1.8 depth 0.2
Slow jet	1 0.8 $\phi$ ×2 # 38 2 0.8 $\phi$ ×2 3 0.8 $\phi$ ×2	# 38 0.9 $\phi$ ×2×4
Fuel level	24mm (0.9449 in.)	



## IV. CHASSIS

37

### 1. FRONT BRAKE AND FRONT WHEEL

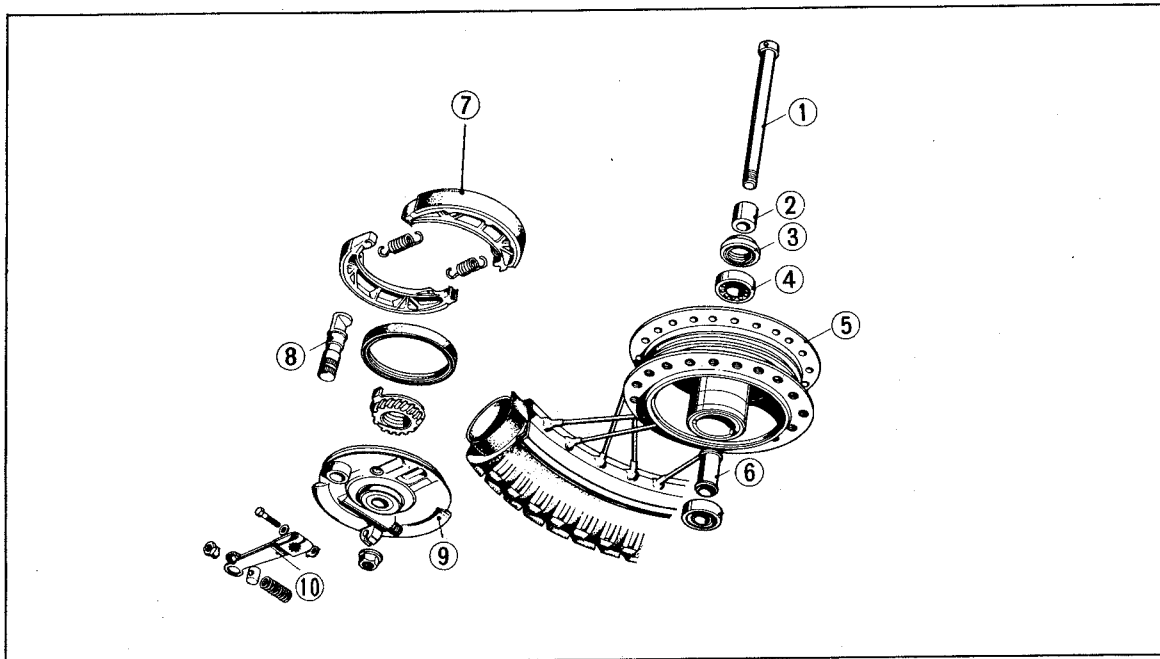

Fig. 99 ① Front wheel axle ② Front wheel side collar ③ 21×37×7 oil seal ④ 6301R ball bearing ⑤ Front wheel hub ⑥ Front axle distance collar ⑦ Brake shoe ⑧ Front brake cam ⑨ Front brake panel ⑩ Front brake arm

#### A. Disassembly

- 1) Place an appropriate stand under the engine.
- 2) Disconnect the front brake cable.
- 3) Disconnect the speedometer cable.
- 4) Remove front wheel axle nut, extract the front wheel axle and then drop the wheel (Fig. 100)
- 5) Remove the brake arm, unhook the two brake shoe springs and then disassemble the brake shoes from the brake panel. (Fig. 101)
- 6) Remove the oil seal, the two ball bearings (#6301R), and then pull out the front axle distance collar.

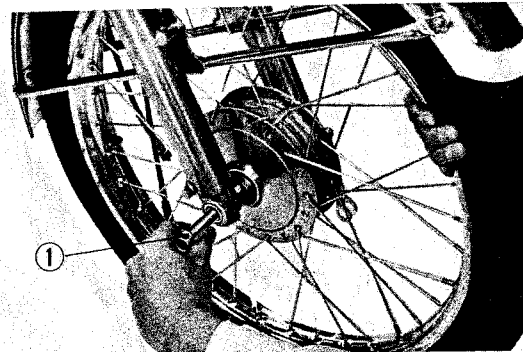

Fig. 100 Front wheel removal  
① Front wheel axle

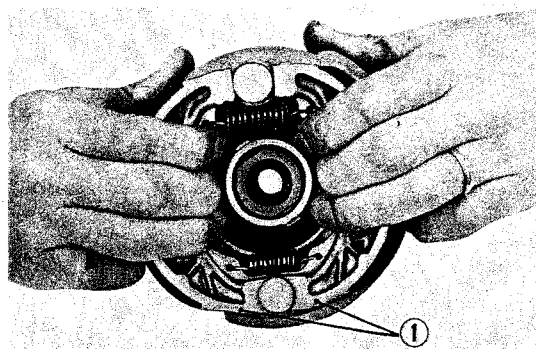

Fig. 101 Brake shoe removal  
① Brake shoe

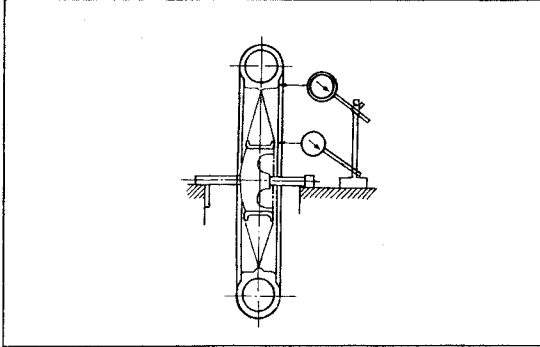

Fig. 102 Rim runout measurement

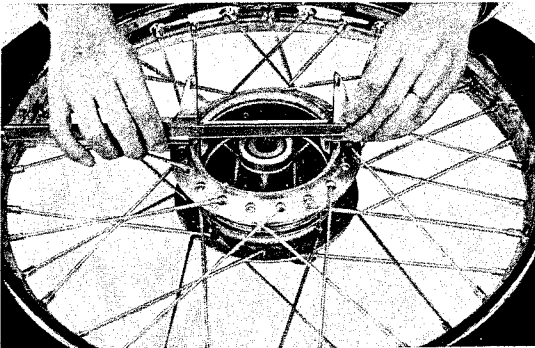

Fig. 103 Front brake drum measurement

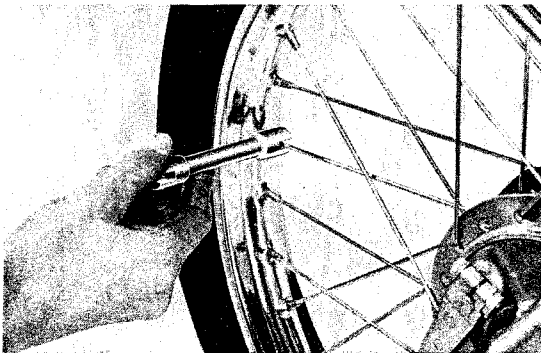

Fig. 104 Spoke retightening

### B. Inspection

- 1) Check for bend in the front axle.
- 2) Check for worn bearing (#6301R).
- 3) Check rim runout using a dial gauge.  
(Fig. 102)

Item	Standard value	Serviceable limit
Side runout	0.5mm Max. (0.020 in.) Max.	3.0mm (0.120 in.)

True the wheel rim by tightening the spokes if beyond the serviceable limit. If damaged or excessively bent, replace with new one.

- 4) Check wear of brake drum using a caliper.  
(Fig. 103)

Item	Standard value	Serviceable limit
Inside diameter of drum	109.8~110.2mm (4.3229-4.3385 in.)	112mm (4.4094 in.)

Replace if beyond the serviceable limit.

- 5) Check wear of brake lining.

Item	Standard value	Serviceable limit
Lining thickness	3.9~4.1mm (0.1535-0.1614 in.)	2mm (0.07874 in.)

Replace if beyond the serviceable limit.

- 6) Check spokes for damage, bent and loosening. Tighten the loose spokes, straighten the bent spokes and replace the broken spokes with new one. (Fig. 104)
- 7) Check brake panel for buckling and other damages. If damaged, replace with new one.
- 8) Check speedometer gears for wear. If worn, replace with new one.
- 9) Check oil seal for damage, buckling and wear. If worn or damaged, replace with new one.
- 10) Check both the exterior and interior of tire for damage, and imbedding of wire and nails. If worn or damaged, replace with new one. When replacing the tire, fit a new inner tube together. Measure tire pressure with pressure gauge. Correct tire pressure is **1.8 kg/cm<sup>2</sup> (26 psi)** for front.
- 11) Check for air leaks around the valve stem and tube. If leaking, repair or replace with new one.

### C. Reassembly

- 1) Inflate the tube with small amount of air and install the tire on the rim by forcing the bead of the tire on the inside of the rim (Fig. 105)

**Note:**

- After the tire has been assembled, inflate with air to about 1/3 the specified pressure and then tap the tire all around with a wooden hammer to relieve pinching of folds in the tube.
  - After assuring that the valve stem is in alignment with the wheel axle, tighten the stem lock nut, being careful not to cause leak around the stem.
- 2) Apply grease to the wheel ball bearings (# 6301R) and the inside of the wheel hub. Assemble distance collar and ball bearings into the wheel hub.

**Note:**

The ball bearings are equipped with a dust seal, therefore, make sure that it is installed in the proper direction.

(Fig. 106)

- 3) Assemble the brake cam into the front brake panel, hook the brake shoe springs on to the brake shoes and then assemble the brake shoes on the brake panel.
- 4) Install the brake arm.
- 5) Assemble the brake panel on the front wheel. Align the recessed section of the panel to the protruding section of the front fork. Assemble the oil seal and side collar on the side of the bearing retainer and then mount it on the front axle with a nut.
- 6) Connect the speedometer cable.
- 7) Connect the front brake cable to the brake arm and adjust the play in the brake lever.

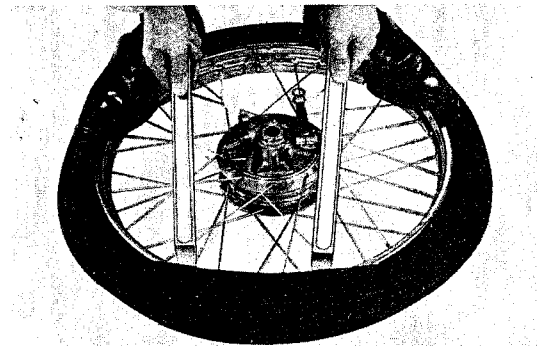

Fig. 105 Tire assembly

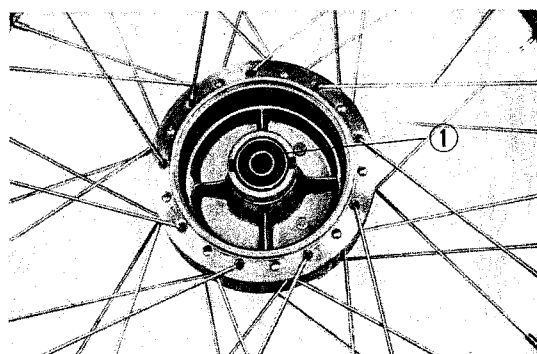

Fig. 106 ① # 6301R ball bearing

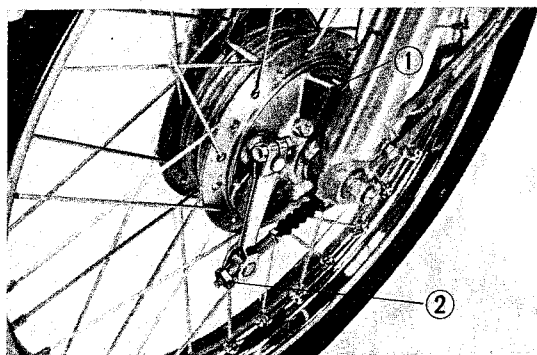

Fig. 107 Front brake wire adjustment  
① Recessed section of pannel ② Adjuster nut

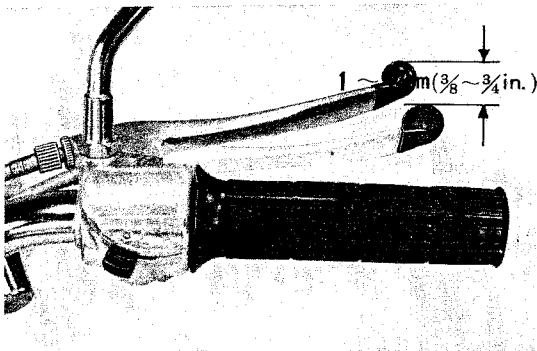

Fig. 108 Brake lever play  
① Adjuster nut ② Lock nut

## 2. REAR BRAKE AND REAR WHEEL

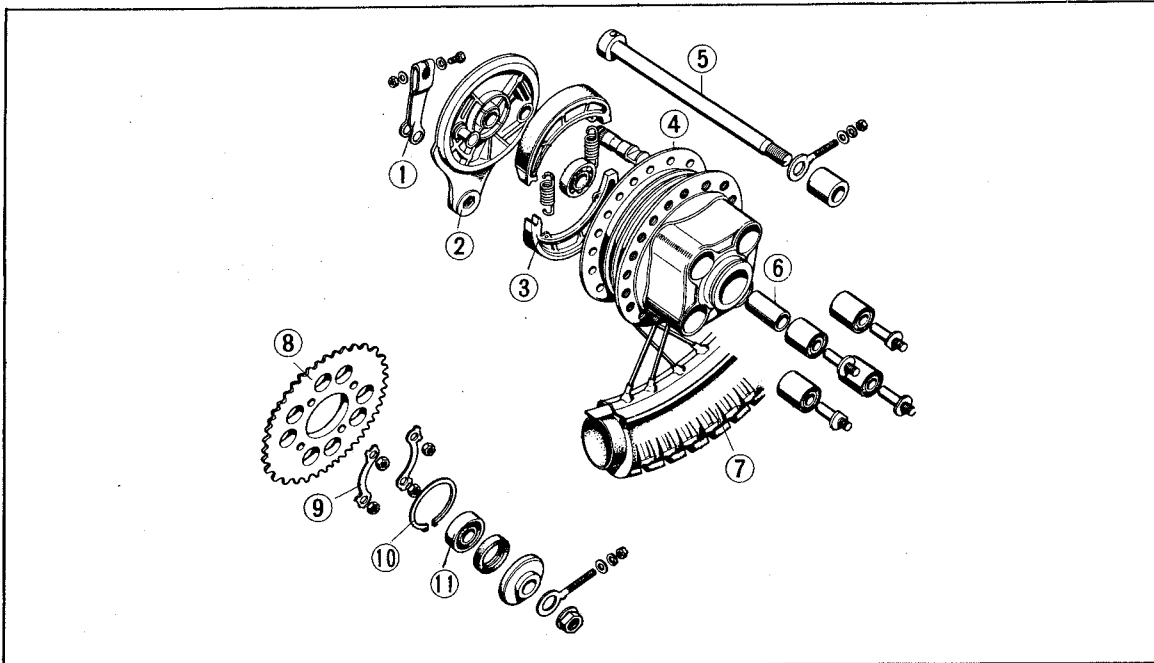

Fig. 109 ① Rear brake arm ② Rear brake panel ③ Brake shoe ④ Rear wheel hub ⑤ Rear wheel axle ⑥ Rear axle distance collar ⑦ Rear wheel tire ⑧ Final driven sprocket ⑨ 8 mm tongued washer ⑩ 58 mm circlip ⑪ 6302R ball bearing

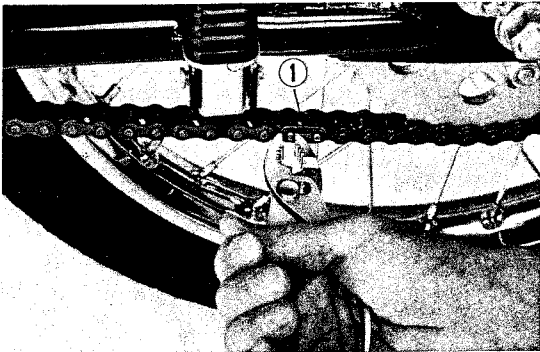

Fig. 110 Drive chain disassembly  
① Drive chain link

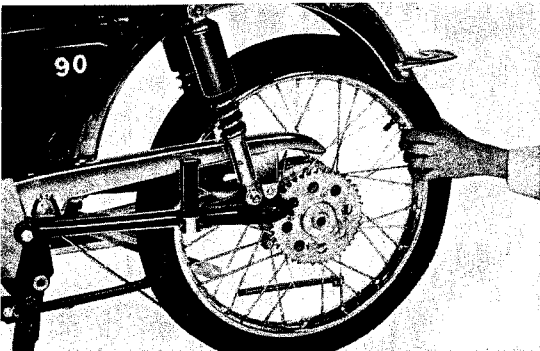

Fig. 111 Rear wheel removal

## A. Disassembly

- 1) Place an appropriate stand under the engine.
- 2) Remove the rear brake rod.
- 3) Unfasten the drive chain link and disconnect the chain.  
(Fig. 110)
- 4) Remove the rear brake arm bolt and then remove the rear brake arm from the brake panel.
- 5) Loosen the nut from the rear axle and remove the rear axle.
- 6) Remove the rear wheel. (Fig. 111)
- 7) Disassemble the brake panel from the wheel hub.  
Remove the brake arm from the panel, pull out the brake cam, disconnect the spring and then remove the brake shoes.
- 8) Straighten the tongued washer on the final driven sprocket, loosen the four mounting bolts, unfasten the circlips and then remove the final driven sprocket.

- 9) Remove the oil seal, ball bearings (see below), and the distance collar from the rear wheel hub.

Ball bearings

CB100, CD100 #6202R and 6302R one

CB125S, CD125S each

SL100, SL125 #6302R two each

#### B. Inspection

- 1) Check for bend in the rear axle.
- 2) Check bearing for wear.
- 3) Check rim runout using a dial gauge.

Item	Standard value	Serviceable limit
Side runout	0.5mm max. (0.0197 in.) max.	3.0mm (0.1181 in.)

True the wheel rim by tightening the spokes if beyond the serviceable limit. If damaged or excessively bent, replace with new one.

- 4) Check wear of brake drum using a caliper. (Fig. 112)

Item	Standard value	Serviceable limit	
Drum inside diameter	CB100 CL100 CB125S CD125S	109.8~110.2mm (4.3229~4.3385in)	112mm (4.4094in.)
	SL100 SL125	110.0~110.3mm (4.3307~4.3425)	

Replace if beyond the serviceable limit.

- 5) Check wear of brake lining. (Fig. 113)

Item	Standard value	Serviceable limit
Lining thickness	3.9~4.1mm (0.1535~0.1614 in.)	2mm (0.0787 in.)

Replace if beyond the serviceable limit.

- 6) Check the spokes for damage, bent and loosening. Tighten the loose spokes, straighten the bent spokes and replace the broken spokes with new one. (Fig. 114)
- 7) Check the brake panel for buckling and other damages. If damaged, replace with new one.
- 8) Check the oil seal for damage, buckling and wear. If worn or damaged, replace with new one.
- 9) Check the tire for damage, and imbedding of wire and nails on both the exterior and interior. If worn or damaged, replace with new one. The tire pressure should be **2.0 kg/cm<sup>2</sup> (28 psi)**.
- 10) Check for air leaks around the valve stem and tube. If leaking, repair or replace with new one.

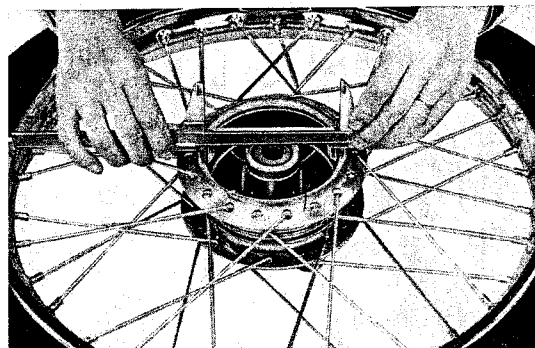

Fig. 112 Rear brake drum measurement

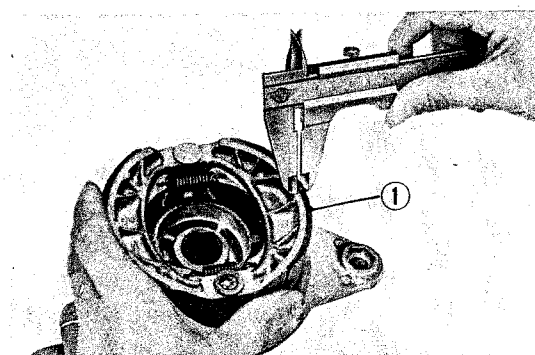

Fig. 113 Brake lining measurement  
① Brake lining

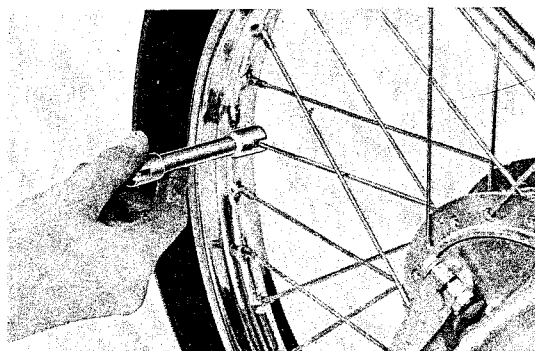

Fig. 114 Spoke retightening

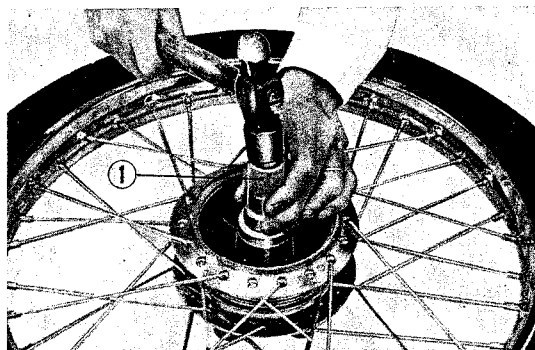

Fig. 115 Ball bearings installation  
① Ball bearing driver

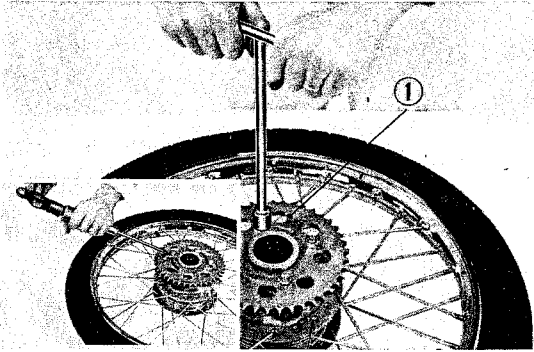

Fig. 116 Final driven sprocket assembly  
① Final driven sprocket

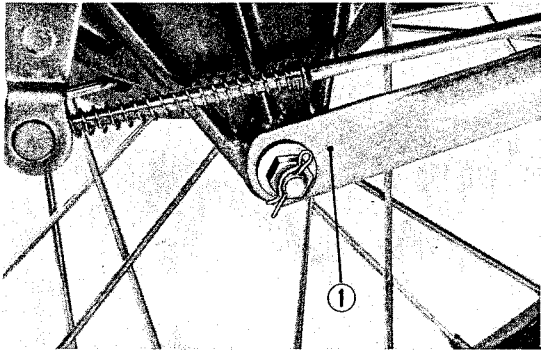

Fig. 117 Brake stopper arm installation  
① Brake stopper arm

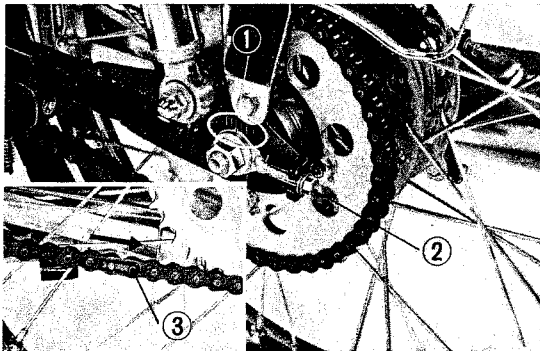

Fig. 118 Drive chain adjustment  
① Index mark and side scale ② Adjuster nut  
③ Drive chain link

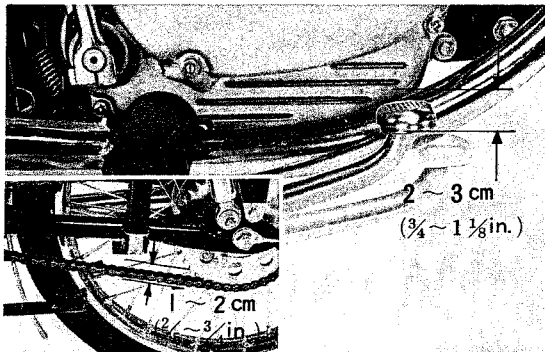

Fig. 119 Chain slack and brake pedal play

### C. Reassembly

- 1) Inflate the tube with a small amount of air and install the tire on the rim by forcing the bead of the tire on the inside of rim.

#### Note:

- After the tire has been assembled, inflate with air to about 1/3 the specified pressure and then tap tire all around with a wooden hammer to relieve any pinching or folds in the tube.
  - After assuring that the valve stem is in alignment with wheel axle, tighten stem lock nut being careful not to cause leaks around the stem.
- 2) Apply grease to the wheel ball bearings and the inside of the wheel hub. Assemble distance collar and ball bearings into the wheel hub. (Fig. 115)
  - 3) Mount the final drive sprocket on the rear wheel hub, install the tongued washers, and nuts. After torquing the nuts, bend the tab on tongued washer to lock it. Finally, install the circlip. (Fig. 116)
  - 4) Mount the brake panel assembly on the rear wheel hub.
  - 5) Assemble the right and left side collars on each side of oil seal and then install rear wheel on the rear fork with the axle.
  - 6) Mount the rear brake stopper arm on the rear brake panel. (Fig. 117)
  - 7) Install and connect drive chain, and after completing the adjustment, tighten the rear axle nut. Chain should be adjusted so that there is 1-2 cm (2/5-3/4 in) slack in the chain (Fig. 119).

#### Note:

The chain joint link must be installed so that the cutout is pointing in the opposite direction to the direction of rotation. When chain is finally adjusted, the chain adjuster indicator on both right and left sides should be at identical locations. (Fig. 118)

- 8) Connect rear brake rod to the brake arm and then make brake adjustments.

#### Note:

The play in the brake pedal should be 2-3 cm (1/4-1-1/8 in.). (Fig. 119).

### 3. STEERING UNIT

#### A. Disassembly

- 1) Disconnect the front brake cable from brake lever.
- 2) Disconnect the clutch cable at the handle clutch lever. (Fig. 120)

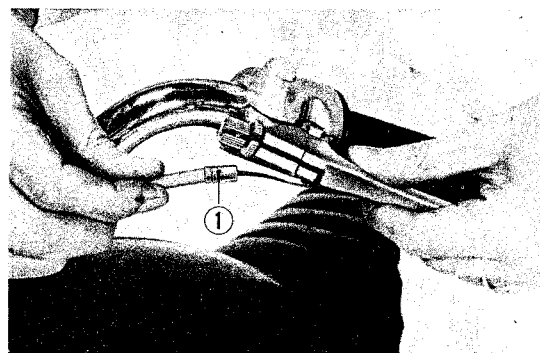

Fig. 120 Clutch cable removal  
① Clutch cable

- 3) (SL100, SL125 U.S.A. Type)  
Remove the combination headlight control and emergency switch by unscrewing two mounting screws. (Fig. 121).
- 4) Disconnect the throttle cable from the throttle grip.

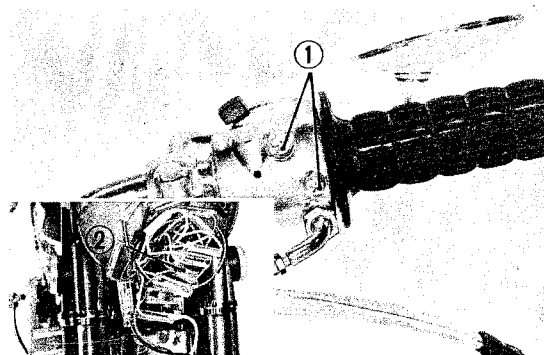

Fig. 121 Emergency switch removal  
① Mounting screws ② Wire harness

- 5) Remove the headlight and disconnect the wire harness in the headlight case. (Fig. 121)
- 6) Loosen four 6mm bolts and remove the handle bar upper holder and handle bar. (Fig. 122)
- 7) Remove the front wheel in accordance with section I.A.
- 8) Remove the headlight case and front fender.

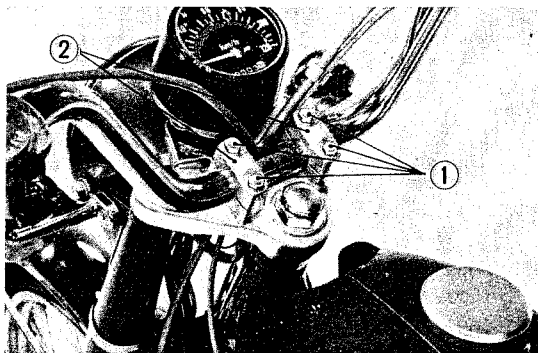

Fig. 122 Handle bar removal  
① 6 mm bolts ② Handle bar upper holder

- 9) (CB100, CL100, CB125S, CD125S)  
Remove the fork bolt, loosen the steering stem mounting bolt, and then drop front fork out the bottom.

#### (SL100, SL125)

Remove four fork top and bottom bridge mounting bolts and drop front fork out the bottom.

- 10) Loosen the steering stem nut and remove the fork top bridge. (Fig. 123)

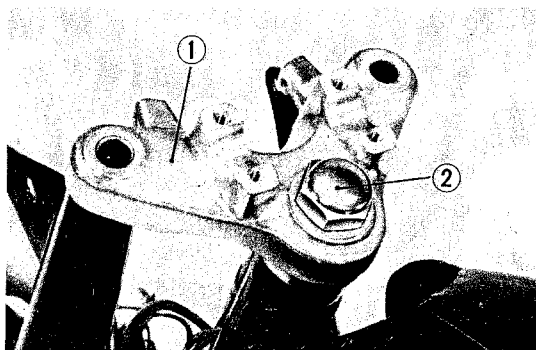

Fig. 123 Fork top bridge removal  
① Fork top bridge ② Steering stem nut

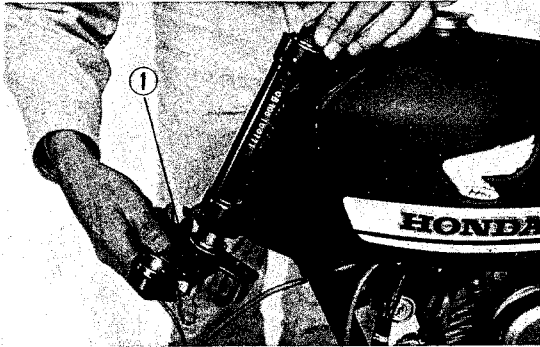

Fig. 124 Steering stem removal  
① Steering stem

### B. Inspection

- 1) Check the condition of both inner cable and casing of the control cables for operation, action and damages. If the cable does not move smoothly, apply grease or replace with new one. If the outer cable is damaged, repair with the plastic tape or replace with new one.
- 2) Check the operation of the throttle grip. If the throttle grip does not move smoothly, apply grease to the throttle hinge. If worn, replace with new one.
- 3) Check the condition of the handle bar for bend and twist. If bent or twisted, straighten or replace with new one.
- 4) Inspect the steel balls for wear and cracks. If worn or damaged, replace with new one.
- 5) Inspect the steering top cone, bottom cone, and the other ball races for galling and wear condition. If worn, replace the cones, races and steel ball together.
- 6) Inspect the steering head dust seal for wear and damage. If worn or damaged, replace with new one.
- 7) Check the steering stem for bend and twist. If slightly bent or twisted, repair with the press. If badly bent or twisted, replace with new one.
- 8) Inspect the threads for damage and deformation. If damaged, replace with new one.
- 9) Check the action of the handle lock return spring. If it does not work properly, replace with new one.

- 11) Loosen the steering head top nut and then drop steering stem out the bottom. (Fig. 124)

When removing steering stem, exercise care not to drop and lose the steel balls (21 pcs. each).

- 12) Remove the two 6mm bolts and separate handle lock from steering stem. Insert engine key into the lock, turn counter clockwise and remove the lock piston.

### C. Reassembly

- 1) Mount the handle lock on the steering stem.
- 2) Apply grease on the ball races and on it set the steel balls. Insert the steering stem into steering head and assemble the top cone race and head top nut.

#### Note:

- Wash the cone race, ball race and steel balls, and apply new grease on the friction surfaces. When assembling parts, exercise care not to drop the steel balls.



- To adjust the head to top nut, first assemble the fork top bridge, front fork, headlight case, front fender and the front wheel in that order; tighten top nut so that the steering handle is neither too tight nor too loose when it is moved fully to the right and left.
- 3) Install the fork top bridge, front fork and wheel.
- 4) Reconnect the throttle, clutch and front brake cables.
- 5) Route the wire harnesses and control cables through their respective positions and then install the steering handle.

**Note:**

Check to make sure that the harnesses and cables are not binding when the steering handle is moved fully to both sides.

- 6) Reconnect all wire harnesses.
- 7) Adjust the play in all the cables. (Fig. 125, 126)

**Throttle cable**

(twist grip to full travel) 90°—100°  
(play) 10°—15°

Front brake cable (at end of lever)  
2-3 cm (3/4-1-1/8 in.)

Clutch cable (at end of lever)  
1-2 cm (2/5-3/4 in.)

#### 4. FRONT SUSPENSION

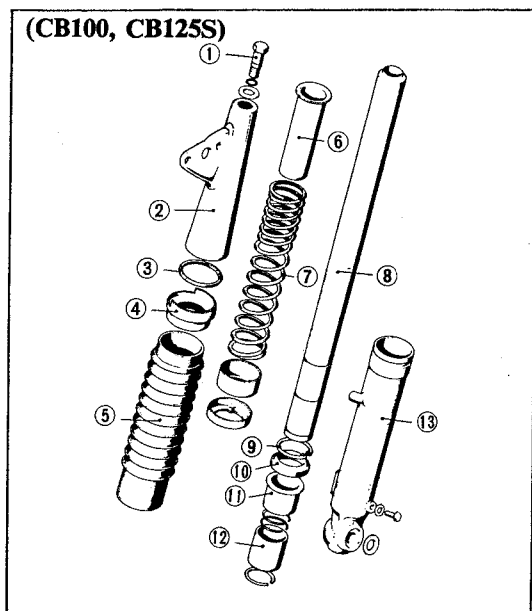

Fig. 127 CB100, CL100

- ① Front fork bolt ② Front fork upper cover ③ Fork cover lower seat packing ④ Fork cover lower seat ⑤ Front fork under cover (CB100), Front fork boot (CL100) ⑥ Front fork spring guide ⑦ Front fork spring ⑧ Front fork pipe ⑨ 37 mm circlip ⑩ Front fork oil seal ⑪ Front fork pipe guide ⑫ Front fork piston ⑬ Front fork bottom pipe

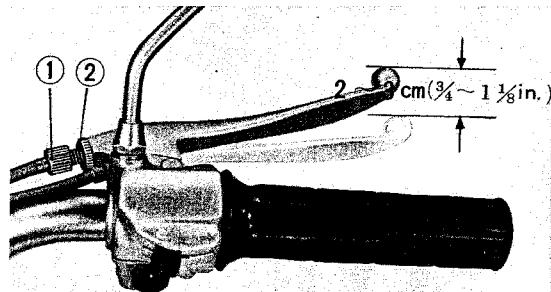

Fig. 125 Brake cable play adjustment

- ① Adjuster nut ② Lock nut

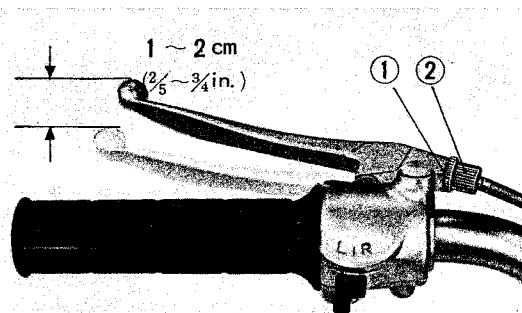
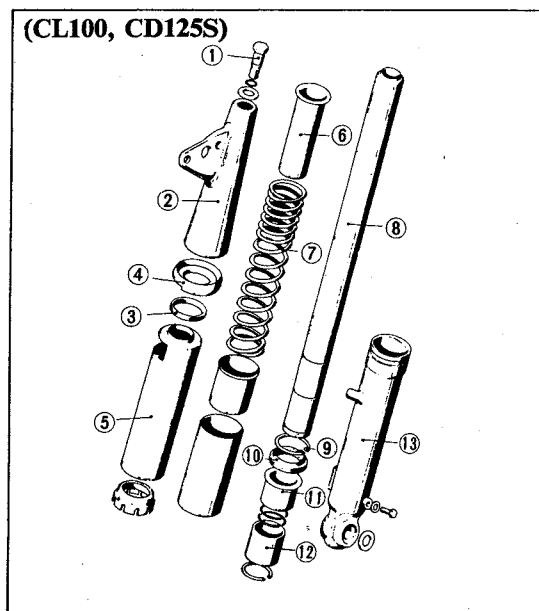

Fig. 126 Clutch cable play adjustment

- ① Lock nut ② Adjuster nut



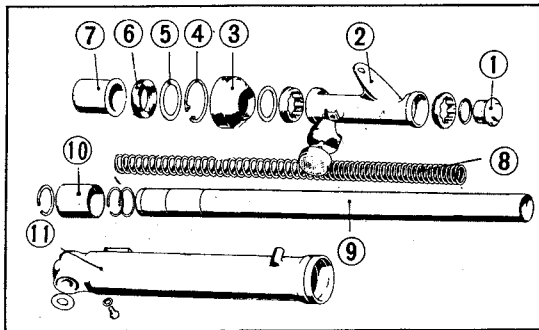

Fig. 128 ① Front fork bolt ② Front fork upper cover  
③ Front fork dust seal ④ 44 mm circlip ⑤ Back  
up ring ⑥ 31×43×10 oil seal ⑦ Front fork pipe  
guide ⑧ Front fork spring ⑨ Front fork pipe  
⑩ Front fork piston ⑪ Front fork bottom case

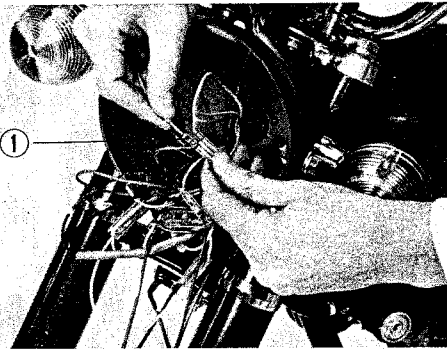

Fig. 129 ① Turn signal connector

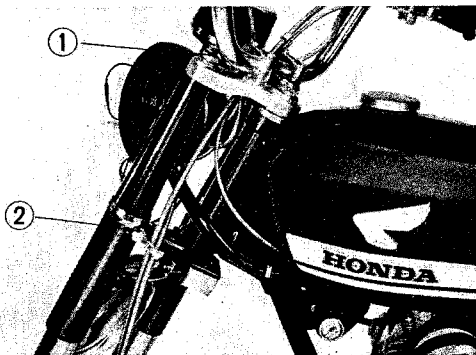

Fig. 130 Front fork removal  
① Front fork bolt ② Fork mounting bolt

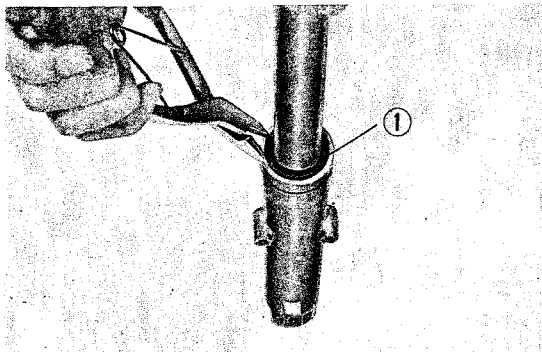

Fig. 131 Circlip removal  
① Circlip

### A. Construction

It is of a telescopic design with bottom case made of alluminium alloy to reduce unsprung weight. The long stroke provides good stability and handling on rough roads.

The oil damper is filled with SAE 10W-30.

Item	CB100, CL100	SL100	CB125S, CD125S	SL125
Stroke	108.5mm (4.2716 in.)	160mm (6.2992 in.)	114.3mm (4.5000 in.)	142mm (5.5118 in.)

### B. Disassembly

- 1) Remove the front wheel in accordance with section 1.A
- 2) **(CB100, CL100, CB125S, CD125S)**  
Remove the headlight case, disconnect the turn signal connector within the case and remove the turn signal. (Fig. 129)
- 3) Loosen the headlight case mounting bolts from both sides and remove the case from the fork upper case.
- 4) **(CB100, CL100, CB125S, CD125S)**  
Unscrew four fender mounting bolts and remove the fender from the fork.
- 5) **(CB100, CL100, CB125S, CD125S)**  
Remove the front fork bolt, loosen the steering stem fork mounting bolt and then remove the fork. (Fig. 130)  
**(SL100, SL125)**  
Loosen the fork top bridge and steering stem front fork mounting bolt and then remove the fork out the bottom.
- 6) Loosen oil drain plug from the bottom case and drain oil.
- 7) **(CB100, CL100, CB125S, CD125S)**  
Remove the front fork under cover or front fork boot, circlip (37 mm dia.), and then disassemble the fork bottom case. (Fig. 131)  
**(SL100, SL125)**  
Remove the dust seal, circlip (44mm dia.), and then disassemble the fork bottom case.

### C. Inspection

#### 1) Front fork spring. (Fig. 132)

Item	Standard value		Serviceable limit
Free length	CB100 CL100	184mm (7.2440 in.)	160mm (6.2992 in.)
	SL100	484.2mm (19.0629 in.)	460mm (18.1102 in.)
	CB125S CD125S	205.5mm (8.0905 in.)	180mm (7.0866 in.)
	SL125	482.3mm (18.9881 in.)	460mm (18.1102 in.)

Replace if beyond the serviceable limit.

#### 2) Wear of front fork piston.

Item	Standard value		Serviceable limit
Outside diameter	CB100 CL100 CB125S CD125S	30.936-30.975mm (1.2174-1.2194 in.)	30.9mm (1.2165 in.)
	SL100 SL125	35.425-35.450mm (1.3946-1.3956 in.)	35.4mm (1.2937 in.)

Replace if beyond the serviceable limit.

- 3) Check the front fork oil seal for damage. If damaged, replace with new one.
- 4) Check the front fork pipe and bottom case for bend or crank. If badly damaged, replace with new one.

### D. Reassembly

- 1) Assemble piston stopper and piston on the front fork pipe.
- 2) Fill front fork bottom case with SAE 10W-30.

**CB100, CL100, CB125S, CD125S:**

130-140cc (4.4-4.7 ozs)

**SL100, SL125: 180-190cc (6.1~6.4 ozs)**

#### 3) (CB100, CL100, CB125S, CD125S)

Insert the front fork pipe assembly into the bottom case, install the oil seal and circlip, and assemble the front fork spring into the fork pipe so that the end with the large pitch is at the bottom. (Fig. 134)

**(SL100, SL125)**

Place the large pitch end of the front fork spring into the bottom case, insert the front fork pipe and assemble the oil seal and circlip.

#### 4) (CB100, CL100, CB125S, CD125S)

Attach the front fork upper and lower covers or fork boots, and install the front fork as a unit. Tighten the front fork bolt and mounting bolt. Attach the front fender

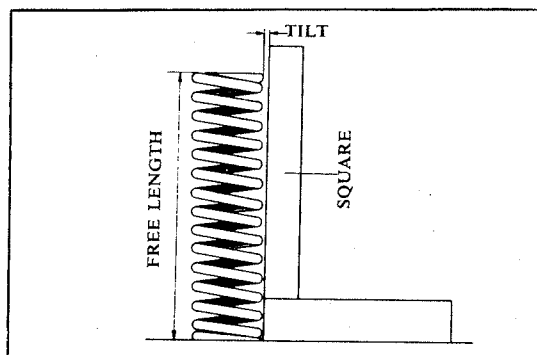

Fig. 132 Spring free length measurement

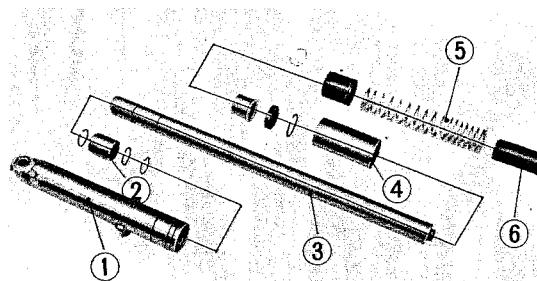

Fig. 133 ① Front fork bottom pipe ② Fork piston  
③ Front fork pipe ④ Bottom case cover  
⑤ Front fork spring ⑥ Front fork spring guide

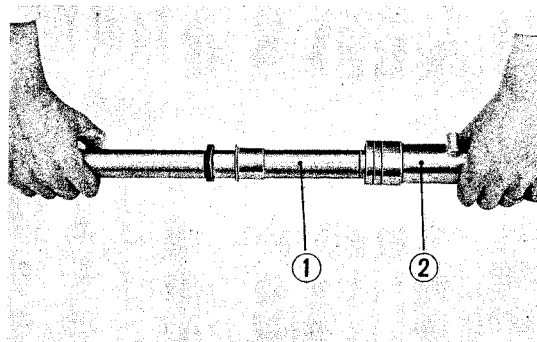

Fig. 134 Front fork assembly  
① Front fork pipe ② Front fork bottom pipe

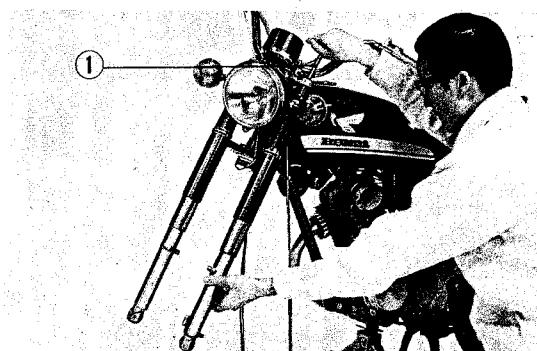

Fig. 135 Front fork installation  
① Front fork puller

**(SL100, SL125)**

Attach the headlight case stay between the fork top bridge and steering stem and install the front fork as a unit.

Tighten the front fork mounting bolts.

- 5) Install the headlight case.

**5. REAR SUSPENSION**

Fig. 136 CB100, CL100, CB125S, CD125S



SL100, SL125

**CB100, CL100, CB125S, CD125S**

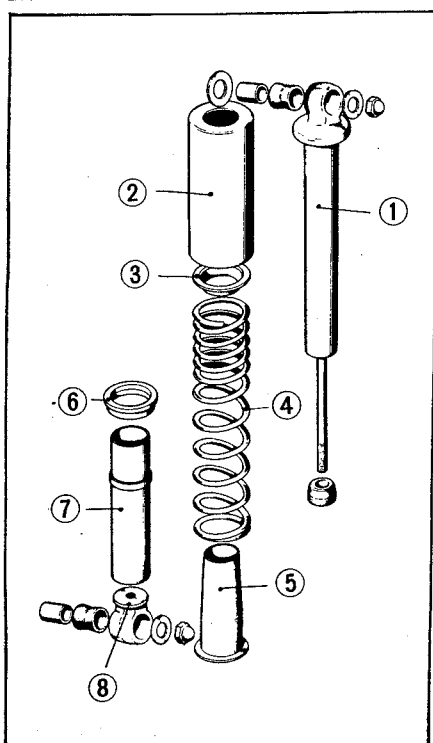
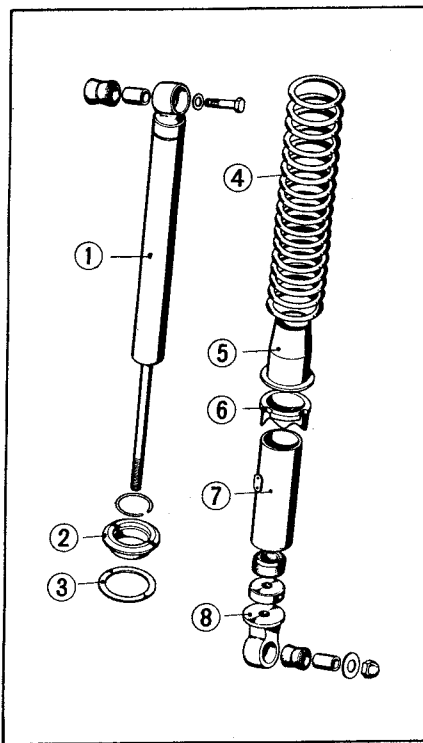
- ① Rear shock absorber
- ② Rear shock absorber upper case
- ③ Rear shock absorber upper seat
- ④ Rear shock absorber spring
- ⑤ Rear shock absorber spring guide
- ⑥ Rear shock absorber spring seat
- ⑦ Rear shock absorber under seat
- ⑧ Rear shock absorber bottom metal

**SL100, SL125**

- ① Rear shock absorber
- ② Rear shock absorber spring seat stopper
- ③ Rear shock absorber spring upper seat
- ④ Rear shock absorber spring
- ⑤ Rear shock absorber spring guide
- ⑥ Rear shock absorber spring adjuster
- ⑦ Rear shock absorber end case
- ⑧ Rear shock absorber bottom metal

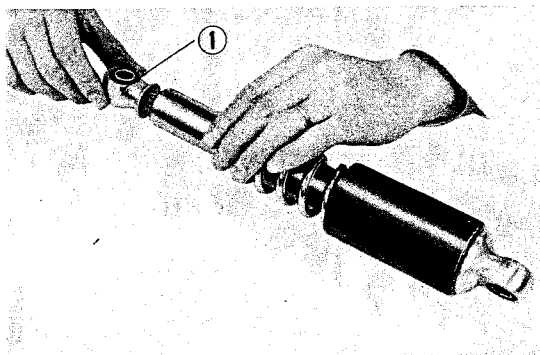

Fig. 137 Rear shock absorber disassembly  
① Bottom metal

**A. Disassembly**

- 1) Remove the rear wheel in accordance with section 2.A.
- 2) Unscrew the two rear shock absorber mounting cap nuts and remove the shock absorber from the frame and rear fork.
- 3) Remove the rear shock absorber bottom metal and then separate the spring and upper case (Fig. 137)
- 4) Remove the chain case.
- 5) Loosen the rear fork pivot nut, extract the rear fork pivot bolt and then remove the rear fork.
- 6) Remove the cotter pin and nut and then remove the rear brake stopper arm from the rear fork.

## B. Inspection

### 1) Rear shock absorber spring.

Item	Standard value	Serviceable limit	
Free length	CB100 CL100 CB125S CD125S	180.9mm (7.1200 in.)	160mm (6.2992 in.)
	CL100 SL125	190mm (7.4803 in.)	170mm (6.6929 in.)

Replace if beyond the serviceable limit.

- 2) Check the shock absorber for oil leaks. If leaks from inside of body, replace the body with new one.
- 3) Check the main damper body for damage or deformation and damper action. If damaged or shock absorber action is not satisfactory, replace with new one. The shock absorber cannot be disassembled and repaired.
- 4) Check the shock absorber case and stopper for damage. Replace if damaged.
- 5) Clearance between the rear fork pivot bushing and bolt.

Item	Standard value	Serviceable limit
Clearance	0.1-0.3mm (0.0031-0.0118 in.)	0.5mm (0.0196 in.)

Replace if beyond the serviceable limit.

- 6) Check the pivot shaft for bend or damage. Straighten the bent shaft and check with the dial gauge. If damaged, replace with new one.
- 7) Check the rear fork swing arm for bend, twist and crack. If slightly bent or twisted, straighten with press and check the swinging arm with the dial gauge. If damaged, replace with new one.

## C. Reassembly

- 1) Install the rear brake arm stopper on the rear fork.
- 2) Insert the grease coated pivot bushing into the rear fork and install this on frame with the rear fork pivot bolt. (Fig. 139)
- 3) Install the chain case on the rear fork, join the rear shock absorber complete to the frame and fork, install and tighten cap nuts.
- 4) Install the rear wheel.

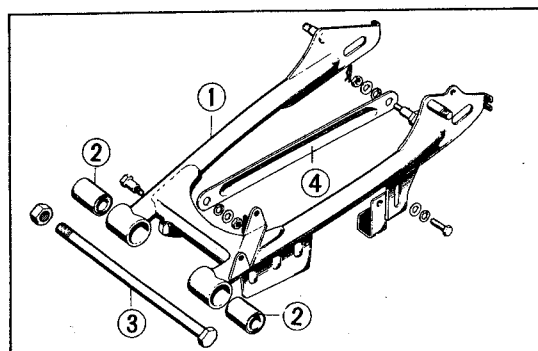

Fig. 138 ① Rear fork ② Rear fork pivot rubber bush  
③ Rear fork pivot bolt ④ Rear brake stopper arm

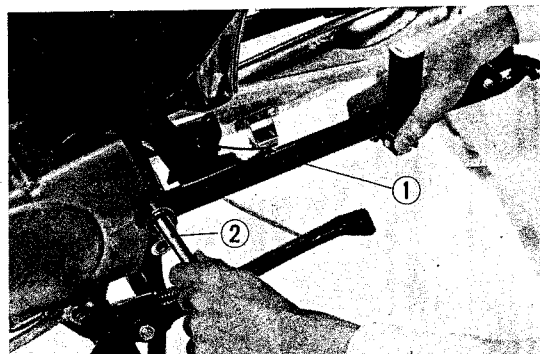

Fig. 139 Rear fork assembly  
① Rear fork ② Rear fork pivot bolt

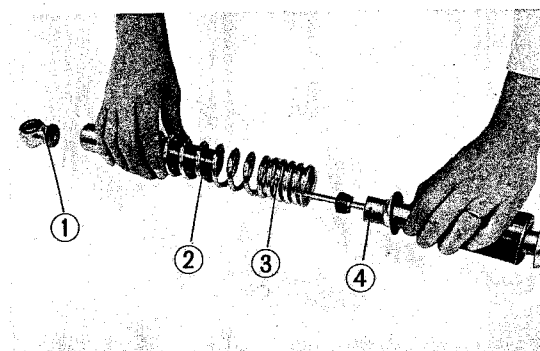

Fig. 140 Rear shock absorber assembly  
① Bottom metal ② Spring guide  
③ Shock absorber spring ④ Shock absorber body

### Note:

- When assembling the rear shock absorber complete, the large pitch end of spring goes toward the top. (Fig. 140)
- After completing installation, adjust the tension of drive chain and the rear brake.

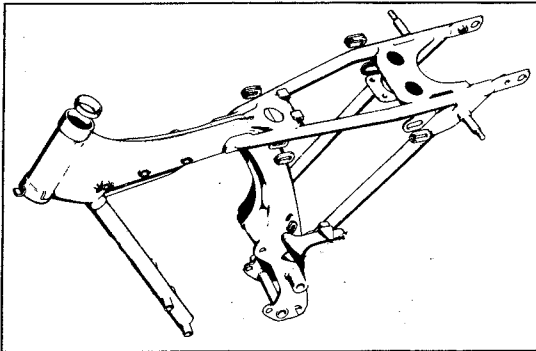

Fig. 141 CB100, CL100, CB125S, CD125S Diamond frame

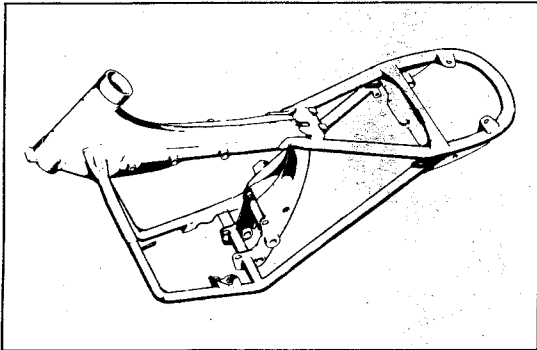

Fig. 142 SL100, SL125 Double cradle frame

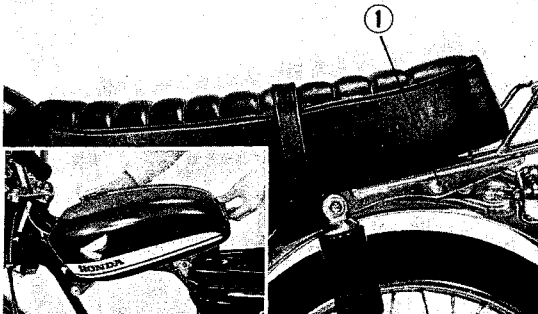

Fig. 143 Seat and fuel tank removal  
① Sub-carrier mounting bolt

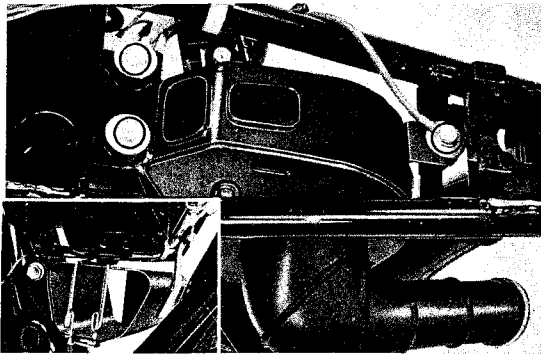

Fig. 144 Air cleaner and tool box removal

## 6. FRAME BODY

### A. Construction

Half frame, half pillar, is made of high strength press steel sheet. The CB100, CL100, CB125S and CD125S are designed with the aim for light weight. It utilizes a diamond frame. The SL100 and SL125 are designed with a sporty double cradle frame.

### B. Disassembly

- 1) Remove the engine in accordance with section engine removal and installation.
- 2) Remove the steering handle in accordance with section 3.A.

#### 3) (CB100, CL100, CB125S, CD125S)

Detach the sub-carrier and then remove the seat. (Fig. 143)

#### (SL100, SL125)

Loosen the seat mounting nuts and remove the seat.

- 4) Position the fuel cock lever to STOP position, disconnect the fuel tube from carburetor, and then remove the fuel tank by pulling toward the rear and slightly upward. Remove the strainer cup, take out the strainer screen and packing and remove the mounting screws to detach it from the fuel tank. (Fig. 143)

- 5) Disassemble the air cleaner and tool box. (Fig. 144)

- 6) Remove the front wheel and front suspension in accordance with section 1.A and 4.B.
- 7) Remove the rear wheel and rear cushion in accordance with section 2.A and 5.A and then remove the rear fender.
- 8) Disassemble the electrical system.
- 9) **(CB100, CL100, CB125S, CD125S)**  
Extract the cotter pin in the main stand pivot pipe, pull out the pivot pipe and remove the stand from the frame. (Fig. 145)

### C. Inspection

- 1) Inspect the welded joints, crack, damage or twist to the pipe. Straighten the minor dent or twisting, weld the crack and paint the worn or scratched parts. Replace twisted or badly dented frame with new one.
- 2) Inspect the top and bottom races for damage and wear.

#### Note:

The ball race can be driven out easily by using a wooden drift from the inside. Exercise care when installing the race so that it is driven in straight and to the full depth. (Fig. 146)

- 3) Check the angle of head pipe and lock for any damage. If damaged, replace with new one.
- 4) Check damage to the seat leather upholstery. If damaged, repair or replace with new one.
- 5) Check for fuel tank leak, clogged fuel filler cap vent, damage or deformed cock valve packing, strainer cup packing and aging or damage to the fuel tube. Flush out interior of the tank with clean gasoline.
- 6) Clean the air cleaner element by blowing off dust with compressed air or wash in soap water. (Fig. 147)
- 7) Replace any exhaust pipe gasket which is damaged.  
Check the muffler for cracks and deformation. If badly damaged, replace with new one. Remove the carbon from the diffuser pipe and clean.
- 8) Check the stand spring for deformation and damage. If the part has lost tension or damaged, replace with new one.

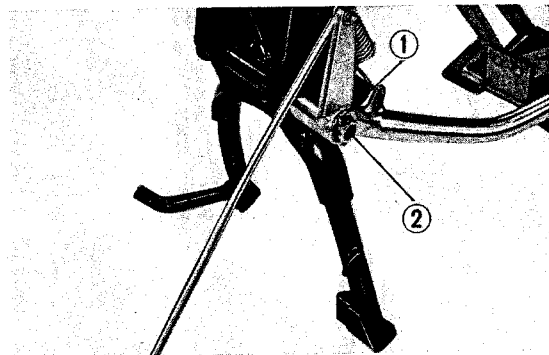

Fig. 145 Stand removal  
① Cotter pin ② Main stand pivot pipe

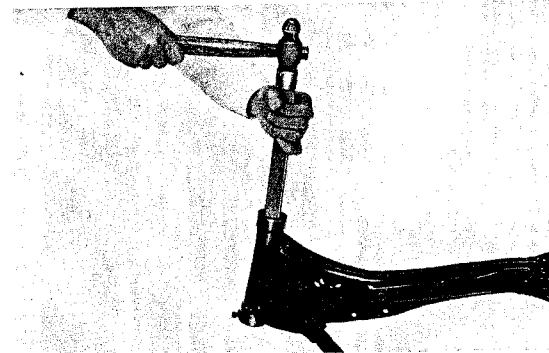

Fig. 146 Ball race removal

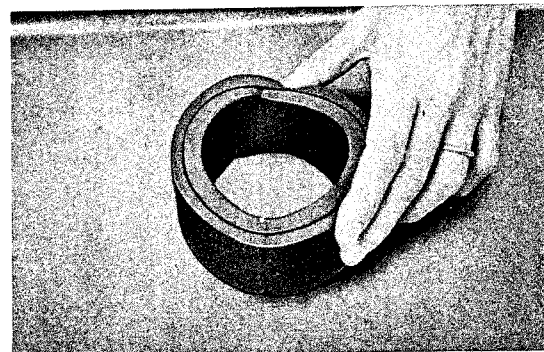

Fig. 147 Air cleaner element cleaning

**D. Reassembly****1) (CB100, CL100, CB125S, CD125S)**

Mount the main stand and brake pedal to the frame together

**(SL100, SL125)**

Mount the brake pedal on the main stand pivot pipe.

2) Mount the rear fender on the frame and install the electrical equipment.

3) Install the rear fork, rear shock absorber, and rear wheel.

4) Install the steering stem, front fork and the front wheel.

**5) (CB100, CL100, CB125S, CD125S)**

Install the fuel tank, seat and sub-carrier on the frame.

**(SL100, SL125)**

Install the fuel tank and seat on the frame.

6) Mount the engine on the frame.

7) Route the respective control cables, and wire harnesses through the specified positions and complete the connections.

**Note:**

**Adjust the brakes, clutch and drive chain slack and check the steering operation.**



## 1. GENERATING SYSTEM

The charging system is an A.C. generator (magnetic single phase A.C. generator) which consists of the stator and rotor. The A.C. generator is rectified by the selenium rectifier and is used to charge the battery.

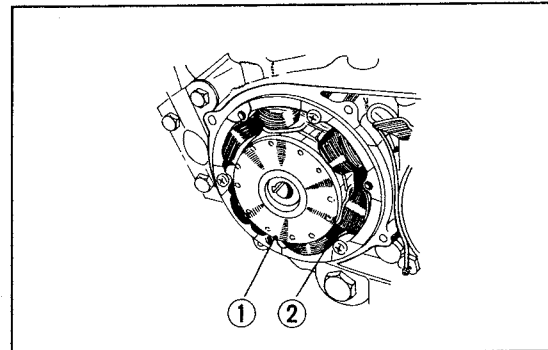

Fig. 148 ① Rotor ② Stator

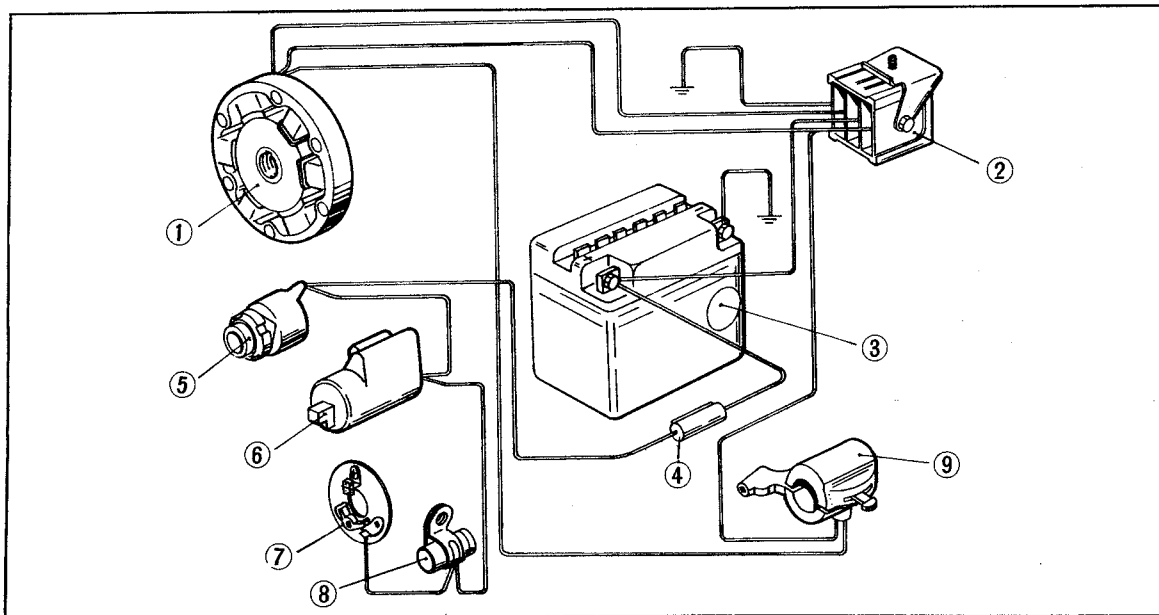
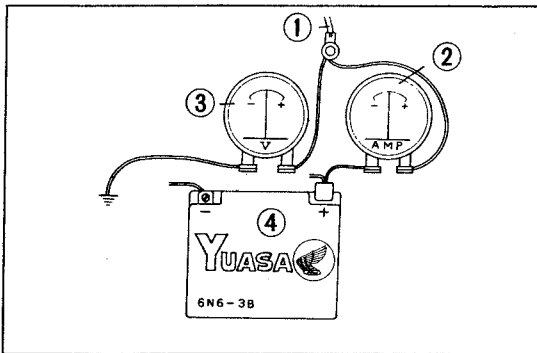

Fig. 149 ① A.C. generator ② Selenium rectifier ③ Battery ④ Fuse ⑤ Combination switch ⑥ Ignition coil ⑦ Braker points  
⑧ Condenser ⑨ Lighting switch

### A.G. GENERATING SPECIFICATIONS

Type & manufacturer	Rotary type. Kokusan Denki or Nippon Denki
Output	6V50W (at 5,000 rpm in night)
Battery voltage	6V-6A
Changing rpm	500-12,000 rpm
Polarity of ground	⊖
weight	1.45kg (3.20 lbs)

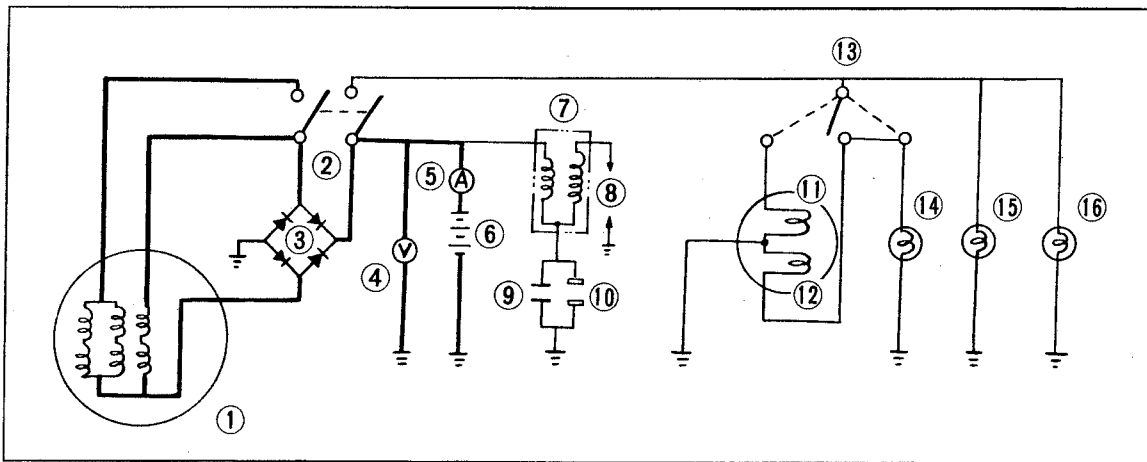

**Fig. 150 Charging test**  
 ① Red/white wire harness ② Ammeter  
 ③ Voltmeter ④ Battery

## 2. CHARGING SYSTEM

### A. Charging test

- 1) Use the ammeter-and-voltmeter.
- 2) Measure the specific gravity of the electrolyte in battery. If it is below 1.26 (corrected to 20°C.), recharge the battery. Its normal value is 1.28 (corrected to 20°C) Perform the following test.
- 3) Disconnect the red/white wire harness terminal from the ⊕ terminal of the battery and connect it to the ⊖ terminal of the ammeter. Connect the ⊕ terminal of battery to the ⊖ terminal of ammeter. Connect the red/white wire harness to the ⊕ terminal of the voltmeter and ground the ⊖ terminal of the voltmeter to earth.
- 4) Start the engine and perform the following two tests in both the day and night operation mode. (Fig. 150)
- 5) Measure the battery voltage and charging current. If they are less than values shown in the following table, check or replace the stator, selenium rectifier, ignition coil and condenser with new one.



**Fig. 151** ① A.C. generator ② Lighting switch ③ Selenium rectifier ④ Voltage meter ⑤ Ammeter ⑥ Battery 6V-6AH ⑦ Ignition coil ⑧ Spark plug ⑨ Condenser ⑩ Contact breaker ⑪ Headlight high beam ⑫ Headlight low beam ⑬ Dimmer switch ⑭ Highbeam pilot light ⑮ Tail/stop light ⑯ Meter light

	Lighting switch		Dimmer switch	Initial charging r.p.m.		5000 r.p.m.	
				r.p.m.	Battery Voltage	Charging current	Battery Voltage
100cc Series	Day	OFF	OFF	1000 r.p.m.	6.8 V	1.3 A	7.8 V
	Night	ON	HB (high beam)	3500 r.p.m.	6.8 V	1.3 A	7.8 V
		ON	LB (low beam)	2200 r.p.m.	6.8 V	1.3 A	7.2 V
125cc Series	Dry	OFF	OFF	1000 r.p.m.	6.8 V	1.7 A	7.9 V
	Night	ON	LB (low beam)	2000 r.p.m.	6.8 V	1.3 A	7.8 V

## B. Inspection

### 1) Stator coil test

Perform a continuity test on the three stator coil harnesses (orange, white, yellow) with a tester to determine the condition of the coil and also inspect for exterior damage. Replace with new one if there is not continuity or damaged. (Fig. 152)

#### Note:

**Do not test on a metal bench.**

### 2) Selenium rectifier test

Check the continuity in the normal direction and also in the reverse direction by applying tester lead probes to green and pink leads, pink and red/white leads, green and yellow leads, and yellow and red/white leads respectively and alternately as shown in the figure. The rectifier is in good condition if continuity exists only in one direction. If there is continuity in both directions or no continuity in either direction when tested, the rectifier is defective and should be changed. (Fig. 153-154)

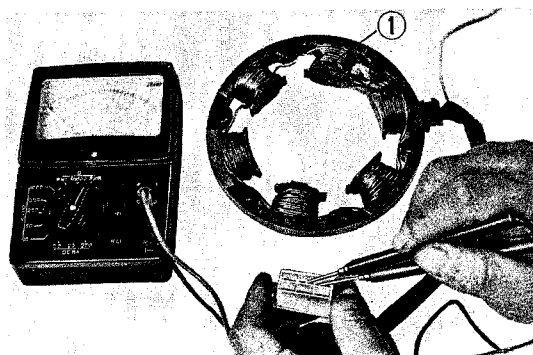

Fig. 152 Stator coil test  
① Stator coil

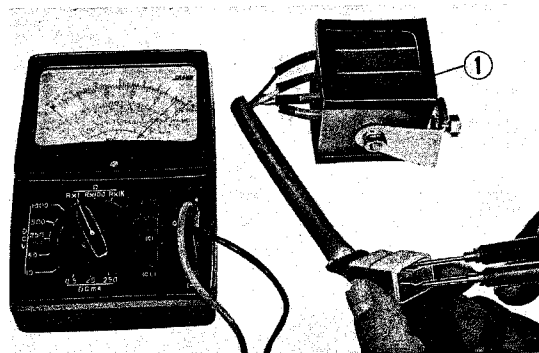

Fig. 153 Selenium rectifier continuity test  
① Selenium rectifier

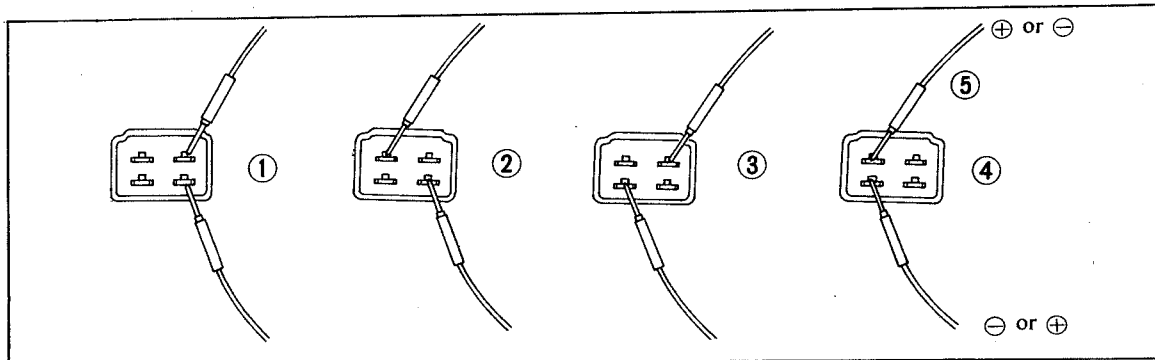

Fig. 154 ① Green and pink leads ② Pink and red/white leads ③ Green and yellow leads ④ Red/white and yellow leads  
⑤ Tester leads

## 3. IGNITION SYSTEM

### 1) Ignition coil test

- ① Perform functional test of the ignition coil to determine its condition. When poor starting is experienced, the cause may also be found by testing the spark plug, contact breaker points, condenser, etc.
- ② Check the ignition coil using the service tester.
- ③ Connect the battery power source to the tester and ground the grounding lead. (Fig. 156)

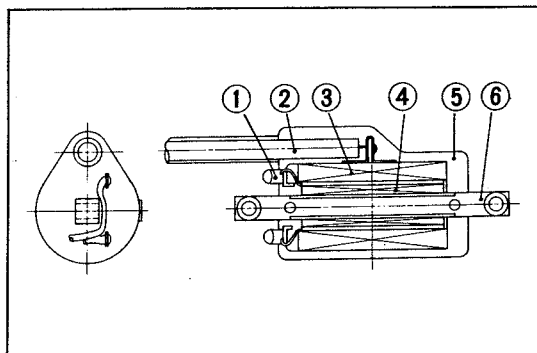

Fig. 155 ① Secondary coil terminal ② Ignition cord  
③ Secondary coil ④ Primary coil ⑤ Body ⑥ Core

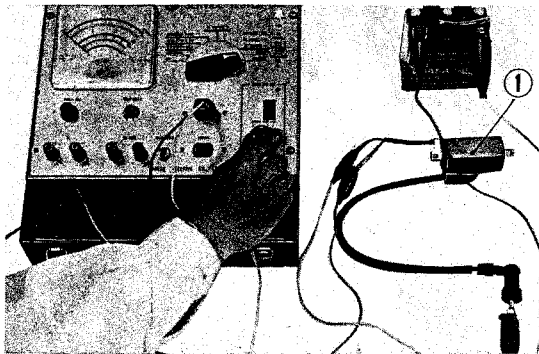

Fig. 156 Ignition coil test  
① Ignition coil

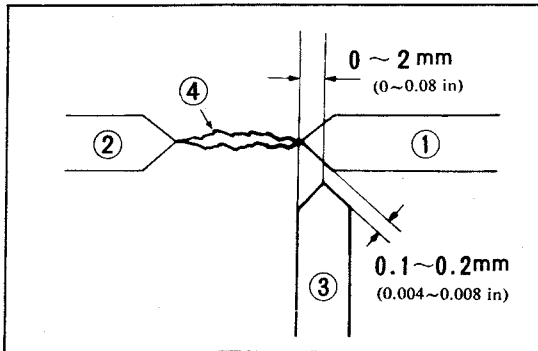

Fig. 157 ① No.1 electrode ② No.2 electrode  
③ No.3 electrode ④ Spark

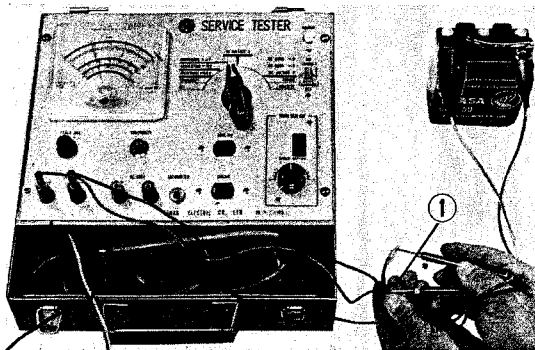

Fig. 158 Condenser test  
① Condenser

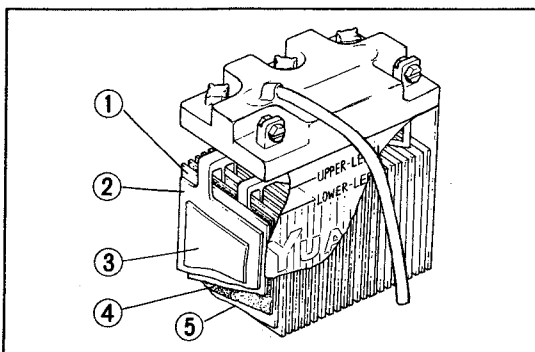

Fig. 159 Battery construction  
① Separator plate ② Cathode plate ③ Separator plate  
④ Glass mat ⑤ Anode plate

- ④ Connect the ignition primary cord to the tester and connect the opposite terminal end to the primary terminal of the coil. Connect the white lead with (∧) type plug to the blue terminal of the ignition coil (primary side) and the red tester lead to the black terminal of the ignition coil. (Fig. 156)
- ⑤ Connect the red tester high tension cord to the high tension cord of the ignition coil.
- ⑥ Turn the selector knob to the COIL TEST position.
- ⑦ Adjust the three point spark tester to maintain maximum distance of spark by turning the control knob while observing the spark condition and then measure the spark distance.
- ⑧ If the spark plug distance is less than 6 mm (0.24 in.), the spark plug is un-serviceable.

2) Condenser test (Fig. 158)

- 1) Connect the 6V battery power source to the tester.
- 2) Turn the selector knob to the "CONDENSER" position.
- 3) Apply one of the tester lead probes to the condenser body, and then read the meter indication. If it measures between 0.21-0.26  $\mu$ F, the condenser is satisfactory. Condenser indicating less than 0.21  $\mu$ F should be replaced.

4. BATTERY

A. Construction

The construction and name of the component parts are shown in the figure. The type of battery having the specifications shown below is installed in these models. (Fig. 159)

Type	6N6-3B
Voltage	6V
Capacity	6AH (at 10 hr rate)
Charging current	0.6A
Specific gravity of electrolyte (when fully charged)	1.260-1.280 at 20°C (68°F)

## B. Inspection and Servicing

1) Measure the specific gravity of the battery electrolyte with a hydrometer and if it is below 1.200 (corrected to 20°C), the battery should be recharged. The specific gravity is calibrated on the stem of the float and the reading is taken at the fluid level with the float buoyant. (Fig. 160)

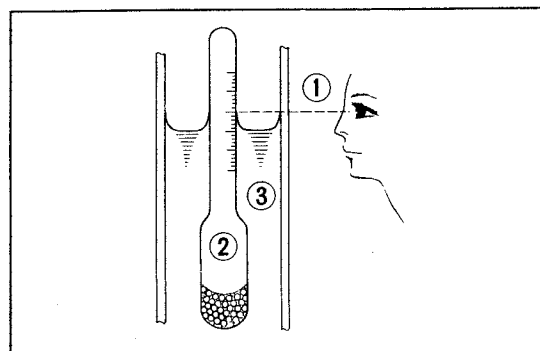

Fig. 160 ① Eye level ② Hydrometer ③ Battery electrolyte

2) If any cell is found to be below the lower level mark on the battery case, add distilled water to bring the level up to the upper level mark. If the electrolyte evaporation rate is unusually great, the charging system should be checked for possible malfunction. If the battery case is cracked or damaged, replace with new one.

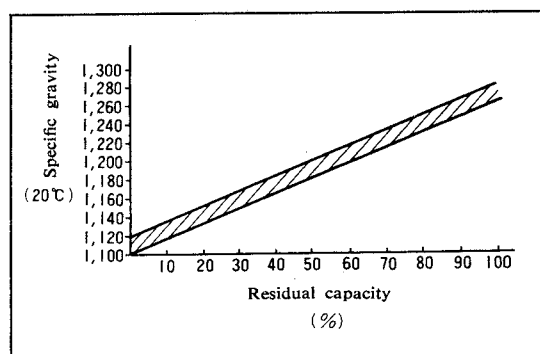

Fig. 161 Relation between specific gravity of battery electrolyte and electrical capacity

3) Check the poor battery connection due to corrosion of the connector and terminal, flaking of the paste from vibration and sulfation. The flaked paste remains on bottom remarkably, replace with new one. (Fig. 162)

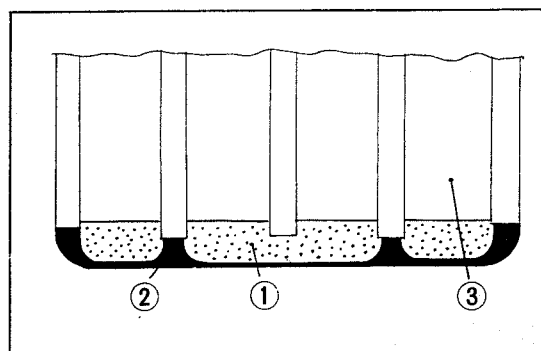

Fig. 162 ① Flaked paste ② Bottom ③ Cathode plate

## C. Battery Charging

- 1) Quick-charge method of charging the battery will seriously effect the battery service life, therefore, it is recommended that this method not be used. When the rapid charge is required, the battery should be recharged at a rate of 0.2 AH.
- 2) During the charging process, hydrogen gas will be generated, therefore, open flame should be kept away.
- 3) After the recharging is completed, the battery should be washed with water to remove spilled electrolyte and the terminals coated with grease.

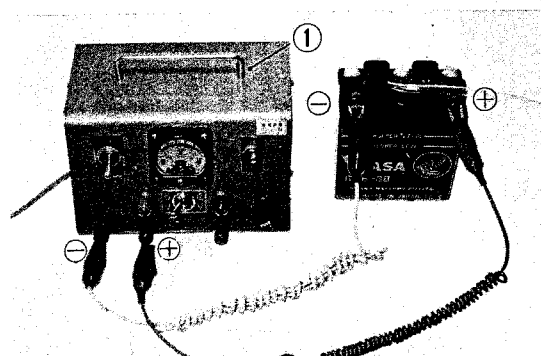

Fig. 163 Battery charging  
① Battery charger

	Normal charge	Rapid charge
<b>Charging current rate</b>	0.6AH	2.0AH max.
<b>Checking for full charge</b>	(1) Specific gravity: 1.260-1.280 (20°C: 68°F) maintained constant (2) 0.2AH→0.6AH (3) 7.5V→8.3V	(1) Specific gravity: 1.260-1.280 maintained at 20°C(68°F) (2) Voltage: When large volume of gas is emitted from the battery (in about 2-3 hours for fully discharged battery), reduce charging rate to 0.2A. Battery is fully charged when a voltage of 7.5V is maintained.
<b>Charging duration</b>	By this method, a battery with specific gravity of electrolyte below 1.220 at 20°C (68°F) will be fully charged in approximately 12-13 hours.	By this method, battery with specific gravity of electrolyte below 1.220 at 20°C (68°F) will be fully charged approximately 1-2 hours.
<b>Remarks</b>		When the charging is urgent, quick charging method may be used, however, the recommended charging current rate should be under 2.0A.

**Note:** Battery should not be charged near open fire.  
Terminals should be cleaned with clean water. Apply grease.

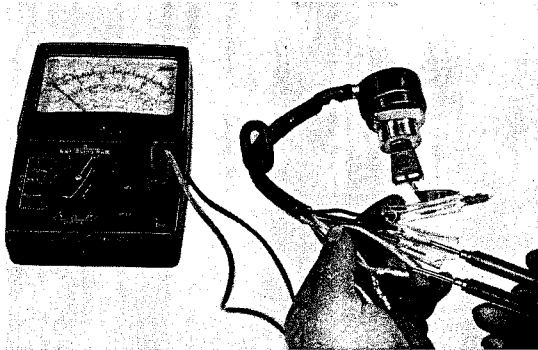

Fig. 164 Combination switch continuity test

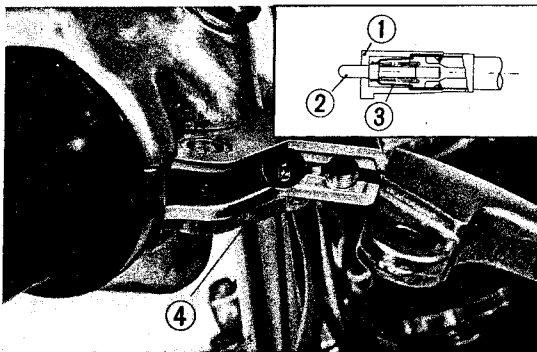

Fig. 165 ① Switch case ② Shaft ③ Contact plate  
④ Front stop switch

## 5. AUXILIARY ELECTRICAL EQUIPMENT

### A. Inspection

#### 1) Combination switch (Fig. 164)

If continuity exists in any other leads than those shown below, first make sure the wiring harness is connected correctly. If the wiring is correct, the switch is defective. Check by the testing conductivity of wires with the switch in each positions. Replace with new one if the conductivity is not correct.

CB100, CL100, CB125S, CD125S, SL100, SL125

	BAT	IG <sub>1</sub>	IG <sub>2</sub>	HO	SW	WL <sub>1</sub>	WL <sub>2</sub>	BAT	IG
OFF					○—○—○				
ON	○—○—○			○—○				○—○	

#### 2) Front stoplight switch (Fig. 165)

Check the front stop light switch for continuity by applying the tester lead probe to the black and green/yellow-green switch lead and depress the brake lever. If there is no continuity, the switch is defective.

Also check the action of switch manually.

#### Note:

- Check brake lever for excess play.
- Light should only operate by the brake lever.

3) Rear stop switch

Check the rear stop switch spring for disengagement. Apply tester lead probes to the green/yellow and black lead to check continuity.

The light should come on when the brake pedal is depressed 2cm (0.78 in.).

Turning the adjuster nut clockwise will delay the switch engagement. (Fig. 166)



Fig. 166 Rear stop switch  
① Adjuster nut

4) Horn

Connect a 6V battery to the horn to test its operation.

The sound volume can be adjusted with the adjusting screw provided on the back of the horn. (Fig. 167)

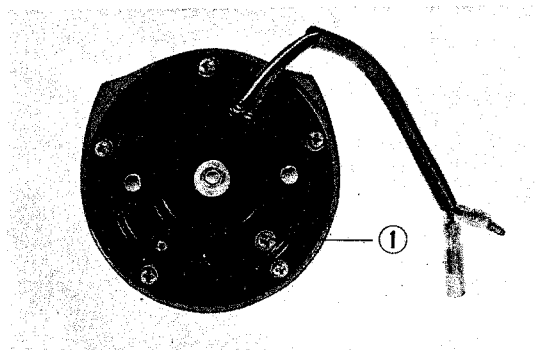

Fig. 167 Horn  
① Volume adjusting screw

5) Horn button switch

Check the continuity of the switch by applying the tester lead probes to the light green cord within the headlight case and to the handle bar. Continuity should exist when the button is pressed. (Fig. 168)

6) Turn signal switch

Disconnect the turn signal switch leads in the headlight case and check the continuity by connecting the gray switch lead to one of the tester probes and applying the other tester lead probe to the blue and orange switch leads alternately and operating the switch. If continuity exist in both positions, the switch is satisfactory. However, if there are continuity in the position other than shown on the chart, the switch is defective. If the both turn signal lamps on one side do not light up or if all lamps on both side light up, the switch or wiring is defective. If the switch and wiring are not defective and no turn signal lamps turn on, the relay is defective. Replace the relay with new one. (Fig. 169)

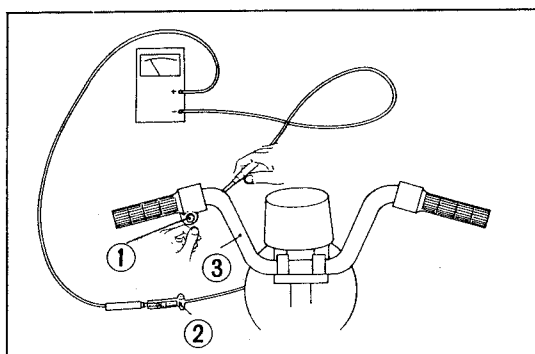

Fig. 168 ① Horn button switch ② Horn button switch lead  
③ Handle bar

Knob position	Blue cord	Gray cord	Orange cord
Right side	○	—○	
Left side			○ —○

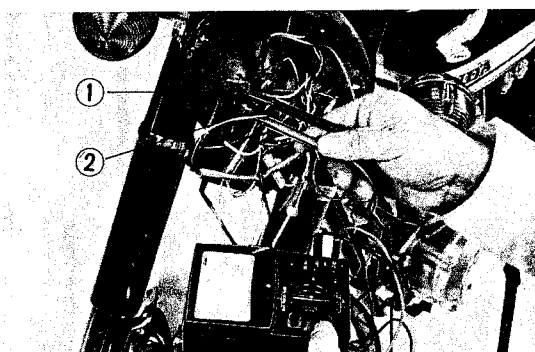

Fig. 169 Turn signal switch continuity test  
① Gray lead ② Blue lead

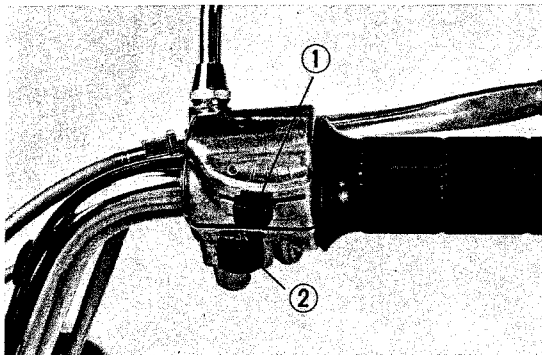

Fig. 170 ① Dimmer switch ② Lighting switch

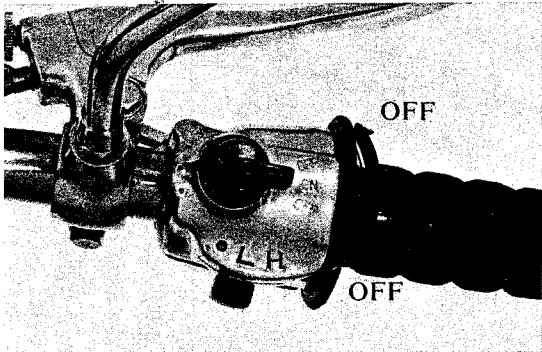

Fig. 171 Emergency switch

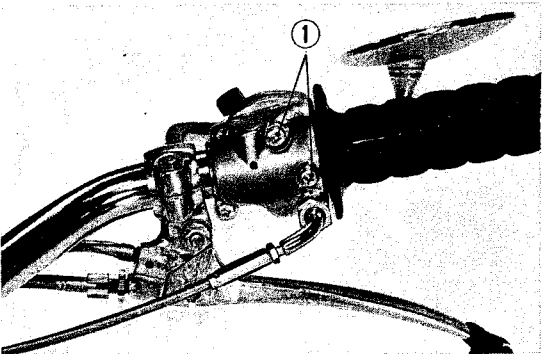

Fig. 172 Emergency switch removal  
① Switch mounting screws

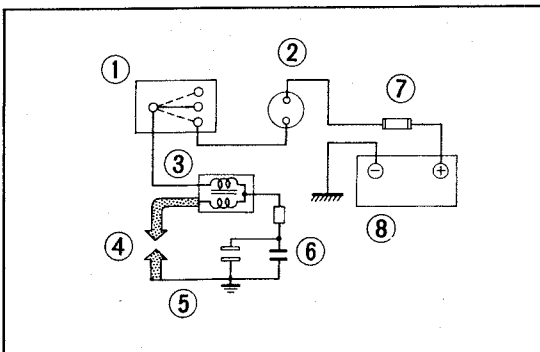

Fig. 173 Emergency switch operation  
① Emergency switch ② Main switch ③ Ignition coil ④ Spark plug ⑤ Contact breaker ⑥ Condenser ⑦ Fuse 15A ⑧ Battery 6V-6AH

7) Lighting and dimmer switch

Check the continuity of switch with the tester in accordance with the table below. (Fig. 170)

	H	TL	L	IG	DY	SE
Off						
Low		○—○	○—○	○—○	○—○	○—○
(N)	○—○	○—○	○—○	○—○	○—○	○—○
High	○—○	○—○	○—○	○—○	○—○	○—○
Color of	Blue	Brown	White	Black	White/ Yellow	Yellow

8) Emergency switch (SL 100 U.S.A. Type).

Construction

The emergency ignition switch (kill button) is provided to insure safe riding and shutting off the engines operation when the motorcycle is overturned or when trouble develops in the throttle system. (Fig. 171)

Disassembly

- ① Loosen two switch mounting screws and separate the upper and lower halves. (Fig. 172)
- ② Disconnect the throttle cable from the throttle cable connector on the bottom of the switch housing.
- ③ Disconnect the wirings within the headlight case and remove the switch assembly.

Inspection

Start the engine, first make sure the engine can be stopped by switching off the emergency switch. If the respective switch positions are not functioned properly, the switch or wiring is defective.

If the wiring is correct, check by the testing conductivity of wires with the switch. If the conductivity is not correct, replace with new one.

Reassembly

Perform assembly in the reverse order of disassembly. Check switch operation.

Operation

The operational principle of the emergency ignition switch is shown by the illustration. Even if ignition switch is ON, the primary circuit can be opened by operation of the switch. (Fig. 173)



## TROUBLE SHOOTING

Troubles	Probable causes	Corrective action
<b>Engine does not start or hard starting</b>	<ol style="list-style-type: none"> <li>1. Lack of compression               <ol style="list-style-type: none"> <li>(1) Tappet stuck open</li> <li>(2) Worn valve guide</li> <li>(3) Valve timing out of adjustment</li> <li>(4) Worn piston rings</li> <li>(5) Worn cylinder</li> </ol> </li> <li>2. No spark produced from spark plug electrodes               <ol style="list-style-type: none"> <li>(1) Fouled spark plug</li> <li>(2) Wet spark plug</li> <li>(3) Fouled breaker contact points</li> <li>(4) Improper point gap</li> <li>(5) Ignition timing out of adjustment</li> <li>(6) Defective ignition coil</li> <li>(7) Open or shorted circuit in ignition cord</li> <li>(8) Shorted condenser</li> </ol> </li> <li>3. Fuel does not flow to carburetor               <ol style="list-style-type: none"> <li>(1) Clogged fuel tank cap vent hole</li> <li>(2) Clogged fuel cock</li> <li>(3) Defective carburetor float valve</li> <li>(4) Clogged fuel tube</li> </ol> </li> </ol>	Adjust tappet clearance,  Replace Repair Replace Replace  Clean Clean Clean Adjust Adjust Replace Replace Replace  Clean Clean Replace Clean
<b>Engine suddenly stalls while running</b>	<ol style="list-style-type: none"> <li>1. Fouled spark plug</li> <li>2. Fouled breaker contact points</li> <li>3. Ignition timing out of adjustment</li> <li>4. Clogged fuel line</li> <li>5. Clogged carburetor jets</li> </ol>	Clean Clean Adjust Clean Clean
<b>Engine noise</b>	<ol style="list-style-type: none"> <li>1. Tappet noise               <ol style="list-style-type: none"> <li>(1) Excessive tappet clearance</li> <li>(2) Weakened or broken valve spring</li> </ol> </li> <li>2. Knocking noise from piston               <ol style="list-style-type: none"> <li>(1) Worn piston and cylinder noise</li> <li>(2) Carbon accumulation in combination chamber</li> <li>(3) Worn piston pin or connecting rod small end</li> </ol> </li> <li>3. Cam chain noise               <ol style="list-style-type: none"> <li>(1) Stretched cam chain</li> <li>(2) Worn cam sprocket or timing sprocket</li> </ol> </li> </ol>	Repair Replace  Replace Clean  Replace  Replace or shorten the chain Replace

Troubles	Probable causes	Corrective action
<b>Engine noise</b>	4. Knocking noise from clutch (1) Looseness of clutch center spline (2) Excessively worn friction disc or clutch (3) Distorted friction disc or clutch plate 5. Crankshaft (1) Excessive runout of crankshaft (2) Excessively worn crankshaft bearing (3) Excessively worn connecting rod, large end 6. Gear noise (1) Worn or binding transmission gear teeth (2) Worn transmission spline (3) Worn or binding primary transmission gear	Replace Replace Replace or repair Repair Replace Replace Replace Replace Replace
<b>Clutch slips</b>	1. Improper adjustment of clutch (no free play) 2. Weakened clutch spring 3. Worn or distorted pressure plate. 4. Distorted clutch plate 5. Worn or distorted friction plate	Readjust Replace Replace Replace Replace
<b>Clutch disengages improperly</b>	1. Improper adjustment of clutch (excessive play) 2. Uneven clutch spring tension 3. Distorted clutch plate	Readjust Readjust Replace
<b>Gear does not shift in</b>	1. Broken center gear shift fork pawl 2. Broken gear shift cam 3. Deformed gear shift fork	Replace Replace Repair or replace
<b>Change pedal does not return to its position</b>	1. Broken or dislocated gear shift return spring 2. Shifting spindle hits crankcase hole	Repair or replace Repair
<b>Gear jumps out while running</b>	1. Worn shifting gears on main shaft and counter shaft 2. Distorted or worn gear shift fork 3. Weakened shift drum stopper spring	Replace Repair or replace Replace

Troubles	Probable causes	Corrective action
<b>Poor engine performance at low speed</b>	<ol style="list-style-type: none"> <li>1. Improper adjustment of tappet</li> <li>2. Poor cylinder head valve seating</li> <li>3. Defective valve guide</li> <li>4. Ignition timing out of adjustment</li> <li>5. Improper breaker contact points</li> <li>6. Excessive spark plug gap</li> <li>7. Weak ignition spark (defective condenser and ignition coil)</li> <li>8. Improper adjustment of carburetor float level</li> <li>9. Improper adjustment of carburetor air screw</li> </ol>	<p>Readjust</p> <p>Replace</p> <p>Replace</p> <p>Readjust</p> <p>Repair</p> <p>Readjust</p> <p>Replace</p> <p>Readjust</p> <p>Readjust</p>
<b>Poor engine performance at high speed</b>	<ol style="list-style-type: none"> <li>1. Weak valve spring</li> <li>2. Valve timing out of adjustment</li> <li>3. Too small spark plug gap</li> <li>4. Ignition timing is retarded</li> <li>5. Weak point arm spring</li> <li>6. Defective ignition coil</li> <li>7. Improper adjustment of carburetor float level</li> <li>8. Clogged air cleaner element</li> <li>9. Insufficient fuel flow to carburetor</li> </ol>	<p>Replace</p> <p>Readjust</p> <p>Readjust</p> <p>Readjust</p> <p>Replace</p> <p>Replace</p> <p>Readjust</p> <p>Clean</p> <p>Clean or replenish</p>
<b>Hard steering</b>	<ol style="list-style-type: none"> <li>1. Broken steering ball bearings</li> <li>2. Bent steering stem</li> <li>3. Excessively tightened steering cone race</li> <li>4. Low tire pressure</li> </ol>	<p>Replace</p> <p>Repair or replace</p> <p>Retighten to specified torque</p> <p>Inflate to specified pressure</p>
<b>Front and rear suspension function too weak</b>	<ol style="list-style-type: none"> <li>1. Weakened main spring</li> <li>2. Insufficient front damper oil</li> </ol>	<p>Replace</p> <p>Refill to specified amount</p>
<b>Front and rear suspension function too hard</b>	<ol style="list-style-type: none"> <li>1. Front damper oil viscosity is too high</li> <li>2. Excessive damper oil</li> <li>3. Improper adjustment of rear cushion</li> </ol>	
<b>Ineffective brake</b>	<ol style="list-style-type: none"> <li>1. Worn brake lining</li> <li>2. Foreign objects adhered on brake lining surface</li> <li>3. Improper engagement of brake arm serration</li> <li>4. Worn brake cam</li> </ol>	<p>Replace</p> <p>Clean</p> <p>Repair</p>

Troubles	Probable Causes	Corrective Action
<b>Exhaust smoke from muffler</b>	<ol style="list-style-type: none"> <li>1. Excessive engine oil</li> <li>2. Excessively worn cylinder and piston rings</li> <li>3. Worn valve guide</li> <li>4. Damaged cylinder</li> </ol>	<p>Check oil level with oil level gauge</p> <p>Replace</p> <p>Replace</p> <p>Replace</p>
<b>Insufficient horsepower</b>	<ol style="list-style-type: none"> <li>1. Improper adjustment of tappet (valve stuck open)</li> <li>2. Weakened valve spring</li> <li>3. Valve timing out of alignment</li> <li>4. Worn cylinder and piston rings</li> <li>5. Poor valve seating</li> <li>6. Ignition timing out of adjustment</li> <li>7. Poor breaker contact points</li> <li>8. Defective plug gap</li> <li>9. Clogged carburetor fuel passage</li> <li>10. Improper adjustment of float level</li> <li>11. Clogged air cleaner</li> </ol>	<p>Readjust</p> <p>Replace</p> <p>Repair</p> <p>Replace</p> <p>Replace</p> <p>Readjust</p> <p>Repair or replace</p> <p>Repair</p> <p>Clean</p> <p>Readjust</p> <p>Clean</p>
<b>Overheating</b>	<ol style="list-style-type: none"> <li>1. Excessive carbon accumulation on cylinder head</li> <li>2. Insufficient oil</li> <li>3. Defective oil pump and clogged oil passage</li> <li>4. Too low float level</li> <li>5. Too early ignition timing (causes knocking)</li> </ol>	<p>Refill up to specified oil level</p> <p>Clean</p> <p>Readjust</p> <p>Readjust</p>

### ELECTRICAL SYSTEM

Troubles	Probable Causes	Corrective Action
<b>Engine does not start</b>	<ol style="list-style-type: none"> <li>1) Battery <ul style="list-style-type: none"> <li>• Discharged</li> <li>• Poor contact of battery terminals</li> </ul> </li> <li>2) Combination switch <ul style="list-style-type: none"> <li>• Open or shorted circuit, disconnected connections</li> <li>• Poor contact between combination switch wire and wire harness</li> </ul> </li> <li>3) Ignition coil <ul style="list-style-type: none"> <li>• Improperly insulated high tension coil</li> <li>• Open or shorted circuit in ignition coil</li> </ul> </li> <li>4) Contact breaker <ul style="list-style-type: none"> <li>• Open circuit in the primary coil</li> <li>• Dirty ground point with oil or dust</li> <li>• Point gap out of adjustment</li> <li>• Improperly charged condenser</li> </ul> </li> </ol>	<p>Recharge or replace</p> <p>Repair</p> <p>Repair</p> <p>Replace</p> <p>Replace</p> <p>Repair</p> <p>Clean</p> <p>Readjust</p> <p>Replace</p>

Troubles	Probable Causes	Corrective Action
<b>Battery self</b>	1) Wiring <ul style="list-style-type: none"> <li>• Open or shorted circuit in battery or disconnected battery terminals</li> </ul> 2) Generator <ul style="list-style-type: none"> <li>• Open or shorted circuit in stator coil or ground</li> <li>• Broken or shorted leads</li> <li>• Demagnetization of rotor</li> </ul> 3) Battery <ul style="list-style-type: none"> <li>• Poor contact of battery terminals</li> <li>• Insufficient battery electrolyte</li> <li>• Shorted battery electrode</li> </ul>	Replace or retighten  Repair or replace Repair Replace  Repair Add distilled water Repair
<b>Winker lamp blinks too fast or too slow</b>	1) Bulb <ul style="list-style-type: none"> <li>• Blinks unusually fast improperly connected relay</li> </ul> 2) Wiring <ul style="list-style-type: none"> <li>• Blinks too fast: bulb with unsuitable wattage</li> <li>• Blinks too slow: Burnt or broken bulb filament</li> <li>• Defective relay</li> </ul>	Replace  Replace Replace Replace
<b>Winker lamp inoperative</b>	1) Winker lamp switch <ul style="list-style-type: none"> <li>• Poor contact of winker relay</li> <li>• Open circuit in winker relay coil</li> </ul> 2) Bulb <ul style="list-style-type: none"> <li>• Bulb wattage is smaller than rated wattage</li> </ul> 3) Relay <ul style="list-style-type: none"> <li>• Poor contact of winker relay</li> <li>• Improperly connected leads</li> </ul>	Replace Replace  Replace  Replace Replace
<b>Horn inoperative, poor sound or too weak sound</b>	1) Horn <ul style="list-style-type: none"> <li>• Cracked diaphragm</li> </ul> 2) Horn button <ul style="list-style-type: none"> <li>• Poor grounding</li> </ul> 3) Wiring <ul style="list-style-type: none"> <li>• Poor contact</li> </ul> 4) Adjusting screw <ul style="list-style-type: none"> <li>• Out of adjustment</li> </ul>	Replace  Repair  Readjust  Readjust
<b>Tail light and head light inoperative</b>	1) Fuse <ul style="list-style-type: none"> <li>• Blown fuse or burnt bulb filament</li> </ul> 2) Bulb <ul style="list-style-type: none"> <li>• Poor contact of lighting switch</li> </ul> 3) Switch <ul style="list-style-type: none"> <li>• Poor contact of dimmer switch</li> </ul> 4) Wiring	Replace  Readjust  Readjust
<b>Stop light inoperative</b>	1) Bulb <ul style="list-style-type: none"> <li>• Burnt or broken bulb filament</li> </ul> 2) Front & tail stop light switch <ul style="list-style-type: none"> <li>• Malfunction of switch</li> </ul> 3) Wiring <ul style="list-style-type: none"> <li>• Poor contact of leads</li> </ul>	Replace  Readjust  Readjust

## PERIODICAL MAINTENANCE

### Maintenance Schedule

The milage intervals shown in the MAINTENANCE SCHEDULE are intended as a guide for establishing regular maintenance and lubrication periods by which the best and most safe riding conditions are assured.

The operating procedures for individual items are described in the section of MAINTENANCE OPERATION.

After 12 months or 10,000 km (6,000 miles) perform repeatedly all items which are described in the column at every 6 months or 5,000 km (3,000 miles) intervals.

Sustained severe or high speed operation under adverse conditions may necessitate more frequent servicing.

Service Required	Months or Miles, whichever occurs first						Page Reference
	Month	First	Second	Third	Thereafter Repeat Every		
	—	6	12	6	12		
	km	300	5,000	10,000	5,000	10,000	
	Mile	200	3,000	6,000	3,000	6,000	
Engine Oil-change	○	Every 1,000 Miles (1,600 km)					8
Oil Filter-clean	○		○		○		8
Spark Plug-clean and adjust or replace		○	○	○			7
Contact Breaker Points-check or service		○	○	○			6
Ignition Timing-check or adjust	○	○	○	○			6
Valve Tappet Clearance-check or adjust	○	○	○	○			5
Cam Chain-adjust	○	○	○	○			9
Air- Cleaner-clean		○			○		9
Throttle Operation-check		○	○	○			45
Carburetor-check or adjust		○	○	○			5
Fuel Valve Strainer-clean		○	○	○			50, 51
Fuel Tank and Fuel Lines-check		○	○	○			50, 51
Clutch-check or adjust	○	○	○	○			7
Drive Chain and Sprockets-adjust and lubricate or replace	○	○	○	○			11
Front and Rear Brake-adjust	○	○	○	○			10
Front and Rear Brake Shoes-check or replace			○		○		38, 41
Front and Rear Brake Links-check		○	○	○			38, 41
Wheel Rims and Spokes-check	○	○	○	○			38, 41
Tires-check or replace		○	○	○			38, 39, 41
Front Fork Oil-check and change		○			○		11
Steering Head Bearings-check or adjust			○		○		44
Steering Handle Lock-check for operation			○		○		44
Side Stand Spring-check		○	○	○			51
Battery Electrolyte Level-check and replenish if necessary	○	○	○	○			11, 56-58
Lights, Horn and Speedometer-check for operation or adjust		○	○	○			58-60

## TECHNICAL DATA

ITEM	CB100	CL100	CL100
<b>DIMENSION</b>			
Overall length	74.2 in. (1,885mm)	71.6 in. (1,820mm)	75.4 in. (1,915mm)
Overall width	29.5 in. (750mm)	32.5 in. (825mm)	31.9 in. (810mm)
Overall height	40.0 in. (1,015mm)	40.5 in. (1,030mm)	42.9 in. (1,090mm)
Wheel base	47.4 in. (1,205mm)	47.8 in. (1,215mm)	49.4 in. (1,255mm)
<b>WEIGHT</b>			
Dry weight	191.8 lbs (87 kg)	191.8 lbs (87 kg)	211.7 lbs (96 kg)
<b>CAPACITIES</b>			
Engine oil	2.1 US pt (1.0 liter)	2.1 U.S. pt (1.0 liter)	2.1 U.S. pt. (1.0 liter)
Fuel tank	2.0 US gal. (7.5 liter)	2.0 U.S. gal. (7.5 liter)	2.0 U.S. gal. (7.5 liter)
Fuel reserve tank	2.5 US pt (1.2 liter)	2.5 U.S. pt (1.2 liter)	2.5 U.S. pt. (1.2 liter)
<b>ENGINE</b>			
Bore and stroke	1.988×1.944 in. (50.5×49.5mm)	1.988×1.949 in. (50.5×49.5mm)	1.988×1.949 in. (50.5×49.5mm)
Compression ratio	9.5: 1	9.5: 1	9.5: 5
Displacement	6.04 cu in. (99 cc)	6.04 cu in. (99 cc)	6.04 cu in. (99 cc)
Horse power	11.5 ps/11,000 rpm	11.5 ps/11,000 rpm	11.5 ps/11,000 rpm
Contact breaker point gap	0.012~0.016 in. (0.3~0.4mm)	0.012~0.016 in. (0.3~0.4mm)	0.012~0.016 in. (0.3~0.4mm)
Spark plug gap	0.024~0.028 in. (0.6~0.7mm)	0.024~0.028 in. (0.6~0.7mm)	0.024~0.028 in. (0.6~0.7mm)
Valve tappet clearance	0.002 in. (0.05mm)	0.002 in. (0.05mm)	0.002 in. (0.05mm)
<b>CHASSIS AND SUSPENSION</b>			
Caster	64°	63°40'	61.5°
Trail	2.95 in. (75mm)	3.07 in. (78mm)	3.7 in. (95mm)
Tire size, front	2.50~18 (4 PR)	2.50-18 (4 PR)	2.75-19 (4 PR)
Tire size, rear	2.75~18 (4 PR)	3.00-18 (4 PR)	3.25-17 (4 PR)
<b>POWER TRANSMISSION</b>			
Primary reduction	4.055	4.055	4.055
Final reduction	2.857	3.071	3.142
Gear ratio, 1 st.	2.500	2.500	2.500
2 nd.	1.722	1.722	1.722
3 rd.	1.333	1.333	1.333
4 th.	1.083	1.083	1.083
5 th.	0.923	0.923	0.923
<b>ELECTRICAL</b>			
Battery	6V-6AH	6V-6AH	6V-6AH
Generator	A.C. generator	A.C. generator	A.C. generator
Fuse	15 amp	15 amp	15 amp
<b>LIGHTS</b>			
Headlight	6V-35/25W	6V-35/25W	6V-35/25W
Tail/stoplight	6V-5.3/17W	6V-5.3/17W	6V-5.3/17W
Turn signal light	6V-18W	6V-18W	—
Meter light	6V-1.5W	6V-1.5W	6V-1.5W
Neutral indicator light	6V-1.5W	6V-1.5W	6V-1.5W
Turn signal indicator light	6V-1.5W	6V-1.5W	—
High beam indicator light	6V-1.5W	6V-1.5W	6V-1.5W

ITEM	CB125S	CD125S	SL125
<b>DIMENSION</b>			
Overall length	74.8 in. (1,900mm)	74.8 in. (1,900mm)	78.5 in. (1,995mm)
Overall width	29.5 in. (750mm)	29.5 in. (750mm)	31.9 in. (810mm)
Overall height	40.0 in. (1,015mm)	39.4 in. (1,000mm)	44.3 in. (1,115mm)
Wheel base	47.4 in. (1,205mm)	47.2 in. (1,200mm)	50.2 in. (1,275mm)
<b>WEIGHT</b>			
Dry weight	202.0 lbs (91.5 kg)	196.2 lbs (89 kg)	209.5 lbs (95.0 kg)
<b>CAPACITIES</b>			
Engine oil	1.0 U.S. qt. 0.9 Imp. qt (1.0 l)	1.0 U.S. qt., 0.9 Imp. qt. (1.0 l)	1.0 U.S. qt., 0.9 Imp. qt. (1.0 l)
Fuel tank	2.0 U.S. gal. 1.6 Imp. gal. (7.5 l)	2.0 U.S. gal., 1.6 Imp. gal. (7.5 l)	1.8 U.S. gal. 1.6 Imp. gal. (7.0 l)
Fuel reserve tank	1.3 U.S. qt. 1.1 Imp. qt. (1.2 l)	1.3 U.S. qt., 1.1 Imp. qt. (1.2 l)	0.4 U.S. gal. 0.3 Imp. gal. (1.5 l)
<b>ENGINE</b>			
Bore and stroke	2.205×1.949 in. (56×49.5mm)	2.205×1.949 in. (56×49.5mm)	2.205×1.949 in. (56×49.5mm)
Compression ratio	9.5: 1	9.5: 1	9.5: 1
Displacement	7.44 cu in. (122 cc)	7.44 cu in. (122 cc)	7.44 cu in. (122 cc)
Horse power	12.0 ps/9,000 rpm	12.0 ps/9,000 rpm	12.0 ps/9,000 rpm
Contact breaker point gap	0.012~0.016 in. (0.3~0.4mm)	0.012~0.016 in. (0.3~0.4mm)	0.012~0.016 in. (0.3~0.4mm)
Spark plug gap	0.024~0.028 in. (0.6~0.7mm)	0.024~0.028 in. (0.6~0.7mm)	0.024~0.028 in. (0.6~0.7mm)
Valve tappet clearance	0.002 in. (0.05mm)	0.002 in. (0.05mm)	0.002 in. (0.05mm)
<b>CHASSIS AND SUSPENSION</b>			
Caster	63°45'	63°45'	60°
Trail	3.15 in. (80mm)	3.15 in. (80mm)	3.15 in. (80mm)
Tire size, front	2.75-18 (4 PR)	2.50-18 (4 PR)	2.75-21 (4 PR)
Tire size, rear	3.00-17 (4 PR)	2.75-18 (4 PR)	3.25-18 (4 PR)
<b>POWER TRANSMISSION</b>			
Primary reduction	4.055	4.055	4.055
Final reduction	3.267	2.800	3.267
Gear ratio, 1 st.	2.500	2.769	2.769
2 nd.	1.722	1.722	1.722
3 rd.	1.333	1.272	1.272
4 th.	1.083	1.000	1.000
5 th.	0.923	—	0.815
<b>ELECTRICAL</b>			
Battery	6V-6 AH	6V-6 AH	6V-6 AH
Generator	A.C. generator	A.C. generator	A.C. generator
Fuse	10 amp	10 amp	15 amp
<b>LIGHTS</b>			
Headlight	6V-25/25W	6V-25/25W	6V-25/35W
Tail/stoplight	6V-3/10w	6V-3/10W	6V-5.3/17W
Turn signal light	6V-8W	6V-8W	—
Meter light	6V-1.5W	6V-1.5W	6V-1.5W
Neutral indicator light	6V-1.5W	6V-1.5W	6V-1.5W
Turn signal indicator light	6V-18W	6V-1.5W	6V-1.5W
High beam indicator light	6V-1.5W	6V-1.5W	6V-1.5W



# WIRING DIAGRAM

(CB100)

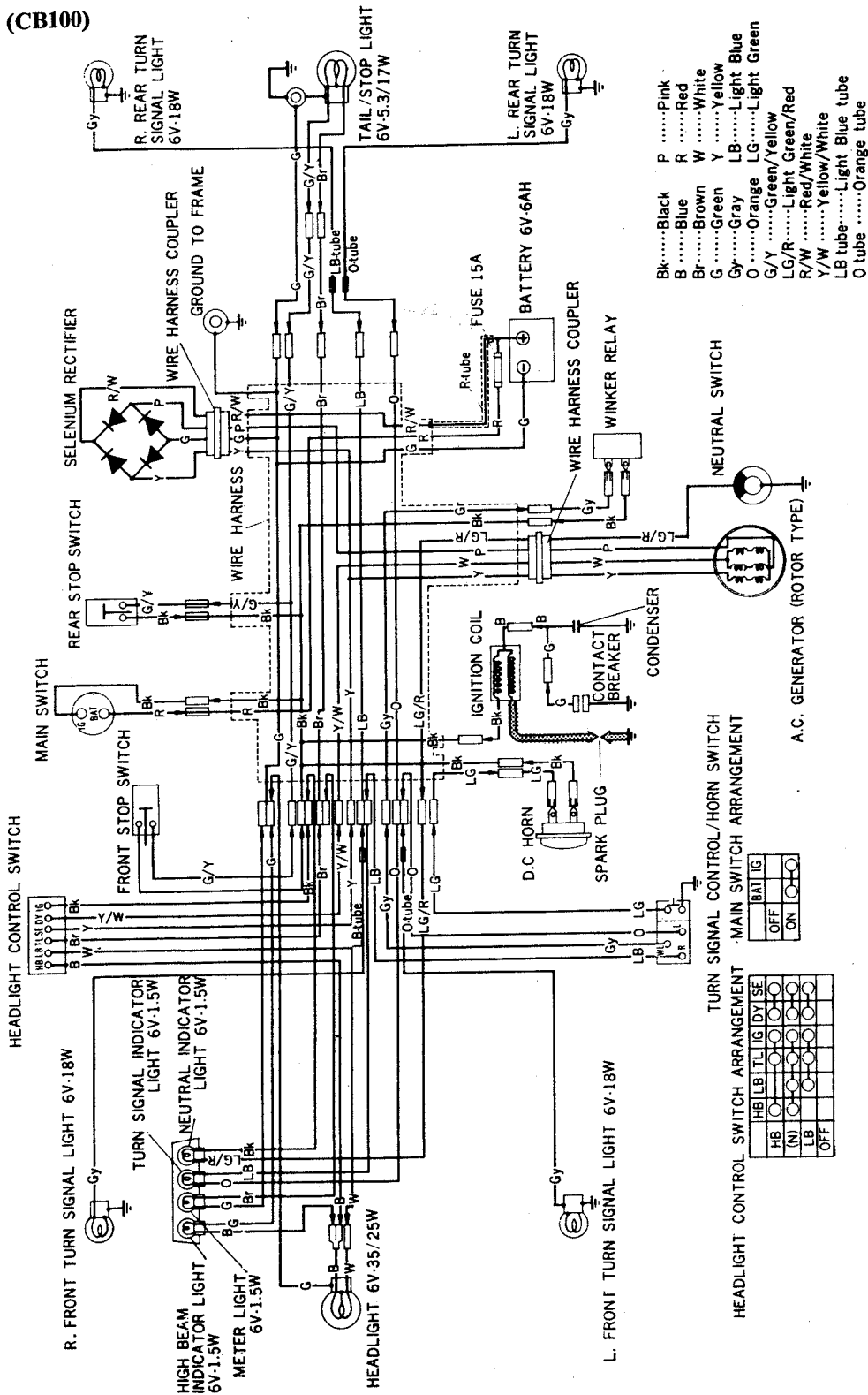

(CL100)

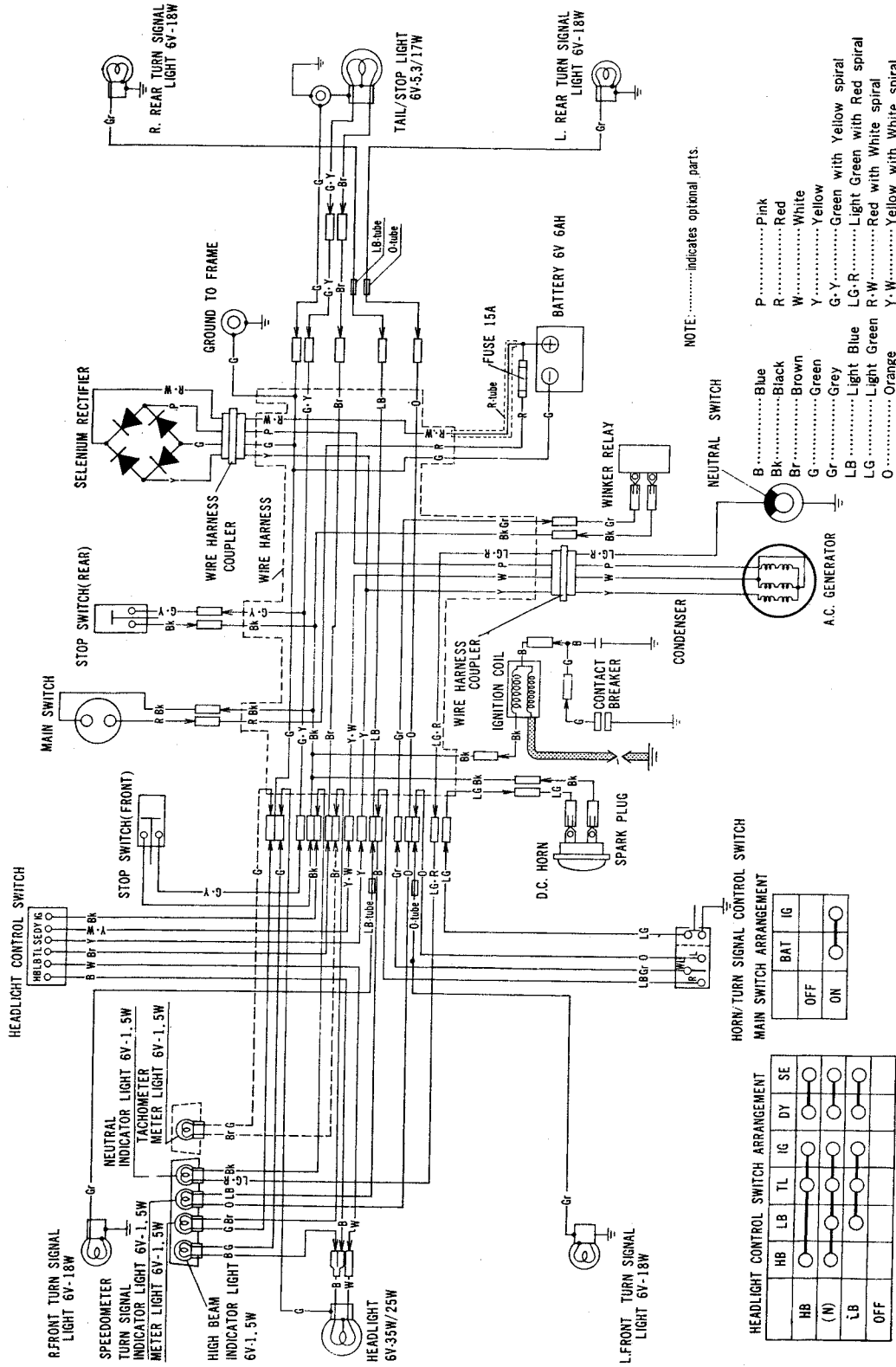

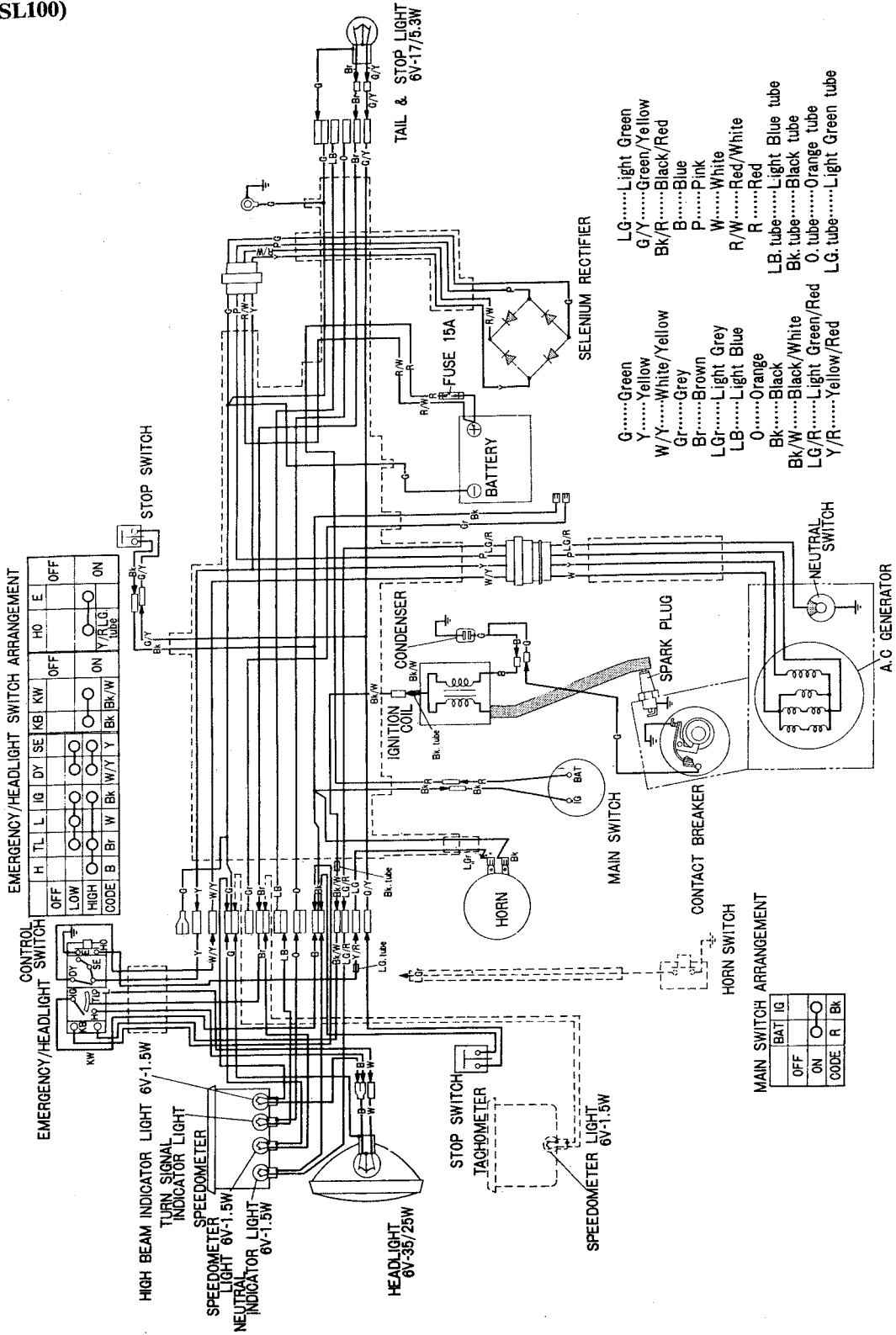

(CB125S)

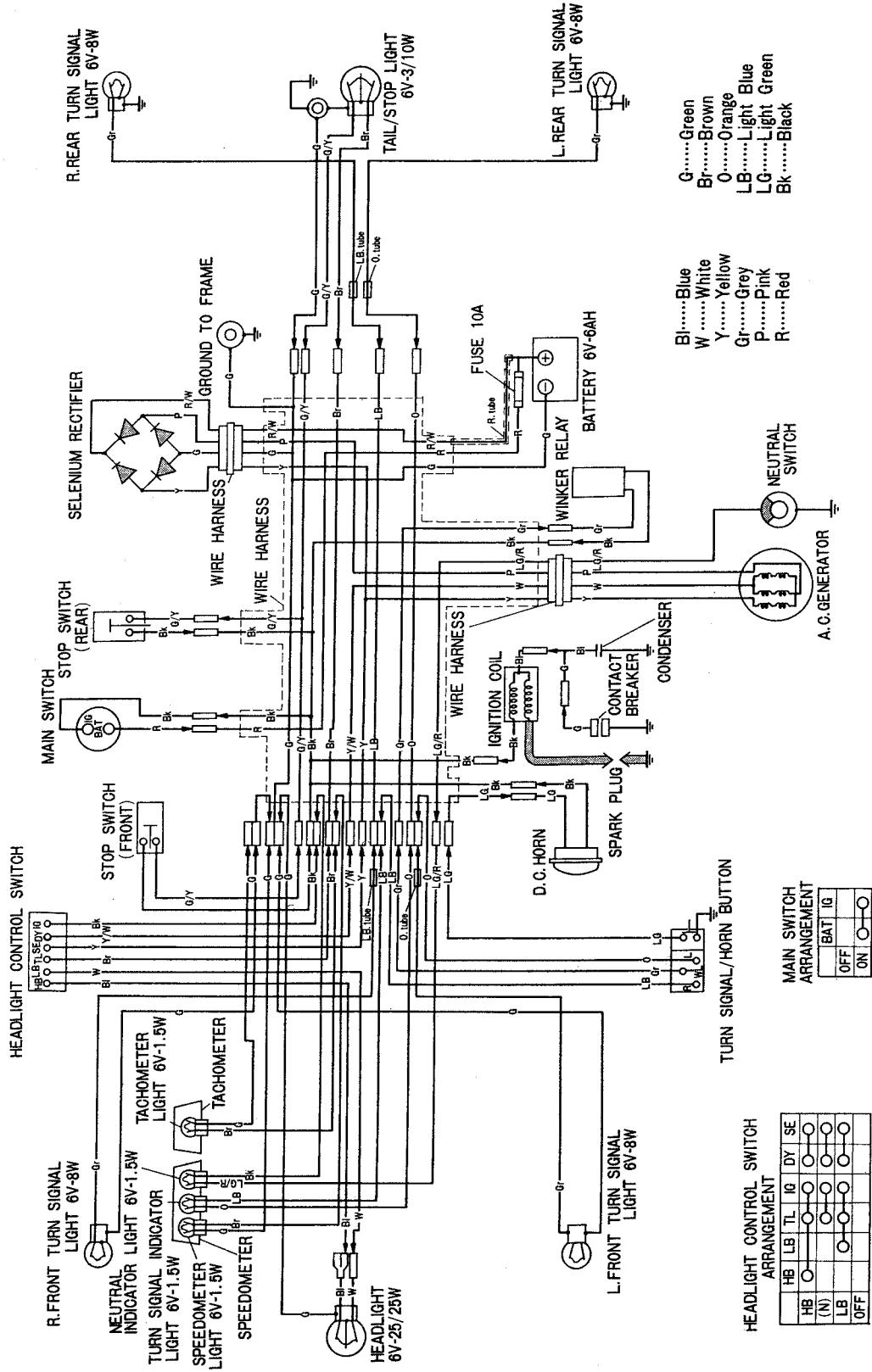

(CD125S)

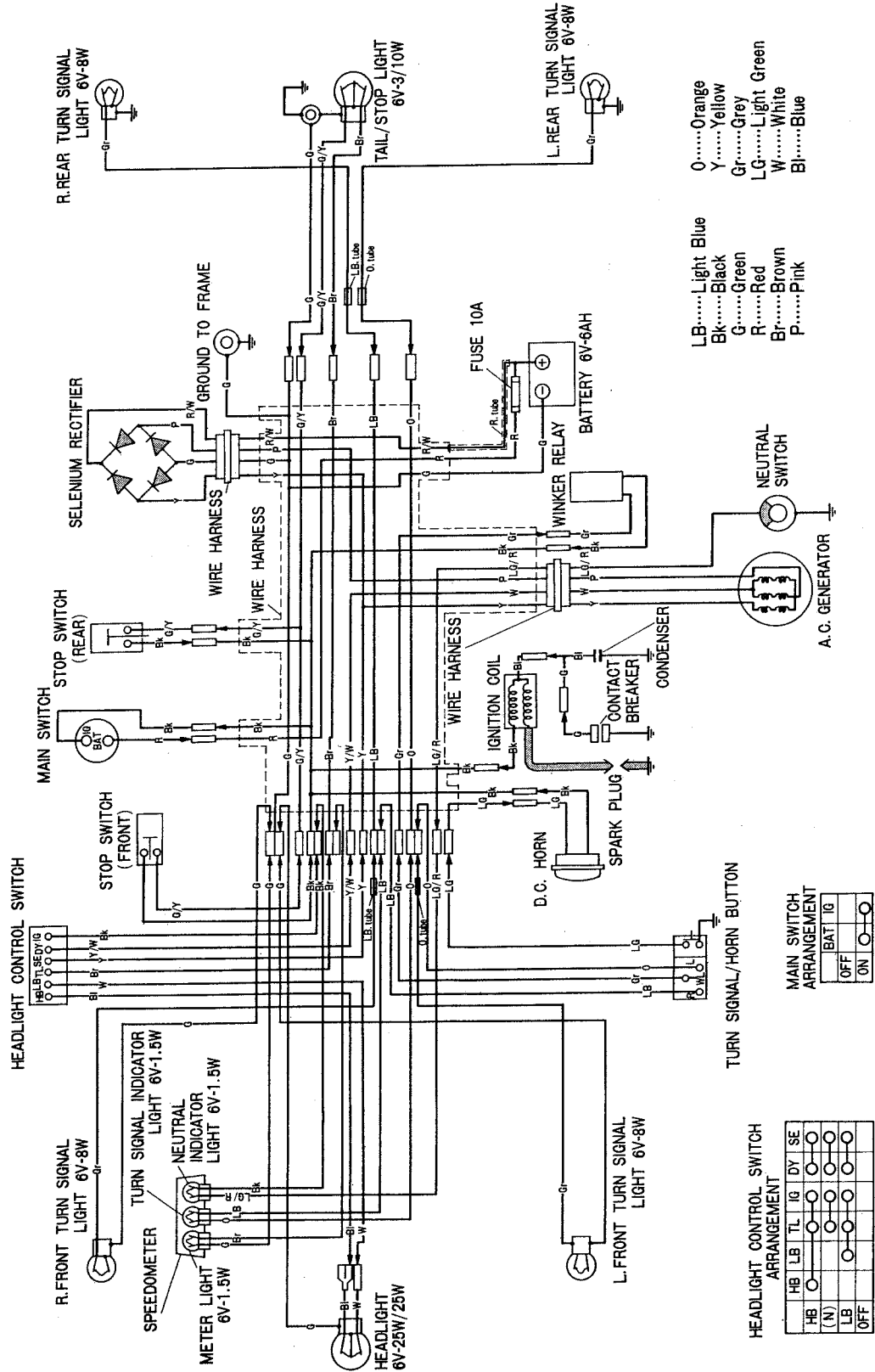

(SL125)

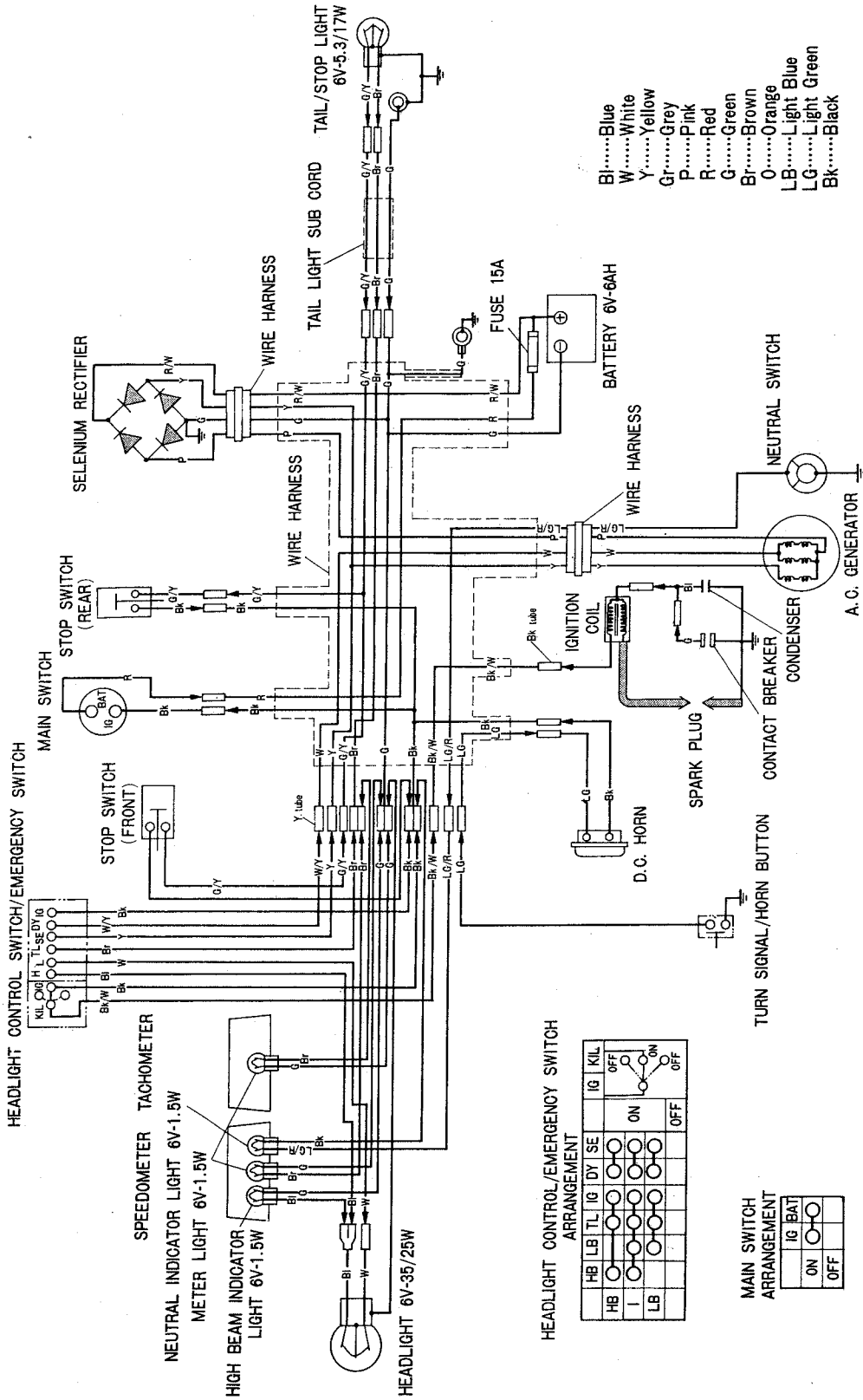

- Bk.....Blue
- W.....White
- Y.....Yellow
- Gr.....Grey
- P.....Pink
- R.....Red
- G.....Green
- Br.....Brown
- O.....Orange
- LB.....Light Blue
- LG.....Light Green
- Bk.....Black

HEADLIGHT CONTROL/EMERGENCY SWITCH ARRANGEMENT

HB	LB	TL	IG	SE	IG	KIL
○	○	○	○	○	OFF	OFF
○	○	○	○	○	ON	ON
○	○	○	○	○	OFF	OFF

MAIN SWITCH ARRANGEMENT

IG	BAT
ON	○
OFF	○

# TL125

## • TL125 SPECIAL TOOLS (ENGINE)

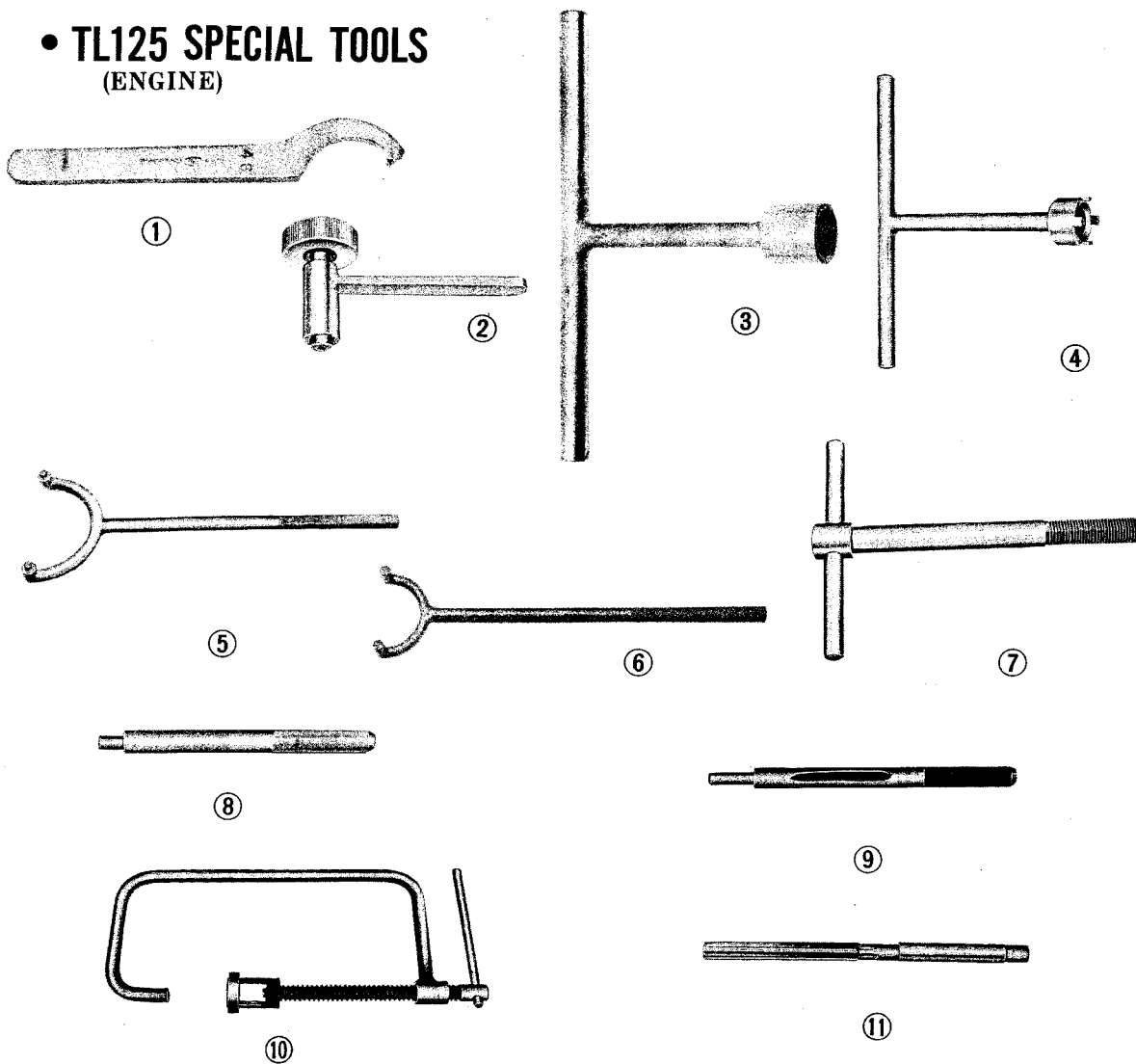

Ref. No.	Tool No.	Description
	07900-3550000	Special tool set
1	07902-2000000	Pin spanner 48mm
2	07908-0010000	Wrench, tappet adjusting
3	07915-2160000	Wrench, stem nut 29mm
4	07916-2830000	Wrench, locknut 16mm
5	07922-0300000	Holder, drive sprocket
6	07923-1070000	Holder, clutch outer
7	07933-2000000	Puller, roter
8	07942-2160100	Driver, Valve guide
9	07942-3290200	Remover, Valve guide
10	07957-3290000	Compressor, Valve Spring
11	07984-0980000	Reamer, Valve guide

(FLAME)

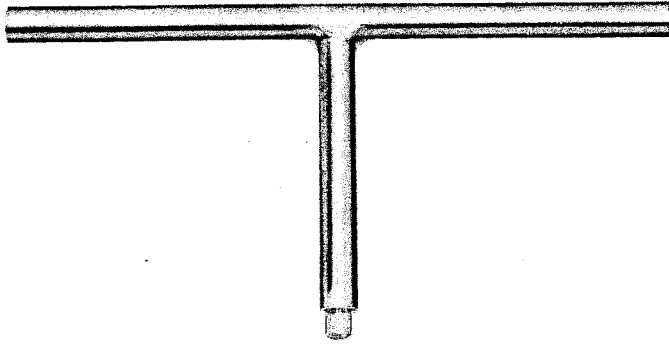

⑫

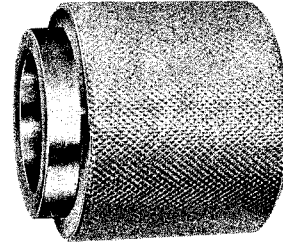

⑬

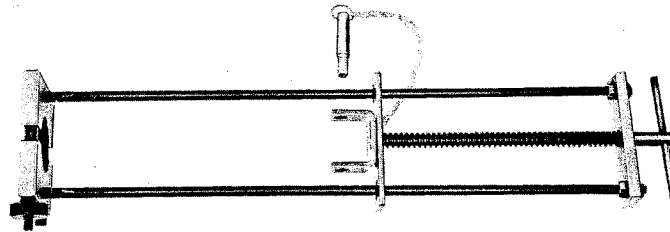

⑭

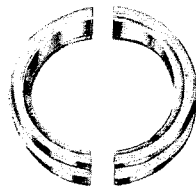

⑮

Ref. No.	Tool No.	Description
12	07917-3230000	Wrench, hollow set 6mm
13	07947-3550000	Driver, fork seal
14	07957-3290000	Tool disassembling (Rear cushion)
15	07967-1180100	Holder, spring attachment (Rear cushion)



## 1. TAPPET CLEARANCE ADJUSTMENT

Tappet clearance check and adjustment should be made the with engine is cold.

1) For adjustment, refer to page 5.

Remove the ACG caps A and B to observe whether or not the T mark is lined up with the index mark on the left crankcase cover. Specified tappet clearance:

(Fig. 1) Intake 0.002in (0.05mm)  
Exhaust 0.002in (0.05mm)

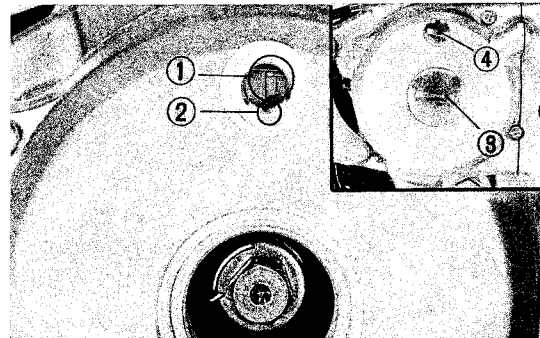

Fig. 1 ① T mark ② INDEX mark  
③ ACG Cap A. ④ ACG Cap B.

## 2. CARBURETOR ADJUSTMENT

1) Refer to page 5.

(Fig. 2)

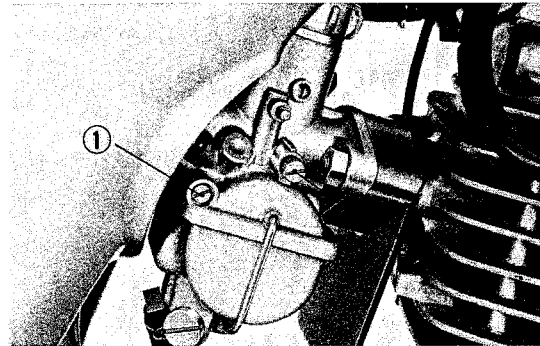

Fig. 2 ① Air screw ② Throttle stop screw

## 3. BREAKER POINT AND IGNITION TIMING ADJUSTMENT

1) Refer to page 6.

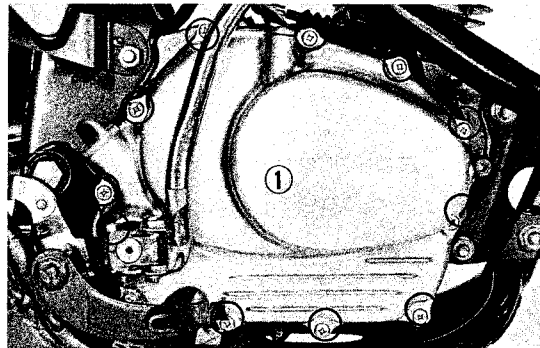

Fig. 3 ① Right crankcase cover

## 4. OIL FILTER CLEANING

- 1) Drain the engine.
- 2) Remove the kick starter pedal.
- 3) Disengage the clutch cable from the clutch lever.
- 4) Remove the right crankcase cover.(Fig. 3)
- 5) Remove the oil filter rotor cover.
- 6) Clean any sludge off the center of the oil filter rotor. (Fig. 4) Reassemble the filter.

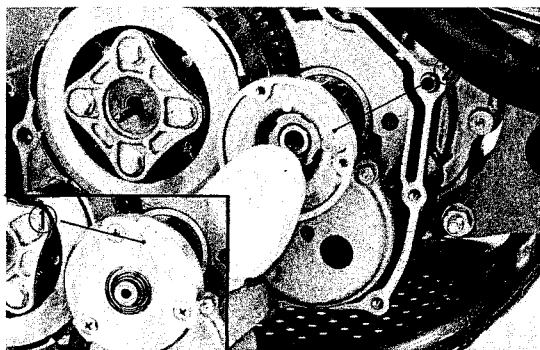

Fig. 4 ① Oil filter rotor cover ② Oil filter rotor

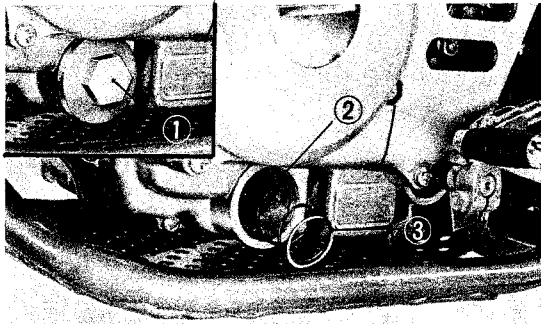

Fig. 5 ① Oil filter cap ② Screen filter ③ Spring

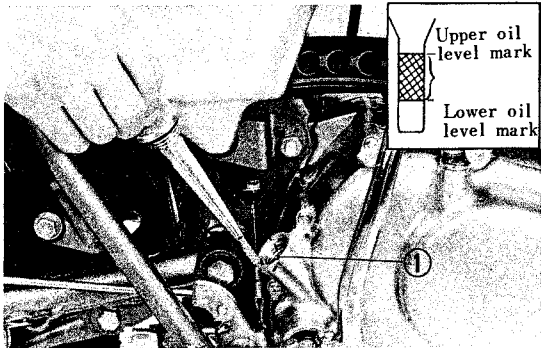

Fig. 6 ① Oil level gauge

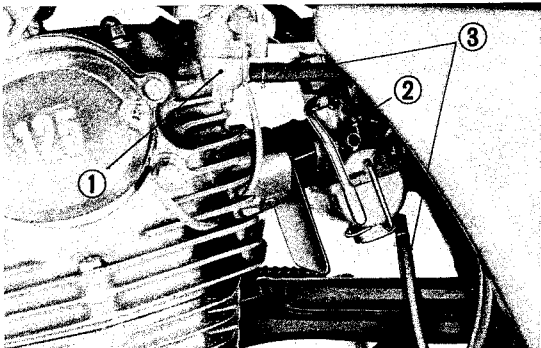

Fig. 7 ① Fuel cock ② Carburetor ③ Fuel pipe

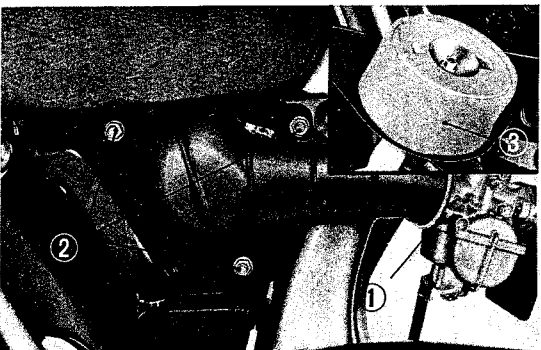

Fig. 8 ① Air cleaner connecting band ② Nut  
③ Air cleaner element

## 5. ENGINE OIL CHANGE

Start engine and run until the normal operating temperature is reached. This facilitates complete and rapid draining.

- 1) Apply the side stand. With the oil filter cap removed, operate the kick pedal several times. Use caution to avoid dropping the screen on the floor while operation.
- 2) Check both the screen filter and spring for presence of dust and dirt; if necessary, clean in solvent or gasoline and dry with compressed air. (Fig. 5)

- 3) Replace the cap and refill with fresh oil up to the upper level mark on the dip stick. Specified oil viscosity: (Fig. 6)

General, all temperatures SAE10W-40

Extreme, high temperature SAE20W-50

Capacity.....1l(1.05 qt)

Alternate:

Above 59° F	SAE30
32° to 59° F	SAE20W
Below 32° F	SAE10W

## 6. CAM CHAIN ADJUSTMENT

- 1) Refer to page 9. (Fig. 7)

## 7. FUEL SYSTEM INSPECTION

- 1) Refer to page 9.

Note:

Do not spill gasoline on the floor since it is highly flammable and may catch fire very easily. Place oily rags or waste in containers provided for them.

## 8. AIR CLEANER MAINTENANCE

- 1) Remove the right side cover.
- 2) Unfasten the band securing the cleaner to the carburetor. Remove three nuts and take out the filter element. Clean the element in solvent or gasoline and dry with compressed air. Refer to page 9. (Fig. 8)

## 9. CLUTCH WIRE ADJUSTMENT

- 1) Fine adjustment is made by loosening lock nut and turning the adjuster in or out until the proper play is obtained at the lever tip.  
To decrease play...Turn clockwise  
To increase play...Turn counter clockwise  
(Fig. 9)

The normal play at the tip of clutch lever should be: 10~20mm (0.4~0.8in)

### Note:

Check the adjustment of the clutch with the engine running. If there is excessive play, even full movement of the clutch lever will not release the clutch fully, resulting in engine stall or creeping of the motorcycle. Also check to be sure that the lever operates smoothly.

## 10. DRIVE CHAIN ADJUSTMENT

- 1) Check the tension of the drive chain. This is done by moving either of the top or bottom side of the chain up and down with fingers midway between the sprockets. Drive chain tension should be adjusted to allow approximately  $\frac{1}{4}$ " inch vertical movement at this point. (Fig. 10) Rotate the rear wheel and check drive chain tension throughout its length.
- 2) To adjust, remove the cotter pins from the axle nuts on both side of the rear fork and turn the adjuster plates in either direction until the specified chain tension is obtained. The adjusters on both side must be in the same setting. To secure it, tighten the nuts to specification and install the cotter pins securely. (Fig. 11)
- 3) Should you experience difficulty in rotating the adjuster, hold it with a hand and rotate while tapping on side of the tire with the other. (Fig. 12)

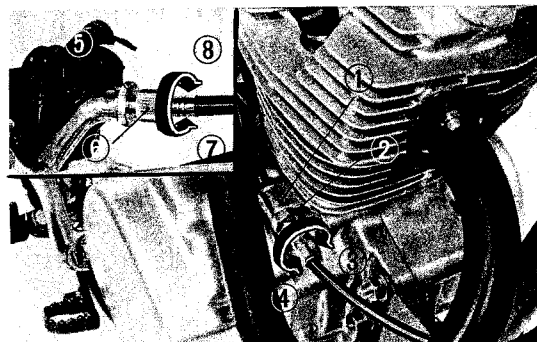

Fig. 9 ① Adjuster ② Lock nut ③ To decrease play  
④ To increase play ⑤ Nut ⑥ Adjuster  
⑦ To decrease play ⑧ To increase play

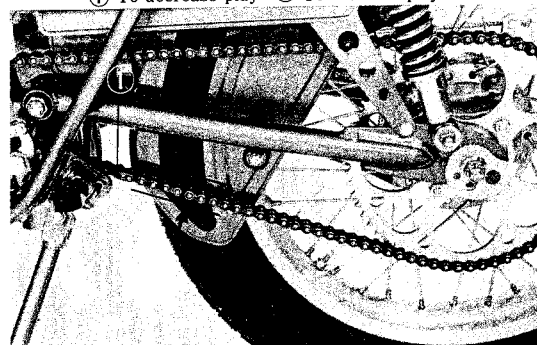

Fig. 10 ① Drive chain

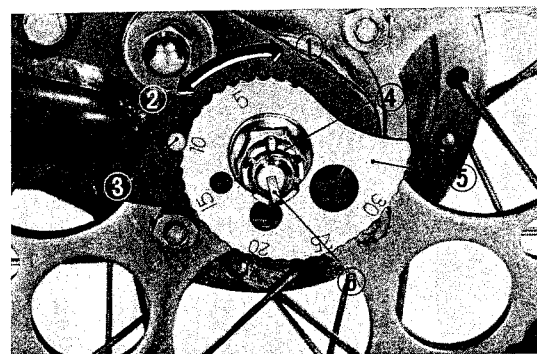

Fig. 11 ① To increased tension ② To decrease tension  
③ Stopper ④ Axle nut ⑤ Adjuster ⑥ Cotter pin

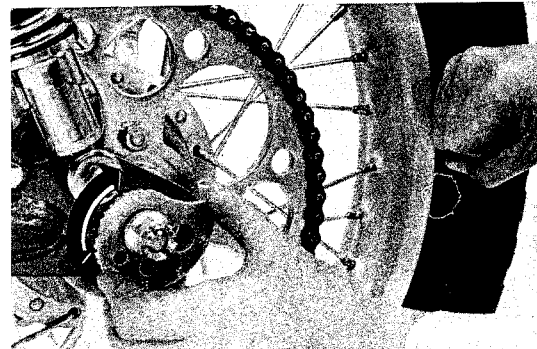

Fig. 12

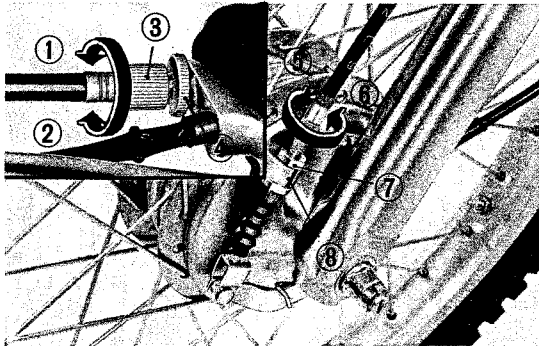

Fig. 13 ① To decrease play ② To increase play  
③ Adjuster ④ Nut ⑤ To decrease play  
⑥ To increase play ⑦ Adjuster ⑧ Lock nut

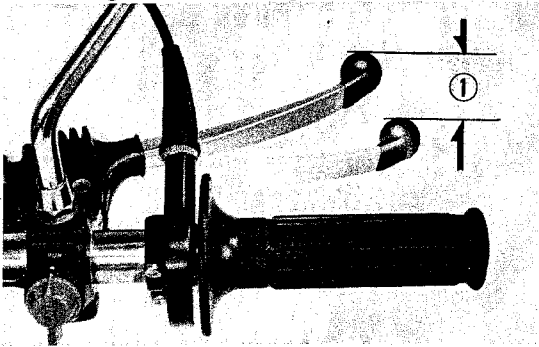

Fig. 14 ① 20~30mm (0.8~1.2 in)

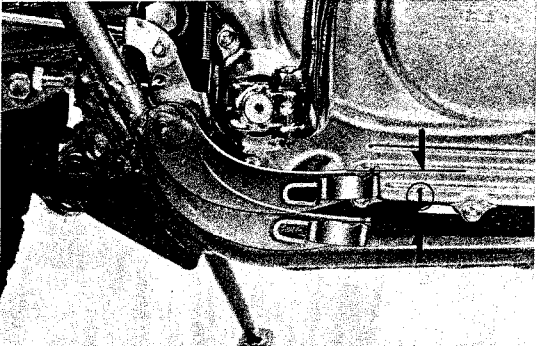

Fig. 15 ① 20~30mm (0.8~1.2 in)

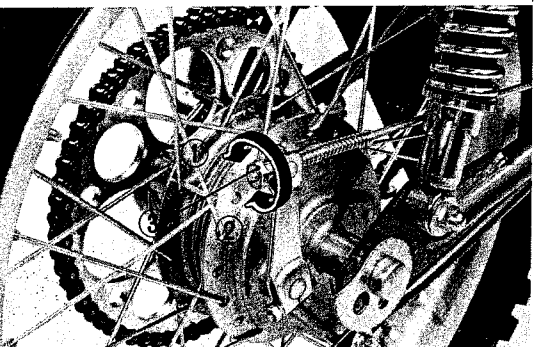

Fig. 16 ① To increase play ② To decrease play  
③ Adjusting nut

## 11. FRONT BRAKE ADJUSTMENT

- 1) To make free play adjustment, loosen the lock nut and turn the adjuster in or out located at the frontwheel. Minor adjustments should be made on the adjuster at the handlebar. Do not rotate the adjuster without first loosening the lock nut.

(Fig. 13)

- 2) Free play at the tip of the brake lever tip should be 20~30mm (0.8~1.2 in)

(Fig. 14),

### Note:

To avoid brake lever breakage in case of an accident, the tightening torque of the ignition and brake lever bracket is a little less than the standard torque limit to allow it to slip.

Make sure to use the specified torque.

Tightening torque..... 0.2kg-m  
(1.4lbs-ft)

## 12. REAR BRAKE ADJUSTMENT

- 1) Rear brake pedal free play, measured at the tip of the rear brake pedal ①, should be maintained at 20~30 mm (0.8~1.2 in). Free play is the distance the brake pedal moves until the brake starts to engage.

(Fig. 15)

- 2) Adjust the pedal free play by turning the rear brake adjusting nut ③. Turning the adjusting nut in direction ② will decrease the brake pedal free play and turning the nut in the direction ① will increase the play. (Fig. 16)

### 13. BRAKE PEDAL HEIGHT ADJUSTMENT

- 1) Brake pedal height can be adjusted to suit an individual rider. To adjust, loosen the lock nut and turn the stopper in or out as required. (Fig. 17)

**Note:**

Always make pedal play adjustment after the pedal height was changed.

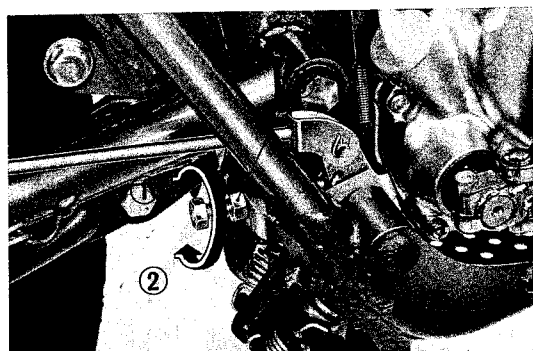

Fig. 17 ① Raise ② Lower ③ Lock nut  
④ Stopper

### 14. GEAR CHANGE PEDAL HEIGHT ADJUSTMENT

- 1) The gear change pedal can be also adjustable in height to suit the riding position of an individual rider. This adjustment is made by turning the adjuster after loosening the lock nut. After adjustment, tighten the lock nut firmly. (Fig. 18)

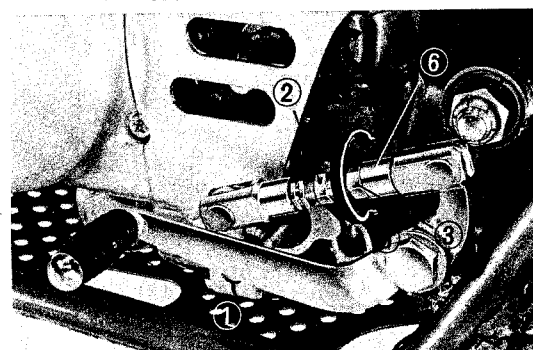

Fig. 18 ① Gear change pedal ② Lock nut (lefthand thread) ③ Adjuster ④ Raise ⑤ Lower ⑥ Lock nut

### 15. FRONT SUSPENSION SPRING ADJUSTMENT

- 1) Front suspension spring tension can be adjustable to meet the rider's weight or different road condition. Use the following procedure.
- 2) Remove the rubber cap from the top of the front fork.
- 3) Using a screwdriver, adjust the spring tension.

To obtain hard suspension, turn the adjuster clockwise, and turn counter-clockwise to make it soft. (Fig. 19)

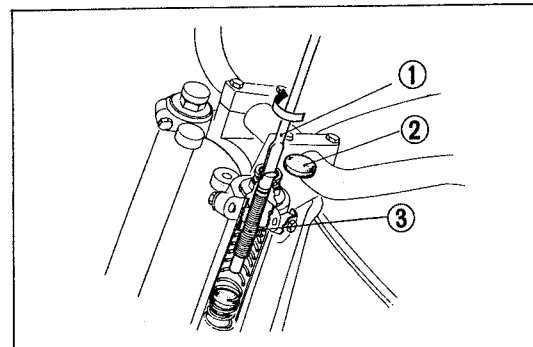

Fig. 19 ① Screwdriver ② Rubber cap ③ Adjuster

### 16. FRONT FORK OIL CHANGE

- 1) Regular oil change is required to keep the front suspension operating efficiently.
- 2) Remove the suspension spring adjuster from top of the fork. Loosen off the drain plugs from each fork leg and pump the fork several times to encourage oil to drain thoroughly. (Fig. 20)

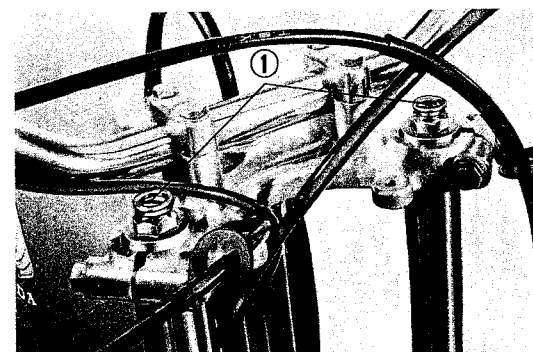

Fig. 20 ① Suspension spring adjuster

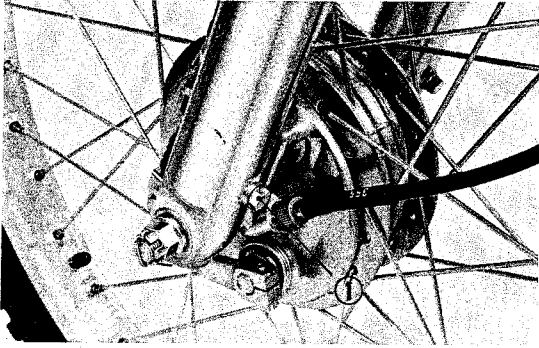

Fig. 21 ① Drain plug

**Note:**

The fork should be flushed using an approved solvent. Do not use gasoline to avoid damaging rubber parts.

- 3) Reinstall the drain plugs and refill with fresh oil. (Fig. 21)

Specified oil..... (automobile automatic transmission oil)

Quantity..... (4.4 to 4.770 ozs)  
130 to 140cc

**Note:**

Tighten the plugs firmly to prevent them from being turned out during operation.

### 17. CYLINDER COMPRESSION INSPECTION

- 1) Refer to page 12.

## 1. In-motorcycle service items

Items to be serviced	Page
1. Oil filter and oil pump	22
2. Clutch	25
3. Gear shift mechanism	32

## 2. ENGINE REMOVAL AND INSTALLATION

### A. Engine Removal

- 1) With the aid of a suitable Hollow set wrench, loosen the bolt at the muffler band securing the muffler to the exhaust pipe joint. (Fig. 23)

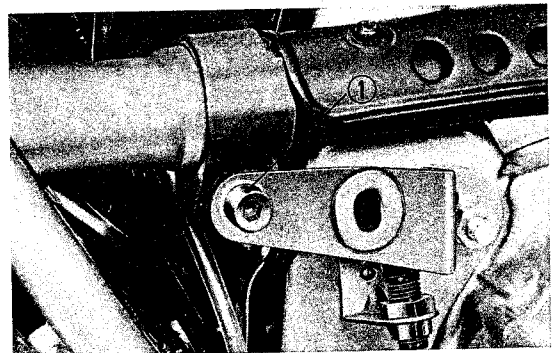

Fig. 23 ① Socket bolt

- 2) To disassemble the exhaust pipe, remove the two exhaust pipe retaining nuts. (Fig. 24)

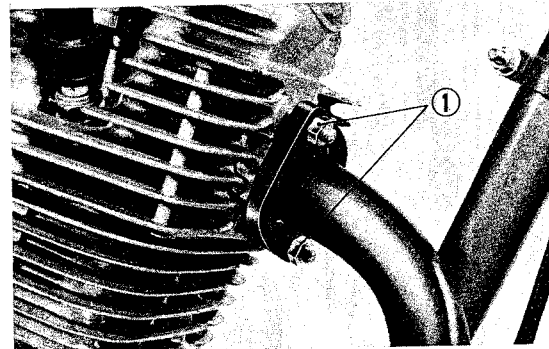

Fig. 24 ① 6mm hex. head nut

- 3) Separate the carburetor from the air cleaner.
- 4) Take out the seat.
- 5) Remove the fuel tank.
- 6) Remove the throttle valve from the carburetor. (Fig. 25)

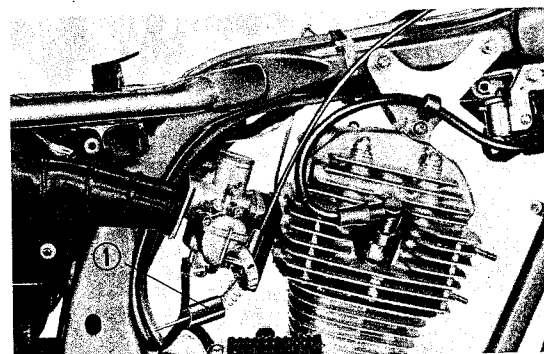

Fig. 25 ① Throttle valve

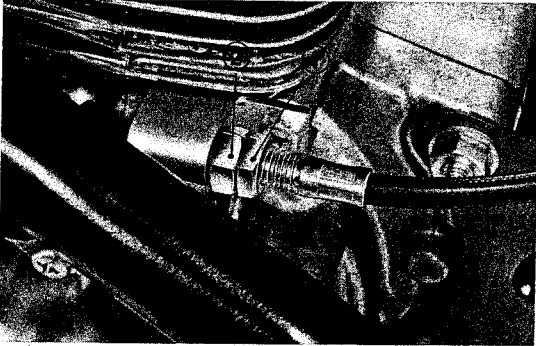

Fig. 26 ① Lock nut ② adjuster

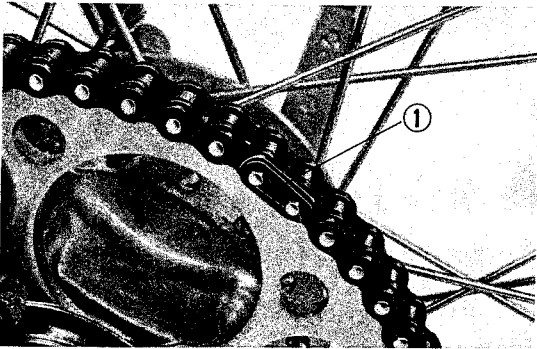

Fig. 27 ① Retaining clip and master link

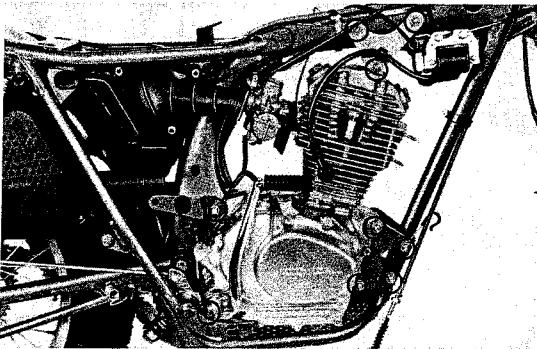

Fig. 28 O = Engine hanger bolts

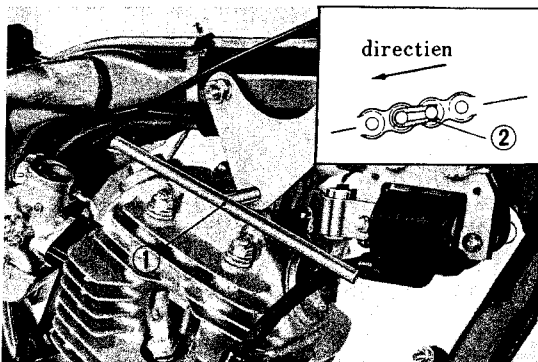

Fig. 29 ① T-screwdriver ② Retaining clip and master link

7) Loosen the clutch wire lock nut and adjuster just enough to slacken the wire; disconnect the wire from the clutch lever. (Fig. 26)

- 8) Remove the noise suppressor cap.
- 9) Remove the left side cover. Disconnect the drive chain by removing the clip from the master link. Take out the chain from the motorcycle. (Fig. 27)
- 10) Disconnect the coupler from the wiring harness.
- 11) Remove the primary wire.
- 12) Remove the nuts from the engine hanger bolts. Lift the rear of the engine just enough to remove load from the hanger bolts; pull off the bolts. (Fig. 28)  
Place the engine on a clean surface or work bench.

#### B. Engine Installation

- 1) To facilitate installation, line up eye on the cylinder head with holes in the top hanger bracket on the frame. Install a T-screwdriver with the end through these holes. The hanger bolts can then be installed easily. (Fig. 29)
- 2) Tighten the exhaust pipe joint to the muffler in two steps; first fingertight and then to the specified torque using a suitable torque wrench.
- 3) In installing a drive chain, note the direction of the master link retaining clip.
- 4) Adjust the clutch as per the instructions described earlier in this manual.



## ● ENGINE

### 1. CLUTCH

In the clutch assembly of TL125, four friction discs and four clutch plates are incorporated, each one plate less than those of CB/CL/SL100 and CB/CL/SL 125 S models. The following shows an exploded view of the clutch so that the relative positions of the parts can be seen. (Fig. 30)

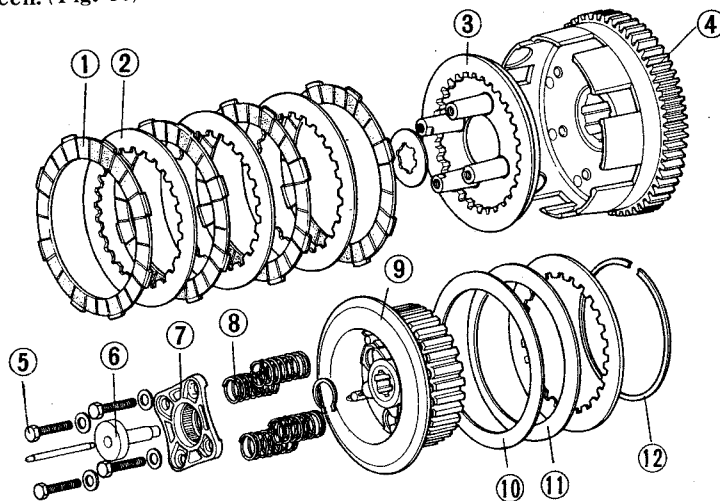

Fig. 30 ① Friction disc ② Clutch plate ③ Clutch pressure plate ④ Clutch outer ⑤ Clutch lifter rod  
⑥ Clutch lifter guide pin ⑦ Clutch lifter plate ⑧ Clutch spring ⑨ Clutch center ⑩ Disc spring seat  
⑪ Clutch spring disc ⑫ Set ring (82.5mm)

#### Removal

- 1) Remove the kick pedal and right crankcase cover in the order in (Fig. 3).
- 2) Disengage the clutch wire end at the crankcase cover.
- 3) Remove the split pin; take out the clutch lifter cam, clutch spring and clutch lever.  
(Fig. 31)

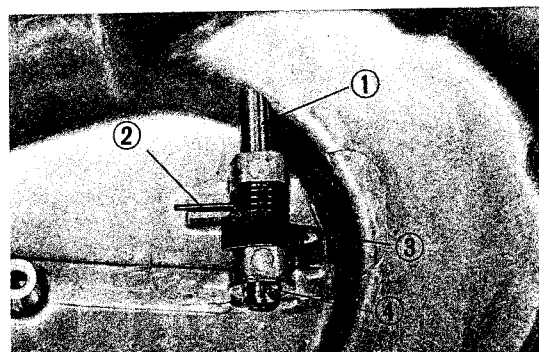

Fig. 31 ① Clutch lever ② Clutch spring  
③ Clutch lifter cam ④ Split pin

- 4) Remove the clutch lifter rod. Follow the items listed on page 25.

Reverse the order of the removal to install the clutch lever.

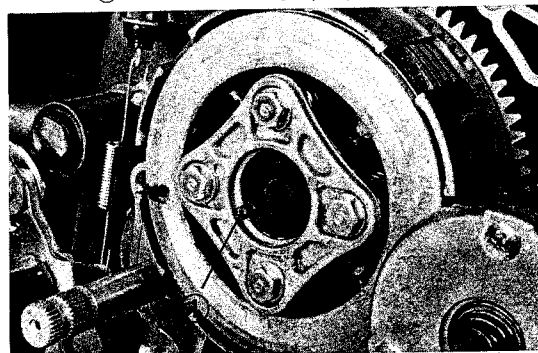

Fig. 32 ① Clutch lifter rod

## 2. TRANSMISSION

The transmission used on TL 125 is essentially the same as those used on CB/CL/SL100 and CB/CD/SL 125S except for the gear arrangement on the main shaft and the resultant changes in the shift drum groove. (Fig. 33)

Disassembly, inspection and assembly procedures will not be shown here since these are identical to those of CB100. See pages 32 thru 35.

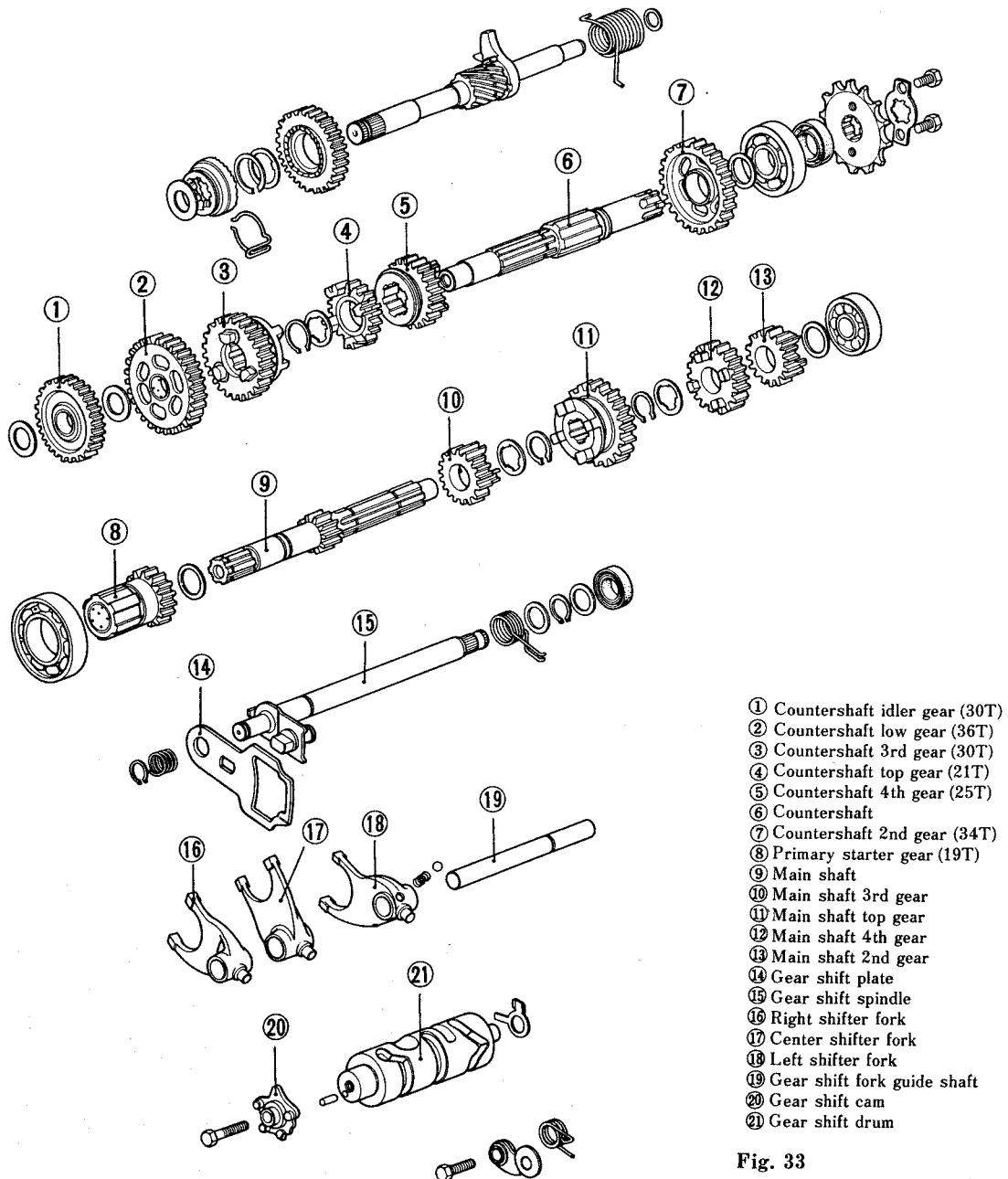

Fig. 33

## ● CHASSIS

### 1. BRAKE ARM

After putting the brake panel assembly on the wheel hub, install the brake arm on the brake camshaft, aligning the mark on the arm with index on the shaft. (Fig. 34)

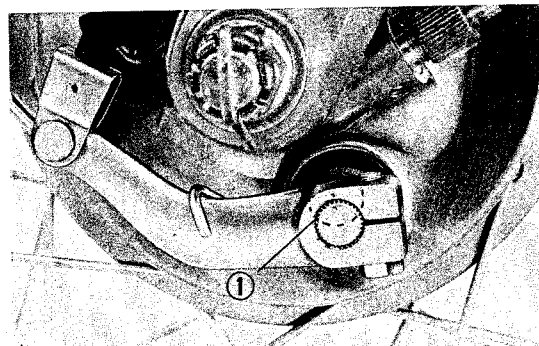

Fig. 34 ① Aligning marks

### 2. HANDLEBAR

Be sure and keep the punch mark on the handlebar flush with the top face of the holder as shown. (Fig. 35)

#### Note:

After making sure that the punch mark and top face of the holder match up, tighten the holder firmly, starting with the front toward the rear.

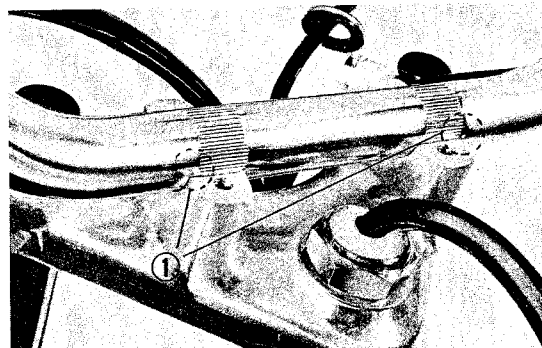

Fig. 35 ① Punch mark

### 3. CABLES AND LEAD WIRES

All cables and lead wires should be positioned as per the instructions given in Figs. 36 and 37.

#### Note:

Be sure that cables and wires are not binding or stressed when the handle is operated between two extremes.

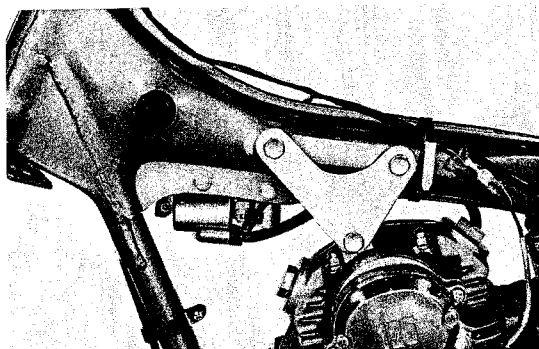

Fig. 36

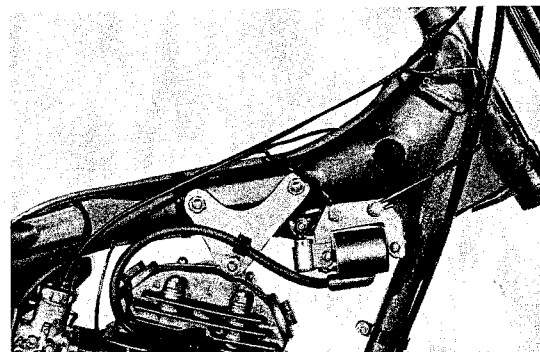

Fig. 37

## 4. FRONT SUSPENSION

	stroke	damping force
TL125	152mm	15~20kg/0.5m/sec

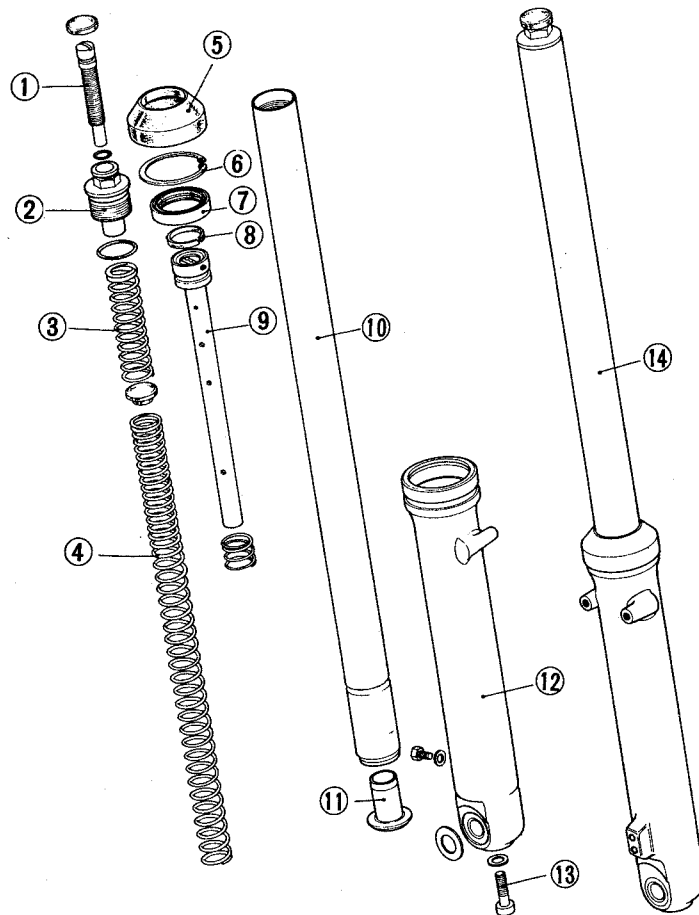

Fig. 38

- |                            |                          |
|----------------------------|--------------------------|
| ① Spring adjuster          | ⑧ Piston ring            |
| ② Fork bolt                | ⑨ Under seat             |
| ③ Front cushion spring "A" | ⑩ Front fork pipe        |
| ④ Front cushion spring "B" | ⑪ Oil lock piece         |
| ⑤ Front fork dust seal     | ⑫ Front fork bottom case |
| ⑥ Inner snap ring (45mm)   | ⑬ Fork bolt cap          |
| ⑦ Oil seal (31×43×12.5)    | ⑭ Front fork Assy        |

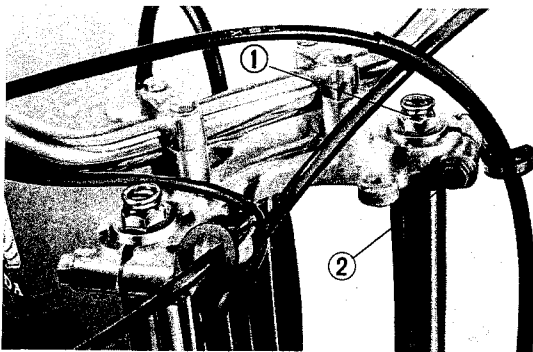

Fig. 39 ① Front fork bolt ② Clamp bolts

## A. DISASSEMBLY NOTES

- 1) Remove the front wheel. For details, see page 37.
- 2) Before removing each front fork, remove the fork bolt and drain bolt.
- 3) Move the front fork to drain the oil.
- 4) Loosen the upper and lower clamp bolts and pull the front fork down.

- 5) Separate the bottom case from the front fork pipe by removing the fork bolt cap.  
To remove, use tool "Hollow set Wrench 07917-3230000."
- 6) Remove the dust seal. Remove the snap ring by using plier. (Fig. 40)
- 7) Separate the fork pipe from the bottom pipe.
- 8) Separate the underseat from the front fork pipe.
- 9) Remove the oil seal.

### B. INSPECTION

- 1) Examine if the front fork piston ring is not worn.
- 2) Check the suspension spring for free length and as-installed tension.
- 3) Inspect the front bottom case for wear.
- 4) Determine if the fork pipe is not cracked or damaged excessively beyond use.

### C. ASSEMBLY

- 1) Wash all parts thoroughly in cleaning solvent.
- 2) Slide the under seat into place in the fork pipe; insert the suspensions spring. (Fig. 41)

**Note:**

Before installation, apply Automobile automatic transmission fluid.

- 3) Assemble the fork pipe with the bottom case.

**Note:**

Use suitable sealer to the fork bolt cap

- 4) Drive the oil seal into place in the bottom case. Use tool "Oil Seal Installer. 07947-3550000. (Fig. 42)
  - 5) Place the snap ring in the groove in the bottom case. Make sure it seats properly.
  - 6) Pour the specified amount of HONDA automobile automatic transmission fluid in the front fork. (Fig. 43)
- Specified quantity..... 4.4~4.70ozs  
(130~140cc)

**Note:**

The fork should be filled with the fluid be-

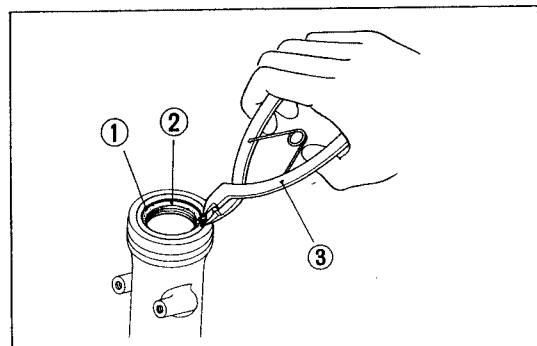

Fig. 40 ① Snap ring ② Oil seal ③ Snap ring plier

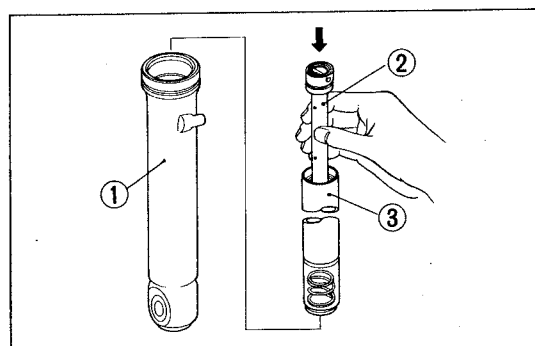

Fig. 41 ① Front fork bottom pipe  
② Bottom pipe ③ Fork pipe

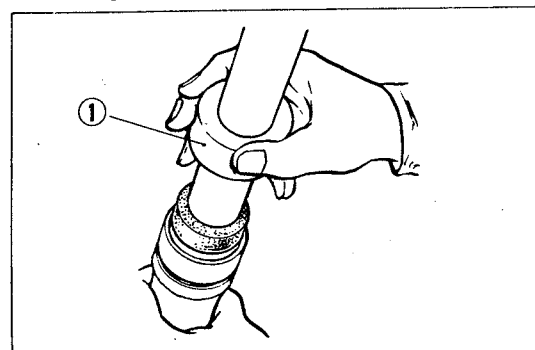

Fig. 42 ① Oil seal installer

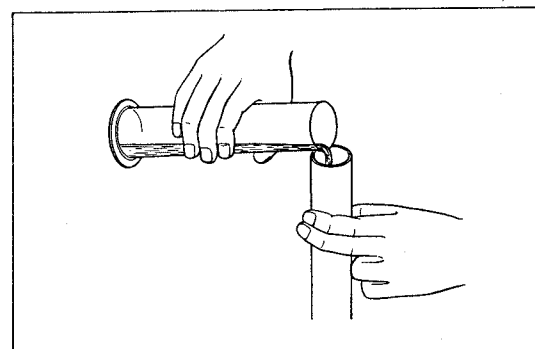

Fig. 43

## ● ELECTRICAL SYSTEM

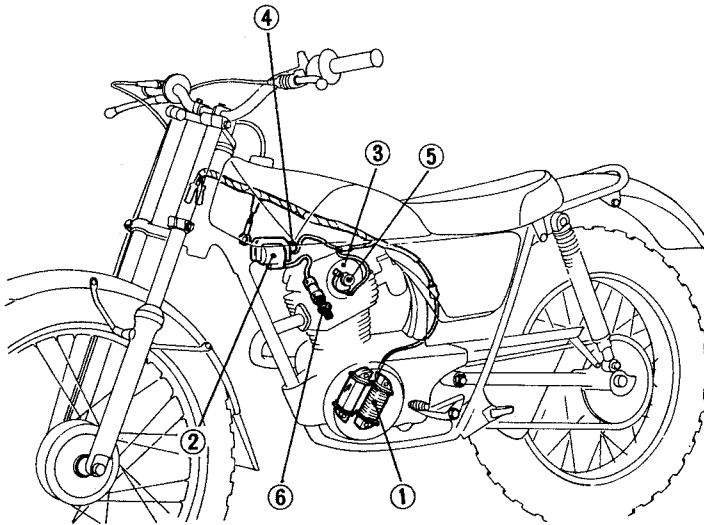
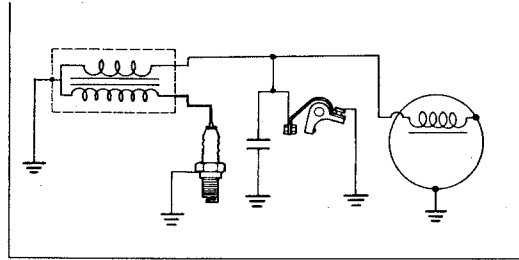

Fig. 44

- ① Generator coil
- ② Ignition coil
- ③ Contact breaker
- ④ Condenser
- ⑤ Spark advancer
- ⑥ Spark plug

Referring to the illustration above, the ignition system consists of the generator, ignition coil, contact breaker, condenser, spark advance mechanism and spark plug to ignite the air-fuel mixture in the engine cylinder.

### Technical Data

Ignition coil	Spark length (3-needle)	7mm min @ 500 rpm
Spark plug	Type	D-8ESL (NGK) X-24ES (DENSO)
	Gap	0.6 to 0.7mm
Contact breaker	Point pressure	800 ± 100g
	Point gap	0.35mm ± 0.05mm
Condenser	Capacity	0.24 μF
	Insulation resistance	10MΩ (by 1000V Megger)
Spark advancer	Advance angle	8.5° ± 1.5°
	Camshaft rpm at 1° advance	1100 ± 100 rpm
	Engine rpm at full advance	2000 ± 100 rpm

## 1. GENERATOR

The generator is fundamentally an A.C. generator, with the rotor built in the engine flywheel. The design is essentially the same as that used on SL250S. Current available at the generator operates the ignition system to supply high-voltage surges to the spark plug in the engine cylinder.

## 2. A.C. GENERATOR

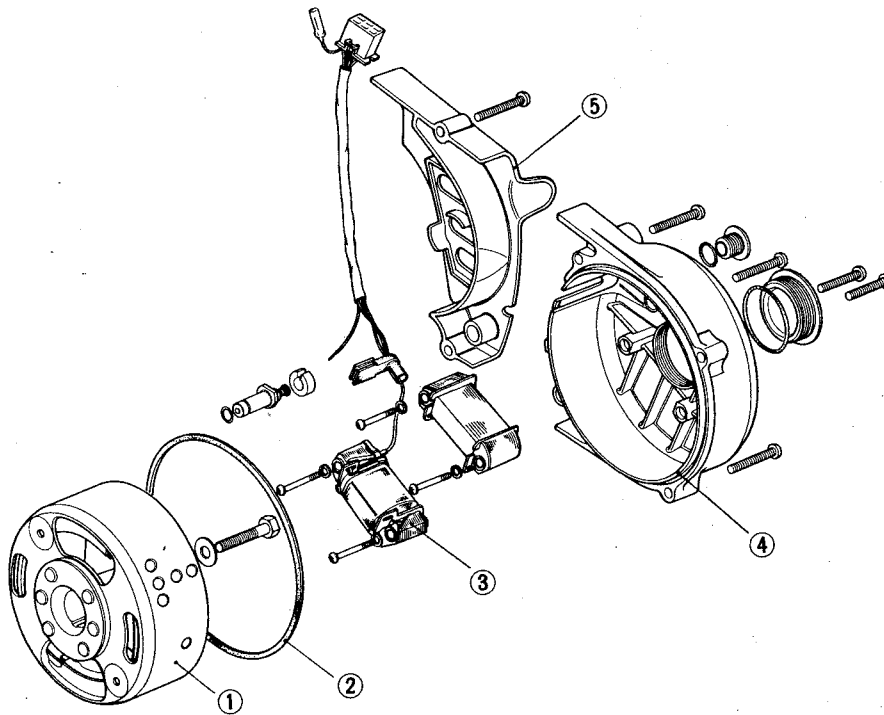

Fig. 45

- ① Flywheel
- ② Oil seal
- ③ Primary coil
- ④ Left crankcase cover
- ⑤ Left crankcase rear cover

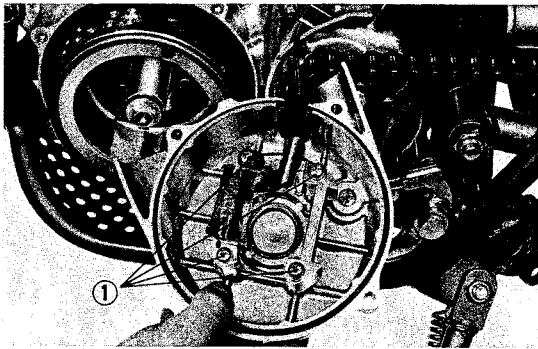

Fig. 46 ① Stator mounting bolt

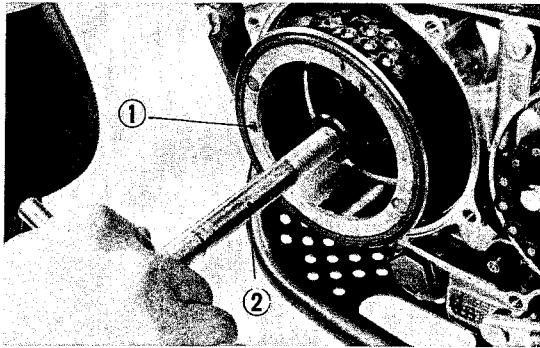

Fig. 47 ① Flywheel ② Flywheel extractor

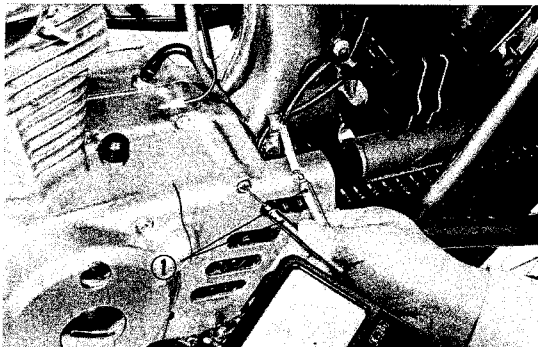

Fig. 48 ① Tester probes

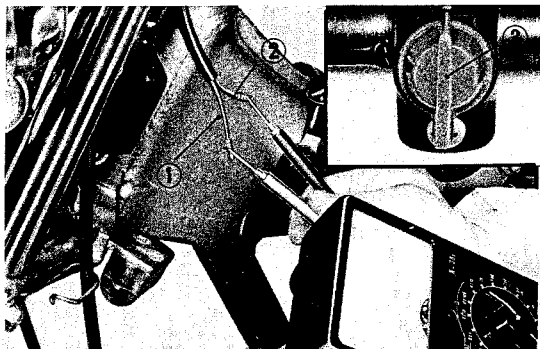

Fig. 49 ① Black/White ② Green ③ Mainswitch

### A. Removal

- 1) Remove the two crankcase covers, front and rear, from the left side of the engine.
- 2) Remove the stator by loosening off the attaching bolts.
- 3) Remove the primary coil by loosening off the Stator mounting bolt (Fig. 47)

- 4) With the help of tool "Flywheel Extractor 07011-20001," remove the flywheel while lightly tapping it around with the right hand. (Fig. 48)

### B. Stator Inspection

When failure to start is due to broken stator coil, this can be checked with a tester. To make this check, disconnect the stator cord, black stripes on white ground, at the wiring connector. Hold a test prod against the connector, and the other against the metal part of the stator. If continuity exists, it indicates the stator coil is not broken or discontinued.

## ● INSPECTION OF ELECTRICAL ACCESSORIES

### 1. MAIN SWITCH

If the engine fails to stop with the ignition switch in OFF, the likelihood is that the switch is internally short-circuited. The ignition switch test is made by first disconnecting the primary lead (black/white) and that of the neutral switch and then checking continuity between the lead with a tester. If continuity exists when the kill switch is turned on, it is probable that the switch is defective, calling for replacement.



### TABLE OF OPTIONAL PARTS

No.	Part Name	Description	Application	Remarks
1	Rear wheel tire	1) New, wider tread tire with special tread pattern (about 10mm wider than standard specification) 2) Tire size same as standard type 3) Featuring more bite on swampy underfoot conditions or on slope in trial race	1) Chain case to be removed  2) Trial race only	Off-road use only
2	Tire gauge (psi)	1) For measuring tire pressure in pound-inch system 2) Gauge dial: 5 to 35 psi		
3	Air pump	1) Portable air pump to inflate tires to standard pressure when driving on public road after racing		
4	Air pump brackets	1) Air pump lower bracket 2) Air pump upper bracket	1) Tightened with left upper of engine hanger plate 2) Fastened with 12mm bolt along with frame body downtube	
5	Front fork stiffener	1) To improve structural rigidity of front fork for higher trial racing	(Mounting location) Left of bottom bridge on the bottom, and right of top bridge on the upper, as viewed from front of motorcycle	
6	Zechin plate	1) For number or code assigned during race	1) Fastened with band to front fork stiffener	
7	Zechine band		1) Tightened to front fork stiffener with two 6mm bolts and zechine plate	
8	Direct type gear change pedal	For use in higher class trial racing	1) Directly attached to gear change pedal spindle in place of link type pedal	

## MAINTENANCE SCHEDULE

The maintenance intervals shown in the following schedule are based upon average riding conditions. Machines subjected to severe use, or ridden in unusually dusty areas, require more frequent servicing.

Items marked with\* should be serviced by an

authorized Honda dealer, unless the owner has proper tools and is mechanically proficient.

Other maintenance items are simple to perform and may be serviced by the owner.

<p style="text-align: center;"><b>INITIAL SERVICE PERIOD</b></p> <p style="text-align: center;"><b>FIRST WEEK OF OPERATION</b></p>	<ul style="list-style-type: none"> <li>● ENGINE OIL—Change.</li> <li>● *CONTACT POINTS AND IGNITION TIMING—Clean, check, and adjust or replace if necessary.</li> <li>● *VALVE TAPPET CLEARANCE—Check and adjust if necessary.</li> <li>● *CARBURETOR—Check and adjust if necessary.</li> <li>● THROTTLE OPERATION—Inspect cable. Check and adjust free play.</li> <li>● *CLUTCH—Check operation and adjust if necessary.</li> </ul>	<ul style="list-style-type: none"> <li>● DRIVE CHAIN—Check, lubricate, and adjust if necessary.</li> <li>● BRAKE CONTROL LINKAGE—Check linkage and adjust if necessary.</li> <li>● TIRES—Inspect and check air pressure.</li> <li>● ALL NUTS, BOLTS, AND OTHER FASTENERS—Check security and tighten if necessary.</li> <li>● *WHEELS, RIMS, AND SPOKES—Check. Tighten spokes and true wheels if necessary.</li> </ul>
<p style="text-align: center;"><b>EVERY 30 OPERATING DAYS</b></p> <p style="text-align: center;"><b>NOTE</b> Change oil every 30 operating days or every 3 months, whichever occurs first.</p>	<ul style="list-style-type: none"> <li>● ENGINE OIL—Change.</li> <li>● SPARK PLUG—Clean and adjust gap, or replace if necessary.</li> <li>● *CONTACT POINTS AND IGNITION TIMING—Clean, check, and adjust or replace if necessary.</li> <li>● *VALVE TAPPET CLEARANCE—Check and adjust if necessary.</li> <li>● POLYURETHANE FOAM AIR FILTER ELEMENT—Clean and oil. Service more frequently if operated in dusty areas.</li> <li>● *CARBURETOR—Check and adjust if necessary.</li> <li>● *WHEELS, RIMS, AND SPOKES—Check. Tighten spokes and tire wheels if necessary.</li> </ul>	<ul style="list-style-type: none"> <li>● *CAM CHAIN TENSION—Adjust (only initial service).</li> <li>● THROTTLE OPERATION—Inspect cable. Check and adjust free play.</li> <li>● *CLUTCH—Check operation and adjust if necessary.</li> <li>● DRIVE CHAIN—Check, lubricate, and adjust if necessary.</li> <li>● BRAKE CONTROL LINKAGE—Check linkage and adjust if necessary.</li> <li>● TIRES—Inspect and check air pressure.</li> <li>● ALL NUTS, BOLTS, AND OTHER FASTENERS—Check security and tighten if necessary.</li> </ul>
<p style="text-align: center;"><b>EVERY YEAR</b></p>	<ul style="list-style-type: none"> <li>● FUEL FILTER SCREEN—Clean.</li> <li>● FUEL LINE—Check.</li> <li>● FRONT FORK OIL—Drain and refill.</li> <li>● *OIL FILTER SCREEN—Clean.</li> <li>● *CENTRIFUGAL OIL FILTER—Clean.</li> <li>● *FRONT AND REAR SUSPENSION—Check operation.</li> <li>● *STEERING HEAD BEARINGS—Adjust.</li> <li>● *BRAKE SHOES—Inspect and replace if worn.</li> <li>● *CAM CHAIN TENSION—Adjust.</li> </ul>	

## SPECIFICATIONS

	Item	English	Metric	
Dimension	Overall length	78.5in.	1.995mm	
	Overall width	33.1in.	840mm	
	Overall height	43.1in.	1.095mm	
	Wheel base	50.4in.	1.280mm	
	Seat height	30.7in.	780mm	
	Foot peg height	13.2in.	335mm	
	Ground clearance	10.2in.	260mm	
	Dry weight	194lbs.	88kg	
Frame	Type	Semi double cradle		
	F. suspension, travel	Telescopic fork, travel 6.0in. (152mm)		
	R. suspension, travel	Swing arm, travel 3.7in. (94mm)		
	F. tire size, pressure	2.75-21 (4PR), Semi-Knobby, tire air pressure 1.5kg/cm <sup>2</sup> 21psi		
	R. tire size, pressure	4.00-18 (4PR), Semi-Knobby, tire air pressure 1.5kg/cm <sup>2</sup> 21psi		
	F. brake, lining area	Internal expanding shoes, swept area 13.4sq·in (86.4 sq-cm)		
	R. brake, lining area	Internal expanding shoes, swept area 13.4sq·in (86.4 sq-cm)		
	Fuel capacity	1.2 US gal.	4.5 lit.	
	Fuel reserve capacity	0.1 US gal	0.5 lit.	
	Caster angle	61° 30'		
	Trail length	4.1in.	105mm	
Engine	Type	Air cooled, 4-stroke OHC engine		
	Cylinder arrangement	Single cylinder 15° inclined from vertical		
	Bore and stroke	2.204 × 1.949in.	56.0 × 49.5mm	
	Displacement	7.44 cu-in	122 cc	
	Compression ratio	8.0 : 1		
	Valve train	Chain driven over head camshaft		
	Maximum horsepower	8.0 BHP/8,000 rpm		
	Maximum torque	5.55 lb-ft/4,000rpm	0.83 kg-m/4,000rpm	
	Oil capacity	1.1 US qt.	1.0 lit.	
	Lubrication system	Forced and wet sump		
	Cylinder head compression pressure	12 kg/sq-cm at 1,000 rpm		
	Intake valve	Opens	BTDC 0°	
		Closes	ABDC 30°	
	Exhaust valve	Opens	BBDC 35°	
		Closes	ATDC 0°	
Valve tappet clearance	0.0002 in.	0.05 mm		
Idle speed	1,300 rpm			
Drive train	Clutch	Wet, multi plates		
	Transmission	5-speed constant mesh		
	Primary reduction	4.055		
	Gear ratio I	2.769		
	Gear ratio II	2.125		
	Gear ratio III	1.578		
	Gear ratio IV	1.000		
	Gear ratio V	0.724		
	Final reduction	4.000, drive sprocket 15T, driven sprocket 60T		
	Gear shift pattern	Left foot operated return system		
Electrical	Ignition	Flywheel magneto		
	Starting system	Kick starter		
	Alternator	A. C. generator		
	Spark plug	NGK D 8ES-L or ND X 24ES		

### TL 125 WIRING DIAGRAM

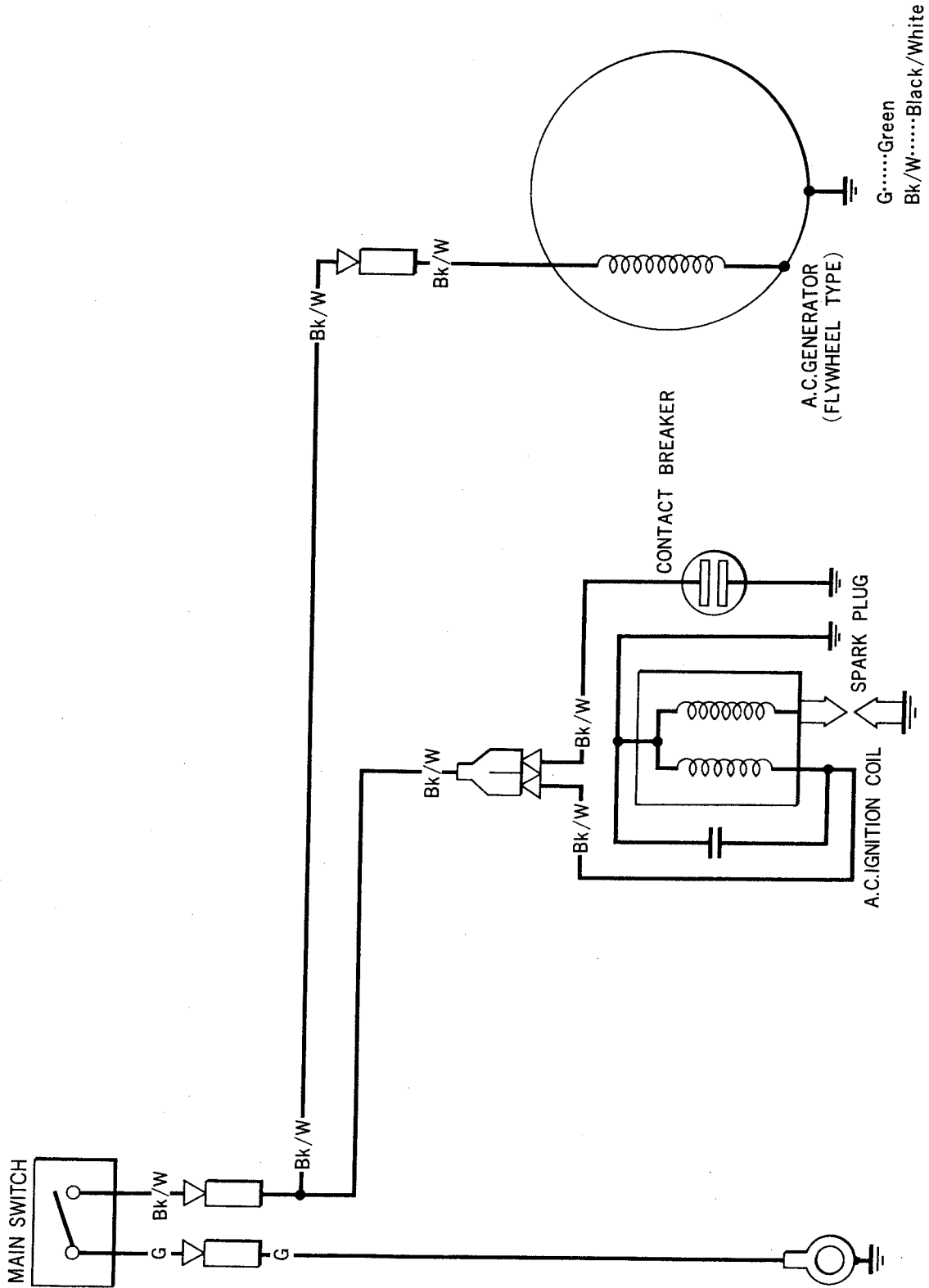

# INDEX

- A -
- Adjust ignition timing ..... 6, 77
- valve tappet clearance.. 5, 77
- cam chain ..... 9, 78
- carburetor ..... 5, 35, 77
- A.C. generator ..... 53, 91
- Air cleaner ..... 9, 50-51, 78
  
- B -
- Battery ..... 11, 56, 58
- Brakes ..... 10, 37, 40, 87
- Brake drum ..... 38, 41
- Brake lining ..... 38, 41
- Brake lever travel ..... 10
- Brake pedal travel ..... 10
- Bore and stroke ..... 67
- Bulb ..... 67
  
- C -
- Cam chain tensioner ..... 9, 29, 78
- Carburetor ..... 5, 35, 77
- Camshaft ..... 15, 18
- Change oil and oil filter ..... 8
- Charging system ..... 54
- Clutch ..... 7, 25, 85
- Compression ratio ..... 67
- Contact breaker ..... 6
- Crankshaft ..... 30
- Curb weight ..... 67
- Cylinder bore ..... 16
- Cylinder head ..... 15
  
- D -
- Displacement ..... 67
- Drive chain ..... 11, 42
  
- E -
- Engine installation ..... 15, 83
- oil drain plug ..... 8
- removal ..... 14
- Electrical ..... 53, 85
- Emergency switch ..... 60
  
- F -
- Final reduction ..... 67
- Front brake ..... 37
- Frame body ..... 50
- Front suspension ..... 45, 88
- Front wheel and tire ..... 37
- Fuel tank capacity ..... 67
- Fuel tank ..... 50, 51
- Front fork oil change ..... 81
- Front Suspension Spring  
Adjustment ..... 81
  
- G -
- Gear change pedal ..... 27
- Gear ratio ..... 67
- Gear shift drum ..... 34
- Gear shift drum stopper ..... 28
- Gear shift fork ..... 27
- Generator ..... 53, 91
- Gear shift mechanism ..... 27
  
- H -
- Headlight ..... 46
- High beam ..... 60
- Horn ..... 59
  
- I -
- Idling speed ..... 5
- Ignition timing ..... 6
- Ignition system ..... 55
- Ignition coil ..... 55
  
- K -
- Kick starter ..... 32
  
- L -
- Lubrication system ..... 22
  
- M -
- Main ignition switch ..... 58
- Maintenance ..... 5
  
- N -
- Neutral switch ..... 34
  
- O -
- Oil filter ..... 8, 22
- screen ..... 8
- Oil pump ..... 22
- Oil gauge ..... 8
  
- P -
- Piston ..... 15
- Piston pin ..... 16
- Piston ring ..... 17
- Primary reduction ..... 67
  
- R -
- Rear brake ..... 40
- Rear shock absorber ..... 48
- Rear fork ..... 48
- Rear wheel and tire ..... 40
- Rocker arm ..... 21
- shaft ..... 21
  
- S -
- Service air cleaner ..... 2
- battery ..... 11
- spark plug ..... 5
- Spark advancer ..... 19
- Spark plug ..... 5
- Special tools ..... 2
- Stop switch ..... 59, 59
  
- T -
- Tail/stop light ..... 67
- Technical data ..... 67
- Torque table ..... 1
- Turning circle ..... 67
- Timing the valves ..... 6
- Tire size ..... 67
- Transmission ..... 32
- Turn signal switch ..... 59
- /horn switch ..... 59
  
- V -
- Valve ..... 20
- Valve timing ..... 6
  
- W -
- Wiring diagram ..... 69-74