

**IMPORTANT SAFETY INSTRUCTIONS  
INCLUDED. READ THROUGH CAREFULLY  
BEFORE YOU RIDE.**

**NVS**  
*Today*



# Safety Warnings

---

## <About this Manual>

\* This manual contains information for the correct handling, safe riding and basic maintenance of your motorcycle. Please read through "**Safety Warning**", "**Safe Riding**" and "**Maintenance Safety Tips**" as they are particularly important.

\* Even if you are already familiar with motorcycles, please read this manual as this model has some special features. Please also read the maintenance notes.

\* When re-selling this motorcycle, please hand this manual and the maintenance record to the next owner.

\* Honda Motor Co., reserves the right to alter specifications and make other changes at any time without notice or obligation.

## <Safety Warning>

The following safety warnings are used in this manual to alert you to potential dangers to the rider, passenger and others. Always read the warnings thoroughly.



**Warning:** High Potential for causing death or severe injury.



**Caution:** Potential for causing death or severe injury.



**Note:** Potential for minor injury.

### \* Other symbols:



**Advice:** To keep the motorcycle in peak condition.



**Tips:** To ensure best performance and pleasant riding.

# Contents

Safe Riding Tips	4
Features	10
Instruments	12
Speedometer	12
Odometer	12
Instruments	13
Brake System	13
Ignition Switch	13
Switches	14
Starter Switch	14
Hi/Lo Beam switch	15
Indicator Switch	15
Horn Switch	15
Steering Lock	16
Engaging/Disengaging	16
Convenience Hook	16
Seat	17
Boot	18
Helmet Holder	19
Document Holder	20
Brake Lock Lever	21

Refuelling	22
Refuelling Procedure	22
Starting the engine	23
Starting Procedure	24
Kick Start Engine	26
Correct Riding	28
Stopping the M/cycle	30

## STATIONARY NOISE TEST INFORMATION

- TESTED 76.6dB (A) AT 4000 rpm
- SILENCING SYSTEM : HONDA
- IDENTIFICATION : HM GFC K1

NVS503901

Maintenance Safety	.....32
Maintenance Information	.....34
Daily Inspection	.....36
Regular Service	.....38
Brakes	.....40
Adjusting Free Play	.....40
Tyres - Checks	.....42
Engine Oil	.....44
Battery	.....46
Fuses	.....48
Transmission	.....49
Air Filter	.....50
Rubber Boots	.....51
Breather Drain	.....51

Caring for your M/cycle	.....52
Storing your M/cycle	.....53
Environmental	.....54
Coloured Parts	.....54
Genuine Honda Parts	.....54
Identification Numbers	.....55
Number Locations	.....55
Troubleshooting	.....55
Specifications	.....56

## Tips for Safe Riding

Correct Protective Clothing and Helmet are essential for safe riding. Observe road regulations and never speed, for your own safety.

Topics covered in the following pages are some basic instructions for your daily handling of this motorcycle. Again, these are for your own safety.

An overspeed warning light is installed on this vehicle. This is fitted for other markets and is not applicable to Australia - Please disregard.

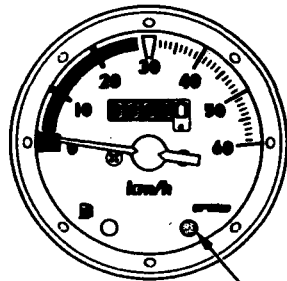

Overspeed warning Light

The maximum capacity of this vehicle is one person. Carrying a pillion passenger is prohibited.

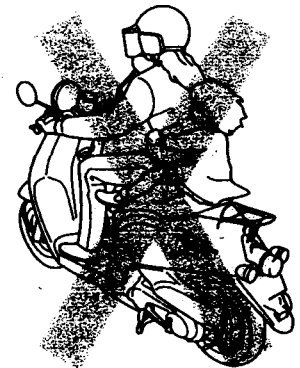

## Before Riding

Please carry out a daily inspection and keep the vehicle clean. See page 34 for details of the daily inspection.

Also, you should arrange a regular maintenance check. For details, see page 36.

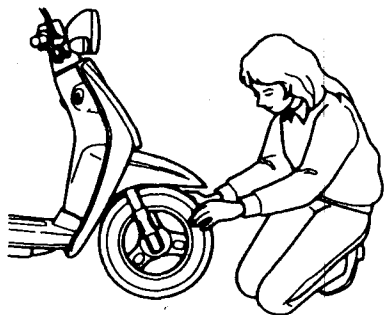

Always stop the engine and keep away from flames, or other possible ignition sources when refuelling.

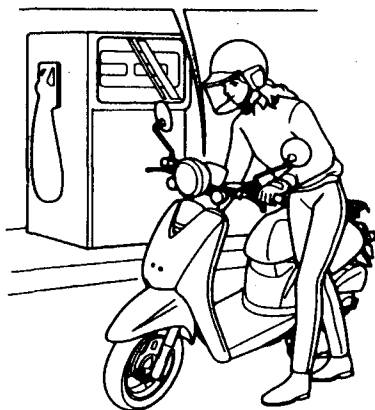
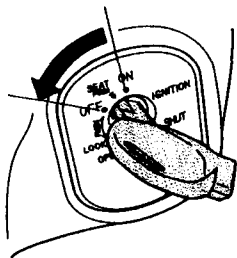

Exhaust fumes contain carbon monoxide and other toxic gas. It is essential that the engine is run only in a well ventilated place.



## Tips for Safe Riding

It is required by law for all riders to wear a helmet when riding a motorcycle. It is vital that you wear a helmet properly and that the helmet is approved to Australian Standard AS1698.

Wearing protective gear and clothing is strongly recommended, such as:

- face shield or goggles
- footwear which covers up to the ankles.
- strong leather gloves
- long sleeved jacket and long trousers.

in terms of clothing, we recommend:

- bright coloured and allow ease of movement.
- avoid wide open cuffs as they may interfere with brake lever operations.

### WARNING

It is vital that you wear a helmet properly, to reduce the risk of fatal or serious injury in the event of an accident. It is also essential that your helmet fits you correctly.

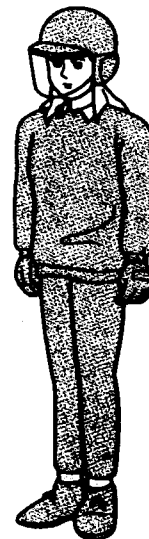



## Riding Position

When riding, always use both hands to hold the handlebar and keep your feet firmly on the floor.



Always avoid abrupt steering movements and single-handed riding. These are basic safety rules and may cause you to lose control of the motorcycle.

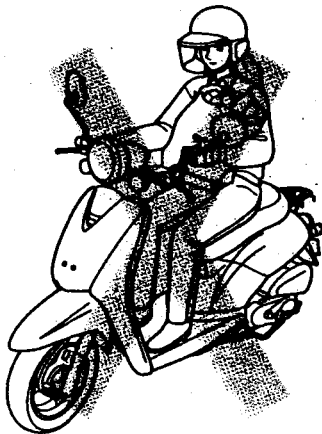

## Loading

Loading of cargo changes the feel and handling of the motorcycle. Overloading may result in dangerously unstable steering.

The correct load limits are shown below:



- Please do not hang large items on the convenience hook as they may interfere with the steering.
- Objects placed near the handlebar may interfere with the steering. Keep the area well clear at all times.
- Do not obstruct the head light with any object. The heat from the light may melt the lens or the object.
- Do not put heavy objects in the Under Seat storage area as they may damage the inner surfaces.
- Do not load objects in anywhere other than the designated carrying areas, as the vehicle may be damaged or become unstable.

### Modification:

Modifications affecting the vehicle structure or its performance may change the vehicle controllability or its handling characteristics. Such modifications are illegal and may reduce the life of the product.

Also, it should be noted that modifications to the motorcycle may affect the Warranty.

This motorcycle complies with the latest Australian Noise Emissions regulations. Any modification affecting the Noise Control Systems are prohibited and may render the motorcycle unroadworthy.

## Parking the Motorcycle

In order to prevent your motorcycle being stolen, always lock the steering when leaving your motorcycle unattended.

Always close the Ignition Lock protector when leaving the motorcycle unattended.

- Always park the motorcycle on a firm, flat surface
- Always select a parking area that does not interfere with traffic flow.
- If there is no other choice but to park on a rough, sloped or soft surface, take necessary precautions to prevent the motorcycle from moving or tipping over.

- The exhaust pipe is very hot for some time after the engine is stopped. Please take necessary precautions when parking.

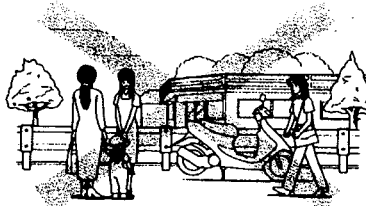
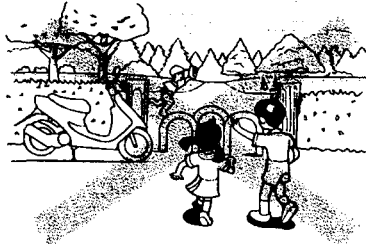

- For your safety, do not touch the engine or exhaust pipe while the engine is running, and for some time after the engine is stopped.

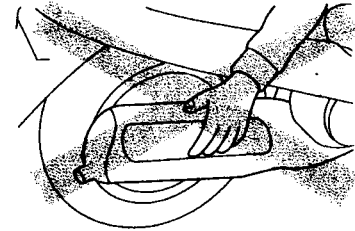

### WARNING

The engine and exhaust are very hot when the engine is running, and for some time after the engine is stopped. In order to avoid burn injury:

- Do not touch the engine or exhaust while the engine is running or soon after it has been stopped.
- Park the motorcycle so as to keep hot components away from other people.

# Features

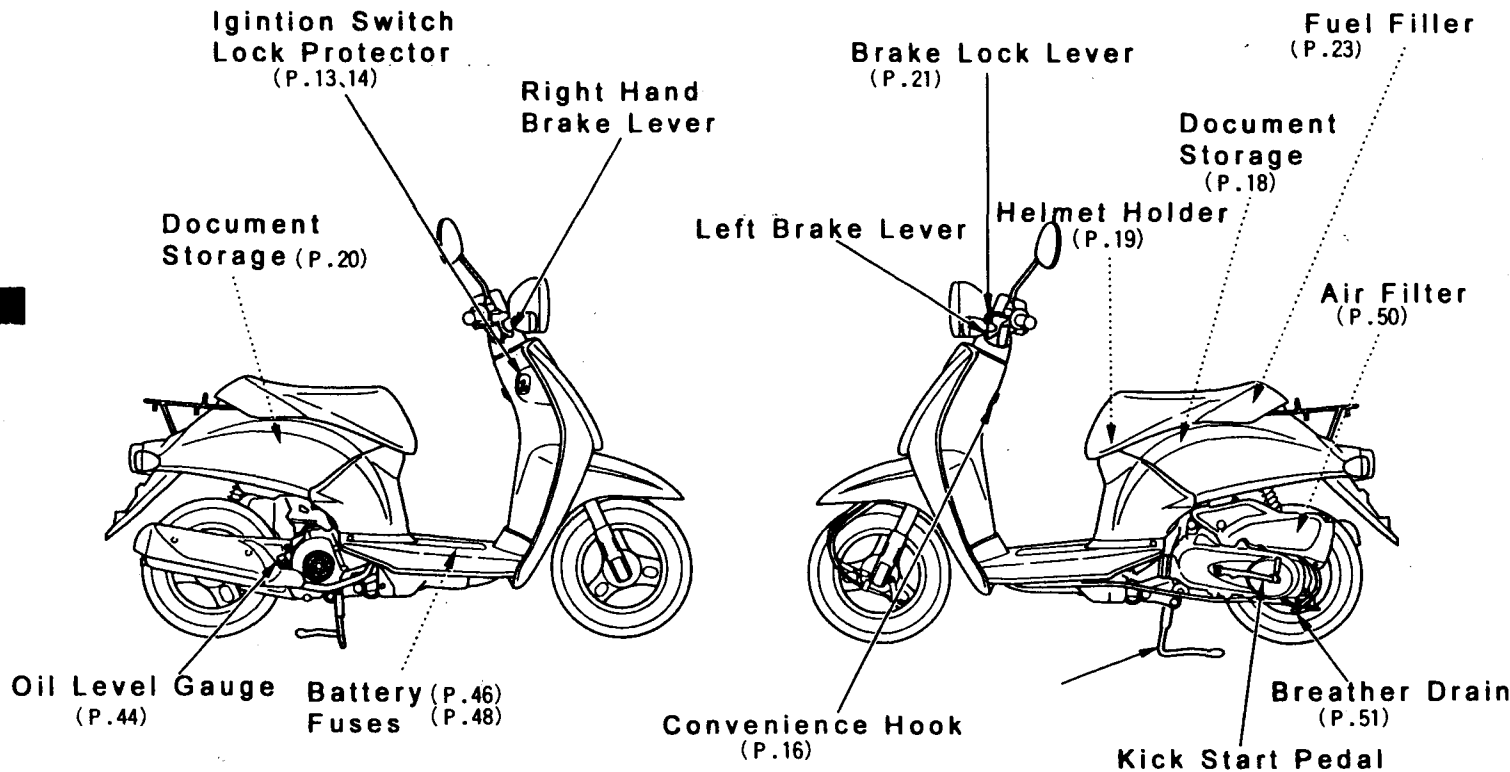

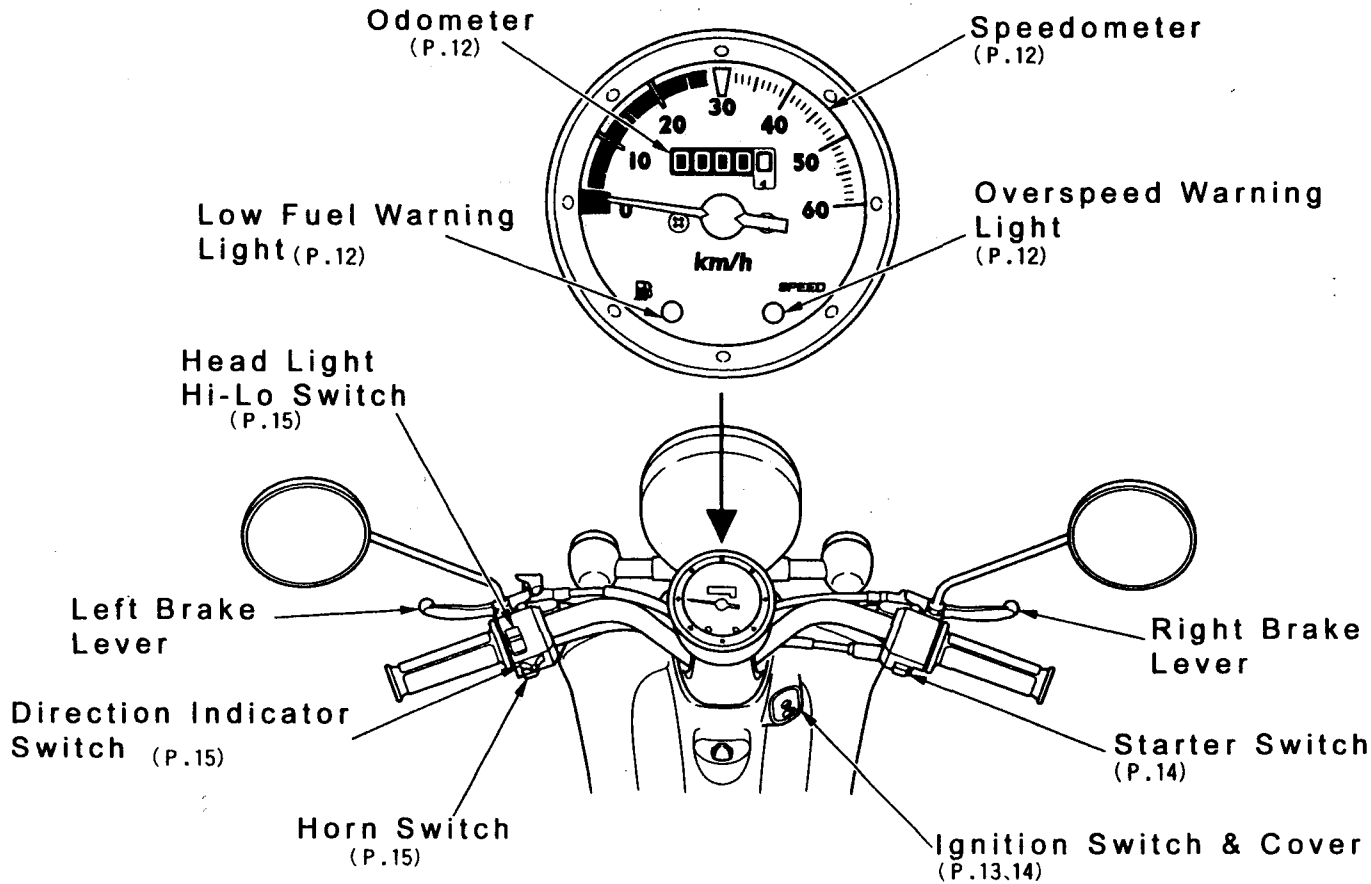

# Instruments

Odometer      Speedometer

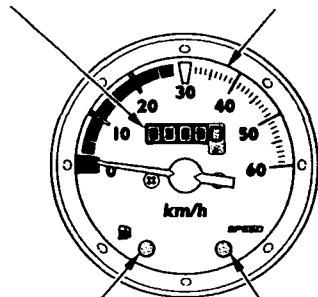

Low Fuel  
Warning

Overspeed  
Warning

## Speedometer

Indicates the vehicle speed in Km/h. Always observe the local speed limit.

## Odometer

Displays the cumulative distance travelled in km's. The last digit with white background indicates in 100 metre increments. The fourth digit, 1000km, has Amber background at 1,3,6&9. We recommend at least an oil change at these intervals.

Amber

Odometer



## Overspeed Warning

This will flash when the vehicle speed exceeds 30kph.

## Low Fuel Warning

Indicates that the fuel quantity is Low. You should refuel as soon as possible if the Low Fuel Warning illuminates, which indicates that you have 1litre of fuel remaining in the fuel tank.

# Instruments

## Combined Braking System

- The Left Brake Lever controls both the Front and Rear wheel brakes.

- The Right Brake Lever controls the Front wheel brakes only.

For most effective Braking, use both the Left and Right Brake levers at the same time.

## Ignition Switch

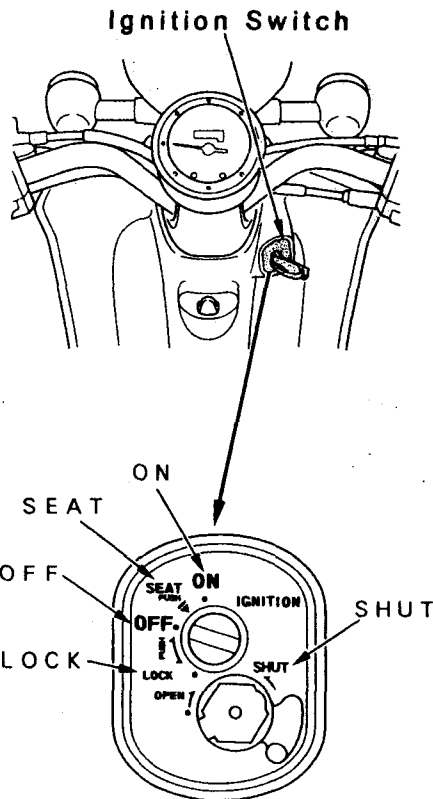

**LOCK** ... Steering is locked.  
The Ignition key can be removed.

**OFF** ... Engine is stopped.  
The Ignition key can be removed.

**SEAT** ... Seat can be opened.  
The engine cannot be started. Key is locked in.

**ON** ... The engine can be started.  
The Key is locked in.

**SHUT** ... The lock protector is Shut. (See next page.)

### Tip

• Leaving the Ignition key in the "ON" position for long periods, with the engine stopped will cause the battery to go flat.

# Switches

## Lock Protector

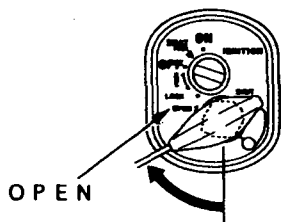
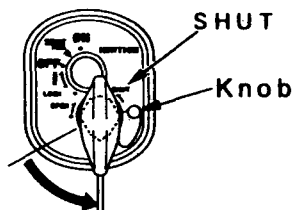
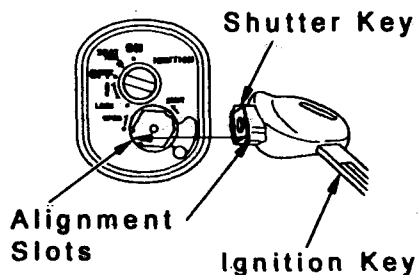

The Lock Protector is designed to help prevent theft. This should be shut whenever the motorcycle is left unattended.

**<Closing the Shutter>**  
Pull out the ignition key and insert the Shutter key. Turn it counterclockwise until the shutter closes.

**<Opening the Shutter>**  
Insert the shutter key and turn it clockwise until the shutter opens.

The Shutter Key is moulded as part of the Ignition Key. It is not a separate key.

## Starter Switch

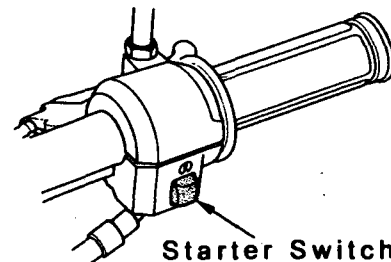

Turn the Ignition key to "ON" and apply the brakes. Push the starter switch to start the engine.

### Tip:

- The engine will not start unless brake is applied.



## Hi/Lo Beam Switch

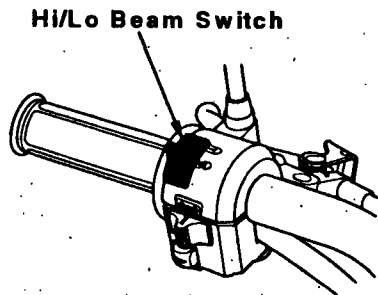

- ⇒ ... Move the switch to this position for Hi Beam.
- ⇒ ... Move the switch to this position for Lo Beam.

**Always select Lo Beam when Other traffic is approaching.**

## Indicator Switch

Indicator Switch

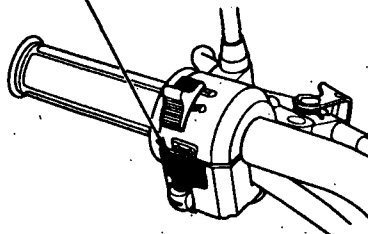

The Indicator can be selected by moving the switch to the left or right.

- ⇒ ... Move the switch to the Right for Right Hand Turn.
- ⇐ ... Move the switch to the Left for Left Hand Turn.

### Tip:

The Indicator does not self Cancel. After turning you must return the switch to the "OFF" position.

## Horn Switch

Horn Switch

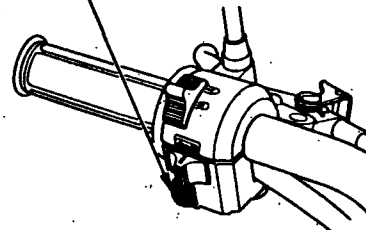

The Horn is activated by pressing the Horn Switch. The Horn will sound as long as the switch is depressed.

# Equipment

## Steering Lock

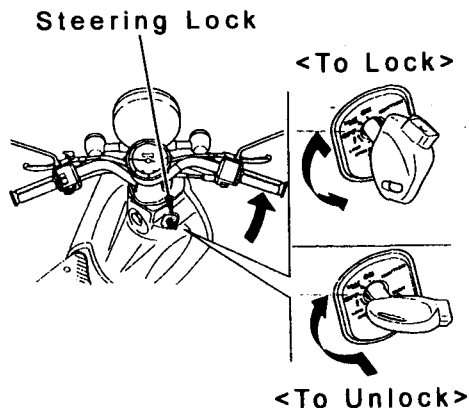

### <Engaging the lock>

Turn the Handlebar fully to the left, push in and turn the ignition key from "OFF" to "LOCK". Jiggle the handlebar if the lock does not engage immediately.

### <Disengaging the Lock>

Push in and turn the Ignition key from "LOCK" to "OFF" position.

#### Tip:

- After engaging the lock, check that it has engaged by trying to turn the bars.
- Park in an appropriate area so your m/cycle does not obstruct traffic.

Always apply the Steering Lock whenever you leave the motorcycle unattended. We also recommend using chain locks in addition to this feature.

## Convenience Hook

### Convenience Hook

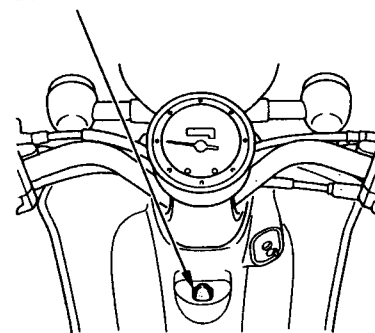

Maximum capacity of the Convenience Hook is 1.5kg.

Please do not suspend large items on the Convenience Hook. The items should be small enough not to stick out of the vehicle or interfere with your steering.

## Seat

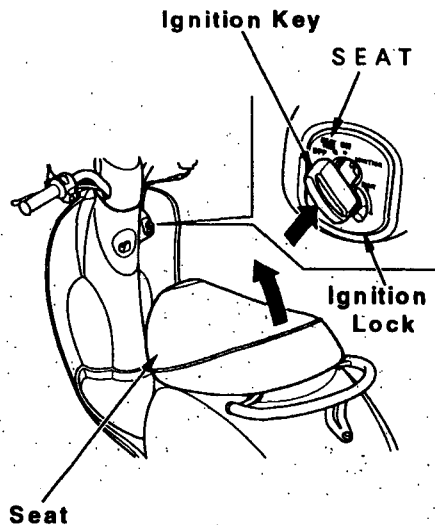

### To Open:

1. Insert the Ignition key into the Ignition Lock and turn it to the "SEAT" position. Push the Ignition key to release lock and open Seat. The seat can now be lifted up to open.

### To Close:

Lower the Seat and press down firmly on the Rear section of the seat to lock it. Riding when the Seat is not properly locked can cause interference/impered riding.

### Tip:

Once the seat is locked into position, it cannot be opened without the key. Take care to ensure that you do not lock the key under the seat.

# Equipment

## Boot

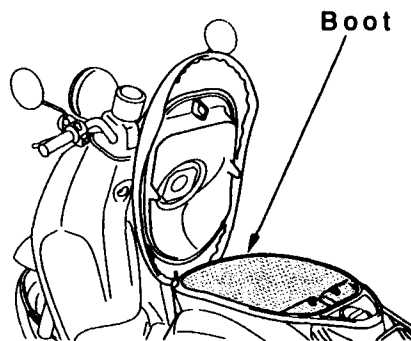

### Maximum Loading 10.0kg

- The seat can be opened by releasing its lock with the Ignition key. (Pg17).
- \_ After closing the Seat, make sure it is locked. Riding with the Seat unlocked is very dangerous.

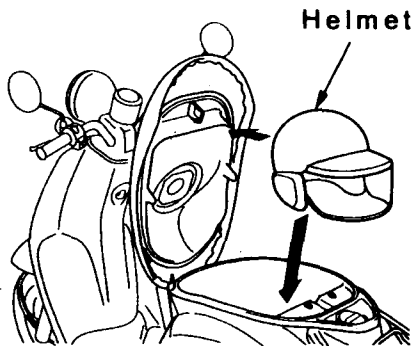

Your helmet can be stored in the boot by facing it towards the rear of the motorcycle.

### Tip:

- Make sure that the ignition key is not left inside the boot when closing it. The boot cannot be opened without it.
- \_ The temperature inside the Boot may increase due to engine heat. Do not put food or flammable items in the boot.
- \_ Do not put fragile or valuable items in the boot.
- \_ The boot is not fully waterproof.
- \_ Depending on size and shape, some helmets and boots may not fit in boot.

## Helmet Holder

Helmet Holder

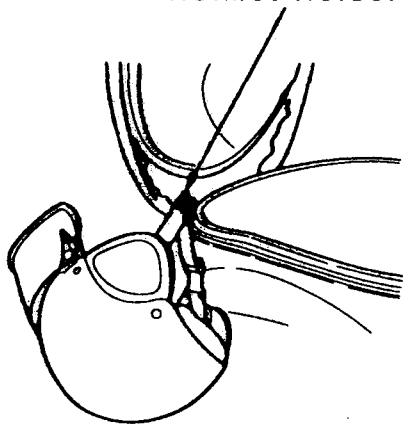

The Helmet holder is only meant to be used when the motorcycle is parked.

When riding, the helmet may disturb your riding and may damage the motorcycle and the helmet itself.

### <Suspending the Helmet>

1. Open the Seat (Pg17).
2. Hook the helmet strap buckle to the helmet holder.
3. Lower the seat and lock it by pushing down firmly on the rear section of the seat. Make sure the seat is properly locked in place.

### <Removing the Helmet>

Use the Ignition key to open the seat and remove the helmet from the hook.

### Tip:

Make sure the Ignition key is not left in the boot when closing it. The boot cannot be opened without it.

## Features

---

### Document Holder

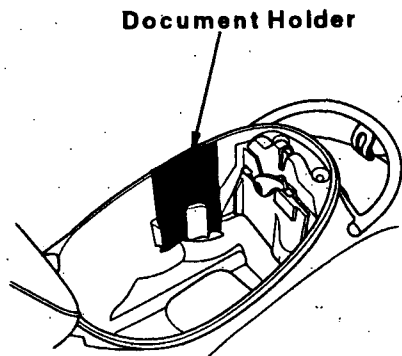

**To access the Document Holder,  
lift the Seat as per the procedure  
on page17 of this manual.**

## Brake Lock Lever

Brake Lock Lever

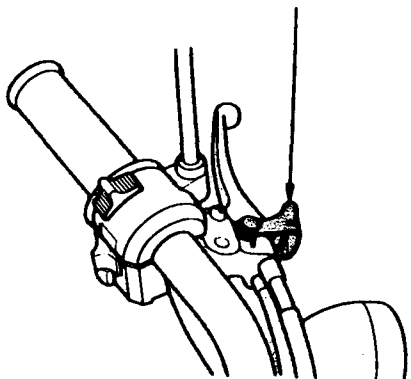

### Tip:

The Brake cannot be locked if the Rear Brake is not adjusted in accordance with the specification. (Pg38).

### <Locking the Brake>

1. Firmly grasp the left brake lever.
2. Move the Brake Lock lever in the direction shown in the diagram below and lock it in position.
3. Release the Left brake lever. The rear brake is now locked.

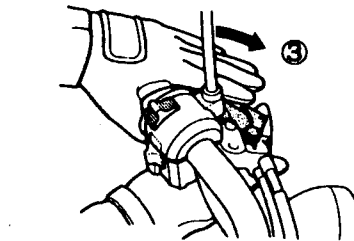
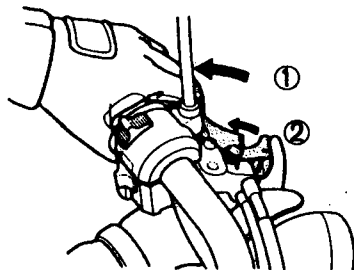

### <Unlocking the Brake>

1. Firmly grasp the left brake lever. The lock lever will disengage automatically.
2. Release the Left brake lever. The Rear brake is now disengaged.

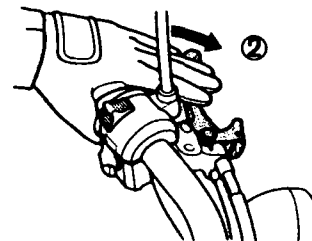
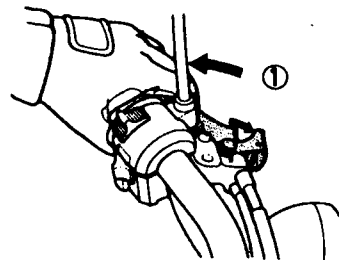

## Refuelling

Type of Fuel: Unleaded  
Petrol only.

### Advice:

- Always use only Unleaded Petrol when refuelling.
- Using fuels containing high levels of alcohol can cause engine or fuel system damage.
- Diesel, inferior petrol or inappropriate fuel additives can adversely affect the engine.

### Warning

- Always stop the engine and keep away from naked flame, sparks or other possible ignition sources when refuelling.
  - Refuelling should only be carried out outdoors.
  - Spilt petrol should be wiped up immediately.
  - Sparks arising from a build-up of static electricity around the body can ignite petrol vapour and cause burn injuries.
- When Refuelling:
- Eliminate static electricity around the body, before opening the fuel tank cap, by touching metal areas such as the motorcycle body or filler nozzle.
  - Only allow refuelling by a person who has eliminated static electricity.



### <Refuelling>

1. Open the Seat (Pg17)
2. Turn the Fuel tank cap to the left to open it.
3. Fill with petrol to the bottom end of the level plate inside the filler neck.

Filling the tank above the bottom end of the filler neck may cause petrol to spill from the fuel tank cap breather.

4. Turning the fuel tank cap to the right closes it. Turn the cap firmly until the Triangular mark on the tank cap aligns with the Triangular mark on the fuel tank surface.
5. Lower the seat and press firmly on the rear of the seat to lock it. Confirm that it is locked.

Level Plate

Align Marks

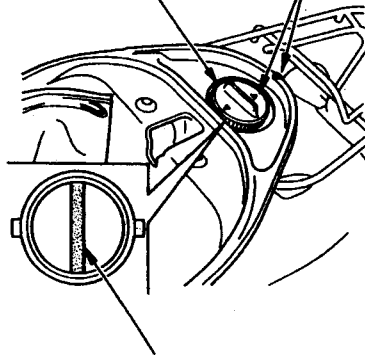

# Procedures

## <Starting the engine>

Exhaust fumes contain carbon monoxide and other toxic gases. It is essential that the engine is run only in a well ventilated area.

Please follow the procedures on Pages 23-25 to start the engine.

- Prior to starting the engine check the oil and fuel levels (See Pg34).
- Use the mainstand when starting the motorcycle.
- Make sure the Rear Brake is Locked when starting the engine to prevent the motorcycle jumping forward. The Rear Brake cannot be locked if it is not adjusted correctly. (See Pg38 for Rear Brake adjustment procedure).

## <Starting Procedure>

1. Lock the Rear Brake (Pg21).

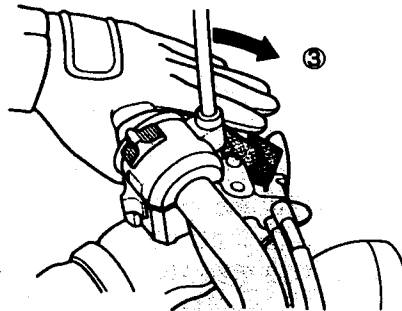
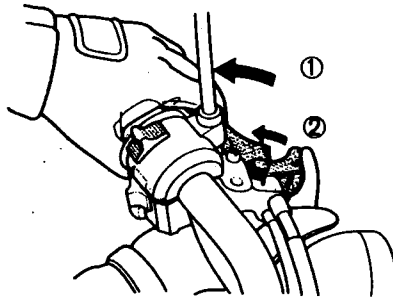

2. Turn the ignition switch to "ON".

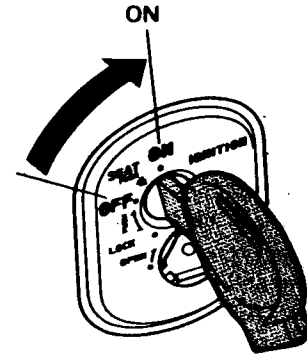

- ③ Press the Starter Button without opening the Throttle.

Release the Starter as soon as the engine starts.

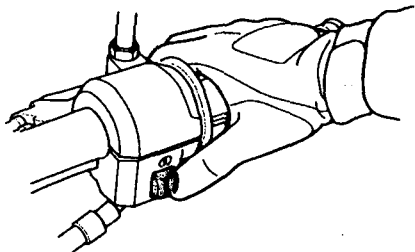

 **Advice:**

- Do not press the Starter Button when the engine is running.

If the engine is warm and fails to start after using the starter for 3~4 seconds, open the Throttle  $1/8 \sim 1/4$  turn.

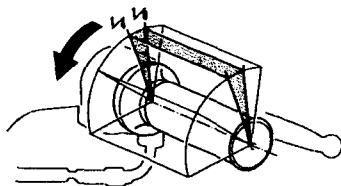

It may take longer than usual to start the engine after not using the motorcycle for a long time, or after refuelling when you have run out of fuel. The Throttle should be fully closed. To save the battery, do not use the starter for longer than 15 seconds and allow 10 seconds between each attempt.

- ④ If the engine is cold, warm up for a few minutes after starting the engine.

 **Advice:**

- Avoid prolonged warm-up. It not only wastes fuel, but it can be harmful to the engine.

## Procedures

### <Starting the engine with the Kick Starter>

After Step 2, kick the Starter Pedal without opening the Throttle.

Once the engine starts, retract the Starter Pedal before riding.



If the engine is warm and fails to start after using the Starter Pedal for 3~4 Seconds, open the Throttle for 1/8~1/4 turn.

You may find it difficult to start the motorcycle after not using for a long time or when refuelling when you have run out of fuel. The throttle should be fully closed and it may take a few attempts to start the engine.

### <Starting to ride>

- Take the motorcycle off the support stand.
  - Push the motorcycle forward to take it off the support stand.
- Make sure the Rear Brake lock is fully engaged and keep the engine running at low rpm.

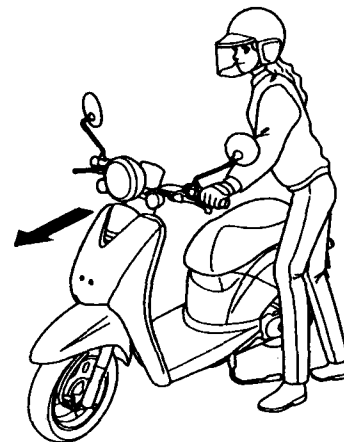

**2 Mounting the motorcycle.**

- Mount from the left side of the motorcycle. Sit on the seat and balance yourself by keeping one foot firmly on the ground.

Keep the Brake Lock engaged.



**3 Grasp the Left Brake Lever to release the Brake Lock.**

Do not open the Throttle while releasing the Brake Lock or the motorcycle will jump forward.

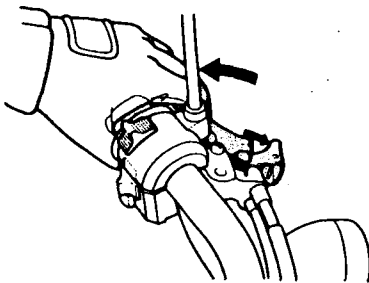

**4 Release the left brake lever and slowly open the throttle.**

Avoid rapid throttle opening to prevent the motorcycle accelerating too fast.

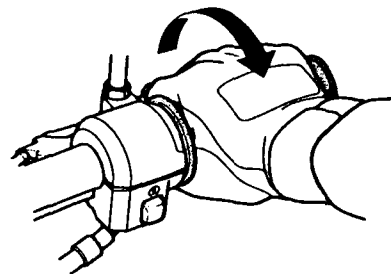

## Correct Riding

Before starting to ride the motorcycle, turn on the Direction Indicator and check behind. Checking behind is best done by looking in the rear view mirrors and then over your shoulder.

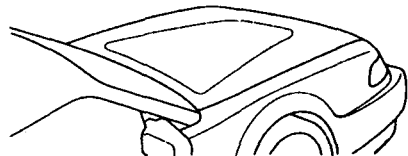
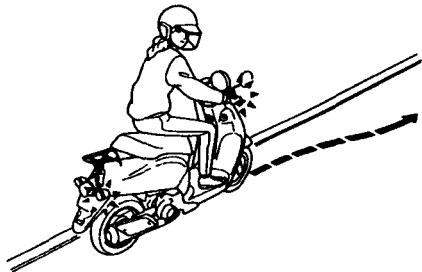

The vehicle speed can be controlled by the throttle grip.

**OPEN** - Increase the speed. Open the throttle slowly. Gradually open the throttle when going up hill.

**CLOSE** - Reduce the speed. Close the throttle quickly to reduce speed.

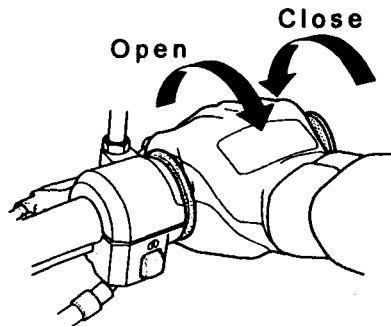

When using the brakes, use both left and right brake simultaneously.

- Use the brakes only after closing the throttle.

- Apply brakes gently, at first, and then firmly.

Never operate the Brake Lock Lever when riding. Sudden locking of the brakes is extremely dangerous.

Left Brake

Right Brake

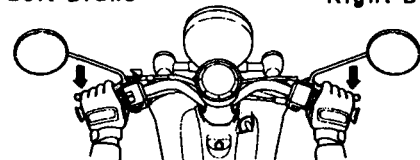

Avoid unnecessarily heavy braking. Abrupt braking may lock the wheels and cause you to lose control of your motorcycle.

Tyres can slip on wet surfaces and your brake-stop distance increases. Slow down and apply brakes earlier.

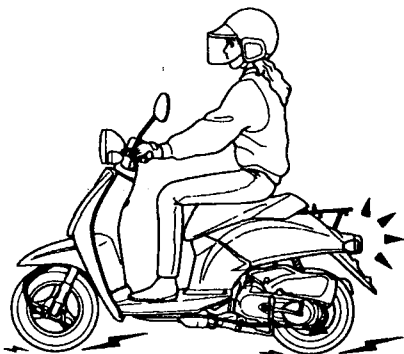

Extra caution is required when riding on a rainy day.

- Tyres may slip on a wet surface and your braking distance may increase. Slow down and apply brakes earlier.

- Close the throttle when going downhill and apply brakes to control speed.

- Continuous braking may lead to brake overheating.

- Braking performance may drop after riding through water or on rainy days.

Find a safe area and check brake operation. If the performance is poor, ride at a slow speed while gently applying the brakes to "dry" the brakes.

- Snowy or icy surfaces are more slippery. Slow down when riding on these surfaces.

### <Stopping the motorcycle>

1. When you approach the stopping position:

- Turn on the Direction Indicator in advance, to warn other traffic of your intentions. Move to the left hand side of the road and stay to the left.

- Close the throttle and apply both brakes simultaneously. The brake light will illuminate to warn other vehicles.

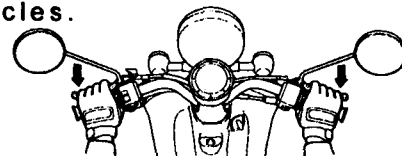

Left Brake

Right Brake

2. When the motorcycle has stopped:

- Cancel the Direction Indicator and turn the Ignition off to stop the engine.

Do not touch the ignition key while riding. The ignition system does not operate in the "SEAT", "OFF" or "LOCK" positions.

Unintentionally turning off the ignition while riding is very dangerous. Stop the motorcycle if you need to turn the ignition key.

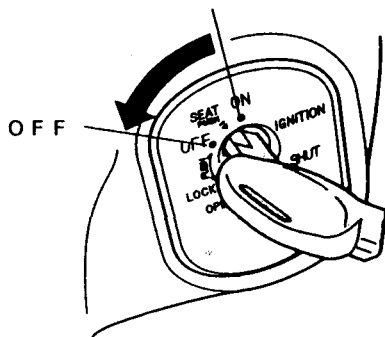

3. Get off to the left and put the motorcycle on the support stand, on level ground.

- Find a safe place with firm, flat surface.

- Hold the handlebar straight with your left hand and hold the rear rack with your right hand. Pull back as you push the support stand down with your foot.

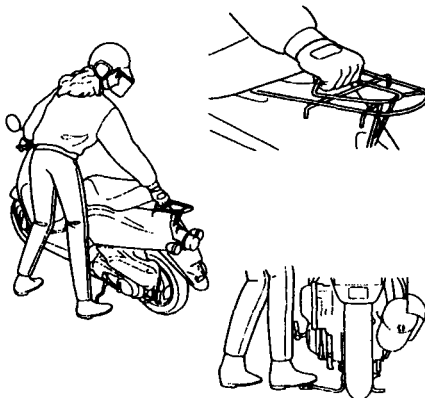

4. In order to prevent theft, always apply the steering lock, remove the ignition key and close the Lock Protector.

We also recommend using a chain and lock in conjunction with these features.

Please be considerate when selecting a place to park your motorcycle.

**NOTE:** Appropriate Run-in procedures will extend the life of your motorcycle. Please avoid rapid acceleration and braking for the first 100km's.





## For your Safety

Always stop the engine and remove the ignition key before starting any maintenance work.

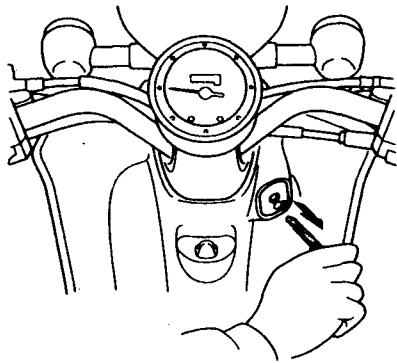

All maintenance should be carried out on a clean, flat and solid surface.

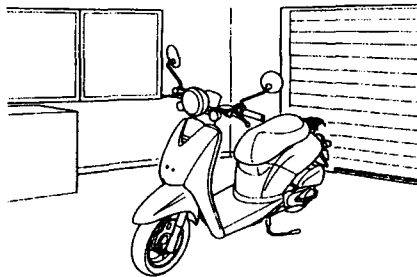

The engine, muffler and the exhaust pipe are very hot when the engine is running and for some time after it is turned off.

Use caution when carrying out any maintenance near these components.

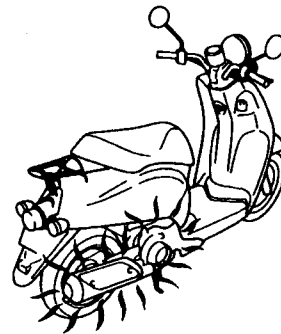

Exhaust fumes contain dangerous gases, like Carbon Monoxide, which can be fatal. Never run the engine in an enclosed space.

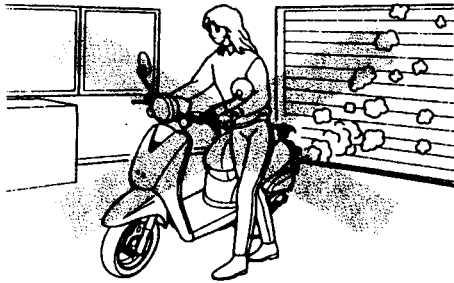

If the motorcycle requires test riding, do so in a safe manner and obey all traffic regulations.



Always use the correct tools when carrying out any maintenance or repairs on the motorcycle.

Any servicing, repair or adjustment should be carried out by an authorised Honda Dealer.

For your safety, we have provided a service schedule for your motorcycle. This is a very basic, minimum service recommendation and your authorised Honda dealer is best placed to advise you on the best service for your motorcycle.

**Warning**

Failure to carry out appropriate servicing may cause an accident and result in serious or fatal injury. It may also void your warranty.

- Please discuss your servicing needs with a Honda dealer.
- Defects found during riding should be rectified prior to your next ride.

Please ensure that you have your motorcycle serviced and maintained regularly.

Please refer to the following pages for details of servicing requirements:

One Month Check .....	35
Spare Parts .....	35
Daily Inspection .....	36
Parts Layout .....	37
Regular Service .....	38
Six Month Service .....	39
Basic Maintenance .....	40
Brakes .....	40
Tyres .....	42
Engine Oil .....	44
Battery .....	46
Fuses .....	48
Transmission .....	49
Air Filter .....	50
Cables .....	51
Breather Drain .....	51

### <One Month Check>

This check is to be carried out at one month or 1000km, after initial purchase, whichever occurs first. This inspection and adjustment can significantly affect the life of the motorcycle.

This service should be carried out by the authorised Honda dealer from whom you purchased the motorcycle. Replacement oil and any parts used will be charged to you.

Please refer to your Owner's Warranty Policy and Service Record booklet for information on your Warranty obligations.

### <Spare Parts>

Always use genuine Honda parts for replacement or service. We guarantee the quality and compatibility for your motorcycle.

Please contact your Honda dealer for purchasing any parts required.

All genuine Honda parts, with the Logo shown below, are covered by a Honda factory warranty.

# HONDA

GENUINE PARTS

### <Daily Inspection>

This is a quick inspection that you should carry out on a daily basis, prior to riding the motorcycle. Please carry out this inspection for your own safety and comfort.

Items shown on the right should be inspected daily. The opposite page shows the location of inspection items, for your reference.

Please refer to your Honda dealer if you encounter any problems, or are unsure of how to check any of these items.

### <Inspection Items>

Brakes      Lever Free Play  
                 Braking Performance

Tyres        Air Pressure  
                 Cuts and other damage  
                 Unusual wear  
                 Tread depth

Engine      Oil Level  
                 Starting / Noise.  
                 Low Speed / Acceleration

Lights and Indicators

Any Defects noticed during riding.

Items such as Tyre Tread, Oil Level, Noises & Performance issues should be inspected at regular intervals, based on riding habits and distance.

## <Parts Layout>

Refer to the "Basic Maintenance" in this owner's manual or to your Honda Dealer.

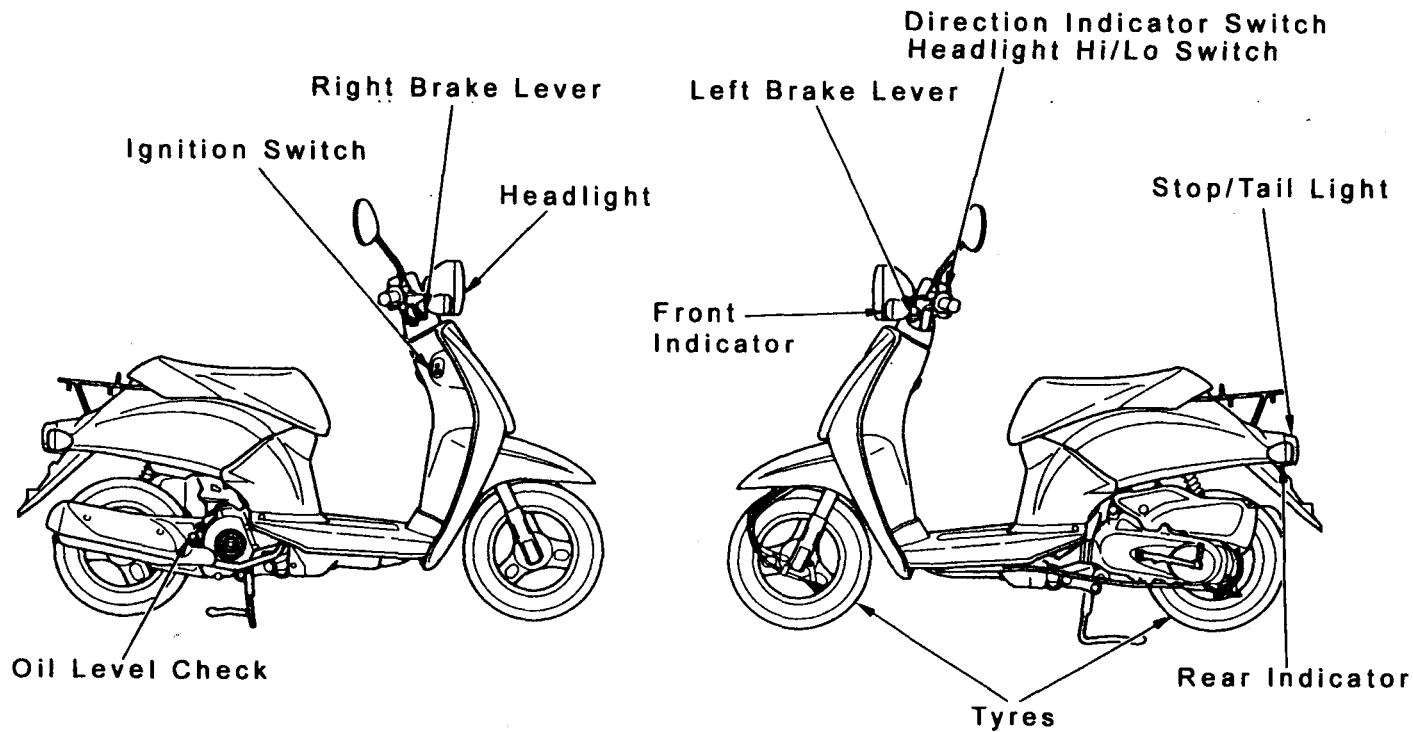

---

### **<Regular Service>**

Servicing should be carried out at one month/1000km's, initially, and then at least every 6 months after that. As well as service items required for the Safe operation of the motorcycle, there are items that require some technical expertise to service or check.

For your own safety, please ensure that regular servicing is carried out, regardless of whether you are doing it yourself or having it done by an authroised Honda dealer.

Servicing and Inspection are your responsibility. Please contact your Honda dealer for servicing if you are unable to do it yourself.

Your Honda dealer has all of the tools and equipment necessary to correctly service and repair your motorcycle.

Please refer to the Specifications on page 58.

Upon completion of each service, ensure that it is recorded in the Owner's Service Policy manual for future reference.

Refer to the next page for six-monthly inspection items. Any additional information can be obtained from the Workshop manual.



---

## **Six Monthly Inspection items**

- |                         |                                  |
|-------------------------|----------------------------------|
| - Ignition System       | Spark Plug Condition             |
| - Engine                | Exhaust Fumes                    |
| - Lubrication System    | Engine Oil Leaks                 |
| - Clutch                | Clutch Adjustment                |
| - Transmission          | Oil Level and Leaks              |
| - Brake Levers          | Free Play and Effectiveness      |
| - Brake Drums and Shoes | Drum and Shoe Wear               |
| - Wheels and Tyres      | Tyre Condition, Wheel Bolts/nuts |

### **<Honda recommended Six Month inspection Items>**

- |                  |                          |
|------------------|--------------------------|
| - Breather Drain | Clean the Breather Drain |
|------------------|--------------------------|

(See Pg 51 for details)

# Maintenance

This section describes frequent maintenance items.

Use of appropriate tools is essential when carrying out any of these procedures.

These procedures require some mechanical skill to enable you to carry them out. Please contact your Honda dealer if you have any doubts regarding your ability to carry out any of these procedures.

## <Brakes>

### <Brake Lever Free Play>

Grasp the brake levers until you feel some resistance. Measure the travel at the end of the lever at that point.

**Left/Right Brake Lever  
free play:  
10~20mm.**

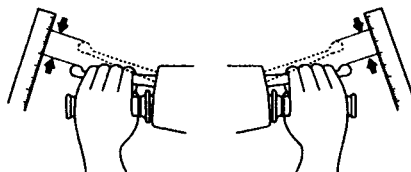

### <Adjusting the Free Play>

Adjustment sequence:

1. Front Brake (R/H Lever)
2. Rear Brake (L/H Lever)

Turn the adjuster to adjust the free play (see figures below).

Re-measure the free play after adjustment.

#### 1. Front

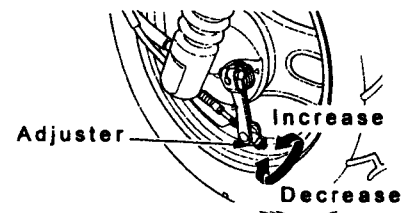

#### 2. Rear

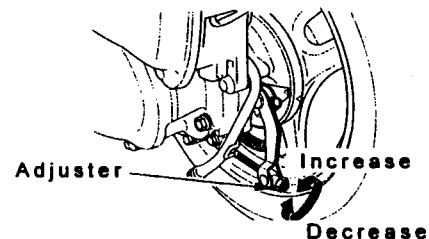

**Tip:**

The adjusting nut is not flat and it is important to ensure that it sits correctly after adjustment.

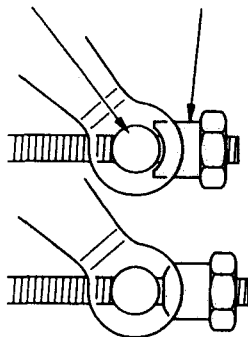

**<Brake shoe check>**

Firmly grasp the brake levers and check that the brake indicator symbols (arrow for the Front wheel and triangle for the Rear wheel) do not align with the Triangular marks on the brake panels.

If the marks align, the Brake Shoes need to be replaced. We suggest that you contact your Honda dealer for the replacement of the brake shoes.

**<Front>**

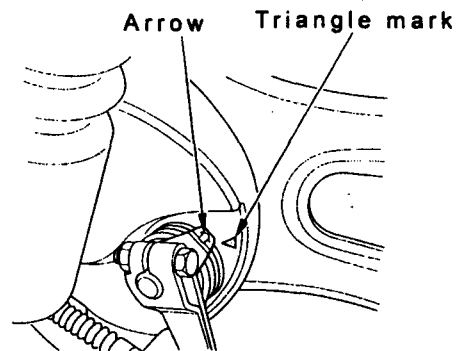

**<Rear>**

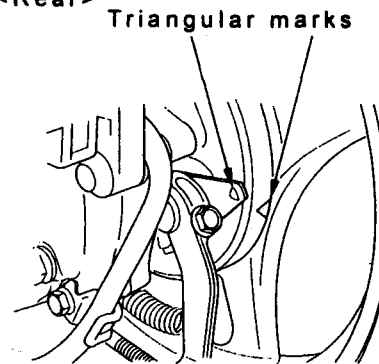

## <Tyres>

Keeping your tyres in good condition is essential for your safety. Maintain tyre pressures within the specified range. Worn tyres should be replaced immediately.

### Warning

Excessively worn tyres and over/under inflated tyres may cause serious accidents, which may result in serious or fatal injuries.

Please observe the Pressure and Wear limits specified in this manual.

## <Tyre Pressure Check>

Tyre inflation can be visually checked. If the tyre "looks flat", use an air pressure gauge while the tyre is cold and adjust the pressure if necessary.

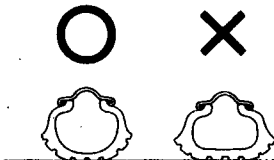

Front	125 kPa (1.25 kgf/cm <sup>2</sup> )
Rear	200 kPa (2.00 kgf/cm <sup>2</sup> )

## <Tyre Damage Check>

Check the tyre surface for any sign of cracks or foreign objects.

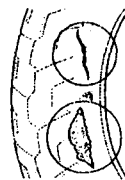

## <Tyre Wear Inspection>

Check the tyre surface for uneven or abnormal wear. Please contact your local Honda dealer if you find unusual wear.

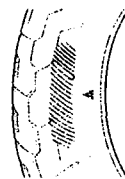

Check the tread depth with the wear indicators. If the wear indicator is visible, replace the tyre.

Tyre Tread Wear Indicators

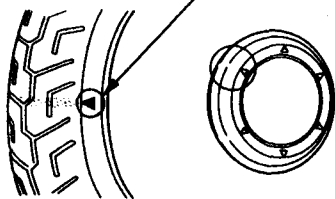

### <Tyre Selection>

Always replace the tyres with the correct size and type of tyre.

Other tyres may negatively affect the handling and stability of your motorcycle.

Please consult your Honda dealer when selecting tyres.

### Replacement Tyres

Front	Size	80/100-10 46J
	Type	IRC MB48 DURO HFC-261
Rear	Size	80/100-10 46J
	Type	IRC MB47 DURO HFC-261

### Warning

Tyres not specified here may negatively affect the handling and stability of your motorcycle. Such changes may cause accidents and may involve serious or fatal injuries.

Please replace with tyres specified in this manual.

## <Engine Oil>

In order to maintain the engine performance, the engine oil needs to regularly checked and changed. Dirty or old oil can damage the engine.

Be careful when working on the engine immediately after stopping the engine as the muffler, exhaust pipe and engine itself will be very hot.

### <Oil Level Check>

1. Place the m/cycle on the stand, on flat ground. Run engine for a few minutes.
2. Stop engine. Remove dipstick and wipe clean.
3. Put dipstick back in, but do not screw it in.
4. Remove and check level. The level should be between the two marks. Top up as required.
5. Screw dipstick back in.

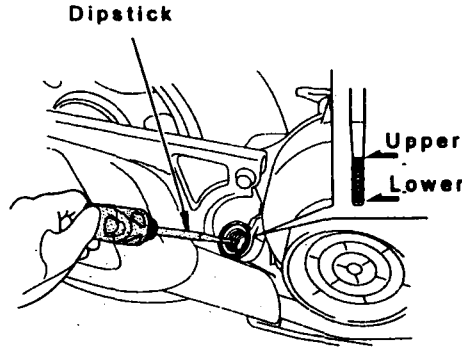

Recommended Oil.  
Genuine Honda 4Stroke  
Motorcycle Oil.

	ULTRA	SUPER 8
API	SJ	SJ
JASO	MA	MA
SAE	10W-30	10W-40

If you are not using Honda oil, refer to the chart on the next page to select a suitable grade for your area.

Always use good quality oil as cheap or inferior quality oils can cause engine life to be reduced.

### Tip:

Do not mix different brands or types of oil. Always use good quality oils to ensure that the life of your engine is not reduced.

The following chart will help you to select the appropriate viscosity grade oil for your area.

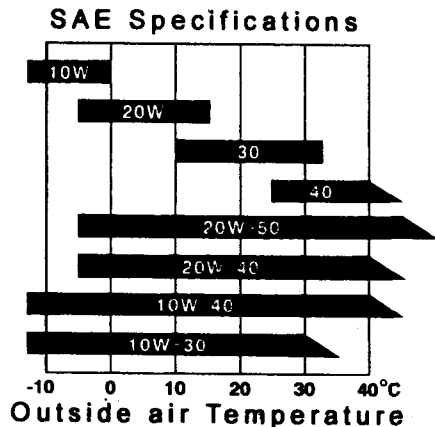

### <Oil Change Intervals>

Initial 1000km's.  
Every 3000km's there-  
after.

Contact your Honda dealer  
for the oil change.

### <Adding Engine Oil>

Check the engine oil level  
as per the instructions on  
the previous page.

If oil is needed, pour the  
oil directly into the Oil  
Filler Opening, taking care  
not to spill oil on engine.  
Any spilled oil should be  
wiped immediately.

Insert the dipstick, but do  
not screw in. If level is up  
to the specified level, put  
dipstick back in and screw  
in firmly.

### Tip:

Correct oil level is important to protect engine life.

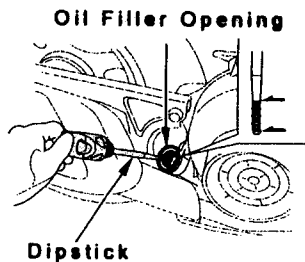

### <Battery>

This motorcycle is equipped with a maintenance-free type battery. There is no need to check/add battery fluid. However, please clean the terminals if they are dirty or corroded.

### <Handling the Battery>

- Battery fumes are explosive. Keep flames or sparks away from battery.
- Battery Acid is corrosive. Keep away from skin and eyes.

#### Advice:

Do not take the caps off the battery. It is not necessary, even during charging.

### Warning

Battery acid is corrosive. Direct contact with the eyes or skin may result in serious burns.

- Wear protective clothing and goggles when handling the battery.
- Keep the battery out of reach of children.

### <First Aid Instructions>

Direct contact with eyes:

- Wash eyes with water for at least 15 minutes. Do not use pressurised water as it may damage eyes.

Direct contact with skin:

- Remove affected clothing and rinse skin with water.

If Swallowed:

- Drink a lot of water/milk.

Please consult a Doctor as soon as possible,

### <Cleaning the Battery Terminals>

Remove the battery (see next page).

- If white powder is present, wash it off with Hot water.
- If terminal is corroded, clean it with wire brush or sand paper.

Re-install the battery after cleaning the terminals, then apply a thin coat of grease over terminals.

Only replace battery with the same type of maintenance-free battery.

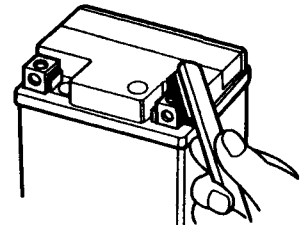



<Battery removal and installation>

1. Place the motorcycle on the Support Stand.
2. Turn off the ignition.
3. Remove the screw holding the battery cover and remove the cover.

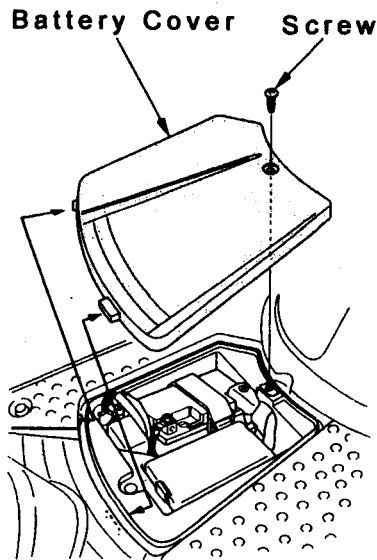

4. Disconnect the Negative cable.
5. Disconnect the Positive cable.
6. Undo the battery strap.
7. Pull out the battery

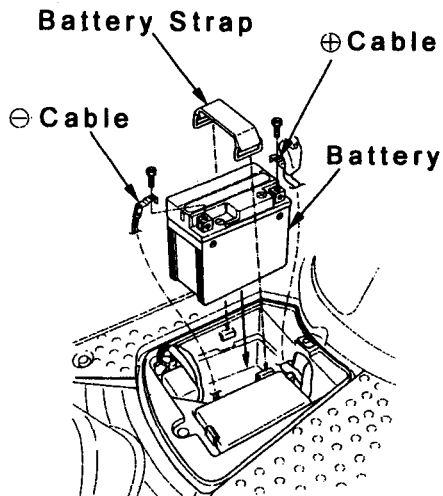

<Installation>

Reverse the removal procedure to re-install the battery.

Connect the Positive cable first.

Tighten the nuts and bolts on terminals after connecting the cables.

## <Fuses>

### <Inspect and Replace>

Turn off the ignition switch and check that all fuses are OK. Replace blown fuses with fuses of the same capacity. Never replace with higher rating fuses or the circuit may be damaged.

If the replaced fuse blows quickly, you should suspect a fault in the circuit and carry out troubleshooting before fitting a new fuse.

#### Advice:

Please use genuine accessories only. Other electrical accessories may overload circuits and cause fuses to blow or flatten the battery.

Blown Fuse

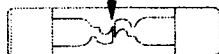

### <Removal>

1. Remove the battery cover (Page 47).
2. Remove the Fuse Holder.

Fuse Holder

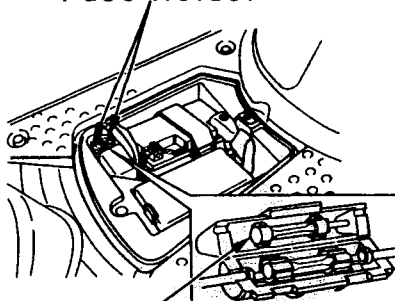

Spare Fuse

3. Open the fuse holder, grip the fuse by both ends and pull to slide the fuse connector apart.

### <Installation>

1. Attach new fuse to fuse connector. Check that it is a snug fit.
2. Press down on both ends of the fuse to install into the fuse holder.
3. Close fuse holder and press firmly to seal it.
4. Attach Battery cover.

Removal

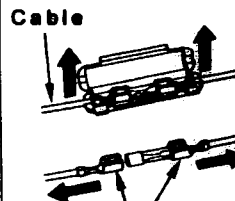

Installation



Fuse Connector

## <Transmission>

### <Oil Level Check>

1. Put the motorcycle on to the Support Stand, on level ground.
2. Undo the check bolt a few minutes after stopping the engine.
3. Visually check that the oil level is at the bottom edge of the bolt hole. If the level is lower, add oil until it spills from the hole.

Make sure no foreign objects or dirt enter the hole when adding oil. Wipe off any spilled oil immediately.

4. Tighten the oil check bolt.

 **Advice:**  
Oil level should not be high or low, or engine may be damaged.

### Oil check bolt

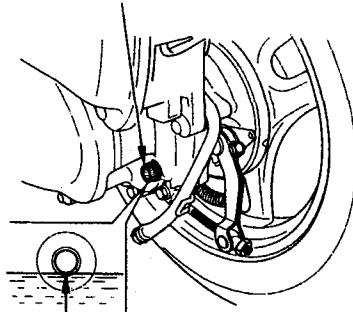

Bolt Hole

### Recommended Oil

API	SG, SH, SJ
JASO	MA
SAE	10W-30

Use only reputable oil that meets or exceeds the recommendations in this manual.

### **Advice:**

Do not mix different types or grades of oil. Cheap, Low-quality oils can cause engine damage or reduce engine life.

### <Oil Leak Check>

Make sure that there are no oil leaks from the Transmission casing.

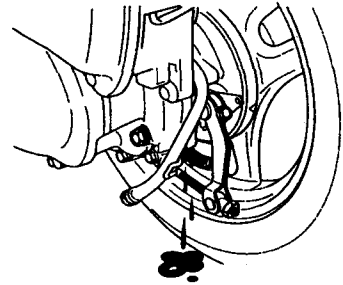

## <Air Filter>

This motorcycle is equipped with a viscous type air filter. There is no need to check and/or clean the filter unless you are operating in extreme conditions. The Filter must be replaced every 10,000km's.

### <Changing the Filter>

1. Undo screws to remove air filter cover.

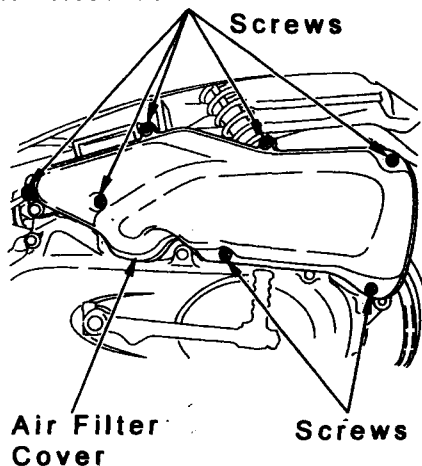

Remove the Air Filter and clean the inside of the housing before fitting new filter.

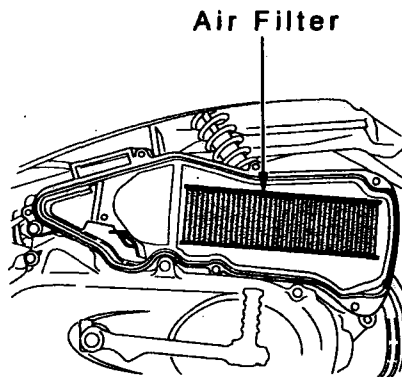

3. Reverse the removal procedure to install the new air filter.

### Advice:

If the Air Filter is not installed correctly, dirt may enter the engine and cause damage.

Make sure water does not enter the air filter when washing the motorcycle. A wet filter may cause some difficulty in starting the engine.

### <Rubber Boots for Cables>

Rubber Boots are fitted to some cables to protect the inner cable. Always check that the boots are properly attached.

Do not apply water directly to the boots when washing the motorcycle and do not scrub them. If boots are dirty, wipe them with a cloth.

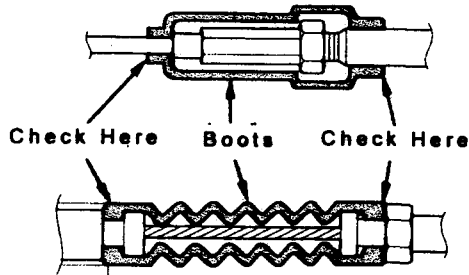

### <Breather Drain>

#### <Cleaning Breather Drain>

Honda recommend that you clean the Breather Drain at six-monthly intervals or whenever contamination can be seen.

1. Place drain tray underneath the breather hose.
2. Undo the drain plug and allow the hose to drain.
3. Refit the plug securely.

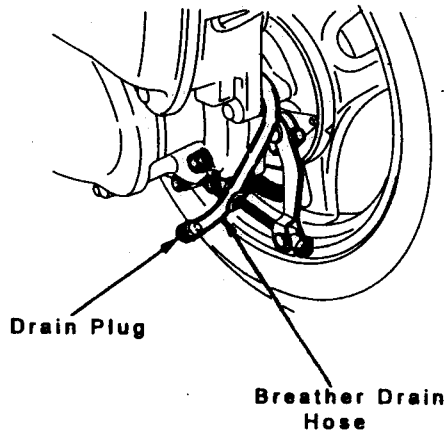

### **<Caring for your motorcycle>**

In order to maintain the value, quality and performance of your motorcycle, it is important to clean it regularly. It is also a good opportunity to inspect it for defects.

After riding near the coast and/or any surface with anti-freezing chemicals sprayed on it, wash and dry the motorcycle and spray exposed metal parts with a good quality Silicon spray, to help prevent corrosion.

### **<Washing your motorcycle>**

1. Rub off dirt with a cloth or sponge while running water on the surface. For severe dirt, use a good quality neutral washing detergent and rinse with water.
2. Wipe water off with a soft cloth. After drying the body, apply grease on the brake lever pivots and Support Stand hinge. Finally, apply wax coating on the surface.

- Always wash your motorcycle when the engine is cold.

- Avoid using pressurised water, particularly around the moving parts, electrical items and brakes to avoid failures.

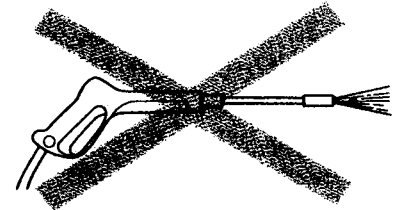

### <Caring for your motorcycle>

- Do not allow water to get into the muffler when hosing. Water inside the muffler may cause rust and engine starting may become difficult.
- Keep water away from the Brake Pads. Braking performance of wet brake pads is reduced. After washing, ride slowly, in a safe area, to check brake performance.
- Try wax or other chemicals on a small area before applying them to the whole motorcycle. Make sure they do not scratch or affect the paint or plastic parts.
- After washing, you may find the inside of the headlight will fog up. Turn the headlight on, with engine running, and allow the light to dry out.

### <Storing the motorcycle>

We recommend that the motorcycle be kept indoors. If that is not possible, put a cover over your motorcycle to protect it from the Sun and weather.

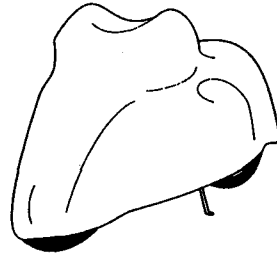

**NOTE:** Do not put the cover on the motorcycle until the engine and muffler have cooled down.

If you are not intending to ride the motorcycle for a long time:

1. Apply a good quality wax to the painted and plastic surfaces.
2. Remove the cover periodically to check the motorcycle for moisture due to condensation.
3. Disconnect the battery terminals to prolong the life of the battery.
4. Apply a good quality Silicon spray to all moving or exposed metal parts.

### <Environmental Consideration>

Waste Products and displaced parts can be harmful to the environment. Please consult your Honda dealer when you are disposing of used parts, oil, batteries or tyres.

### <Coloured Parts>

When ordering coloured parts, please quote the Vehicle Identification Number, Model name and Colour Code. The Colour Code is on a label, inside the Boot.

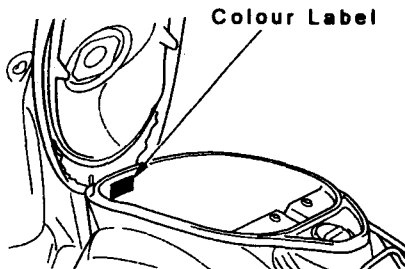

### <Genuine Honda Symbol>

There is a "HONDA" logo stamped on the rear of the muffler to prove that it is a genuine HONDA part.

Always insist on genuine HONDA parts when repairing or servicing your motorcycle.

"HONDA" Logo

**HONDA**



### <Vehicle Identification Number (VIN)>

The VIN is important when registering a vehicle and ordering parts. It could also help to identify your motorcycle if it is stolen. Record the number and keep it in a safe place.

V.I.N

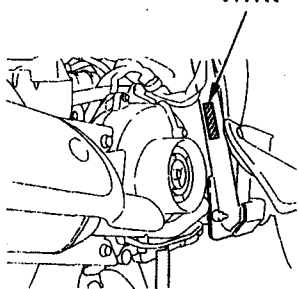

Engine Number

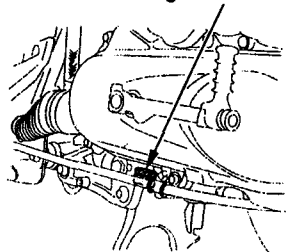

### <V.I.N location>:

The VIN is located on the main frame tube, in front of the engine.

### <Engine Number>:

The Engine Number is located on the lower part of engine, below the transmission case.

### <Ignition Key>:

For security reasons, the Ignition Key code is not recorded by Honda. You should record it in a safe place in case you lose the key.

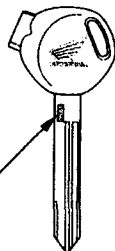

Ignition Key Number

If your motorcycle breaks down while riding, please contact your nearest Honda dealer for assistance.



If you have trouble starting the engine, or it stops while you are riding, please check the following items before contacting your Honda dealer.

- Fuel Level
- Starting Procedure (Pg24)
- Engine Oil

# Specifications

<b>Model Type</b>		BA-AF61
<b>Length</b>		1,695 mm
<b>Width</b>		630 mm
<b>Height</b>		1,030 mm
<b>Wheelbase</b>		1,180 mm
<b>Engine/Capacity</b>		4 Stroke / 49cc
<b>Weight</b>		75 kg
<b>Seating Capacity</b>		1
<b>Tyre Size</b>	<b>Front</b>	80/100-10 46J
	<b>Rear</b>	80/100-10 46J
<b>Ground Clearance</b>		110 mm
<b>Fuel Consumption</b>		65.0km/lt (@30km/h, Test Conditions).
<b>Turning Radius</b>		1.8 m
<b>Compression Ratio</b>		10.1
<b>Maximum Power</b>		2.8 kW(3.8 PS) / 8,000 rpm
<b>Fuel Tank Capacity</b>		5.0 l
<b>Ignition Type</b>		CDI - Battery Ignition
<b>Ignition Timing</b>		BTDC14° / 2,000rpm
<b>Idle Speed</b>		2,000 rpm
<b>Spark Plug</b>	NGK	CR7HSA CR8HSA
	DENSO	U22FSR-U U24FSR-U
<b>Battery</b>		12V-3Ah
<b>Clutch</b>		Dry, Multi-plate shoe type

Right Brake Lever Free Play		10-20 mm
Left Brake Lever Free Play		10-20 mm
Tyre Pressure	Front	125 kPa (1.25 kgf/cm <sup>2</sup> )
	Rear	200 kPa (2.00 kgf/cm <sup>2</sup> )
Engine Oil	Capacity	0.8 l
	At Oil Change	0.7 l
Transmission Oil Capacity		0.12 l
Fuses		15A,10A
Spark Plug Gap		0.6-0.7 mm
Air Filter Type		Viscous Paper Type Element
Globes	Headlamp	12V-30/30W
	Tail/Stop Lamp	12V-18/5W
	Direction Indicator	12V-10W

