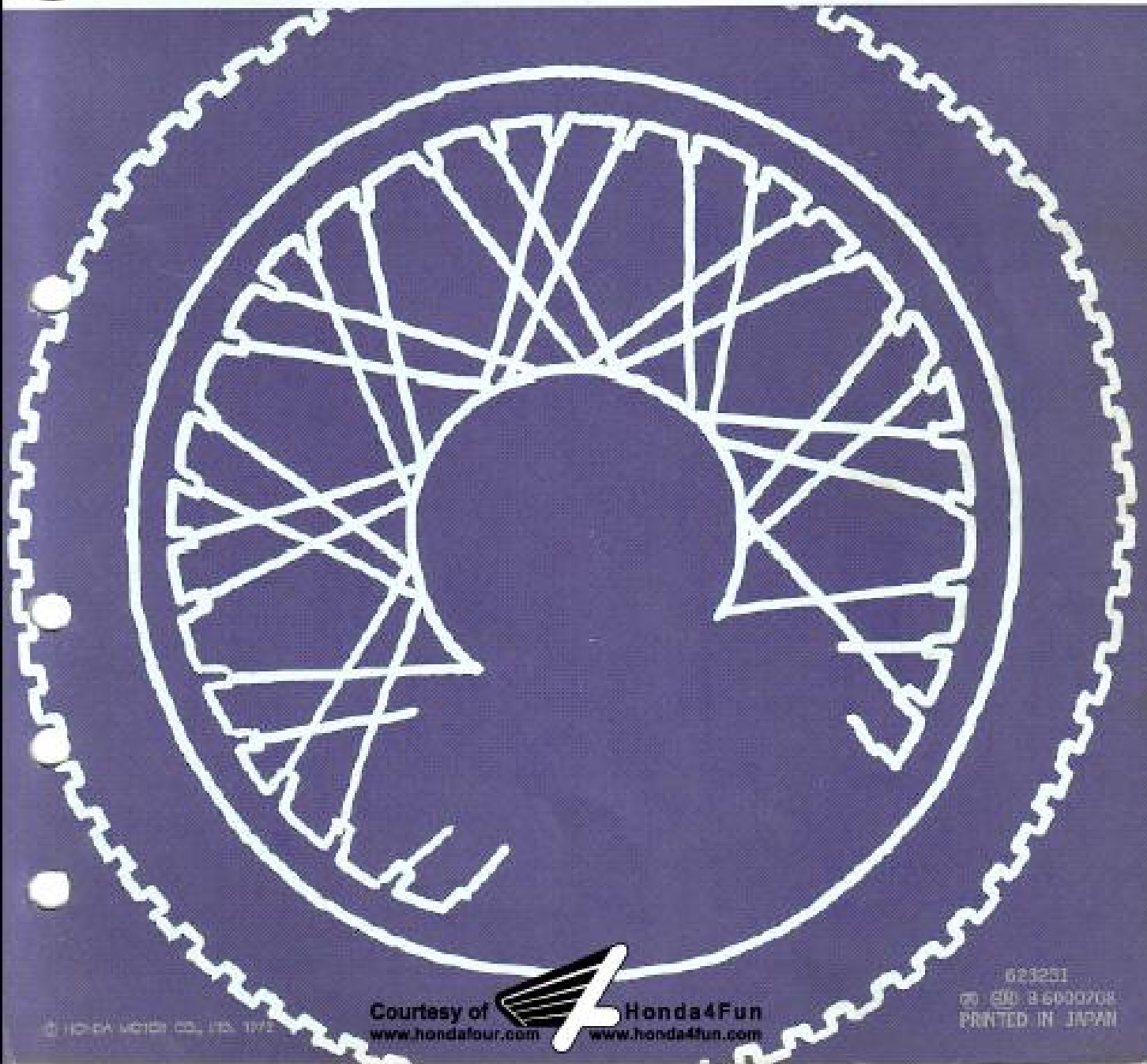


SHOP MANUAL

HONDA
CB350F - CB400F



© 1994 HONDA MOTOR CO., LTD. 1993

Courtesy of  Honda4Fun
www.hondafour.com www.honda4fun.com

623231
© 1993 3-6000708
PRINTED IN JAPAN

PREFACE

Courtesy of
www.hondafour.com



Honda4Fun
www.honda4fun.com

This SERVICE MANUAL has been prepared as a "SERVICE GUIDANCE" for the mechanic responsible for the upkeep of the HONDA CB350F and CB400F. It is compiled into various functional groups and summarizes the procedures for disassembling, inspecting and reassembling the components of the machine. Strict adherence to the instructions given herein will result in better, safer service work.

All information, illustrations and specifications contained herein are based on the 1972 model CB350F. At the end of this manual, the modified information and operation procedures of the model CB400F are given separately. HONDA reserves the right to make changes at any time without notice and obligation.

Courtesy of Honda4Fun (www.honda4fun.com - www.hondafour.com).

HONDA MOTOR CO., LTD.

SERVICE PUBLICATION OFFICE

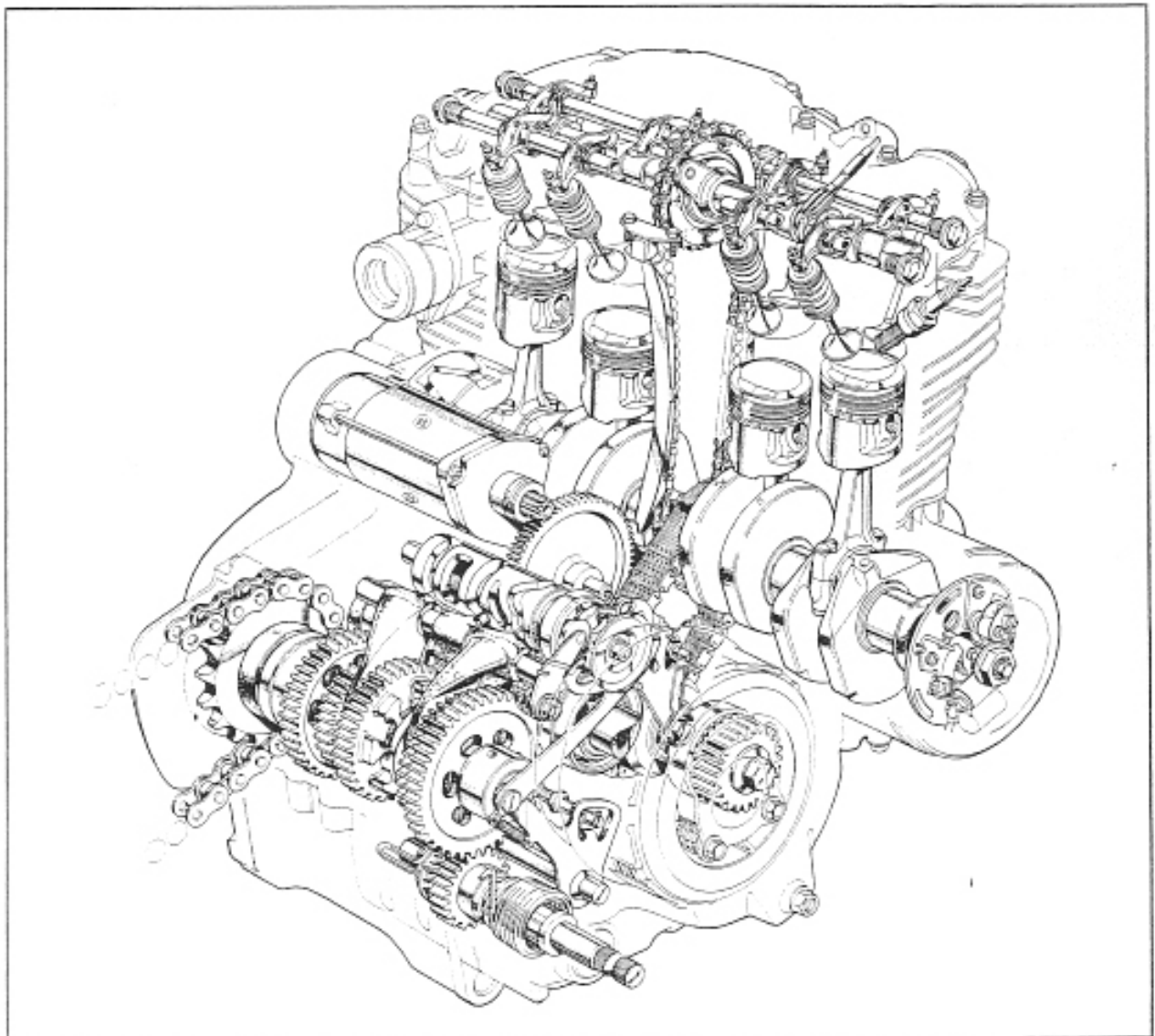
I. THE 8 RULES FOR EFFECTIVE SERVICEWORK	3	SUPPLEMENT TO CB400F	
II. INSPECTION AND ADJUSTMENT	4	I. TECHNICAL FEATURE	87
1. Tappet	4	II. INSPECTION AND ADJUSTMENT	88
2. Breaker point gap and ignition timing	5	1. Clutch	88
3. Carburetor	6	2. Rear brake	88
4. Clutch	8	3. Wheel	88
5. Cam chain	8	4. Spark plug	89
6. Engine oil	8	5. Fuel filter	89
7. Front brake	9	6. Air cleaner	90
8. Rear brake	9	7. Front suspension	90
9. Air cleaner	10	8. Rear suspension	91
10. Drive chain	10	9. Side stand	92
11. Front forks	10	III. ENGINE	93
III. ENGINE	11	1. Piston rings	93
1. On-vehicle servicing	11	2. Clutch	93
2. Engine removal and installation	11	3. Gearshift mechanism	94
3. Cylinder head • Camshaft • Cylinder • Piston	12	4. Carburetor	95
4. Oil pump • Oil filter	18	IV. FRAME	96
5. Clutch	20	1. Front suspension	96
6. Kick starter	22	2. Rear suspension	98
7. Gear shift mechanism	23	3. Frame body	96
8. Transmission	26	V. ELECTRICAL SYSTEM	100
9. Primary shaft	28	1. Charging system	100
10. Cam chain tensioner	30	2. Starting system	100
11. Crankshaft • Connecting rod	31	3. Electrical equipments	101
12. Crankcase	34	VI. SERVICE DATA	103
13. Carburetor	35	1. Special tools	103
IV. FRAME	39	2. Maintenance schedule	104
1. Front wheel	39	3. Torque specifications	105
2. Front disc brake	42	4. Service data	106
3. Rear wheel • Rear brake	45	5. Wiring diagram	109
4. Steering handlebar	47	6. Routing	110
5. Steering stem	49	7. Specifications	111
6. Front suspension	50		
7. Rear suspension	52		
8. Frame body	53		
V. ELECTRICAL SYSTEM	57		
1. General description	57		
2. Ignition system	58		
3. Charging system	61		
4. Starting system	65		
5. Electrical equipments	69		
VI. SERVICE DATA	72		
1. Special tools	72		
2. Maintenance schedule	74		
3. Torque specification	75		
4. Service data	76		
5. Trouble shooting	79		
6. Wiring diagram	84		
7. Specifications	85		

I. THE 8 RULES FOR EFFECTIVE SERVICE WORK

1. Use new packings, gaskets, O-rings and cotter pins whenever reassembling.
2. When tightening bolts or nuts for which sequence is not specified, begin on center or larger diameter bolts and tighten them in a criss-cross pattern to specified torque in two or more steps if necessary.
3. Use genuine HONDA parts and lubricants or those recommended by HONDA.
4. Use special service tool where use of such a tool is specified.
5. Clean engine parts in or with cleaning solvent upon disassembly. Apply lubricant to their sliding surfaces when reassembling.
6. Coat or fill parts with grease where specified as such.
7. Upon assembling, check every possible part for proper installation and movement or operation.
8. When working with others, try to give a signal or communicate for safety.

Precautions for Readers

1. The procedures for reassembling the engine and frame parts are not described. Follow the reverse of disassembling procedures carefully observing the titles "Reassembly" in each section.
2. All the service data for each component are compiled on the last pages of this manual.



II. INSPECTION AND ADJUSTMENT

This section describes the inspection and adjustment procedures for the important items of the periodical maintenance of the HONDA 350 Model CB350F. Cross-refer to PERIODICAL MAINTENANCE SCHEDULE on page 74. For the items other than those described in this section, refer to "Inspection" of each part in this manual.

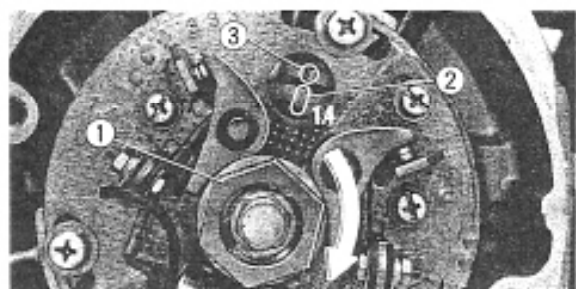


Fig. 2-1 ① Special nut ③ Matching mark
 ② Mark "T" 1.4

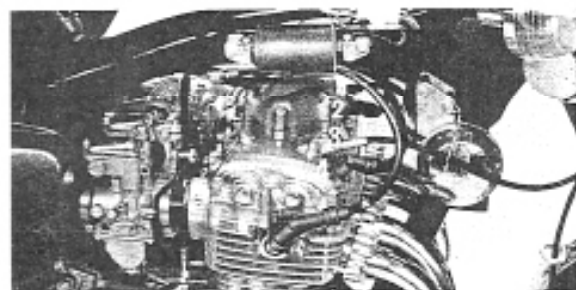


Fig. 2-2 Cylinder No

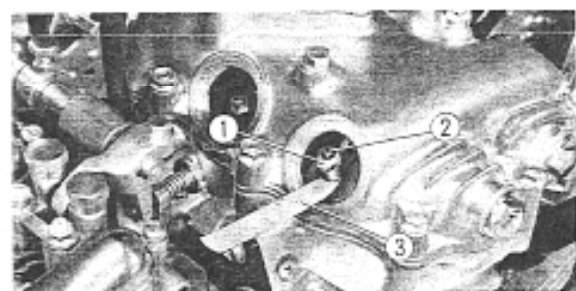


Fig. 2-3 ① Lock nut ③ Feeler gauge
 ② Adjusting screw

I. TAPPET

Inspection and adjustment of the tappet clearance should be made when the engine is cold.

1. Remove the fuel tank.
2. Remove the eight tappet hole caps. Remove the point cover.
3. Rotate the crankshaft clockwise at the special nut so as to align the mark "T" 1.4 with the matching mark.
4. Make sure if No. 1 piston is at the TDC position on compression stroke. If not, rotate the crankshaft a full turn clockwise so as to make proper alignment.
5. Check and adjust the tappet clearance of the "O" valves. (Refer to the table below).

To adjust, loosen the lock nut and turn the adjusting screw.

Tappet clearance	Intake valve 0.05 mm (0.002 in.)
	Exhaust valve 0.05 mm (0.002 in.)

Cylinder	No. 1	No. 2	No. 3	No. 4
Intake valve	○	×	○	×
Exhaust valve	○	○	×	×

6. Rotate the crankshaft a full turn clockwise so as to align the mark "T" 1.4 with the matching mark (in this position, the No. 4 piston is at TDC of the compression stroke) and check the "×" valves for correct tappet clearance.
7. Upon completion of the inspection and adjustment of the tappet clearance, install the tappet hole caps and point cover.
8. Install the fuel tank. Check the fuel tube for proper connection.

2. BREAKER POINT GAP AND IGNITION TIMING

Breaker point gap

- Remove the point cover.
- Rotate the crankshaft clockwise at the special nut. Check the maximum gap of the points 1.4.
 Maximum gap: 0.3~0.4mm (0.012~0.016in.)
 To adjust the gap, loosen the screw "a" and move the breaker base 1.4.
- Check the point gap of the points 2.3 in the same manner as for the points 1.4.
 To adjust, loosen the screw "b" and move the breaker base 2.3.

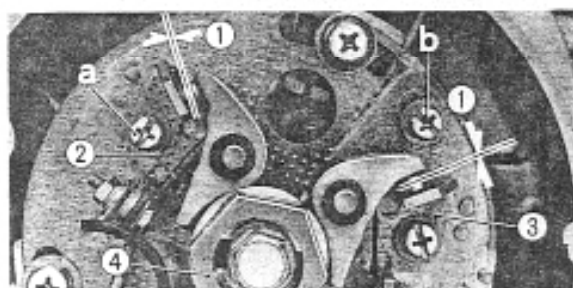


Fig. 2-4 ① Point gap ② Breaker base 2.3
 ③ Breaker base 1.4 ④ Special nut

Ignition timing

Test and adjust using a stroboscopic timing light (Service Tester SRH500, Tool No. 07171-99900).

- Make connection for the service tester as instructed by the tester manufacturer.
 Connect the timing light cord to the spark plug of the No. 1 or No. 4 cylinder.
- Start the engine and set its idle speed to 1,200rpm. Illuminate the matching mark with the timing light and see if the mark "F" 1.4 is aligned with the matching mark. If not aligned, loosen the three screws "c" and move the breaker base plate "e" in either direction.
 Moving the plate to the right will advance the ignition timing and to the left retard the timing.
- Increase the engine speed up to 2,500rpm and check the matching mark. If the mark stays between the advance marks, the ignition timing is correct.
- Connect the timing light cord to the spark plug of the No. 2 or No. 3 cylinder. Idle the engine and see if the mark "F" 2.3 is aligned with the matching mark. If not aligned, loosen the two screws "d" and move the breaker base plate "f" in either direction.

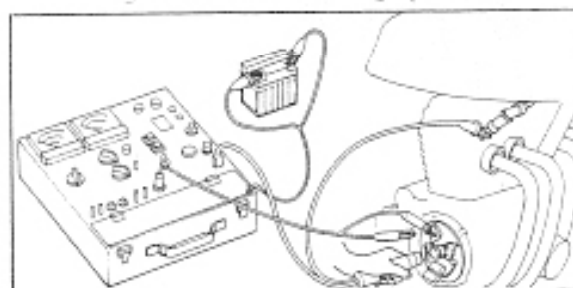


Fig. 2-5 Checking ignition timing

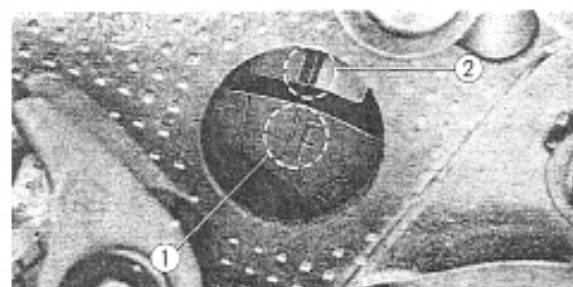


Fig. 2-6 ① Mark "F" 1.4
 ② Matching mark



Fig. 2-7 ① Breaker base plate "e"
 ② Breaker base plate "f"

- Increase the engine speed up to 2,500rpm and see if the mark "F" 2.3 stays between the two advance marks.

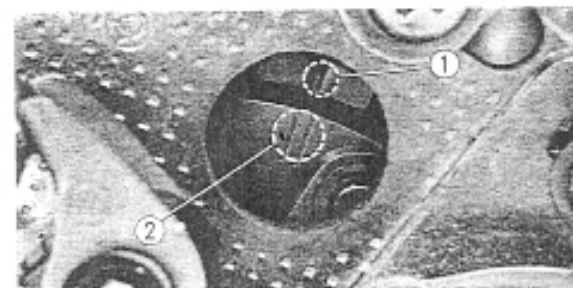


Fig. 2-8 ① Matching mark
 ② Advance marks

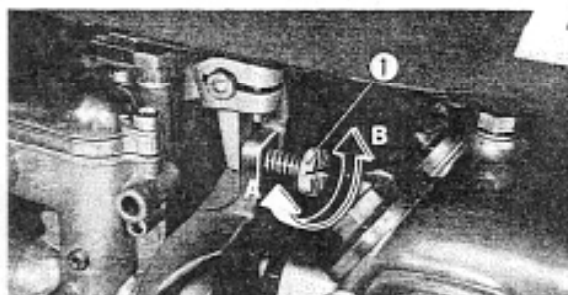


Fig. 2-9 ① Throttle stop screw

3. CARBURETOR

Carburetor should be serviced after the engine is warmed up.

Checking idle engine speed

1. To set the engine to 1,200rpm, turn the throttle stop screw. Turning the screw clockwise (in direction "A") will increase the engine idle speed, and vice versa (in direction "B").

Checking synchronization

1. Remove the four screws from the intake manifolds of the carburetors. Install the attachment A (Tool No. 07068-30007) and B (Tool No. 07068-30012) and install the vacuum gauges (Tool No. 07064-30001).
2. Start the engine and read each gauge.
Specified value: 16~24 cmHg

NOTE:

All the gauges should register the same value within the specification.

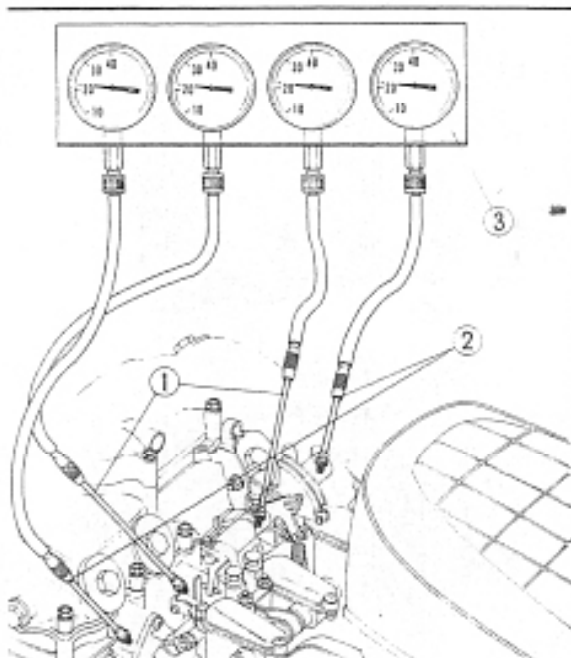


Fig. 2-10 ① Adaptor A ② Adaptor B ③ Vacuum gauge

Adjusting synchronization

1. Remove the fuel tank from the machine. Connect a longer fuel tube of the carburetor to the tank.
2. Turn the throttle stop screw to adjust the distance (H) between the throttle lever and stay to 56 mm (2.205 in.). Turning the screw clockwise (in direction "A") will increase the distance (H), and vice versa (in direction "B").

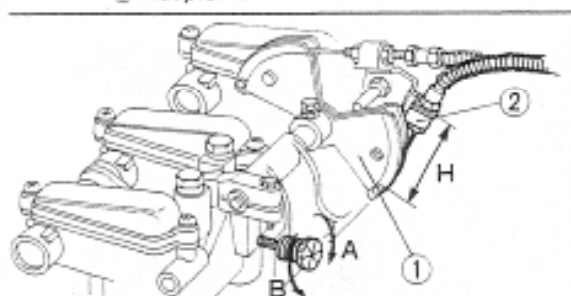


Fig. 2-11 ① Throttle lever ② Stay

3. Start the engine and see all the value within the specification. If out of the specification, loosen the lock nut and turn the adjusting screw to adjust. Turning the screw in direction "B" will increase the vacuum pressure, and vice versa (in direction "A").

NOTE:

Upon adjustment, tighten the lock nut securely and snap the throttle grip three or four times to recheck the synchronization

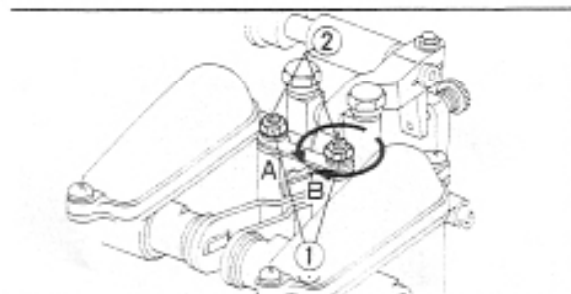


Fig. 2-12 ① Lock nut ② Adjusting screw

Adjusting fast idle speed

The adjustment should be made during the engine warm-up after synchronization of the carburetors has been adjusted.

1. Place the choke lever in the full open position and check the clearance (ℓ) between the link plate and adjusting screw.

Specified clearance: 0~0.3 mm (0~0.012 in.)

To adjust the clearance, loosen the lock nut and turn the adjusting screw. Turning the screw clockwise (in direction "A") will decrease the clearance and, vice versa (in direction "B").

2. Start the engine. Slowly operate the choke lever up and down to find the maximum engine rpm. If within the specifications of 3,500~4,500 rpm, the fast idle speed is satisfactory. If not, adjust by means of the adjusting screw. Turning the screw clockwise (in direction "A") will increase the engine rpm, and vice versa (in direction "B").

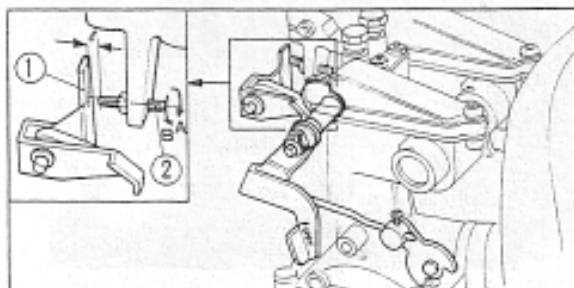


Fig. 2-13 ① Link plate
② Adjusting screw

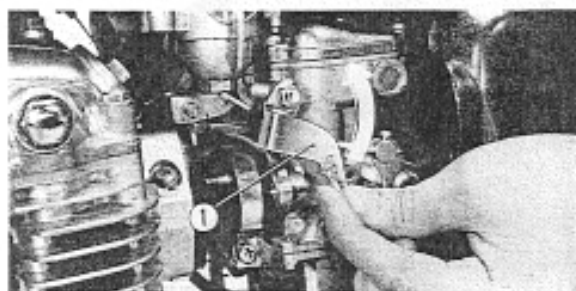


Fig. 2-14 ① Choke lever

Adjusting overtravel stopper

1. Return the throttle grip to the closed position. Loosen the lock nut and turn the link pin to adjust the clearance (H).

Specified clearance: 2.0~2.1 mm (0.079~0.083 in.)

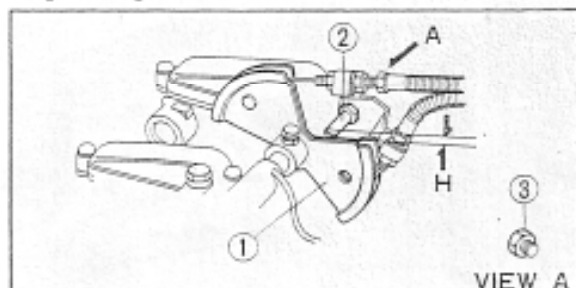


Fig. 2-15 ① Throttle lever
② Link pin
③ Lock nut

Adjusting throttle cable

1. Check the throttle grip for play.

Specified play: approx. 10° around the grip

To adjust the play, loosen the lock nuts and turn the adjusting nut. Turning the nut clockwise (in direction "A") will increase the play, and vice versa (in direction "B").

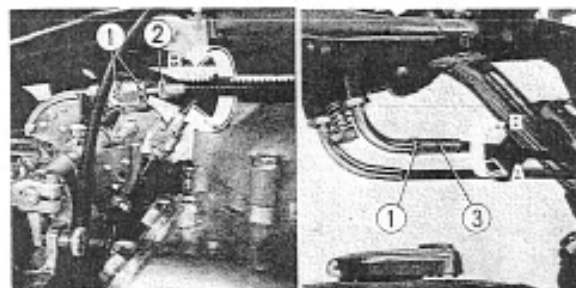


Fig. 2-16 ① Lock nut
② Adjusting nut
③ Cable adjuster

2. For fine adjustment, loosen the cable lock nut and turn the cable adjuster. Turning the adjuster clockwise (in direction "A") will decrease the play, and vice versa (in direction "B").

3. With the throttle grip in the fully closed position, see if the throttle lever contacts the link pin. Replace the throttle return cable, if the lever does not contact the pin.

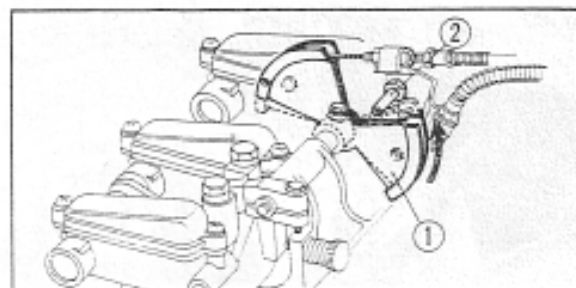


Fig. 2-17 ① Throttle lever
② Link pin

II. INSPECTION AND ADJUSTMENT

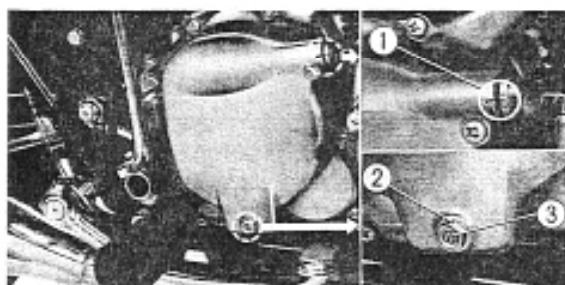


Fig. 2-18 ① Matching mark ② Lock nut ③ Clutch adjuster

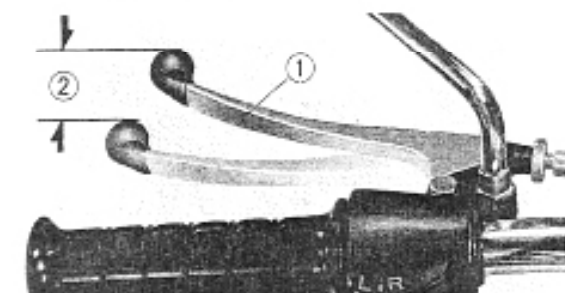


Fig. 2-19 ① Clutch lever ② Clutch lever free play

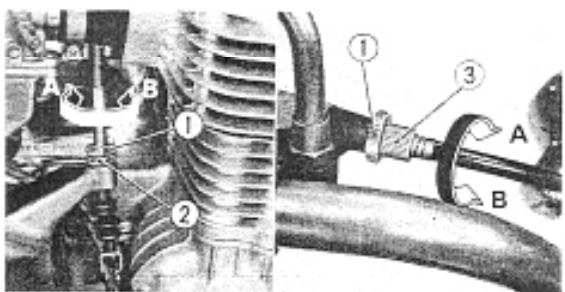


Fig. 2-20 ① Lock nut ② Clutch cable lower adjuster ③ Clutch cable upper adjuster

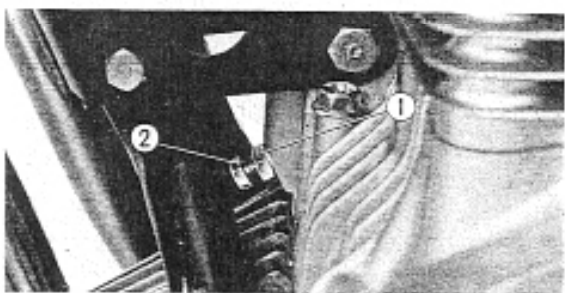


Fig. 2-21 ① Lock nut ② Adjusting bolt

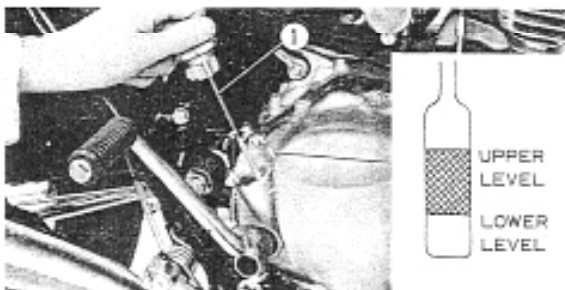


Fig. 2-22 ① Oil level gauge

4. CLUTCH

1. Align the matching mark on the clutch lever with that on the R. crankcase cover and loosen the lock nut. Turn the clutch adjuster counterclockwise until it becomes tight and back it off about 1/4 turn. Tighten the lock nut.

2. Check the tip of the clutch lever for free play. Specified play: 10~20 mm (0.4~0.8 in.)
3. To adjust the play, loosen the lock nut and turning the lower adjuster clockwise (in direction "A") will increase the play, and vice versa (in direction "B").

4. Fine adjustment can be made by means of the upper adjuster of the clutch cable. When adjusting, loosen the lock nut.
5. Upon adjustment, make sure the clutch operates properly.

5. CAM CHAIN

1. Start the engine.
2. Set the engine idle speed to 1,200 rpm. Loosen the lock nut and tensioner adjusting bolt using box wrench contained in tool kit.
3. Retighten the adjusting bolt and secure the lock nut.

NOTE:

Do not pull or push the tensioner push bar since it is self-adjusting type.

6. ENGINE OIL

Checking oil level

1. Lower the main stand to support the machine. Insert the oil level gauge into the engine case, not screwed in, to check the oil level. Oil should be up to the upper level on the gauge.

Changing oil

1. Loosen the drain bolt and remove the oil filter by loosening its center bolt. Drain oil out of the crankcase.
2. Retighten the drain bolt and reinstall the oil filter.
3. Fill with recommended oil through the oil filler opening.

Capacity: 3.5 ℓ (3.7 US qt., 3.11mp. qt.)

Recommended oil: SAE 10 W-40 (All weather)

SAE 20 W-50 (Above 59°F or 15°C)

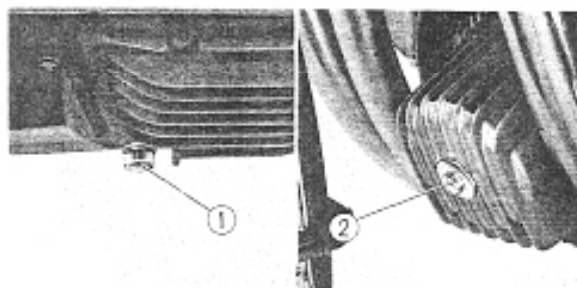


Fig. 2-23 ① Drain bolt
② Oil filter center bolt

7. FRONT BRAKE

Checking fluid level

1. Remove the fluid cup cap of the master cylinder.
2. Check to see the brake fluid level is up the level line inside the cup. If the level is low, add SAE DOT 3 brake fluid.

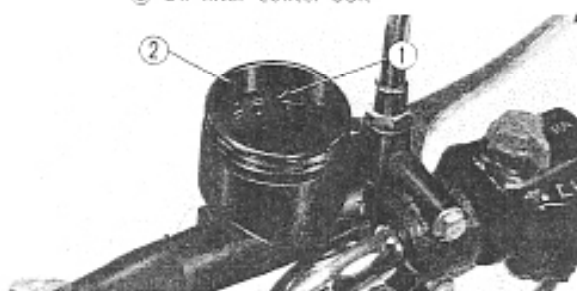


Fig. 2-24 ① Level line
② Fluid cup

Adjusting calipers

1. Loosen the lock nut and turn the adjusting bolt counterclockwise until the pad B contacts the disc.
2. Turn the bolt clockwise 1/3 to 1/2 turn from this position and tighten the lock nut.

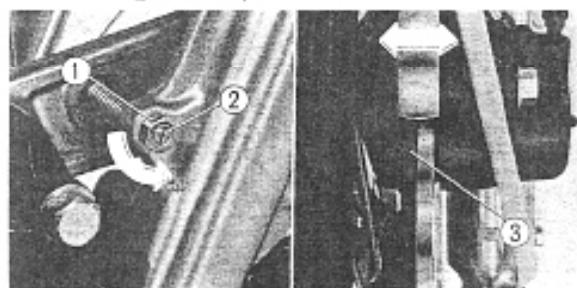


Fig. 2-25 ① Lock nut
② Adjusting bolt
③ Pad B

Bleeding

1. Fill the fluid cup with brake fluid up to the fluid level line.
2. Remove the bleeder cap and connect a vinyl hose to the bleeder valve.
3. Operate the brake lever several times until a resistance is felt. Loosen the bleeder valve about 1/4 turn using a spanner to bleed air. Retighten the bleeder valve and stop operating the brake lever. Repeat this procedure until no bubbles are contained in the fluid coming out of the valve.

NOTE:

Keep the fluid cup properly filled during the bleeding operation.

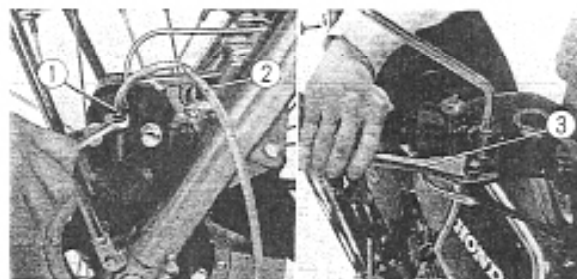


Fig. 2-26 ① Bleeder valve
② Vinyl hose
③ Brake lever

8. REAR BRAKE

1. To adjust the depressed-height of the rear brake pedal, loosen the lock nut and turn the adjusting bolt. Turning the bolt clockwise (in direction "A") will decrease the height, and vice versa (in direction "B").

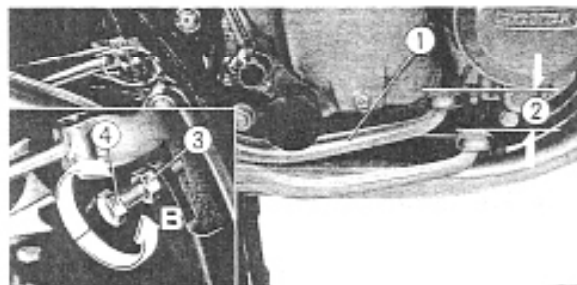


Fig. 2-27 ① Rear brake pedal
② Free travel
③ Lock nut
④ Adjusting bolt

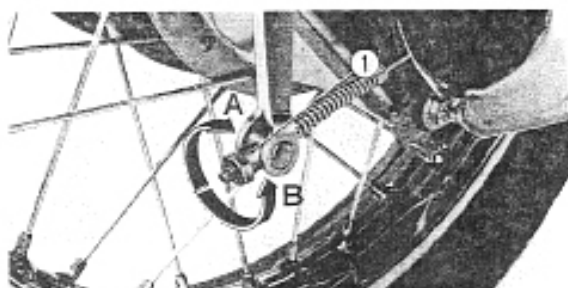


Fig. 2-28 ① Adjusting nut

- To adjust the free travel at the tip of the pedal, turn the adjusting nut. Turning the nut clockwise (in direction "A") will decrease the free travel, and vice versa (in direction "B").

Specified free travel: 20~30 mm (0.8~1.2 in.)

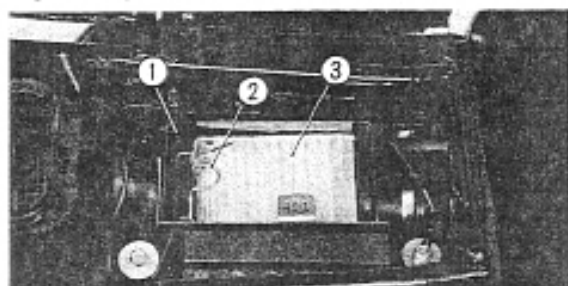


Fig. 2-29 ① Air cleaner case ② Set spring
③ Air cleaner

9. AIR CLEANER

- Open the seat.
- Remove the tool tray and air cleaner cover.
- Remove the set spring to remove the air cleaner element.
- Lightly tap the element by hand and apply a blast of compressed air from inside.
- Check the hole at the bottom of the air cleaner case for clogging.

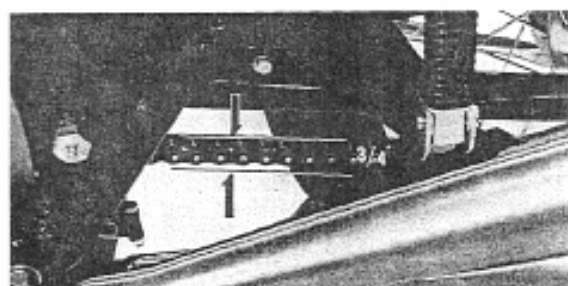


Fig. 2-30 Checking drive chain sag

10. DRIVE CHAIN

Checking drive chain tension

- Check the chain tension by finger-depressing at a point half way between the sprockets and by measuring the sag.
Specified sag: 20 mm (3/4 in.)

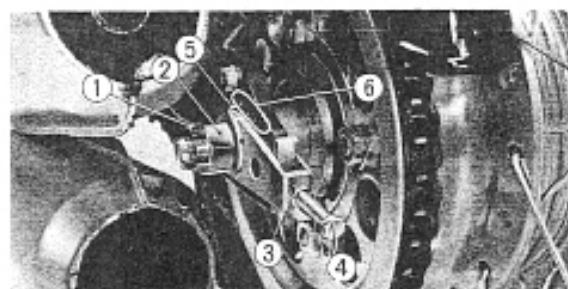


Fig. 2-31 ① Cotter pin ④ Adjusting nut
② Axle nut ⑤ Index mark
③ Lock nut ⑥ Side scale

- To adjust, remove the cotter pin, loosen the axle nut and lock nut, and turn the adjusting nut in either direction.

Upon adjustment, align the index marks on the right and left drive chain adjusters with the same notches in the side scales. Tighten the axle nut and install the cotter pin.

11. FRONT FORK

Changing fork oil

- Loosen the front fork bolts and drain bolts. Drain oil out of the fork cylinders.
- Retighten the drain bolts and fill the front fork cylinders with any brand of automatic transmission fluid for motorvehicle.

Capacity: 105 cc (3.6 ozs.) per cylinder

NOTE:

- * 125cc (4.2 ozs.) oil will be required to fill one fork when disassembled.
- * Torque the front fork bolt to the specification.

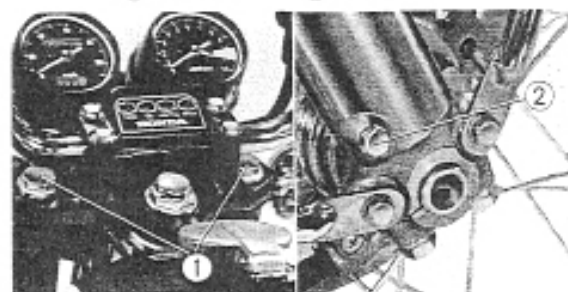


Fig. 2-32 ① Front fork bolts
② Drain bolt

III. ENGINE

1. ON-VEHICLE SERVICING

Parts to be serviced	Ref. pages
Cylinder head and camshaft	12
Cylinder and pistons	12
Oil Pump and oil filter	18
Clutch	20
Kick starter	22
Gear shift mechanism	23
Cam chain tensioner	30
Carburetor	35
Electrical system (generator and contact points)	—

2. ENGINE REMOVAL AND INSTALLATION

The preliminary works for the engine removal are shown in the diagram below. Proceed in the numerical order shown. To install, reverse the removal order.

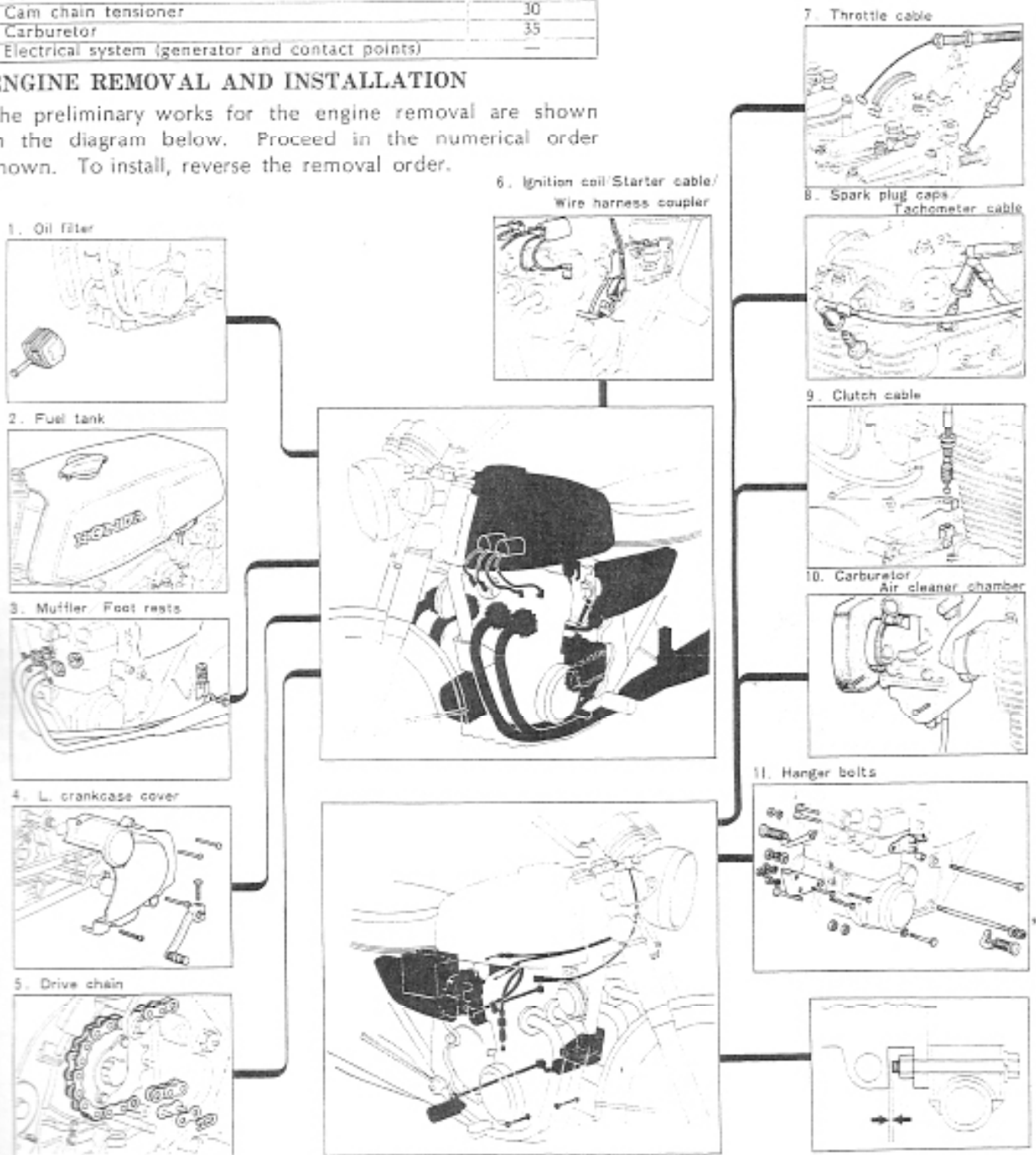


Fig. 3-1

Use specified hanger bolts (10x75mm) at lower crankcase front. Be sure to install spring washer

CYLINDER HEAD, CAMSHAFT, CYLINDER AND PISTONS

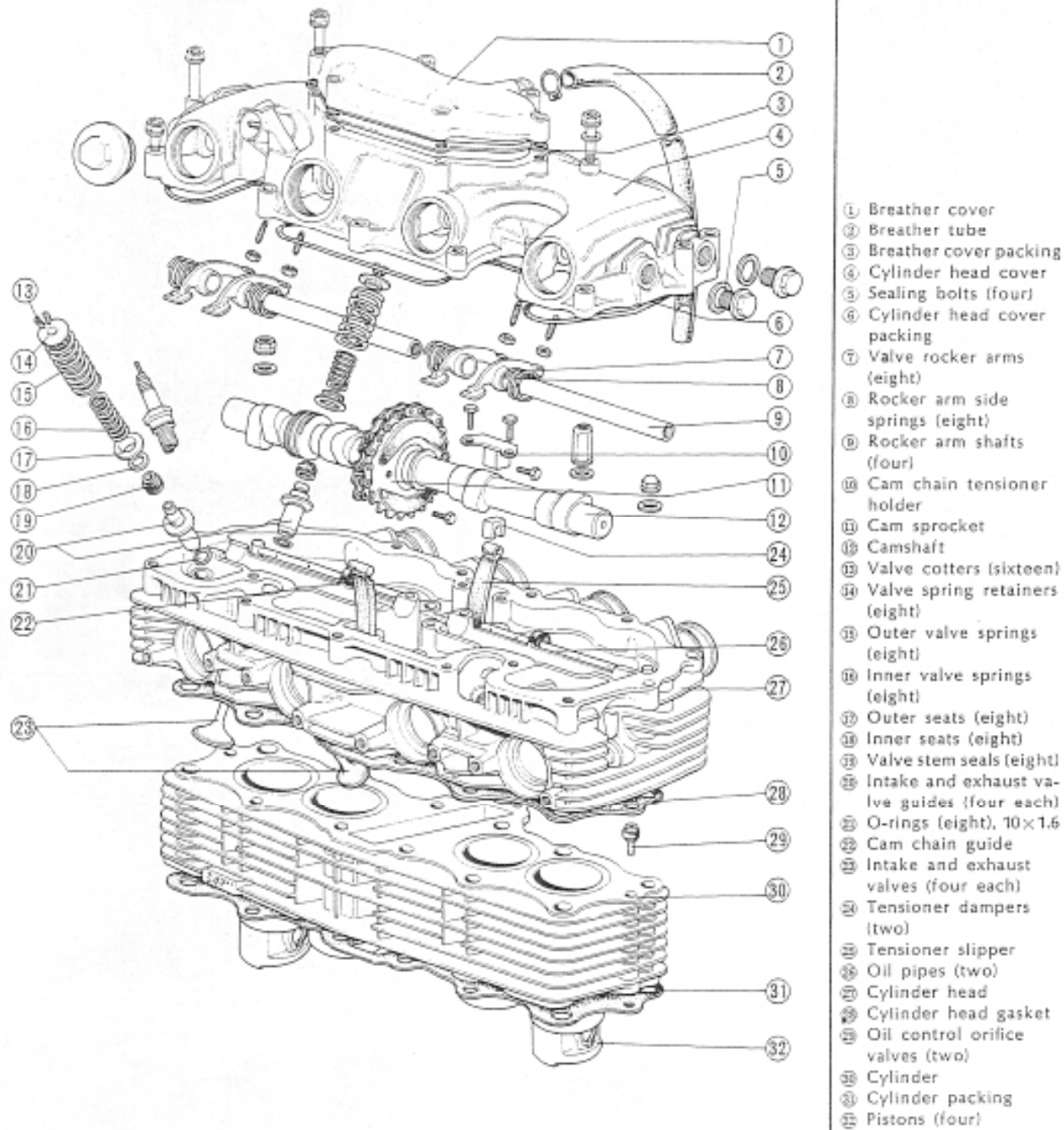


Fig. 3-2



Disassembly

1. Open the seat. Remove the fuel tank.
 2. Remove the ignition coils.
 3. Remove the breather cover.
 4. Disconnect the tachometer cable.
 5. Remove the eight tappet hole caps and loosen the rocker arm adjusting screws. Then remove the cylinder head cover. To remove the rocker arm shaft, remove the cap nut and screw a 10 mm (pitch 1.25 mm) bolt in the shaft.
 6. Remove the muffler.
 7. Remove the four spark plug caps and remove Nos. 2 and 3 spark plugs.
 8. Remove the cam chain tensioner holder and remove the cam chain tensioner slipper.
 9. Remove the point cover.
 10. Hand-rotate the crankshaft at the special nut until one of the cam sprocket knock bolts comes upward, and remove the bolt. Further rotate the crankshaft a full turn to remove another bolt.
 11. Remove the cam sprocket from the camshaft and remove the cam chain.
 12. Pull out the camshaft from the right side.
- NOTE:**
Hold the cam chain with wire or the like to prevent the chain from falling in the crankcase.
13. Remove the air cleaner element and loosen the air cleaner chamber retaining screw.

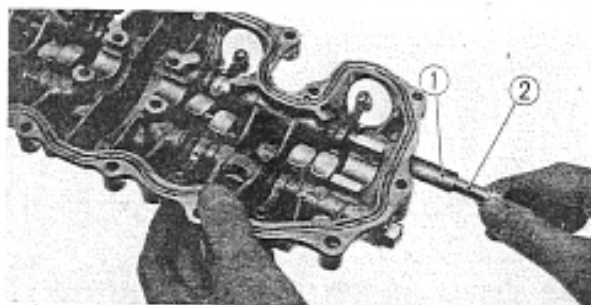


Fig. 3-3 ① Rocker arm shaft
② 10 mm (pitch 1.25 mm) bolt

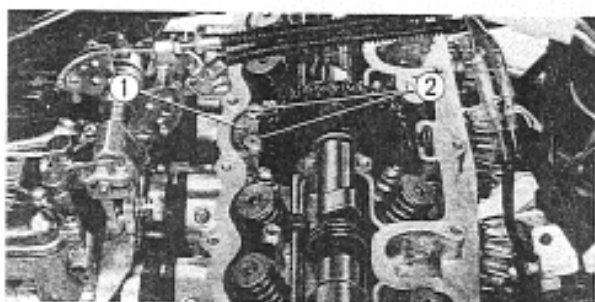


Fig. 3-4 ① Cam chain tensioner holder
② 6×20 bolts

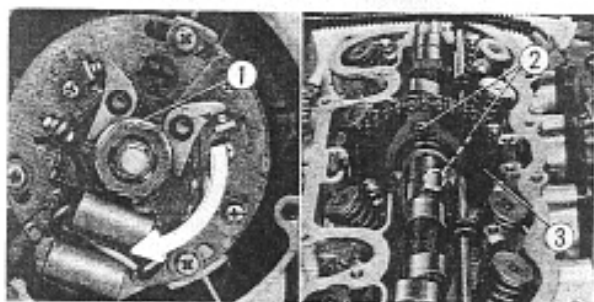


Fig. 3-5 ① Special nut
② Knock bolts
③ Cam sprocket

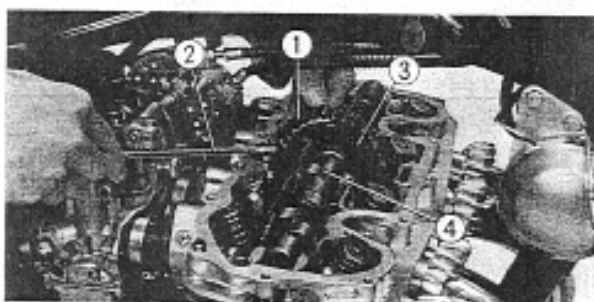


Fig. 3-6 ① Cam chain
② Screwdriver
③ Cam sprocket
④ Camshaft



Fig. 3-7 ① Air cleaner chamber
② Retaining screw

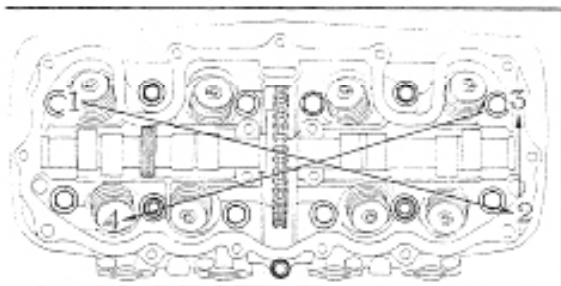


Fig. 3-8 Removal sequence of cylinder head securing bolts

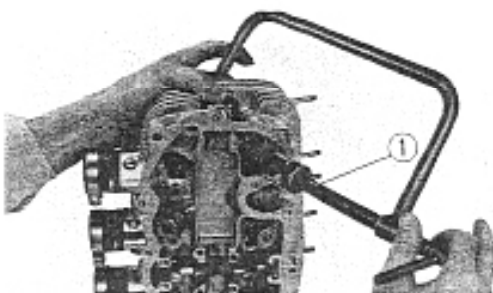


Fig. 3-9 ① Valve lifter

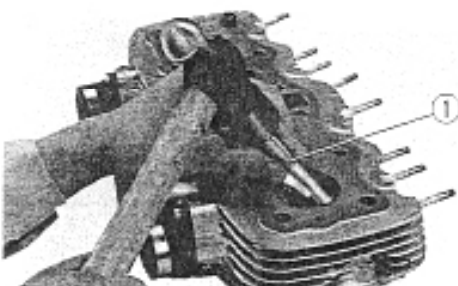


Fig. 3-10 ① Valve guide remover

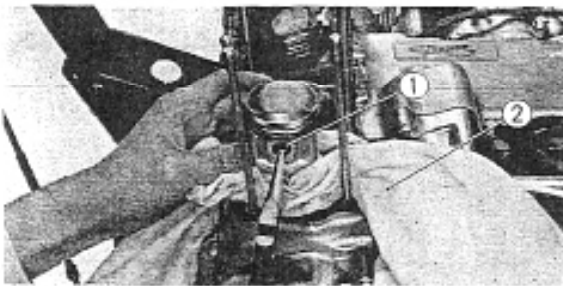


Fig. 3-11 ① Piston pin clip
② Waste cloth

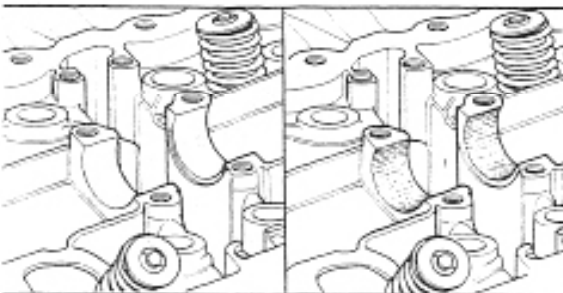


Fig. 3-12 Good No good

14. Remove the carburetors.
15. Loosen the cylinder head securing bolts in a criss-cross pattern, starting at external one as shown in Fig. 3-8.
16. Take out the cam chain guide and remove the cylinder head.

- 1) Use valve lifter (Tool No. 07031-32901) to compress the valve spring and remove the valve cotter. Then remove the valve and valve spring.

- 2) Replacing valve guide
Use valve guide remover (Tool No. 07046-32901) to remove the valve guide.

17. Remove the cylinder.

18. Remove the piston pin clips to pull out the piston pin. Remove the piston.

NOTE:

1. Put a waste cloth or the like under the piston not to fall the pin clips in the crankcase.
2. Take care not to damage the piston when removing the piston rings.

Inspection

Camshaft and cylinder head

1. Check the rocker arm-to-rocker arm shaft clearance.
2. Check the cylinder head camshaft bearing surfaces for scratches and excessive wear.

3. Measure the height of each cam.
4. Check the camshaft center journal for deflection.
5. Measure the valve seat width.
Coat the valve seat with prussian blue thinly and uniformly. Hold the valve against the seat and rotate it one turn. If the prussian blue shows a band of uniform width all the way around both seat and valve, the valve contact is proper. In case the contact is improper, lap the valve and recheck. If still defective, reface the valve seat.

NOTE:

When using a valve seat grinder, be sure to follow the instructions given by the tool manufacturer.

6. Measure the outside diameter of the valve stem.
7. Check the valve-to-valve guide clearance.
8. Measure the free length of the valve spring.
9. Check the cylinder head surface for flatness.

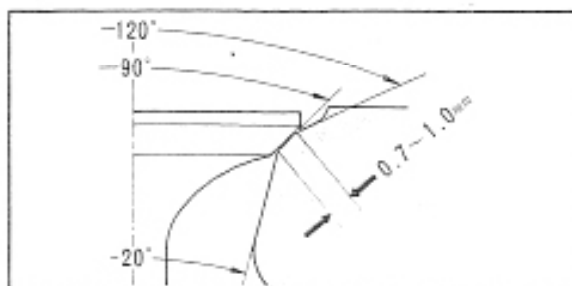


Fig. 3-13 Valve seat contact

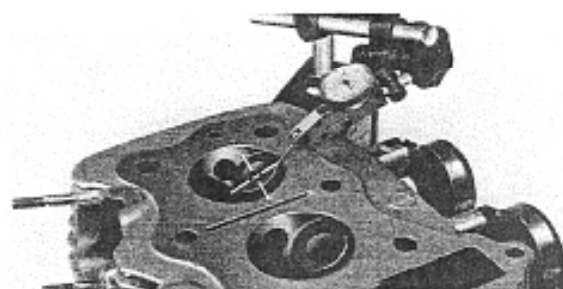


Fig. 3-14 Checking valve-to-valve guide clearance

Cylinder and pistons

1. Measure the inside diameter of each cylinder.
Measure the inside diameter of cylinder with a cylinder gauge at the top, center and bottom, in parallel (X) with, and at right angles (Y) to, the center line of the cylinder.
2. Measure the outside diameter of the piston at its skirt.
3. Measure the inside diameter of the piston pin hole.
4. Measure the outside diameter of the piston pin.
5. Check the piston ring-to-piston pin groove clearance.
6. Check the piston ring end gap.
Insert the cylinder skirt to make measurement of the gap using a thickness gauge.

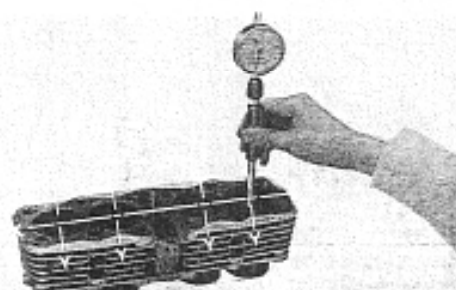


Fig. 3-15 Checking inside diameter of cylinder



Fig. 3-16 Checking piston ring end gap

Reassembly**Piston rings**

1. Use the piston rings of the same make in a set. Install the rings to the piston with their markings facing upward.

Marking	Manufacturer
N	NIHON PISTON RING
R	RIKEN PISTON RING
T	TEIKOKU PISTON RING

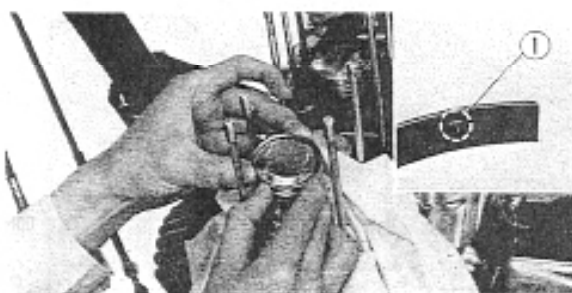


Fig. 3-17 ① Marking

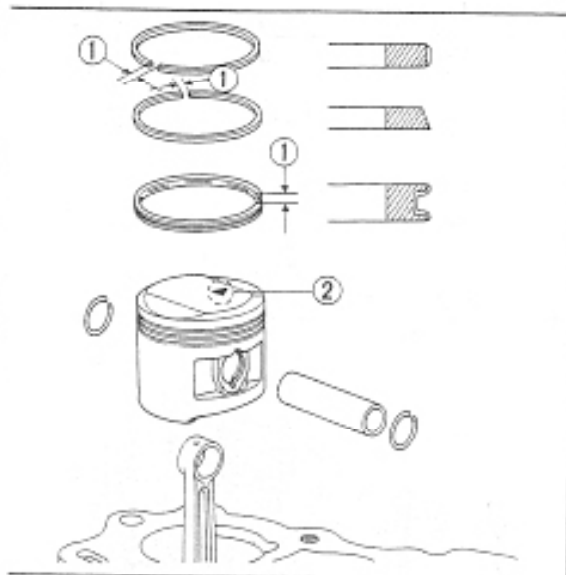


Fig. 3-18 ① Piston ring gap
② Piston mark

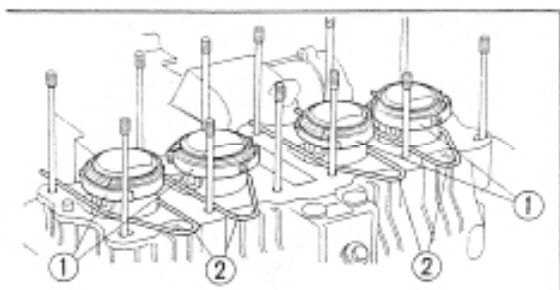


Fig. 3-19 ① Piston ring compressors
② Piston bases

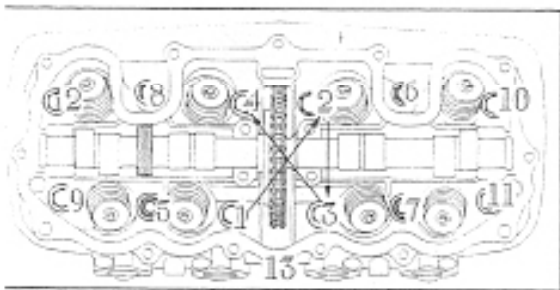


Fig. 3-20 Cylinder head nuts tightening sequence

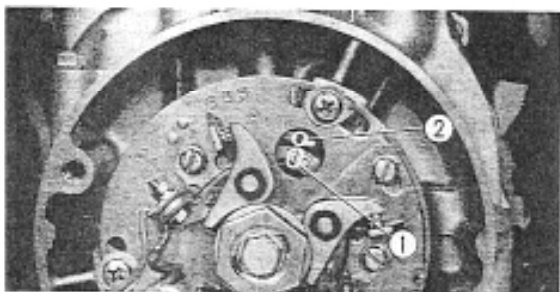


Fig. 3-21 ① "T" 1.4 mark
② Matching mark

2. When a new ring is used, check it for proper fit in the piston ring groove.
3. Position the rings so that their gaps of the top, second and oil rings are staggered 120° , each being apart from the direction at right angles to the piston pin.

Pistons

Install the piston with the arrow mark on the piston head toward the front (exhaust side) and "IN" mark toward the rear (intake side) of the engine.

Cylinder

1. Rotate the crankshaft so that all the four pistons will rise in a line and install the piston bases (Tool No. 07033-33301) to the pistons. Set the base in the groove below the piston boss. Then install the piston compressors (Tool No. 07032-33301) on the piston rings. Gradually lower the cylinder until all the piston rings enter the cylinder bores. Remove the piston bases and piston compressors.

NOTE:

Apply a coat of engine oil to the piston rings before installing the pistons into the cylinder.

2. Check the oil control orifice valve for clogging before installation.

Cylinder head

1. When installing a new valve guide, drive it in using valve guide driver (Tool No. 07047-32901) and ream with reamer (Tool No. 07008-20002).
2. Apply a coat of engine oil to the threads of the nut and tighten the nuts in a criss-cross pattern, starting at the internal one as shown in Fig. 3-20.

Torque specification :

200kg-cm (14.5ft-lbs)

Valve timing

1. Rotate the crankshaft and align the mark "T" 1.4 on the spark advancer with the matching mark as shown in Fig. 3-21.

2. Install the cam chain to the cam sprocket so that the matching lines on the sprocket will be aligned with the upper surface of the cylinder head.
3. Install the cam sprocket to the camshaft with two knock bolts.

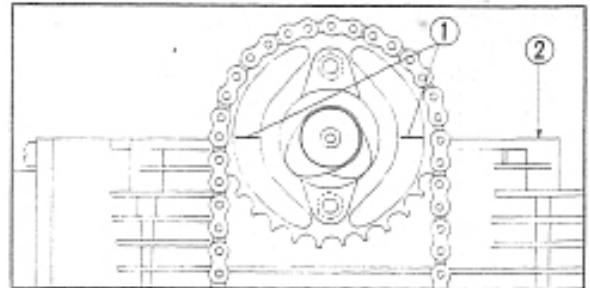


Fig. 3-22 ① Cam sprocket matching lines
 ② Cylinder head upper surface

Cylinder head cover

1. Apply a liquid packing to the cylinder head cover packing groove. Install the packing in place. Replace packing if damaged.

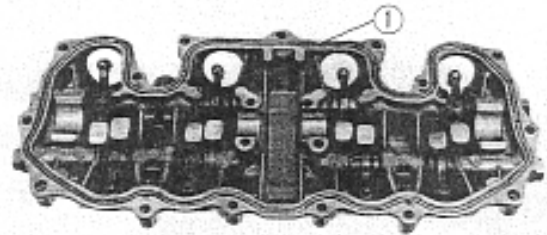


Fig. 3-23 ① Cylinder head cover packing

2. Tighten the bolts securing the cylinder head cover in the sequence as shown in Fig. 3-24.

Torque specification :

70~110 kg-cm (5.1~8.0 lbs-ft)

NOTE:

The torque difference of each bolt should be within 20 kg-cm (1.5 lbs-ft).

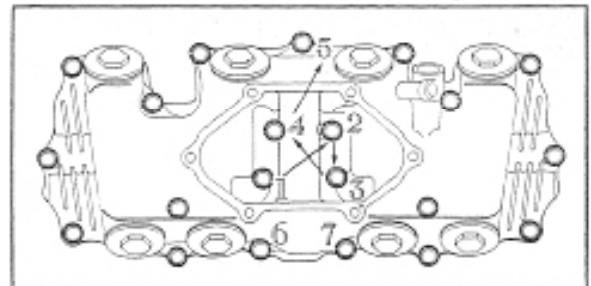


Fig. 3-24 Tightening sequence of cylinder head cover bolts

1. OIL PUMP AND OIL FILTERS

- The oil pump is a double trochoid pump driven by the primary shaft.
- One oil filter uses a screen and the another, paper element to provide two-stage filtering.

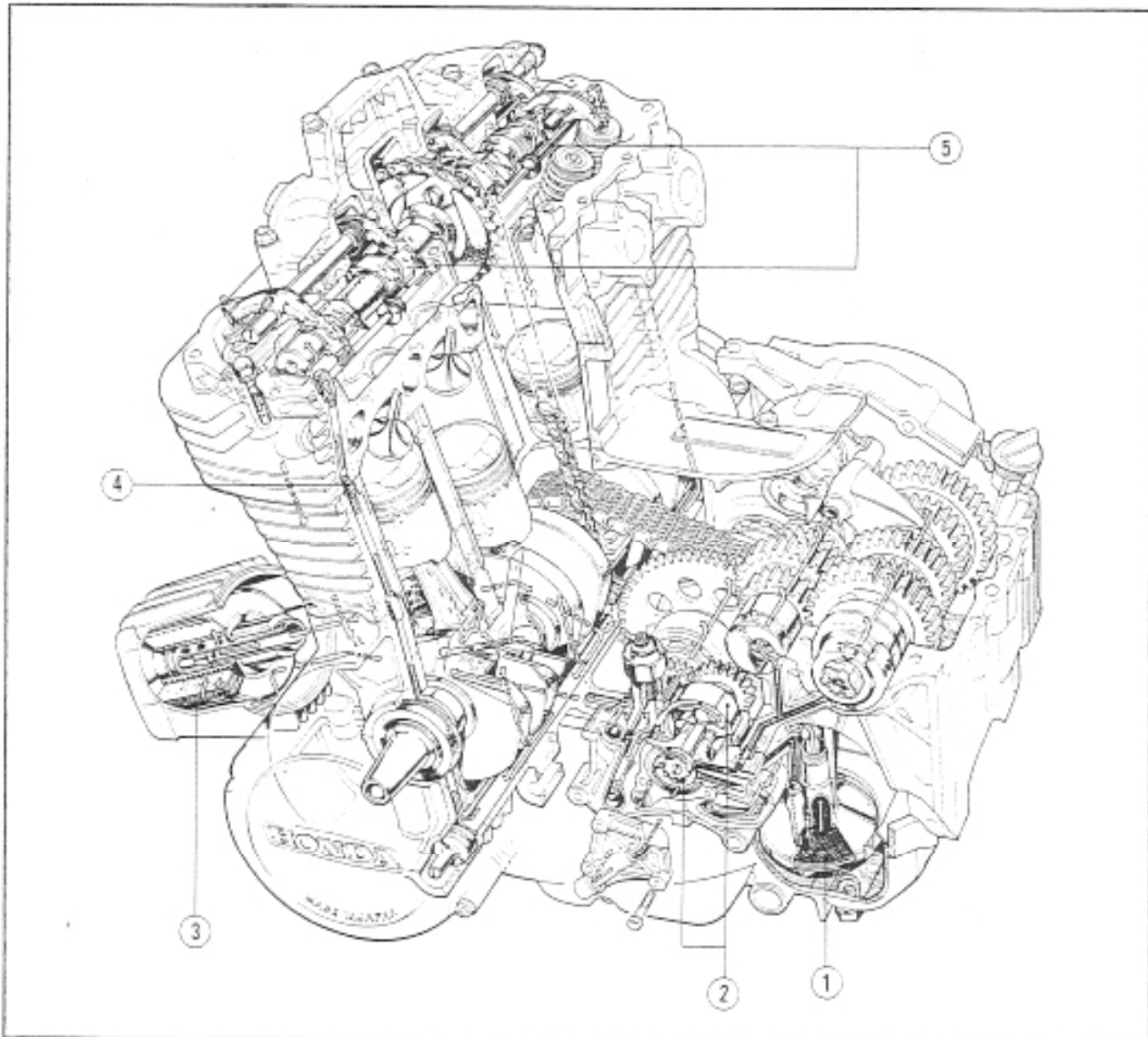
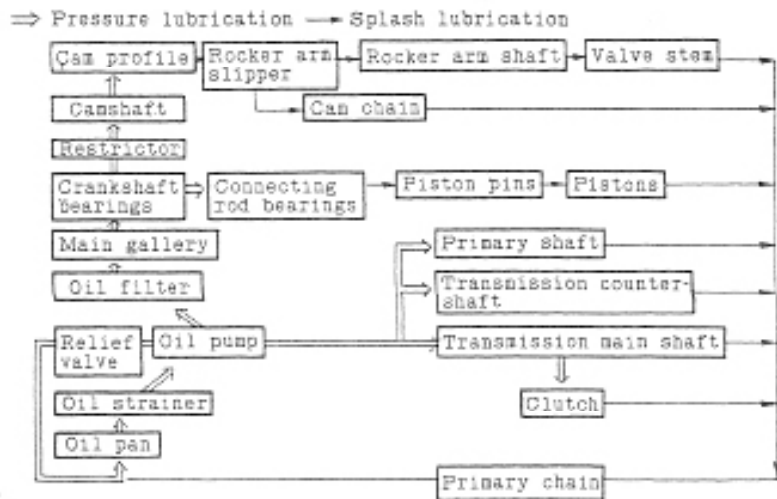


Fig. 3-25 Lubricating oil circuits

① Oil strainer ② Oil pump ③ Oil filter ④ Oil control orifice valve ⑤ Oil pipe

Disassembly**Oil pump**

1. Remove the gear change pedal and left-hand side foot rest.
2. Remove the L. crankcase cover.
3. Disconnect the oil pressure switch cord.
4. Remove the oil pump.

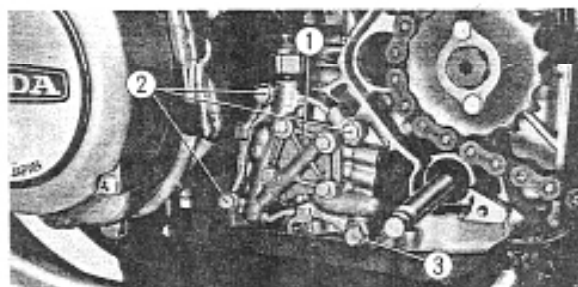


Fig. 3-26 ① Oil pump ③ 8 mm bolt
② 6 mm bolts

Oil screen filter

1. Drain the crankcase.
2. Remove the oil pan.
3. Remove the oil screen filter.

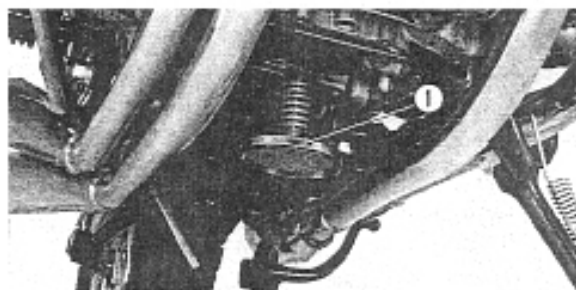


Fig. 3-27 ① Oil screen filter

Oil filter

1. Loosen the oil filter center bolt to remove the oil filter.

Inspection**Oil pump**

1. Check the outer rotor-to-pump body clearance.
2. Check the inner rotor-to-outer rotor clearance.
3. Check the relief valve for dust entry and for operation.

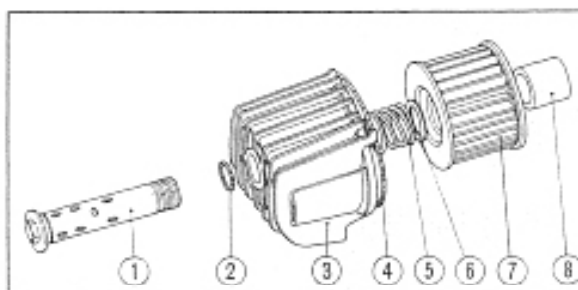


Fig. 3-28 ① Oil filter center bolt
② O-ring, 15×2.5
③ Oil filter case
④ O-ring, 89×4.5
⑤ Set spring
⑥ Spring seat
⑦ Oil filter element
⑧ Oil filter bolt collar

Reassembly

1. Be sure to install O-rings in their proper locations as shown.
2. Check the oil level in the crankcase and add oil if necessary.
3. Make sure the oil filter is properly assembled. (See Fig. 3-28)

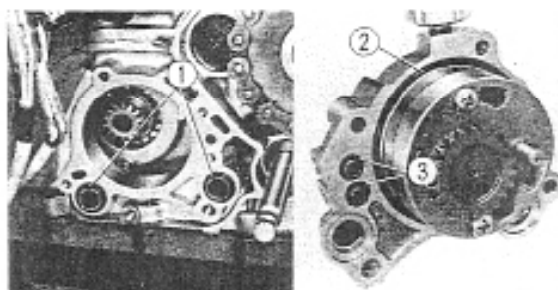


Fig. 3-29 ① O-ring, 15×2.5
② O-ring, 63×2.5
③ O-ring, 9.9×1.5

CLUTCH

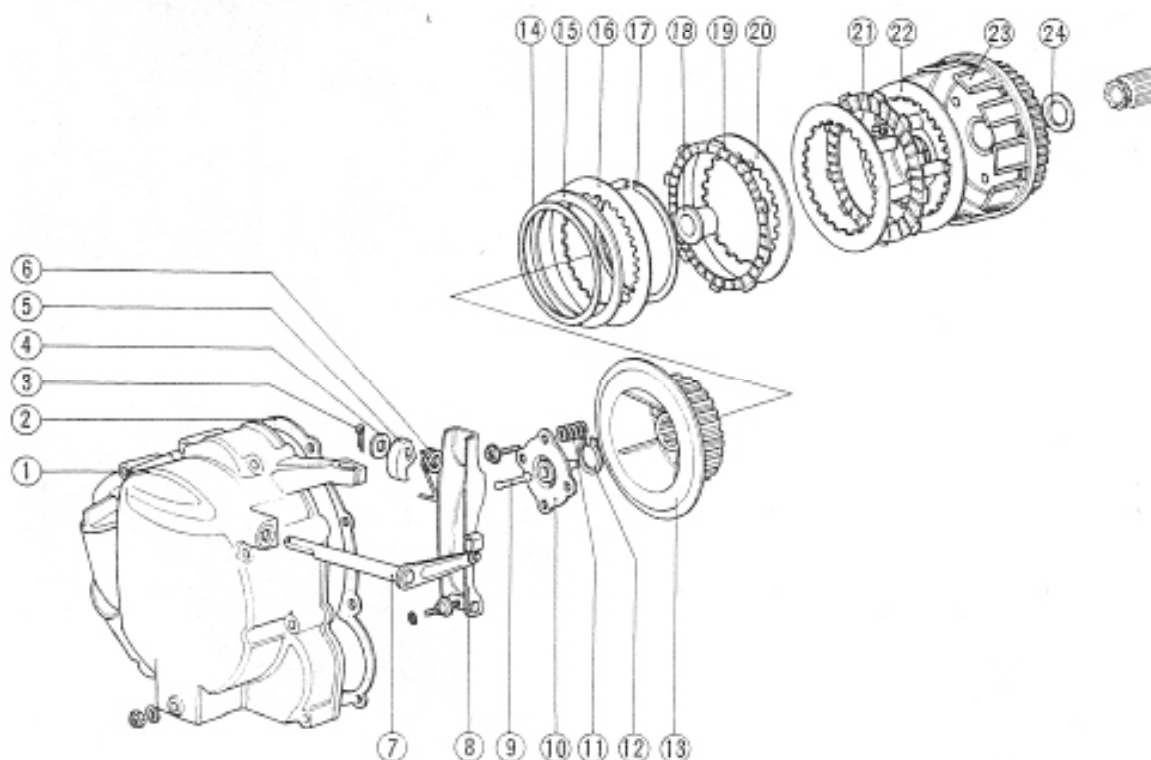


Fig. 3-30

- | | | | |
|------------------------------|--------------------------|---------------------------|-------------------------------|
| • Crankcase cover, R | ⑦ Clutch lever | ⑲ Clutch center | Ⓜ Clutch friction disc |
| • Cover packing | ⑧ Clutch adjusting lever | Ⓜ Disc spring seat | Ⓜ Clutch plates (six) |
| • Cotter pin, 2.0×15 | ⑨ Clutch lifter rod | Ⓜ Clutch disc spring | Ⓜ Clutch friction discs (six) |
| • Washer, 10mm | ⑩ Clutch lifter plate | Ⓜ Clutch plate B | Ⓜ Clutch pressure plate |
| • Clutch lifter cam | ⑪ Clutch springs (four) | Ⓜ Special set ring, 92 mm | Ⓜ Clutch outer |
| • Clutch lever return spring | ⑫ Snap ring, 25 mm | Ⓜ Collar, 25 mm | Ⓜ Thrust washer, 25mm |

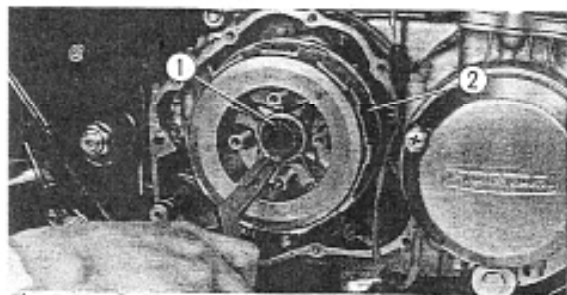


Fig. 3-31 ① 25 mm snap ring
② Clutch assembly

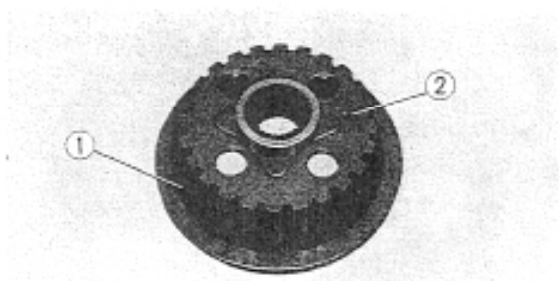


Fig. 3-32 ① 92 mm special set ring
② Clutch center

Disassembly

1. Drain oil from the crankcase.
2. Remove the right-hand side foot rest and kick starter pedal.
3. Remove the R. crankcase cover
4. Remove the clutch pressure plate.
5. Remove the 25 mm snap ring and remove the clutch assembly.
6. Remove the 92 mm special set ring from the clutch center. Disassemble the clutch plate B, clutch disc spring and disc spring seat.
7. Remove the clutch lever and clutch adjuster lever from the R. crankcase cover.

Inspection

1. Measure the thickness of the friction disc.
2. Check the clutch plate for distortion.
3. Measure the free length of the clutch spring.
4. Check the clutch center-to-clutch plate B clearance (δ), and if beyond specified limit, replace clutch plate B.

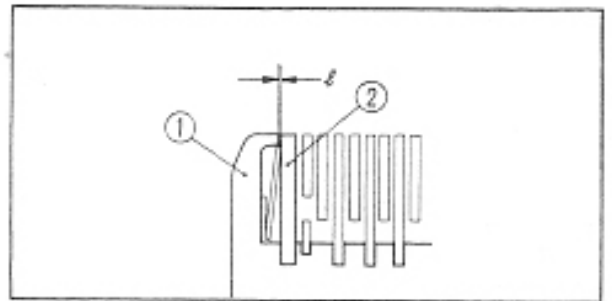


Fig. 3-33 ① Clutch center
 ② Clutch plate B

Reassembly

1. Install the disc spring seat and clutch disc spring in proper direction as shown.

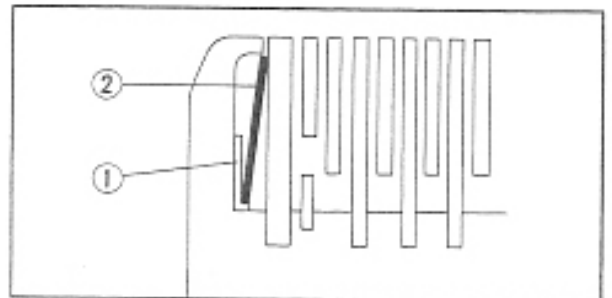


Fig. 3-34 ① Disc spring seat
 ② Clutch disc spring

2. Be sure to install the 25mm thrust washer.
3. Alternately install the friction discs and clutch plates to the clutch outer, and finally install the 8mm friction disc (see ⑥, Fig. 3-30).

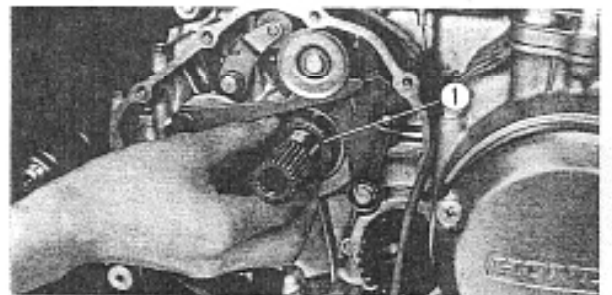


Fig. 3-35 ① 25 mm thrust washer

MEMO

KICK STARTER

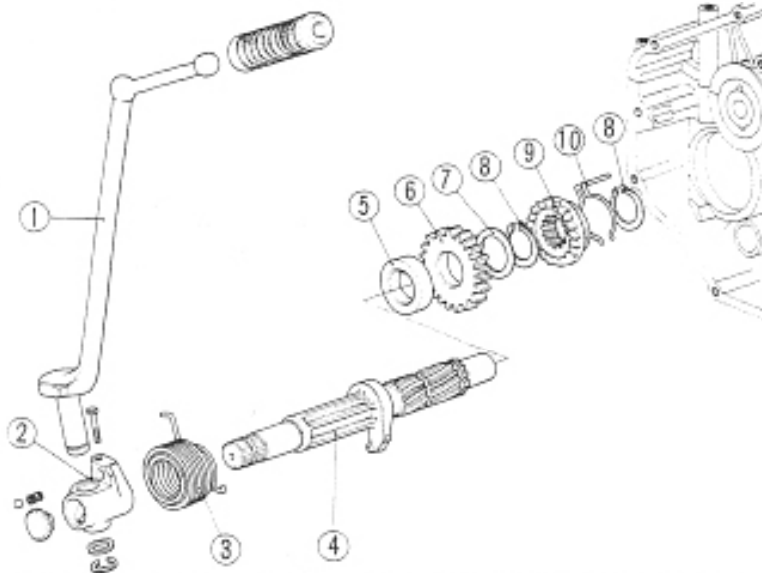


Fig. 3-36

- | | | | |
|-----------------------|------------------------|-------------------------|----------------------------------|
| ① Kick starter arm | ④ Kick starter spindle | ⑦ Thrust washer, 20 mm | ⑩ Starter pinion friction spring |
| ② Kick arm joint | ⑤ Collar | ⑧ Set rings (two) 20 mm | |
| ③ Kick starter spring | ⑥ Kick starter pinion | ⑨ Starter drive ratchet | |

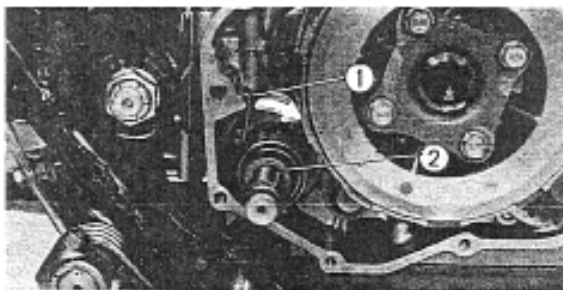


Fig. 3-37 ① Kick starter spring
② Kick starter spindle

Disassembly

1. Drain oil from the crankcase.
2. Remove the R. foot rest and kick starter pedal.
3. Remove the R. crankcase cover.
4. Remove the kick starter spring and remove the kick starter assembly.

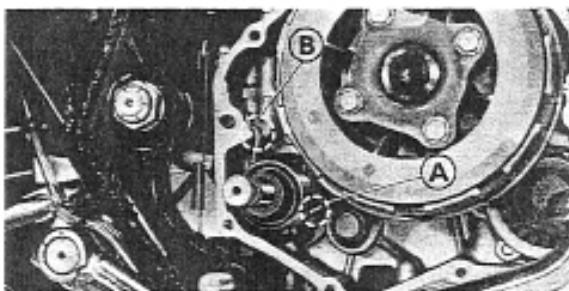


Fig. 3-38 Installing kick starter spring

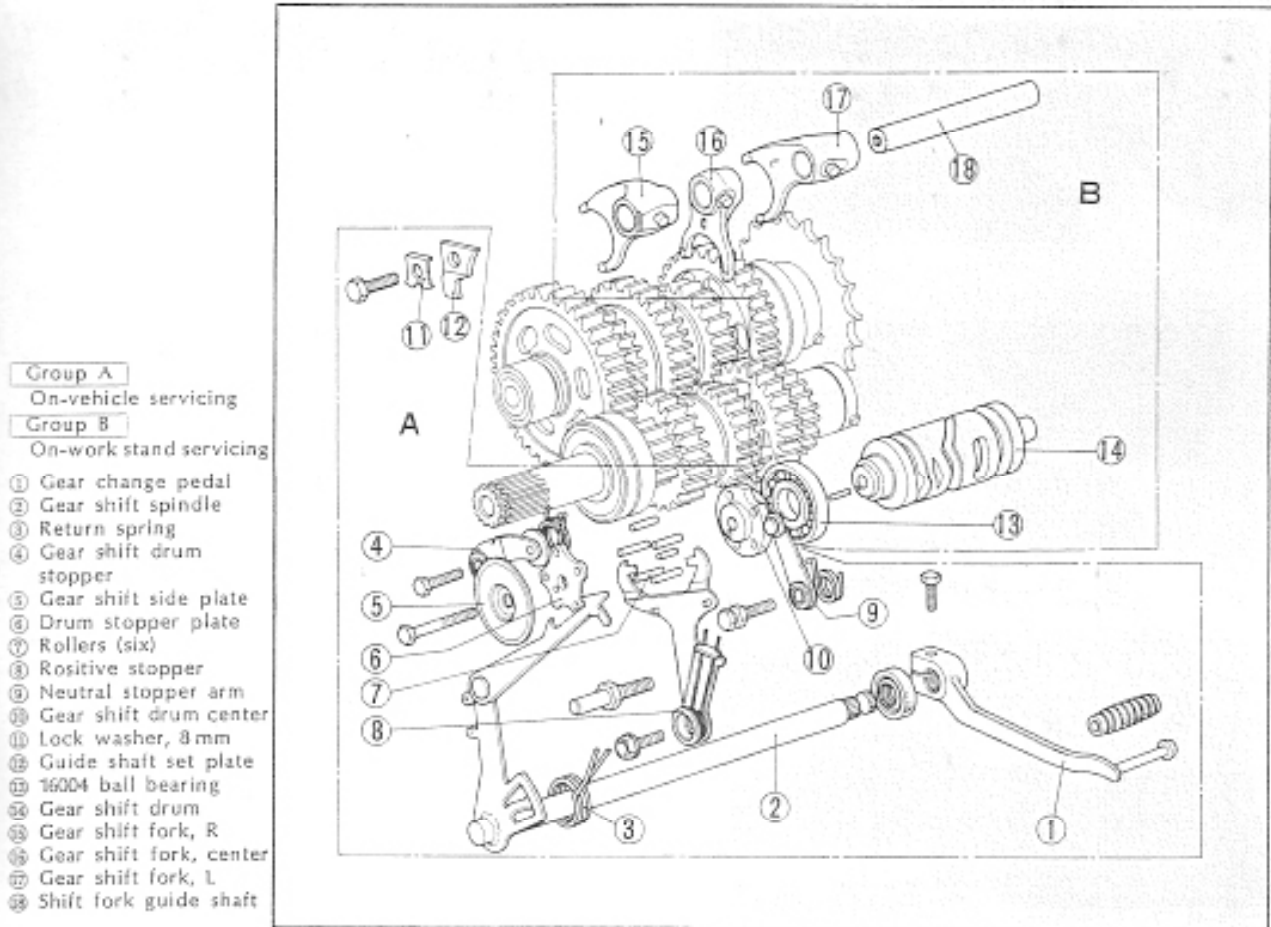
Inspection

1. Check the starter drive ratchet for smooth and proper operation.
2. Check the kick starter pinion-to-kick starter spindle clearance.

Reassembly

1. Insert the hair pin section of the starter pinion friction spring into the crankcase stopper groove in place.
2. Hook the end ④ of the kick starter spring as shown, and install the kick starter assembly. Install the other end ⑩ of the spring to the crankcase rib as shown.
3. Check to be sure the starter pinion gear is properly meshed with the low gear.

7. GEAR SHIFT MECHANISM



Disassembly

Group A

1. Drain oil from the crankcase.
2. Remove the R. foot rest and kick starter pedal.
3. Remove the gear change pedal.
4. Remove the R. crankcase cover.
5. Remove the gear shift spindle.
6. Disassemble the positive stopper, gear shift drum stopper and neutral stopper arm. Fig. 3-41 indicates the transmission gears in neutral.

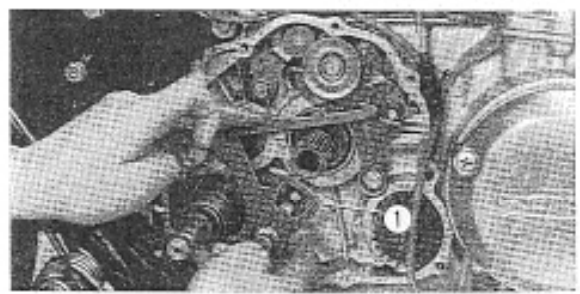


Fig. 3-40 ① Gear shift spindle

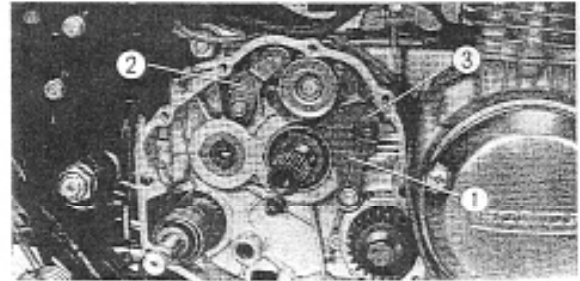


Fig. 3-41 ① Positive stopper
② Gear shift drum stopper
③ Neutral stopper arm

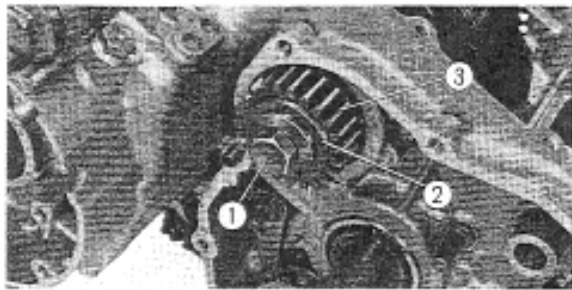


Fig. 3-42 ① 12 mm bolt
② Primary shaft lock washer
③ Secondary drive gear

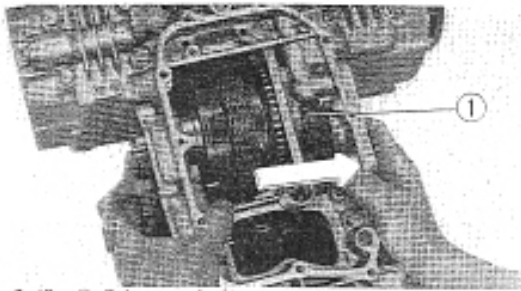


Fig. 3-43 ① Primary shaft

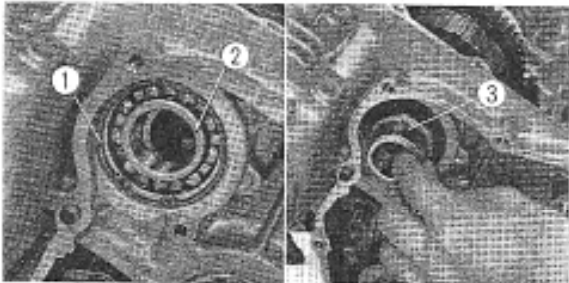


Fig. 3-44 ① 52 mm internal circlip
② 6205 ball bearing
③ 25 mm collar



Fig. 3-45 ① Main shaft
② Countershaft

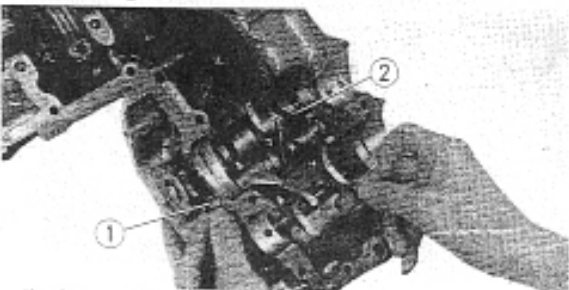


Fig. 3-46 ① Shift fork guide shaft
② Gear shift drum

7. Remove the contact breaker base and spark advancer.
8. Remove the oil pump.
9. Remove the secondary drive gear from the primary shaft by removing the 12 mm bolt.

Group B

1. Dismount the engine from the machine and follow the steps 1 thru 9 above.
2. Pull out the primary shaft to the right.
3. Remove the 52 mm internal circlip, and disassemble the 6205 ball bearing and 25mm collar.
4. Loosen the bolts securing the upper and lower crankcases to remove the lower crankcase.
5. Remove the transmission main shaft and the countershaft at the same time.
6. Remove the gear shift set plate, and pull out the shift fork guide shaft and gear shift drum.

Inspection

1. Measure the width of the gear shift fork finger.
2. Measure the outside diameter of the shift fork guide shaft.
3. Measure the inside diameter of the gear shift fork.
4. Check the gear shift fork guide-to-gear shift drum groove clearance.

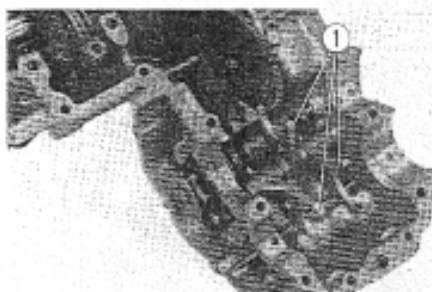


Fig. 3-47 ① Gear shift forks

Reassembly

1. Install the gear shift drum and gears in the neutral position.
2. Install the guide set plate, and bend the lug of the lock washer against the flat of the 8mm bolt.
3. Install the gear shift forks properly in their respective positions. They are provided with the marks "R", "C" and "L" for identification.
4. Check the gear shift drum stopper, neutral stopper arm and positive stopper are in their proper respective positions, and also check them for operation.
5. Move the gear shift spindle to check each related part for smooth operation.
6. Refer to pages 26~27 for the installation of the transmission.
7. Refer to page 34 for the installation of the upper and lower crankcases.

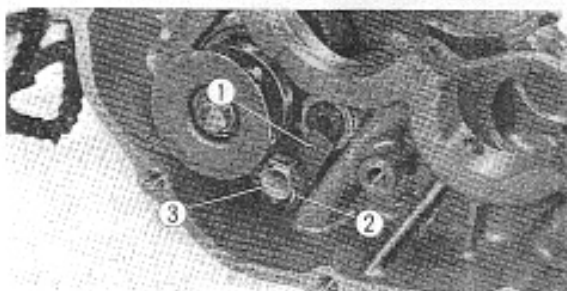


Fig. 3-48 ① Guide set plate
② Lock washer
③ 8 mm bolt

MEMO

8. TRANSMISSION

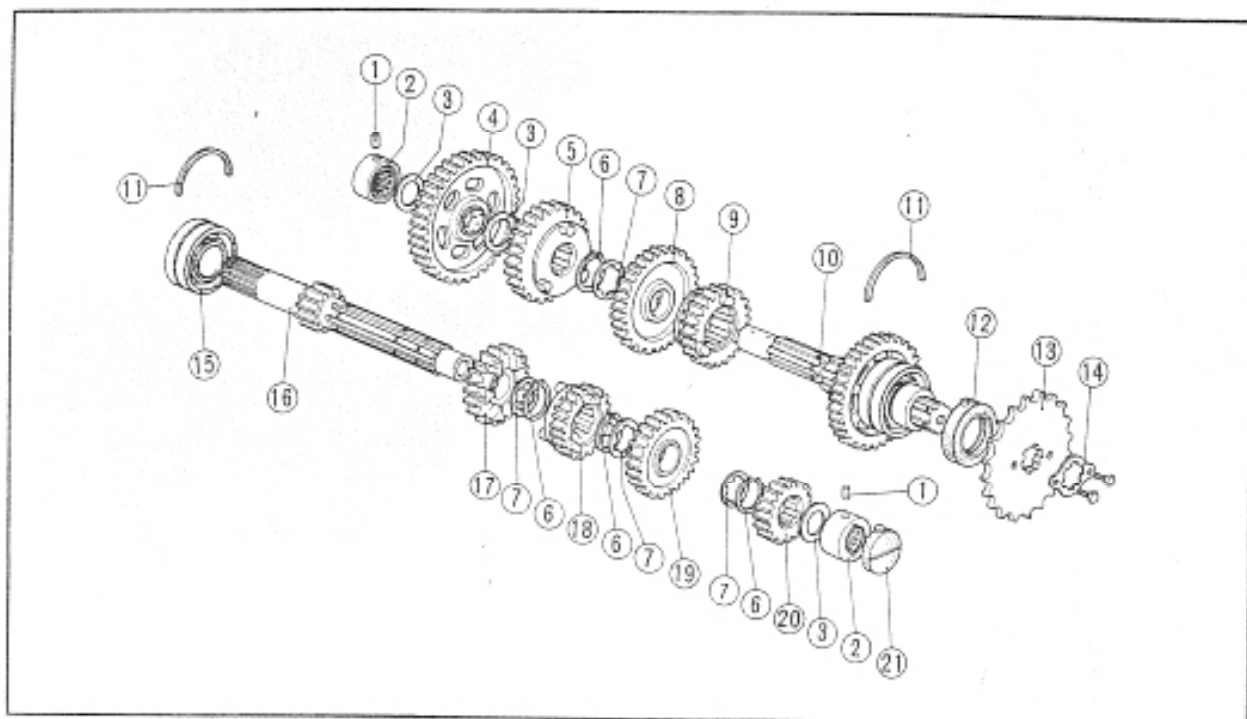


Fig. 3-49

- | | | |
|--|----------------------------------|-------------------------------|
| ① Gear shift fork guide pins (two), 6 mm | ⑥ Countershaft third gear, 34T | ⑬ Ball bearing, 5205 HS |
| ② Needle bearings (two), 20 mm | ⑦ Countershaft top gear, 28T | ⑭ Main shaft |
| ③ Thrust washers (three), 20 mm | ⑧ Countershaft, 37T | ⑮ Main shaft fourth gear, 27T |
| ④ Countershaft low gear, 41T | ⑨ Bearing set rings (two), 52 mm | ⑯ Main shaft third gear, 24T |
| ⑤ Countershaft fourth gear, 31T | ⑩ Oil seal | ⑰ Main shaft top gear, 29T |
| ⑥ Circlips (four), 25 mm | ⑪ Drive sprocket, 17T | ⑱ Main shaft second gear, 20T |
| ⑦ Thrust washers (four) | ⑫ Drive sprocket fixing plate | ⑲ Oil seal |

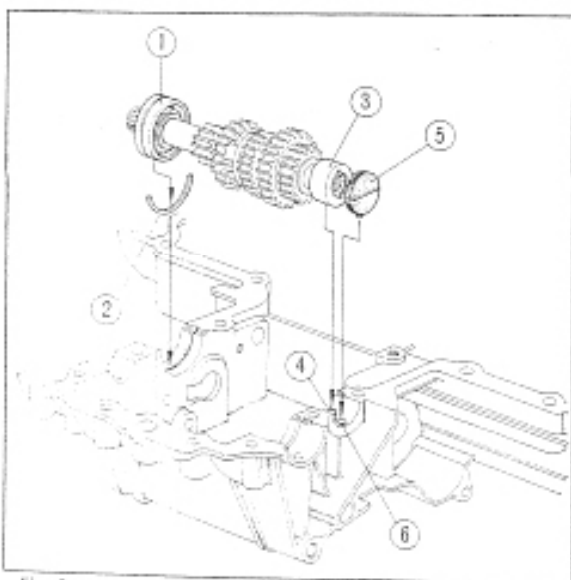


Fig. 3-50
 ① 5205 HS ball bearing
 ② 52 mm bearing set ring
 ③ 20 mm needle bearing
 ④ 6 mm guide pin
 ⑤ Oil seal
 ⑥ Pin hole

Disassembly

1. Remove the main shaft and countershaft from the upper crankcase. (See page 24)

Inspection

1. Check the gears for backlash.
2. Replace any gear if its lugs are excessively worn or damaged. Also check the gears for smooth sliding on the shaft splines.
3. Check each gear-to-its mounting shaft clearance.

Reassembly**Main Shaft**

1. Install the 5205 HS ball bearing with its groove fitted with the 52mm bearing set ring in place.
2. Install the 20mm needle bearing with its pin hole fitted with the 6mm guide pin.
3. Install the oil seal with its dowel fitted into the pin hole in the upper crankcase.

Countershaft

1. Install the 20mm needle bearing with its pin hole fitted with the 6mm guide pin in the upper crankcase.
2. Install the 5205 ball bearing with its ring groove fitted with 50mm bearing set ring installed in the upper crankcase.
3. Install the oil seal with its dowel fitted into the pin hole in the upper crankcase.

Rotate the crankshaft to check each gear for smooth moving.

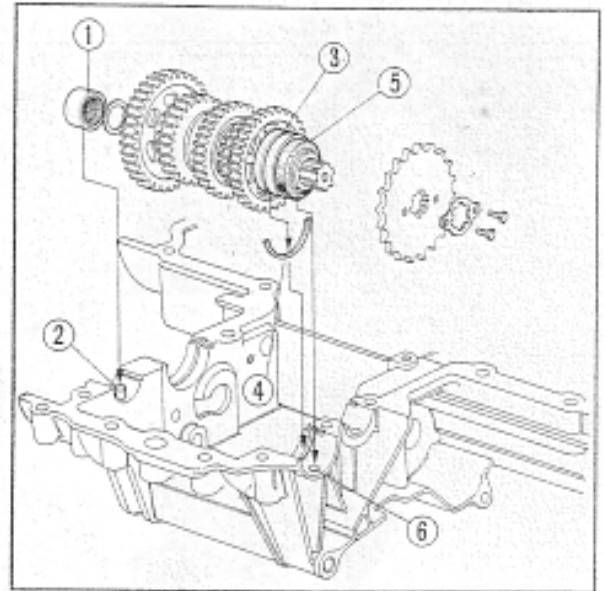


Fig. 3-51 ① 20 mm needle bearing
 ② 6 mm guide pin
 ③ 5205 ball bearing
 ④ 50 mm bearing set ring
 ⑤ Oil seal
 ⑥ Pin hole

MEMO

9. PRIMARY SHAFT

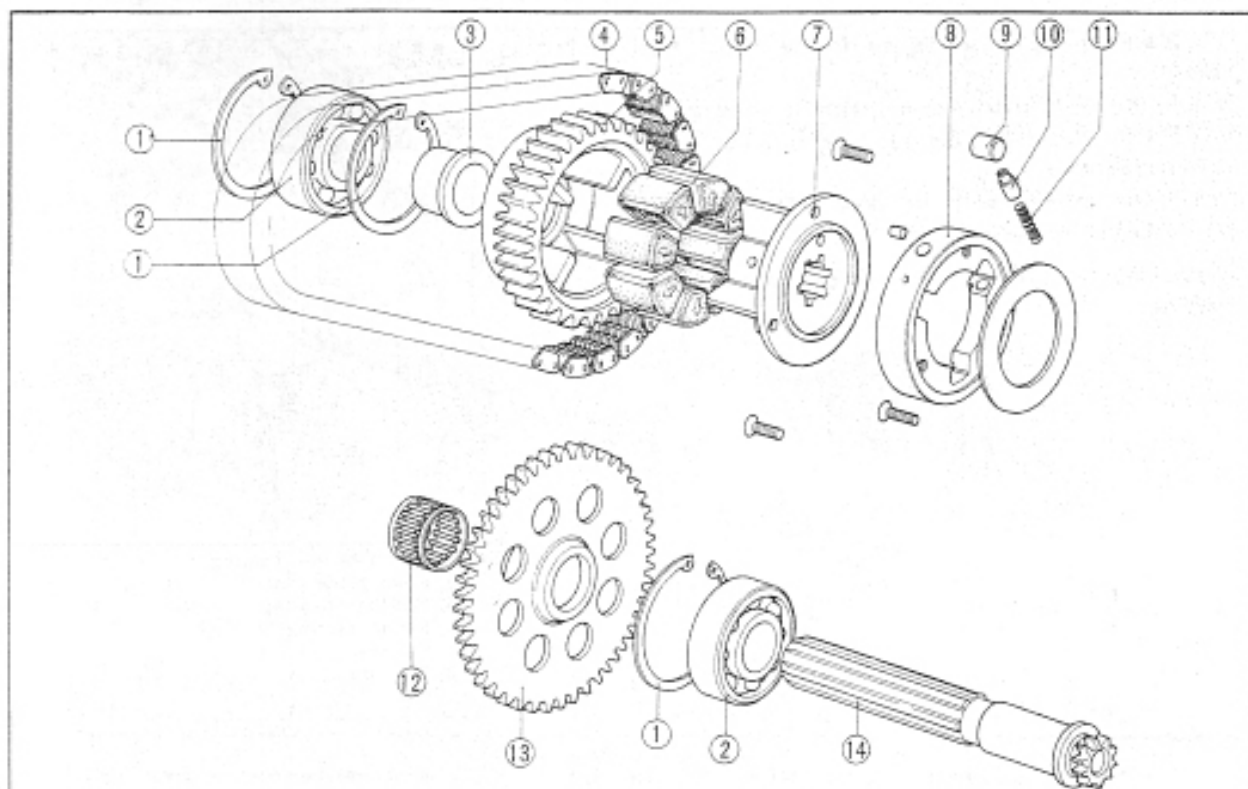


Fig. 3-52

- ① Internal circlips (three), 52 mm
- ② Ball bearings (two), 6205
- ③ Collar, 25×21.8
- ④ Primary drive chain
- ⑤ Primary driven sprocket

- ⑥ Rubber dampers (eight)
- ⑦ Driven sprocket hub
- ⑧ Clutch outer
- ⑨ Rollers (three), 10.2×9.5
- ⑩ Caps (three)

- ⑪ Springs (three)
- ⑫ Needle bearing
- ⑬ Starter driven gear
- ⑭ Primary shaft

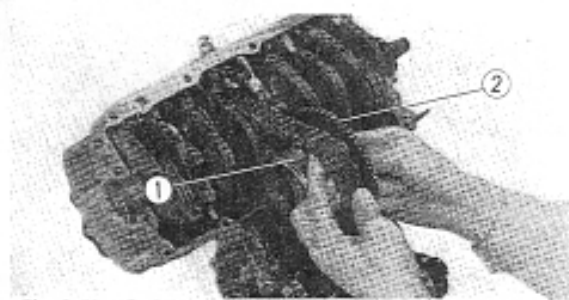


Fig. 3-53 ① Primary driven sprocket
② Starter driven gear



Fig. 3-54 ① Primary driven sprocket
② Driven sprocket hub

Disassembly

1. Pull out the primary shaft. (See page 24)
2. Remove the primary driven sprocket and starter driven gear.
3. Remove the driven sprocket hub from the primary driven sprocket.
4. Remove the rubber dampers.

Inspection

1. Check the starting clutch and its related parts for wear or any other damage. Also check the rollers for smooth rolling.
2. Check the starter driven gear needle bearing for any damage.

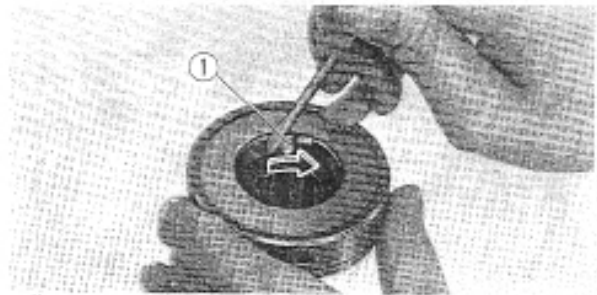


Fig. 3-55 ① Starting clutch roller

Reassembly

1. When the clutch outer body has been disassembled, tighten three 6 mm flat screws to secure the driven sprocket hub to clutch outer body, and stake each screw head in two positions as shown.

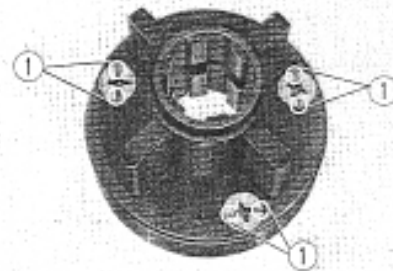
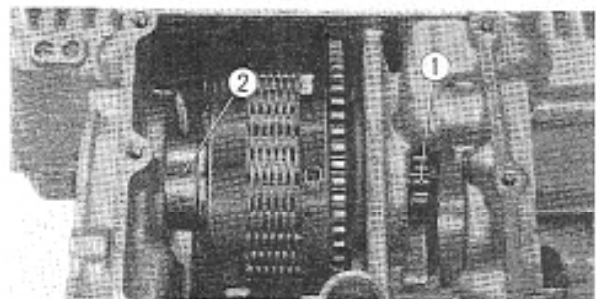


Fig. 3-56 ① Stake

2. After assembling the upper and lower crankcases insert the primary shaft into the crankcase from right side, and install the collar.

Fig. 3-57 ① Primary shaft
② 25 mm collar

3. Drive the 6205 ball bearing into the primary shaft, and secure with the 25 mm internal circlip.
4. Tighten the crankcases with securing bolts. (See page 34)

Fig. 3-58 ① 6205 ball bearing
② 52 mm internal circlip

5. Install the primary shaft lock washer with the mark "OUTSIDE" facing outward.

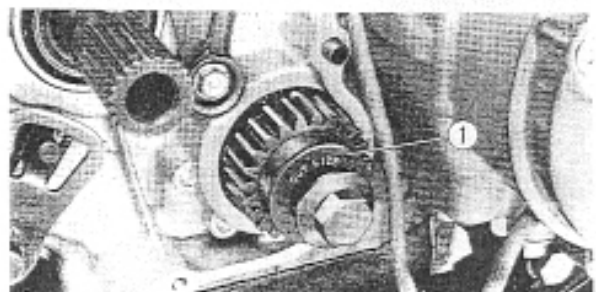


Fig. 3-59 ① Lock washer

10. CAM CHAIN TENSIONER

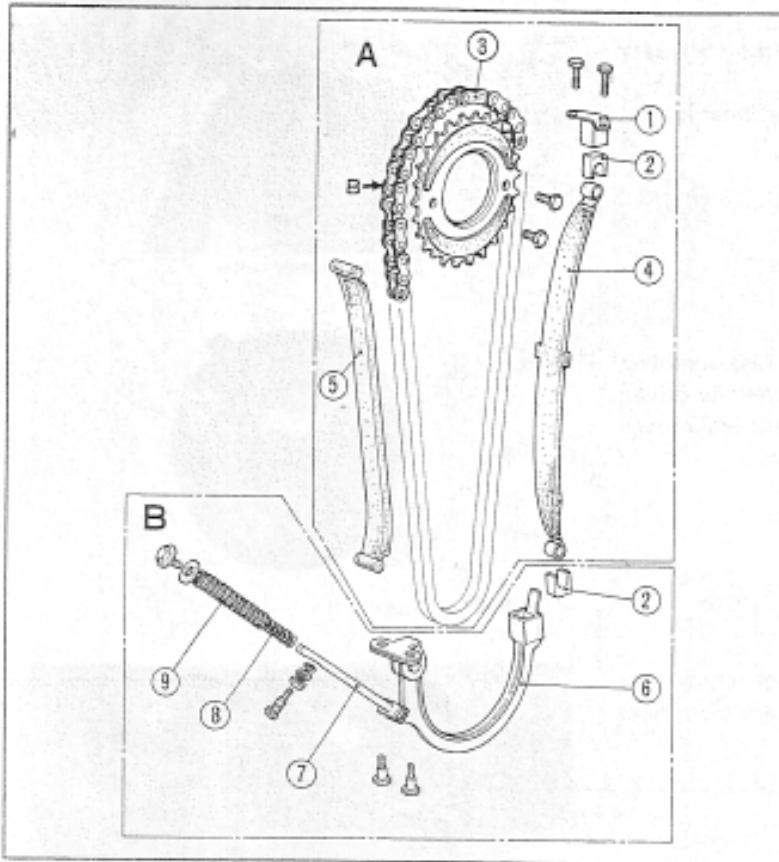


Fig. 3-60

- Group A On-vehicle servicing
Group B On-work stand servicing
- ① Cam chain tensioner holder
 - ② Tensioner dampers (two)
 - ③ Cam chain
 - ④ Tensioner slipper
 - ⑤ Cam chain guide
 - ⑥ Cam chain tensioner arm
 - ⑦ Push bar
 - ⑧ Tensioner inner spring
 - ⑨ Tensioner outer spring

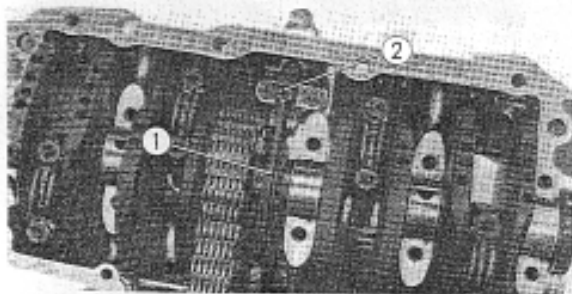


Fig. 3-61 ① Tensioner arm
② Push bar

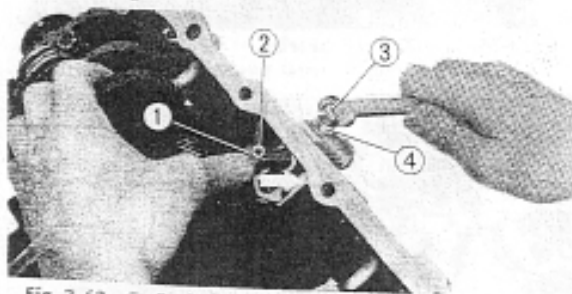


Fig. 3-62 ① Push bar
② Mark
③ Tensioner adjusting bolt
④ Lock nut

Disassembly**Group A**

1. Remove the cam chain guide and tensioner slipper. (See pages 12-14)

Group B

1. Remove the lower crankcase. (See pages 23-24)
2. Remove the tensioner arm and tensioner push bar.

Inspection

1. Check the cam chain guide and tensioner slipper for wear.

Reassembly

1. Install the tensioner push bar with the mark facing upward as shown. Then finger-depress the push bar and secure it with tensioner adjusting bolt and lock nut.

11. CRANKSHAFT AND CONNECTING RODS

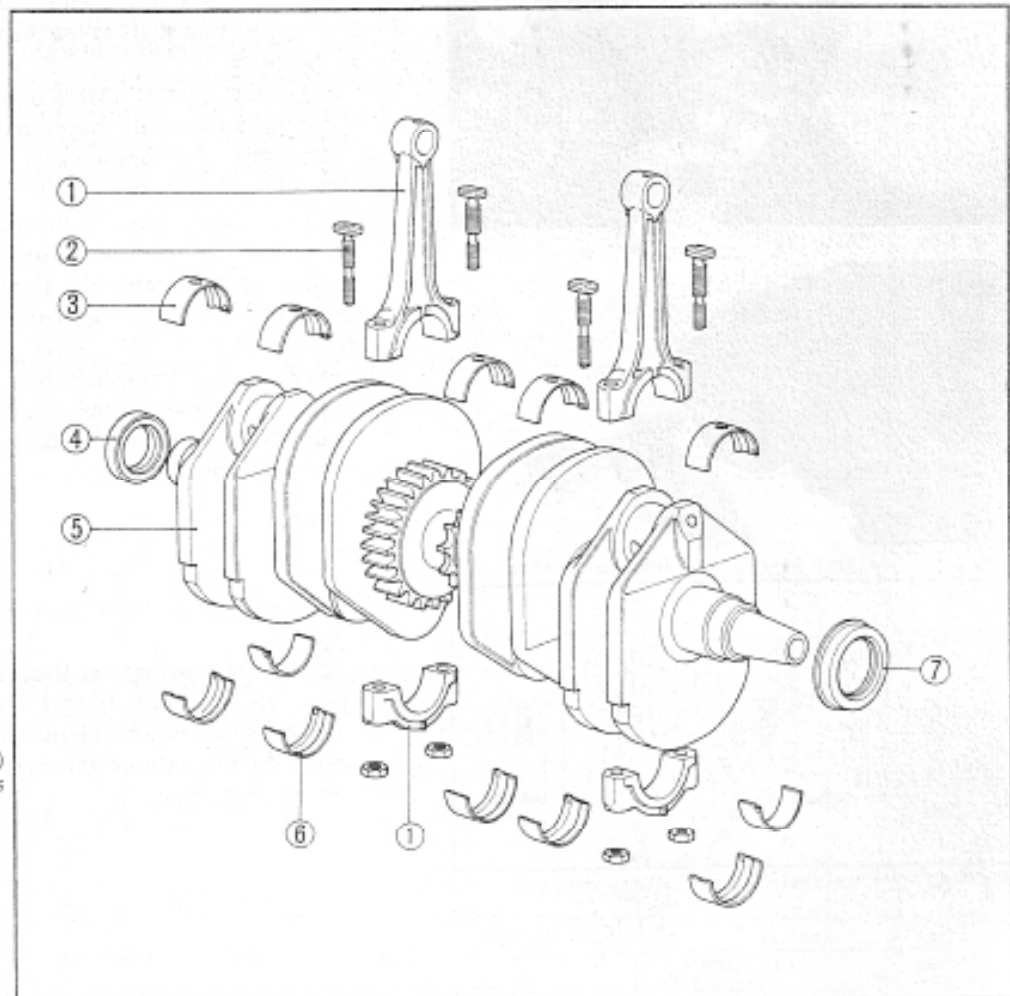


Fig. 3-63

- ① Connecting rods (four)
- ② Connecting rod bolts (eight)
- ③ Crankshaft bearings (ten)
- ④ Oil seal, 30×42×8
- ⑤ Crankshaft
- ⑥ Connecting rod bearings (eight)
- ⑦ Oil seal, 30×45×8

Disassembly

1. Remove the cylinder head, cylinder and pistons. (See pages 12-14)
2. Pull out the A-C generator rotor using rotor remover. (Tool No. 07011-33301)
3. Separate the lower crankcase from the upper one. (See pages 23-24)
4. Remove the cam chain tensioner arm. (See page 30)
5. Remove the crankshaft.

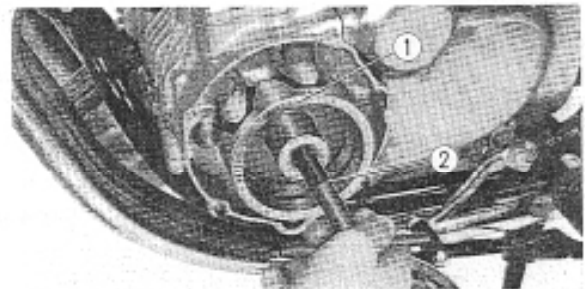
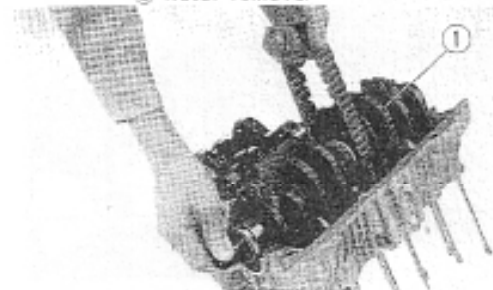
Fig. 3-64 ① A-C generator rotor
② Rotor remover

Fig. 3-65 ① Crankshaft

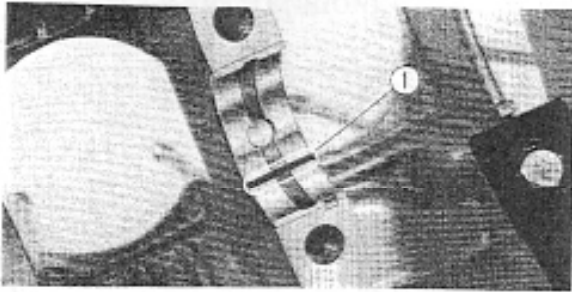


Fig. 3-66 ① Plastigauge

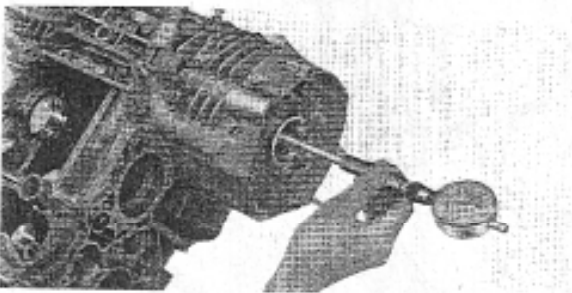


Fig. 3-67 Checking bearing seat inside diameter

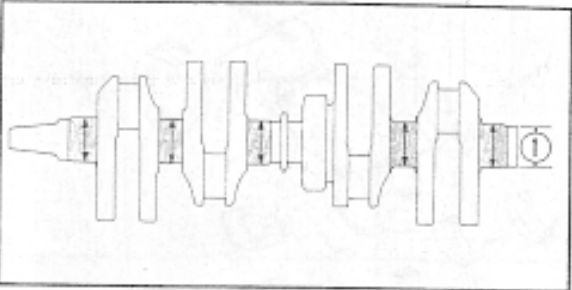


Fig. 3-68 ① Crankshaft journal outside diameter

Unit: mm (in.)

Crankcase bearing I. D. \ Crankshaft journal O. D.	31.99-32.00 (1.2594-1.2598)	31.98-31.99 (1.2590-1.2594)	31.97-31.98 (1.2586-1.2590)
35.000-35.008 (1.3780-1.3783)	D (yellow)	C (green)	B (brown)
35.008-35.016 (1.3783-1.3786)	C (green)	B (brown)	A (black)
35.016-35.024 (1.3786-1.3789)	B (brown)	A (black)	AA (blue)

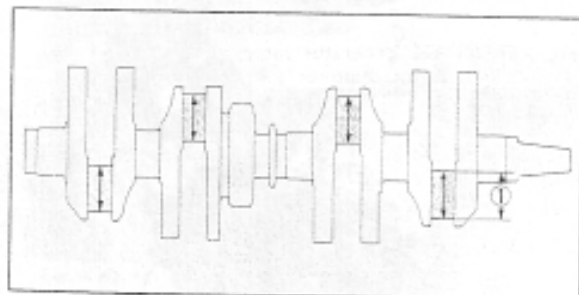


Fig. 3-69 ① Crankshaft pin outside diameter

Inspection

1. Check the crankshaft center journal for runout.
2. Check the crankshaft-to-crankshaft bearing clearance as follows:
 - 1) Place a piece of plastigauge on the bearing as shown, and install the crankshaft on it.
 - 2) Assemble the upper and lower crankcases by torquing the securing bolts to the specification.
 - 3) Remove the upper crankcase and measure the clearance by the plastigauge. If beyond specified limit, replace crankshaft bearing with a new one.
3. Select the crankshaft bearings in a selective set as follow:
 - 1) Remove the crankshaft bearings and tighten the upper and lower crankcases to the specified torque. Check the inside diameter of each bearing seat as shown.
 - 2) Measure the outside diameter of the crankshaft journals.
 - 3) Select out bearings on the basis of the readings taken in the steps 1) and 2) above. The bearings may be identified by a daub of color print on the side or the mark (alphabet) stamped on the rear side.

4. Measure the inside diameter of the connecting rod small end.
5. Check the side clearance of the connecting rod big end.
6. Check the connecting rod big end-to-crankshaft journal clearance as follows:
 - 1) Remove the connecting rod bearing cap and place a piece of a plastigauge on the bearing surface. Torque the bearing cap bolts to specification.
 - 2) Remove the cap and measure the clearance by the plastigauge. If beyond the specified limit, replace bearing with a new one.

7. Select the connecting rod bearings in a selective set as follows:
 - 1) Measure the outside diameter of the crankshaft pin.
 - 2) Check to make sure the code number (1, 2 and 3) stamped on the connecting rod big end side is properly matched as shown.
 - 3) After following the steps 1) and 2) above, select out the bearings referring to the identification table below.

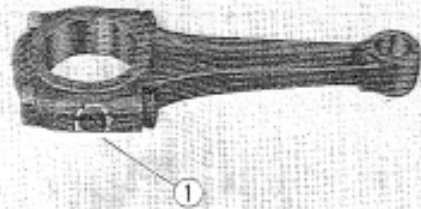


Fig. 3-70 ① Code No.

Unit: mm (in.)

Crankshaft pin O. D. Connecting rod code no.	31.99-32.00 (1.594-1.2598)	31.98-31.99 (1.2590-1.2594)	31.97-31.98 (1.2586-1.2590)
1	E (red)	D (yellow)	C (green)
2	D (yellow)	C (green)	B (brown)
3	C (green)	B (brown)	A (black)

NOTE:

The bearings must be installed with the tang facing toward the front (exhaust side).

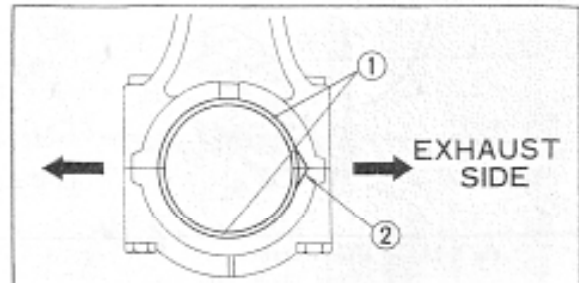


Fig. 3-71 ① Bearing ② Tang

8. Select the connecting rods

When replacing connecting rod with a new one, proceed matching the code mark (alphabet) stamped on the connecting rod big end side as shown.

NOTE:

The weight of the connecting rod does not include the weight of the bearings.

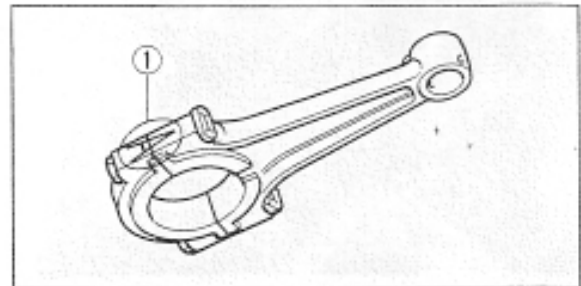


Fig. 3-72 ① Code mark

Reassembly

1. Apply a coat of liquid packing to the mating surfaces of the crankcases and install the bearings after the packing becomes dry.
2. Apply a coat of molybdenum disulfide compound or engine oil to the bearing surfaces.

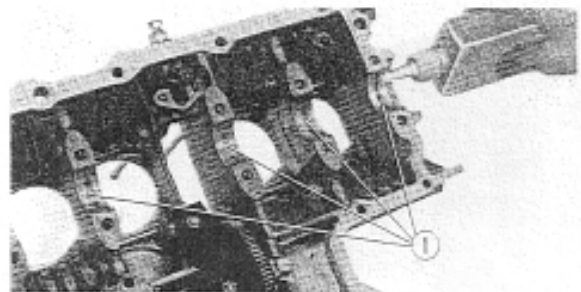


Fig. 3-73 ① Bearings

12. CRANKCASE

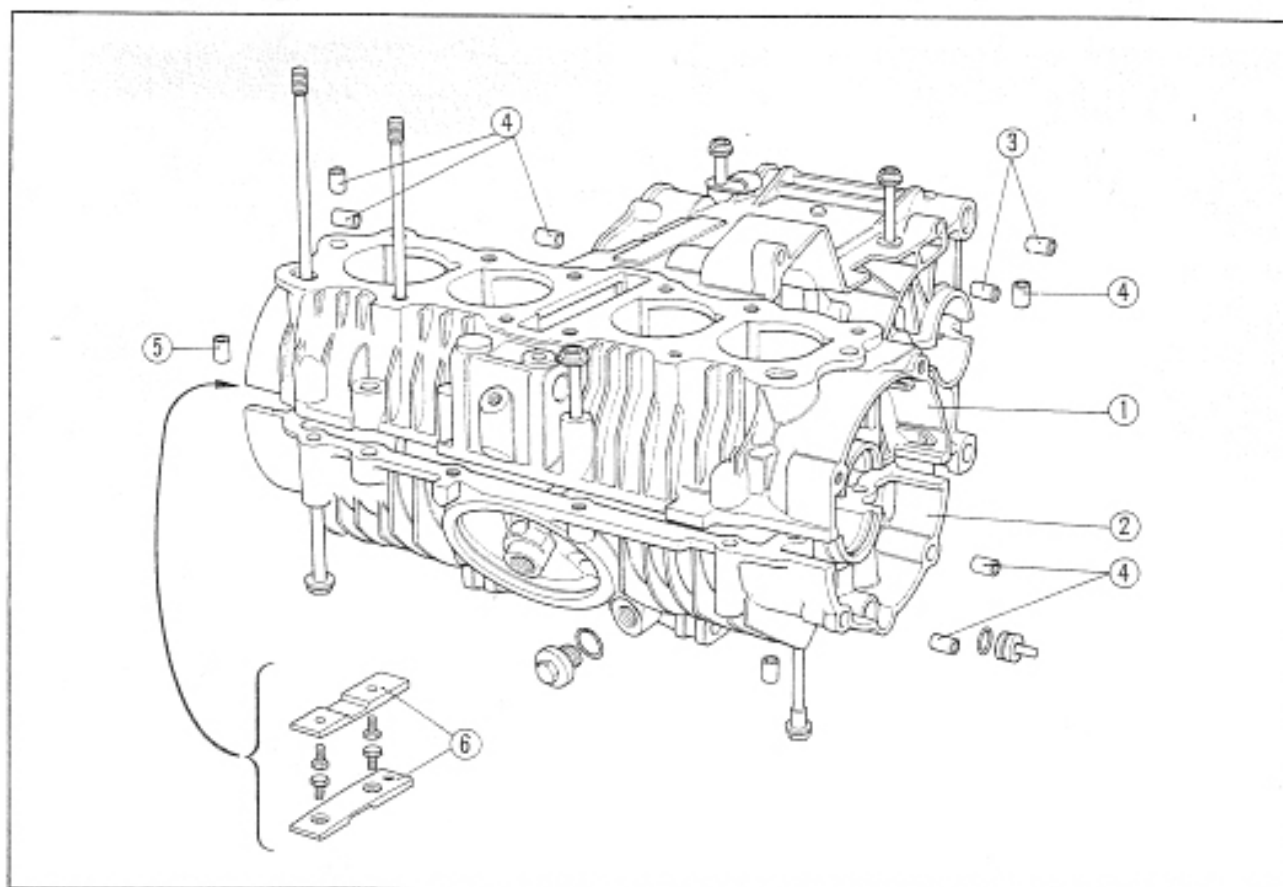


Fig. 3-74 ① Upper crankcase ③ Dowel pins (two), 8×10 ⑤ Dowel pins (two), 10×14
② Lower crankcase ④ Dowel pins (six), 8×14 ⑥ Primary chain guides (two)



Fig. 3-75 ① Primary chain guide
② Recessed mark

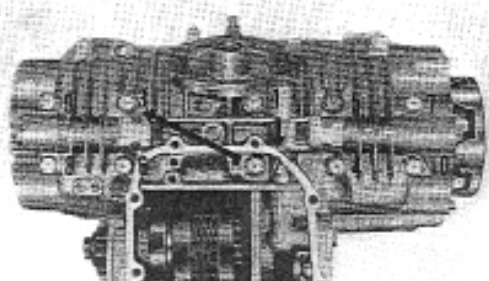


Fig. 3-76 Tightening sequence

Disassembly

1. Separate the upper and lower crankcases from each other. (See pages 23–24)

Inspection

1. Check the crankcase oil passage for clogging.
2. Check the primary chain guides for wear.

Reassembly

1. Install the primary chain guide with its recessed mark facing the transmission.
2. Apply a uniform coat of liquid packing to the crankcase mating surfaces.
3. Make sure all dowel pins are properly installed in their respective positions.
4. Tighten the ten UBS bolts on the crankcase in the sequence as shown in Fig. 3-76.
5. Use each bolt in its proper position.

13. CARBURETOR

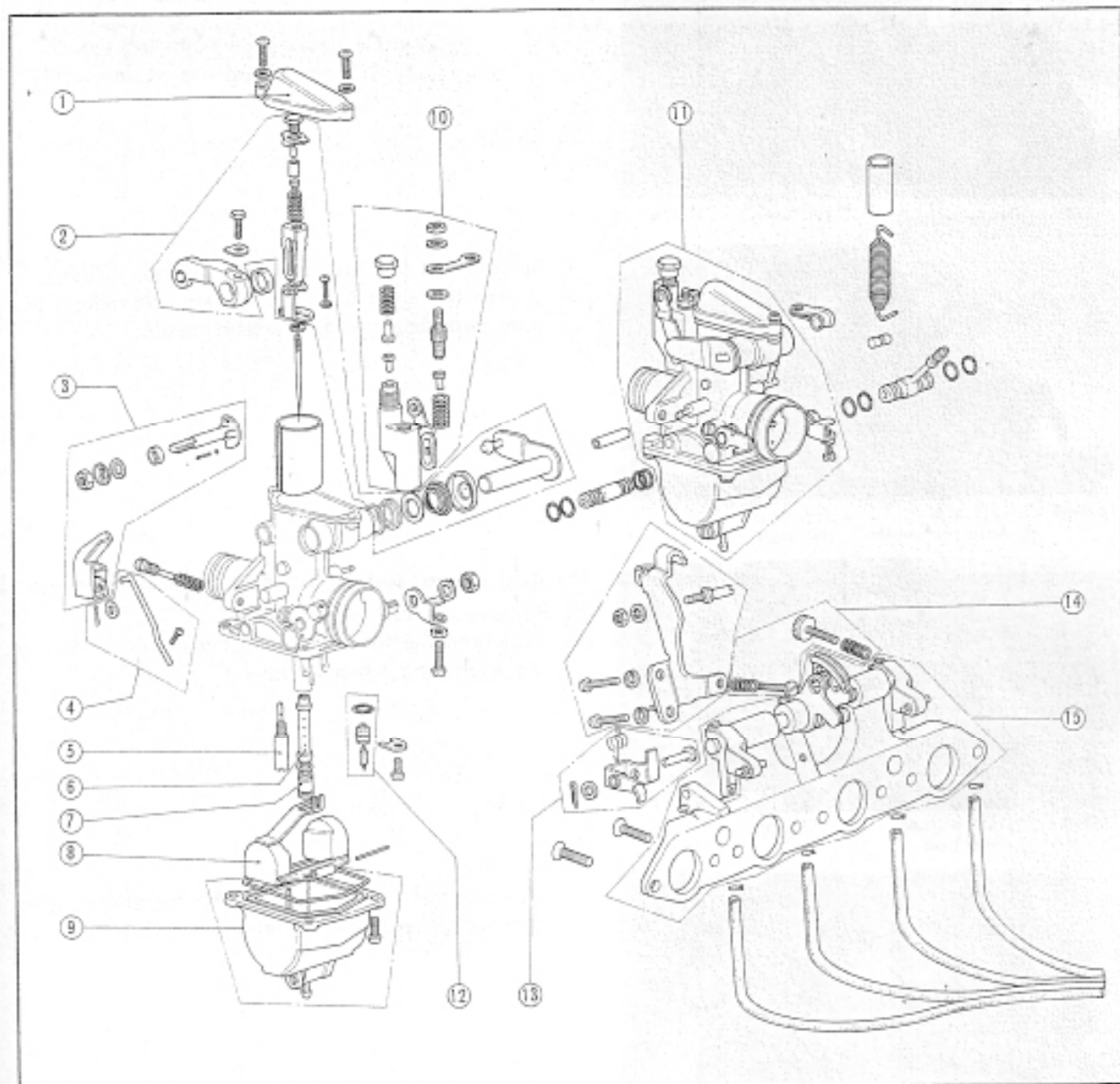


Fig. 3-77 ① Top set ⑤ Slow set ⑩ Float chamber set A ⑬ Link set
 ② Link arm set A ⑥ Jet needle set ⑪ Adjust holder set A ⑭ Screw set B
 ③ Link set ⑦ Main jet set ⑫ Carburetor assembly ⑮ Stay plate set
 ④ Choke rod set ⑧ Float set ⑬ Float valve set

● Carburetor Component Parts

The carburetor component parts are available in a set as shown in Fig. 3-77. It is recommended that its respective parts be replaced as a set so as to maintain a satisfactory performance of the carburetor.

Disassembly

1. Remove the carburetor assembly from the machine. (See page 11)

Stay plate and carburetor body

2. Remove the throttle return spring from the link lever.

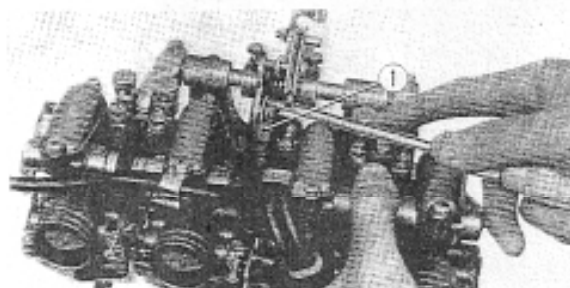


Fig. 3-78 ① Throttle return spring

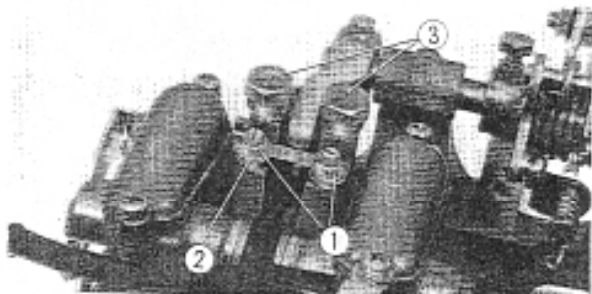


Fig. 3-79 ① Hex. nuts ③ Cap nuts
② Dust plate B

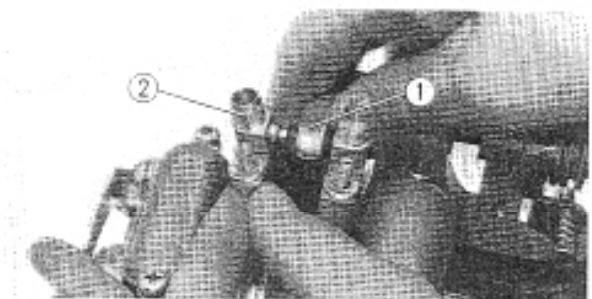


Fig. 3-80 ① Link arm
② Adjuster holder

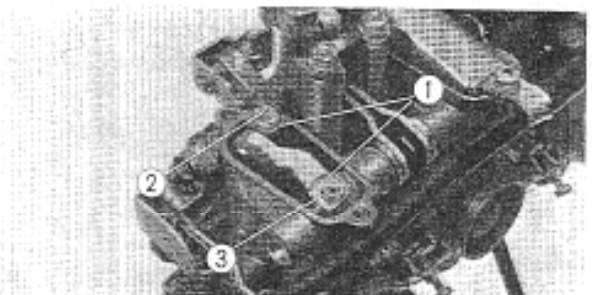


Fig. 3-81 ① Lock washers ③ 6 mm bolt
② 4 mm bolt

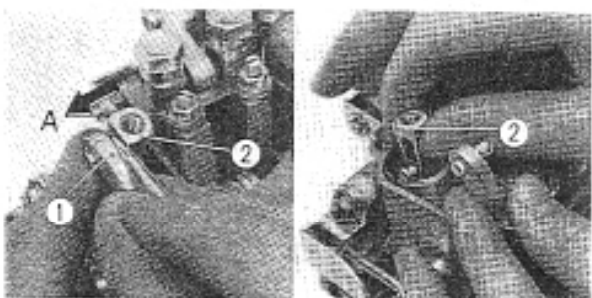


Fig. 3-82 ① Link arm ② Throttle shaft

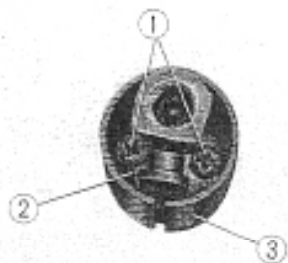


Fig. 3-83 ① 3 mm screws ③ Throttle valve
② Valve plate

3. Remove the dust plate B by loosening hex. nuts, and loosen the cap nuts.

4. Remove the link arm from the adjuster holders.
5. Loosen the eight 6 mm flat screws and remove the four carburetors from the stay plate.

Throttle valves and jet needles

6. Remove the carburetor top.
7. Straighten the lugs of the lock washers to remove the 4 mm and 6 mm bolts.

8. Pry out the link arm from the throttle shaft in direction A with a screwdriver.

9. Loosen the two 3 mm screws and remove the valve plate from the throttle valve by turning the plate 90°.
10. Remove the jet needle from the throttle valve.

Adjuster holders

1. Remove the carburetor from the plate. (Refer to the steps 1 through 5.)
2. Remove the adjusting screw from the adjuster holder. Then remove the holder from the lever.

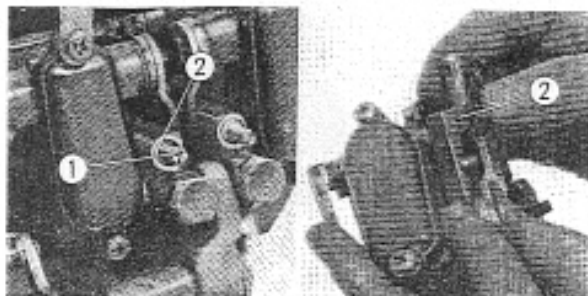


Fig. 3-84 ① Adjusting screw ② Adjuster holder

Float, main jet and slow jet

1. Remove the float chamber.
2. Remove the leaf spring, main jet and slow jet.

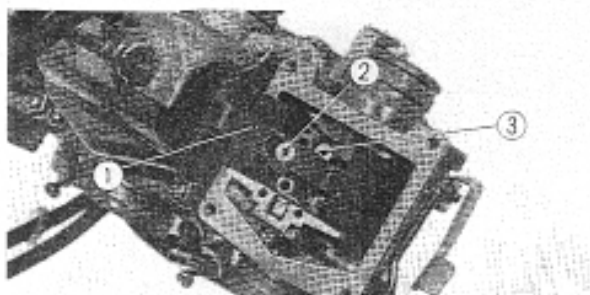


Fig. 3-85 ① Leaf spring ② Main jet ③ Slow jet

3. Pull out the float arm pin and remove the float.

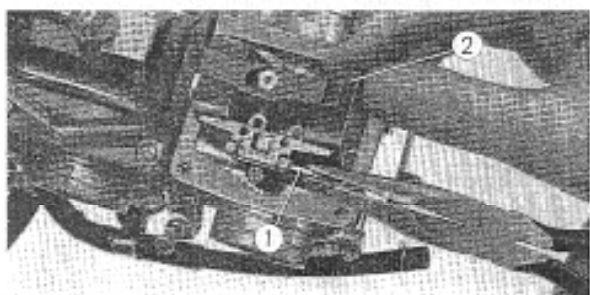


Fig. 3-86 ① Float arm pin ② Float

4. Remove the clip plate and remove the valve seat.

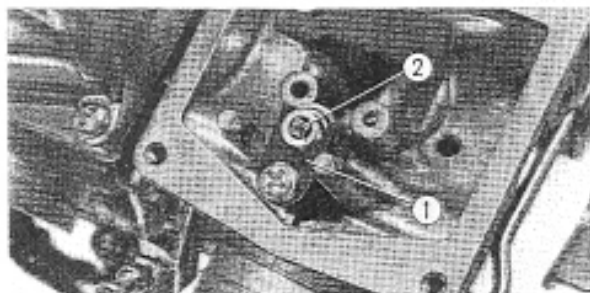


Fig. 3-87 ① Clip plate ② Valve seat

Inspection

1. Blow the main and slow jets to check them for clogging.
2. Adjusting fuel level

Move the float so that the float arm comes in a slight contact with the tip of the float valve, and check the height of the float with a float level gauge as shown. If out of specification, adjust by bending the float arm.

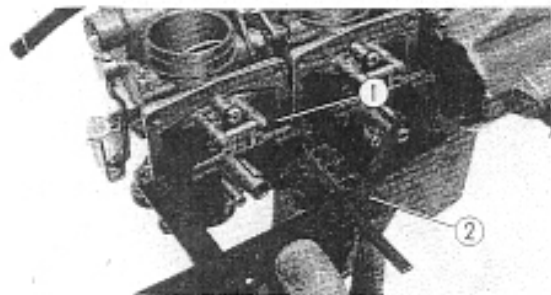


Fig. 3-88 ① Float ② Float level gauge

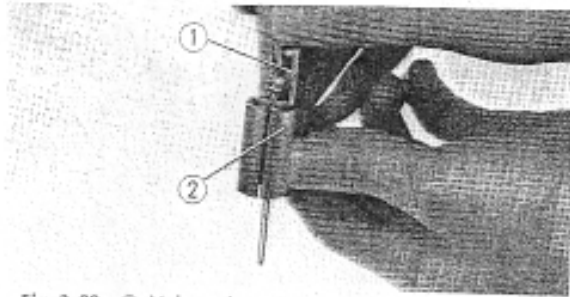


Fig. 3-89 ① Valve plate
② Throttle valve

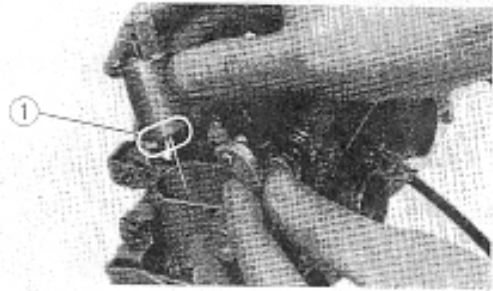


Fig. 3-90 ① Cutway part

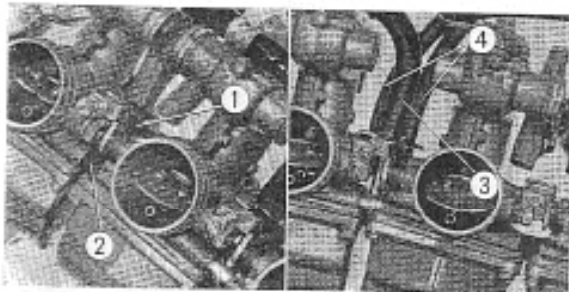


Fig. 3-91 ① Fuel tube (2.5×16) ③ Fuel tube
② Fuel joint ④ Fuel tube (3.5×600)

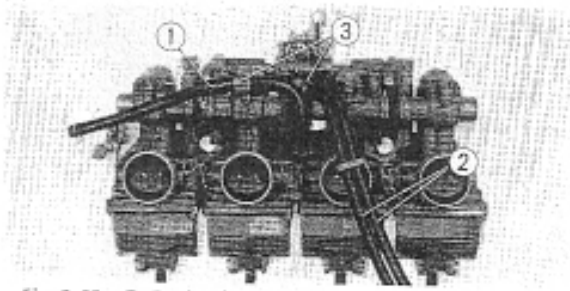


Fig. 3-92 ① Fuel tube ③ Clips
② Fuel tube (3.5×600)

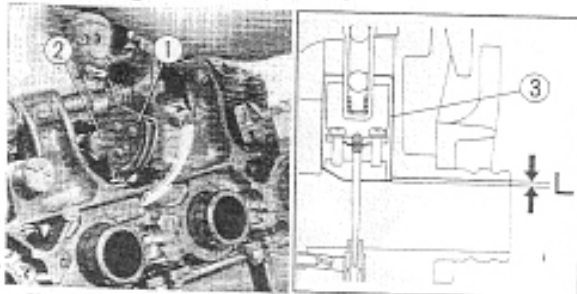


Fig. 3-93 ① Throttle lever ③ Throttle valve
② Adjusting screw

Reassembly

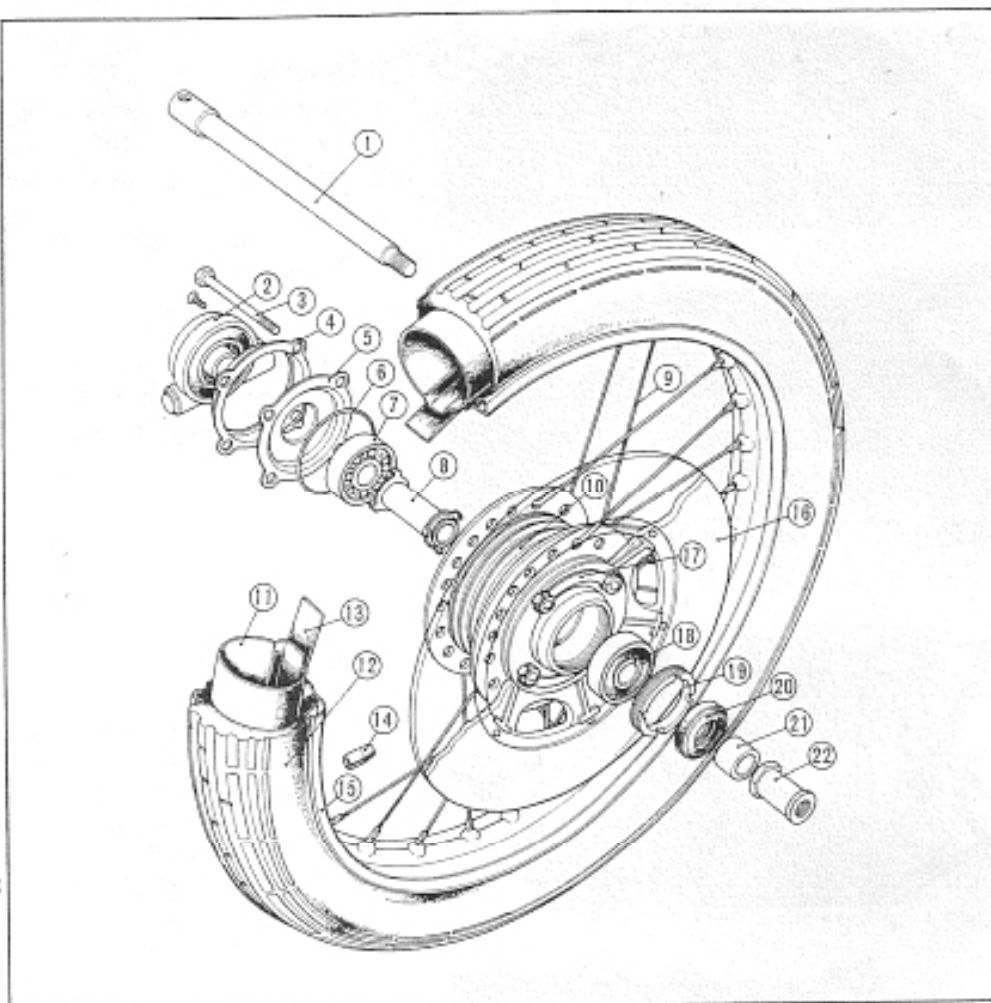
- Put the two 3 mm screws together with spring washers on the valve plate, and press the plate down in the throttle valve by aligning the protrusion of the valve plate with the slot of the throttle valve. Then turn the plate 90° toward the link arm side and tighten with the 3 mm screws.
- Install the throttle valve to the carburetor body by aligning the carburetor protrusion with the throttle valve slot. Check to make sure the cutaway part of the throttle valve is facing the choke valve side.
- Install the fuel tubes and fuel joint to the carburetor.
- Install and route each carburetor tube as shown in Fig. 3-92.
- Move the throttle lever until it contacts the adjusting screw, and check the throttle valve-to-throttle bore clearance (L). If out of specification (0~1.0 mm/0~0.04 in.), adjust the clearance by means of the adjusting screw.

IV. FRAME

1. FRONT WHEEL

Fig. 4-1

- ① Front wheel axle
- ② Speedometer gear box
- ③ Bolts (four) 8×90
- ④ Gear box retainer cover
- ⑤ Gear box retainer
- ⑥ Retainer O-ring
- ⑦ 6302U radial ball bearing
- ⑧ Front axle distance collar
- ⑨ Spokes (thirty-six)
- ⑩ Front wheel hub
- ⑪ Front wheel tube
- ⑫ Front wheel tire
- ⑬ Front tire flap
- ⑭ Wheel balance weight
- ⑮ Front wheel rim
- ⑯ Front brake disc
- ⑰ 8 mm lock washer (two)
- ⑱ 6302U radial ball bearing
- ⑲ Front wheel bearing retainer
- ⑳ Dust-seal 22×36×8
- ㉑ Wheel side collar
- ㉒ Front wheel axle nut



Disassembly

1. Using a jack under the engine, raise the front wheel off the ground.
2. Remove the speedometer cable.
3. Loosen the axle holder retaining nuts and remove the front forks wheel from the front forks.

NOTE:

Do not operate the front brake lever with the front wheel removed.

4. Loosen the front wheel axle nut and remove the front wheel axle.
5. Straighten the lugs of the lock washers and remove the front brake disc.
 - 1) When the brake disc has been removed, the gear box retainer cover can be removed as an assembly.

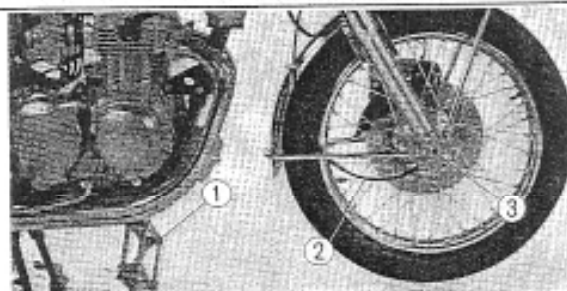


Fig. 4-2 ① Jack ② Speedometer cable

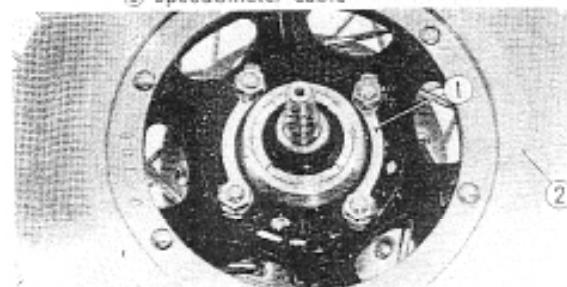


Fig. 4-3 ① Lock washer ② Brake disc

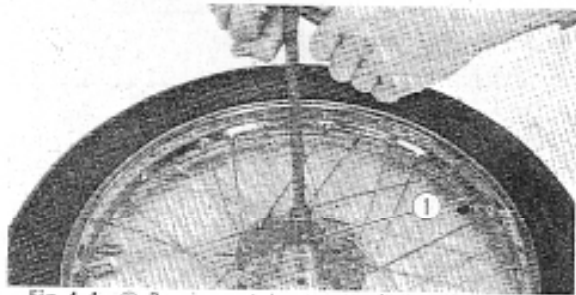


Fig. 4-4 ① Bearing retainer wrench

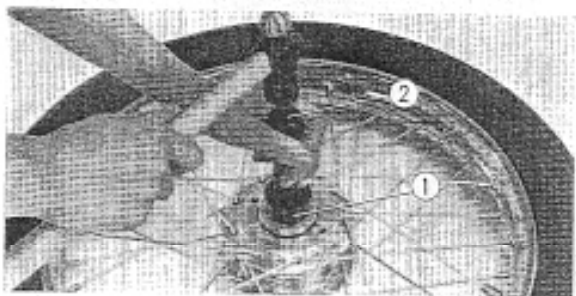
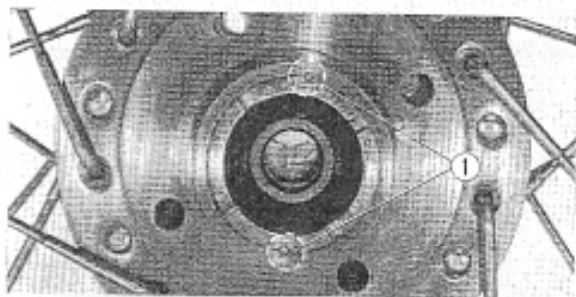
Fig. 4-5 ① Outer bearing driver attachment
② Driver handle

Fig. 4-6 ① Stake

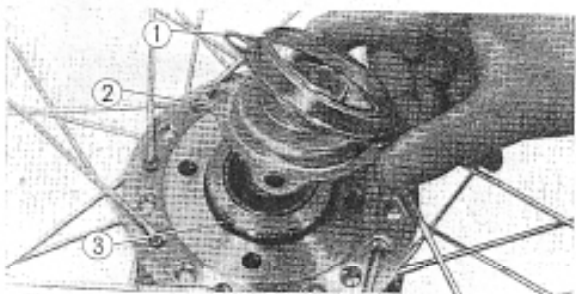
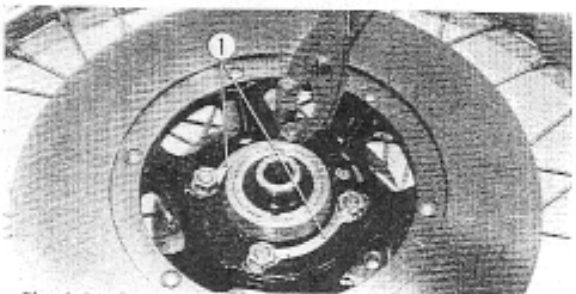
Fig. 4-7 ① Gear box retainer cover
② Gear box retainer
③ Retainer O-ring

Fig. 4-8 ① Lock washers

6. Remove the dust seal and remove the bearing retainer with bearing retainer wrench (Tool No. 07088-32301).

Inspection

1. Check the front axle for bend.
2. Check the front wheel rim for face runout.
3. Check the spokes for looseness, bend or any other damage.
4. Check the tire for cracks, excessive wear or any other damage.
5. Check the tube valve for air leaks.
6. Check the tire pressure.

Tire pressure specification: 1.8 kg/cm² (26 psi)

Reassembly

1. Fill the ball bearings and the front wheel hub with grease. Drive the bearings in the hub.
 - 1) Use the outer bearing driver attachment (Tool No. 07048-33301) and ball bearing driver handle (Tool No. 07048-61101) for the bearing installation.
 - 2) Be sure to install the distance collar.
2. Stake the bearing retainer at two places as shown.
3. Check the retainer O-ring is properly installed. Install the gear box retainer and retainer cover with the 8 mm bolts. Then put the brake disc on the opposite side of the wheel hub.

4. Install the brake disc to the wheel hub with the nuts.

NOTE:

Be sure to renew the lock washers. Bend the lugs of the washers properly after tightening the nuts.

5. Install the speedometer gear box in place to the gear box retainer.

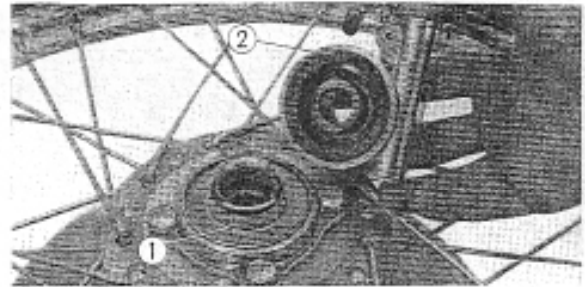


Fig. 4-9 ① Gear box retainer
② Speedometer gear box

6. Install the front wheel to the front forks.
Tighten the axle holder at the left side (brake disc side) first and then the one at the right side.
To prevent misalignment, tighten the front axle holder nut first, then tighten the rear nut until axle is clamped securely in place.

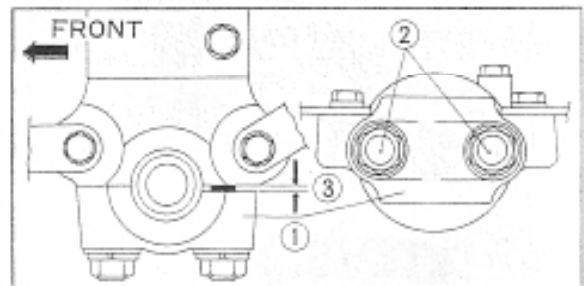


Fig. 4-10 ① Axle holder
② Axle holder nuts
③ Gap at rear

Wheel balancing

1. Jack up the machine to clear the wheel of the ground.
Mark the side off the tire and lightly spin the wheel several times.
2. If the mark comes to rest at the same point each time, it is an indication that wheel is out of balance.

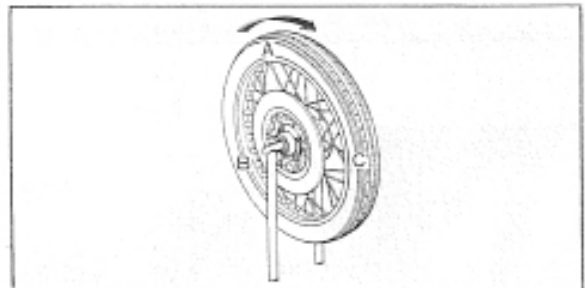


Fig. 4-11 Wheel balancing

3. Install a balance weight to the nipple end of the spoke at the top of the wheel directly opposite the heaviest point (the bottom of the wheel).
The balance weights are available in four different weights 5, 10, 15 and 20 gr.
4. Repeat the testing several times. If the wheel no longer stops at one place each time, it is completely balanced.
5. The wheel balancing should be made with the brake disc installed.

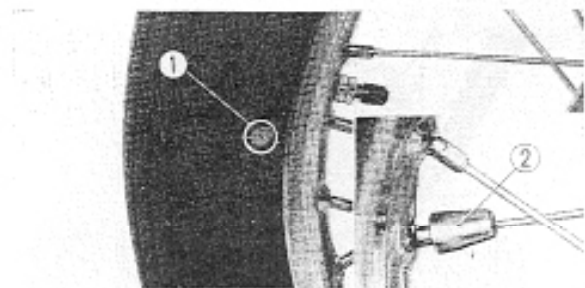


Fig. 4-12 ① Balance marking
② Balance weight

2. FRONT DISC BRAKE

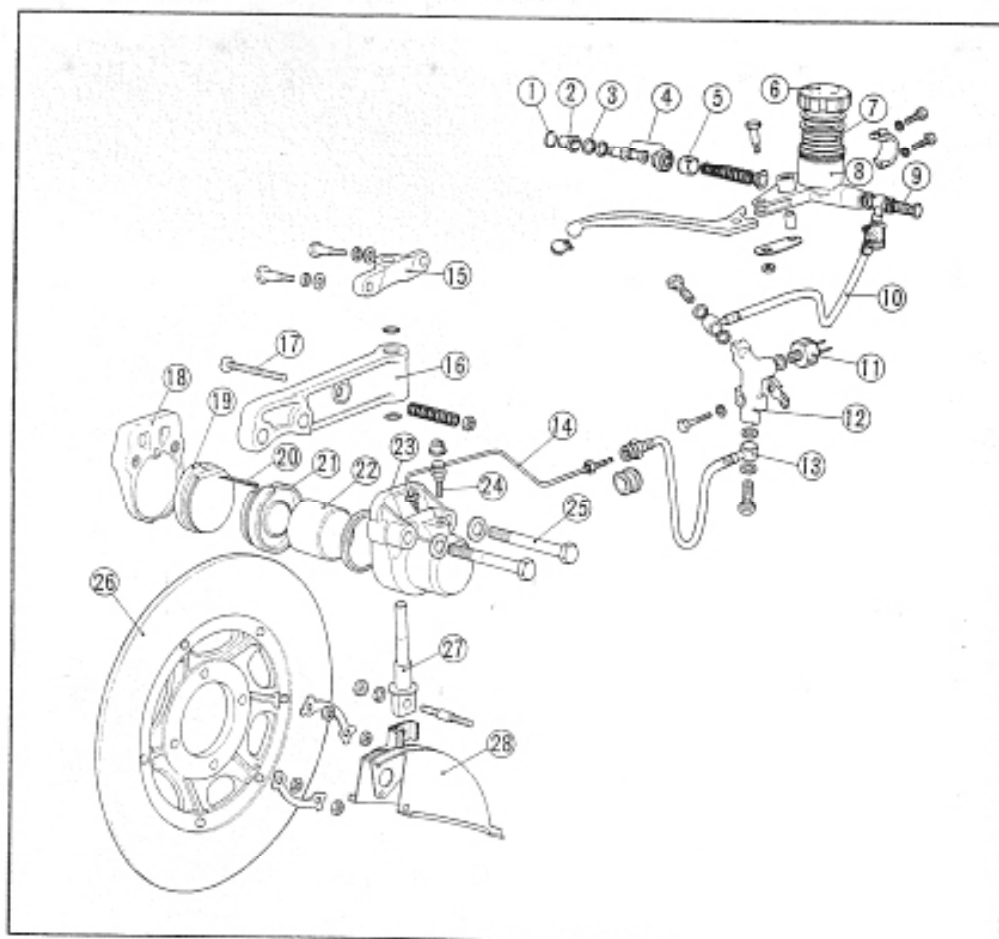


Fig. 4-13

- ① Boots stopper
- ② Boots
- ③ 18 mm internal circlip
- ④ Piston
- ⑤ Primary cup
- ⑥ Oil cup cap
- ⑦ Diaphragm
- ⑧ Master cylinder
- ⑨ Oil bolt
- ⑩ Front brake hose B
- ⑪ Stop switch
- ⑫ 3 way joint
- ⑬ Front brake hose A
- ⑭ Front brake pipe
- ⑮ Caliper holder joint
- ⑯ Caliper holder
- ⑰ Caliper adjust bolt
- ⑱ Caliper B
- ⑲ Pad B
- ⑳ Cotton pin 1.6×22
- ㉑ Pad A
- ㉒ Piston
- ㉓ Caliper A
- ㉔ Bleeder valve
- ㉕ Caliper securing bolts (two)
- ㉖ Front brake disc
- ㉗ Caliper holder
- ㉘ Disc cover

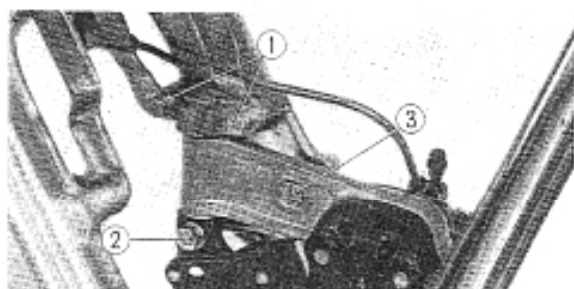


Fig. 4-14 ① 6 mm bolts ③ Caliper adjusting bolt
② 8 mm nut

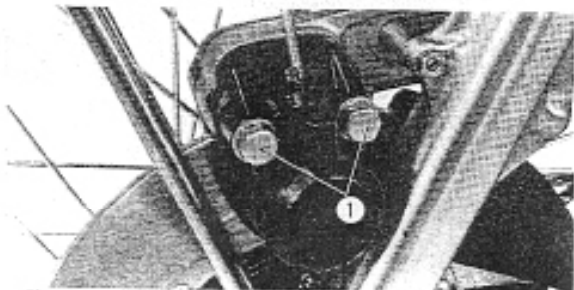


Fig. 4-15 ① Caliper securing bolts

Disassembly

Front brake disc

1. Drain the brake fluid.
2. Disconnect the front brake pipe from the caliper.
3. Remove the front fender.
4. Loosen the caliper adjusting bolt and 8 mm nut to remove the disc cover and caliper assembly.
5. Loosen the two caliper securing bolts to separate the calipers A and B.

6. Pull out the cotter pin or remove the pad B from the caliper B.

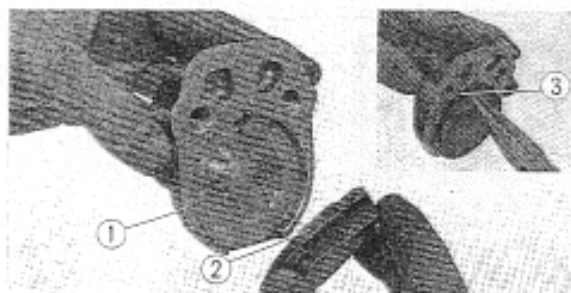


Fig. 4-16 ① Caliper B
② Pad B
③ Cotter pin

7. Remove the pad A from the caliper A by lightly tapping the head of the caliper.

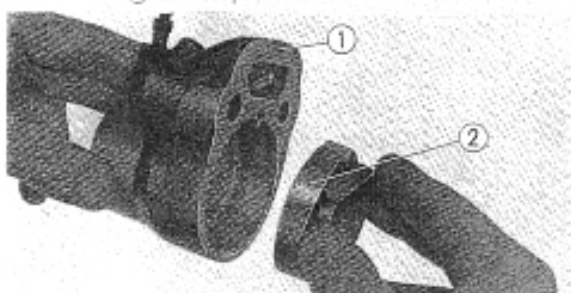


Fig. 4-17 ① Caliper A
② Pad A

Master cylinder

1. Remove the master cylinder.
 - 1) Remove the master cylinder boots and loosen the oil bolt.
 - 2) Loosen the hex. bolts to remove the master cylinder holder.
 - 3) Loosen the brake lever pivot bolt to remove the brake lever.
2. Remove the boot from the cylinder, taking care not to damage it. Remove the circlip using snap ring pliers (Tool No. 07073-32301).

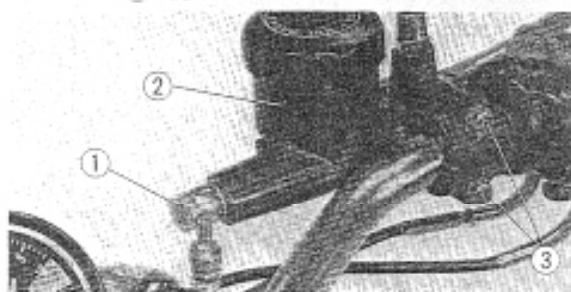


Fig. 4-18 ① Oil bolt
② Master cylinder
③ Hex. bolts



Fig. 4-19 ① Master cylinder
② Snap ring pliers

3. Remove the piston, primary cup, spring and check valve from the master cylinder in this order.

NOTE:

1. Apply air pressure of 2~3 kg/cm² (28~43 psi) to the brake hose joint to remove the primary cup.
2. Take care not to damage the check valve when removing it.

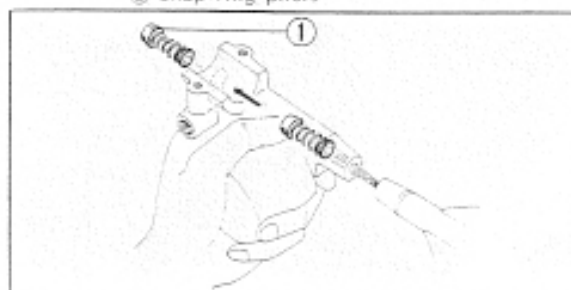


Fig. 4-20 ① Primary cup

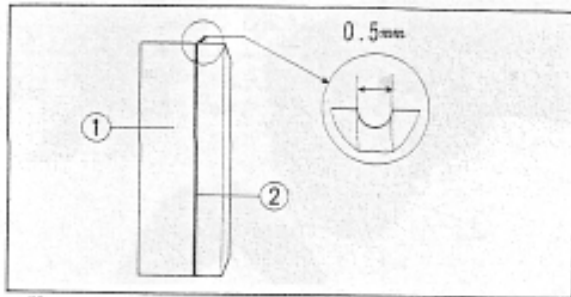


Fig. 4-21 ① Pad
② Red-line groove

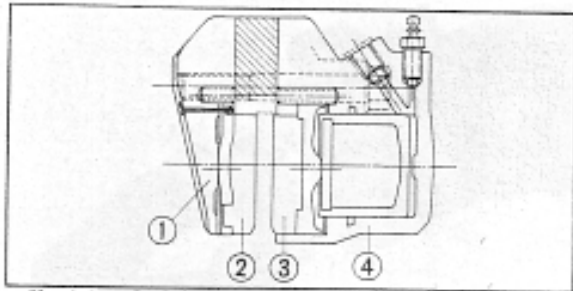


Fig. 4-22 ① Caliper B ③ Pad A
② Pad B ④ Caliper A

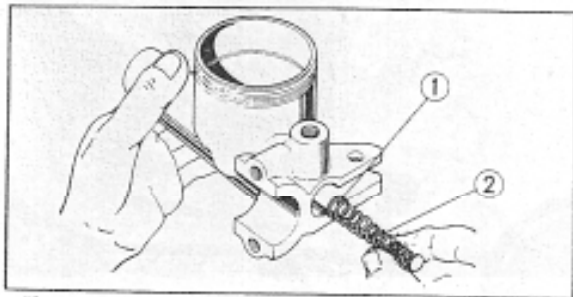


Fig. 4-23 ① Check valve ② Return spring

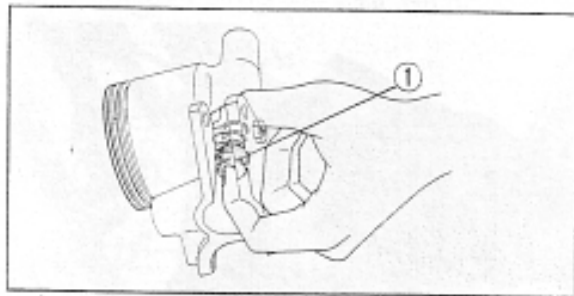


Fig. 4-24 ① Primary cup

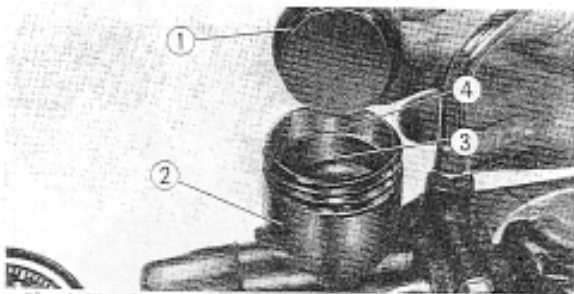


Fig. 4-25 ① Diaphragm ③ Brake fluid
② Master cylinder ④ Level line

Inspection

1. Check the pads A and B for excessive wear. Replace the pad if it is worn down to its red-line groove (wear limit line).
2. Measure the inside diameter of the caliper cylinder and the outside diameter of the piston.
3. Measure the inside diameter of the master cylinder and the outside diameter of the piston.

Reassembly

Caliper assembly

1. Apply a coat of silicone sealing grease to the sliding surface of the calipers when installing the pads A and B.

NOTE:

1. Do not grease the friction surfaces of the pads.
2. Take care to prevent foreign material from entering the caliper assembly at reassembly.

Master cylinder

1. Apply a coat of brake fluid to the inside surface of the cylinder.
2. Install the check valve together with the return spring to the cylinder.

NOTE:

Check to see the valve is installed properly in the cylinder.

3. Apply a thin coat of brake fluid to around the primary cup, and install it to the cylinder in proper orientation.

NOTE:

1. Take care not to damage the primary cup during installation.
2. Be sure to renew primary cup when it is disassembled.

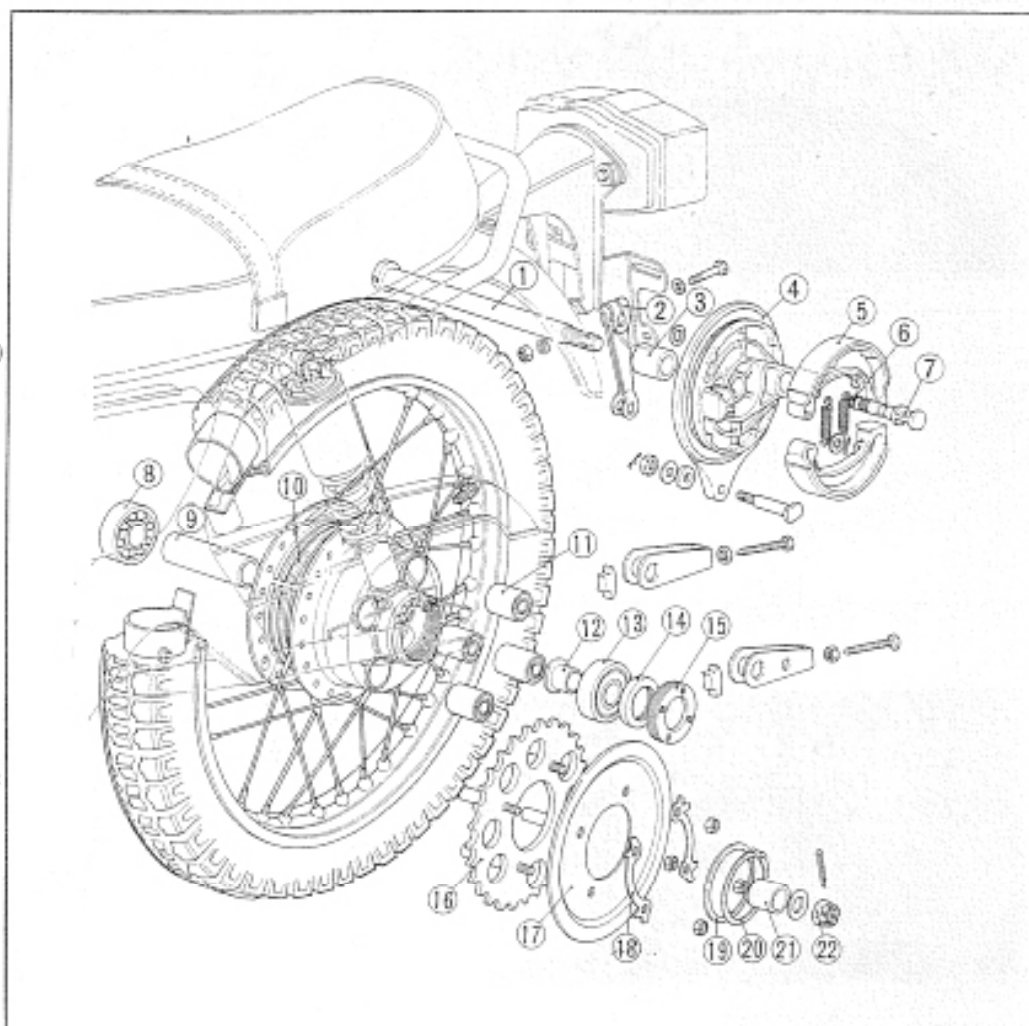
4. Install the 18 mm circlip. Check to see the circlip is fitted in place.

5. Bleed the brake line and fill the master cylinder fluid cup with SAE DOT3 brake fluid.

3. REAR WHEEL AND REAR BRAKE

Fig. 4-26

- ① Rear wheel axle
- ② Rear brake arm
- ③ Rear brake panel side collar
- ④ Rear brake panel
- ⑤ Rear brake shoe (two)
- ⑥ Rear brake shoe spring (two)
- ⑦ Rear brake cam
- ⑧ 6303 radial ball bearing
- ⑨ Rear axle distance collar A
- ⑩ Rear wheel hub
- ⑪ Rear wheel damper bush (four)
- ⑫ Rear axle distance collar B
- ⑬ 6304 radial ball bearing
- ⑭ Dust-seal 30×45×9.5
- ⑮ Rear wheel bearing retainer
- ⑯ Final driven sprocket
- ⑰ Sprocket side plate
- ⑱ 10 mm lock washer (two)
- ⑲ Washer 70 mm
- ⑳ External circlip 69 mm
- ㉑ Rear wheel side collar
- ㉒ Castle nut 16 mm



Disassembly

1. Remove the muffler at each side.
2. Remove the rear brake rod and rear brake stopper arm.
3. Loosen the drive chain adjusting bolt and lock nut on each side. Remove the cotter pin and loosen the axle nut.
4. Remove the drive chain from the final driven sprocket. Then take off the rear wheel together with the chain adjuster stopper and rear wheel axle.
5. Remove the 69 mm external circlip and remove the final driven sprocket. The lock washers need not be removed.

NOTE:

1. When replacing the final driven sprocket, replace it together with its fixing bolts.
2. When the lock washer has been removed, replace it with new one at reassembly.

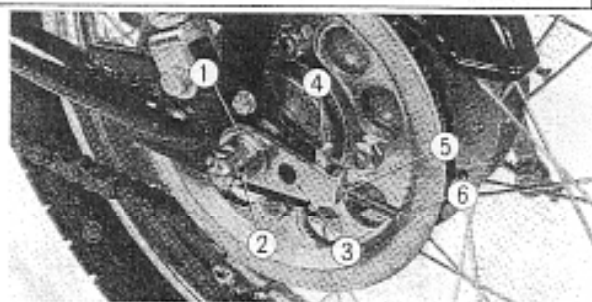
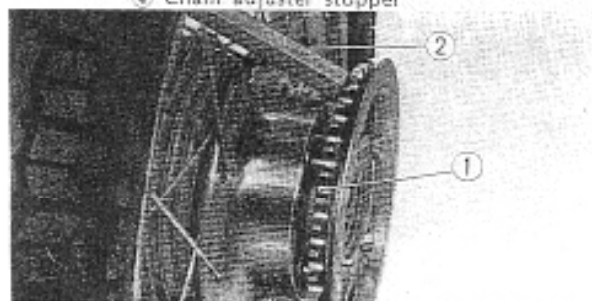

 Fig. 4-27 ① Axle nut ⑤ Lock nut
 ② Cotter pin ⑥ Chain adjusting bolt
 ③ Drive chain adjuster
 ④ Chain adjuster stopper


Fig. 4-28 ① Final driven sprocket ② Wood block

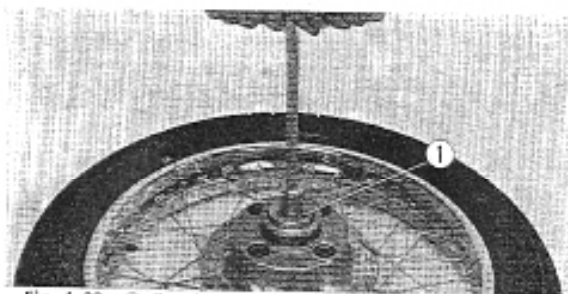


Fig. 4-29 ① Bearing retainer wrench

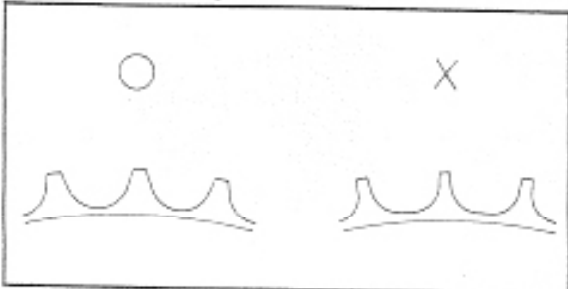


Fig. 4-30 Final driven sprocket for wear

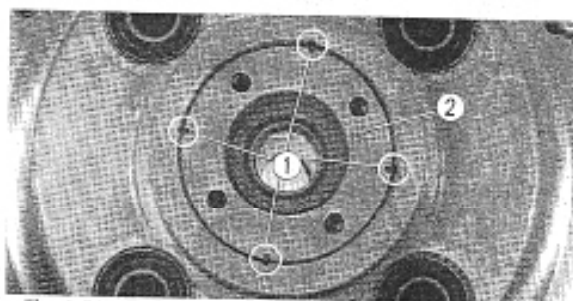
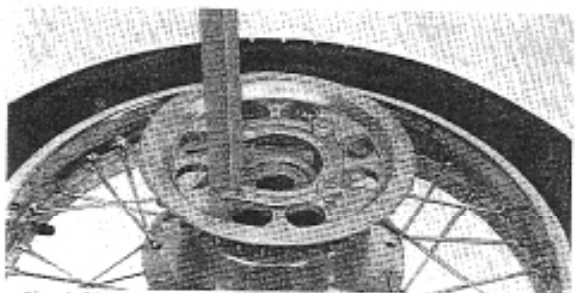
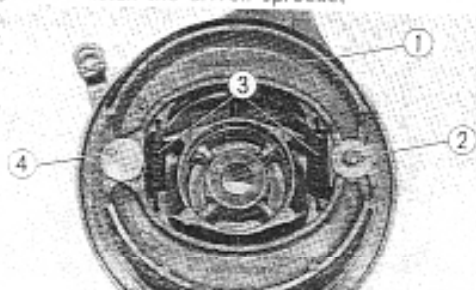
Fig. 4-31 ① Stake
② Bearing retainer

Fig. 4-32 Install the driven sprocket

Fig. 4-33 ① Brake shoes
② Anchor pin
③ Brake shoe springs
④ Brake shoe cam

- Remove the rear wheel bearing retainer with bearing retainer wrench (Tool No. 07088-32901).

Inspection

- Check the rear wheel axle for bend.
- Check the ball bearings for excessive play.
- Check the rim for face runout.
- Check the spokes for looseness, bend or any other damage.
Spoke torque specification: 20~30 kg-cm (1.5~1.9 lbs-ft).
- Check the final driven sprocket for wear or any other damage.
- Check the drive chain for excessive wear, elongation or any other damage.
- Check the tire for cracks, excessive wear or any other damage.
- Check the tire pressure.
Tire pressure specification: 2.0 kg/cm² (28 psi).
- Check the brake lining for excessive wear.
- Check the brake panel for cracks or any other damage.
- Check the brake drum for excessive wear.

Reassembly

- Fill the ball bearings and the wheel hub with grease. Insert the distance collar into the hub and drive in the bearing using bearing driven handle (Tool No. 07048-61101) and driver attachment (Tool No. 07048-33301).
- Install the bearing retainer using retainer wrench (Tool No. 07088-32901). Stake the bearing retainer at four places as shown in Fig. 4-31.
- Install the driven sprocket to the pivot bushing of the wheel hub and secure it with the 69 mm circlip.
- Apply a coat of grease to the anchor pin before installing the brake shoes.

NOTE:

- The brake shoe lining must be free from any grease or oil.
- Upon completion of reassembly, check the drive chain tension and adjust properly.
Also check the rear brake pedal for depressed-height and free play, and adjust properly if necessary.

4. STEERING HANDLEBAR

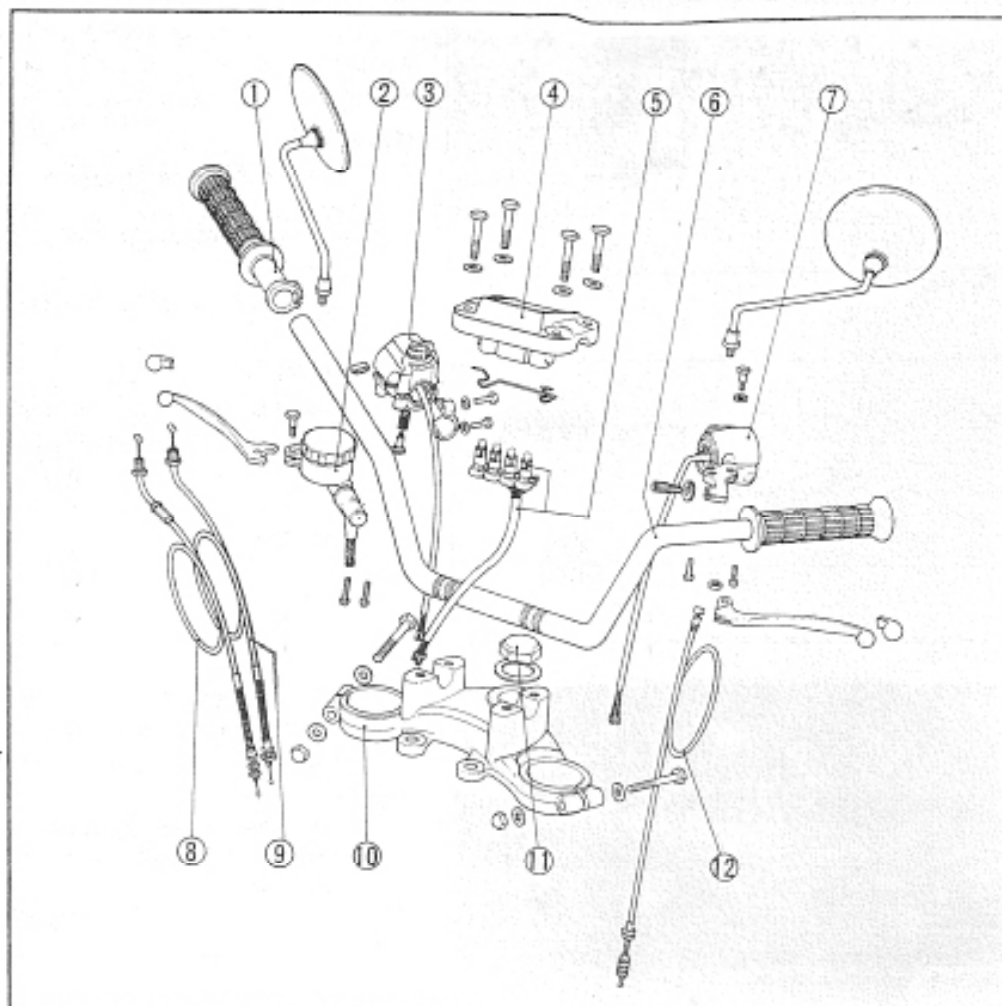


Fig. 4-34

- ① Throttle grip pipe
- ② Master cylinder
- ③ Starter, headlight, emergency switch
- ④ Upper handle holder
- ⑤ Pilot lamp
- ⑥ Steering handlebar
- ⑦ Turn signal, horn switch
- ⑧ Throttle cable A
- ⑨ Throttle cable B
- ⑩ Fork top bridge
- ⑪ Steering stem nut
- ⑫ Clutch cable

Disassembly

1. Remove the master cylinder, taking care not to spill brake fluid.
2. Disconnect the clutch cable at the lever.
3. Disconnect the throttle cables A and B from the carburetor throttle cable stay.
4. Remove the head light unit from the case and disconnect the wiring at the harness in the case.
5. Remove the upper handle holder and remove the steering handlebar.

Fig. 4-35 ① Master cylinder
② 6mm hex boltsFig. 4-36 ① Upper handle holder
② Steering handlebar

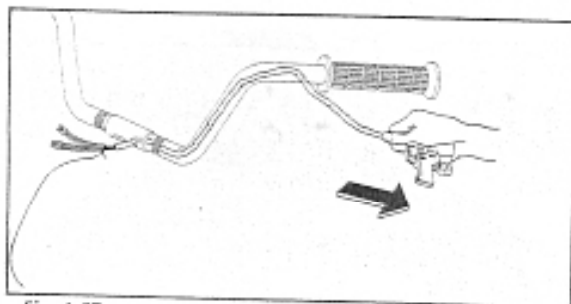


Fig. 4-37

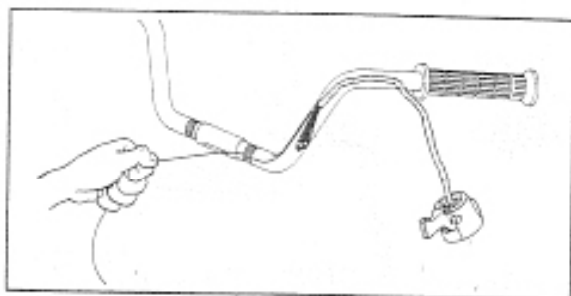


Fig. 4-38

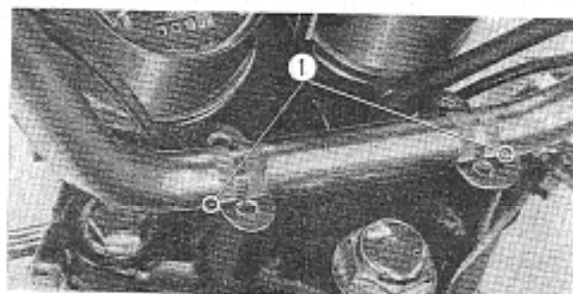


Fig. 4-39 ① Punch marks

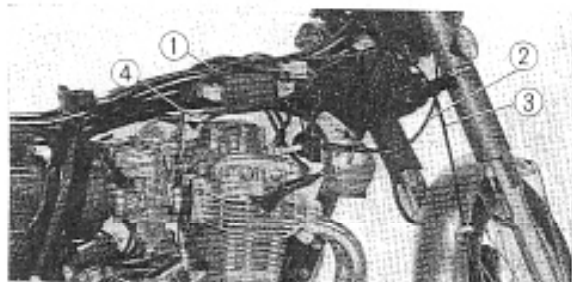


Fig. 4-40 ① Clutch cable ② Tachometer cable ③ Speedometer cable ④ Throttle cables

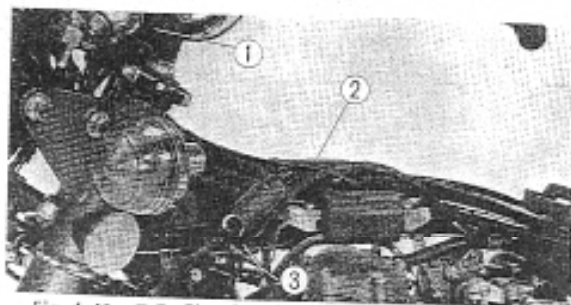


Fig. 4-41 ① Clutch cable ② Tachometer cable ③ Throttle cables

- Carefully pull out the lighting switch assembly and turn signal switch assembly from the steering handlebar.

Inspection

- Check the steering handlebar for twist or any other damage.
- Check each wiring for breakage or any other damage.
- Check each cable for damage.

Reassembly

- Install the lighting switch assembly and turn signal switch assembly to the steering handlebar. In this case use a wire or the like to tie the ends of the wirings to pass through in the pipe without binding or kinking.

- Install the steering handlebar, aligning the punch marks on the handlebar with the mating edges of the holder and fork top bridge.

NOTE:

- When tightening the upper holder to the fork top bridge, tighten the hex. bolts at the front first and then the ones at the rear.
- Take care not to bind or kink the wirings.
- Check to be sure each wiring and cable is free from binding or kinking when turning the steering handlebar fully to either left or right side.



5. STEERING STEM

Disassembly

1. Remove the front wheel and caliper assembly.
2. Remove the steering handlebar.
3. Remove the head light unit from the head light case and disconnect the wiring at the harness in the case. Then remove the case from the steering stem.
4. Disconnect the brake hose at the 3 way joint at the steering stem.
5. Remove the speedometer and tachometer. Disconnect the meter cables at the engine and front wheel sides.

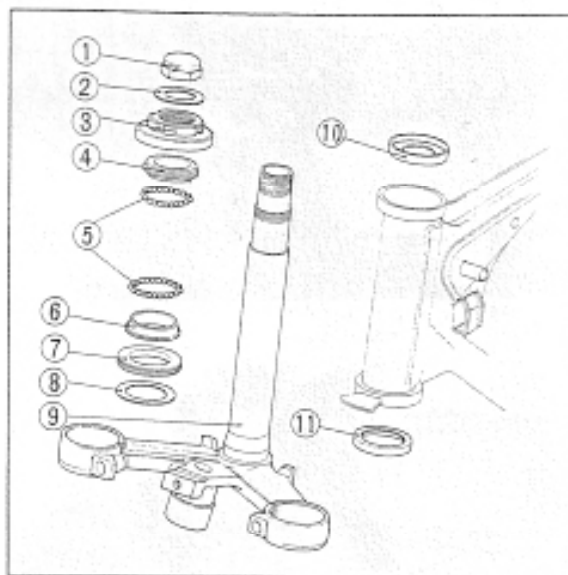


Fig. 4-42 ① Steering stem nut
② Steering stem nut washer
③ Steering top thread
④ Steering top cone race
⑤ #5 steel balls (thirty seven)
⑥ Steering bottom cone race
⑦ Steering head dust seal
⑧ Dust seal washer
⑨ Steering stem
⑩ Steering top ball race
⑪ Steering bottom ball race

6. Loosen the front fork bolt at the steering stem bottom bridge, and also loosen the bolts securing the forks at the fork top bridge. Then pull out the front fork assembly.
7. Loosen the steering stem nut on top of the stem, and remove the fork top bridge.



Fig. 4-43 ① Front fork bolts
② Steering stem nut
③ Fork top bridge

8. Loosen the steering head top thread to remove the steering stem.

NOTE:

Take care not to lose the steel balls (upper: 19 pcs. and lower: 18 pcs.)

Inspection

1. Check the steering stem for bend or any other damage.
2. Check the steering top and bottom cone races for excessive wear or any other damage.
3. Check the steering head dust seal for excessive wear.



Fig. 4-44 ① Steering head top thread
② Steering stem



Fig. 4-45 ① Top cone race
② $\varnothing 8$ steel balls

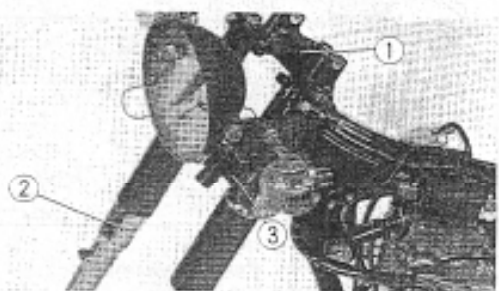


Fig. 4-46 ① Fork top bridge
② Front fork assembly
③ Steering stem

Reassembly

1. Install $\varnothing 8$ steel balls (upper: 19 pcs. and lower: 18 pcs.) to each race properly. Fully tighten the steering head top thread and turn it off so that the stem rotates easily without rattles when turned to either to left or right side.

NOTE:

Be sure to clean the cone races, ball races and steel balls in cleaning solvent, and apply a coat of grease before reassembly.

2. The fork top bridge should be installed after temporarily tightening the steering stem.

6. FRONT SUSPENSION

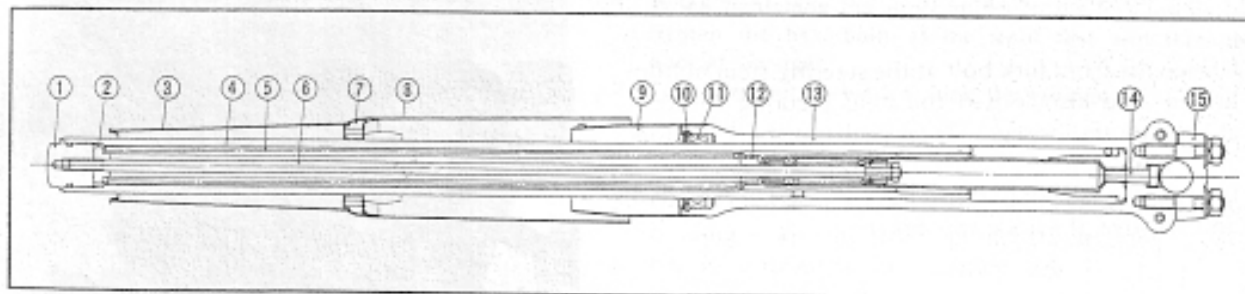


Fig. 4-47

- ① Front fork bolt
- ② Lock nut
- ③ Front fork cover
- ④ Front fork pipe
- ⑤ Front cushion spring

- ⑥ Damper
- ⑦ Front fork rib
- ⑧ Front fork under cover
- ⑨ Bottom case cover
- ⑩ 47 mm internal circlip

- ⑪ Oil seal 33×46×10.5
- ⑫ Cushion spring seat
- ⑬ Front fork bottom case
- ⑭ Socket bolt 8mm
- ⑮ Axle holder

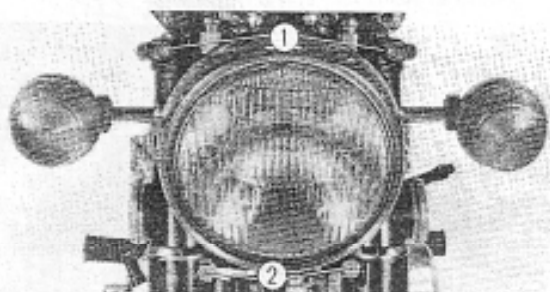


Fig. 4-48 ① 8 mm bolt at fork top bridge
② 8 mm bolt at steering stem bottom bridge

Disassembly

1. Remove the front wheel.
2. Remove the caliper assembly and front fender.
3. Loosen the 8 mm bolts at the steering stem bottom bridge and at the fork top bridge, which secure the front fork assembly. Pull out the assembly from underside.

NOTE:

Before loosening the above bolts, make the front fork bolts loose.

4. Drain the front suspension oil.

5. Remove rust on the front fork pipe, if any, with fine emery cloth.
6. Loosen the 8 mm socket bolt at the bottom of the fork bottom case using hollow wrench (Tool No. 07085-32301).

The front fork pipe complete with the damper unit can be removed from the bottom case as shown in Fig. 4-50 **A**.

7. Remove the front fork bolt on top of the fork pipe to remove the front cushion spring and spring seat.
8. To remove the oil seal, take off the bottom case cover and remove the circlip.

Inspection

1. Measure the free length of the front cushion spring.
2. Check the front fork pipe and bottom case for looseness or any other damage.
3. Check the oil seal for scratches or any other damage.
4. Check the front fork pipe sliding part for damage.

Reassembly

1. Install the front fork pipe complete with the damper unit into the fork bottom case.

NOTE:

Apply locking sealant to the 8mm socket bolt.

2. Apply a coat of ATF (automatic transmission fluid) to around and inside the oil seal before installing it to the front fork pipe. Press-fit the seal using front seal driver (Tool No. 07054-33301).

NOTE:

1. Be sure to install the circlip in place.
2. Replace the oil seal with a new one at reassembly.
3. Fill each front fork bottom case with good quality ATF of 125 cc (4.2 ozs).

NOTE:

When changing oil, add 105 cc (3.6 ozs).

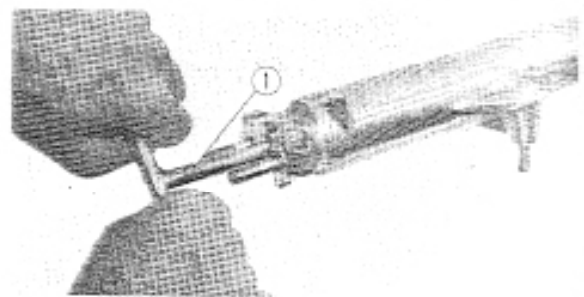


Fig. 4-49 ① Hollow wrench

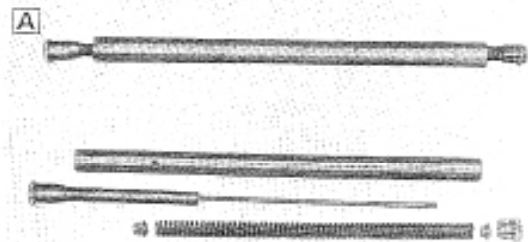


Fig. 4-50

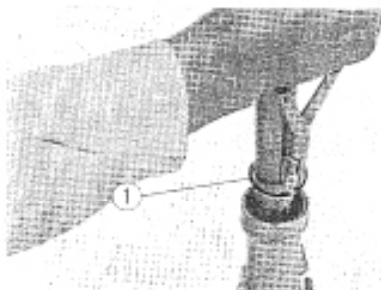


Fig. 4-51 ① Circlip



Fig. 4-52 ① Fork bottom case
② Front fork pipe



Fig. 4-53 ① Oil seal
② Front fork pipe
③ Front seal driver

7. REAR SUSPENSION

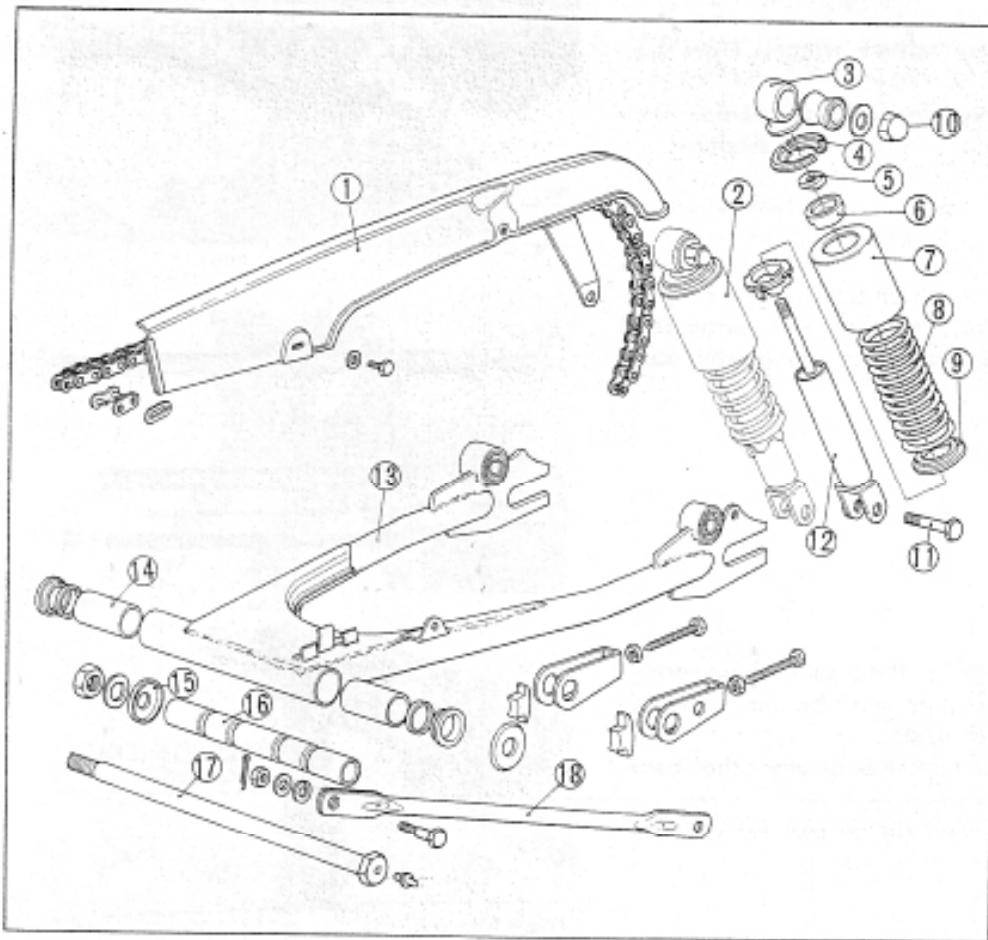


Fig. 4-54

- ① Drive chain case (two)
- ② Rear suspension (two)
- ③ Upper joint (two)
- ④ Spring seat stopper (four)
- ⑤ 9 mm lock nut (two)
- ⑥ Rear cushion stopper rubber (two)
- ⑦ Rear cushion upper case (two)
- ⑧ Rear cushion spring (two)
- ⑨ Spring under seat (two)
- ⑩ Rear cushion upper nut (two)
- ⑪ Hex bolt 10×32 (two)
- ⑫ Rear damper (two)
- ⑬ Rear fork
- ⑭ Rear fork pivot bush (two)
- ⑮ Rear fork dust-seal cap (two)
- ⑯ Rear fork center collar
- ⑰ Rear fork pivot bolt
- ⑱ Rear brake stopper arm

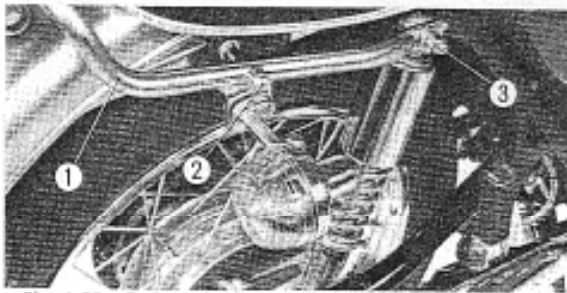


Fig. 4-55 ① Rear bumper
② 8 mm bolt
③ Rear cushion upper nut

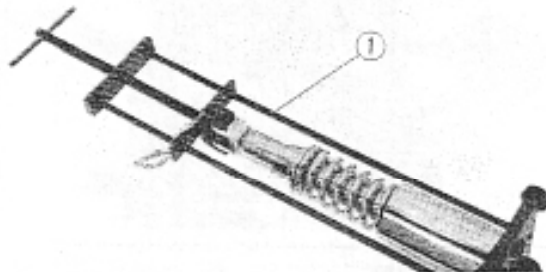


Fig. 4-56 ① Rear suspension service tool

Disassembly**Rear suspension**

1. Remove the rear bumper by loosening the 8 mm bolts and rear cushion upper nuts.
2. Remove the rear suspension by removing 10 mm bolts.

3. Compress the rear suspension using service tool (Tool No. 07035-32901) and remove the spring seat stoppers to remove the rear cushion spring.

Rear fork

4. Remove the rear wheel.
5. Loosen the self lock nut to pull out the rear fork pivot bolt. Then remove the rear fork from the frame.

Inspection

1. Measure the free length of rear cushion spring.
2. Check the rear cushion damper for deformation or oil leakage.
3. Check the rear cushion stopper rubber for damage.
4. Measure the rear fork center collar-to-bushing clearance.
5. Check the rear fork swing arm for bend.

Reassembly

1. Apply a coat of grease to the rear fork center collar before installing it to the rear fork.
2. Install the rear fork.
 - Insert the rear fork pivot bolt from the left side.
3. Assemble the rear suspension.
 - 1) Compress the rear suspension with the service tool (Tool No. 07035-32901) and pull up the upper joint to install the spring seat stoppers in place.
 - 2) Apply locking sealant to upper joint before tightening.
4. Install the rear suspension to the frame.

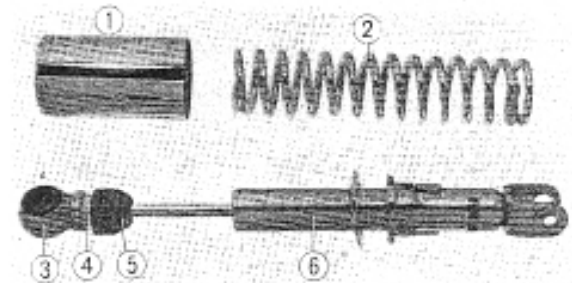


Fig. 4-57 ① Upper case
② Rear cushion spring
③ Upper joint
④ Lock nut
⑤ Stopper rubber
⑥ Rear damper unit

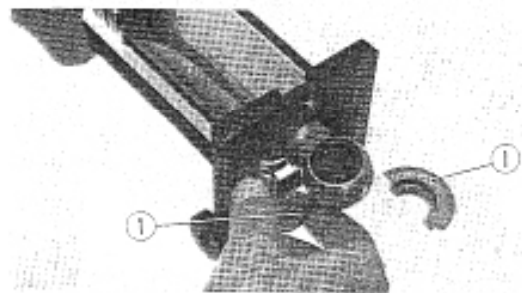


Fig. 4-58 ① Spring seat stoppers

8. FRAME BODY

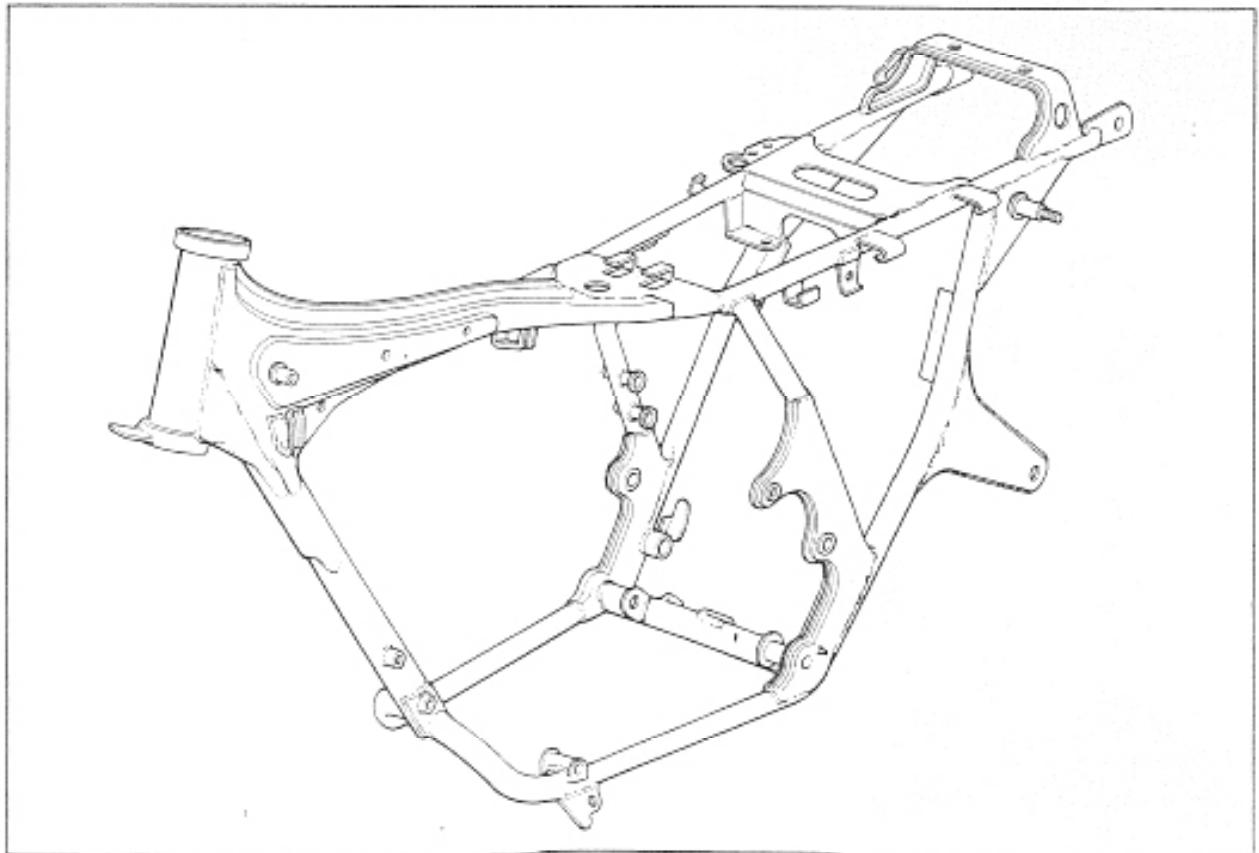


Fig. 4-59 Frame body



Fig. 4-60 ① ⊖ terminal
② ⊕ terminal

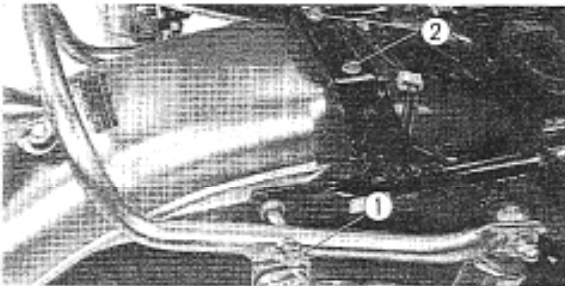


Fig. 4-61 ① 8 mm hex bolts
② 6 mm hex bolts

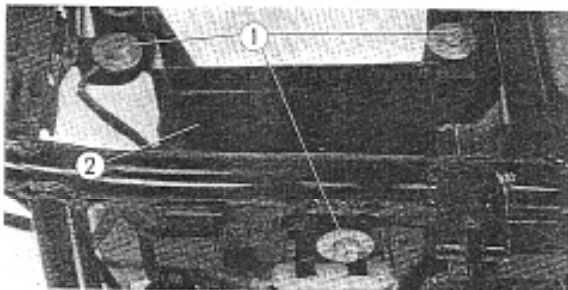


Fig. 4-62 ① 6 mm bolts
② Air cleaner case

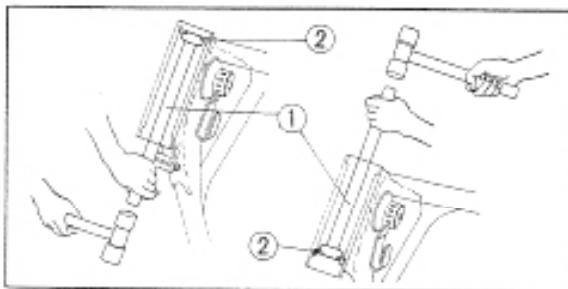


Fig. 4-63 ① Ball race remover
② Ball races

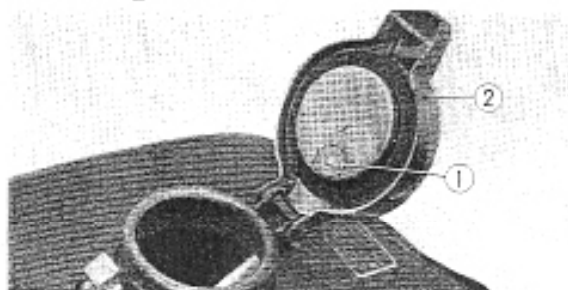


Fig. 4-64 ① Hole
② Fuel filler cap

Removal

1. Remove the fuel tank.
2. Remove the seat.
3. Remove the battery.
Disconnect the ground cable at the negative terminal first and then the starter cable at the positive terminal of the battery.
4. Dismount the engine from the frame.
5. Remove the steering stem.
Before removing the stem, remove the front wheel, front forks and steering handlebar.
6. Remove the rear fender.
Disconnect the wire leads of the rear turn signals and tail/stop light.
Loosen the 6 and 8 mm hex bolts which secure the rear fender.
7. Remove the air cleaner case and battery box.
Disconnect each wiring at the connector and coupler.
Remove the silicon rectifier, regulator and starter magnetic switch.
Loosen the three hex. bolts which secure the air cleaner case.
8. Disconnect the wire harness.
9. Remove the main and side stands.
10. Remove the top and bottom ball races from the steering head pipe using ball race remover (Tool No. 07048-33315).

Inspection

1. Check the hole in the fuel filler cap for clogging.
2. Check the frame body for bend, cracks, deformation or any other damage.

3. Check the steering head pipe for misalignment or deformation.
4. Check wire harness, coupler and connector for proper connection or any other damage.

5. Check the O-ring of the fuel cock drain and strainer cup for fatigue or any other damage.
6. Check the fuel pipe for any damage.

Installation

1. Drive the top and bottom ball races into the steering head pipe properly and evenly using ball race driver attachment (Tool No. 07048-33310) and driver handle (Tool No. 07048-61101).
2. Connect the wire harness.
Route the wirings and secure them with the clips.

3. Install the air cleaner case and battery box.
Remove any dust from the cleaner case and check the water drain hole for clogging before installation.

4. Install the battery box.
Connect the starter cable to the positive terminal and then the ground cable to the negative terminal of the battery.
Route the battery overflow tube in accordance with the battery caution mark.

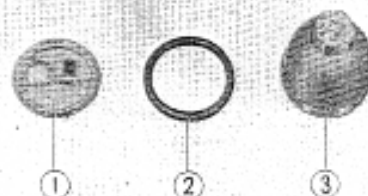


Fig. 4-65 ① Fuel strainer screen
② O-ring
③ Fuel strainer cup

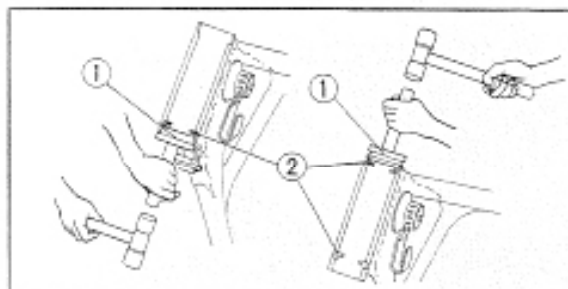


Fig. 4-66 ① Ball race remover
② Ball races

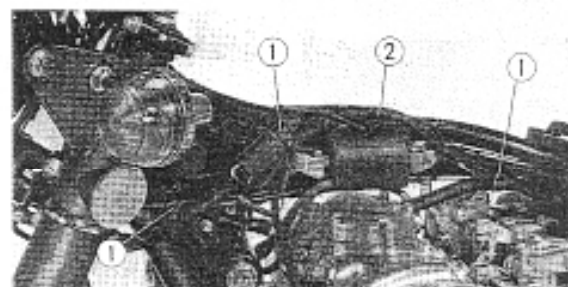


Fig. 4-67 ① Clips
② Wire harness

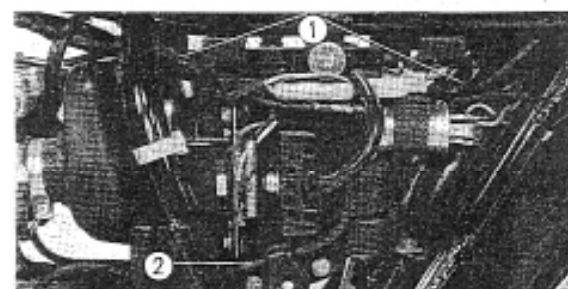


Fig. 4-68 ① Wire harness
② Starting motor cable



Fig. 4-69 ① Battery over flow tube

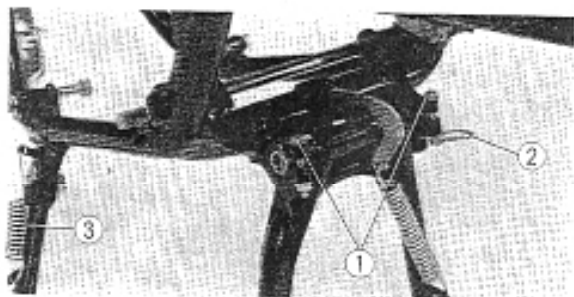


Fig. 4-70 ① Main stand mounting bolts
② Battery over flow tube guide
③ Side stand spring

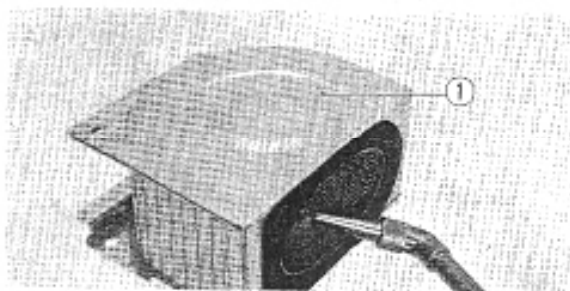


Fig. 4-71 ① Air cleaner

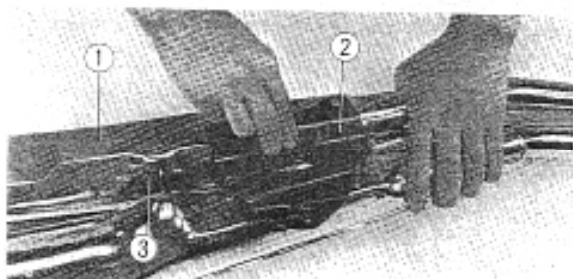


Fig. 4-72 ① Muffler
② Muffler bracket
③ Connecting tube

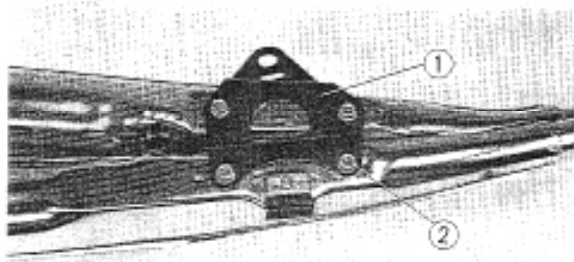


Fig. 4-73 ① Muffler bracket
② 8 mm nut

5. Install the main stand and side stand.

NOTE:

1. Do not overtighten the main stand mounting bolts. Be sure to install the battery over flow tube guide to the left side of the bolt.
2. Install the side stand spring with its longer hook part upward.

6. Clean the air cleaner.

Lightly tap the cleaner element and apply a blast of compressed air from inside to remove dust out.

7. Install the mufflers.

Join the upper and lower mufflers securely with the connecting tube and tighten the connecting pipe.

Install the mufflers to the frame with the brackets and tighten the 8 mm nuts.

V. ELECTRICAL

Courtesy of  Honda4Fun
www.hondafour.com www.honda4fun.com

1. GENERAL DESCRIPTION

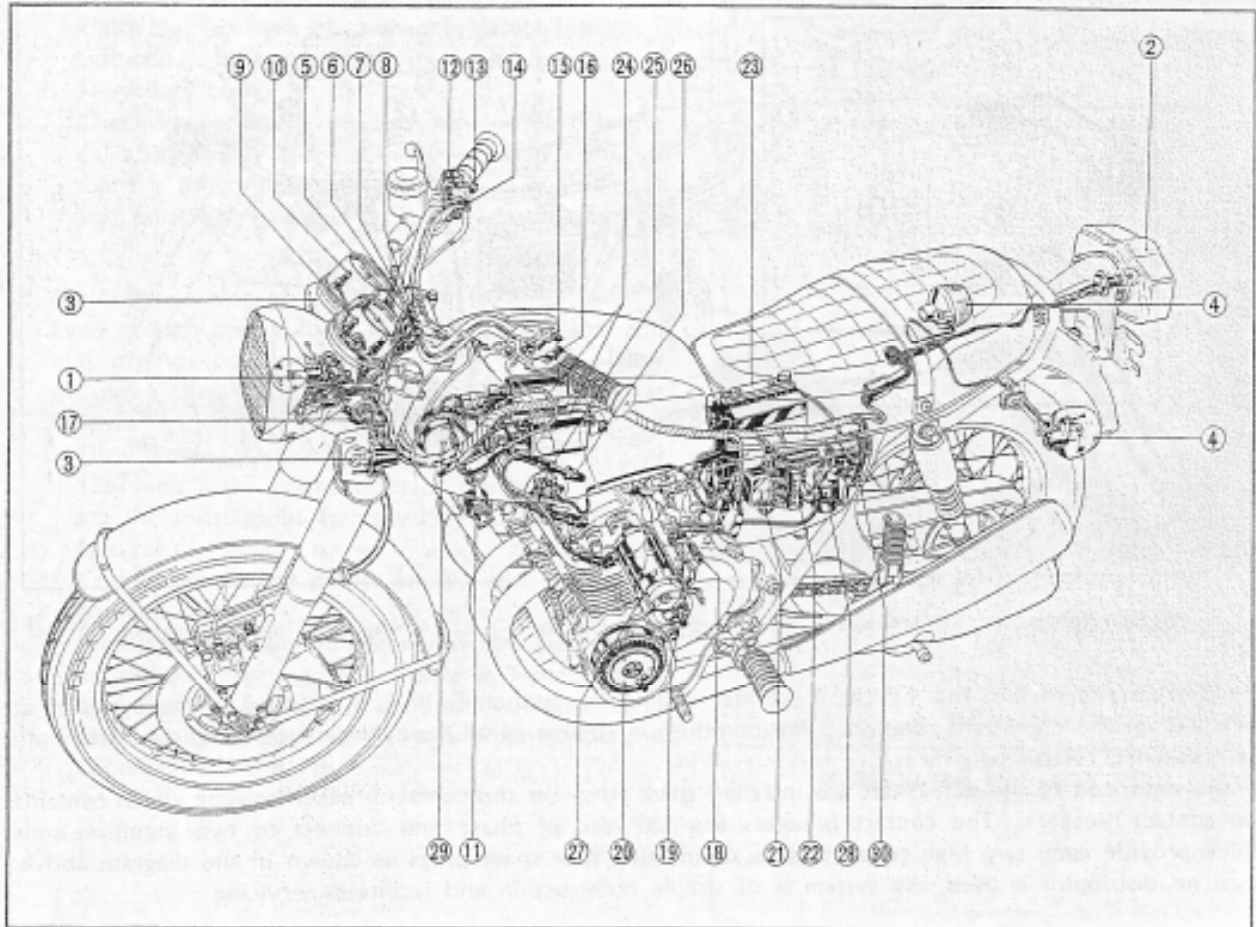


Fig. 5-1

LIGHTS

- ① Headlight
- ② Tail/stoplight
- ③ Front turn signal lights
- ④ Rear turn signal lights
- ⑤ Turn signal indicator lamp
- ⑥ Oil pressure warning lamp
- ⑦ Neutral indicator lamp
- ⑧ High beam indicator lamp
- ⑨ Speedometer lamp
- ⑩ Tachometer lamp

SWITCHES

- ⑪ Main switch
 - ⑫ Emergency switch
 - ⑬ Headlight control switch
 - ⑭ Starter switch
 - ⑮ Turn signal control switch
 - ⑯ Horn button
 - ⑰ Stop switch
 - ⑱ Neutral switch
 - ⑲ Oil pressure switch
- #### CHARGING SYSTEM
- ⑳ A-C generator
 - ㉑ Regulator

- ㉒ Silicon rectifier
 - ㉓ Battery
- #### IGNITION SYSTEM
- ㉔ Ignition coils
 - ㉕ Contact breaker
 - ㉖ Spark plugs
- #### STARTING SYSTEM
- ㉗ Starting motor
 - ㉘ Magnetic switch
- #### ELECTRICAL EQUIPMENT
- ㉙ Horn
 - ㉚ Winker relay

2. IGNITION SYSTEM

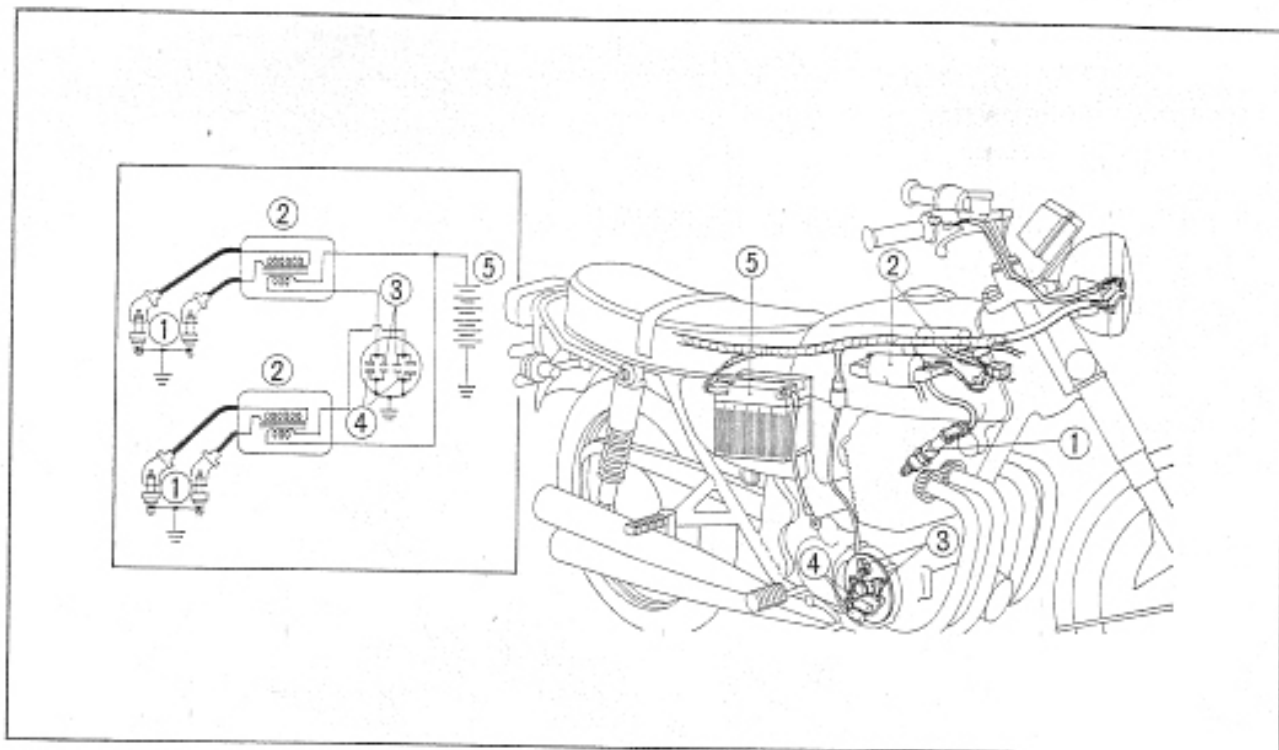


Fig. 5-2

① Spark plugs ② Ignition coils ③ Contact breakers ④ Capacitors ⑤ Battery

The ignition system fires the 4-cycle, 4-cylinder engine in a sequence of 1, 2, 4 and 3 of the cylinders at each 180° of the crankshaft rotation. The combustion strokes of all the cylinders are completed each time the crankshaft rotates two turns.

To the right end of the crankshaft are installed spark advancer and contact breaker housing which contains two contact breakers. The contact breakers are 180° out of phase and connect to two ignition coils which provide each two high tension cords connecting four spark plugs as shown in the diagram above. Since no distributor is used, the system is of simple construction and facilitates servicing.

Ignition coil 3 point spark gap opening	7 mm (0.27 in.), min.
Spark plug Type (standard) Plug gap	D-8ESL (NGK), X-24 ES (DENSO) 0.6-0.7 mm (0.024-0.028 in.)
Contact breaker Point gap Spring force	0.3-0.4 mm (0.012-0.016 in.) 650-850 gr. (1.43-1.87 lbs)
Capacitor Capacity Insulation resistance	0.22 μ F \pm 10% 10 M Ω (1,000 V with a megger)
Spark advancer Start of advance (crankshaft rotation) Full advance (crankshaft rotation) Advance angle	1,400-1,600 rpm 2,300-2,500 rpm 23.5°-26.5°

Ignition coils

Inspection

1. Continuity test

1) Primary coil

Check for continuity between the two terminals of the primary coil with a radio tester.

Right coil : yellow, black lead to white lead.

Left coil : blue, black lead to white lead.

2) Secondary coil

Check for continuity the high tension cord terminal and primary side terminal on each cord. If there is no continuity, the coil has an open-circuit and must be replaced.

2. Performance test

Even though continuity is ensured, an ignition coil may provide poor performance after a long period of use. Check to determine its performance as follows :

1) Turn the service tester selector knob to IGNITION TEST and make connections of the tester following the instructions furnished by the tester manufacturer.

2) Connect the tester power supply cord to a fully charged battery.

Measure the maximum distance where spark jumps across the gap regularly, using a 3-point spark appears as B in Fig. 5-5, connect the high tension cords in reverse to make measurement under the condition of A in Fig. 5-5.

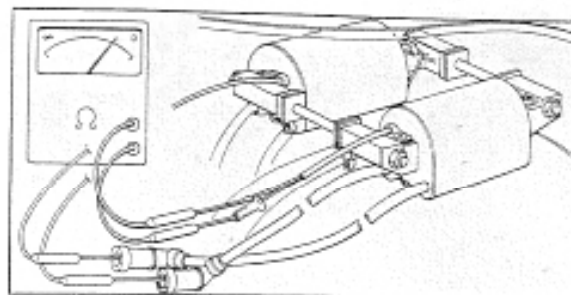


Fig. 5-3 Checking ignition coil for continuity

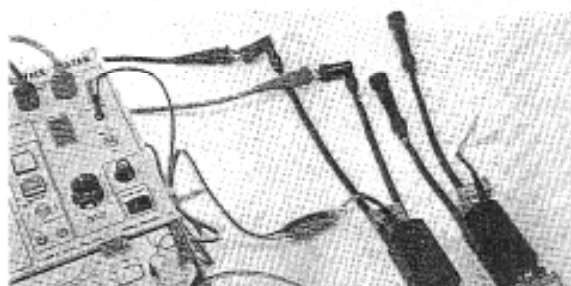


Fig. 5-4 Ignition coil performance test

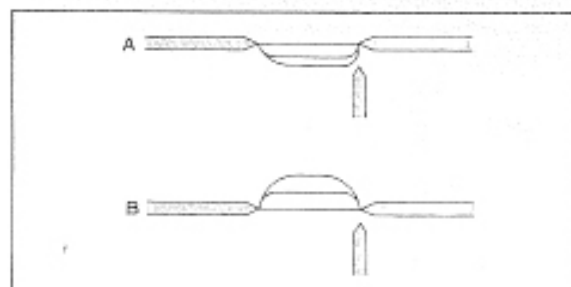


Fig. 5-5 3-point spark tester

Spark plugs

Inspection

1. Check the spark plug for worn or pitted electrodes, excessive gap, and damaged insulator.

1) Clean dirty spark plug using a plug cleaner or wire brush.

2) Measure the electrode gap with a thickness gauge, and adjust if necessary.

Gap specification : 0.6~0.7 mm (0.024~0.028 in)

3) Replace the spark plug with a new one, if the insulator or gasket is damaged or distorted.

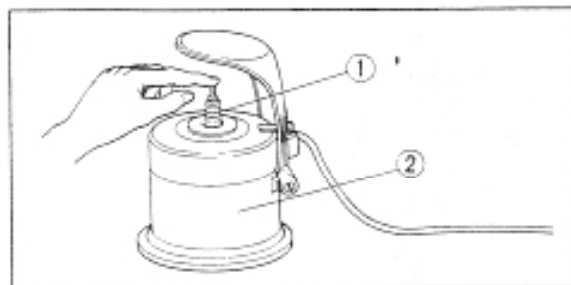


Fig. 5-6 ① Spark plug ② Plug cleaner

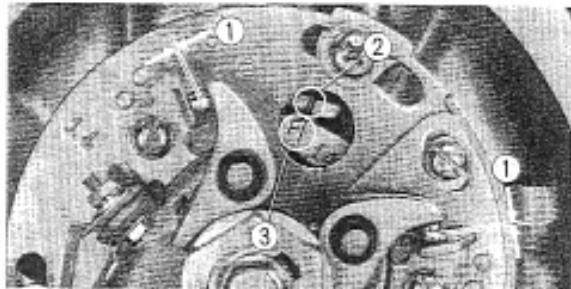


Fig. 5-7 ① Breaker point gap ② Matching mark
③ "F" mark

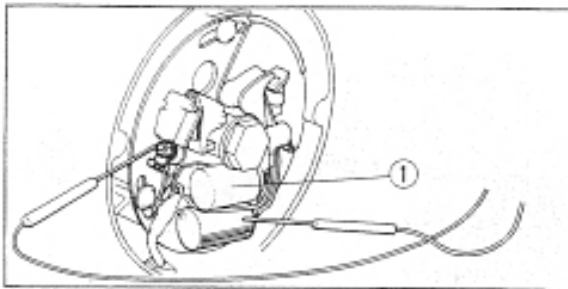


Fig. 5-8 ① Capacitors

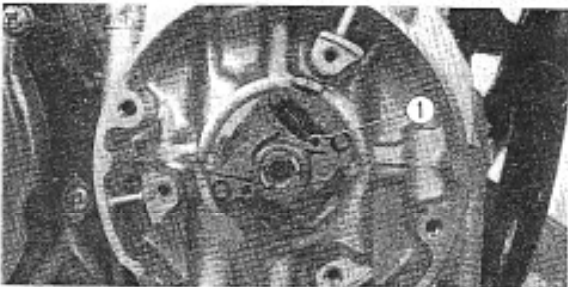


Fig. 5-9 ① Spark advancer

Contact breakers and capacitors

1. Contact breakers

For the adjustment of the breaker point and ignition timing, refer to the section INSPECTION AND ADJUSTMENT.

2. Capacitors

Measure the capacitance of the capacitors using the service tester.

Capacitance specification : $0.22 \mu\text{F} \pm 10\%$

NOTE:

The point must be kept open when measuring.

Spark advancer

Inspection

1. Wipe off any foreign matter from the friction surfaces and check for smooth operation.
2. Check the advancer pin for excessive wear.
3. Take the readings of the crankshaft rpm at initial and full advance angles using the timing light of the service tester.

MEMO

3. CHARGING SYSTEM

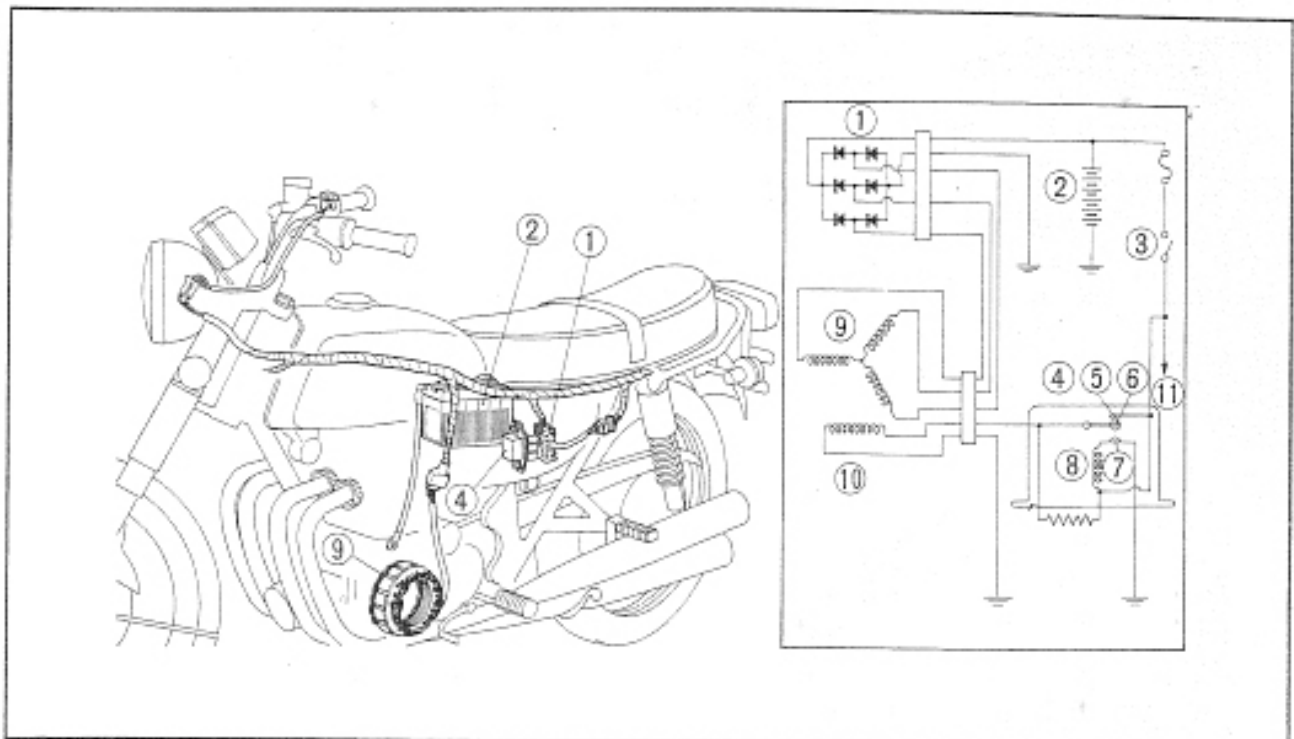


Fig. 5-10

- | | | | |
|---------------------|------------------|-----------------|--------------|
| ① Silicon rectifier | ④ Regulator | ⑦ Lower contact | ⑩ Field coil |
| ② Battery | ⑤ Upper contact | ⑧ Relay coil | ⑪ Load |
| ③ Main switch | ⑥ Moving contact | ⑨ Stator coil | |

The charging system consists of a 3 phase A-C generator, silicon diode rectifier, voltage regulator and storage battery. The 3 phase A-C generator, a brushless exciting type, is capable to generate high voltage output enough to operate all electrical units of this machine. It features compact construction, light weight and reduced wear parts to facilitate its handling and servicing. A dual-contact type Tirrill regulator is used in the charging circuit.

1. Charging test

- 1) Use a fully charged battery for the test. (The specific gravity of the electrolyte in each cell must be 1.26~1.28 at 20 C° or 68 F°.)
- 2) Connect the negative probe of an ammeter to the positive terminal of the battery and the positive probe to the harness.
- 3) Connect the probes of a voltmeter to the battery terminals in similar polarity.
- 4) Run the engine under the conditions of NIGHT-TIME RIDING by switching the headlight on, and DAYTIME RIDING, with the headlight off and take the meter readings. If the readings are out of the charging characteristics as specified on next page, check the generator for condition. If it is normal, check and adjust the regulator.

NOTE:

Remember the generator output may vary with a temperature.

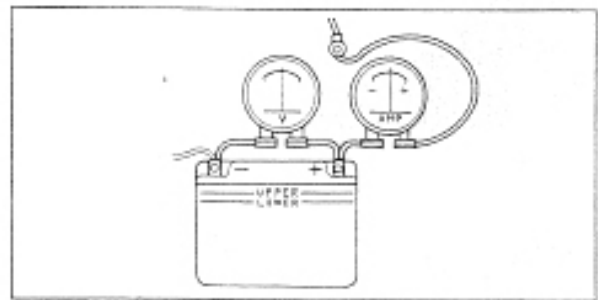


Fig. 5-11 Charging test

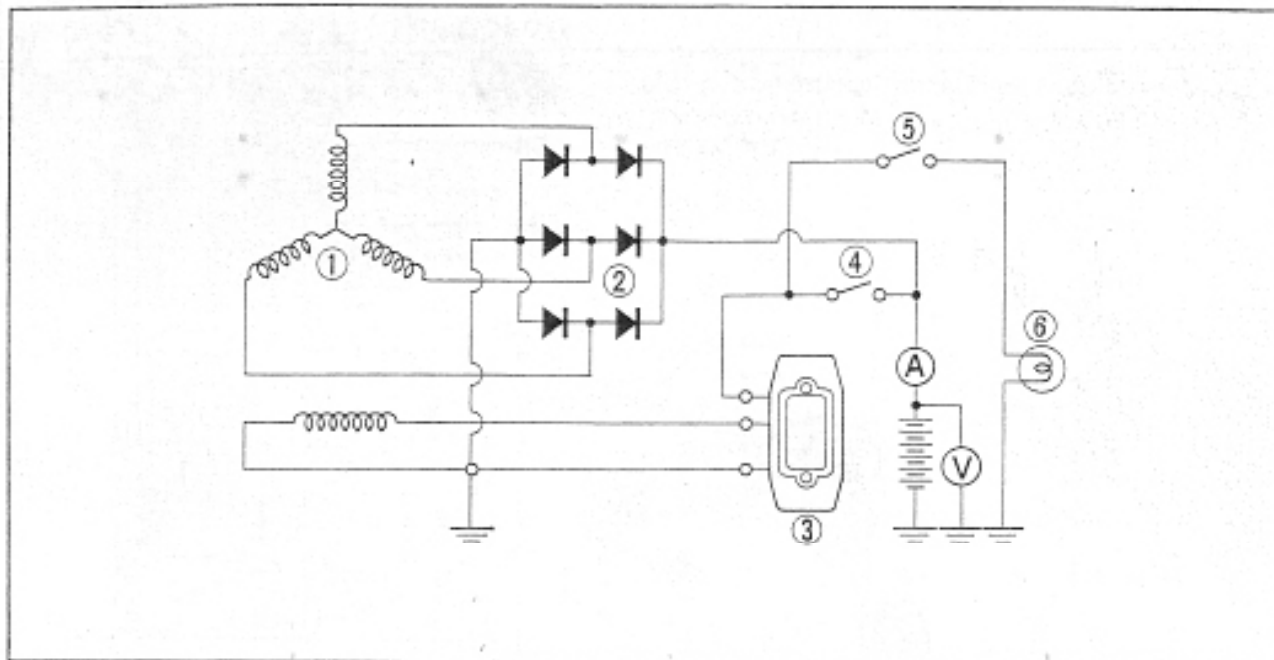


Fig. 5-12 Charging test circuit

- ① A-C generator ③ Regulator ⑤ Lighting switch
- ② Silicon rectifier ④ Main switch ⑥ Load

Charging characteristics

Engine (rpm)	1,000	2,000	3,000	4,000	5,000	6,000	7,000	8,000
Charging current (Ampere)								
NIGHTTIME RIDING	1.6	1.9	2.0	1.8	1.6	1.5	1.4	1.4
DAYTIME RIDING	—	—	4	2.6	2.0	1.6	1.4	1.4
Battery terminal voltage (Volt)	12.5	14.2	15	15	15	15	15	15

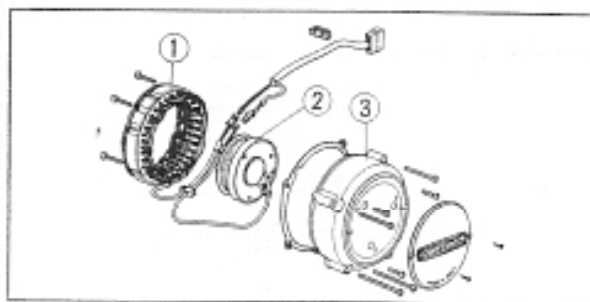


Fig. 5-13 ① Stator coil
② Field coil
③ Dynamo cover

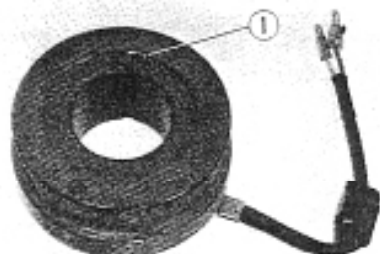


Fig. 5-14 ① Field coil

A-C generator

Rated current output	14.5V 13A
Rated charging speed	5,000rpm
Ground polarity	⊖

Inspection

1. Checking field coil for continuity
Check for continuity between the two leads (white and green) with a radio tester.
Resistance specification : 4.6~5.0Ω

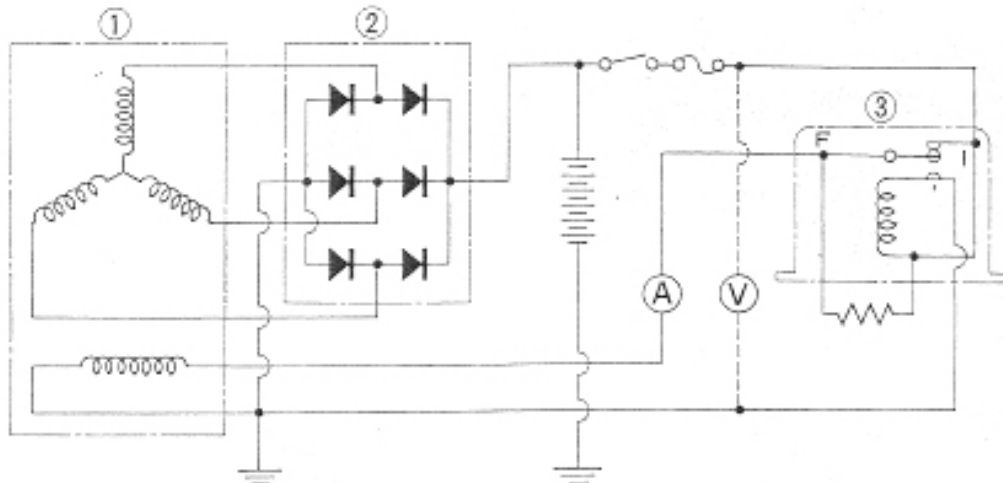


Fig. 5-15 ① A-C generator ② Silicon diode rectifier ③ Regulator

2. Checking resistance of the stator coil windings: Using an ohmmeter set to its lowest scale range, measure the resistance between one yellow wire lead and each of the remaining two. Test all three leads in this manner.

Specification: 0.61–0.69 ohms resistance between leads

Silicon diode rectifier

Test each diode for forward and reverse continuity with an ohmmeter or test light. Touch one of the yellow wire coupling pins ③ with either of the test instrument leads, then touch the second test lead to pins ④ and ⑤ in turn. Note the continuity indication. Repeat this procedure at each of the two remaining yellow wire coupling pins ③ (Fig. 5-18).

Reverse the test instrument leads and repeat the above procedure.

The rectifier is good if the test shows continuity in one direction only at all diodes. The rectifier is defective if:
a. There is continuity in both directions at any diode.
b. There is no continuity in either direction at any diode.

CAUTION:

Do not use an ohmmeter's megohm range (ohms X 1,000,000) for this test.

Do not operate the engine with the red/white rectifier lead disconnected.

When installing a battery, be careful to connect battery terminal wires in correct polarity.

Disconnect the rectifier coupling plug when charging the battery from an external power source.

Failure to observe these precautions may result in damage to the diodes.

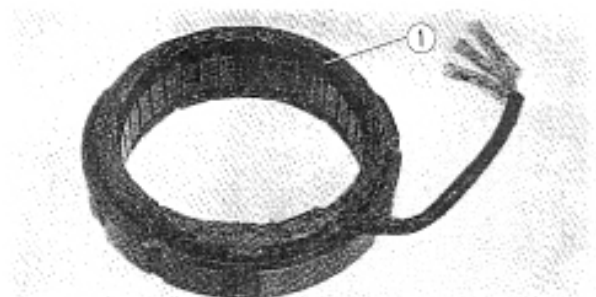


Fig. 5-16 ① Stator coil

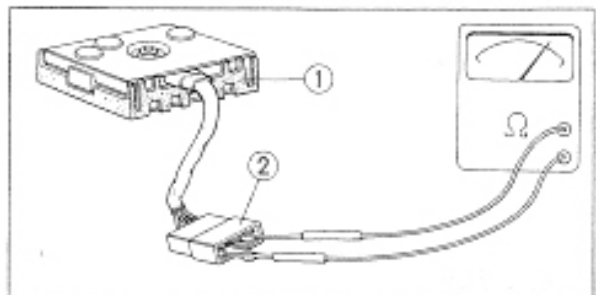


Fig. 5-17 ① Silicon diode rectifier ② Coupler

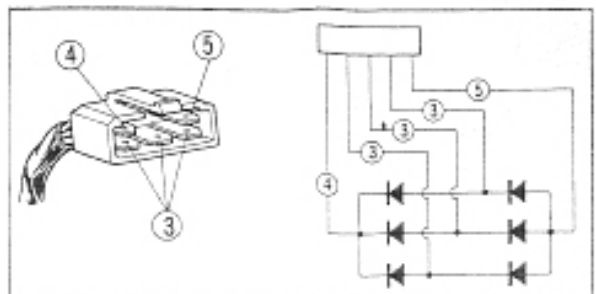


Fig. 5-18 ③ Yellow leads ④ Red/white lead ⑤ Green lead

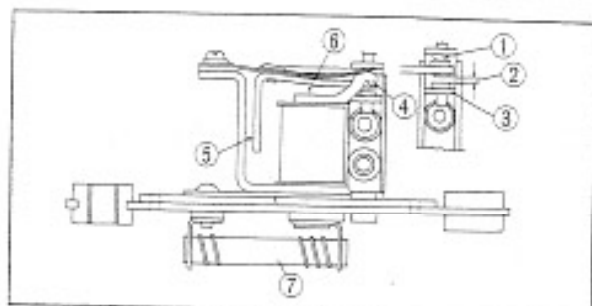


Fig. 5-19 ① Upper contact point
② Point gap
③ Lower contact point
④ Charging rate adjustment arm
⑤ Angle gap
⑥ Armature gap
⑦ Resistor

Regulator

Intermittent opening of the regulator contact points during operation creates a resistance in the field circuit, reducing alternator output. The voltage level at which this occurs may be adjusted as necessary.

Testing

Test regulator with battery fully charged.

1. Connect a DC voltmeter from regulator ignition terminal (I) to ground. Remove the white lead from the field terminal (F), and connect an ammeter between the wire and the terminal.
2. With the engine idling, note the field current. If value exceeds Mode I limits in the table below, the regulator or alternator field coil is faulty.
3. Slowly increase engine speed until the ammeter needle deflects to half the Mode I value. Note the voltage reading at the moment the ammeter needle deflects and compare with Mode II in the table below.
4. Increase engine speed to 4000rpm or more, and note the maximum voltage reading. Field current and voltage should agree with Mode III in the table below.

MODE	FIELD CURRENT	VOLTAGE
I (idle)	2.4-2.6 A	to 13.2 V
II	1.2-1.3 A	13.5-14.5 V
III	0-1.2 A	14.0-15.0 V

If field current does not decrease as voltage increases, the regulator is faulty.

If field current to voltage values are higher or lower than the limits in the table, adjustment is indicated.

If voltage exceeds 15.0V at any speed, system is overcharging.

Adjustment

1. **Armature gap: 0.6-1.0 mm (0.020-0.040 in.)**
If adjustment is required, loosen the point base screw, and raise or lower the point assembly to obtain the correct armature gap.
2. **Angle gap: 0.6 mm (0.024 in.)**
Adjustment of the armature gap simultaneously adjusts the angle gap.
3. **Point gap: 0.3 mm (0.012 in.)**
If adjustment is required, carefully bend the lower point bracket to obtain the correct point gap.
4. **Adjusting arm**
After checking armature gap and point gap, bend the adjusting arm up or down to obtain the correct voltage readings. Bend the adjusting arm up to increase the charging rate or down to decrease the charging rate.

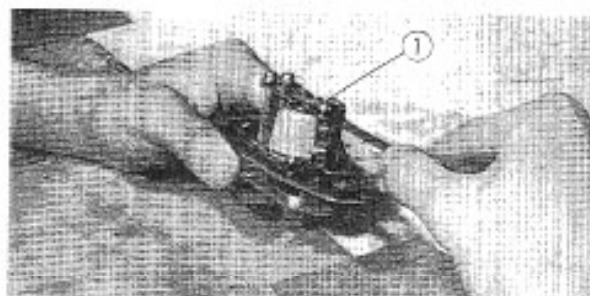


Fig. 5-20 ① Checking point gap with a feeler gauge

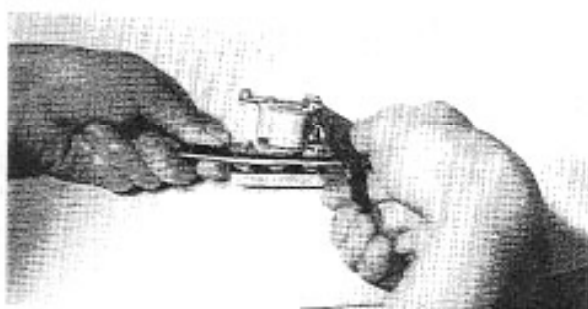


Fig. 5-21 Bending the adjusting arm to adjust the charging rate

4. STARTING SYSTEM

The starting motor is located on the upper crankcase. It is of a drip- and dust-proof type.

The torque developed by the motor is transmitted through reduction gears, driven gear, and overrunning clutch to the primary shaft.

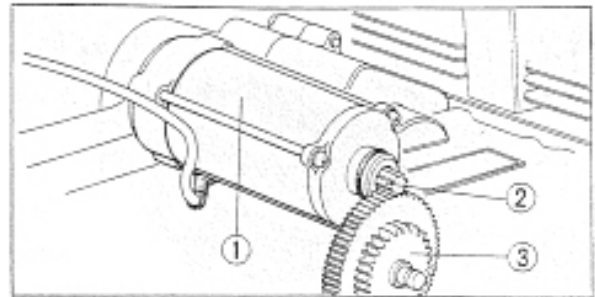


Fig. 5-22 ① Starting motor
② Starting motor shaft gear
③ Starting motor reduction gear

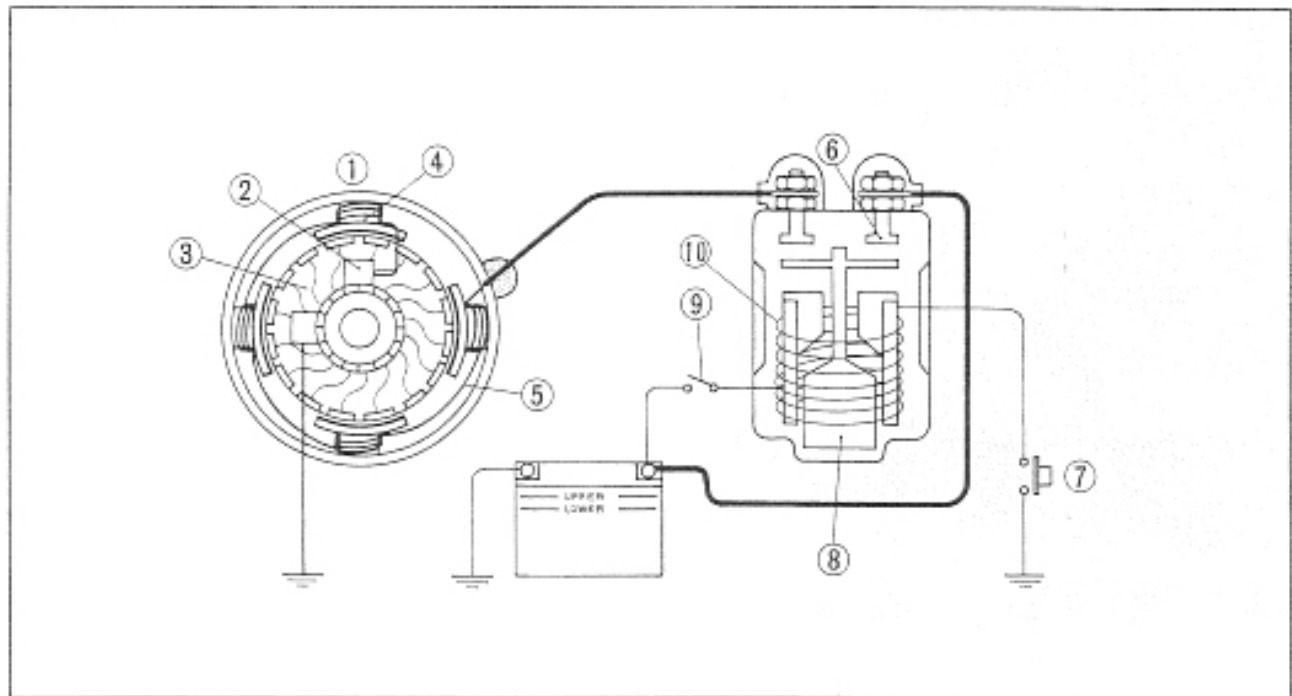


Fig. 5-23

- | | | |
|------------------|-------------------|------------------|
| ① Starting motor | ④ Poles | ⑦ Starter switch |
| ② Brushes | ⑤ Field coil | ⑧ Plunger |
| ③ Armature | ⑥ Magnetic switch | ⑨ Main switch |

Starting motor

Specifications and characteristics

Rated output voltage : 12 V

Rated output : 0.6kW

Rated operating time : 30sec., (continuous)

	On-load	No-load	When locked
Voltage (V)	11	8	5
Amperage (A)	35	120	250
Torque (kg-cm) (lb-ft)	--	0.11 (0.795)	0.26 (1.880)
Speed (rpm)	1,100-22,000	3,200	--

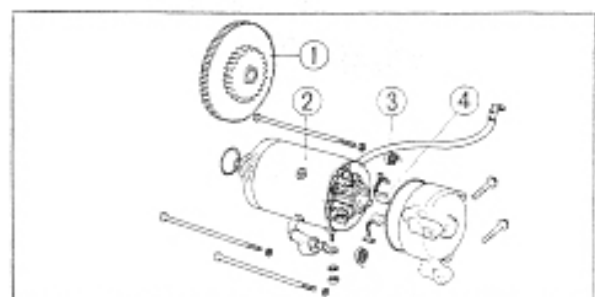


Fig. 5-24 ① Starting motor reduction gear
② Starting motor
③ Brush spring
④ Brush

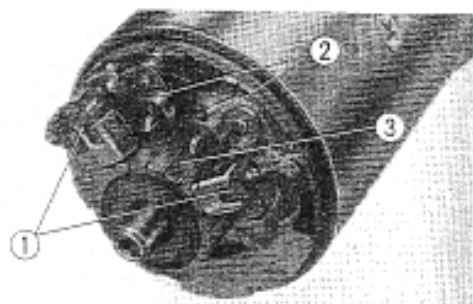


Fig. 5-25 ① Carbon brushes ② Brush springs ③ Commutator

Inspection

1. Checking carbon brushes

Check the brushes and springs for condition. Brushes which are excessively worn and not seating properly on commutator and weakened brush spring may cause the starting motor inoperative. Replace the brush or spring if out of the specifications below.

	Standard value	Repair limit
Carbon brush length, mm (in.)	12~13 (0.47~0.51)	5.5 (0.22) max.
Brush spring tension, kg (lbs)	0.5~0.6 (1.1~1.3)	0.4 (0.8) max.

2. Cleaning commutator

Check the commutator surface for condition. Polish the surface with a fine emery cloth if dirty, and thoroughly wipe it clean before reassembly.

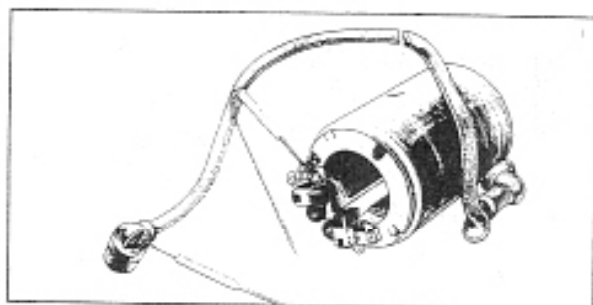


Fig. 5-26 Checking field coil for continuity

3. Checking field coil for continuity

Check for continuity between the brushes connected to the field coil and starting motor cable. If there is no continuity, it is an indication that the field coil has an open circuit.

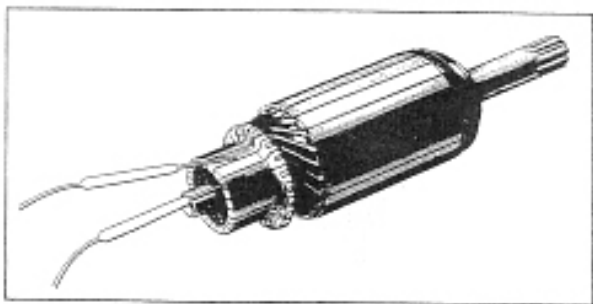


Fig. 5-27 Checking armature coil for continuity

4. Checking armature coil for continuity

The armature coil with a short-circuit will result in a failure of the starting motor to operate properly. Check for continuity between the commutator surface and core. If there is any continuity, the stator coil is grounded.

Starting magnetic switch

The starting motor draws a large amount of current of approx. 100A when cranking the engine.

This is why a large-capacity electromagnetic switch which is electrically remote-controlled by a separate switch (starter switch) is used.

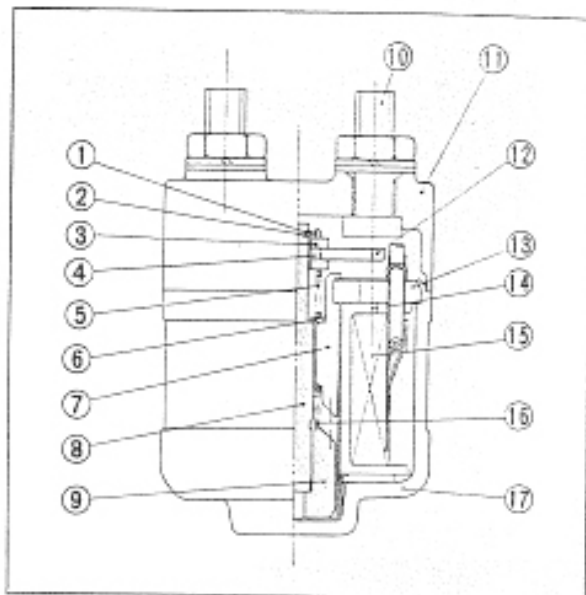


Fig. 5-28

① Stopper	⑩ Contact bolt
② Stopper holder	⑪ Case
③ Washer	⑫ Contact plate
④ Roller A	⑬ Yoke
⑤ Contact spring	⑭ Coil bobbin
⑥ Flat washer	⑮ Coil complete
⑦ Plunger holder	⑯ Return spring
⑧ Plunger shaft	⑰ Body
⑨ Plunger	

Inspection

1. Checking primary coil for continuity

If there is no continuity, the primary coil has an open-circuit. The coil is in good condition when a clicking sound is heard by applying a 12V battery across the two leads of the coil.

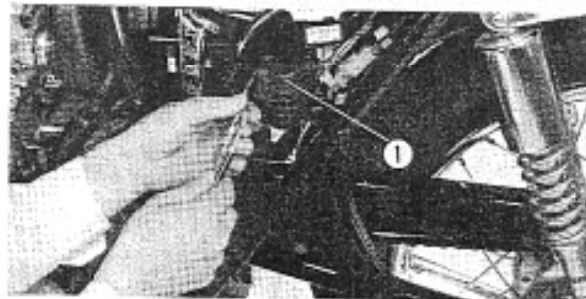


Fig. 5-29 ① Starting magnetic switch

2. After a long period of use, the contact points of the magnetic switch will become pitted or burnt due to a large amount of current, and, in the worst cases, the current will not flow due to increased resistance.

Check for continuity across the two leads of the primary coil by connecting a 12V battery with the switch turned on. If there is no continuity, it is an indication that the starting magnetic switch is at fault.

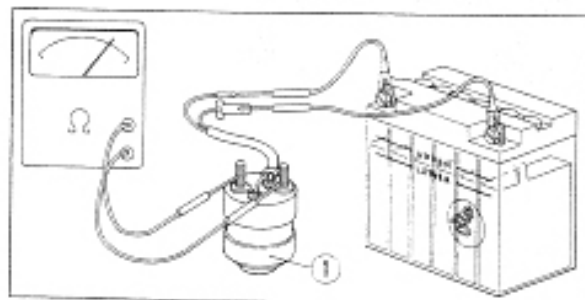


Fig. 5-30 ① Starting magnetic switch

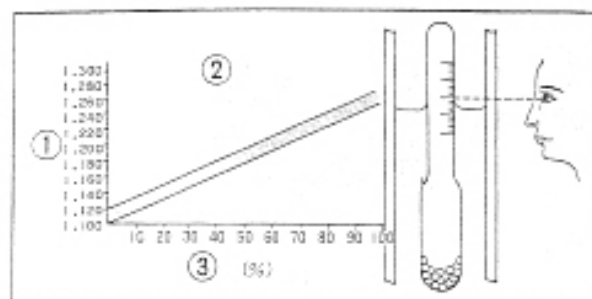


Fig. 5-31 ① Specific gravity
② Relation between specific gravity and residual charge
③ Residual charge

Battery

Specifications

Type	12 N 12 A-4 A
Voltage	12 V
Capacity	12 AH

Measuring specific gravity of electrolyte.

Using a hydrometer, measure the specific gravity of the electrolyte in each cell. When the reading taken is below 1.200 at 20°C or 68°F, recharge the battery. When reading the hydrometer, hold the gauge barrel vertically as shown.

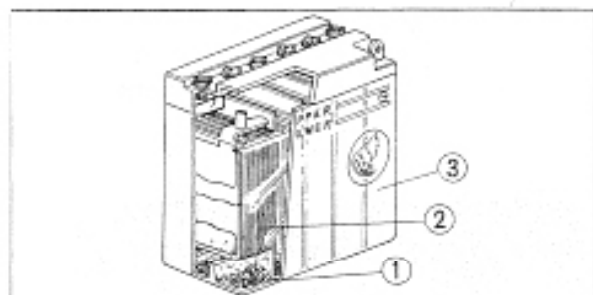


Fig. 5-32 ① Sediment
② Plates
③ Battery case

Inspection

1. Check each battery cell for correct electrolyte level semi-monthly or monthly. If the level is low, add distilled water up to the upper level.
2. When the electrolyte decreases rapidly, check the charging system.
3. Periodically check each cell for correct specific gravity. After adding distilled water, charge the battery by operating the engine, and then check the specific gravity.
4. Check the battery terminals for corrosion. Check for separated battery paste and for sulfation. These defects are the symptoms of a run-down battery. Periodical inspection is always necessary, especially the battery is kept in storage for an extended period of time.

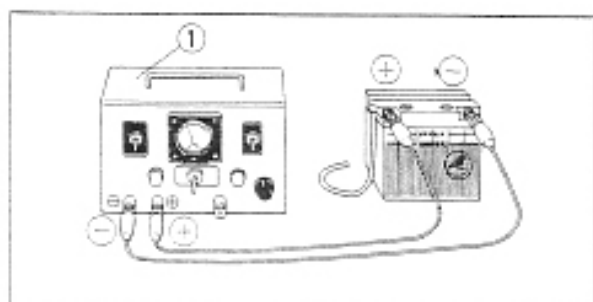


Fig. 5-33 ① Battery charger

Charging battery

1. It is advisable that the battery be charged as slowly as possible since quick charging is the sure way of shortening the battery service life. Where the battery has to be charged quickly the charging current should be held to 2.0A maximum.
2. Hydrogen gas is produced during charging operation. Keep away from fire.
3. After charging, flush the battery clean and grease the terminals.



5. ELECTRICAL EQUIPMENTS

Main switch

With the key in either ON or OFF, check the main switch for continuity. If there is continuity in the circuit (○—○), the switch is in good condition. If there is no continuity or if there is any continuity in other circuits shown below, the switch is at fault.

		BAT	IG	TL1	TL2
Cord color		Red	Black	Brown/white	Brown
Key Position	OFF				
	I	○—○	○—○	○—○	○—○
	II	○—○	○—○	○—○	○—○

Front stop switch

Put the tester probes on the terminals of the front stop switch cords (black, green/yellow).

Operate the brake lever to check for continuity.

The stop light should come on with the brake lever is moved 5~10 mm (0.2~0.4 in.) as measured at the tip of the lever.

NOTE:

Note that the lever play is 2~5 mm (0.08~0.2 in.) at the lever end.

Rear stop switch

Put the tester probes on the terminals of the rear stop switch cords (green/yellow, black) to check for continuity. The rear stop light should come on when the rear brake pedal is depressed 20 mm (0.8 in.) as measured at the tip of the pedal. Adjust by means of the adjusting nut if necessary.

Horn

Check for continuity between the horn cord terminals or check to make sure the horn sounds when it is connected to fully charged 12 V battery.

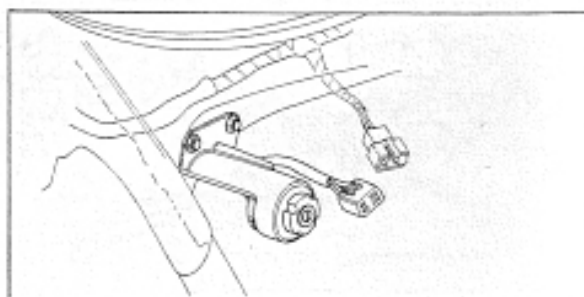


Fig. 5-34 Checking main switch

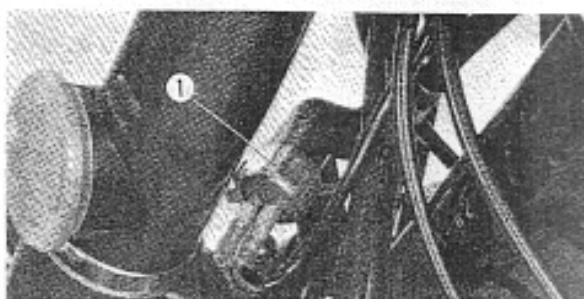


Fig. 5-35 ① Front stop switch

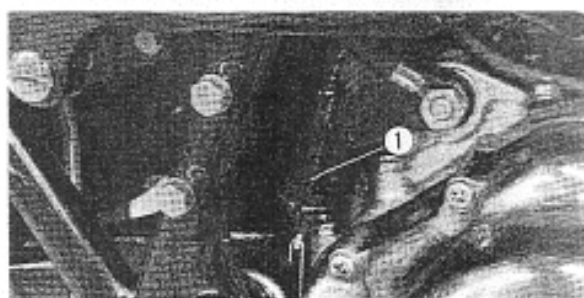


Fig. 5-36 ① Rear stop switch

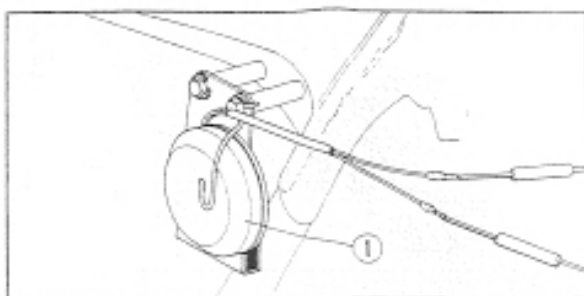


Fig. 5-37 ① Horn

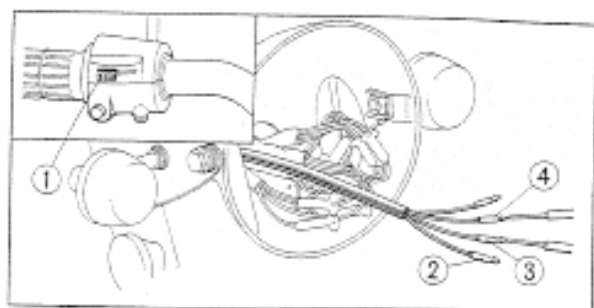


Fig. 5-38 ① Turn signal control switch
② Light blue cord
③ Gray cord
④ Orange cord

Turn signal control switch

Disconnect the cord of the turn signal control switch in the head light case. Check for continuity between the terminals of the gray cord and orange cord (left turn signal) and between those of the gray cord and light blue cord (right turn signal). The switch is in good condition if there is continuity in the circuits (○—○) shown below:

Knob Position	Cord color		
	Light blue	Gray	Orange
R	○—○	○—○	
OFF			
L		○—○	○—○

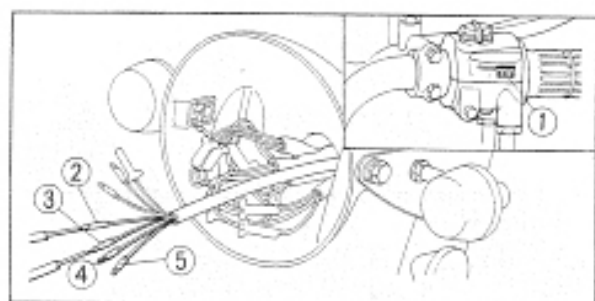


Fig. 5-39 ① Headlight control switch
② Black cord ④ Brown, white cord
③ Blue cord ⑤ White cord

Head light control switch

Check for continuity between the respective terminals of the switch cords in the head light case.

The switch is in good condition if there is continuity in the circuits (○—○) with the switch selector knob set in each position.

Any continuity in other circuits shown below is the symptom of malfunction of the switch.

Cord color	IG	HB	TL	LB
	Black	Blue	Brown/white	White
ON	H	○—○	○—○	
	N	○—○	○—○	○—○
	L	○—○	○—○	○—○

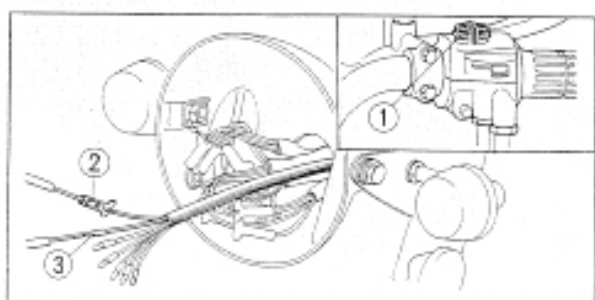


Fig. 5-40 ① Emergency switch
② Black cord ③ White cord

Emergency switch and starter switch

Check for continuity between the respective terminals of the switch cords in the head light case. The switch is normal if there is continuity as specified below (○—○) with the switch selector knob set in each position. Any continuity in other circuits shown below indicates malfunction of the switch.

Emergency switch

Cord color	Black	Black/white
RUN	○—○	○—○
OFF		

Starter switch

Cord color	Yellow/red	Body grounding
ON	○—○	○—○
OFF		

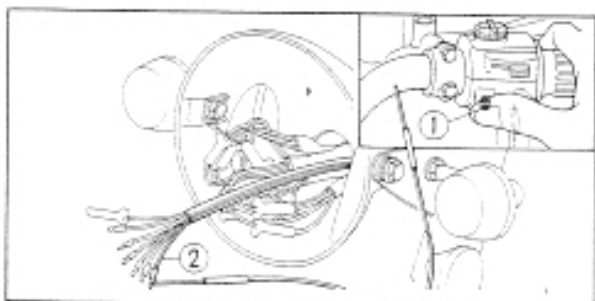


Fig. 5-41 ① Starter switch
② Yellow, red cord

Horn button

Check for continuity making contact the tester lead probes respectively on the terminal of the light green cord in the head light case and on the handlebar with the horn button pushed. If there is continuity, the horn button is normal.

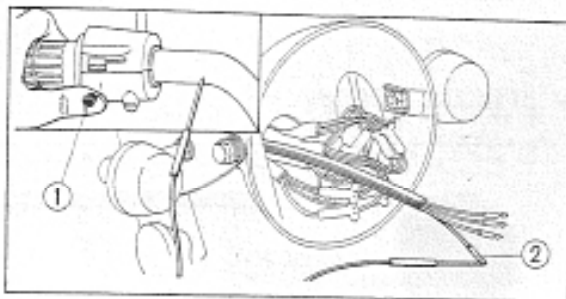


Fig. 5-42 ① Horn button
② Light green cord

Oil pressure control switch

The oil pump supplies lubricating oil to the engine under a pressure of 4.5 kg/cm^2 (64 lb/in^2). When the oil pressure drops below 0.3 kg/cm^2 (4.3 lb/in^2), the oil pressure control switch operates and the warning lamp comes on, indicating the oil supply is insufficient. Check the oil pressure control switch located on the oil pump for continuity. The switch is normal if there is continuity. The oil pressure pilot lamp will come on when the main switch is turned on and should go out after the engine is started.

If the pilot lamp remains on with the engine started, and the pressure control switch in good condition, the cause of trouble is suspected in the hydraulic system. Locate and correct the trouble with the engine stopped.



Fig. 5-43 ① Oil pressure control switch

Neutral switch

The neutral switch is located on the left side of the crankcase. With the transmission gears in neutral, the neutral switch is grounded and the neutral pilot lamp comes on.

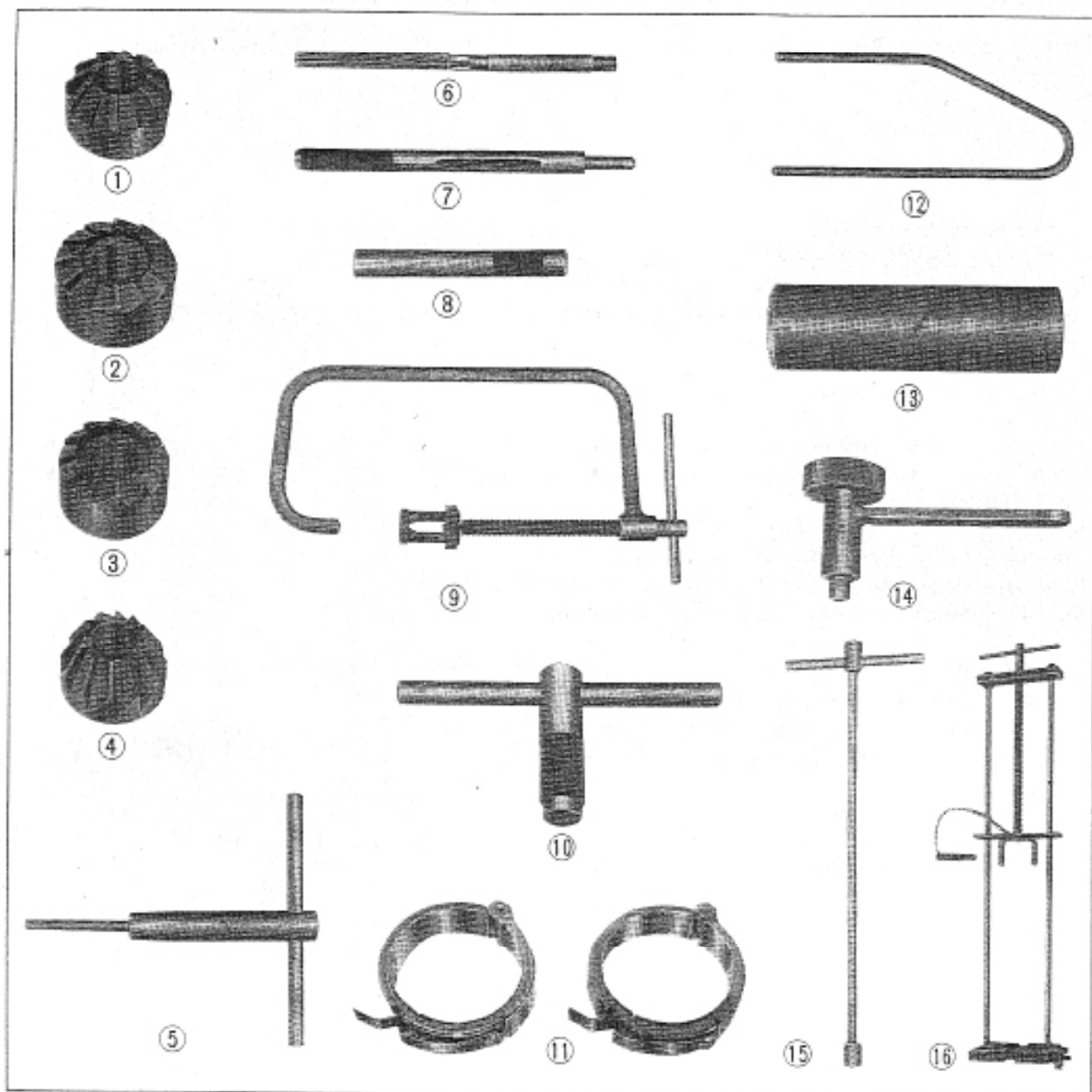
Place the transmission gears in neutral and remove the left crankcase cover. Check the neutral switch for continuity. The switch is normal if there is continuity.



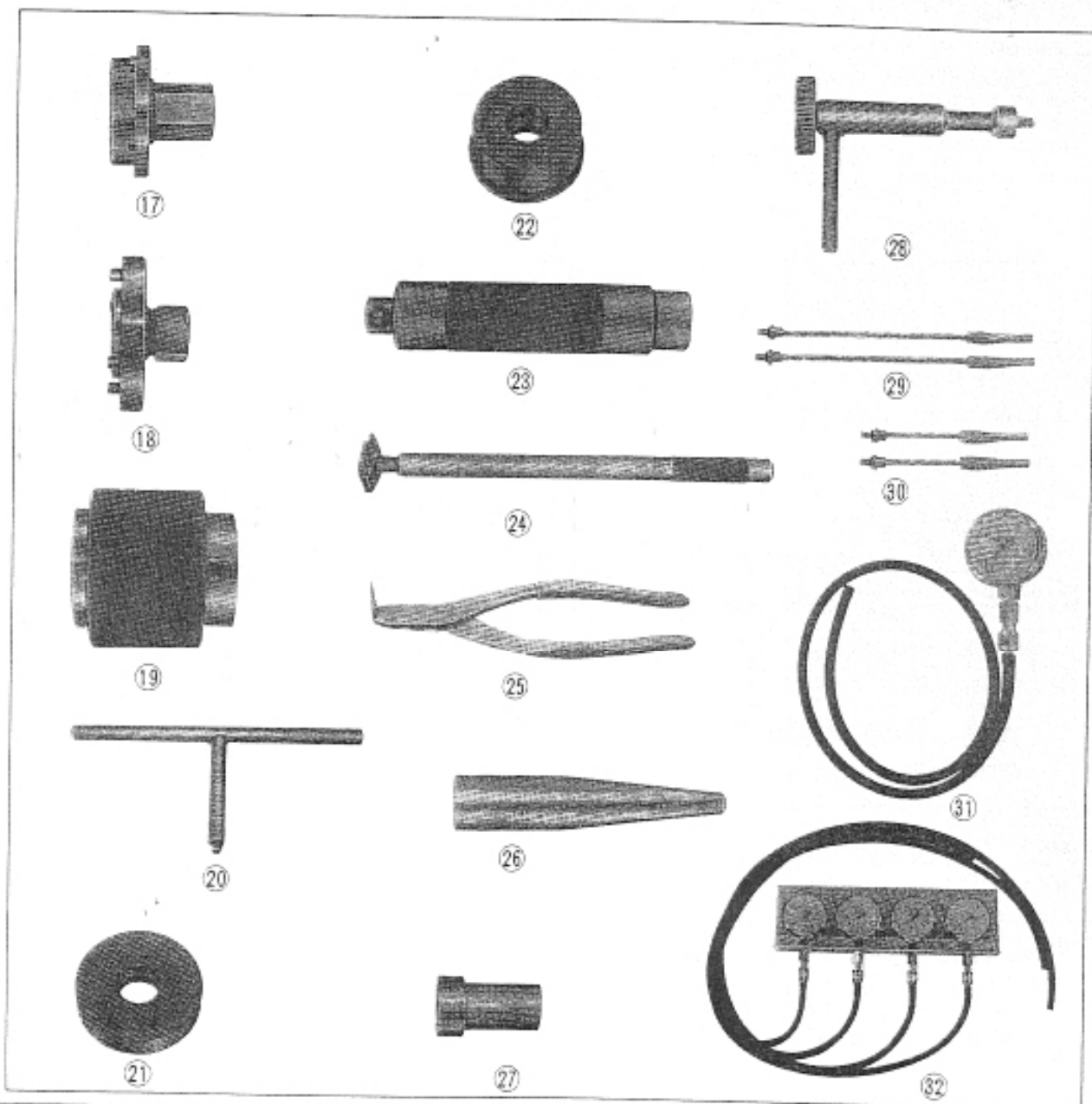
Fig. 5-44 ① Neutral switch

VI. SERVICE DATA

I. SPECIAL TOOLS



Ref. No.	Tool No.	Description	Ref. No.	Tool No.	Description
	07000-33300	CB 350 F Special tool set	⑧	07047-32901	Valve guide driver
	07000-33305	Valve seat cutter set (include No. 1-No. 8)	⑨	07031-32901	Valve lifter
①	07001-09802	Valve seat 90° cutter	⑩	07011-33301	Generator rotor puller
②	07003-09802	Intake valve seat flat cutter	⑪	07032-33301	Piston ring compressor (4 pcs)
③	07004-09802	Exhaust valve seat flat cutter	⑫	07033-33301	Piston base (4 pcs)
④	07006-09802	Valve seat interior cutter	⑬	07048-33305	Ball bearing attachment
⑤	07007-20001	Valve seat cutter holder	⑭	07081-00110	Tappet wrench set
⑥	07008-20002	Valve guide reamer	⑮	07078-32302	Box wrench 12 mm
⑦	07046-32901	Valve guide remover	⑯	07035-32901	Rear suspension service tool



Ref. No.	Tool No.	Description	Ref. No.	Tool No.	Description
Ⓐ	07088-32301	Front wheel retainer wrench	Ⓐ	07043-32305	Master piston slider
Ⓑ	07088-32901	Rear wheel retainer wrench		OPTION	
Ⓒ	07054-33301	Front fork oil seal driver	Ⓑ	07057-32302	Carburetor synchronization wrench
Ⓓ	07085-32301	Hollow set wrench 6 mm	Ⓒ	07068-30007	Vacuum gauge attachment A
Ⓔ	07048-33301	Bearing driver attachment	Ⓓ	07068-30012	Vacuum gauge attachment B
Ⓚ	07048-33310	Ball race driver attachment	Ⓔ	07064-30012	Vacuum gauge
Ⓛ	07048-61101	Driver handle	Ⓚ	07064-30001	Vacuum gauge set
Ⓜ	07048-33315	Ball race remover			
Ⓝ	07073-32301	Snap ring pliers			
Ⓟ	07043-32301	Piston cup guide			

2. MAINTENANCE SCHEDULE

MAINTENANCE SCHEDULE This maintenance schedule is based upon average riding conditions. Machines subjected to severe use, or ridden in unusually dusty areas, require more frequent servicing.	INITIAL SERVICE PERIOD 500 miles	REGULAR SERVICE PERIOD Perform at every indicated month or mileage interval, whichever occurs first.			
		1 month 500 miles	3 months 1,500 miles	6 months 3,000 miles	12 months 6,000 miles
Engine Oil—change.	●		○		
Oil Filter Element—replace.	●			○	
Oil Filter Screen—clean.					○
Spark Plug—clean and adjust gap.				○	
*Contact Points—check, and adjust gap.	●			○	
*Ignition Timing—check, and adjust if necessary.	●			○	
*Valve Tappet Clearance—check, and adjust if necessary.	●			○	
*Cam Chain Tension—adjust.	●			○	
Air Cleaner—clean.		(Clean more frequently if operated in dusty areas)		○	
Air Cleaner—replace.					○
Carburetors—check, and adjust if necessary.	●			○	
Throttle Operation—inspect cables, check, and adjust free play.	●			○	
Fuel Cock Filter Screen—clean.				○	
Fuel Lines—check.				○	
*Clutch—check operation, and adjust if necessary.	●			○	
Drive Chain—check, lubricate, and adjust if necessary.	●	○			
Brake Fluid Level—check, and add fluid if necessary.	●			○	
*Brake Shoes/Pads—inspect, and replace if worn.				○	
Brake Control Linkage—check linkage, and adjust free play if necessary.	●			○	
*Wheel Rims and Spokes—check. Tighten spokes and true wheels, if necessary.	●			○	
Tires—inspect and check air pressure.	●		○		
Front Fork Oil—drain and refill.	●				○
Front and Rear Suspension—check operation.	●			○	
Rear Fork Bushing—grease.				○	
*Steering Head Bearings—adjust.					○
Battery—check electrolyte level, and add water if necessary.	●		○		
Lighting Equipment—check and adjust if necessary.	●	○			
All Nuts, Bolts, and Fasteners—check security and tighten if necessary.	●	○			

Items marked * should be serviced by an authorized Honda dealer, unless the owner has proper tools and is mechanically proficient. All other maintenance items are simple to perform and may be serviced by the owner.



3. TORQUE SPECIFICATIONS

ENGINE

Tightening point	Thread dia. (mm)	Torque	
		kg-cm	lbs-ft
Crankcase and crankcase covers	6, P1.0	70-110	5.1-8.0
Cylinder head	8, P1.25	200 (Apply oil to the nuts before tightening)	14.5
Carburetor insulator-to-cylinder head	6, P1.0	70-110	5.1-8.0
Cam sprocket	7, P1.0	160-200	11.6-14.5
A-C generator rotor	10, P1.25	300-400	21.7-29.0
Primary drive gear	12, P1.25	300-400	21.7-29.0
Tappet adjusting nut	5, P0.5	70-110	5.1-8.0
Upper and lower crankcases	8, P1.25	220-260	15.2-18.9
Cylinder head cover	6, P1.0	70-110	5.1-8.0

FRAME

Tightening point	Thread dia. (mm)	Torque	
		kg-cm	lbs-ft
Steering stem nut	24, P1.0	800-1,200	57.9-86.9
Fork top bridge to front forks	8, P1.25	180-230	13.1-16.7
Handlebar holder	8, P1.25	180-230	13.1-16.7
Front fork bottom bridge to front forks	8, P1.25	180-230	13.1-16.7
Spokes	—		
Front wheel	—	25-30	1.9-2.2
Rear wheel	—	20-25	1.5-1.9
Rear fork pivot bolt	14, P1.5	550-700	39.8-50.7
Front wheel axle nut	12, P1.5	450-550	32.6-39.8
Front fork axle holder	8, P1.25	180-230	13.1-16.7
Engine hanger bolt	10, P1.25	300-400	21.7-29.0
Rear wheel axle nut	16, P1.5	800-1,000	57.9-72.4
Final driven sprocket	10, P1.25	300-400	21.7-29.0
Brake arm	6, P1.0	80-100	5.9-7.3
Front and rear brake torque links	8, P1.25	180-230	13.1-16.7
Rear suspension	10, P1.25	300-400	21.7-29.0
Step bar	12, P1.25	450-550	32.6-39.8
Gear change pedal and kick arm	6, P1.0	80-100	5.9-7.3
Seat band	6, P1.0	80-100	5.9-7.3



4. SERVICE DATA

ENGINE

Unit: mm (in.)

Item	Assembly standard	Service limit
Rocker arm-to-rocker arm shaft clearance	0.016-0.052 (0.0006-0.0020)	0.1 (0.0039)
Cam height of camshaft		
Intake	28.185-28.225 (1.1096-1.1112)	28.0 (1.1024)
Exhaust	28.184-28.224 (1.1096-1.1111)	28.0 (1.1024)
Camshaft center journal runout	—	0.1 (0.0039)
Valve seat width	0.7 (0.03)	1.5 (0.06)
Valve stem O. D.		
Intake	5.48-5.49 (0.2158-0.2161)	5.35 (0.2106)
Exhaust	5.46-5.47 (0.2150-0.2154)	5.35 (0.2106)
Valve-to-valve guide clearance		
Intake	0.01-0.03 (0.0004-0.0012)	0.3 (0.0118)
Exhaust	0.03-0.05 (0.0012-0.0020)	0.3 (0.0118)
Valve spring preload		
Inner	19.2/13.0-14.6 kg (0.7559/28.665-32.1930 lbs)	—
Outer	23.7/32.0-32.4 kg (0.9330/70.560-71.4420 lbs)	—
Valve spring free length		
Inner	29.0 (1.1417)	27.0 (1.0630)
Outer	34.5 (1.3583)	32.5 (1.2795)
Cylinder head flatness	—	0.3 (0.0118)
Cylinder I. D.	47.00-47.01 (1.8504-1.8508)	47.1 (1.8543)
Piston skirt O. D.	46.97-46.99 (1.8492-1.8500)	46.85 (1.8445)
Piston pin hole I. D.	13.002-13.008 (0.5119-0.5121)	13.05 (0.5138)
Piston pin O. D.	12.994-13.00 (0.5116-0.5118)	12.9 (0.5079)
Piston ring-to-piston ring groove clearance		
Top ring	0.03-0.055 (0.0012-0.0022)	0.15 (0.0059)
Second ring	0.015-0.045 (0.0006-0.0018)	0.15 (0.0059)
Oil ring	0.015 (0.0006)	0.15 (0.0059)
Piston ring end gap		
Top ring	0.1-0.3 (0.0039-0.0118)	0.7 (0.0276)
Second ring	0.1-0.3 (0.0039-0.0118)	0.7 (0.0276)
Oil ring	0.1-0.3 (0.0039-0.0118)	0.7 (0.0276)
Outer rotor O. D.-to-pump body clearance		
Main pump	0.06-0.12 (0.0024-0.0047)	0.35 (0.0138)
Auxiliary pump	0.15-0.20 (0.0059-0.0079)	0.35 (0.0138)
Outer rotor-to-inner rotor clearance		
Main pump	0.15 (0.0059), max.	0.3 (0.0118)
Auxiliary pump	0.15 (0.0059), max.	0.3 (0.0118)
Friction disc thickness	2.62-2.78 (0.1032-0.1095)	2.3 (0.0906)
Clutch plate surface warpage	0.1 (0.0039), max.	0.2 (0.0079)
Clutch spring preload	25.0/19.3-20.7 kg (0.9842/42.557-45.643 lbs)	—
Clutch spring free length	35.5 (1.3976)	34.0 (1.3386)

Unit: mm (In.)

Item	Assembly standard	Service limit
Clutch center-to-clutch plate B clearance	0.1-0.5 (0.004-0.02)	Beyond assembly standard
Gear shift fork finger width	5.93-6.00 (0.2335-0.2362)	5.5 (0.2165)
Gear shift guide shaft O. D.	12.957-12.984 (0.5101-0.5112)	12.9 (0.5079)
Gear shift fork I. D.	13.000-13.018 (0.5118-0.5125)	12.95 (0.5098)
Kick starter pinion-to-shaft clearance	0.04-0.082 (0.0016-0.0032)	0.1 (0.004)
Gear shift fork dowel-to-drum groove clearance	0.05-0.22 (0.0020-0.0087)	0.3 (0.0118)
Transmission gear backlash		
1st and 2nd	0.044-0.134 (0.0017-0.0053)	0.2 (0.0079)
3rd, 4th and 5th	0.046-0.142 (0.0018-0.0056)	0.2 (0.0079)
Transmission gear-to-shaft clearance		
C-1	0.04-0.074 (0.0016-0.0029)	0.2 (0.0079)
Other gears	0.04-0.081 (0.0016-0.0032)	0.2 (0.0079)
Cam chain tensioner slipper thickness (center)	4.0 (0.1575)	3.0 (0.118) max.
Cam chain guide thickness	6.1-6.3 (0.2402-0.2480)	5.0 (0.197)
Crankshaft runout (center) ¹	0.03 (0.0012), max.	0.05 (0.0020)
Crankshaft journal clearance	0.018-0.048 (0.0007-0.0019)	0.08 (0.0032)
Connecting rod small end I. D.	13.012-13.033 (0.5123-0.5131)	13.10 (0.5158)
Connecting rod big end side clearance	0.02-0.07 (0.0008-0.0028)	0.15 (0.0059)
Connecting rod big end-to-crankshaft journal clearance	0.018-0.048 (0.0007-0.0019)	0.08 (0.0032)
Primary chain guide thickness (center)	6.0-6.3 (0.236-0.248)	5.0 (0.197)



FRAME

Unit: mm (in.)

Item	Assembly standard	Service limit
Brake disc face runout	0.3 (0.0118), max.	0.3 (0.0118), min.
Brake disc thickness	6.9-7.1 (0.2717-0.2795)	—
Wheel rim face runout	0.5 (0.0197), max.	2.0 (0.079)
Wheel bearing end play	0.07 (0.0028), max.	0.1 (0.0039)
Wheel bearing radial play	0.03 (0.0012), max.	0.05 (0.0020)
Front axle runout	0.01 (0.0004)	0.2 (0.0079)
Caliper cylinder I. D.	38.18-38.20 (1.5032-1.5039)	38.215 (1.5045)
Caliper piston O. D.	38.115-38.480 (1.5006-1.5150)	38.105 (1.5002)
Master cylinder I. D.	14.00-14.043 (0.5512-0.5529)	14.055 (0.5533)
Master cylinder piston O. D.	13.957-13.984 (0.5495-0.5505)	13.940 (0.5488)
Rear axle runout	0.01 (0.0004)	0.2 (0.0079)
Rear brake lining thickness	4.9-5.0 (0.1929-0.1969)	2.5 (0.0984)
Rear brake drum I. D.	160.0-160.3 (6.2992-6.3110)	161 (6.3386)
Front suspension spring preload	389.2/26.4 kg (15.3229/58.212 lbs)	—
Front suspension spring free length	426.5 (16.7917)	416 (16.378)
Rear suspension spring free length	195.8 (7.7087)	190 (7.480)
Rear fork pivot bushing-to-center collar clearance	0.1-0.3 (0.0039-0.0118)	0.5 (0.02)
Rear fork bushing I. D.	21.5-21.552 (0.8465-0.8485)	21.70 (0.8543)
Center collar O. D.	21.427-21.460 (0.8436-0.8449)	21.35 (0.8406)
Front fork bottom case I. D.	33.000-33.039 (1.2992-1.3007)	33.18 (1.3063)
Front fork bottom piston O. D.	32.925-32.950 (1.2963-1.2973)	32.875 (1.2944)



5. TROUBLE SHOOTING

ENGINE

Trouble	Probable Cause	Remedies
Engine does not start	<ol style="list-style-type: none"> Excessive wear of piston ring or cylinder. Seized valve in valve guide. Seized piston. Faulty valve timing. Low or lack of compression pressure. <ul style="list-style-type: none"> Pressure leak Blown out cylinder head gasket. Warped gasketing surface of the cylinder and cylinder head. 	Replace. Replace. Replace. Adjust. Lap the valve to obtain good valve seating or replace. Replace. Repair or replace.
Poor engine idling	<ol style="list-style-type: none"> Incorrect tappet clearance. Low or lack of compression pressure. Excessive valve guide clearance. 	Adjust to standard value. Repair. Replace valve and guide.
Loss of power	<ol style="list-style-type: none"> Valve sticking open. Incorrect seating of valve. Weak or broken valve spring. Faulty valve timing. Blown out cylinder head gasket. Excessive wear of cylinder and piston. Worn, weak or broken piston ring. Loose spark plug. 	Replace. Lap valve. Replace. Check valve timing and adjust if necessary. Replace. Replace. Replace. Retighten.
Overheating	<ol style="list-style-type: none"> Heavy carbon deposit on combustion chamber and piston head. Lean fuel mixture. Retarded ignition timing. Low oil level, poor quality. Extended operation in low gear. 	Remove carbon. Adjust the carburetor. Adjust ignition timing. Add good grade oil.
Backfire	<ol style="list-style-type: none"> Incorrect seating of inlet valve. Faulty valve timing. Incorrect ignition timing. Excessive spark plug gap. Improper fuel. 	Check the valve seating. Adjust. Adjust. Adjust the gap to 0.024~0.028 in. (0.6~0.7 mm). Use good quality fuel.
White exhaust smoke	<ol style="list-style-type: none"> Excessive wear of cylinder and piston. Overfilled engine oil. Excessively high oil pressure. Poor quality oil. 	Replace the piston. Adjust the oil level. Check the breather. Replace with good quality oil.
Black exhaust smoke	<ol style="list-style-type: none"> Rich fuel mixture. 	Adjust the carburetor.
Difficult gear shifting	<ol style="list-style-type: none"> Improper clutch disengagement. Damaged gear or foreign object lodged in the gear. Gear shift fork¹ inoperative. Incorrect operation of the gear shift drum stopper and change pedal. Mainshaft and countershaft out of alignment. High oil viscosity. 	Adjust the clutch. Replace the defective parts. Repair or replace. Repair or replace. Repair or replace. Change the oil.
Excessive high gear noise	<ol style="list-style-type: none"> Excessive gear backlash. Worn main and countershaft bearing. 	Repair or replace. Repair or replace.



Trouble	Probable Cause	Remedies
Gear slip out	<ol style="list-style-type: none"> 1. Worn fingers on gear shift fork. 2. Worn gear dog hole. 3. Worn spline. 	Replace. Replace. Replace.
Clutch slippage	<ol style="list-style-type: none"> 1. No play in the clutch lever. 2. Weak or none uniform clutch spring. 3. Worn or grazed friction disc. 	Adjust the clutch. Replace the weak spring. Replace.
Poor clutch engagement	<ol style="list-style-type: none"> 1. Excessive play of clutch lever. 2. Warped friction disc. 3. Warped pressure plate. 4. Bent main shaft. 	Adjust clutch lever play. Replace. Replace. Replace.
Pedal does not return	<ol style="list-style-type: none"> 1. Faulty return spring. 2. Unhook return spring. 	Replace. Hook return spring.
Kick starter gear does not rotate	<ol style="list-style-type: none"> 1. Excessive wear of kick starter pawl. 	Replace.
Engine does not start	Carburetor <ol style="list-style-type: none"> 1. Choke fully open. 2. Carburetor air screw improperly set. 3. Air leaking into the cylinder head. 4. Clogged carburetor slow jet. 5. Clogged fuel valve or piping. 6. Clogged vent hole in the fuel tank cap. 7. No fuel in the tank. 	Close choke. Adjust air screw. Retighten carburetor connecting tube. Check, clean and retighten. Disassemble and clean. Disassemble and clean. Fill tank with gasoline.
Poor engine idling	Carburetor <ol style="list-style-type: none"> 1. Clogged or loose carburetor slow jet. 2. Improper float level. 3. Incorrect air screw adjustment. 4. Carburetor linkage malfunction. 5. Air leaks. 	Check, clean and retighten. Adjust. Adjust. Adjust. Tighten all air passage connection.
Improper running of engine	Carburetor <ol style="list-style-type: none"> 1. Jet size too small. 2. Improper float level. 3. Clogged carburetor main jet. 4. Carburetor linkage malfunction. 5. Air leaks. 	Replace with larger size jet. Adjust. Clean and retighten. Adjust. Tighten all air passage connection.

CHASSIS

Trouble	Probable Cause	Remedies
Heavy steering	1. Steering stem excessively tightened. 2. Damaged steering stem steel balls. 3. Bent steering. 4. Low front tire pressure.	Loosen the steering stem nut. Replace. Replace. Add air to the specified pressure of 1.8 kg/cm ² (26 psi).
Front and rear wheel wobble	1. Loose steering stem mounting bolt. 2. Worn front and rear wheel bearings. 3. Front or rear wheel runout or distorted. 4. Loose spoke. 5. Defective tire.	Retorque. Replace bearing. Repair or replace. Retorque. Replace.
Soft suspension	1. Loss of spring tension. 2. Excessive load.	Replace.
Hard suspension	1. Ineffective front fork damper. 2. Ineffective rear damper.	Repair. Replace.
Suspension noise	1. Front case or rear damper rubbing. 2. Interference between cushion case and spring. 3. Faulty fork stopper rubber. 4. Insufficient front fork oil.	Inspect cushion spring and case. Repair or replace. Replace. Add ATF.
Defective brake	1. Front brake. <ul style="list-style-type: none"> - Insufficient brake fluid. - Air in the brake system. - Worn brake pad. - Worn piston. - Worn or distorted brake disc. - Brake lever out of adjustment. 2. Rear brake. <ul style="list-style-type: none"> - Worn brake lining. - Worn brake shoe or poor contacts. - Worn brake cam. - Wet brake from water or oil. - Worn brake shaft. - Brake pedal out of adjustment. 	Add brake fluid. Bleed brake system. Replace pad. Replace piston. Replace disc. Readjust. Replace. Replace. Replace. Clean. Replace. Readjust.

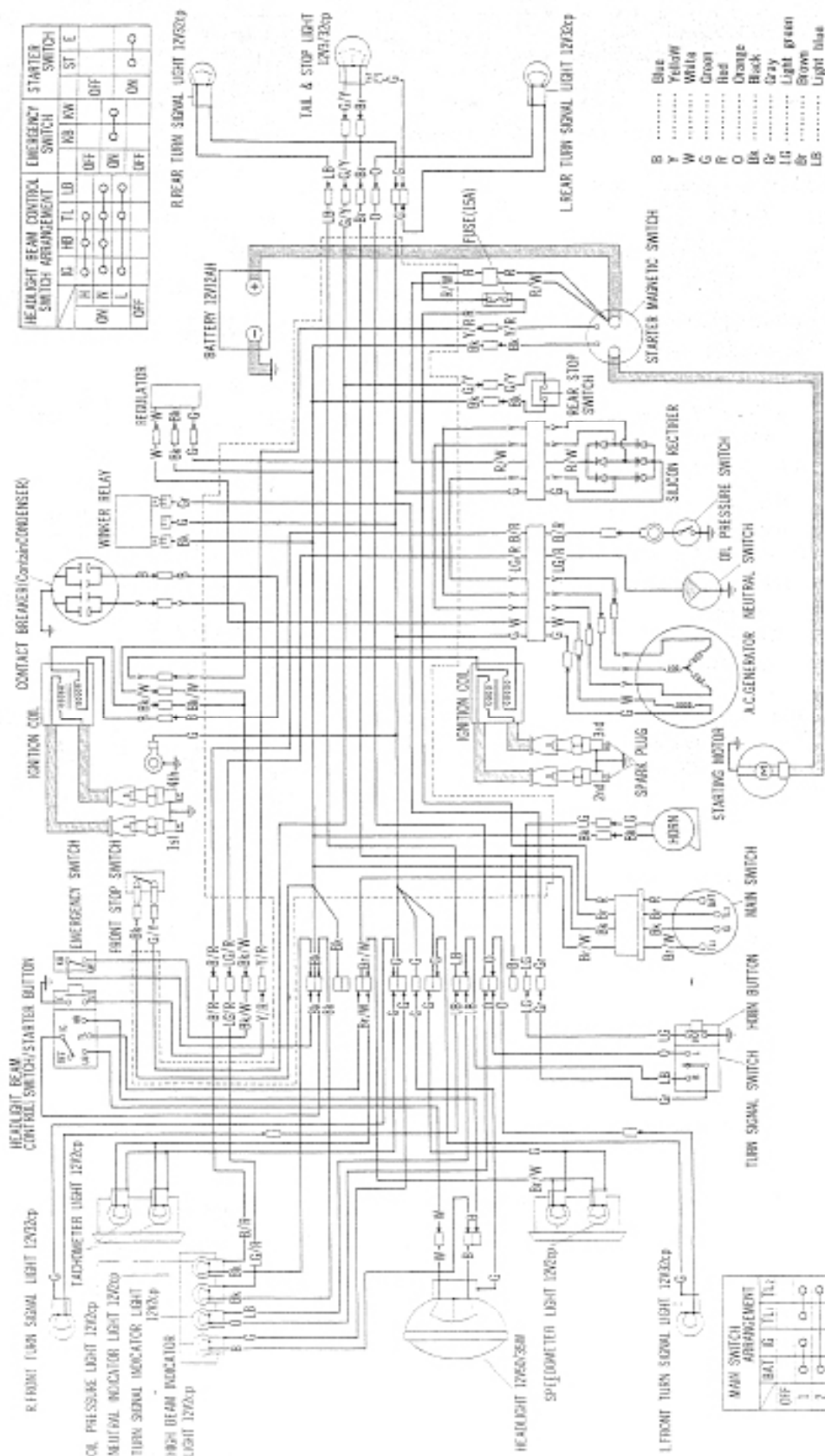


ELECTRICAL

Troubles	Probable Causes	Remedies
Engine does not Start	<ol style="list-style-type: none"> Battery <ul style="list-style-type: none"> Discharged. Poor contact of battery terminals. Main switch <ul style="list-style-type: none"> Open or shorted circuit, disconnected connections. Poor contact between main switch wire and wire harness. Ignition coil <ul style="list-style-type: none"> Improperly insulated high tension coil. Open or shorted circuit in ignition coil. Contact breaker <ul style="list-style-type: none"> Open circuit in the primary coil. Dirty ground point with oil or dust. Point gap out of adjustment. Improperly charged condenser. 	Recharge or replace. Repair. Repair. Repair. Replace. Replace. Repair. Clean. Readjust. Replace.
Starting motor does not operate	<ol style="list-style-type: none"> Defective battery. Poor contact of magnetic switch. Poor contact of starting motor carbon brush. 	Charge or replace. Repair or replace. Repair or replace.
Horn inoperative, poor sound or too weak sound	<ol style="list-style-type: none"> Horn <ul style="list-style-type: none"> Cracked diaphragm. Horn button. <ul style="list-style-type: none"> Poor grounding. Wiring <ul style="list-style-type: none"> Poor contact. Adjusting screw <ul style="list-style-type: none"> Out of adjustment. 	Replace. Repair. Repair. Readjust.
Taillight and headlight inoperative	<ol style="list-style-type: none"> Fuse <ul style="list-style-type: none"> Blown fuse or burnt bulb filament. Bulb <ul style="list-style-type: none"> Burnt bulb filament. Switch <ul style="list-style-type: none"> Poor contact of lighting switch. Wiring 	Replace. Replace. Repair.
Stop light inoperative	<ol style="list-style-type: none"> Bulb <ul style="list-style-type: none"> Burnt or broken bulb filament. Front and tail stop light switch <ul style="list-style-type: none"> Malfunction of switch. Wiring <ul style="list-style-type: none"> Poor contact of leads. 	Replace. Readjust. Repair.
Winker lamp blinks too fast or too slow	<ol style="list-style-type: none"> Bulb <ul style="list-style-type: none"> Blinks unusually fast: improperly connected relay. Wiring <ul style="list-style-type: none"> Blinks too fast: bulb with unsuitable wattage. Blinks too slow: burnt or broken bulb filament. Defective relay 	Replace. Replace. Replace. Replace.

Troubles	Probable Causes	Remedies
Winker lamp operative	1. Winker lamp switch - Poor contact of winker relay. - Open circuit in winker relay coil. 2. Bulb - Bulb wattage is smaller than rated wattage. 3. Relay - Poor contact of winker relay. - Improperly connected lead.	Replace. Replace. Replace. Replace. Replace.
No charging	1. Broken wire or shorted, loose connection. 2. Faulty coil due to short or grounding. 3. Faulty or shorted silicon diode. 4. Broken or shorted lead wire at regulator. 5. Regulator voltage at no load is too low.	Repair or replace. Replace. Replace. Repair or replace. Readjust.
Insufficient charging	1. Wiring - Broken wire, intermittent shorting or loose connection. 2. Generator - Shorting across layer in the field coil. (resistance indicated in continuity test) - Shorting across layer in stator coil. - Open circuit in one of the stator coil. - Faulty or shorted silicon diode. 3. Regulator - Voltage below specified value at no load. - Dirty or pitted points. - Coil or resistor internally shorted. 4. Battery - Low electrolyte level. - Defective battery plates.	Repair. Replace. Replace. Replace. Readjust. Polish or replace. Replace. Add distilled water. Replace.
Excessive charging	1. Wiring P terminal circuit and F terminal circuit shorted resulting in split wound generator. 2. Battery Internal short. 3. Regulator - Excessive voltage at no load voltage. - Improper grounding. - Broken coil lead wire.	Repair. Replace. Repair. Provide proper ground. Repair or replace.
Unstable charging voltage	1. Wiring - Bare wire shorting intermittently under vibration or broken wire making partial contact. 2. Generator - Layer short (intermittent shorting). 3. Generator - Intermittent open circuit in the coil. - Improperly adjusted voltage. - Defective main switch. - Dirty points.	Repair or replace. Repair or replace. Repair or replace. Readjust. Replace. Clean.

6. WIRING DIAGRAM





7. SPECIFICATION

	Item	Metric	English	
Dimension	Overall length	2,060 mm	81.1 in.	
	Overall width	780 mm	30.7 in.	
	Overall height	1,090 mm	42.9 in.	
	Wheel base	1,355 mm	53.3 in.	
	Seat height	780 mm	30.7 in.	
	Foot peg height	300 mm	11.8 in.	
	Ground clearance	155 mm	6.1 in.	
	Dry weight	170 kg	373 lbs.	
Frame	Type	Semi-double cradle		
	F. suspension, travel	Telescopic fork, Travel 114.6 mm (4.5 in.)		
	R. suspension, travel	Swing arm, Travel 91.0 mm (3.6 in.)		
	F. tire size, pressure	3.00-18 (4PR), Air pressure 1.8 kg/cm ² (26 psi)		
	R. tire size, pressure	3.50-18 (4PR), Air pressure 2.0 kg/cm ² (28 psi)		
	F. brake, lining area	Disc brake, Lining swept areas 288 cm ² (44.8 sq. in.)		
	R. brake, lining area	Internal expanding shoes, Lining swept areas 150 cm ² (23 sq. in.)		
	Fuel capacity	12 lit.	3.2 U.S.gal. 2.6 Imp.gal.	
	Fuel reserve capacity	2 lit.	0.5 U.S.gal. 0.4 Imp.gal.	
	Caster angle	63°40'		
	Trail length	85 mm	3.3 in.	
	Front fork oil capacity	125 cc (to fill if dry)	4.2 ozs.	
	Front fork oil capacity	105 cc (refill after draining)	3.0 ozs.	
	Engine	Type	Air cooled, 4-stroke O.H.C. engine	
Cylinder arrangement		Vertical four parallel		
Bore and stroke		47.0×50.0 mm	1.850×1.969 in.	
Displacement		347 cc	21.1 cu-in.	
Compression ratio		9.3 : 1		
Valve train		Chain driven over head camshaft		
Oil capacity		3.5 lit.	3.7 U.S.qt. 3.1 Imp.qt.	
Lubrication system		Forced and wet sump		
Cylinder head compression pressure		12 kg/cm ² (170.7 psi)		
Intake valve		Opens	At 5° (before top dead center)	
		Closes	At 35° (after bottom dead center)	
Exhaust valve		Opens	At 35° (before bottom dead center)	
		Closes	At 5° (after top dead center)	
Valve tappet clearance		IN·EX 0.05 mm	0.002 in.	
Idle speed		1,200 rpm		



	Item	Metric	English	
Carburetor	Type	Piston valve		
	Setting mark	656 c		
	Main jet	φ 75		
	Slow jet	φ 35		
	Air screw opening	$7/8 \pm 3/8$		
	Float height	21 mm	0.827 in.	
Drive train	Clutch	Wet, multi-plate type		
	Transmission	5-speed, constant mesh		
	Primary reduction	3.423		
	Gear ratio I	2.733		
	Gear ratio II	1.850		
	Gear ratio III	1.416		
	Gear ratio VI	1.148		
	Gear ratio V	0.965		
	Final reduction	2.235		
	Gear shift pattern	Left foot operated return system		
Electrical	Ignition	Battery and ignition coil		
	Starting system	Starting motor and kick starter		
	Alternator	A-C generator 0.156 kW/5,000 rpm		
	Battery capacity	12 V-12 AH		
	Spark plug	NGK D8ESL ND X24ES		
	Headlight	Low/High beam	12 V-35 W/50 W	
	Tail/stoplight	Tail/Stop	12 V-3/32 cp (SAE TRADE NO. 1157)	
	Turn signal light		12 V-32 cp (SAE TRADE NO. 1073)	
	Speedometer light		12 V-2 cp (SAE TRADE NO. 57)	
	Tachometer light		12 V-2 cp (SAE TRADE NO. 57)	
	Neutral indicator light		12 V-2 cp (SAE TRADE NO. 57)	
	Turn signal indicator light		12 V-2 cp (SAE TRADE NO. 57)	
	High beam indicator light		12 V-2 cp (SAE TRADE NO. 57)	

I. TECHNICAL FEATURE

BLOW-BY GAS CIRCULATOR

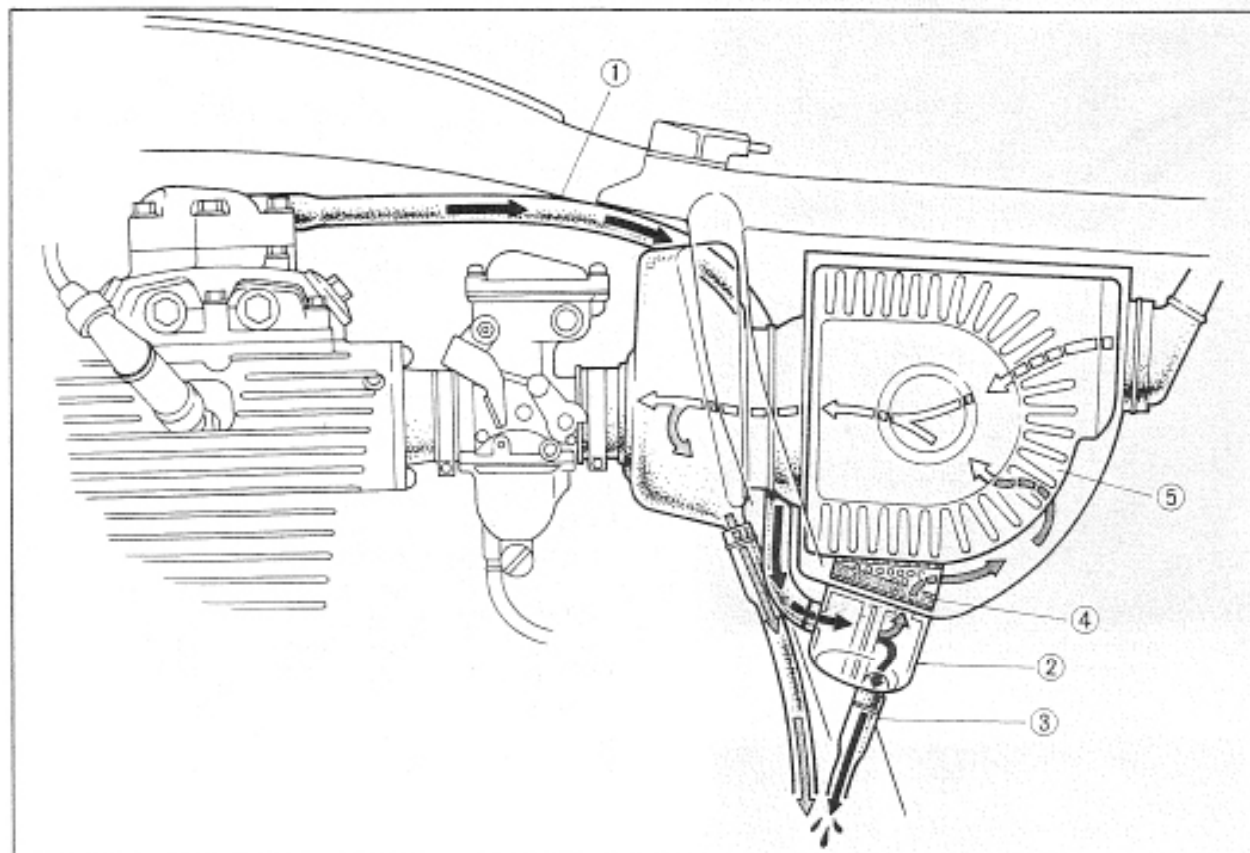


Fig. 1-1 ① Breather tube ⑤ Oil drain tube ⑥ Air cleaner element
② Breather case ④ Breather element

The blow-by gas from the inside of the cylinder head through breather tube enters the breather box, the oil is separated by the breather element and the gas is then led to the air cleaner. The gas enters the air cleaner and is filtered together with the fresh air by the air cleaner element and is then again led to the combustion chambers through the carburetors. Therefore, the blow-by gas is reduced by recombustion of the unburned gas.

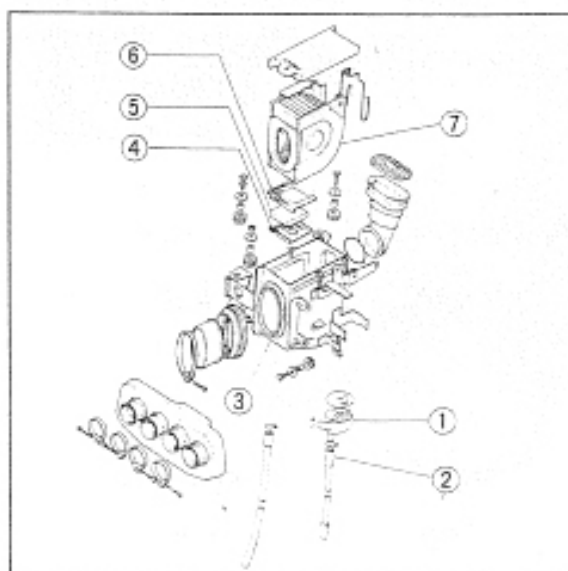


Fig. 1-2 ① Breather box
② Oil drain tube
③ Air cleaner case
④ Lower element holder
⑤ Breather element
⑥ Upper element holder
⑦ Air cleaner element

II. INSPECTION AND ADJUSTMENT

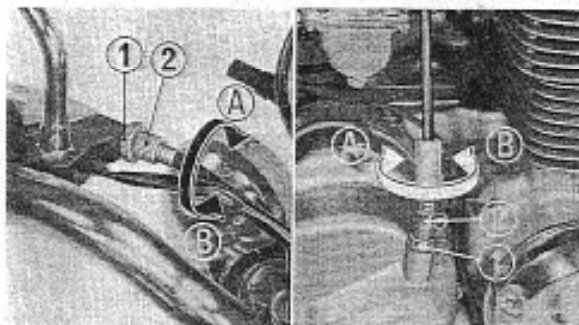


Fig. 2-1 ① Lock nut ② Clutch cable adjuster

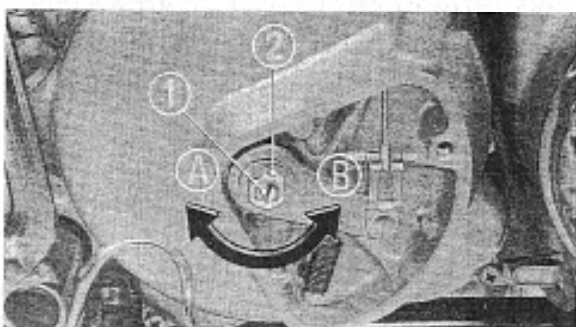


Fig. 2-2 ① Clutch adjusting screw
 ② Adjusting screw lock nut

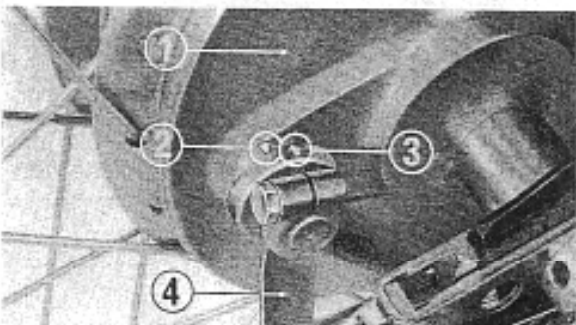


Fig. 2-3 ① Brake panel ③ Arrow
 ② Reference mark ④ Brake arm

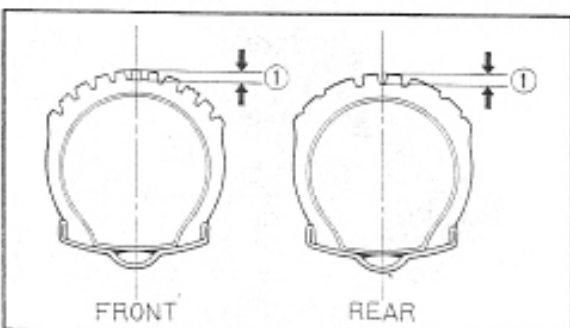


Fig. 2-4 ① Center tread depth

1. CLUTCH

1. Check the clutch lever for free play at its tip.
Standard play: 10-20 mm (0.4-0.8 in.)
2. Screw the clutch cable adjuster located at the clutch lever, all the way into (A) the clutch lever bracket.
3. Turn the clutch cable adjuster located at the clutch housing, in the direction (A) to loosen the clutch cable.
4. Remove the clutch cover. Loosen the clutch lifter adjusting screw lock nut (see Fig. 2-2), turn the clutch adjusting screw in the clockwise direction (A) until a slight resistance is felt. From this position, turn the adjusting screw in the counterclockwise direction (B) 1/4~1/2 turn. Tighten the lock nut.
5. Turn the clutch cable adjuster located at the clutch housing side of engine, in the (A) direction so that there is approximately 3/4" of free play at the end of the clutch lever, then tighten lock nut.
6. The remaining clutch lever free play is obtained by the clutch cable adjuster at the clutch lever.
7. After the adjustment has been made, check to see that the clutch is not slipping and that the clutch is properly disengaging.

After the engine starts, pull in the clutch lever and shift into gear, and make sure that the engine does not stall, and the motorcycle does not creep. Gradually release the clutch lever and open the throttle, the motorcycle should start smoothly and gradually accelerate.

2. REAR BRAKE

Brake shoes

1. Check the distance between the arrow adjacent to the brake arm and reference mark on the brake on the brake panel of full application of the brake.
2. If the arrow aligns with the reference mark on full application of the brake, replace the brake shoes and check the brake drum for wear.

3. WHEEL

Tire tread wear

Tire should be replaced when center tread depth is worn to the following limits.

Center tread depth:

Front — 1.5 mm (0.06-in.)

Rear — 2.0 mm (0.08-in.)

4. SPARK PLUG

1. Remove the spark plug cap from the spark plug. Unscrew the plug, using a spark plug wrench, and remove the spark plug from the cylinder head.
2. Check the spark plug for deposits, electrode erosion and damaged gasket. A spark plug with burned electrodes, bristered insulator or damaged gasket should be replaced with a new one. Fouled spark plug can be cleaned in spark plug cleaner or with a wire brush.
3. Using a feeler gauge, adjust the gap to the specification.

Specified plug gap: 0.7-0.8 mm (0.028-0.032-in.)

To adjust, bend the side electrode only.

4. Clean the plug seat in the cylinder head. Screw the plug into the thread hole in two steps; first, finger-tight, and then use a spark plug wrench to tighten the plug an additional 1/2 to 3/4 turn or until the sealing gasket is compressed.

5. FUEL FILTER

1. Place the fuel cock lever in the "OFF" position; disconnect the fuel tubes. Take out the fuel tank.
2. Loosen the fuel cock fixing nut and then remove the fuel cock and fuel filter from the fuel tank.

3. Check the gasket to see if it is not damaged. Replace with a new one, if found to be damaged too badly beyond use.
4. Wash the fuel filter in solvent and dry with compressed air. Any slightest damage can not be tolerated here. Also replace the filter with a new one if found to be clogged.

5. Install the fuel filter to the fuel cock with the fixing nut.

Do not forget to install the gasket into the groove of the fixing nut.

6. Install the fuel cock to the fuel tank with the fixing nut.

7. Install the fuel tank in place on the frame; connect tubes and secure with the clips.

8. Fill the tank with fuel. With the fuel cock lever in the "ON" position, check for any leakage past the tube joints or connections.

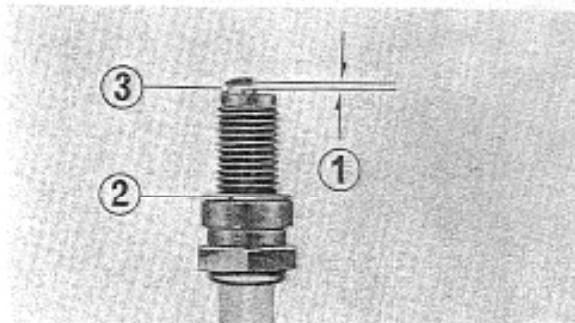


Fig. 2-5 ① Spark plug gap ③ Side electrode
② Gasket

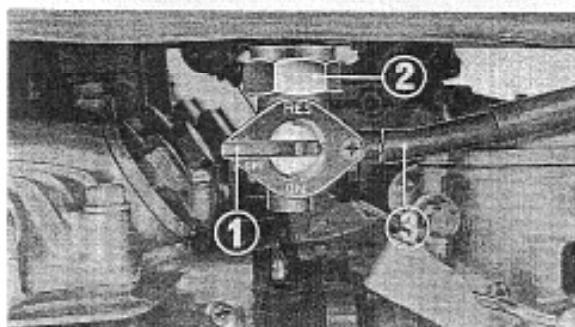


Fig. 2-6 ① Fuel cock lever ③ Fuel tube
② Fuel cock fixing nut

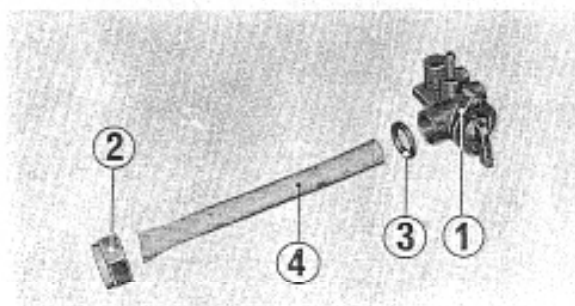


Fig. 2-7 ① Fuel cock ③ Gasket
② Fixing nut ④ Fuel filter

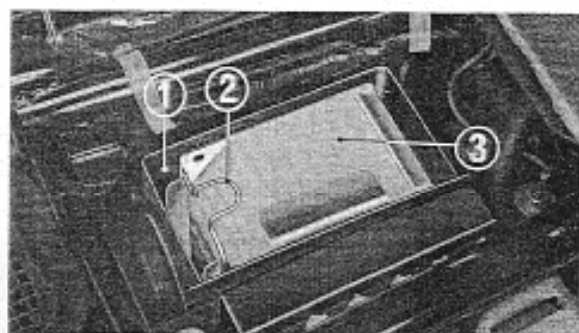


Fig. 2-8 ① Air cleaner case
② Retaining clip
③ Air cleaner element

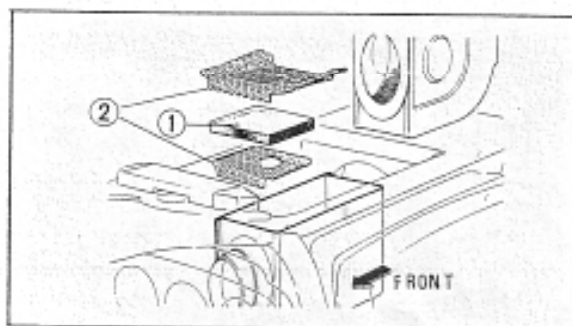


Fig. 2-9 ① Breather element ② Element holder

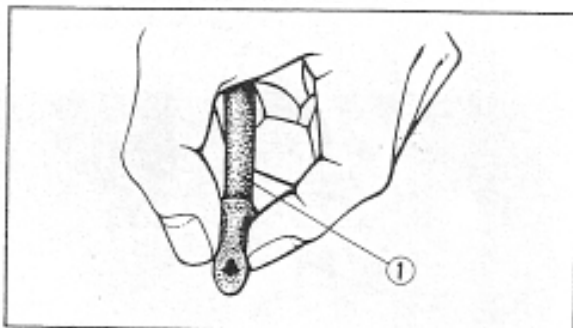


Fig. 2-10 ① Drain tube



Fig. 2-11 ① Checking front suspension

6. AIR CLEANER

1. Raise the seat and remove the tool compartment together with the air cleaner cover.
2. Lift out the air cleaner element retaining clip. Remove the air cleaner element.
3. Clean the air cleaner element by tapping it lightly to loosen dust. The remaining dust can be brushed from the outer element surface or blown away by applying compressed air from the inside of the element.

4. Remove the element holders and breather element.
5. Wash the breather element in clean solvent. Squeeze out excess solvent and then dry the element thoroughly.

WARNING:

- Gasoline or low flash point solvents are highly flammable and must not be used to clean the breather element.
- Do not use acid, alkali or organic solvent for washing the breather element.

6. Squeeze to open lower end of the drain tube, and remove any oil or water which may have accumulated.
7. To reinstall the air cleaner, reverse the removal procedures.

7. FRONT SUSPENSION

Checking

1. With the front brake applied, check the action of the shock absorbers. This can be done by jouncing the shock absorbers up and down several times by hands. Also check for leaks, twist or bends, and replace, if any, parts worn or damaged beyond repair.
2. Check the front forks and handlebar mounting bolts for looseness.



Changing front fork oil

1. Remove the drain plugs from the both forks. Grasp the handlebar and jounce up and down several times to aid in draining the remaining oil.
2. Replace the drain plugs. Place a suitable stand under the engine to raise the front wheel off the ground.

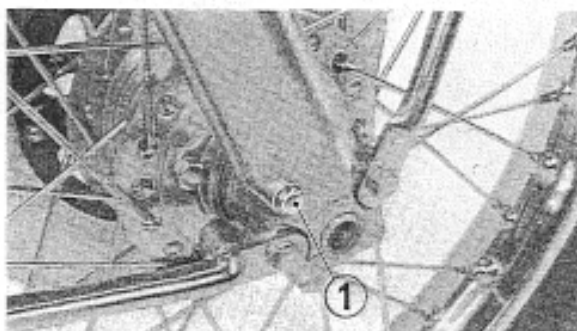


Fig. 2-12 ① Front fork drain plug

3. Remove the oil filler plugs and pour the specified amount of ATF (permanent quality automatic transmission fluid) into the holes.

Capacity: 145-150cc (4.8-4.9ozs.)

NOTE:

Specified amount of fluid will be required to fill one fork whenever disassembled.

Specified amount: 160-165cc (5.6-5.8ozs.)

4. Replace the filler plugs and remove the stand under the engine.

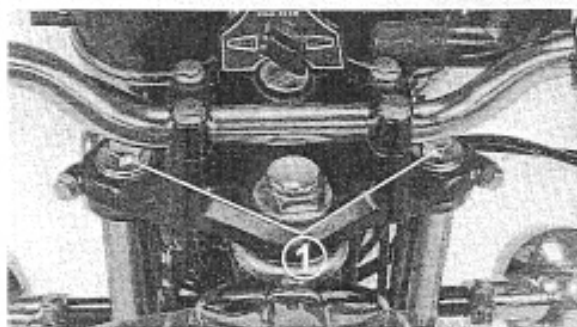


Fig. 2-13 ① Oil filler plug

8. REAR SUSPENSION

Inspection

1. Raise the rear wheel off the ground. Axially move the rear wheel in and out with force to see if the rear fork bushings are worn. If worn excessively beyond use, replace.
2. Check the suspension mountings for looseness.



Fig. 2-14 ① Rear fork ② Rear shock absorber

Rear fork Bushing Lubrication

There is a lubrication point as shown in the figure. It is recommended that lubrication be performed every 6 months or 3,000 miles whichever occurs first. Use multipurpose grease, Type NLGI No. 2. *

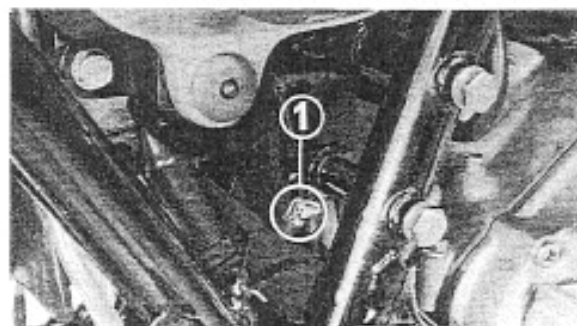


Fig. 2-15 ① Grease fitting

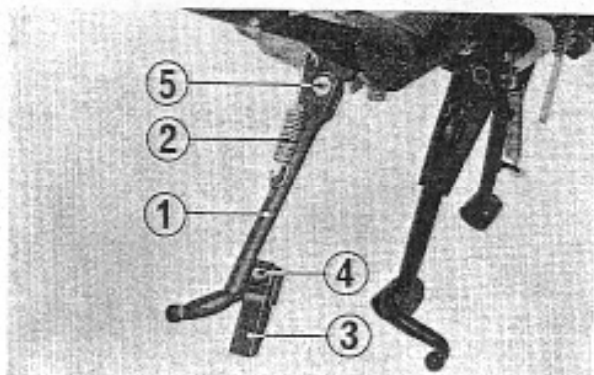


Fig. 2-16 ① Side stand bar ④ 6mm bolt
② Spring ⑤ Side stand pivot bolt
③ Rubber block

9. SIDE STAND

1. Check the entire stand assembly (side stand bar, bracket and rubber block) for installation, deformation or otherwise excessive damage.
2. Check the spring for freedom from damage or other defects.

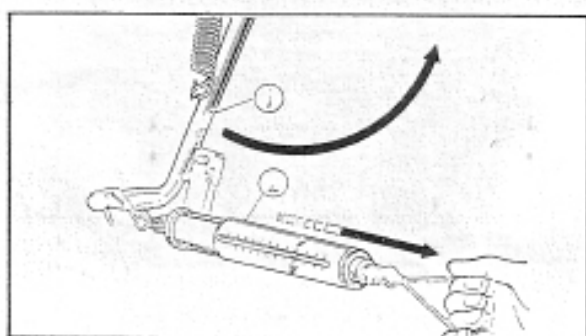


Fig. 2-17 ① Side stand bar ② Spring scale

3. Check the side stand for proper return operation:
 - a. With the side stand applied, raise the stand off the ground by using the main stand.
 - b. Attach a spring scale to the lower end of the stand and measure the force with which the stand is returned to its original position.
 - c. The stand condition is correct if the measurement falls within 2-3kg (4.4-6.6lbs.)

If the stand requires force exceeding the above limit, this might be due to neglected lubrication, overtightened side stand pivot bolt, worn stand bar or bracket, or otherwise excessive tension. Repair as necessary.

4. Check the rubber block for deterioration or wear. When the rubber block wear is excessive so that it is worn down to the wear line, replace it with a new one.

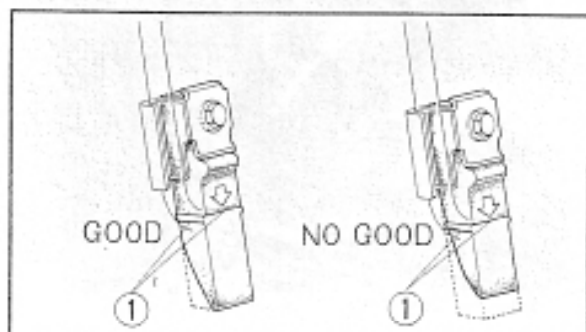


Fig. 2-18 ① Wear line

Rubber block replacement

1. Remove the 6mm bolt; separate the rubber block from the bracket at the side stand.
2. After making sure the collar is installed, put a new rubber block in place in the bracket with the arrow mark out.

NOTE:

- Use rubber block having the mark "OVER 260 lbs. ONLY"
3. Secure the rubber block with the 6mm bolt.

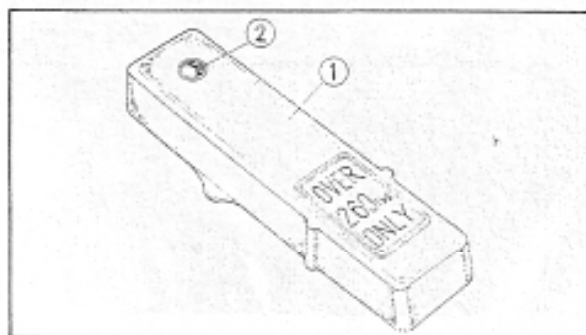


Fig. 2-19 ① Rubber block ② Collar



1. PISTON RINGS

Assembly

- To install the oil ring, first place the spacer and then the rails in position. The spacer and rail gaps must be staggered 20-30 mm (0.8-1.2-in.).
- Install the second and top rings in this order in the piston with their markings facing upward.

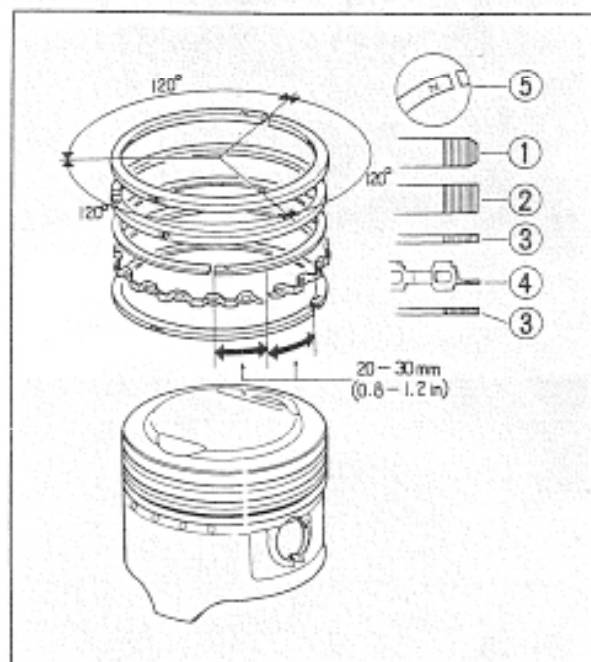
NOTE:

- Do not mix the top and second rings.
 - After installing all rings in the piston, hand-rotate them and check to be sure they move smoothly without any sign of binding.
- The ring gaps must be staggered 120 deg. and must not be in the direction of the piston pin boss or at right angle to the pin.

NOTE:

On the gap of the three-piece type oil ring refer to that of the spacer.

Fig. 3-1 ① Top ring ④ Spacer
② Second ring ⑤ Piston ring marking
③ Rail



2. CLUTCH

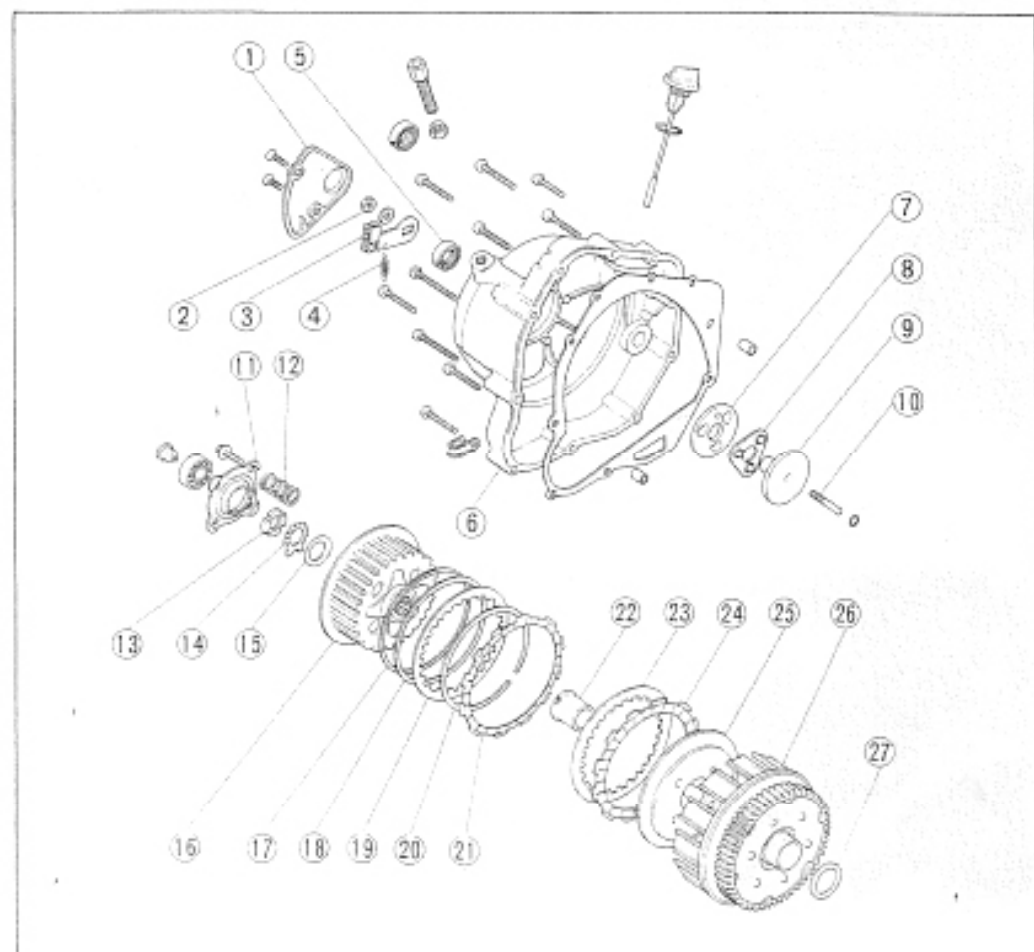


Fig. 3-2

- Clutch cover
- Lock nut
- Clutch lifter lever
- Clutch lever spring
- Oil seal
- Right crankcase cover
- Clutch cam plate
- Ball retainer
- Clutch lifter
- Clutch adjusting screw
- Clutch lifter plate
- Clutch spring
- Lock nut
- Lock washer
- Lock washer
- Clutch center
- Disc spring seat
- Clutch disc spring
- Clutch plate B
- Special set ring
- Clutch friction disc
- Collar
- Clutch plate (six)
- Clutch friction disc (six)
- Clutch pressure plate
- Clutch outer
- Thrust washer

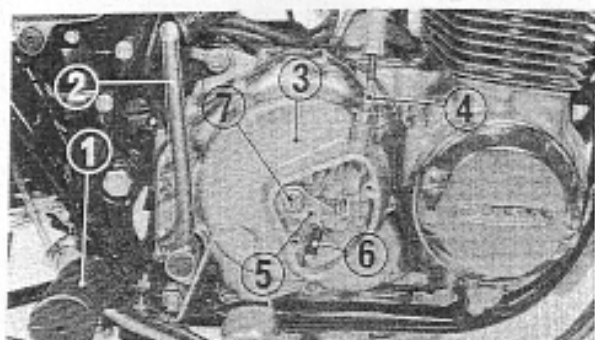


Fig. 3-3 ① Foot rest ⑤ Clutch lifter lever
② Kick starter pedal ⑥ Spring
③ Right crankcase cover ⑦ Lock nut
④ Clutch adjuster

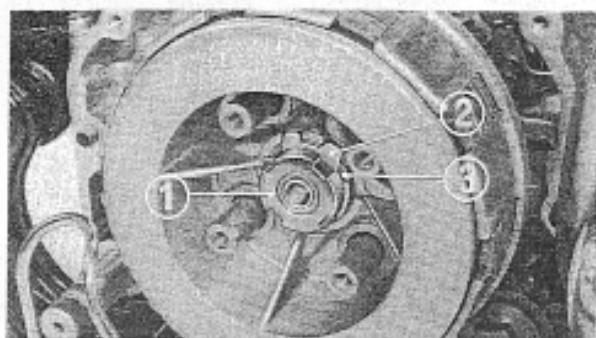


Fig. 3-4 ① 16mm lock nut ③ Lock washer
② Lock washer

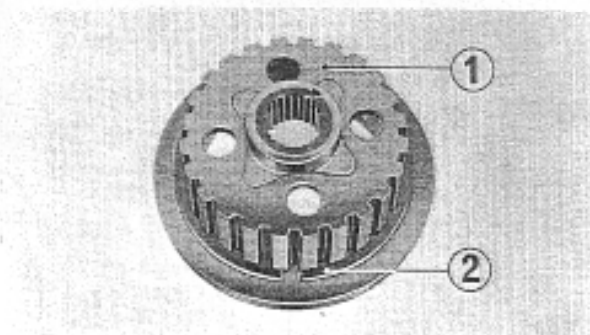


Fig. 3-5 ① Clutch center
② 92mm special set ring

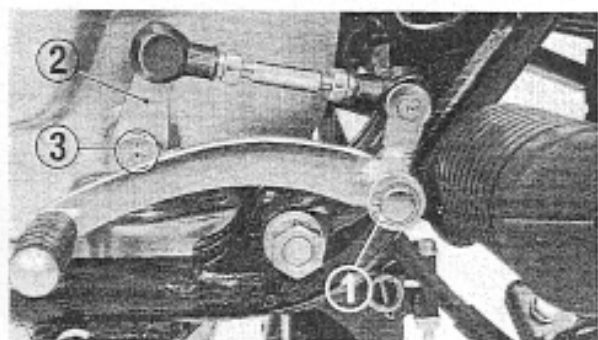


Fig. 3-6 ① Snap ring ③ Punch marks
② Gearshift lever

Disassembly

1. Drain the engine thoroughly by removing the drain plug.
2. Remove the rear brake adjusting nut.
3. Remove the right foot rest and kick starter pedal.
4. Remove the clutch cover from the right crankcase cover.
5. Turn the clutch adjusters to loosen the clutch cable.
6. Disconnect the clutch cable from the clutch lifter lever.
7. Remove the right crankcase cover.
8. Screw off the clutch adjusting screw lock nut and remove the clutch lifter lever and spring.
9. Remove the clutch cam plate, ball retainer, clutch lifter and adjusting screw from the right crankcase cover.
10. Screw off the bolts and remove the clutch lifter plate and clutch springs.
11. Using special tool "Lock Nut Wrench" (Tool No. 07916-6390000), loosen off the 16mm lock nut and remove the clutch assembly.
12. Remove the 92mm special set ring from the clutch center. Disassemble the clutch plate B, clutch disc spring and disc spring seat.

3. GEARSHIFT MECHANISM

Gearshift pedal

Removal

1. Pry off the snap ring and loosen off the gearshift lever locking bolt.
2. Remove the gearshift pedal assembly.

Installation

1. Install the gearshift pedal assembly with the punch mark on the gearshift lever lined up with that on the gearshift spindle.

2. Adjust the gearshift pedal position so that the pedal lever is in parallel with the gearshift lever on the spindle.

This adjustment is made by turning the adjuster after loosening the lock nuts. After adjustment, tighten the lock nuts firmly.

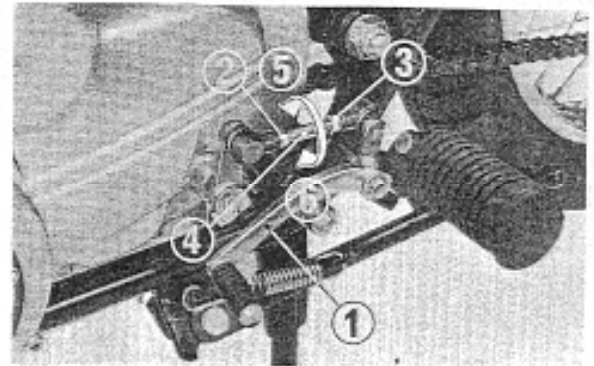
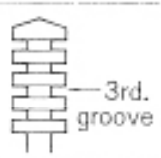


Fig. 3-7 ① Gearshift pedal ④ Adjuster
② Lock nut ⑤ To open
(left hand thread) ⑥ To close
③ Lock nut

4. CARBURETOR

Setting table

ITEM	
Setting number	054-A
Main jet	⌀ 75
Slow jet	⌀ 40
Jet needle setting	
Air screw opening	2 ± 1/2
Float height (gauge)	21 mm (0.827-in.)

I. FRONT SUSPENSION

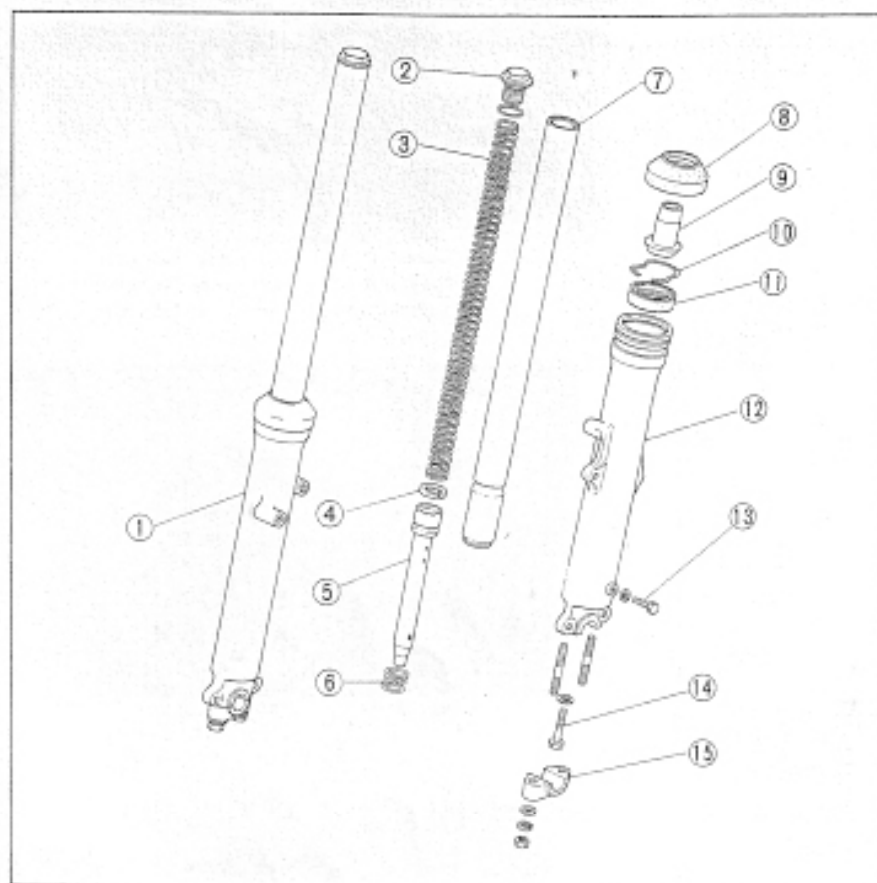


Fig. 4-1

- ① Right front shock absorber
- ② Fork bolt
- ③ Front shock absorber spring
- ④ Piston ring
- ⑤ Under seat pipe
- ⑥ Rebound spring
- ⑦ Front fork pipe
- ⑧ Bottom case cover
- ⑨ Oil lock piece
- ⑩ Oil seal stop
- ⑪ Oil seal
- ⑫ Bottom case
- ⑬ Drain bolt
- ⑭ Socket bolt
- ⑮ Front axle holder

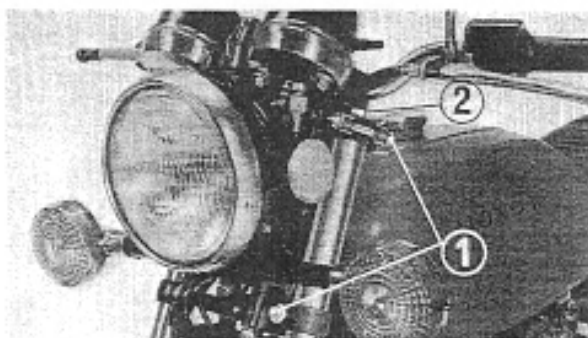


Fig. 4-2 ① Front fork securing bolt
② Front fork bolt

Disassembly

1. Remove the front wheel.
2. Remove the caliper assembly from the left front fork.
3. With the front fork bolt loosened, loosen the bolts at the fork top bridge and steering stem, which secure the front fork. Pull the front fork toward the bottom.
4. Drain the front suspension oil.
5. Remove the rust on the front fork pipe, if any, with fine emery cloth.
6. Remove the socket bolt and separate the front fork pipe and oil lock piece from the bottom case. Use "Allen Head Wrench" (Tool No. 07917-3280000) to remove the socket bolt. Protect the shock absorber with rug when holding it on a vice. Remove the front fork bolt on top of the front fork pipe; remove the front shock absorber spring, under seat pipe and rebound spring.

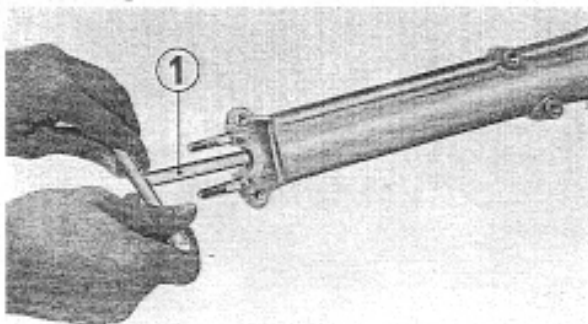


Fig. 4-3 ① Allen head wrench

- B. Remove the bottom case cover. Pry off the oil seal stop and remove the oil seal from the bottom case.

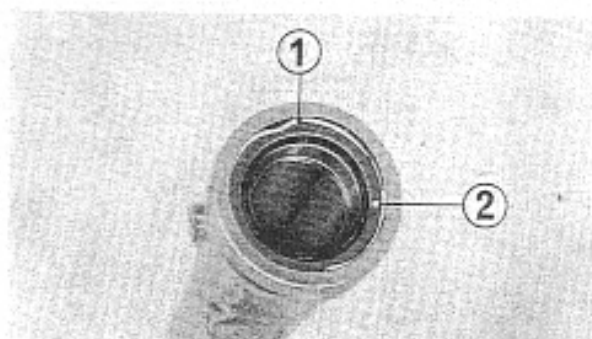


Fig. 4-4 ① Oil seal stop
② Oil seal

Inspection

1. Check the free length of the front shock absorber spring.
2. Check the seat pipe for wear on the piston ring.
3. Check the bottom case and fork pipe for wear, crack or any other defect.
4. Check the oil seal for wear or damage.

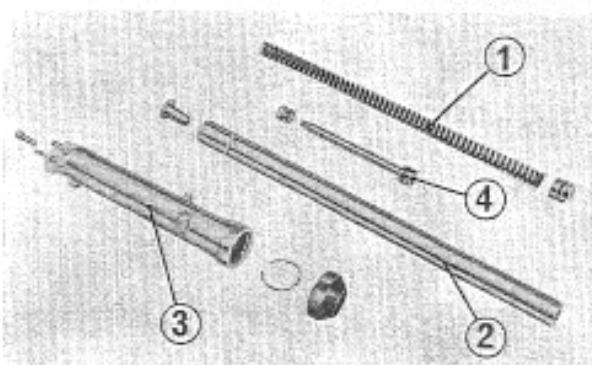


Fig. 4-5 ① Front shock absorber spring
② Front fork pipe
③ Bottom case
④ Piston ring

Assembly

1. Clean all parts in solvent before assembly.
2. Apply a coating of ATF (automatic transmission fluid) to the entire surface of a new oil seal. Install the oil seal to the bottom case. Drive fit the oil seal using "Fork Seal Driver" (Tool No. 97947-3330000). Install the oil seal stop and bottom case cover.
3. Install the rebound spring and seat pipe into the front fork pipe.
4. After installing the oil lock piece, insert the front fork pipe to the bottom case and secure with the socket bolt.

NOTE:

Apply liquid sealant to the threads of the socket bolt.

5. Fill each front fork with 160-165cc (5.6-5.8ozs.) of ATF before installation.
6. Install the front fork assembly so that the chamfered edge on the fork pipe aligns with the upper surface of the fork top bridge as shown.
7. After all parts have been installed, check the action of the front shock absorbers by grasping the handlebar and jouncing the front forks up and down. Also, check the front forks for signs of leaks from the oil seal.

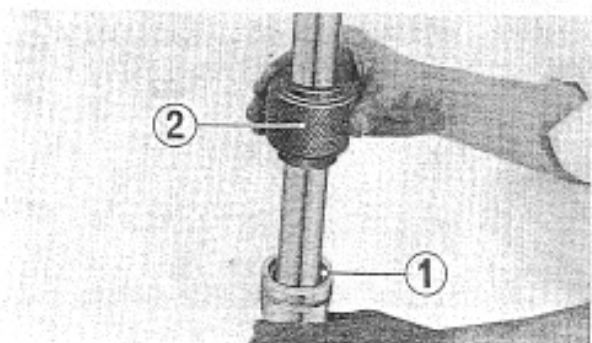


Fig. 4-6 ① Oil seal
② Fork seal driver

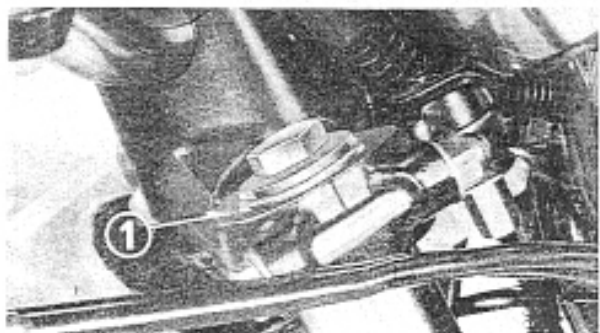
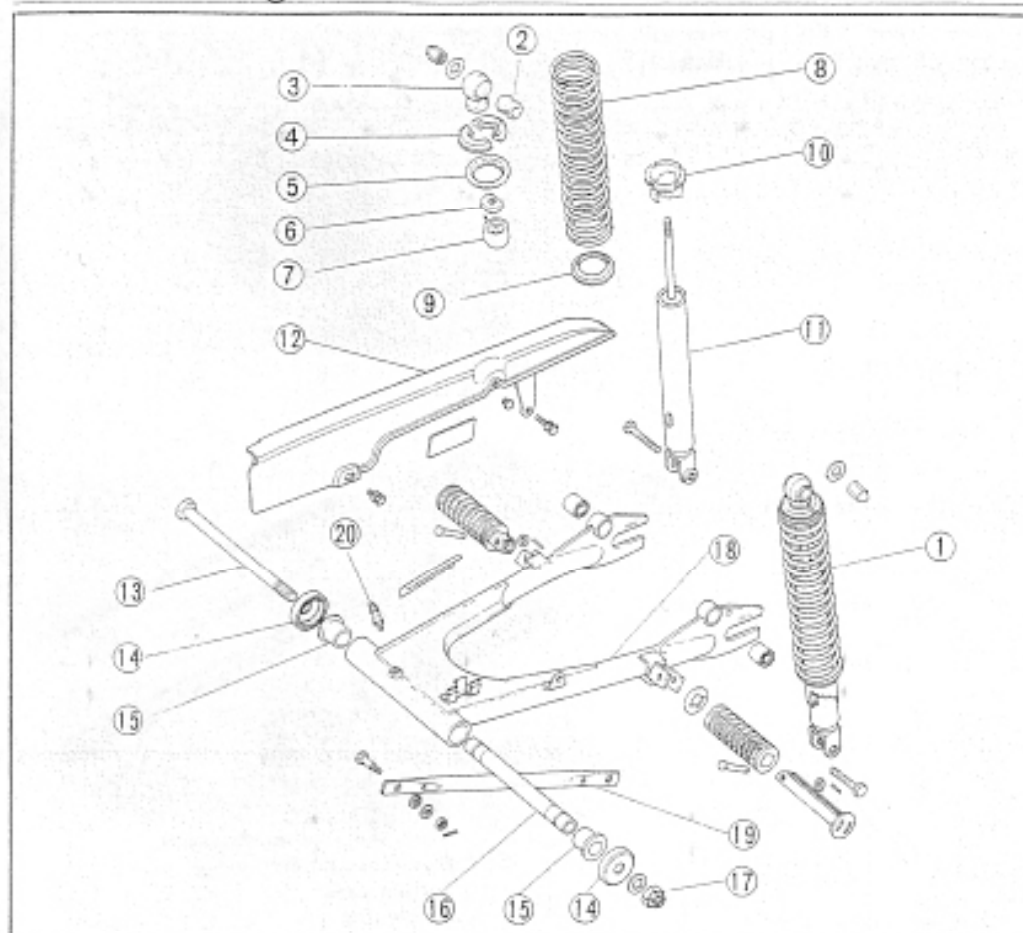


Fig. 4-7 Chamfered edge of front fork pipe



2. REAR SUSPENSION

Fig. 4-5

- ① Rear shock absorber assembly
- ② Joint rubber
- ③ Upper joint
- ④ Spring seat stop
- ⑤ Spring upper seat
- ⑥ Lock nut (10mm)
- ⑦ Stop rubber
- ⑧ Rear shock absorber spring
- ⑩ Spring lower seat
- ⑫ Spring adjuster
- ⑬ Rear damper
- ⑭ Drive chain case
- ⑮ Rear fork pivot bolt
- ⑯ Dust seal cap
- ⑰ Rear fork pivot bushing
- ⑱ Rear fork center collar
- ⑲ Self-locking nut (14mm)
- ⑳ Rear fork
- ㉑ Rear brake stop arm
- ㉒ Grease fitting

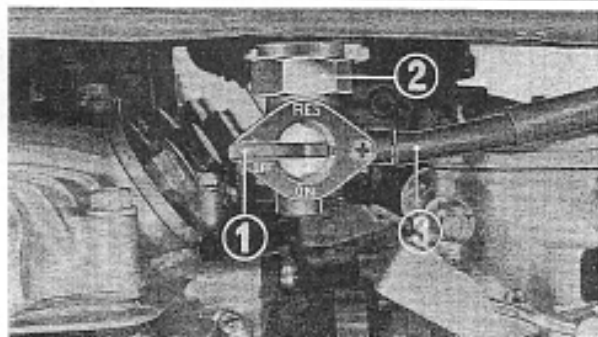


Fig. 4-9 ① Fuel cock lever ③ Fuel tube
② Fuel cock fixing nut

3. FRAME BODY

Fuel Cock

1. Place the fuel cock lever in the "OFF" position; disconnect the fuel tubes. Take out the fuel tank.
2. Loosen the fuel cock fixing nut and then remove the fuel cock and fuel filter from the fuel tank.
3. Disassemble the fuel cock. Loosen off the screws and remove the plate, washer, lever, spring, O-ring and valve from the fuel cock body.
4. Check the valve faces of the fuel cock for scores or any other damage. Replace with a new cock assembly, if necessary.
5. Check the gasket to see if it is not damaged. Replace with a new one, if found to be damaged too badly beyond use.
6. Wash the fuel filter in solvent and dry with compressed air. Any slightest damage can not be tolerated here. Also replace the filter with a new one if found to be clogged.
7. Install the fuel filter to the fuel cock with the fixing nut. Do not forget to install the gasket into the groove of the fixing nut.
8. Install the fuel cock to the fuel tank with the fixing nut.
9. Install the fuel tank in place on the frame; connect tubes and secure with the clips.
10. Fill the tank with fuel. With the fuel cock lever in the "ON" position, check for any leakage past the tube joints or connections.

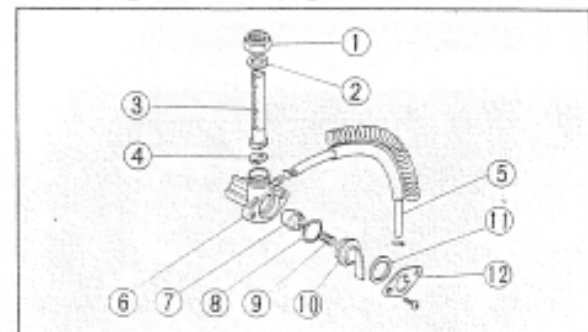


Fig. 4-10

- ① Nut
- ② Gasket
- ③ Fuel filter
- ④ Filter seat
- ⑤ Fuel tube
- ⑥ Fuel cock body
- ⑦ Valve
- ⑧ O-ring
- ⑨ Spring
- ⑩ Cock lever
- ⑪ Washer
- ⑫ Lever setting plate



Muffler

Removal

1. Loosen off two bolts that secure the muffler to the frame.

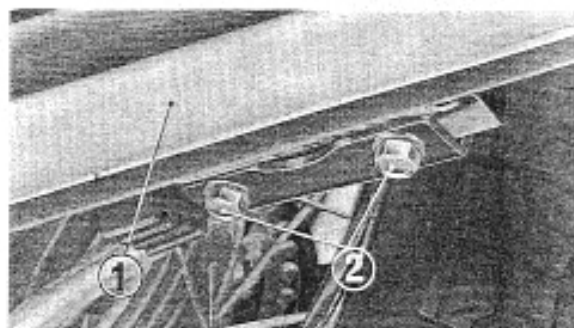


Fig. 4-11 ① Muffler
② Bolt

2. Loosen off eight joint nuts and remove the muffler assembly, exhaust pipe joints and joint collars.

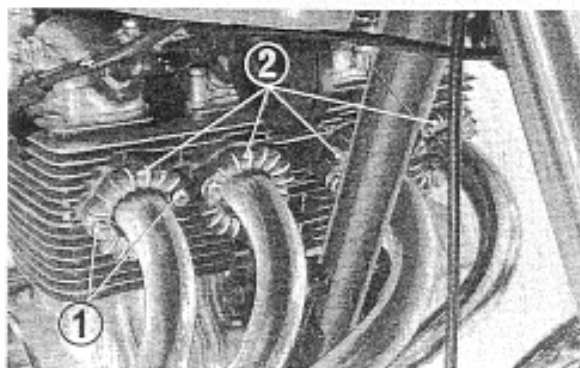


Fig. 4-12 ① Joint nut
② Exhaust pipe joint

3. Loosen the muffler band bolts and remove the two exhaust pipes and sealing gaskets from the muffler assembly.

Inspection

1. Check the exhaust pipe gaskets for damage.
2. Check the muffler sealing gaskets for damage.

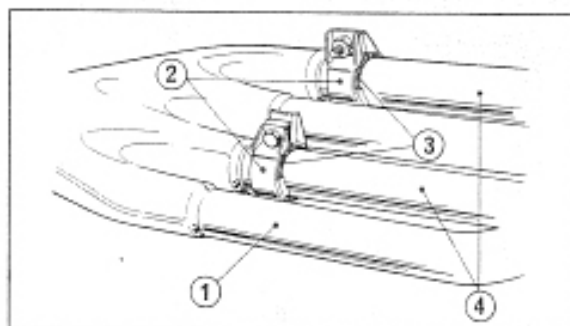


Fig. 4-13 ① Muffler assembly
② Band
③ Gasket
④ Exhaust pipe

Installation

1. Install the exhaust pipes to the muffler assembly through the sealing gaskets.
2. Tighten the muffler bands so that the bolts are at the upper part of the muffler.
3. Install the muffler assembly.



I. CHARGING SYSTEM

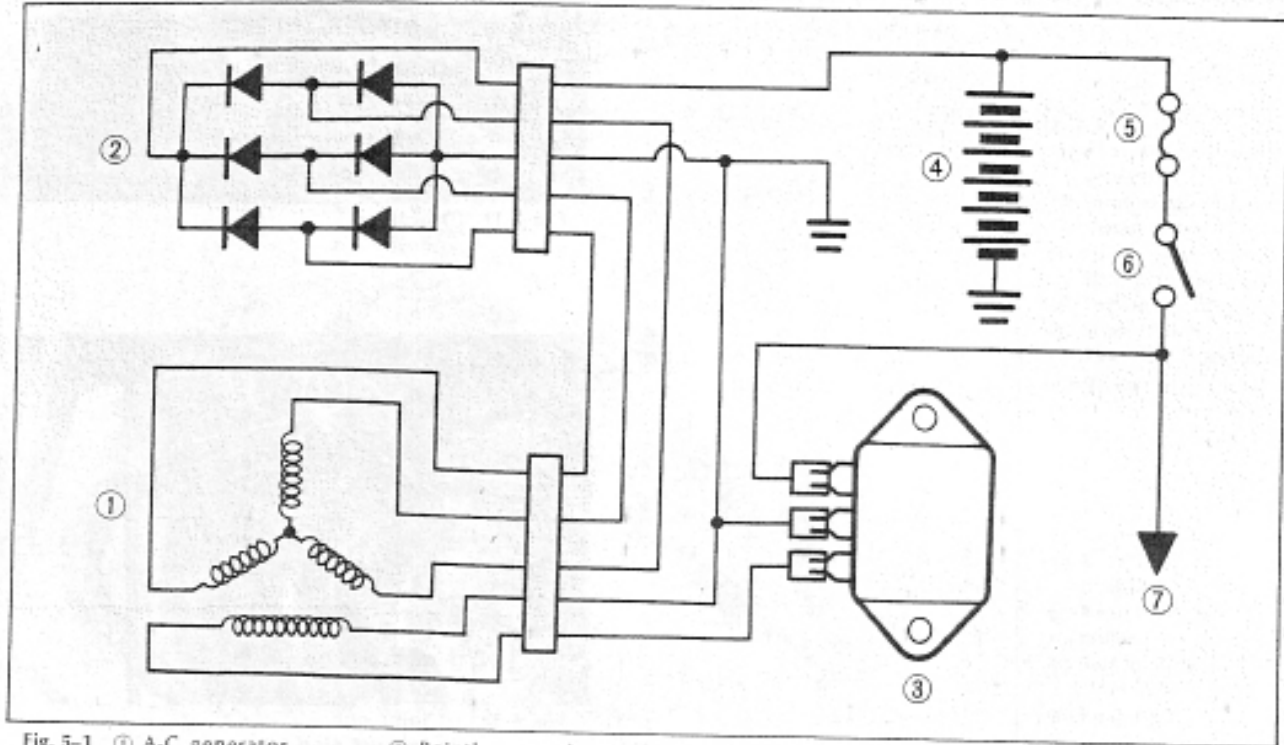


Fig. 5-1 ① A-C generator ② Silicon diode rectifier ③ Pointless regulator ④ Battery ⑤ Fuse ⑥ Main switch ⑦ Load

2. STARTING SYSTEM

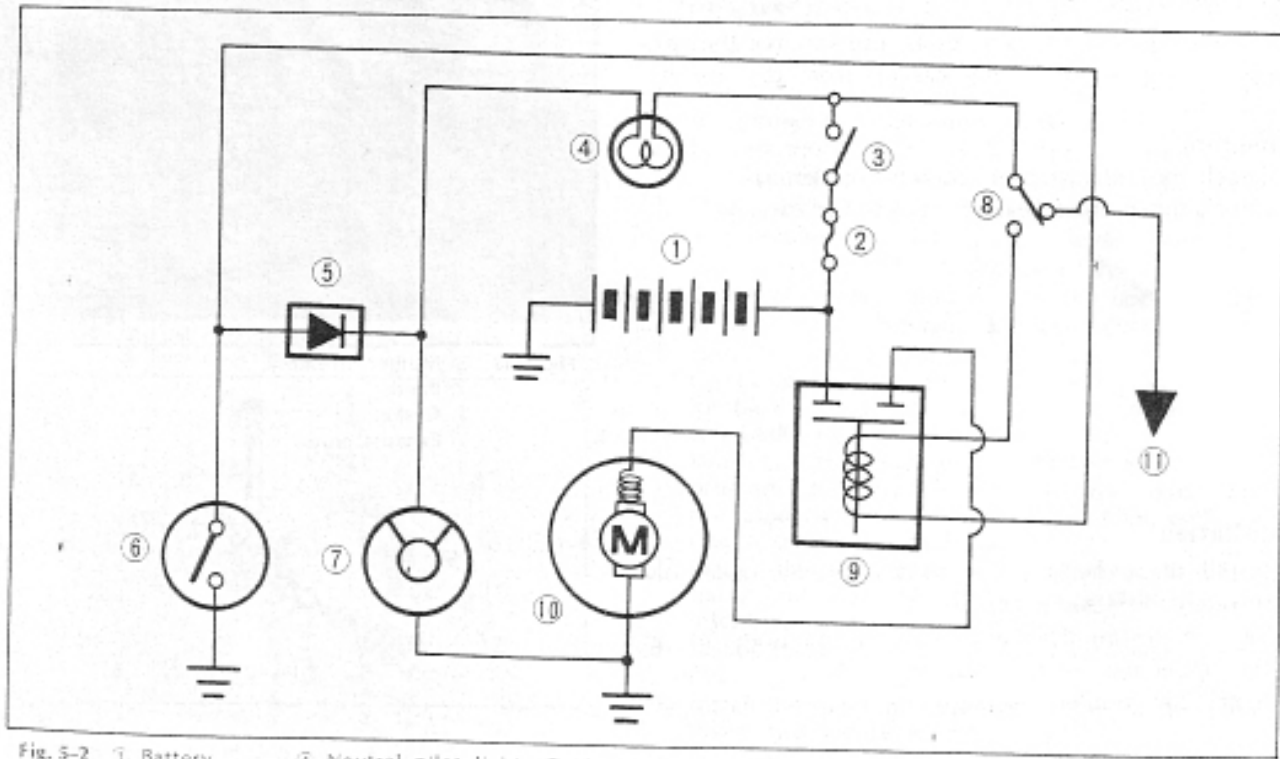


Fig. 5-2 ① Battery ② Neutral pilot light ③ Fuse ④ Silicon diode ⑤ Neutral switch ⑥ Starting switch ⑦ Main switch ⑧ Clutch switch ⑨ Starting magnetic switch ⑩ Starting motor ⑪ To lighting system

Clutch switch

Check the continuity between the green and green/red leads of the switch in the headlight case. Continuity should exist only when the clutch is disengaged.

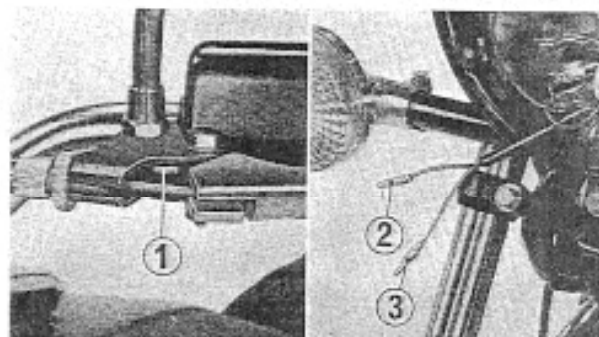


Fig. 5-3 ① Clutch switch
② Green lead
③ Green/red lead

Starting switch

Disconnect the terminals of the starting switch leads in the connector cover. Check for continuity between the circuits (o—o) as shown in the table immediately below.

Terminal	ST1	ST2	HL
Wire color	Black	Yellow/red	Black/red
FREE	○	○	○
PUSH	○	○	

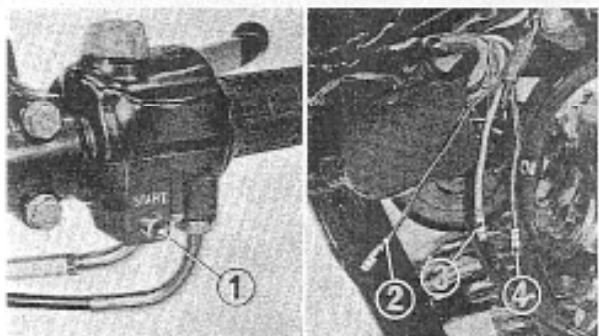


Fig. 5-9 ① Starting switch
② Yellow/red lead
③ Black lead
④ Black/red lead

Silicon diode

Check the diode for continuity with a radio tester in high-reading range. If current flows only one direction (From cathode to anode), the diode is normal. Current flow in both directions or no current is a sign of malfunction of the diode.

NOTE:

Do not use a megger as a high voltage generated in the megger will damage the diode.

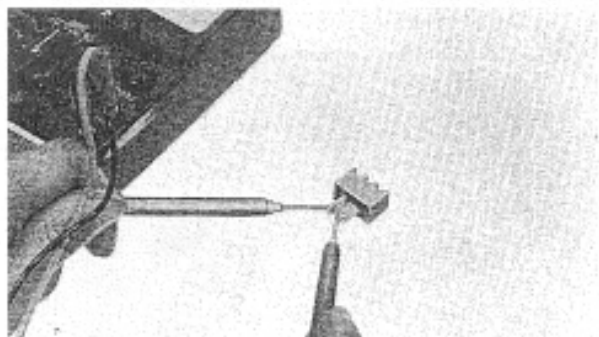


Fig. 5-5 Checking silicon diode

3. ELECTRICAL EQUIPMENTS

Main switch

With the key in OFF, ON or PARK, check the main switch for continuity. The switch is normal if continuity exists in the circuit (o—o). Discard the switch if there is any continuity in other circuits shown below.

Terminal	BAT	IG	TL1	TL2	PA
Wire color	Red	Black	Brown	Brown/white	Brown
PARK	○	○	○	○	○
ON	○	○	○	○	○
OFF					
LOCK					

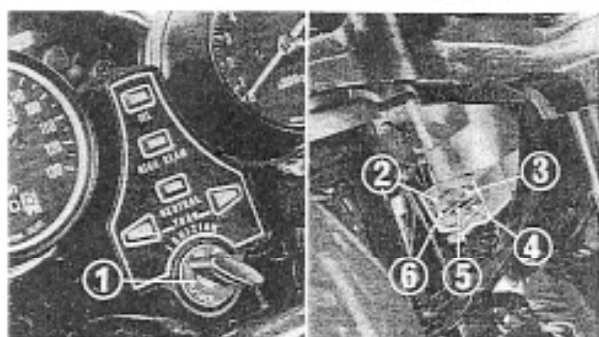


Fig. 5-6 ① Main switch
② Brown
③ Brown
④ Brown, white
⑤ Red
⑥ Black

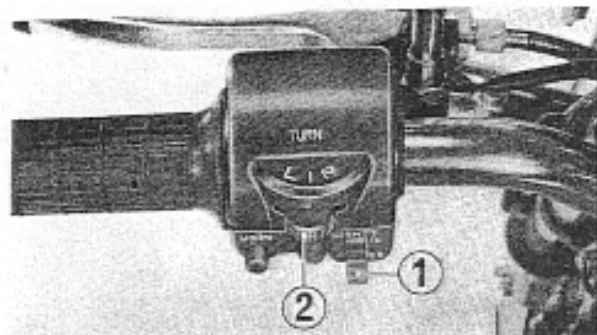


Fig. 5-7 ① Dimmer switch
② Turn signal control switch

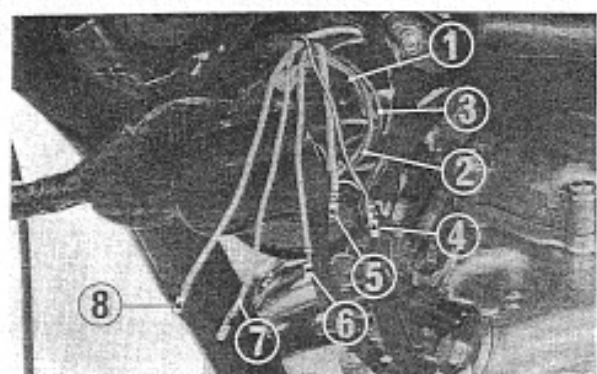


Fig. 5-8 ① Grey lead ⑥ Blue lead
② Orange lead ⑦ Orange/white lead
③ Light blue lead ⑧ Light blue/white lead
④ Black/yellow lead
⑤ White lead

Dimmer and turn signal control switch

Check for continuity between respective terminals of the switch leads in the connector cover. The switch is normal if there is continuity as specified below (o—o) with the switch selector knob in each position.

Terminal	W	L	R	P(F)	PL	PR
Wire color	Grey	Orange	Light blue	—	Light blue/white	Orange/white
L	o—o			o—o		o—o
N				o—o	o—o	o—o
R	o—o		o—o	o—o		
Terminal	HL	Hi	Lo	P(F)		
Wire color	Black/Yellow	Blue	White	—		
Hi	o—o					
(N)	o—o	o—o	o—o	o—o		
Lo	o—o		o—o			

Horn switch

Disconnect the terminal of the horn switch lead in the connector cover. Check the continuity between the grey lead and ground.

Continuity should exist only when the button is depressed.

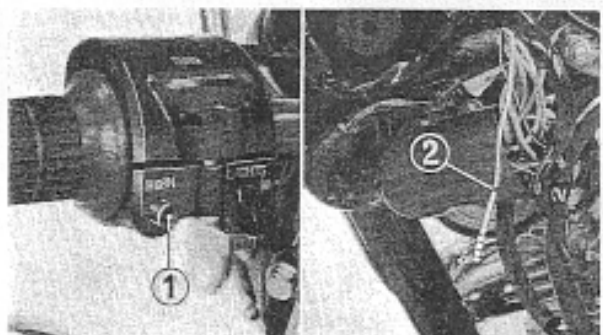


Fig. 5-9 ① Horn switch
② Grey lead

Engine stop switch

Check for continuity between the respective terminals of the switch leads in the connector cover. The switch is good condition if there is continuity in the circuit (o—o) with the switch selector knob in each position.

Terminal	IG	RUN
Wire color	Black	Black/white
OFF		
RUN	o—o	o—o
OFF		

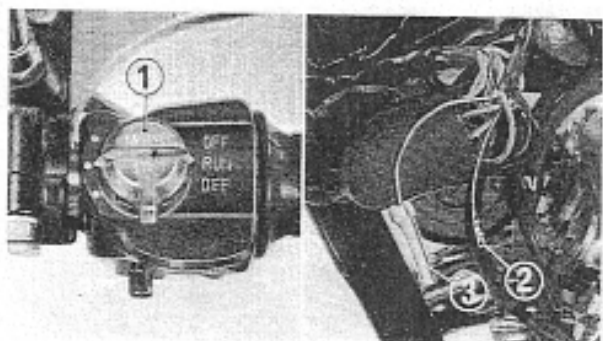


Fig. 5-10 ① Engine stop switch
② Black
③ Black white

VI. SERVICE DATA

Courtesy of  Honda4Fun
www.hondafour.com www.honda4fun.com

I SPECIAL TOOLS

No.	Tool No.	Description
	07900-3770000	CB 400F special tool set
1	07902-2000000	Pin spanner (48mm)
2	07906-3230000	Box wrench (12mm)
3	07908-0010000	Tappet adjusting wrench
4	07901-3230101	Front wheel bearing retainer wrench
5	07910-3290000	Rear wheel bearing retainer wrench
6	07914-3230000	Snap ring pliers
7	07916-6390000	Lock nut wrench (16mm)
8	07917-3230000	Allen head wrench (6mm)
9	07933-3330000	Rotor puller
10	07942-3290100	Valve guide driver
11	07942-3290200	Valve guide compressor
12	07945-3330100	Bearing driver attachment (inner)
13	07945-3330200	Bearing driver attachment (Outer)
14	07945-3330300	Ball race driver attachment
15	07947-3330000	Fork seal driver
16	07949-6110000	Driver handle
17	07953-3330000	Ball race remover
18	07955-3770000	Piston ring compressor
19	07957-3290000	Valve spring compressor
20	07958-3330000	Piston base
21	07959-3290000	Shock absorber compressor
22	07984-2000000	Valve guide reamer (Intake)
23	07984-3770000	Valve guide reamer (Exhaust)
24	07921-0010000	Flare nut wrench
25	07922-2870000	Drive sprocket holder
26	07797-2920300	Special tool case
OPTIONAL		
27	07504-3000100	Vacuum gauge set
28	07908-3230200	Carburetor synchronization wrench set

2. MAINTENANCE SCHEDULE

This maintenance schedule is based upon average riding conditions. Machines subjected to severe use, or ridden in unusually dusty areas, require more frequent servicing.	INITIAL SERVICE PERIOD	REGULAR SERVICE PERIOD			
		Perform at every indicated month or mileage interval, whichever occurs first.			
	500 miles	1 month 500 miles	3 months 1,500 miles	6 months 3,000 miles	12 months 6,000 miles
Engine Oil—Change	●		○		
Oil Filter Element—Replace	●			○	
Oil Filter Screen—Clean					○
Spark Plug—Clean and adjust gap or replace if necessary.				○	
*Contact Points and Ignition Timing—Clean, check, and adjust or replace if necessary.	●			○	
*Valve Tappet Clearance—Check, and adjust if necessary.	●			○	
*Cam Chain Tension—Adjust	●			○	
Paper Air Filter Element and Breather Element—Clean		(service more frequently if operated in dusty areas)		○	
Paper Air Filter Element—Replace					○
*Carburetor—Check, and adjust if necessary.	●			○	
Throttle Operation—Inspect cable. Check, and adjust free play.	●			○	
*Fuel Filter Screen—Clean				○	
Fuel Lines—Check				○	
*Clutch—Check operation, and adjust if necessary.	●			○	
Drive Chain—Check, lubricate, and adjust if necessary.	**●	○			
Brake Fluid Level—Check and add fluid if necessary.	●			○	
*Brake Shoes/Pads—Inspect, and replace if worn.				○	
Brake Control Linkage—Check linkage, and adjust free play if necessary.	●			○	
*Wheel Rims and Spokes—Check. Tighten spokes and true wheels, if necessary.	●			○	
Tires—Inspect and check air pressure.	●	○			
Front Fork Oil—Drain and refill.	***●				○
Front and Rear Suspension—Check operation.	●			○	
Rear Fork Bushing—Grease, check for excessive looseness.				○	
*Steering Head Bearings—Adjust.					○
*Side Stand—Check installation, operation, deformation, damage and wear.				○	
Battery—Check electrolyte level, and add water if necessary.	●		○		
Lighting Equipment—Check and adjust if necessary.	●	○			
All Nuts, Bolts, and Other Fasteners—Check security and tighten if necessary.	●	○			

Items marked * should be serviced by an authorized Honda dealer, unless the owner has proper tools and is mechanically proficient. Other maintenance items are simple to perform and may be serviced by the owner.

** Initial service period 200 miles. *** Initial service period 1,500 miles.

3. TORQUE SPECIFICATIONS

ENGINE

Tightening point	Thread dia. (mm)	Torque	
		kg-cm	lbs-ft
Crankcase and crankcase covers	6, P1.0	70-110	5.1-8.0
Cylinder head	8, P1.25	200 (Apply oil to the nuts before tightening)	14.5
Carburetor insulator-to-cylinder head	6, P1.0	70-110	5.1-8.0
Cam sprocket	7, P1.0	160-200	11.6-14.5
A-C generator rotor	10, P1.25	300-400	21.7-29.0
Primary drive gear	12, P1.25	300-400	21.7-29.0
Tappet adjusting nut	5, P0.5	70-110	5.1-8.0
Upper and lower crankcases	8, P1.25	220-260	15.2-18.9
Cylinder head cover	6, P1.0	70-110	5.1-8.0
Clutch center	16, P1.0	400-450	29.0-32.6
Connecting rod	8, P1.25	200-220	14.5-15.2

FRAME

Tightening point	Thread dia. (mm)	Torque	
		kg-cm	lbs-ft
Steering stem nut	24, P1.0	800-1,200	57.9-86.9
Fork top bridge to front forks	8, P1.25	180-230	13.1-16.7
Handlebar holder	8, P1.25	180-230	13.1-16.7
Front fork bottom bridge to front forks	8, P1.25	180-230	13.1-16.7
Spokes	—		
Front wheel	—	25-30	1.9-2.2
Rear wheel	—	20-25	1.5-1.9
Rear fork pivot bolt	14, P1.5	550-700	39.8-50.7
Front wheel axle nut	12, P1.5	450-550	32.6-39.8
Front fork axle holder	8, P1.25	180-230	13.1-16.7
Engine hanger bolt	10, P1.25	300-400	21.7-29.0
Rear wheel axle nut	16, P1.5	800-1,000	57.9-72.4
Final driven sprocket	10, P1.25	400-500	29.0-36.2
Brake arm	6, P1.0	80-100	5.9-7.3
Front and rear brake torque links	8, P1.25	180-230	13.1-16.7
Rear suspension	10, P1.25	300-400	21.7-29.0
Step bar	12, P1.25	450-550	32.6-39.8
Gear change pedal and kick arm	6, P1.0	80-100	5.9-7.3

4. SERVICE DATA

ENGINE

Unit: mm (in.)

Item	Assembly standard	Service limit
Rocker arm-to-rocker arm shaft clearance	0.016-0.052 (0.0006-0.0020)	0.1 (0.0039)
Cam height of camshaft		
Intake	28.185-28.225 (1.1096-1.1112)	28.0 (1.1024)
Exhaust	28.184-28.224 (1.1096-1.1111)	28.0 (1.1024)
Camshaft center journal	—	0.1 (0.0039)
Valve seat width	0.7 (0.03)	1.5 (0.0039)
Valve stem O.D.		
Intake	5.48-5.49 (0.2158-0.2161)	5.35 (0.2106)
Exhaust	5.47-5.48 (0.2154-0.2158)	5.35 (0.2106)
Valve-to-valve guide clearance		
Intake	0.01-0.03 (0.0004-0.0012)	0.3 (0.0118)
Exhaust	0.01-0.03 (0.0004-0.0012)	0.3 (0.0118)
Valve spring preload		
Inner	19.2/13.0-14.6 kg (0.7559/28.665-32.1930 lbs)	—
Outer	23.7/32.0-32.4 kg (0.9330/70.560-71.4420 lbs)	—
Valve spring free length		
Inner	29.0 (1.1417)	27.0 (1.0630)
Outer	34.5 (1.3583)	32.5 (1.2795)
Cylinder head flatness	—	0.3 (0.0118)
Cylinder I.D.	51.00-51.01 (2.0079-2.0083)	51.1 (2.0118)
Piston skirt O.D.	50.97-50.99 (2.0067-2.0075)	50.85 (2.0020)
Piston pin hole I.D.	13.002-13.008 (0.5119-0.5121)	13.05 (0.5138)
Piston pin O.D.	12.994-13.00 (0.5116-0.5118)	12.9 (0.5079)
Piston ring-to-piston ring groove clearance		
Top ring	0.025-0.055 (0.0010-0.0022)	0.15 (0.0059)
Second ring	0.015-0.045 (0.0006-0.018)	0.15 (0.0059)
Piston ring end gap		
Top ring	0.15-0.35 (0.0059-0.0138)	0.7 (0.0276)
Second ring	0.15-0.35 (0.0059-0.0138)	0.7 (0.0276)
Oil ring	0.2-0.5 (0.0079-0.0197)	0.9 (0.0035)
Outer rotor O.D.-to-pump body clearance		
Main pump	0.06-0.12 (0.0024-0.0047)	0.35 (0.0138)
Auxiliary pump	0.15-0.20 (0.0059-0.0079)	0.35 (0.0138)
Outer rotor-to-inner rotor clearance		
Main pump	0.15 (0.0059), max.	0.3 (0.0118)
Auxiliary pump	0.15 (0.0059), max.	0.3 (0.0118)
Friction disc thickness	2.62-2.78 (0.1032-0.1095)	2.3 (0.0906)
Clutch plate surface warpage	0.1 (0.0039), max.	0.2 (0.0079)
Clutch spring free length	31.25 (1.2303)	29.75 (1.1712)
Clutch center-to-clutch plate B clearance	0.1-0.5 (0.004-0.02)	Beyond assembly standard
Gearshift fork finger width	5.93-6.00 (0.2335-0.2362)	5.5 (0.2165)



Unit: mm (in.)

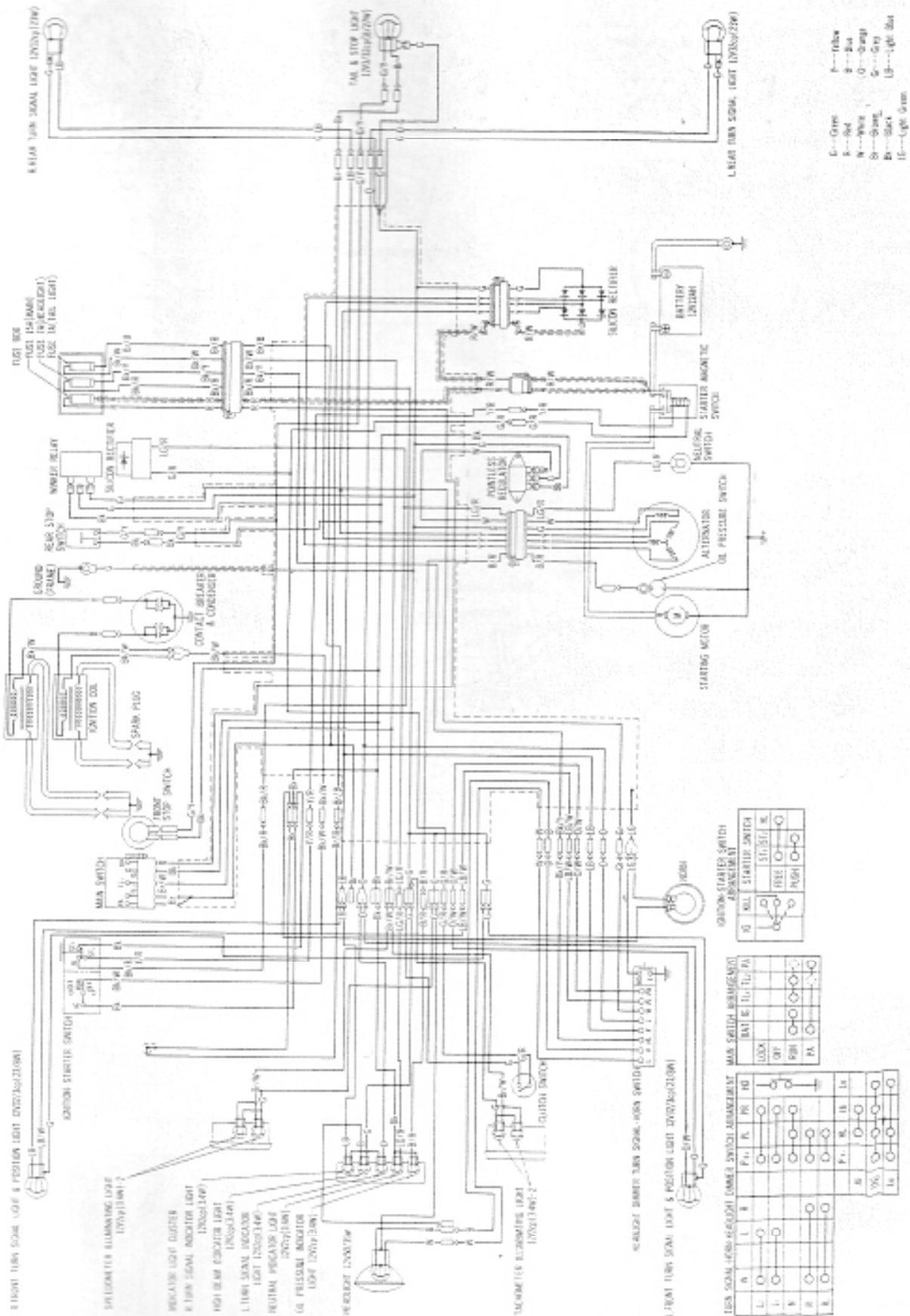
Item	Assembly standard	Service limit
Gearshift guide shaft O.D.	12.957-12.984 (0.5101-0.5112)	12.9 (0.5079)
Gearshift fork I.D.	13.000-13.018 (0.5118-0.5125)	12.95 (0.5098)
Kick starter pinion-to-shaft clearance	0.04-0.082 (0.0016-0.0032)	0.1 (0.004)
Gearshift fork dowel-to-drum groove clearance	0.05-0.22 (0.0020-0.0087)	0.3 (0.0118)
Transmission gear backlash	—	0.2 (0.0079)
Transmission gear-to-shaft clearance		
C-1	0.04-0.074 (0.0016-0.0029)	0.2 (0.0079)
Other gears	0.04-0.081 (0.0016-0.0032)	0.2 (0.0079)
Cam chain tensioner slipper thickness (center)	4.0 (0.1575)	3.0 (0.118) max.
Cam chain guide thickness	6.1-6.3 (0.2402-0.2480)	5.0 (0.197)
Crankshaft runout (center)	0.03 (0.0012), max.	0.05 (0.0020)
Crankshaft journal clearance	0.018-0.048 (0.0007-0.0019)	0.08 (0.0032)
Connecting rod small end I.D.	13.012-13.033 (0.5123-0.5131)	13.10 (0.5158)
Connecting rod big end side clearance	0.02-0.07 (0.0008-0.0028)	0.15 (0.0059)
Connecting rod big end-to-crankshaft journal clearance	0.018-0.048 (0.0007-0.0019)	0.08 (0.0032)
Primary chain guide thickness (center)	6.0-6.3 (0.236-0.248)	5.0 (0.197)



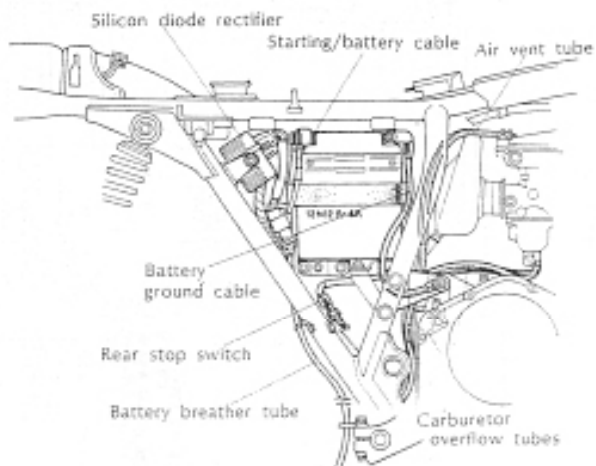
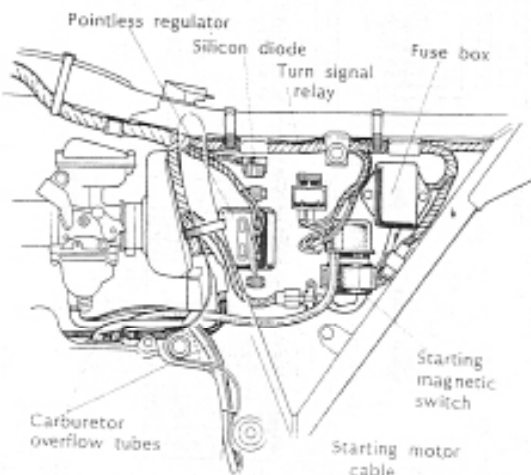
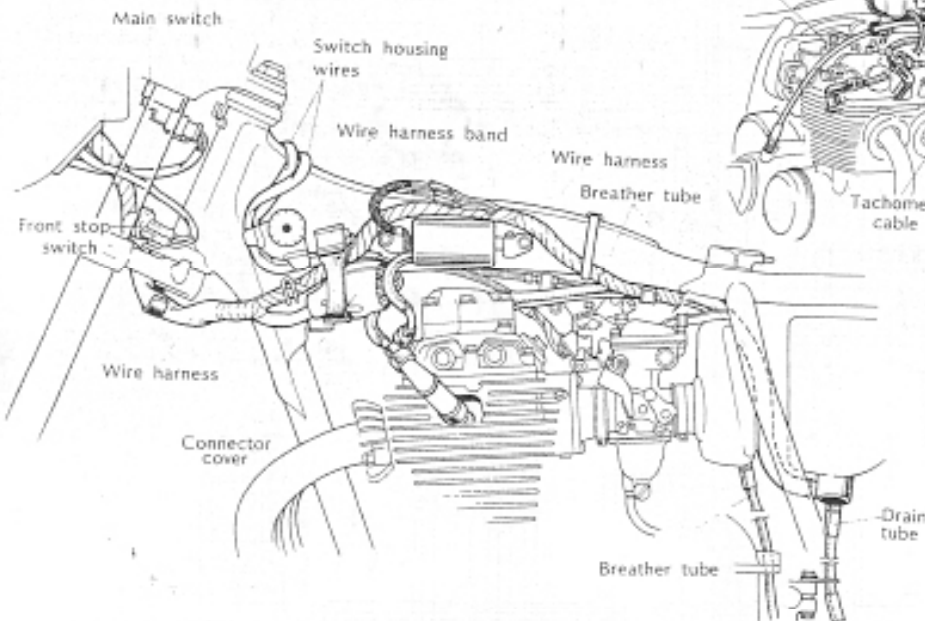
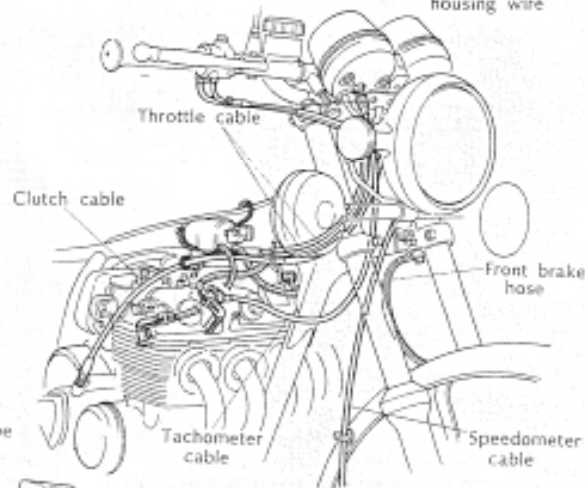
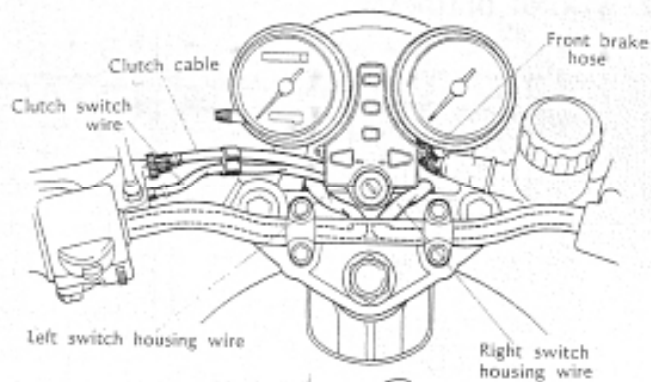
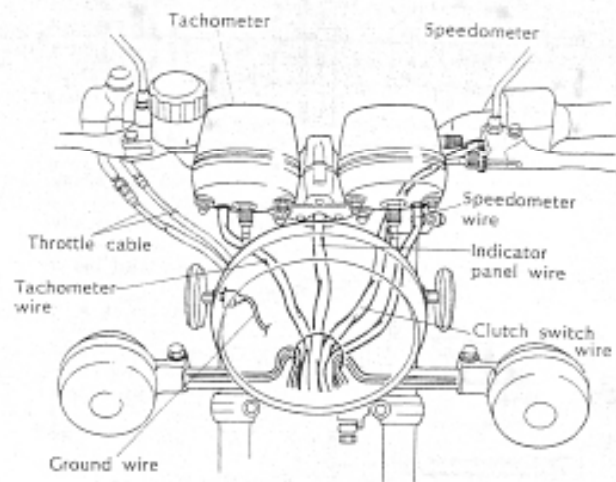
FRAME

Item	Assembly standard	Unit: mm (in.)
		Service limit
Brake disc face runout	0.3 (0.0118), max.	0.3 (0.0118), min.
Brake disc thickness	6.9-7.1 (0.2717-0.2795)	—
Wheel rim face runout	0.5 (0.0197), max.	2.0 (0.079)
Wheel bearing end play	0.07 (0.0028) max.	0.1 (0.0039)
Wheel bearing radial play	0.03 (0.0012), max.	0.05 (0.0020)
Front axle runout	0.01 (0.0004)	0.2 (0.0079)
Caliper cylinder I. D.	38.18-38.20 (1.5032-1.5039)	38.215 (1.5045)
Caliper piston O. D.	38.115-38.480 (1.5006-1.5150)	38.105 (1.5002)
Master cylinder I. D.	14.00-14.043 (0.5512-0.5529)	14.055 (0.5533)
Master cylinder piston O. D.	13.957-13.984 (0.5495-0.5505)	13.940 (0.5488)
Rear axle runout	0.01 (0.0004)	0.2 (0.0079)
Rear brake lining thickness	4.9-5.0 (0.1929-0.1969)	2.5 (0.0984)
Rear brake drum I. D.	160.0-160.3 (6.2992-6.3110)	161 (6.3386)
Front suspension spring free length	478.6 (18.843)	450 (17.717)
Rear suspension spring free length	210.4 (8.284)	190 (7.480)
Rear fork pivot bushing-to-center collar clearance	0.1-0.3 (0.0039-0.0118)	0.5 (0.02)
Rear fork bushing I. D.	21.5-21.552 (0.8465-0.8485)	21.70 (0.8543)
Center collar O. D.	21.427-21.460 (0.8436-0.8449)	21.35 (0.8406)
Front fork bottom case I. D.	33.000-33.039 (1.2992-1.3007)	33.18 (1.3063)
Front fork Pipe O. D.	32.90-32.98 (1.2952-1.2984)	32.875 (1.2944)

5. WIRING DIAGRAM



6. ROUTING



7. SPECIFICATION

	Item	Specification	
Dimension	Overall length	2,040 mm (80.3 in.)	
	Overall width	705 mm (27.8 in.)	
	Overall height	1,040 mm (40.9 in.)	
	Wheel base	1,355 mm (53.3 in.)	
	Seat height	790 mm (31.1 in.)	
	Foot peg height	330 mm (13.0 in.)	
	Ground clearance	150 mm (5.9 in.)	
	Dry weight	170 kg (375 lbs.)	
Frame	Type	Semi-double cradle	
	F. suspension, travel	Telescopic fork, Travel 114.5 mm (4.5 in.)	
	R. suspension, travel	Swing arm, Travel 79.0 mm (3.1 in.)	
	F. tire size, pressure	3.00S18 (4PR), Air pressure 1.8 kg/cm ² (26 psi)	
	R. tire size, pressure	3.50S18 (4PR), Air pressure 2.0/25 kg/cm ² (28/36 psi)	
	F. brake, lining area	Disc brake, Lining swept areas 38 cm ² (5.9 sq. in.)	
	R. brake, lining area	Internal expanding shoes, Lining swept areas 70 cm ² (10.9 sq. in.)	
	Fuel capacity	14 lit. (3.7 U.S. gal. 3.1 Imp. gal.)	
	Fuel reserve capacity	3 lit. (0.8 U.S. gal. 0.7 Imp. gal.)	
	Caster angle	63°30'	
	Trail length	85 mm (3.3 in.)	
	Front fork oil capacity	160-165 cc (to fill if dry) (5.6-5.8 ozs.)	
	Front fork oil capacity	145-150 cc (refill after draining) (4.8-4.9 ozs.)	
Engine	Type	Air cooled, 4-stroke O.H.C. engine	
	Cylinder arrangement	Vertical four parallel	
	Bore and stroke	51.0 × 50.0 mm (2.008 × 1.969 in.)	
	Displacement	408 cc (24.9 cu. in.)	
	Compression ratio	9.4 : 1	
	Valve train	Chain driven over head camshaft	
	Oil capacity	3.5 lit. (3.7 U.S. qt. 3.1 Imp. qt.)	
	Lubrication system	Forced and wet sump	
	Cylinder head compression pressure	12 kg/cm ² (170.7 psi)	
	Intake valve	Opens	At 5° (before top dead center)
		Closes	At 35° (after bottom dead center)
	Exhaust valve	Opens	At 35° (before bottom dead center)
		Closes	At 5° (after top dead center)
	Valve tappet clearance		IN-EX 0.05 mm (0.002 in.)
Idle speed		1,200 rpm	



	Item	Specifications
Carburetor	Type	Piston valve
	Setting mark	054-A
	Main jet	φ75
	Slow jet	φ40
	Air screw opening	2 ± 1/2
	Float height	21 mm (0.827 in.)
Drive train	Clutch	Wet, multi-plate type
	Transmission	6-speed constant mesh
	Primary reduction	3.423
	Gear ratio I	2.733
	Gear ratio II	1.800
	Gear ratio III	1.375
	Gear ratio IV	1.111
	Gear ratio V	0.965
	Gear ratio VI	0.866
	Final reduction	2.235
	Gear shift pattern	Left foot operated return system
Electrical	Ignition	Battery and ignition coil
	Starting system	Starting motor and kick starter
	Alternator	A-C generator 0.156 kW/5,000 rpm
	Battery capacity	12V-12AH
	Spark plug	NGK D8ESL, ND X24ES
	Headlight	Low/High beam 12V-35 W/50W
	Tail/stoplight	Tail/Stop 12V-3/32 cp (SAE TRADE NO. 1157)
	Turn signal light	12V-32 cp (SAE TRADE NO. 1157/10731)
	Speedometer light	12V-2 cp (SAE TRADE NO. 57)
	Tachometer light	12V-2 cp (SAE TRADE NO. 57)
	Neutral indicator light	12V-2 cp (SAE TRADE NO. 57)
	Turn signal indicator light	12V-2 cp (SAE TRADE NO. 57)
	High beam indicator light	12V-2 cp (SAE TRADE NO. 57)
	Position light	12V-3 cp (SAE TRADE NO. 1757)