

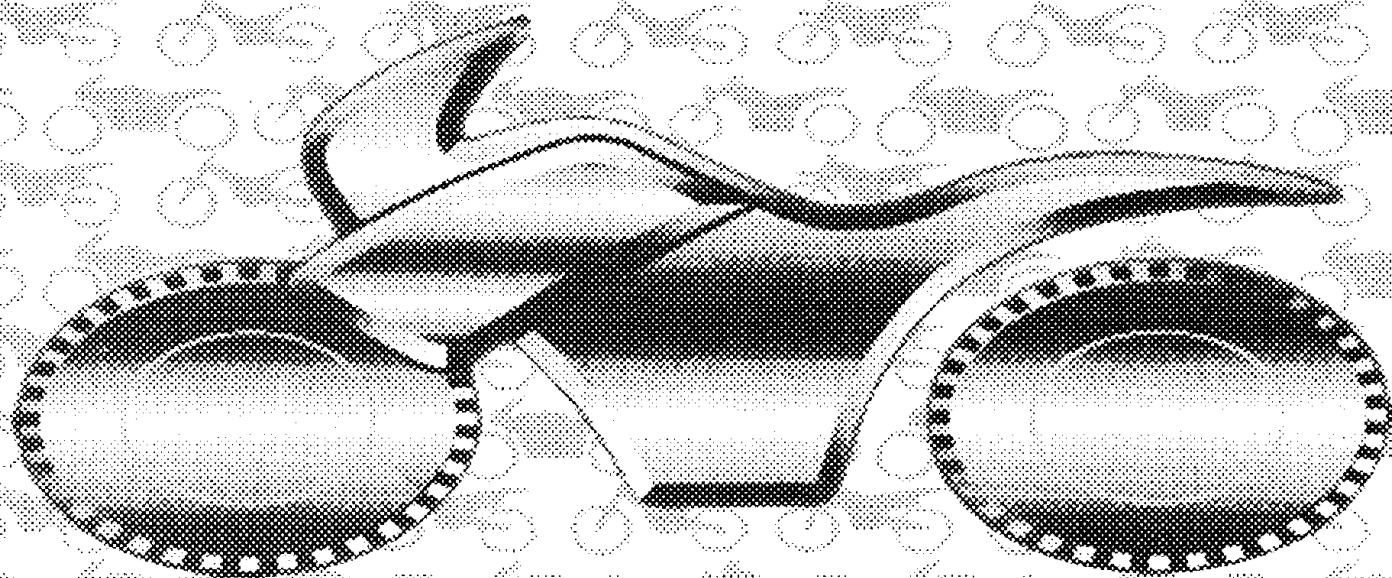

Important safety instructions included.
Read through carefully before you ride.



Owner's Manual

CRM250AR

Thank you for purchasing a Honda Motorcycle. For your safety and comfort, please familiarise yourself with this manual before riding.

At time of purchase

- * Please obtain this owners manual.
Ask your dealer about the following:
- Tips on handling and riding.
- Contents/period of the warranty.
- Service requirements
- Filling out the purchase receipt and the warranty card.
- Signing the Warranty registration form – to verify that all the features of the machine have been explained to you.

Motorcycle rider's licence

This motorcycle has a total displacement of 249cm³(cc). You must hold a corresponding motorcycle rider's license in order to ride on public roads.

The vehicle is designed to carry a maximum of two people, including the rider. Note that you cannot carry a passenger for the first 12 months after obtaining your motorcycle license.

Safety Warnings

About this manual

* This manual contains the information for the correct handling, safe riding and basic maintenance. Please read through “**Safety Warning**”, “**Safe riding**” and “**Maintenance safety tips**” as they are particularly important.

* Even if you are familiar with motorcycles already, please read this manual as this model has some special features. Please also read the maintenance note.

* When re-selling the vehicle please hand the manual and the maintenance record to the next owner.

* Honda Motor Co., reserves the right to alter specifications and make other changes at any time without notice or obligation.

Safety warnings

* Safety warnings

The following safety warnings are used in this manual to alert you to the potential for danger to the rider, the passenger and the others. Always read the warnings thoroughly.



Warning: High potential of causing death or severe injury.



Caution: Potential of causing death or severe injury.



Note: Potential of minor injury.

*

Other symbols:



Advice: To keep your motorcycle in peak condition.



Tips: To ensure best performance and pleasant riding.

1

Contents

FOR YOUR OWN SAFETY	4		
PARTS	10	Features / Accessories	21
INSTRUMENTS AND INDICATORS	12	Handlebar lock.....	21
Instruments.....	12	Seat.....	22
Speedometer.....	12	Helmet holder.....	23
Odometer.....	12	Document bag.....	24
Trip meter.....	12	Tool kit holder.....	24
<u>Indicators / Warning Lamps</u>	13	<u>Fuel Supply</u>	25
Speed warning.....	13	Fuel cock.....	26
Oil pressure warning.....	13	<u>Basic Operation</u>	27
Coolant temperature warning.....	14	Starting the engine.....	27
Turn signal indicator.....	15	Changing gear.....	30
High beam pilot lamp.....	15	Riding tips.....	31
Neutral indicator.....	15	Braking.....	33
<u>Switches</u>	16	Suspension – Rear.....	35
Ignition switch.....	16	Suspension – Front.....	36
Head lamp dimmer switch.....	17		
Engine stop switch.....	18		
Horn switch.....	19		
Turn signal switch.....	20		

Contents

MAINTENANCE SAFETY TIPS	37		
Maintenance	40	Fuses and relays.....	64
Daily inspection.....	40	Inspection / replacement.....	64
Regular service.....	45	Tyres	66
Maintenance Schedule	46	Pressure.....	66
Basic maintenance	49	Tread.....	66
Engine oil.....	50	Replacement tyres.....	67
Transmission oil.....	51	Air Filter	68
Adding Oil.....	51	Air filter element replacement.....	68
Coolant.....	54	<u>Cleaning</u>	69
Coolant level.....	54	<u>Damper Unit</u>	71
Adding coolant.....	55	<u>For our environment</u>	71
Drive Chain.....	56	<u>Colour labels</u>	72
Chain tension.....	56	<u>Genuine Honda mufflers</u>	73
Lubrication / Cleaning.....	57	<u>Vehicle Identification Number</u>	74
Brakes	58	<u>Overheat</u>	75
Front brake.....	58	<u>Engine does not start</u>	76
Brake fluid level.....	57	<u>Specifications</u>	77
Brake pads wear.....	59	<u>Service Data and Noise Warning</u>	80
Rear brake.....	60		
Brake fluid level.....	58		
Brake pads wear.....	61		
Clutch.....	62		
Clutch free play adjustment.....	63		

For Your Own Safety

- The topics described here are the basic instructions for handling the vehicle.

Please follow the instructions from your owner's manual.

Before Riding

- Please conduct the daily inspection. Keep the vehicle clean at all times and inspect the specified items.
- Please conduct the regular service.

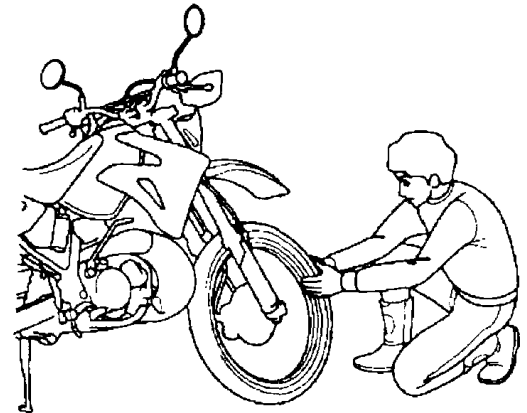

For Your Own Safety

- Stop the engine before refueling and keep well clear of naked flames.
- Exhaust gas is toxic. Operate the engine in a well-ventilated place.

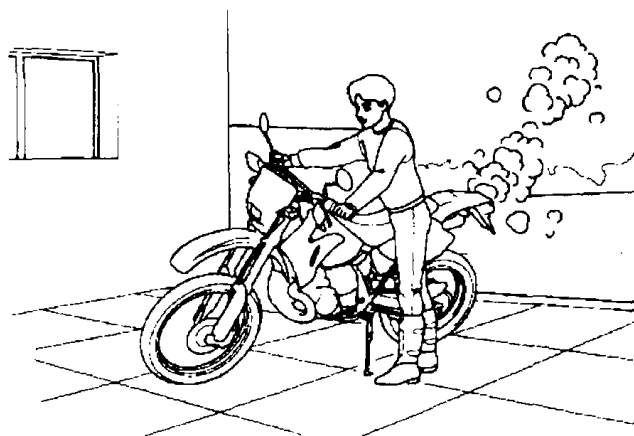
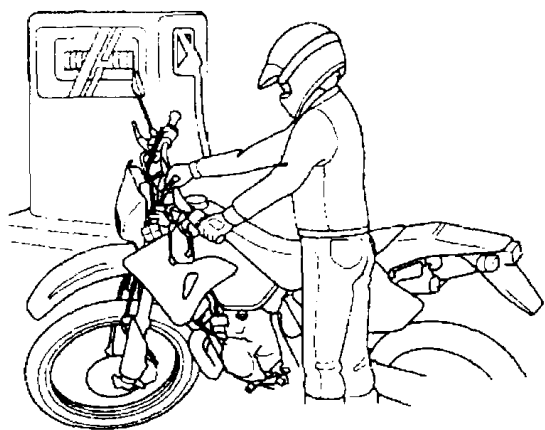

For Your Own Safety

Protective apparel

- *Both rider and passenger are required by law to wear a helmet. Secure the chin- strap properly. Helmets approved to AS1698 are the only legal helmets in Australia.*
- Wear protective clothing and gear such as:
 - Face shield or goggles.
 - Motorcycle boots or any footwear that covers the ankles.
 - Leather gloves.
 - Long pants and a long sleeved jacket.

Riding apparel should be bright or reflective.
Allow freedom of movement.
Avoid flared pants and loose sleeved jackets, which could get caught with the brake and gear shift pedals.



Caution

Wearing the helmet incorrectly increases the risk of serious injury or death in an accident.
Both rider and passenger must wear helmets, protective gear and protective clothing.

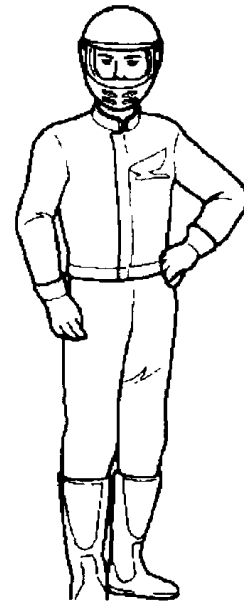

For Your Own Safety

Riding Tips

- Keep both hands on the handlebars and both feet on the footpegs at all times whilst in motion.
- The pillion passenger should place both feet on the rear footpegs and use both hands to stay in position. It is the rider's responsibility to check that the passenger is positioned correctly.
- Do not jerk the handlebars or attempt to ride with only one hand. This safety rule applies to any two-wheeled vehicle.

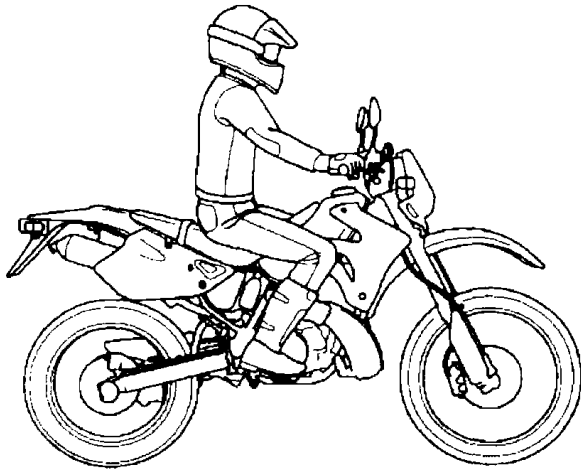

7

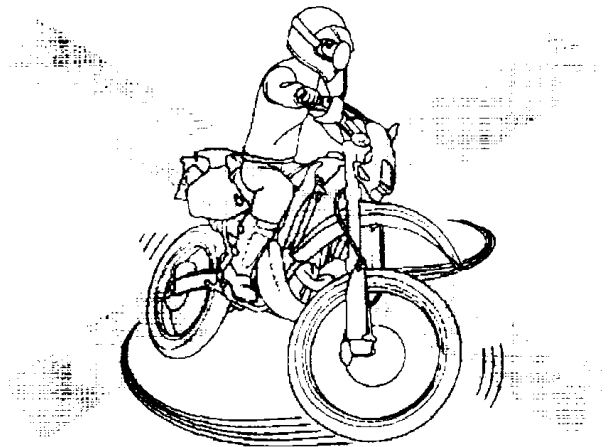

For Your Own Safety

Luggage

- Controllability and stability of the vehicle changes by loading luggage. Be careful in terms of loading and securing the luggage.
- Do not place any items around the steering handle. It may obstruct the steering.
- Do not place any items in front of the headlamp. It may melt the lens or damage the item itself.

Modification

Any modification which affects the function and the structure of the vehicle may affect the controllability and exhaust noise, which may affect the durability of the motorcycle.

Any illegal modification may cause inconvenience to the surroundings. Any damage caused by these modifications is totally out of our warranty.

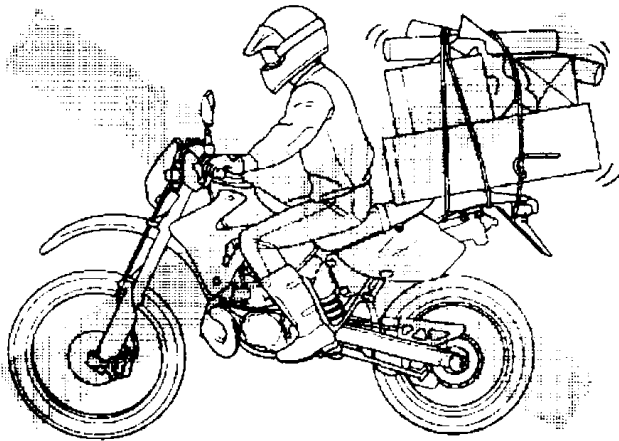

For Your Own Safety

Parking

- Park on stable and flat ground.
- Do not obstruct the traffic flow when parking your vehicle.
- Park the vehicle so as to keep the hot muffler away from other people.
- While running the engine or immediately after shutdown, do not touch the engine or muffler.



Notes

- Do not touch the muffler or the engine while the engine is running or immediately after shutdown.
- Park the motorcycle so that the engine and the muffler can be kept away from other people.

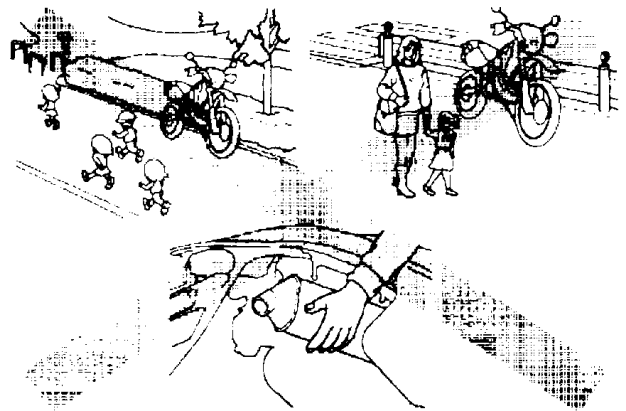

Parking with the sidestand

- Park on flat and stable ground with the handlebars turned fully to the left. The vehicle may have difficulty staying upright in the following circumstances:
 - The handlebars turned to the right.
 - Parked on sloped, soft, sandy or bumpy ground.

If there is no other choice, take maximum **9** precautions to keep the vehicle stable.

Parts

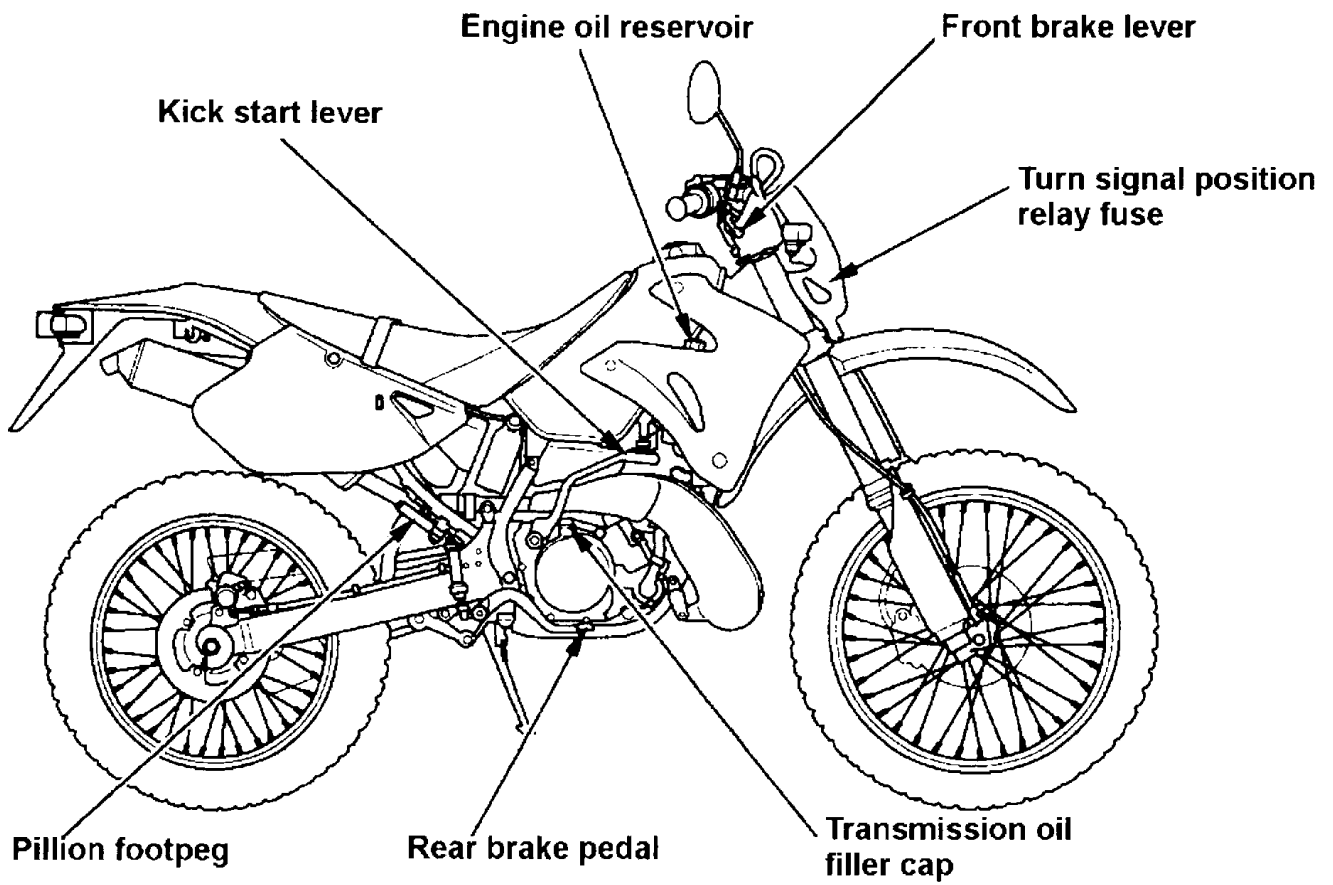

Parts

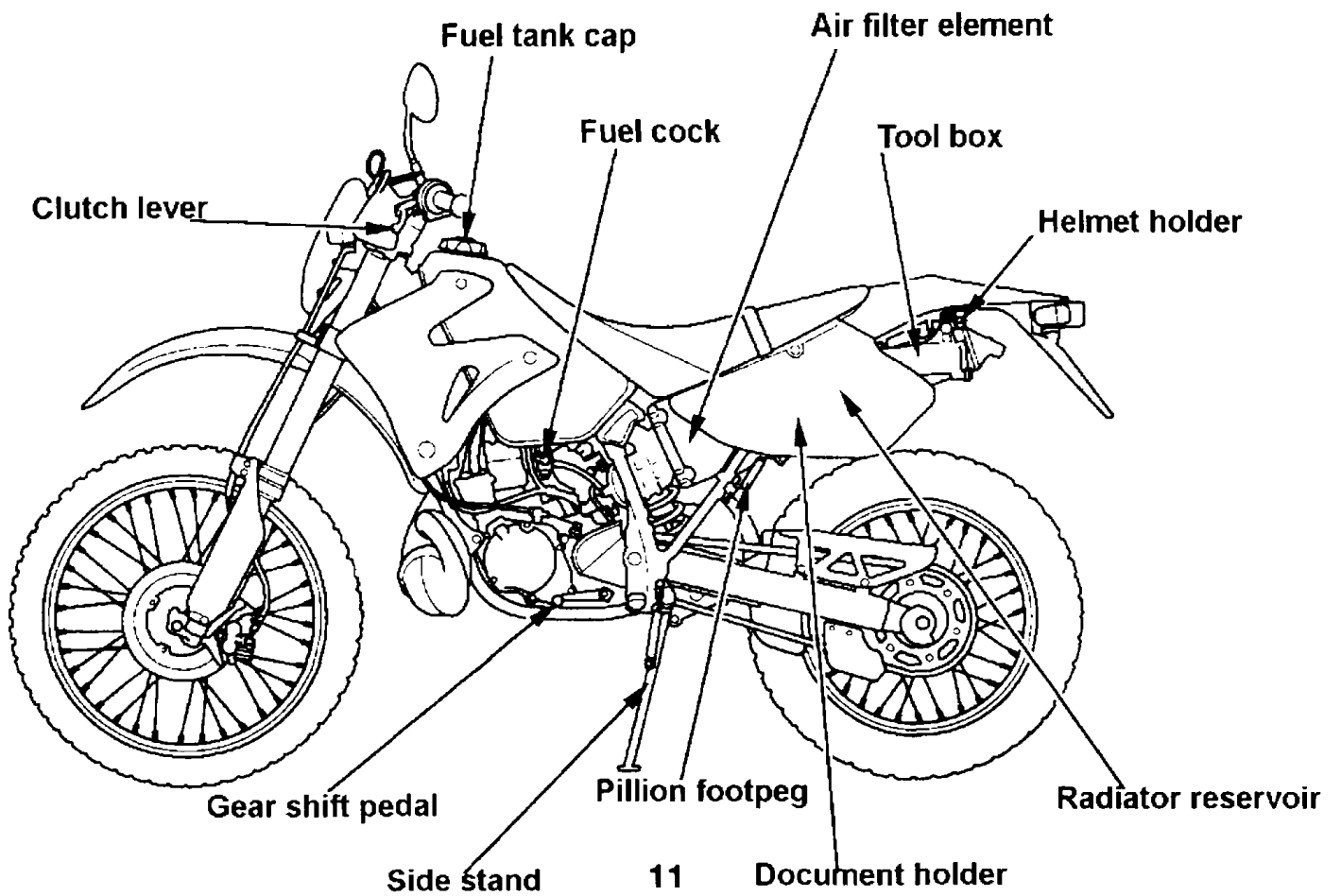

Instruments and Indicators

Instruments and Indicators

Instruments

Speedometer

Indicates the travelling speed.
Ride safely and observe the legal speed limit.

Odometer

Shows accumulated distance traveled in kilometres.
The black number on white background shows 100m increments.

Tripmeter

Shows distance traveled per trip.
Reset to zero by rotating the reset knob in the direction of the arrow as shown.

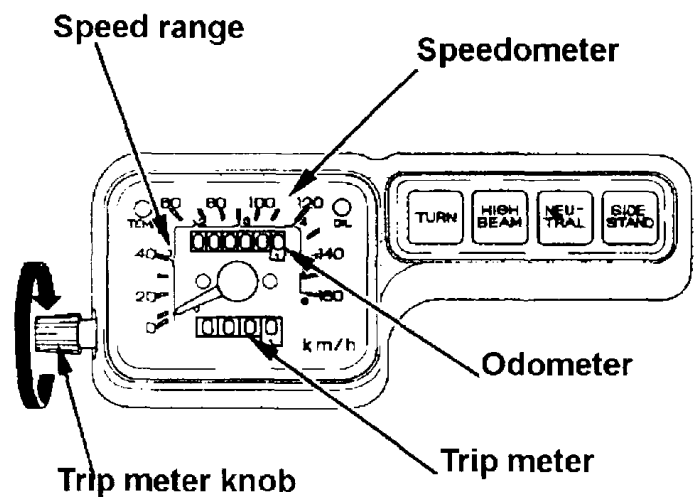

Indicators / Warning Lamps

Indicators / Warning lamps

Speed warning lamp (optional)

Illuminates when the speedometer indicates approx 85km/h.

Oil pressure warning lamp

Lights when the oil pressure drops while the engine is running. Should the warning lamp light while the engine is running, stop immediately and check the oil level. If there is sufficient oil or if the lamp stays on after refilling the oil, contact an authorized Honda dealer as soon as possible.



Advice

Riding with the oil pressure warning lamp "ON" could result in damaging the engine. Such damage will not be covered by Warranty.



Tip

In normal operation, the oil pressure warning lamp turns on when the main switch is turned ON, and it turns OFF when the correct oil pressure is reached.

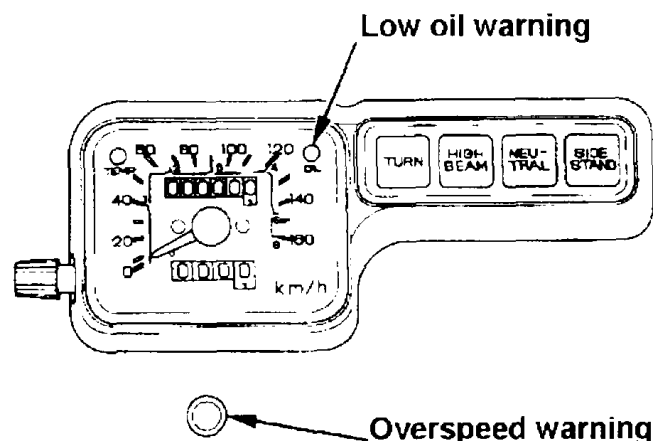

Indicators / Warning Lamps

Coolant temperature warning lamp

Lights when the coolant temperature rises beyond a certain limit while the engine stop switch is in the (run) position and the ignition switch is "ON".

If the lamp lights when the engine is running, stop the engine immediately and check the coolant level (p.54).



Advice

Continuing riding with the lamp "ON" (overheating) may result in damaging the engine.

Such damage will not be covered by Warranty.



Tip

Normally the lamp lights when the engine stop switch is in the (run) position and the ignition switch is turned ON and it turns OFF after a few seconds. It lights for a few seconds when the engine is stalled, which is not a fault.



Tip

Prolonged idling during hot weather can cause the warning lamp to light. In this case, you have to cool the engine either by taking a gentle ride or by turning the engine off.

Water temp. warning

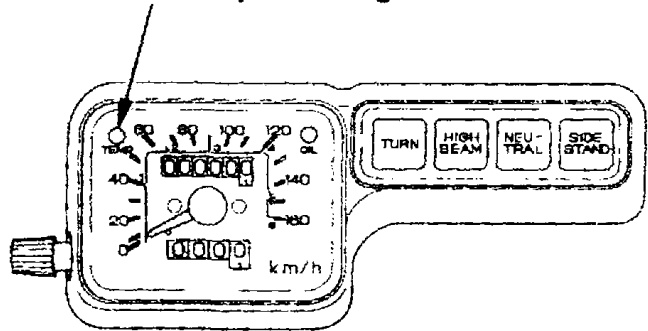

Indicators / Warning Lamps

Turn Signal Indicator

Flashes when the turn signal is ON.

High Beam Pilot Lamp

Lights if the high beam is selected.

Neutral Indicator

Lights if the engine is in neutral gear and the main switch key is at ON position.

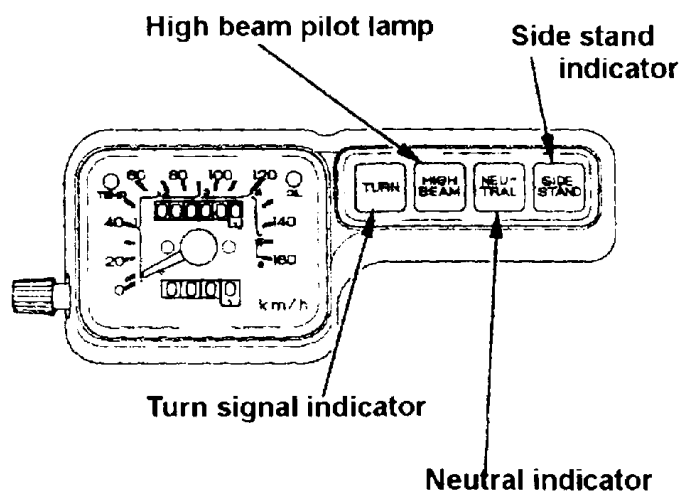

Switches

The ignition switch operates the electrical circuits.

Do not touch the switch whilst riding.

Turning the ignition switch to "OFF" or "LOCK" will prevent the engine from starting.



Advice

- The headlamp turns "ON" when the engine is started.



Tips

- Lock the handlebars and pull the key out whenever you leave the vehicle.

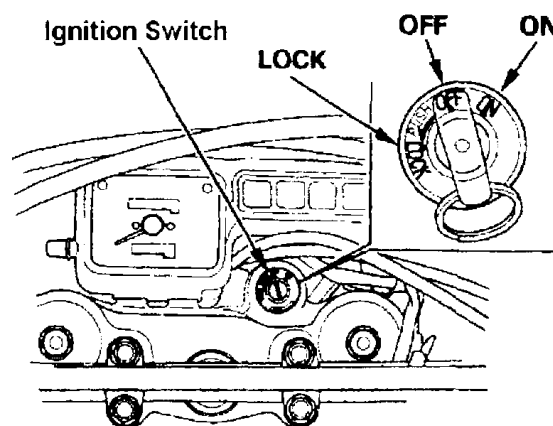

Key position	Function	Remove Key
ON (With Engine Running)	Start, day/night ops <ul style="list-style-type: none"> Headlamp "ON" Able to use turn signals, horns, and stops lamps. 	Unable
OFF	Stop <ul style="list-style-type: none"> All electrical systems disabled 	Yes
LOCK	Handlebar lock engaged <ul style="list-style-type: none"> All electrical systems disabled 	YES

Switches

Headlamp Dimmer Switch

Push the corresponding side of the switch.

- (Hi) High beam
- (Lo) Low beam

Select LO (low beam) during the day.

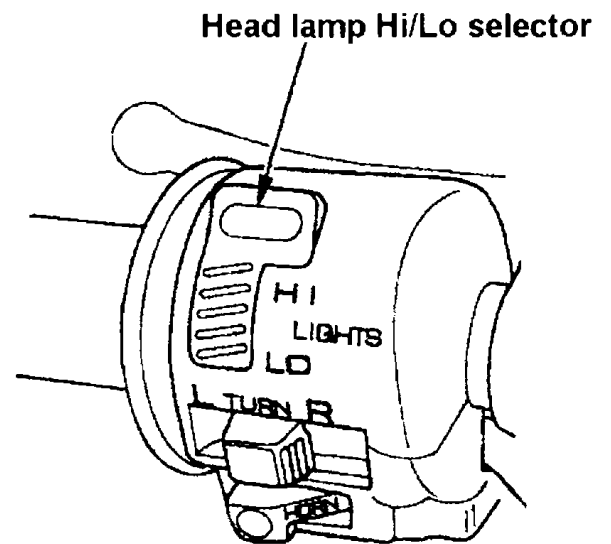

Switches

Engine Stop Switch

The engine stop switch allows you to stop the engine immediately in an emergency situation.

The engine stop switch should be left in RUN position during normal riding and used only in case of emergency.

Switching between RUN and OFF whilst riding leads to unstable engine running and riding instability. It may also damage the engine.



Advice

If using this switch in an emergency stopped engine, turn the ignition switch OFF to avoid battery becoming flat.

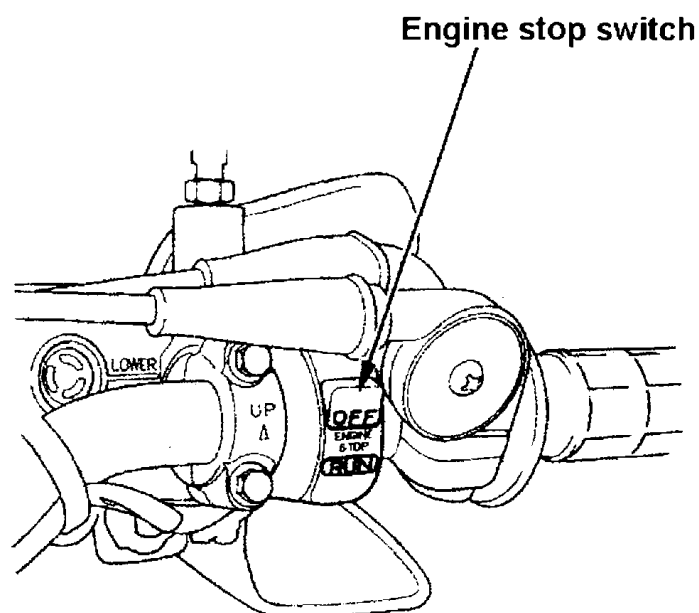

Switches

Horn Switch

The horn sounds by pushing the horn switch when the ignition switch is ON.

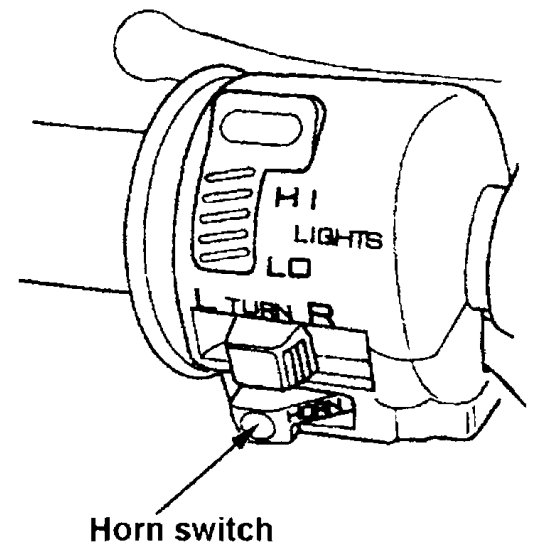

Turn Signal Switch

The turn signal switch is used to operate the turn signal lamps when turning left or right or changing lanes. The engine must be running.

Push the switch to the turning direction.
Push in to cancel.



Tip

- The turn signal does not cancel automatically. Always cancel the switch after turning to avoid confusing other drivers.
- Use correct wattage bulbs. Incorrect wattage bulbs may affect the rate at which the Indicators flash.

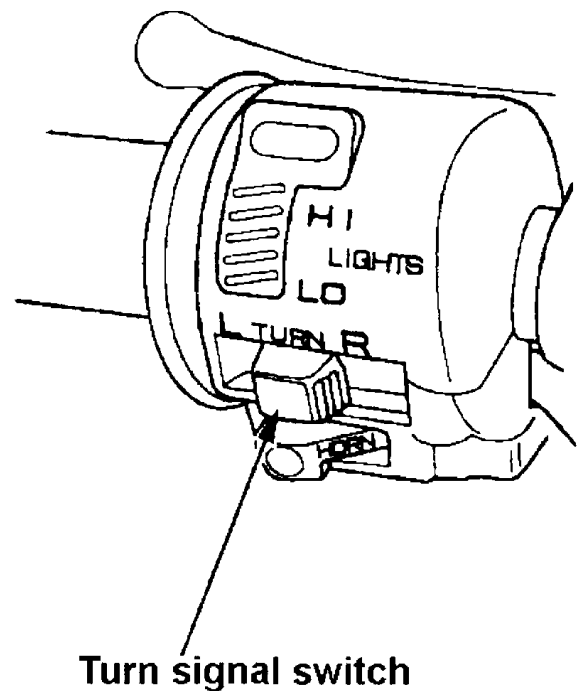

Switches

Handlebar Lock

To prevent theft, always apply the handlebar lock when parking. Use of a chain lock or similar device is also recommended.

To engage the lock

1. Turn fully to the left or right.
2. Insert the key to the ignition switch.
3. Push the key in and turn it to "Lock" position.
4. Remove the key.

To disengage the lock

Follow the above procedure in reverse order.

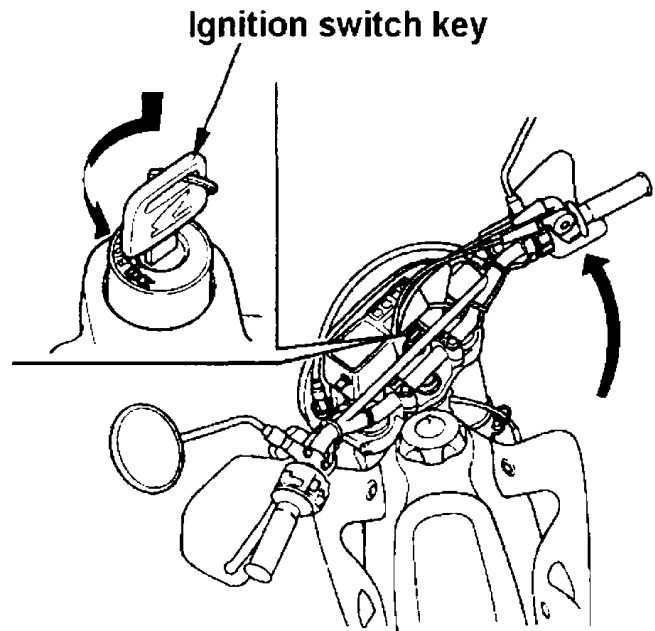

Tip

Park in a safe place away from traffic. Jiggle the handlebar to check the lock is engaged.

Installation

1. Set the projection of the seat to the tank guide to attach the seat.
2. Push the rear end of the seat down to locate the mounting holes on either side.
3. Insert and tighten the 2 x 12mm bolts.
4. Pull up on front of seat to ensure it is secure.
5. Refit side covers – insert front locating lug into frame bracket and lock rear mounting screw.

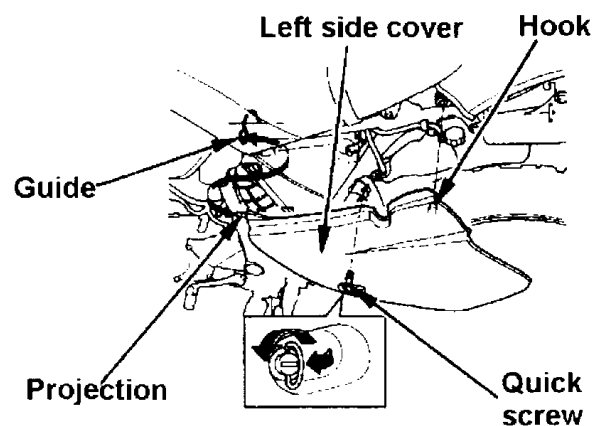

Removal

1. Remove both side covers
2. Remove 2 x 12mm screws from seat mountings.
3. Slide seat back and lift up.

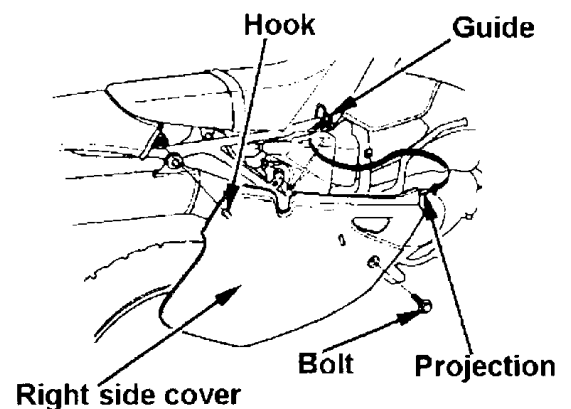

Helmet Holder

Helmet Holder

The helmet holder may only be used when the motorcycle is parked. Using the holder will interfere with the operation and may damage the motorcycle. Also it will damage the helmet, reducing its protection.

To use the helmet holder

1. Remove the seat
2. Pass the helmet holder wire through the ring on the helmet strap and hook to the helmet holder.

Keep the helmet holder wire in storage when the holder is not in use.

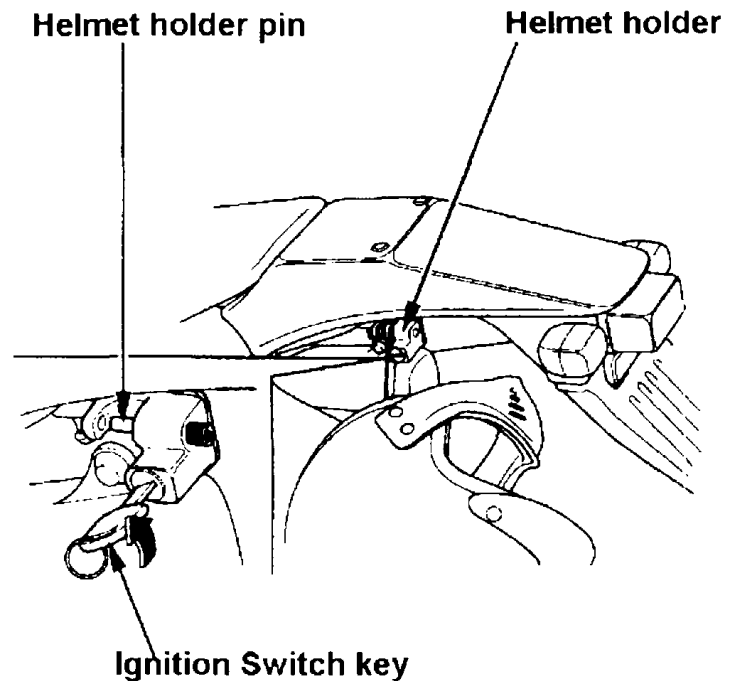

Document Holder

Document Holder

The document holder is located under the left hand side cover.

Keep the owners manual and the service manual in a plastic bag and store in the holder.

- Refer to pg22 to remove the left hand side cover.



Tip

When washing the motorcycle, do not apply water from underneath to prevent water going inside the seat.

Tool Kit Holder

The tool kit holder is located under the rear fender.

Use the ignition key open/close the tool kit holder.

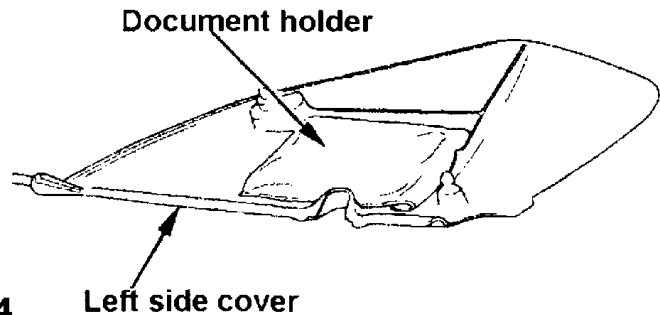
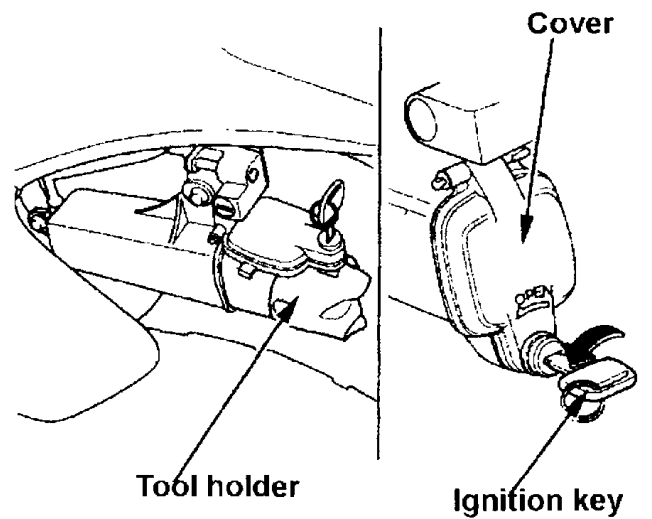

Fuel Supply

The CRM250AR uses only unleaded petrol. Always stop the engine before refueling and keep well clear of naked flames, sparks or heat sources.



Caution

Petrol is highly flammable. Improper handling will result in severe injury.

When handling the petrol:

- Always stop the engine and keep away from flames, sparks or heat sources.
- Refuel outside.
- Wipe off spilled petrol straight away.

Refueling

1. Lift up the key cover. Insert the ignition key and turn to the right to open the fuel fill cap.

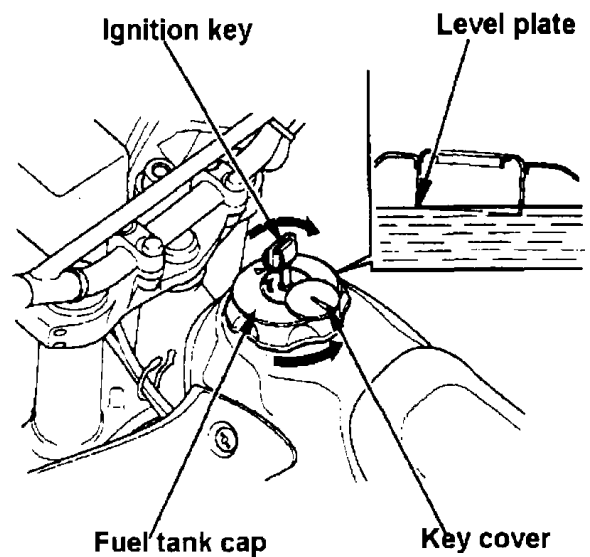

Fuel Supply

- Do not fill higher than the bottom of the filler neck (see diagram) or petrol may seep out through the breather hole on the fuel tank cap.
- Close the cap firmly and remove the key.
The key cannot be removed unless the cap is properly locked.

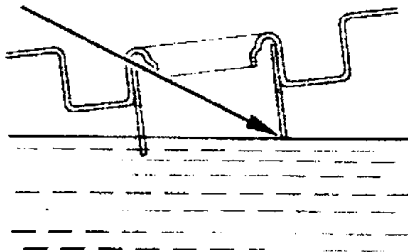

Fuel Cock

The fuel cock lever has three positions:

“ON” fuel supplied to carburettor when the engine starts.

“OFF” select when the motorcycle is not in use for a long period or being serviced.

“RES” reserve fuel tank (holds approx 2 litres of fuel) is selected. Turn to RES when you run out of fuel in ON position whilst riding. Refuel as soon as possible and turn back to ON to prevent complete fuel starvation.

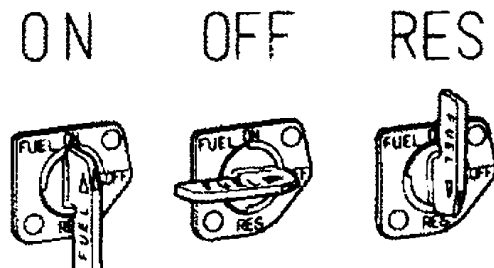

Basic Operation

Starting the Engine

Engine exhaust fumes contain carbon monoxide and other harmful substances. Always start the engine in well ventilated area.



Advice

- Do not rev the engine unless required to do so. Abrupt throttle movement wastes fuel and may damage the engine.



Tip

- This model is equipped with an automatic ignition cut off circuit that stops the engine automatically if the gearshift is set while the side stand is still down. Always retract the side stand before selecting a gear.

Basic Operation

Starting Procedure

- When the engine is cold:
 1. Check the engine stop switch is in RUN position.
 2. Check the fuel cock lever is in ON position.
 3. Turn the ignition ON.
 4. Shift the gear change pedal to neutral position and check that the neutral indicator is ON.
 5. Pull the choke lever all the way back.
 6. Close the throttle and operate the kick start lever rapidly.
 7. When the engine starts, gradually push the choke lever forward and warm up the engine until the rpm stabilizes, then push the choke lever all the way forward.
 8. Check the side stand is retracted before riding.
- Refer to p76 if the engine fails to start. **28**

Basic Operation

Starting Procedure

- When the engine is hot:
 1. Check the engine stop switch is in the "RUN" position.
 2. Check the fuel cock lever is in the "ON" position.
 3. Turn the ignition switch "ON".
 4. Shift the gear change pedal into neutral position and check the neutral indicator is "ON".
 5. Close the throttle and operate the kick start lever rapidly.
If the engine fails to start after one or two trials, follow procedure 6.
 6. If the engine does not start with the throttle closed, open the throttle to 7 ~ 3 as shown in the diagram operate the kick start lever rapidly.
 7. Check the side stand is retracted before selecting a gear.

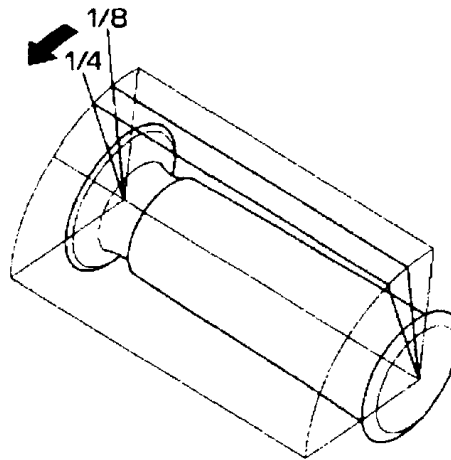

Refer to p 76 if the engine fails to start

Changing Gears

Changing Gear

The CRM250AR has a six speed return gear change:

- Release the throttle and fully squeeze the clutch lever before selecting / changing gear.
- Operate the gear shift pedal gently but firmly using your toe (excessive force may damage the gear change system). You should be able to feel the gear changer click solidly into place.

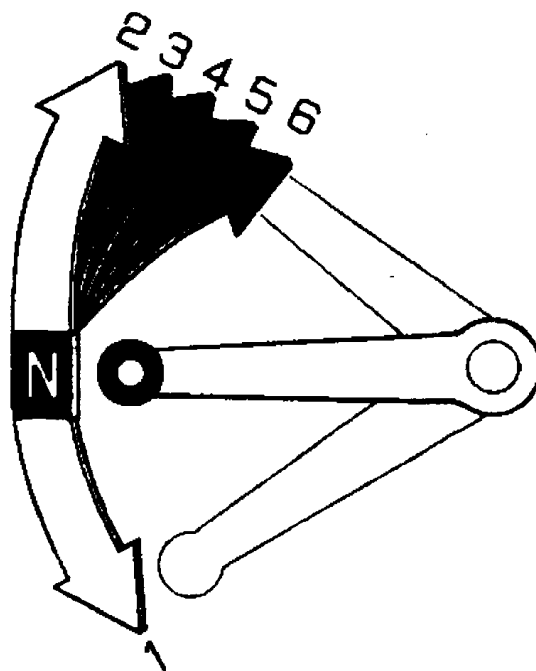

Riding Tips

Riding Tips

- Check the side stand is retracted before riding – selecting a gear.
- Use the gears within the speed ranges given in the table.
- To save fuel and prolong the life of the motorcycle, avoid rapid acceleration or deceleration.

Gear	Speed Range
1 st	0-40 km/h
2 nd	10-65 km/h
3 rd	20-90 km/h
4 th	30-120 km/h
5 th	40-145 km/h
6 th	60 km/h and above



Advice

If you notice any unusual sound or other problems, contact an authorized HONDA dealer as soon as possible.



Tip

- Accelerate as gently as possible.
- Always observe the speed limit.

Running In

Keep the engine in relatively lower rpm and avoid rapid acceleration and deceleration for the first 500km. This will prolong the life of the engine.

Riding Tips

Changing down the gears

Changing down gears provides greater acceleration in situation such as overtaking. Avoid changing down at high speed, which can damage both the engine and the transmission by running the engine at excessively high rpm.

The table shows the maximum speed for each shift down.

	Maximum Speed
6 th - 5 th	140 km/h & below
5 th - 4 th	120 km/h & below
4 th - 3 rd	80 km/h& below
3 rd - 2 nd	60 km/h& below
2 nd - 1 st	40 km/h& below



Notes.

Damage caused by incorrect Gear changing will not be covered by warranty.

Braking

- For optimum braking performance, apply front and rear brakes simultaneously.
- Brake as gently as possible to avoid locking the tyres which makes the motorcycle unstable / uncontrollable.
- In wet weather and surface, the tyres become more likely to lock and slide, therefore the stopping distance increases. Reduce the riding speed and allow longer braking distance under such circumstances.
- Avoid continuous braking to prevent overheating the brake system which causes brake fade and reduces the braking performance.
- Braking performance may be affected by puddles and wet weather. Always test the brakes gently after riding through such a condition (keep clear of the other traffic and slow down first). If necessary, apply the brakes periodically whilst riding at reduced speed until they dry out.

Engine braking

Engine braking can be used to reduce speed instead of or in combination with, the brakes by simply retarding the throttle.

Shift down gears if necessary.

Avoid abrupt shift down or the motorcycle may fishtail.

Use a combination of the engine braking and the intermittent braking on long or steep downhill slopes.

Rear Suspension

Rear Suspension

1. Suspension feel can be altered between Hard and Soft by adjustment of the screw on remote reservoir.
2. By turning the screw clockwise, you will increase compression damping of the rear suspension unit.



Notes.

Adjustment of this screw will affect handling characteristics of your motorcycle. Do not adjust if you do not understand the operation of the rear suspension.

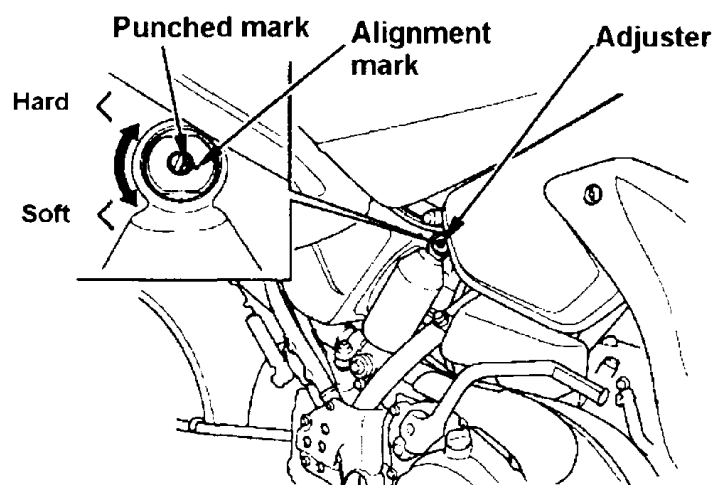

Front Suspension

Front Suspension

1. Compression damping adjustment.
2. This adjustment affects how quickly the fork compresses.
3. Turning the screw clockwise will increase compression damping of the front fork leg unit.



Notes.

Adjustment of this screw will affect handling characteristics of your motorcycle. Do not adjust if you do not understand the operation of the front suspension.

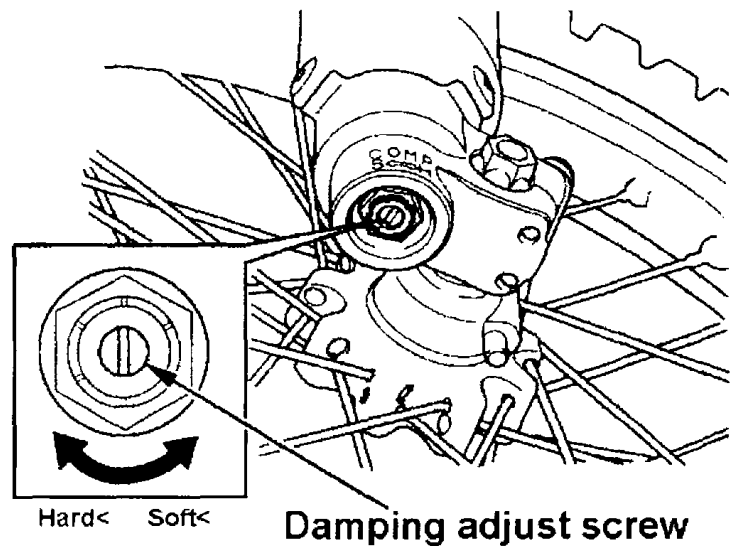

Maintenance Safety Tips

Maintenance Safety Tips

- Stop the engine and remove the key when servicing.
- Park on a flat and stable surface using the side stand.

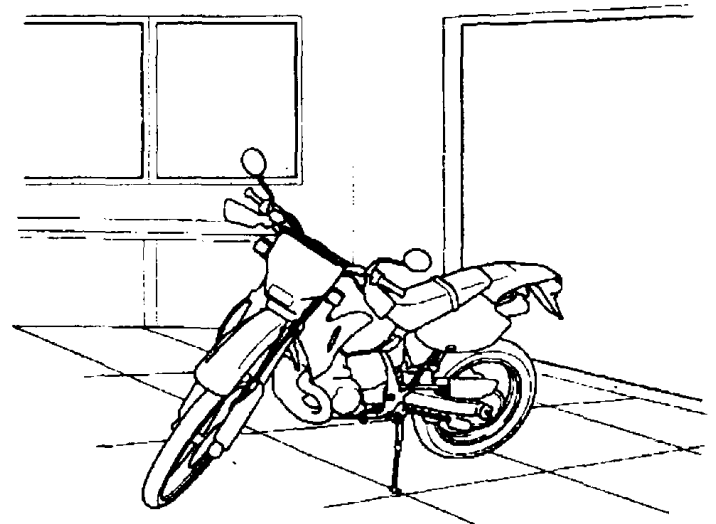
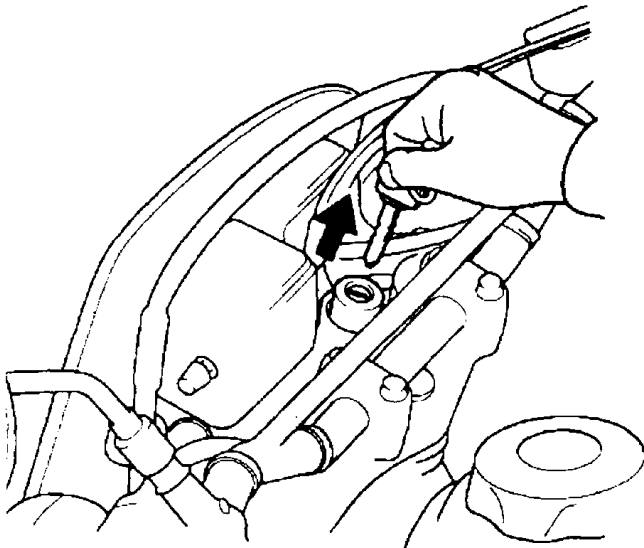

Maintenance Safety Tips

- Wait for the engine, the muffler and the exhaust pipe to cool before starting work.
- Engine exhaust fumes contain carbon monoxide and other harmful substances. Do not run the engine in poorly ventilated area such as a closed workshop.

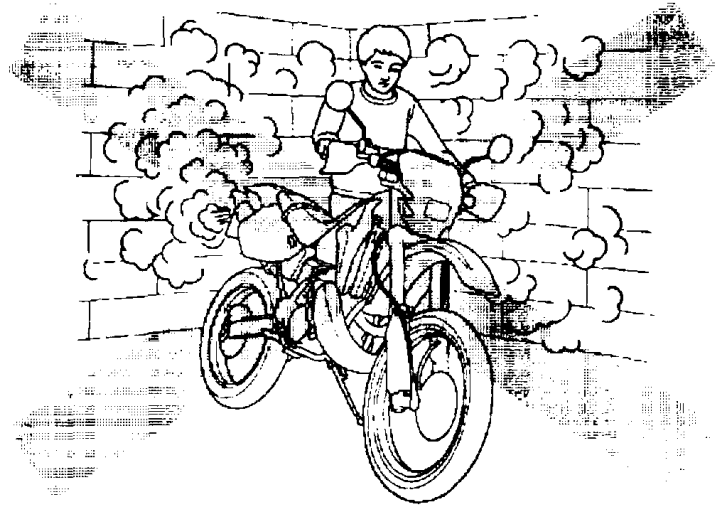
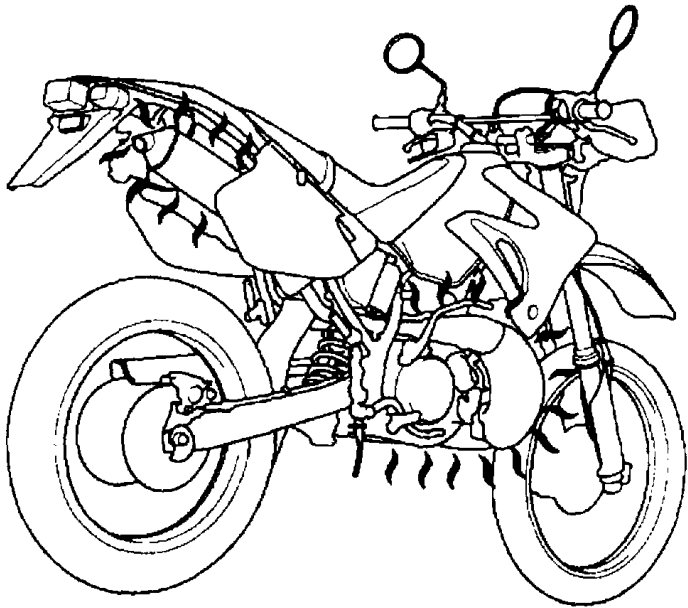

Maintenance Safety Tips

- If the motorcycle requires test riding, conduct in a safe place, away from other traffic.
- Always use proper tools.
- Any servicing, repair or adjustment should be carried out by an authorized Honda dealer.

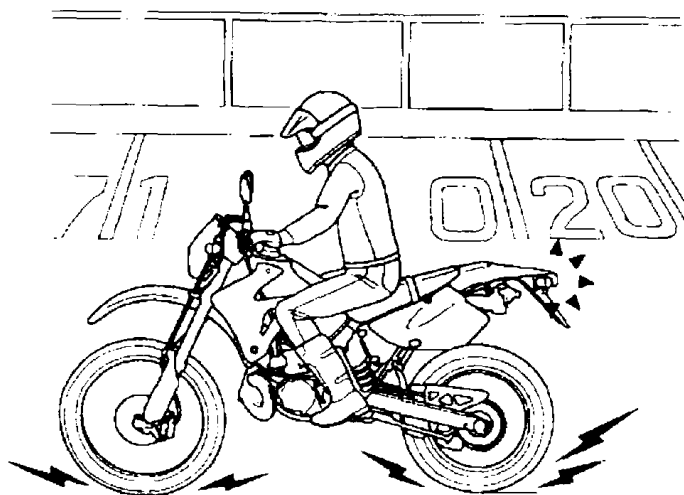

Maintenance

- To ensure the safety and comfort of riding your motorcycle, it is required to inspect some items daily and service the machine regularly.
- Inspection and maintenance procedures and requirements are described on the following pages.



Caution

Always comply with the correct servicing procedure. Failure to do so could result in fatal or severe injury.

- Follow the procedures and guidelines given in this owner's manual and the service manual.
- Observe all service and maintenance schedules.
- Fix all problems before you ride.

After the first month.....	41
Replacement parts.....	41
Daily (pre-ride) inspection.....	42
Maintenance parts layout.....	43
Regular service.....	45
Maintenance Schedule.....	46
Basic maintenance.....	49
Engine oil.....	50
Coolant.....	54
Drive Chain.....	56
Brakes.....	58
Clutch.....	62
Fuses.....	64
Tyres.....	66
Air filter.....	68

Maintenance

After the first month

The first service after one month (or 1000km) is crucial to the life of the engine. Contact an authorized Honda dealer for all service requirements.

Your Honda dealer has all the expertise and technical information necessary to correctly service or repair your machine.

Replacement parts

Use only genuine Honda parts when servicing the motorcycle.

Honda parts are designed specifically for Honda vehicles and are subject to rigorous examination procedures.

Honda parts are available from authorized Honda dealers and are identified by the Honda logo.

Only Honda genuine parts are covered by a manufacturers warranty.

(12mths / unlimited kms).

Some conditions apply.



Maintenance

Daily (pre-ride) Inspection

All motorcycle riders are advised to carry out a daily pre-ride inspection to ensure safe and comfortable riding.

Details of the daily inspection are given below. Underlined items are described in "Basic Maintenance" (p. 49~).

The diagrams on the following pages show the inspection parts.

Daily (pre-ride) Inspection Checklist

- **Brakes** - Lever free play (hydraulic)
 - Pedal free play (hydraulic)
 - Braking performance
 - Brake fluid level
- **Tyres** - Air pressure
 - Cracks / damage
 - Abnormal wear
 - Tread (x)
- **Engine** - Coolant level (x)
 - Engine oil level (4-stroke only) (x)
 - Starting noise (x)
 - Low speed / acceleration (x)
- Lamps and turn signals
- Any problems detected on the previous day.

(x) ≙ Check as appropriate in line with usage time and distance traveled.

Maintenance

Maintenance Parts Layout

Maintenance procedures and guidelines are given in "Basic Maintenance" pages of this manual.

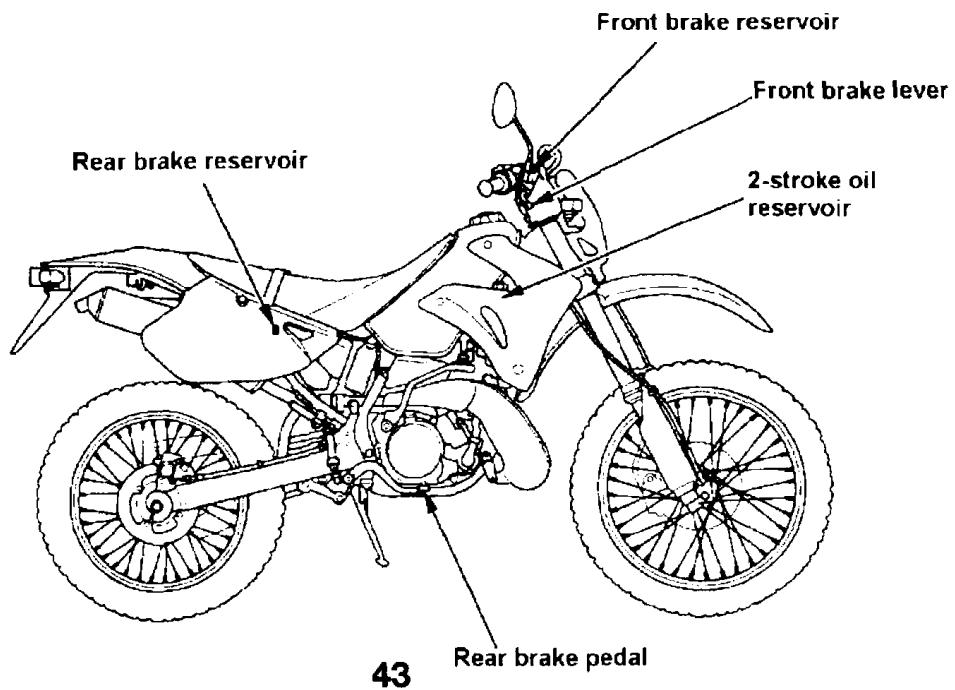

43

Rear brake pedal

Front brake reservoir

Front brake lever

2-stroke oil
reservoir

Rear brake reservoir

Maintenance

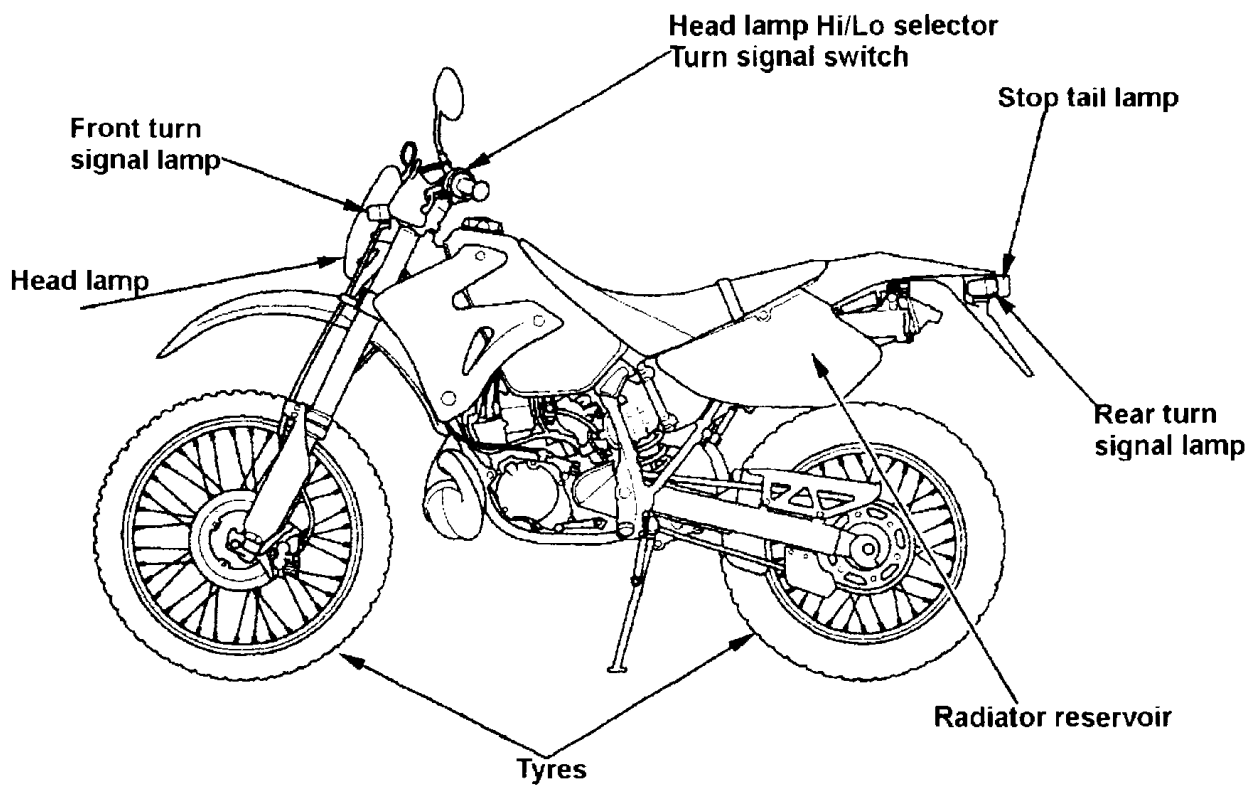

Maintenance

Regular Service

The CRM250AR requires the first one month (or 1000km) service and every 6000km thereafter.

For optimum safety and comfort, conduct these regular services.

It is your responsibility to have your motorcycle serviced by an authorized Honda dealer.

Specifications are given on pages 77, 78 & 79.

Record the results of every service in the service manual maintenance log and store in a safe place.

- Contact your Honda dealer to arrange servicing.
- If you are checking the motorcycle by yourself, do not carry out work beyond your knowledge and skill, for your own safety.
All repair work should be referred to an Authorized Honda Dealer.
- These instructions are based on the assumption that the motorcycle will be used exclusively for its designed purpose. Sustained high speed operation, or operation in unusually wet or dusty conditions will require more frequent service than specified in the MAINTENANCE SCHEDULE.
- Consult your authorised Honda dealer for recommendations applicable to your individual needs and use.

Maintenance Schedule

Maintenance Schedule

The following Maintenance Schedule specifies all maintenance required to keep your motorcycle in peak operating condition. Maintenance work should be performed in accordance with standards and specifications of Honda by properly trained and equipped technicians. Your authorised Honda dealer meets all of these requirements. Perform the Pre-ride Inspection (page 42) at each scheduled maintenance period.

I: INSPECT AND CLEAN, ADJUST, LUBRICATE OR REPLACE IF NECESSARY
 C: CLEAN R: REPLACE A: ADJUST L: LUBRICATE

ITEM	FREQUENCY	NOTE	ODOMETER READING [NOTE (1)]								*Refer to Service Manual
			X 1,000km	1	6	12	18	24	30	36	
			X 1,000mi	0.6	4	8	12	16	20	24	
		MONTH		6	12	18	24	30	36		
* FUEL LINE					I				I	-	
* THROTTLE OPERATION					I				I	-	
* CARBURETTOR CHOKE					I				I	-	
* AIR CLEANER	(NOTE 2)				I	I	R	I	I	R	
CRANKCASE BREATHER	(NOTE 3)				C	C	C	C	C	C	
SPARK PLUG					I	R	I	R	I	R	
* VALVE CLEARANCE				NA	-	-	-	-	-	NA	
ENGINE OIL				R	R	R	R	R	R	R	
ENGINE OIL FILTER				R		R		R		R	
* CARBURETTOR SYNCHRONISATION				NA	-	-	-	-	-	-	
* ENGINE IDLE SPEED					I	I	I	I	I	I	
RADIATOR COOLANT	(NOTE 4)					I		I		R	
* COOLING SYSTEM						I		I		I	

Maintenance Schedule

ITEM	FREQUENCY	NOTE	ODOMETER READING [NOTE (1)]								*Refer to Service Manual
			X 1,000km	1	6	12	18	24	30	36	
			X 1,000mi	0.6	4	8	12	16	20	24	
			MONTH	6	12	18	24	30	36		
DRIVE CHAIN			EVERY 1,000km (600mi) I, L								*
DRIVE CHAIN SLIDER				I		I		I		-	
BRAKE FLUID		(NOTE 4)		I	I	R	I	I	R	-	
BRAKE SHOE / PAD WEAR				I	I	I	I	I	I	-	
BRAKE SYSTEM				I		I		I		-	
* BRAKE LIGHT SWITCH					I		I		I	-	
* HEADLIGHT AIM					I		I		I	-	
CLUTCH SYSTEM				I	I	I	I	I	I	-	
SIDE STAND					I		I		I	-	
* SUSPENSION					I		I		I	*	
* NUTS, BOLTS, FASTENERS				I		I		I		-	
** WHEELS / TYRES					I		I		I	-	
** STEERING HEAD BEARINGS				I		I		I		*	

Maintenance Schedule

- ← *SHOULD BE SERVICED BY YOUR AUTHORISED HONDA DEALER, UNLESS THE OWNER HAS PROPER TOOLS AND SERVICE DATA AND IS MECHANICALLY QUALIFIED, REFER TO THE OFFICIAL HONDA SHOP MANUAL.*
- ← ← *IN THE INTEREST OF SAFETY, WE RECOMMEND THESE ITEMS BE SERVICED ONLY BY YOUR AUTHORISED HONDA DEALER.*

Honda recommends that your authorised Honda dealer should road test your motorcycle after each periodic maintenance is carried out.

- NOTES:
1. At higher odometer readings, repeat at the frequency interval established here.
 2. Service more frequently when riding in unusually wet or dusty areas.
 3. Service more frequently when riding in rain or at full throttle.
 4. Replace every 2 years, or at indicated odometer interval, whichever comes first. Replacement requires mechanical skill.

Basic Maintenance

Basic Maintenance

This section describes basic maintenance procedures that should be performed on a regular basis.

Do not carry out any work beyond your knowledge and skill, and always use proper tools.

Contact an Authorized Honda Dealer if you do not have proper tools or skills required for a particular job.

Engine Oil Reservoir

Engine Oil Reservoir

1. The engine on the CRM250 operates on a two(2) stroke mix. Oil input is controlled by an oil injection pump.
2. Two stroke oil is held in a reservoir located behind right hand radiator shroud.
3. To remove oil filler cap, you must first remove the radiator shroud by taking out the two (2) screws and one (1) bolt.
4. By releasing the steel clip, you can remove the oil filler cap.
5. Use only a high quality two (2) stroke oil.
6. Fill reservoir to oil level gauge indicated on upper part of reservoir. (Refer diagram).

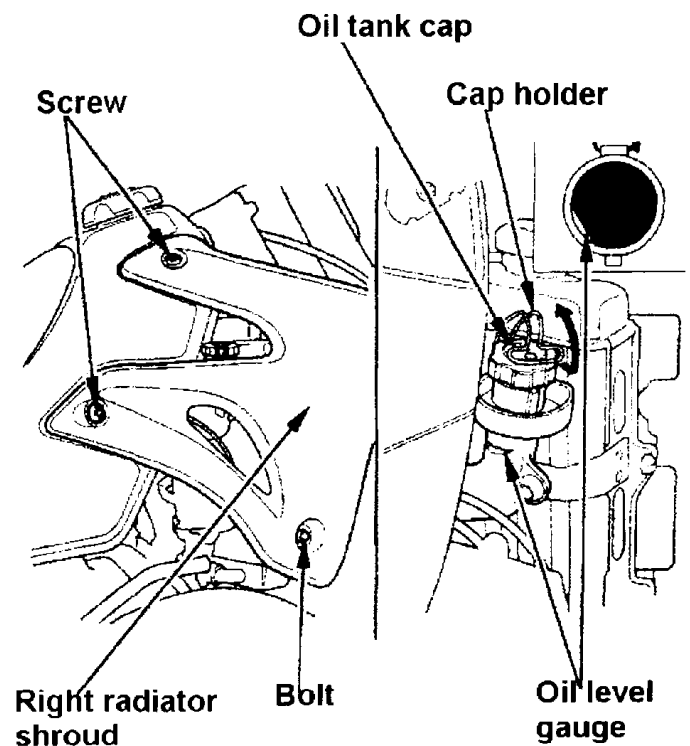

Transmission Oil

Transmission Oil



Notes.

The engine, the muffler and the exhaust pipes are extremely hot after stopping the engine.

Transmission oil should be checked as part of your pre-ride inspection.

1. To check transmission oil, hold bike in an upright position. Ensure bike is on level ground.
2. Remove check bolt.
3. The oil level should be up to the lower threads of the check bolt hole.
4. To add oil, remove filler cap and pour in the recommended transmission oil until it is at the correct level.

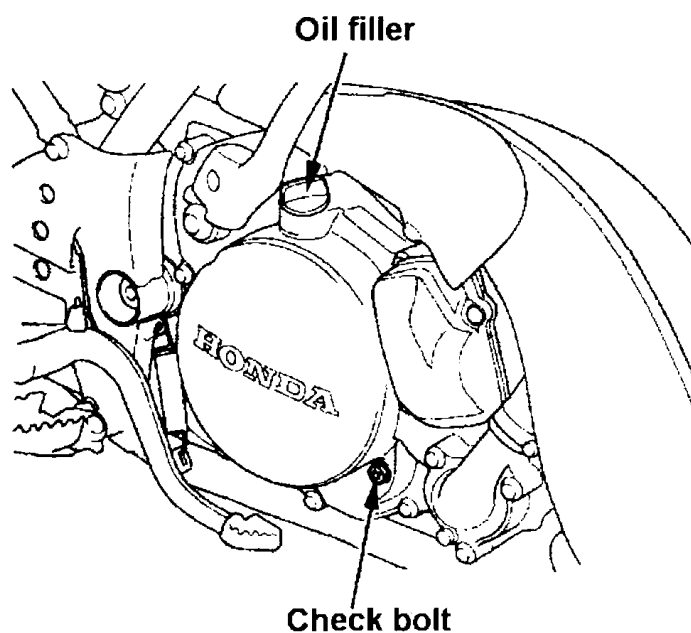

Transmission Oil

Recommended Oil

Genuine Honda oil for 4-stroke motorcycle.

If you are using the products other than Honda, select from the following ranges.

- API type: SE or SF grade
- SAE rating: Select from the diagram on page 53
- Do not use oils containing Friction Modifiers.



Advice

- The engine oil also lubricates the clutch. Use of engine oils designed to reduce wear and tear on the engine could cause the clutch to slip, affect engine start up, degrade engine performance and even shorten the engine life. Do not use oil additives designed to reduce engine wear and tear.

	API Type	SAE rating
Ultra U	SE grade	10W – 30
Ultra GP	SF grade	10W – 40 or 20W - 50

Transmission Oil

Temperature and Viscosity

Choose the Transmission oil corresponding to the atmospheric temperature in your riding area.

Oil change intervals.

Initial: 1,000km

After the first change:

Every 6000km

Contact an Authorized Honda Dealer for the oil change.

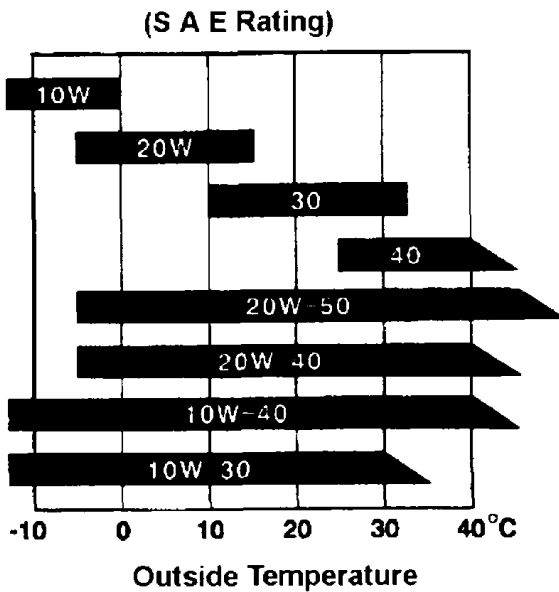

Coolant

1. The Honda CRM250 has a liquid cooled engine, Coolant level should be checked as part of your basic maintenance.
2. You can do this by visually inspecting the coolant level, behind the left hand side cover.
3. Make sure bike is on level ground and ensure that coolant level falls within the upper and lower graduations.

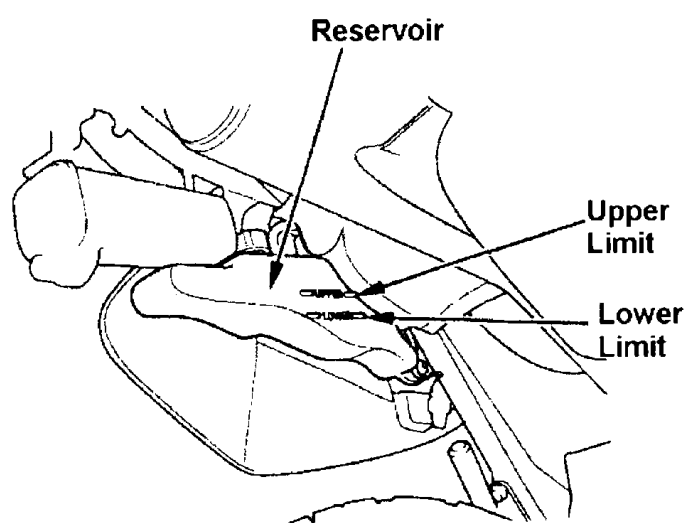

Caution

Do not remove the radiator cap while the engine is hot. Coolant can spurt out, causing severe scalding.

Allow the engine and radiator to cool before attempting to remove the radiator cap.

Adding Coolant

1. To top-up the reservoir, you must first remove the seat and left hand side cover.(refer page 22)
2. Remove filler cap and fill reservoir with Honda Ultra coolant to level indicated on reservoir.
3. If level drops significantly, it may mean there is a leak in the cooling system.

Contact an authorised dealer for technical support.

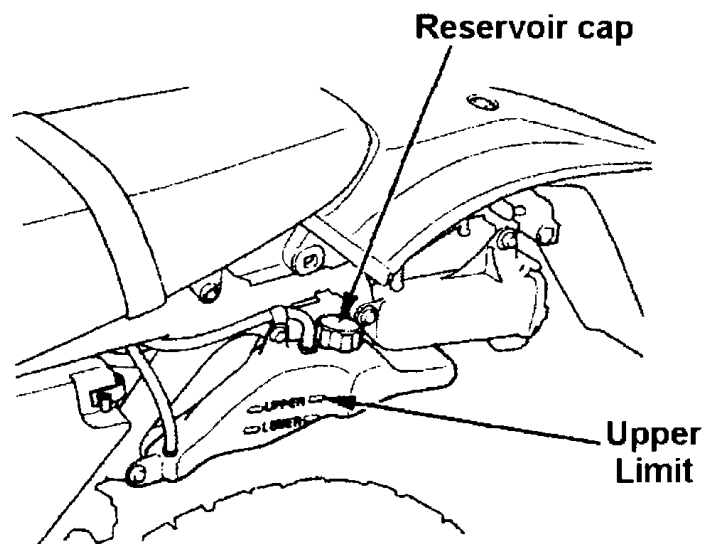

Advice

Use of poor quality water or radiator fluid other than the recommended type will cause corrosion / electrolysis.

Drive Chain

< Chain Slack Check >

Place the motorcycle on the side stand and pull the chain up and down at the mid-point between the front and the rear sprockets. Measure the slack using a ruler.

Drive chain slack: 30 ~ 40mm

Adjust the slack if out of the range.

Never ride the motorcycle if the slack is 60mm or more.

Roll the motorcycle back and forward to observe the chain.

If the chain is jerky or noisy, have it serviced / replaced.

Contact an Authorized Honda Dealer for the adjustment or the replacement.

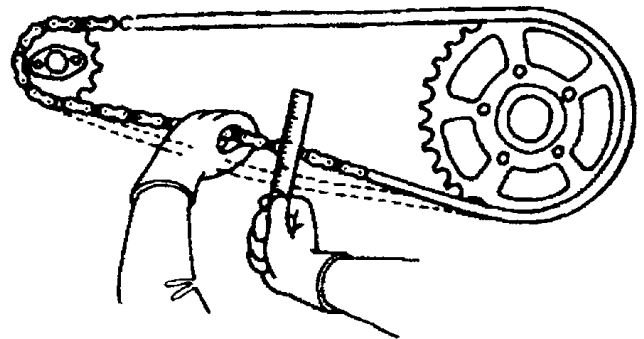

Drive Chain Slack

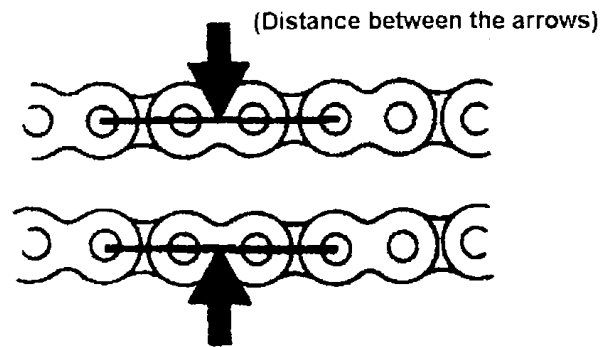

Drive Chain

< Lubrication and Cleaning >

Place the motorcycle on the side stand and clean mud or dirt from the chain and sprocket.

Move the motorcycle back and forward to clean entire chain.

Avoid steam cleaning as the chain has rubber seals.

Apply lubrication oil to both sides of the chain roller so as to have the oil reach entire part of the chain.

Excessive lubrication may result in spattering oil on the body or on your clothing.

Chain Oil: "Genuine Honda Chain Oil"

Or gear oil (#80 ~ #90).

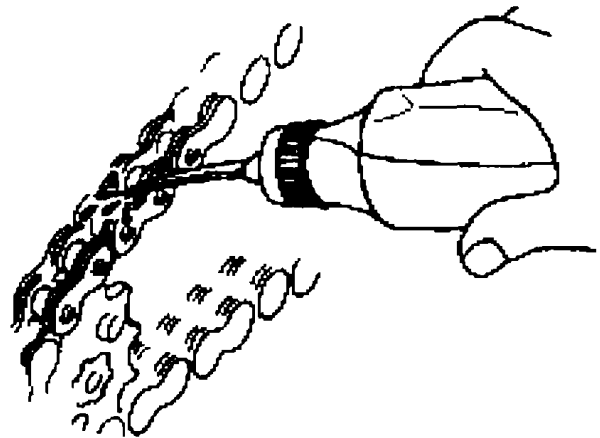

Advice

Do not use chain spray and other lubrication oil containing solvents. They may shorten the life of the chain.

Brakes

Front Brake

< Brake fluid level check >

Place the motorcycle on flat surface and set the side stand. Move the handlebar to make sure the reservoir cap surface is level

Check the fluid level is above the lower limit line (minimum line).

If the fluid level is below the minimum, brake pads may be worn. Check the pads

If the brake pads are fine, there may be a leak in the brake system. Refer to p 60

Contact an Authorized Honda Dealer.

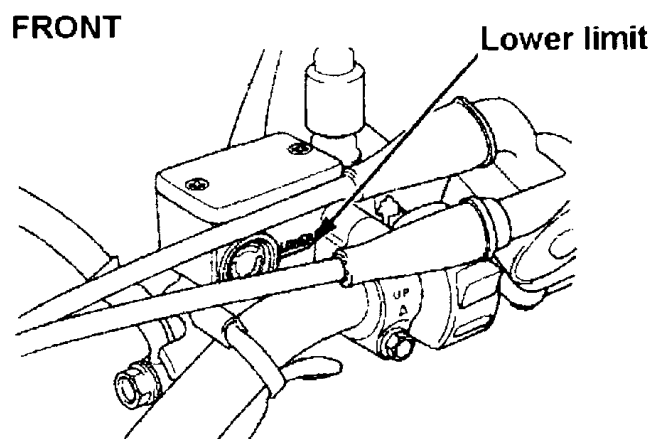

Brakes

< Brake pads inspection >

Honda recommends that the front brake pads be inspected regularly, between services.

Inspect the front brake pads from underneath the calipers.

If the wear limit line is worn through to the side of the brake disc, replace the pads on both sides.

Contact an Authorized Honda Dealer for brake pad replacement.

Always replace brake pads as a set – failure to do so may cause uneven braking or instability.

FRONT

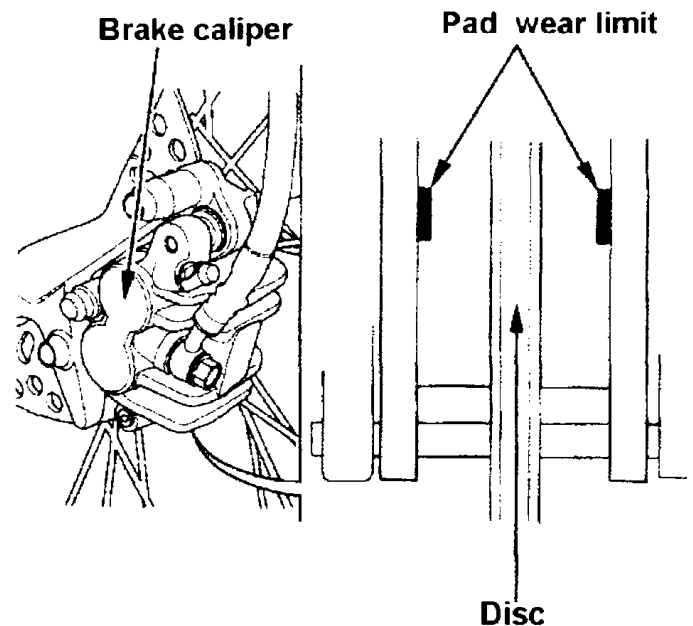

Rear Brake

< Brake fluid level check >

Hold the motorcycle upright on a flat surface so that the brake fluid reservoir is level.

Check the fluid level is between minimum and maximum lines.

If the fluid level is below the minimum, brake pads may be worn. Check the pads (p. 61).

If the brake pads are fine, there may be a leak in the brake system.

Contact an Authorized Honda Dealer.

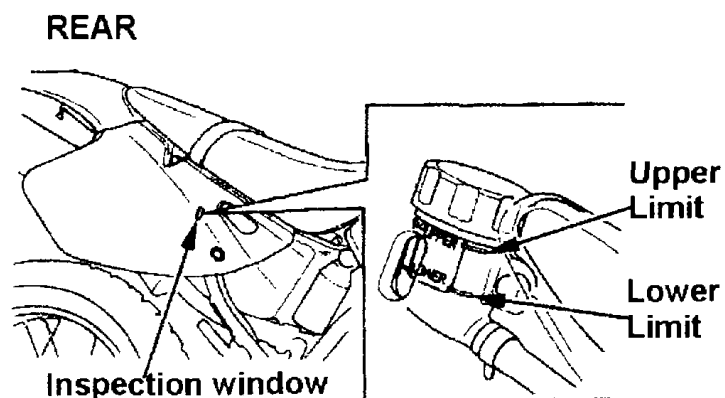

Brakes

< Brake pads inspection >

Honda recommends that the rear brake pads be inspected regularly between services.

Inspect the rear brake pads from behind the brake calipers. If the wear limit line is worn through to the side of the brake disc, replace the pads on both sides.

Contact an Authorized Honda Dealer for brake pad replacement.

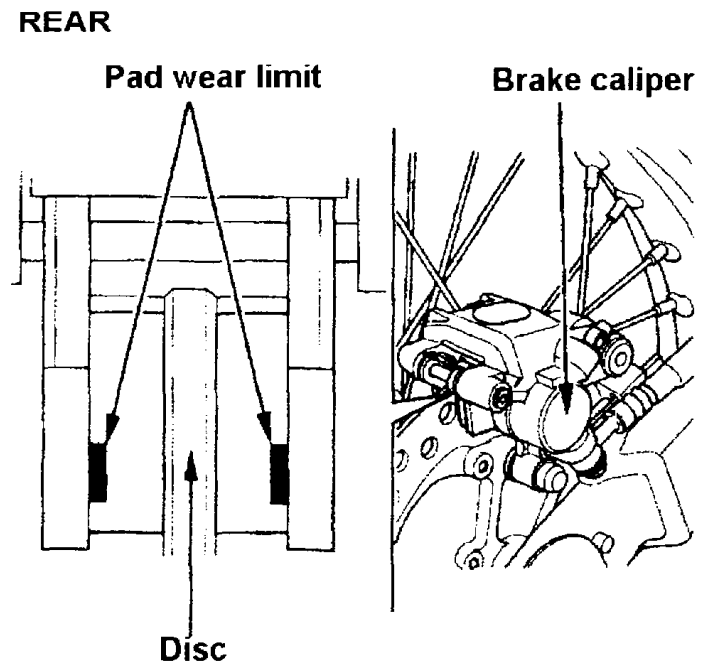

Clutch

< Free play in the clutch lever >

Squeeze the clutch lever until resistance is felt. Measure the distance traveled at the tip of the clutch lever with a ruler.

Free play: 10 ~ 20mm

Adjust the free play if necessary (p.63).

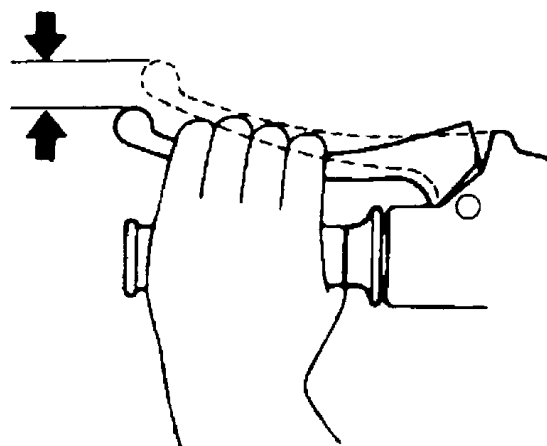

Clutch

< Free play adjustment >

Adjust the free play with the adjusters on either the clutch lever and/or the clutch end of the clutch cable.

- Loosen the lock nut to use the adjuster.
- After adjusting, tighten the lock nut.
- Check the free play again.

Start the engine and try changing gears. If the changes are jerky or the engine stalls or starts to move, re-adjust the free play.

COARSE ADJUSTMENT

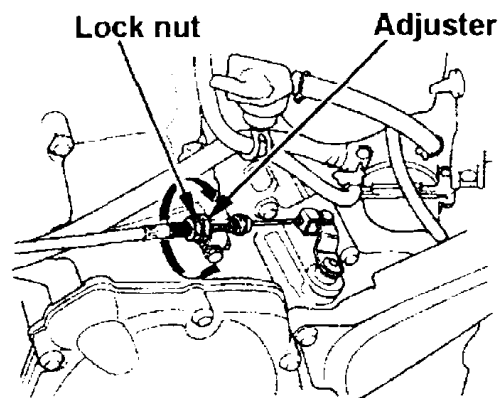

FINE ADJUSTMENT

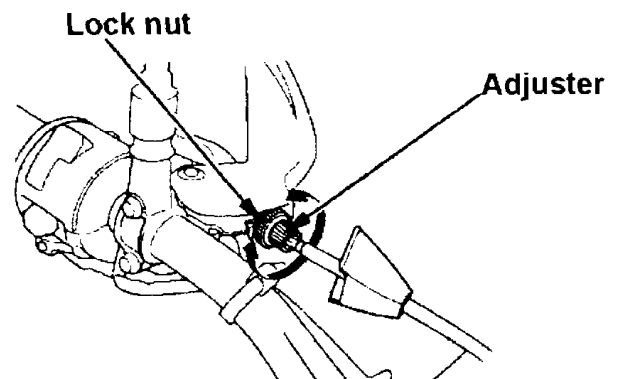

Fuses

< Fuse inspection / replacement >

Stop the engine before checking the fuses. Replace blown fuses with the fuses of same rating.

Never use higher-rating fuses. They may cause overheating and electrical system damage.

If a new fuse blows soon after replacement, there may be a fault in the relevant electrical system. Locate and repair the fault before installing a new fuse.

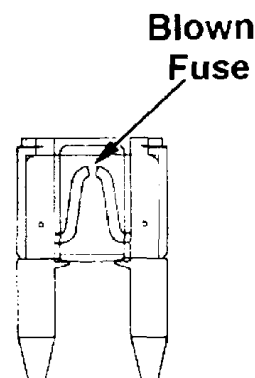
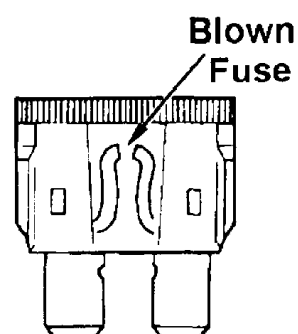

Advice

Replace the electrical parts only with genuine Honda accessories.

Other parts can cause fuses to blow.

Fuses and Relays

Fuses and Relays

1. Remove the headlight and shroud
2. Open the fuse holder.
3. Locate the blown fuse.
4. Replace with another of equivalent amperage.
5. Close the fuse holder and install the headlight.

Relays

Follow procedure above and identify relays from the wiring diagram in Service Manual.

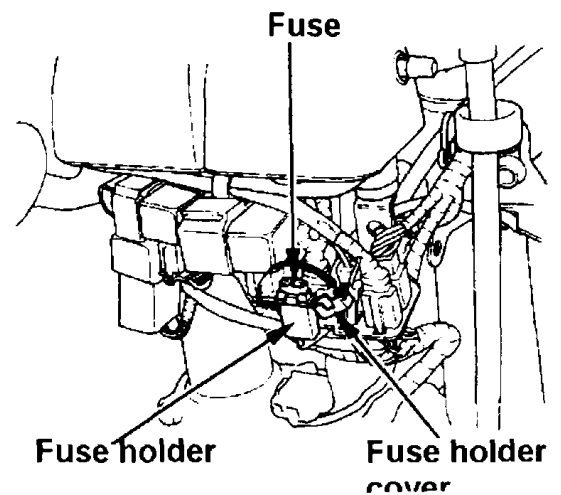
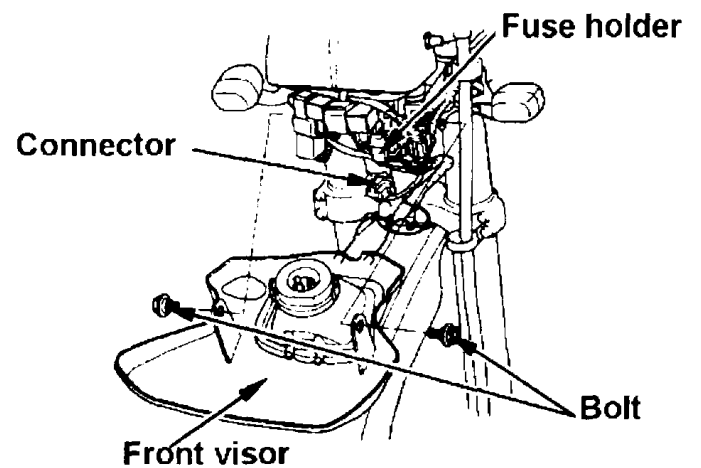

Tyres

Tyres should be kept in good condition and maintained at the rated pressure at all times. Worn tyres should be replaced immediately.



Caution

Use of worn tyres or failure to maintain tyres at the correct pressure can cause an accident resulting in serious injury or death.

Always maintain tyres at the correct pressure given in this owner's manual, and replace worn tyres immediately.

< Air pressure >

Check the air pressure while the tyres are cold.

< Tread >

Tyres should be replaced as soon as wear indicators start to appear on the tyre wall, or when the tread on the centre of the tyre reaches the level shown below.

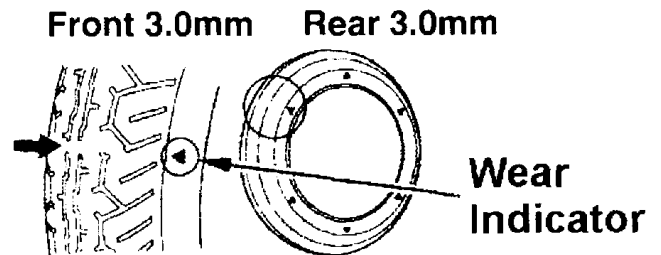

Without pillion passenger	Front	1.50kgf/cm ²
	Rear	1.50kgf/cm ²
With pillion passenger	Front	1.50kgf/cm ²
	Rear	1.50kgf/cm ²

Tyres

< Replacement Tyres >

Replace with only the approved tyres shown below. Use of other tyres can affect handling and stability.

Contact an Authorized Honda Dealer when replacing a tyre.

Front	Size	3.00 – 21 – 51P
	Type	IRC GP-21F
Rear	Size	4.60 – 18 63P
	Type	IRC GP-22R



Warning

Use of tyres other than the designated tyres in the table can affect handling and stability and could cause serious injury or death. Replace tyres only with the approved types given in this owner's manual.

Air Filter

Air Filter

< Replacing the air filter >

The oil-soaked viscous air filter element does not require inspection under normal operating conditions but should be replaced every 20,000km. Under severe conditions the filter should be inspected and replaced more regularly.

Replacements are available at your Authorized Honda Dealer.

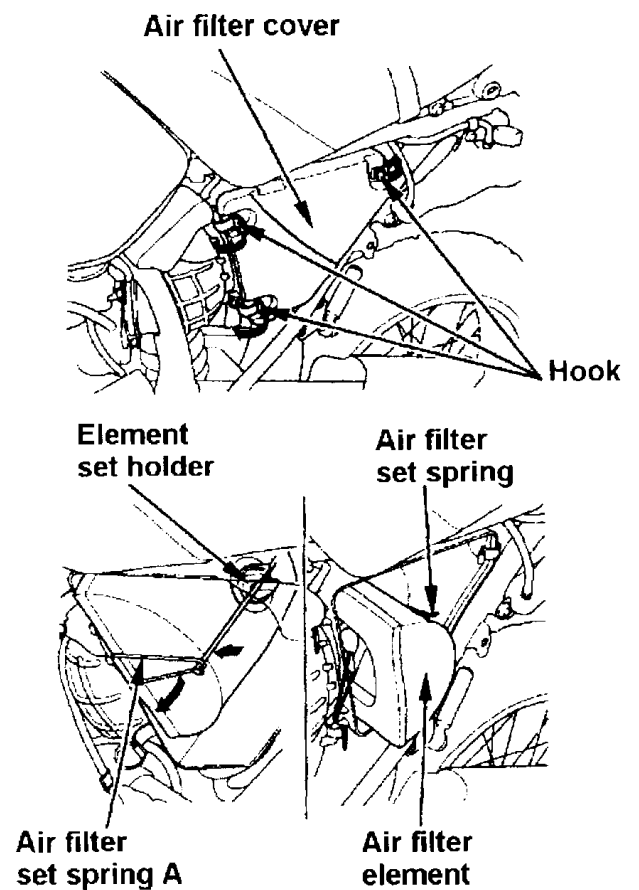

Cleaning

- To prevent internal rust and potential starting problems, keep water out of the muffler.
- Keep brake parts dry. Water in the brake mechanism affects braking performance.
- Polish painted surfaces and plastic parts gently. Strong rubbing with wax or polishing compounds can wear down the paint coating and cause discoloration.

After cleaning the motorcycle, start the engine and test the brakes (keep clear of other traffic and keep a low speed).

If necessary, apply the brakes periodically while riding at reduced speed until they dry out.

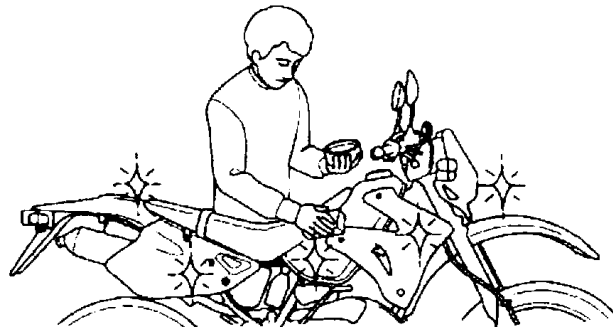
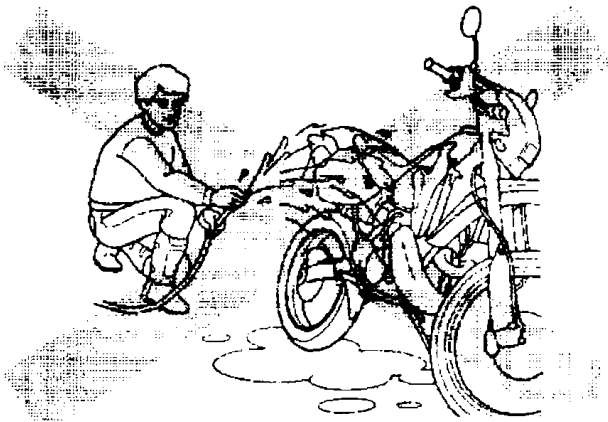

- Dry and lubricate any moving parts that may be affected by water.

Aluminum Parts (Aluminum wheel)

Parts made out of Aluminum Alloy should be handled carefully.

- Aluminum parts corrode if exposed to salt or mud. Sponge off salt water, road salt and other dirt immediately using mild detergent.
Rinse with plenty of water and dry with soft cloth.
- To prevent scratching, avoid abrasive cleaners and steel wool and do not use excessive force when cleaning or rubbing aluminum parts.

Environmental Consideration

Damper Units

The damper units contain compressed Nitrogen Gas. Contact an Authorized Honda Dealer when the damper units require replacement.



Warning

Do not throw the damper unit into fire or disassemble the unit. It may explode which could cause serious injury or death.

Please do not:

- Throw into fire
- Drill a hole in it, or
- Disassemble

Environmental Consideration

For environmental consideration, please handle used batteries, tyres, engine oil properly in terms of environmental manners.

Colour Label

Colour Label

When ordering coloured parts, quote the model name, colour and code on the colour label.

The colour label is located on the frame under the seat.

Colour label

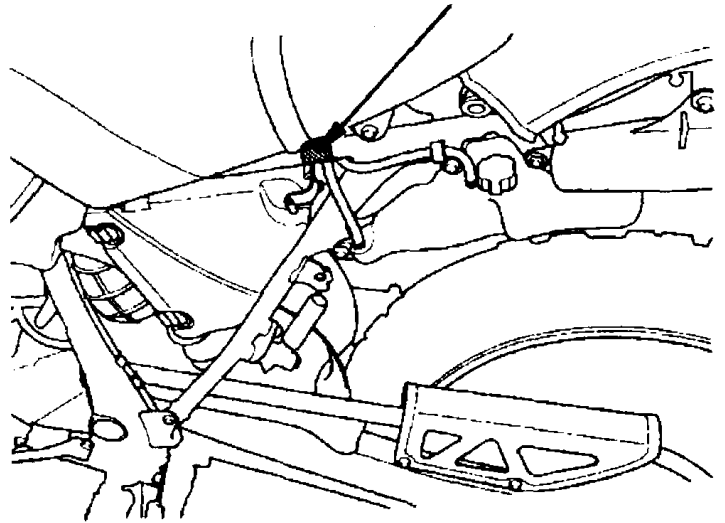

Genuine Honda Mufflers

Genuine Honda Mufflers

Use only genuine Honda mufflers with engraved Honda logo on the rear.

HONDA LOGO



Vehicle identification Number

Vehicle Identification Number (VIN)

The VIN is required when ordering parts and registering your motorcycle, and can also be helpful if the motorcycle is stolen.

Write down the VIN number together with the vehicle registration number and store in a safe place.

Vehicle Identification Number(VIN)

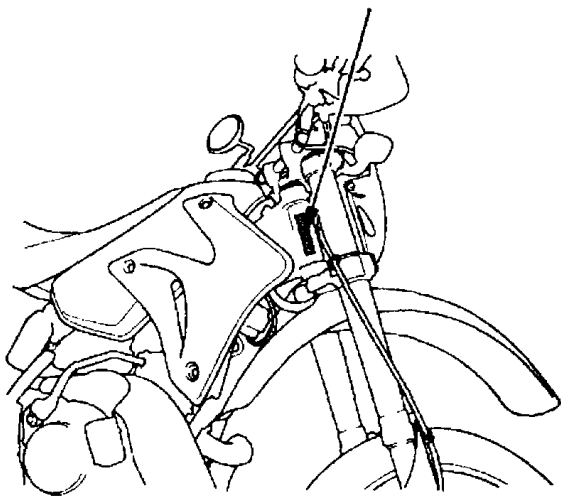

Engine Number

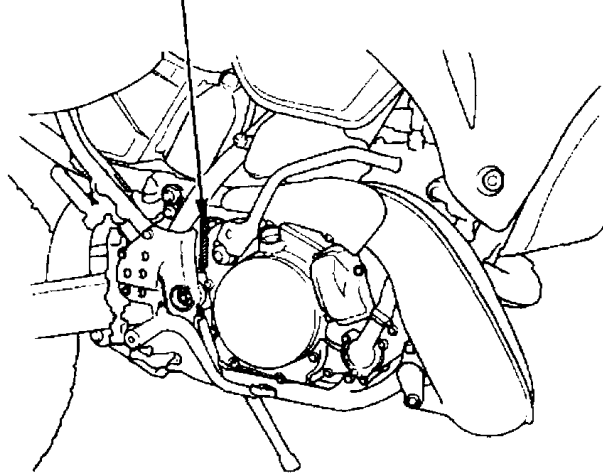

If engine overheats

If engine overheats

< Procedure >

Switch the engine OFF and wait for it to cool down.

1. Once the engine has cooled, check the coolant level (p.54) and refill if necessary
2. Check for leaks from the radiator hoses and elsewhere in the cooling system.
 - If a leak exists:
Do not start the engine. Contact an Authorized Honda Dealer for assistance.
 - If no leak exists:
The motorcycle may be able to be ridden. Contact an Authorized Honda Dealer if the engine overheats again.
3. Even if you do not encounter further overheating problems, have the engine checked by an Authorized Honda Dealer as soon as possible.

If engine fails to start

If engine fails to start

Should the engine fail to start or inadvertently come to a stop, check:

- The starting procedure (it should be as described in this owner's manual).
- The petrol level in the fuel tank.

Repairs

- Contact an Authorized Honda Dealer for repairs.
- To prolong the life of your motorcycle, do not attempt to repair it by yourself. Have it serviced properly by an Authorized Honda Dealer.

Specifications

Type	MD32	
Overall length	2195mm	
Overall width	825mm	
Overall height	1215mm	
Wheelbase	1460mm	
Engine type / volume	2-stroke, petrol / 0.249l	
Dry weight	127kg	
Seating Positions	2	
Tyre size	Front	3.00 – 21 51P
	Rear	4.60 – 18 63P
Minimum ground clearance	320mm	
Fuel consumption	36km/l (@60km/h)	
Minimum turning radius	2.3m	
Compression ratio	6.7	
Compression pressure	12kgf/cm ² - 400rpm	
Maximum Output power	40 PS / 8000rpm	
Maximum torque	4.0kg-m / 6,500rpm	
Fuel tank capacity	11 Litres	

Specifications

Ignition system		CDI
Ignition timing		BTDC 15° / 1400rpm
Idling speed		1300rpm
Spark plugs	NGK	BR7ES BR8ES BR9ES
	DENSO	W22ESR-U W24ESR-U W27ESR-U
Reduction ratio between engine and gearbox		2.600
Clutch type		Wet multi-plate coil spring
Gearbox type		Constant mesh transmission
Gear change mechanism		Left foot pedal
Gear ratio	1 ST	2.538
	2 ND	1.764
	3 RD	1.400
	4 TH	1.090
	5 TH	0.909
	6 TH	0.807
Final reduction ratio		3.000

Specifications

Drive chain slack		30-40mm	
Tyre pressure	Driver only	Front	1.50 kgf/cm ²
		Rear	1.50 kgf/cm ²
	Driver and Passenger	Front	1.50 kgf/cm ²
		Rear	1.50 kgf/cm ²
Transmission Oil	Total capacity		1.2 l
	Oil filter change		0.65 l
	Oil change		0.54 l
Clutch lever free play			10 – 20mm
Spark plug gap			0.8 – 0.9mm
Air filter element		Type	Viscous filter type
Bulbs	Headlamp		12V – 60/55W
	Stop lamp (rear)		12V – 18/5W
	Front turn signals		12V – 15W
	Rear turn signals		12V – 15W

Noise Warning

Noise Control System (Australia Only)

TAMPERING WITH THE NOISE
CONTROL SYSTEM IS PROHIBITED:

Owners are warned that the law may
prohibit:

- (a) The removal or rendering inoperative by any person other than for purposes of maintenance, repair, or replacement, of any device or element of design incorporated into any new motorcycle for the purpose of noise control prior to its sale or delivery to the ultimate purchaser or while it is in use: and
- (b) The use of the motorcycle after such device or element of design has been removed or rendered inoperative by any person.

Notes

Notes

