

BRUTALE

1050



Manuale di Manutenzione
Maintenance manual

BRUTALE

1090

MV AGUSTA



Manuale di manutenzione
Versione Italiana



INDICE GENERALE

<i>cap.</i>	<i>Descrizione argomenti</i>	<i>pag.</i>
1	MANUTENZIONE	3
1.1.	Simbologia	3
1.2.	Tabelle di manutenzione e controllo	4
1.3.	Attrezzi e accessori in dotazione	14
1.4.	Tabella lubrificanti e liquidi	15
1.5.	Olio motore - Controllo livello	16
1.5.1.	Olio motore - Ripristino livello	17
1.6.	Liquido di raffreddamento - Controllo livello	19
1.6.1.	Liquido di raffreddamento - Ripristino livello	20
1.7.	Pastiglie freni - Controllo usura	22
1.8.	Fluido comando freni - Controllo livello	23
1.9.	Fluido comando frizione - Controllo livello	25
1.10.	Pneumatici - Controllo e sostituzione	26
1.11.	Catena - Controllo e lubrificazione	32
1.12.	Regime di minimo - Controllo	36
1.13.	Sostituzioni - informazioni generali	37
1.13.1.	Fusibili - Sostituzione	37
1.13.2.	Faro anabbagliante - Sostituzione lampadina	40
1.13.3.	Faro abbagliante - Sostituzione lampadina	43
1.13.4.	Luce targa - Sostituzione lampadina	44
1.14.	Batteria	45
1.15.	Pulizia della motocicletta	47
1.16.	Periodo di sosta prolungata	50

<i>cap.</i>	<i>Descrizione argomenti</i>	<i>pag.</i>
2	GUASTI	51
2.1.	Inconvenienti al motore	51
2.2.	Inconvenienti all'impianto elettrico	56
3	INFORMAZIONI TECNICHE	59
3.1.	Descrizione generale della motocicletta	59
3.1.1.	Circuito freno anteriore	61
3.1.2.	Circuito freno posteriore	62
3.1.3.	Circuito frizione	63
3.1.4.	Lubrificazione motore	64
3.1.5.	Circuito di raffreddamento	65
3.1.6.	Circuito di alimentazione	66
3.2.	Dati tecnici	67
3.3.	Riferimento colori componenti sovrastrutture	75
3.4.	Riferimento colori componenti telaio e ciclistica	77



1.1. Simbologia

Le parti di testo di particolare importanza, relative alla sicurezza della persona e all'integrità della motocicletta, sono evidenziate con i seguenti simboli:



Pericolo - Attenzione: la mancata o incompleta osservanza di queste prescrizioni può comportare pericolo grave per la propria incolumità e per quella di altre persone.



Cautela - Precauzione: la mancata o incompleta osservanza di queste prescrizioni può comportare un rischio di danni alla motocicletta.

Per indicare le persone autorizzate allo svolgimento delle operazioni di regolazione e/o manutenzione, esse sono contraddistinte dai seguenti simboli:



Informazioni sulle operazioni consentite al motociclista.



Informazioni sulle operazioni che devono essere svolte solo dal personale autorizzato.

Per evidenziare ulteriori informazioni vengono utilizzati i seguenti simboli:



Il simbolo  indica la necessità di utilizzare un attrezzo od un'attrezzatura specifica per il corretto svolgimento dell'operazione descritta.



Il simbolo “ § ” indica il rimando al capitolo identificato dal numero che lo segue.



1.2. Tabelle di manutenzione e controllo

Le operazioni di manutenzione e controllo più importanti e la loro frequenza sono riportate nelle specifiche tabelle. È indispensabile eseguire tali operazioni per mantenere la motocicletta efficiente e sicura.

Gli intervalli indicati nella tabella della manutenzione periodica e di lubrificazione devono venire considerati solo come una guida generale in condizioni di marcia normali. Potrebbe essere necessario ridurre tali intervalli in funzione delle condizioni climatiche, del terreno, della situazione geografica e dell'impiego individuale.

Alcune operazioni possono essere eseguite dal proprietario della motocicletta, purchè in possesso delle competenze necessarie. In caso contrario fare eseguire le operazioni presso un centro di assistenza autorizzato.

In generale le operazioni di manutenzione vanno eseguite con motocicletta posizionata su cavalletto posteriore, con motore spento e con interruttore in posizione "OFF". Durante il controllo del livello dei liquidi è invece preferibile tenere la moto in posizione verticale senza utilizzare il cavalletto posteriore.

Oltre i 36.000 Km (22400 mi), le operazioni devono essere eseguite con la stessa frequenza indicata nelle specifiche tabelle.



ATTENZIONE

- Una manutenzione impropria, o la mancata esecuzione dei lavori di manutenzione consigliati, aumenta il rischio di incidenti o di danneggiamenti della moto.
- Utilizzate sempre ricambi originali MV Agusta. L'utilizzo di ricambi non originali può accelerare l'usura della moto ed abbreviarne la durata.
- La mancata esecuzione delle operazioni raccomandate o l'utilizzo di ricambi non originali può comportare la non operabilità della garanzia.
- La sostituzione e/o il ripristino dei lubrificanti e dei liquidi va eseguita utilizzando esclusivamente i prodotti indicati nel §1.4.



ATTENZIONE

Nel caso di utilizzo in pista si raccomanda di far verificare la moto sia prima che dopo l'uso da personale specializzato appartenente alla rete dei Centri assistenza MV Agusta. L'utilizzo su pista è permesso solo occasionalmente e, comunque, non a scopi agonistici, anche se amatoriali.

L'uso della moto in pista comporta un sensibile incremento dell'usura delle varie componenti, con conseguente vita utile delle stesse ridotta rispetto ad un normale utilizzo su strada od autostrada.



Tabelle manutenzione programmata

1

Frequenza Manutenzione Km (mi)		0	1000 (600)	6000 (3800)	12000 (7500)	18000 (11200)	24000 (14900)	30000 (18600)	36000 (22400)
Tagliando		Pre-con segna	A	B	C	D	E	F	G
DESCRIZIONE		OPERAZIONE							
Olio motore		Controllo livello	Prima di ogni utilizzo del veicolo						
		Sostituzione	●	●	●	●	●	●	●
			Comunque ogni anno						
Filtro olio motore		Sostituzione (Utilizzare esclusivamente filtri olio originali MV Agusta)	●	●	●	●	●	●	●
			Comunque ad ogni sostituzione olio motore						
Liquido di raffreddamento		Controllo / Ripristino livello	Prima di ogni utilizzo del veicolo						
		Sostituzione	Ogni due anni						
Impianto raffreddamento		Controllo perdite	●	●	●	●	●	●	●
Elettroventole		Controllo funzionamento	●	●	●	●	●	●	●
Valvole		Controllo / Regolazione			●		●		●
Catena distribuzione		Controllo			●		●		
		Sostituzione							●



Tabelle manutenzione programmata

1

Frequenza Manutenzione Km (mi)		0	1000 (600)	6000 (3800)	12000 (7500)	18000 (11200)	24000 (14900)	30000 (18600)	36000 (22400)	
Tagliando		Pre-con segna	A	B	C	D	E	F	G	
DESCRIZIONE		OPERAZIONE								
Pattino mobile distribuzione		Controllo / Sostituzione			●		●			
		Sostituzione							●	
			Comunque ad ogni sostituzione della catena di distribuzione							
Tendicatena distribuzione		Controllo / Sostituzione			●		●		●	
Candele		Controllo / Sostituzione		●		●		●		
		Sostituzione			●		●		●	
Filtro benzina		Controllo / Sostituzione			●		●		●	
Corpo farfallato		Controllo e Regolazione	●	●	●	●	●	●	●	
Filtro aria		Controllo / Sostituzione		●	●	●	●	●	●	
Fluido freni e frizione		Controllo livello	Prima di ogni utilizzo del veicolo							
		Controllo livello	●	●	●	●	●		●	●
		Sostituzione					●			
			Comunque ogni 2 anni							





Tabelle manutenzione programmata

Frequenza Manutenzione Km (mi)		0	1000 (600)	6000 (3800)	12000 (7500)	18000 (11200)	24000 (14900)	30000 (18600)	36000 (22400)
Tagliando		Pre-con segna	A	B	C	D	E	F	G
DESCRIZIONE	OPERAZIONE								
Freni / Frizione	Controllo funzionalità	Prima di ogni utilizzo del veicolo							
	Pulizia zona di contatto leva / pistoncino pompa	Ogni 500 ÷ 1000 km (300 ÷ 600 mi)							
	Controllo funzionalità	●	●	●	●	●	●	●	●
	Controllo circuito	●	●	●	●	●	●	●	●
	Pulizia zona di contatto leva / pistoncino pompa	●	●	●	●	●	●	●	●
Pastiglie freni (anteriore + posteriore)	Controllo usura	Ogni 1000 Km (600 mi)							
	Controllo/ Sostituzione		●	●	●	●	●	●	●
Tubi circuito carburante	Controllo difetti e perdite		●	●	●	●	●	●	●
	Sostituzione	Comunque ogni 3 anni							
Comando acceleratore	Controllo funzionalità	Prima di ogni utilizzo del veicolo							
	Controllo funzionalità	●	●	●	●	●	●	●	●
	Verifica/regolazione gioco	●	●	●	●	●	●	●	●
Comando starter	Controllo funzionalità	●	●	●	●	●	●	●	●



Tabelle manutenzione programmata

1

Frequenza Manutenzione Km (mi)		0	1000 (600)	6000 (3800)	12000 (7500)	18000 (11200)	24000 (14900)	30000 (18600)	36000 (22400)
Tagliando		Pre-con segna	A	B	C	D	E	F	G
DESCRIZIONE		OPERAZIONE							
Trasmissioni e comandi flessibili		Controllo / Regolazione	●	●	●	●	●	●	●
Catena di trasmissione 		Controllo	Ogni 1000 Km (600 mi)						
		Lubrificazione	Ogni 1000 Km (600 mi) e dopo ogni guida sotto la pioggia						
	Controllo / Regolazione	●	●	●	●	●	●	●	●
	Lubrificazione		●	●		●		●	
	Sostituzione				●		●		●
Pignone / Rosetta di fermo		Controllo		●	●		●		●
		Sostituzione				●		●	
	Comunque ad ogni sostituzione della catena di trasmissione								
Corona		Controllo		●	●		●		●
		Sostituzione				●		●	
	Comunque ad ogni sostituzione della catena di trasmissione								



Tabelle manutenzione programmata

1

Frequenza Manutenzione Km (mi)		0	1000 (600)	6000 (3800)	12000 (7500)	18000 (11200)	24000 (14900)	30000 (18600)	36000 (22400)	
Tagliando		Pre-con segna	A	B	C	D	E	F	G	
DESCRIZIONE		OPERAZIONE								
Parastrappi corona		Controllo / Sostituzione			●		●		●	
Ghiera canotto di sterzo		Controllo / Regolazione	●		●		●		●	
Cuscinetti di sterzo		Controllo / Regolazione	●		●		●		●	
		Lubrificazione					●			
Pneumatici		Controllo pressione	Ad ogni utilizzo del veicolo e comunque ogni 10 giorni							
		Controllo usura	Ad ogni utilizzo del veicolo e comunque ogni 500 Km (300 mi)							
		Controllo pressione	●	●	●	●	●	●	●	●
		Controllo usura		●	●	●	●	●	●	●
Cerchi ruota		Controllo visivo		●	●	●	●	●	●	
			Comunque ad ogni sostituzione dei pneumatici							
Cuscinetti ruota anteriore		Controllo		●	●	●	●	●		
			Comunque ad ogni sostituzione dei pneumatici							
		Sostituzione								●



Tabelle manutenzione programmata

Frequenza Manutenzione Km (mi)		0	1000 (600)	6000 (3800)	12000 (7500)	18000 (11200)	24000 (14900)	30000 (18600)	36000 (22400)
Tagliando		Pre-con segna	A	B	C	D	E	F	G
DESCRIZIONE	OPERAZIONE								
Cavalletto laterale	Controllo funzionalità	Prima di ogni utilizzo del veicolo							
	Controllo funzionalità	●	●	●	●	●	●	●	●
Interruttore cavalletto laterale	Controllo funzionalità	Prima di ogni utilizzo del veicolo							
	Pulizia zona di contatto con cavalletto laterale	Ogni 500 ÷ 1000 km (300 ÷ 600 mi)							
	Controllo funzionalità	●	●	●	●	●	●	●	●
Mozzo ruota posteriore	Controllo / lubrificazione astuccio rullini				●		●		
	Sostituzione / lubrificazione astuccio rullini								●
Cuscinetti forcellone	Controllo / lubrificazione								●
Pattini catena forcellone	Controllo / sostituzione		●	●	●	●	●	●	●
Pattini catena piastra telaio	Controllo / sostituzione		●	●	●	●	●	●	●
Ammortizzatore posteriore	Controllo / regolazione		●		●		●		●
Olio forcella anteriore	Sostituzione						●		



Tabelle manutenzione programmata

=1

Frequenza Manutenzione Km (mi)		0	1000 (600)	6000 (3800)	12000 (7500)	18000 (11200)	24000 (14900)	30000 (18600)	36000 (22400)
Tagliando		Pre-con segna	A	B	C	D	E	F	G
DESCRIZIONE	OPERAZIONE								
Collegamenti batteria	Controllo e pulizia		●	●	●	●	●	●	●
Impianto elettrico	Controllo funzionalità	●	●	●	●	●	●	●	●
Strumentazione	Controllo funzionalità	Prima di ogni utilizzo del veicolo							
	Controllo funzionalità	●	●	●	●	●	●	●	●
Luci / segnali visivi	Controllo funzionalità / Sostituzione lampadine	Prima di ogni utilizzo del veicolo							
	Controllo funzionalità / Sostituzione lampadine	●	●	●	●	●	●	●	●
Avvisatore acustico	Controllo funzionalità	Prima di ogni utilizzo del veicolo							
	Controllo funzionalità	●	●	●	●	●	●	●	●
Fanale anteriore	Controllo funzionalità	Prima di ogni utilizzo del veicolo							
	Regolazione	Ad ogni variazione di assetto del veicolo ed utilizzo con passeggero							
	Controllo funzionalità	●	●	●	●	●	●	●	●
Interruttore accensione	Controllo funzionalità	Prima di ogni utilizzo del veicolo							
	Controllo funzionalità	●	●	●	●	●	●	●	●



Tabelle manutenzione programmata

Frequenza Manutenzione Km (mi)		0	1000 (600)	6000 (3800)	12000 (7500)	18000 (11200)	24000 (14900)	30000 (18600)	36000 (22400)
Tagliando		Pre-con segna	A	B	C	D	E	F	G
DESCRIZIONE		OPERAZIONE							
Serrature		Controllo funzionalità	Prima di ogni utilizzo del veicolo						
		Controllo funzionalità	●	●	●	●	●	●	●
Serraggio viti e dadi		Controllo / serraggio	●	●	●	●	●	●	●
Fascette stringitubo		Controllo / serraggio	●	●	●	●	●	●	●
Lubrificazione generale			●	●	●	●	●	●	●
Collaudo generale			●	●	●	●	●	●	●

**1****1.3. Attrezzi e accessori in dotazione**

Nel vano portaoggetti viene fornita una busta che contiene i seguenti attrezzi:

- 1 barra esagonale (esagono da 10 mm);
- 6 chiavi a maschio esagonale (esagono da 2,5 - 3 - 4 - 5 - 6 - 8 mm);
- 1 chiave per eccentrico ruota posteriore e relativa prolunga;
- 1 estrattore per minifusibili;
- 3 fusibili (7,5A - 15A).

Vengono inoltre forniti i seguenti accessori:

- 1 chiave per candele (esagono da 16 mm);
- 1 busta portadocumenti.





1.4. Tabella lubrificanti e liquidi

Descrizione	Prodotto consigliato	Specifiche
Olio lubrificazione motore	AGIP RACING 4T 10W/60 (*)	SAE 10W/60 - API SJ
Liquido di raffreddamento	AGIP ECO - PERMANENT	Glicole - Etilenico diluito con 50% di acqua distillata
Fluido comando frizione e freni	AGIP BRAKE FLUID DOT4	DOT4
Olio lubrificazione catena	MOTUL CHAIN LUBE ROAD	-

* : Per la reperibilità del prodotto consigliato, MV Agusta consiglia di rivolgersi direttamente ai propri concessionari autorizzati. L'olio motore AGIP Racing 4T 10W/60 è stato realizzato appositamente per il motore del motociclo Brutale. Qualora il lubrificante descritto non fosse reperibile, MV Agusta consiglia l'utilizzo di olii completamente sintetici con caratteristiche conformi o superiori alle seguenti normative:

- Conforme API SJ
- Conforme ACEA A3
- Conforme JASO MA
- Gradazione SAE 20 W-50 o 10 W-60

NOTA

Le specifiche sopra indicate devono essere riportate, da sole od insieme ad altre, sul contenitore dell'olio lubrificante.





1.5. Olio motore - Controllo livello

Eseguire il controllo a freddo, a motore spento. Se effettuato a caldo, il motore deve essere spento da almeno dieci minuti.

Questo controllo va effettuato disponendo la motocicletta su un piano orizzontale ed in posizione di marcia (posizione verticale).

Il livello deve essere compreso tra i riferimenti MAX e MIN riportati nel carter.

Nel caso in cui il livello dell'olio si trovi sotto il riferimento MIN, effettuare un rabbocco (vedere 1.5.1).



Pericolo - Attenzione: Non avviare il motore se l'olio è sotto il riferimento MIN.

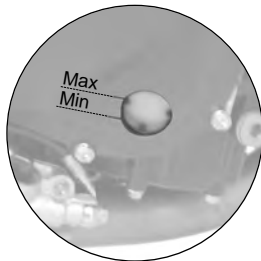



1.5.1. Olio motore - Ripristino livello

Per ripristinare il livello è necessario svitare il tappo olio utilizzando la barra esagonale da 10 mm in dotazione montata su una apposita chiave (vedi figura). Versare una quantità di olio del tipo consigliato fino a raggiungere un adeguato livello; in ogni caso non superare mai il riferimento MAX. Riavvitare il tappo al termine dell'operazione.



ATTENZIONE

Prima di eseguire il rimontaggio del tappo olio, lubrificare l'O-Ring presente sul tappo utilizzando del grasso AGIP Grease 30.

Eeguire infine il serraggio del tappo olio al valore di 35 Nm, utilizzando una chiave dinamometrica.

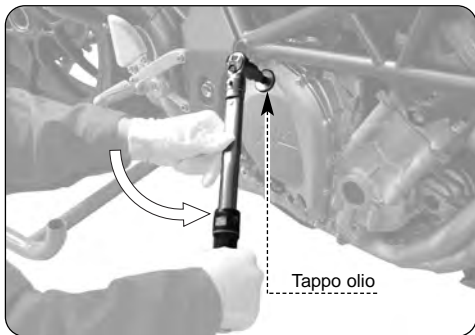

CAUTELA

Per prevenire slittamenti della frizione ed evitare il danneggiamento del motore, non miscelare additivi chimici all'olio, né utilizzare olii di tipo differente da quello riportato nel § 1.4. Accertarsi che non penetrino corpi estranei nel carter durante il rabbocco.



1

**ATTENZIONE**

L'olio motore, nuovo o esausto, può essere pericoloso. L'ingestione di olio motore, nuovo o esausto, può essere nociva per le persone e per gli animali domestici. In caso di ingestione di olio motore, chiamare immediatamente un medico e non provocare il vomito onde evitare aspirazione del prodotto nei polmoni. Si è constatato che il contatto continuo con l'olio motore provoca il cancro della pelle su cavie. Brevi contatti con l'olio motore possono irritare la pelle.

- Tenere l'olio motore, nuovo o esausto, lontano dalla portata dei bambini e degli animali domestici.
- Indossare indumenti con le maniche lunghe e guanti impermeabili all'acqua ogni volta che si effettua il rabbocco dell'olio motore.
- Lavarsi con acqua e sapone, se l'olio motore entra in contatto con la pelle.
- Riciclare o smaltire correttamente l'olio motore esausto.



1.6. Liquido di raffreddamento - Controllo livello

Eeguire il controllo a freddo e a motore spento. Questo controllo va effettuato disponendo la motocicletta su un piano orizzontale ed in posizione di marcia (posizione verticale).

Il livello deve essere compreso tra il riferimento MIN e la parte inferiore del tubo telaio, come mostrato in figura.

Nel caso in cui il livello del liquido refrigerante si trovi sotto il riferimento MIN, effettuare un rabbocco (vedere § 1.6.1).



ATTENZIONE

Non utilizzare il motociclo se il livello del liquido di raffreddamento si trova al di sotto del riferimento MIN.

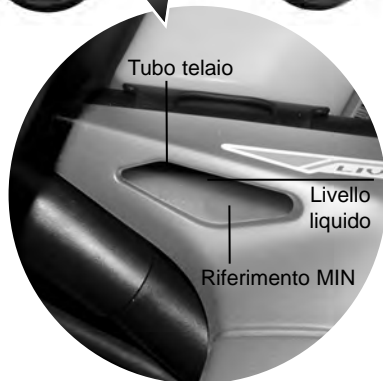

1



1

1.6.1. Liquido di raffreddamento - Ripristino livello

Per accedere al tappo rimuovere il coperchio svitando le relative viti di fissaggio.

Svitare il tappo ed effettuare il rabbocco utilizzando il fluido di raffreddamento consigliato nel § 1.4.

Tappo caricamento liquido di raffreddamento

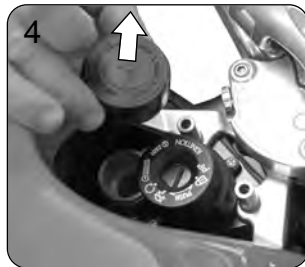
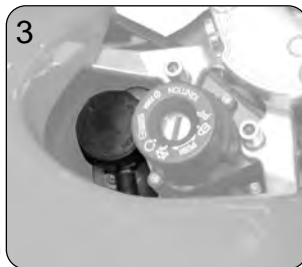
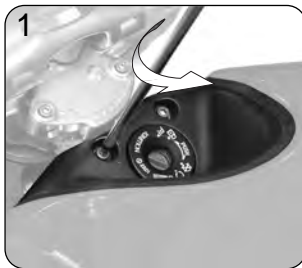

Dopo il ripristino del livello, rimontare accuratamente le parti precedentemente smontate.



ATTENZIONE : Il rabbocco del liquido di raffreddamento va effettuato sempre a motore freddo. Non tentare mai di togliere il tappo del serbatoio del liquido di raffreddamento quando il motore è caldo per evitare il rischio di ustioni. Il circuito è in pressione!



CAUTELA : Per il ripristino e/o la sostituzione del liquido di raffreddamento utilizzare esclusivamente il prodotto specificato in tabella § 1.4. Non miscelare né diluire il liquido di raffreddamento con additivi o fluidi differenti. Nel caso in cui il prodotto indicato al § 1.4. non fosse reperibile, utilizzare un prodotto avente analoghe caratteristiche tecniche.



CAUTELA : Gli spruzzi di refrigerante possono danneggiare le superfici verniciate. Stare attenti a non versare il fluido quando si riempie l'impianto di raffreddamento. Asciugare immediatamente con un panno pulito l'eventuale refrigerante del motore versato.

**ATTENZIONE**

In determinate condizioni il glicole etileno contenuto nel liquido di raffreddamento è infiammabile e la sua fiamma è invisibile. Evitare di portare a contatto il liquido di raffreddamento con parti calde, in quanto la conseguente combustione del glicole etileno potrebbe esporre al rischio di ustioni.

**ATTENZIONE**

Il liquido refrigerante del motore è nocivo se ingerito o se entra in contatto con gli occhi o con la pelle. Tenere il liquido refrigerante del motore lontano dalla portata dei bambini e degli animali domestici. In caso di ingestione di liquido refrigerante, chiamare immediatamente un medico e non provocare il vomito onde evitare aspirazione del prodotto nei polmoni. In caso di contatto del liquido refrigerante del motore con gli occhi o con la pelle, sciacquare immediatamente con acqua.



1

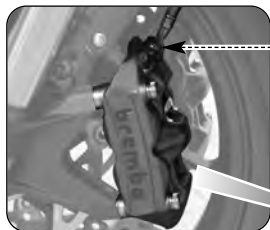

Pinza freno anteriore

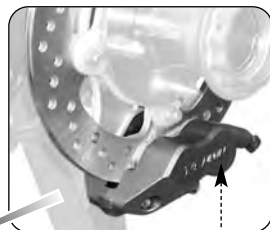

Pinza freno posteriore

Disco freno

Pastiglia

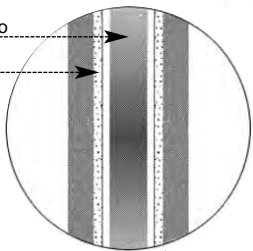

Limite di usura 1 mm

1.7. Pastiglie freni - Controllo usura

Controllare periodicamente l'altezza dello strato del materiale di attrito delle pastiglie, avendo cura di non scendere mai al di sotto del limite di usura minimo di 1 mm.



Pericolo - Attenzione: Utilizzando la moto con le pastiglie dei freni usurate, la potenza di frenata diminuisce ed aumenta il rischio di incidenti. Se lo spessore residuo è vicino al limite di usura, rivolgersi ad un centro di assistenza autorizzato per effettuare la sostituzione delle pastiglie. Sottoporre le nuove pastiglie ad opportuno rodaggio.



Serbatoio freno posteriore



Serbatoio freno anteriore

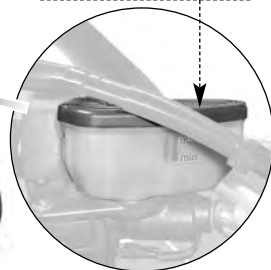

1

1.8. Fluido comando freni - Controllo livello



ATTENZIONE

Il mancato controllo ed una manutenzione carente dei freni aumentano il rischio di incidenti. Prima di ogni uscita con la moto, controllare il sistema frenante secondo le istruzioni riportate nel Quick Manual.

L'usura delle pastiglie dei freni provoca un normale calo del livello del fluido. In ogni caso il livello deve essere compreso tra i riferimenti MAX e MIN. Se tale livello scende al di sotto del riferimento MIN, occorre rivolgersi ad un centro assistenza autorizzato per un controllo generale dell'impianto frenante.



**1****ATTENZIONE**

Non utilizzare la motocicletta se il livello è al di sotto al riferimento MIN; in tale condizione l'impianto frenante potrebbe non funzionare correttamente, con conseguente rischio di perdita di controllo del veicolo ed incidenti. Se il livello del liquido si trova al di sotto del riferimento MIN, rivolgersi ad un concessionario MV Agusta per effettuare un controllo dell'impianto frenante.

**ATTENZIONE**

Fare effettuare il rabbocco del liquido dei freni esclusivamente da personale autorizzato. Il liquido dei freni è nocivo o mortale, se ingerito, ed è nocivo se viene a contatto della pelle e degli occhi. Tenete il liquido dei freni fuori dalla portata dei bambini e degli animali domestici. In caso di ingestione del liquido dei freni, chiamare immediatamente un medico e non provocare il vomito onde evitare aspirazione del prodotto nei polmoni. In caso di contatto del liquido dei freni con gli occhi o con la pelle, sciacquare immediatamente con acqua.

**ATTENZIONE**

Fare effettuare il rabbocco del liquido freni utilizzando solamente il tipo di fluido consigliato nel §1.4. del presente manuale. Eventuali miscele tra fluidi di tipo differente possono causare una reazione chimica pericolosa e la diminuzione dell'efficienza di frenata, con conseguente aumento del rischio di incidenti.

**ATTENZIONE**

Una quantità insufficiente di liquido freni può permettere la penetrazione di aria nell'impianto dei freni, compromettendo l'efficienza della frenata con conseguente aumento del rischio di incidenti. La presenza di aria nell'impianto idraulico potrebbe essere evidenziata nel caso in cui, premendo la leva del freno, si avvertisse una sensazione di eccessiva cedevolezza. In caso di presenza di aria nell'impianto idraulico, farne effettuare lo spurgo da un concessionario MV Agusta prima di utilizzare il mezzo.



1.9. Fluido comando frizione - Controllo livello

Il livello deve essere compreso tra i riferimenti MAX e MIN. Se tale livello scende al di sotto del riferimento MIN, occorre rivolgersi ad un centro assistenza autorizzato per un controllo generale dell'impianto comando frizione.



ATTENZIONE

Non utilizzare la motocicletta se il livello è al di sotto del riferimento MIN; in tale condizione l'impianto di comando frizione potrebbe non funzionare correttamente, con conseguente rischio di perdita di controllo del veicolo ed incidenti. Se il livello del liquido si trova al di sotto del riferimento MIN, rivolgersi ad un concessionario MV Agusta per effettuare un controllo dell'impianto frizione.



ATTENZIONE

Fare effettuare il rabbocco del liquido comando frizione utilizzando solamente il tipo di fluido consigliato nel §1.4. del presente manuale.





1 1.10. Pneumatici - Controllo e sostituzione



ATTENZIONE

Prima dell'uso verificare sempre la pressione dei pneumatici ed il loro stato di usura.

Il controllo della pressione dei pneumatici è un fattore fondamentale per assicurare la sicurezza di guida. I pneumatici non sufficientemente gonfi peggiorano la maneggevolezza della moto e si usurano rapidamente; al contrario pressioni di gonfiaggio troppo elevate determinano una minore superficie di contatto con il suolo e possono ridurre l'aderenza del veicolo.

Prima di ogni utilizzo della moto è perciò indispensabile eseguire il controllo della pressione con pneumatici a temperatura ambiente, cioè con la motocicletta parcheggiata da almeno tre ore.



ATTENZIONE

L'errato gonfiaggio dei pneumatici comporta seri pericoli nell'utilizzo della moto. Una pressione insufficiente può causare lo slittamento del pneumatico sul cerchione od il suo distacco, con conseguente afflosciamento del pneumatico e perdita di controllo del veicolo.



Effettuando il controllo subito dopo avere utilizzato la motocicletta, si otterrebbero infatti dei valori più alti rispetto a quelli effettivi e ciò potrebbe portare ad un'errata regolazione della pressione dei pneumatici. Il controllo della pressione va eseguito rispettando i valori riportati al §2.2. e/o nell'etichetta situata sul lato sinistro del canotto di sterzo. Nel caso di lunghe percorrenze continuative aumentare il valore della pressione nominale di 0,2 bar.

Inoltre, prima dell'uso è estremamente importante controllare lo stato di usura dei pneumatici; i pneumatici usurati tendono infatti a subire forature con maggiore facilità, ed influiscono negativamente sulla stabilità e la maneggevolezza della moto. Nel corso del controllo assicurarsi che lo spessore del battistrada non sia al di sotto dei valori prescritti dal codice della strada e che non compaiano crepe sul fondo della scolpitura. Inoltre non devono essere presenti chiodi o frammenti di vetro sul pneumatico, né fessurazioni sul fianco dello stesso. Se queste condizioni non fos-

sero verificate, fare sostituire immediatamente il pneumatico da un concessionario MV Agusta.

**ATTENZIONE**

I limiti di profondità del battistrada possono variare da nazione a nazione. Rispettare sempre le disposizioni di legge della nazione d'impiego.

**ATTENZIONE**

- **Fare sostituire i pneumatici eccessivamente consumati da un concessionario MV Agusta. Oltre ad essere illegale, l'utilizzo del motociclo con pneumatici eccessivamente usurati riduce la stabilità di marcia e può provocare la perdita del controllo del mezzo.**
- **Se un pneumatico è forato o danneggiato va sostituito, non riparato. Un pneumatico riparato garantisce prestazioni limitate e livelli di sicurezza inferiori rispetto ad un pneumatico nuovo.**



1

Se si esegue una riparazione temporanea o di emergenza ad un pneumatico, guidare lentamente e con cautela fino al più vicino concessionario MV Agusta e far sostituire il pneumatico. Dopo la riparazione di un pneumatico non eccedere mai la velocità di 60 km/h. La riparazione non può essere effettuata se il pneumatico è forato sul fianco, o se il foro sul battistrada è più grande di 6 mm.

- Per la riparazione temporanea di un pneumatico forato, MV Agusta sconsiglia l'utilizzo di sigillanti liquidi. Questi sigillanti possono influire negativamente sul materiale degli strati del pneumatico e nascondere i danni secondari causati da eventuale penetrazione di oggetti.

- Sostituire i pneumatici utilizzando esclusivamente quelli prescritti al § 2.2. Evitare inoltre di utilizzare simultaneamente pneumatici di tipo o marca differenti tra loro per le coperture anteriori e posteriori. L'utilizzo di pneumatici impropri può influire negativamente sulla manovrabilità e la stabilità della motocicletta, aumentando il rischio di incidenti.
- I cerchi della motocicletta sono stati progettati per l'utilizzo di pneumatici tubeless. Non installare pneumatici del tipo con camera d'aria su cerchi per pneumatici tubeless. I talloni potrebbero non assestarsi correttamente ed i pneumatici, slittando sui cerchi, potrebbero afflosciarsi causando la perdita di controllo del veicolo.



- **Non installare una camera d'aria in un pneumatico tubeless. Il surriscaldamento del pneumatico potrebbe far scoppiare la camera d'aria, provocando l'afflosciamento del pneumatico e la perdita di controllo del veicolo.**
- **Fare installare i pneumatici in conformità alla direzione di rotazione indicata dalle frecce sui fianchi di ciascun pneumatico.**

- **I pneumatici nuovi devono essere sottoposti ad un periodo di rodaggio prima di raggiungere la completa efficienza; in questa fase è infatti possibile che i pneumatici abbiano una aderenza relativamente scarsa su determinate superfici stradali. Consigliamo quindi di guidare a velocità moderata ed usare estrema cautela nella guida per circa 100 km dopo l'installazione di un pneumatico nuovo.**



1 Smontaggio della ruota posteriore



Cautela-Precauzione: Nel caso in cui si rendesse necessario far effettuare la sostituzione del pneumatico posteriore presso un gommista, assicurarsi che nello smontaggio e nel rimontaggio della ruota vengano utilizzati i seguenti utensili:

- Chiave a bussola poligonale da 55 mm
- Chiave dinamometrica

Se le suddette operazioni venissero effettuate con utensili differenti, i componenti della ruota posteriore potrebbero essere gravemente danneggiati. Consigliamo quindi di non fare effettuare la sostituzione del pneumatico presso un'officina non adeguatamente attrezzata; in ogni caso è preferibile rivolgersi ad un concessionario MV Agusta.

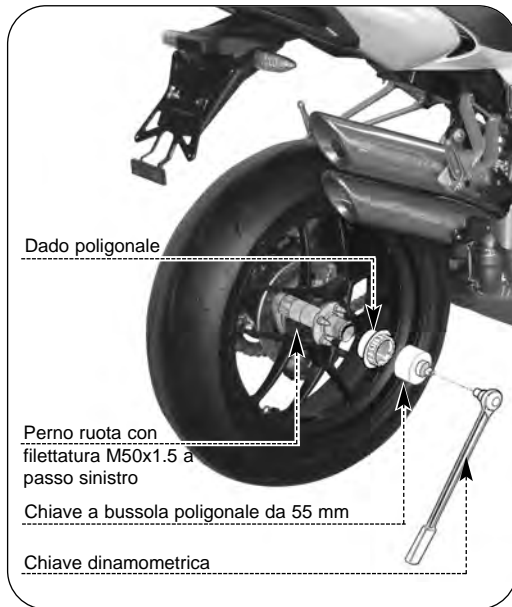



□ Controllo delle ruote

Prima di utilizzare il mezzo, controllare sempre che il cerchio della ruota non presenti cricche, piegature o deformazioni.



ATTENZIONE

Se si riscontrano danneggiamenti, fare sostituire la ruota da un concessionario MV Agusta. Non tentare di eseguire riparazioni delle ruote, neppure di lieve entità.

In caso di sostituzione del pneumatico o della ruota, occorre fare eseguire l'equilibratura della ruota presso un concessionario MV Agusta. Lo sbilanciamento della ruota può compromettere la stabilità e la manovrabilità del mezzo e ridurre la durata dei pneumatici.



ATTENZIONE

Per eseguire l'equilibratura della ruote, ricorrere esclusivamente a contrappesi omologati. È sconsigliato l'utilizzo di bilancianti liquidi o di bilancianti liquidi/sigillanti.



ATTENZIONE

Non tentare di far rimuovere un pneumatico tubeless senza la speciale attrezzatura necessaria e le protezioni per il cerchio. In caso contrario, si rischia di danneggiare o deformare la superficie di tenuta del cerchio stesso, con conseguente rischio di afflosciamento del pneumatico e perdita di controllo del veicolo.



1.11. Catena - Controllo e lubrificazione

Per effettuare le seguenti operazioni posizionare la motocicletta sul cavalletto posteriore, su un piano orizzontale e con il cambio in folle.

□ Controllo della regolazione



ATTENZIONE: Prima di controllare la regolazione della catena, rivolgersi ad un centro assistenza autorizzato MV Agusta per verificare che il veicolo presenti la quota corretta dell'assetto statico della sospensione posteriore. Accertarsi inoltre che la catena sia adeguatamente lubrificata.

L'asse del ramo inferiore della catena deve trovarsi ad una distanza di **50 mm** dal paracateni inferiore. Effettuare il controllo su più punti della catena ruotando manualmente la ruota posteriore. Il gioco deve restare pressoché costante mentre la ruota gira; se la catena presenta forti oscillazioni del gioco, ciò significa che alcune maglie sono schiacciate, grippate o allungate. Se la distanza della catena dal paracateni inferiore è maggiore di 50 mm, occorre far effettuare la regolazione della catena.

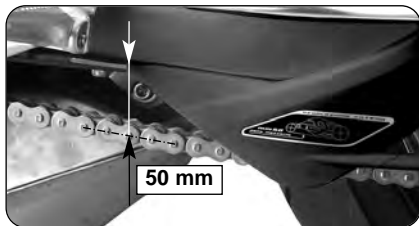

NOTA: Su richiesta, tramite il Servizio Ricambi MV Agusta è possibile ordinare uno speciale copricatena superiore in versione allungata. Il montaggio di tale componente sulla Vostra motocicletta può consentire di ottenere una maggiore protezione rispetto ad un analogo componente standard.





ATTENZIONE: L'uso della motocicletta con la catena in cattive condizioni o mal regolata può dar luogo ad incidenti. Prima di ogni uscita con la moto, effettuare il controllo della catena in conformità al presente capitolo. Nel caso in cui si rendesse necessaria la regolazione della tensione della catena, rivolgersi ad un centro assistenza autorizzato MV Agusta.



ATTENZIONE: Se la catena presenta maglie schiacciate, grippate o allungate, farne effettuare la sostituzione presso un centro assistenza autorizzato MV Agusta.



ATTENZIONE: Se si rilevano danni o usura eccessiva della catena o dei relativi ingranaggi, occorre rivolgersi ad un concessionario MV Agusta per la loro sostituzione. Ogni volta che si sostituisce la catena, anche i relativi ingranaggi devono essere rinnovati.



ATTENZIONE

Può essere pericoloso utilizzare una catena del tipo a falsamaglia. Una maglia principale non completamente rivettata, o del tipo a falsamaglia, può aprirsi e provocare incidenti o seri danni al motore. Non utilizzare mai catene con falsamaglia.



ATTENZIONE

Ogni volta che si renda necessario operare sulle viti del mozzo ruota posteriore, occorre rivolgersi ad un concessionario MV Agusta. Per il serraggio delle viti, rispettare il valore della coppia di serraggio indicata nella targhetta presente sul forcellone. Il superamento del valore indicato può causare il precoce deterioramento del mozzo ruota posteriore, compromettendo l'affidabilità del veicolo e la sicurezza del conducente e del passeggero.



1 □ Lubrificazione

La catena deve essere correttamente lubrificata per garantire la massima efficienza.

► Pulizia preliminare: prima di effettuare la lubrificazione è necessario disciogliere i depositi di sporco sulla catena utilizzando kerosene; tali depositi devono essere successivamente rimossi con un panno pulito e/o un getto d'aria.



Cautela - Precauzione: la catena è del tipo con anelli di tenuta (O-RING); per prevenirne il danneggiamento, non effettuare la pulizia della catena tramite getti di vapore o acqua ad alta pressione, né utilizzando benzina o solventi detergenti in commercio. La pulizia della catena va effettuata utilizzando esclusivamente kerosene.



ATTENZIONE

Il kerosene può essere pericoloso. Il kerosene è infiammabile. Il contatto con il kerosene può essere nocivo per i bambini e gli animali domestici.

Tenere le fiamme libere e gli oggetti ad elevata temperatura lontani dal kerosene. Tenere i bambini e gli animali domestici lontani dal kerosene. Effettuare correttamente lo smaltimento del kerosene usato.



► **Lubrificazione:** applicare un leggero ed uniforme strato di lubrificante sull'intero sviluppo della catena avendo cura di non raggiungere le parti circostanti, in particolare i pneumatici. Dirigere il getto dello spray sulla maglia interna, affinché possa lubrificare la superficie degli O-Ring e penetrare all'interno del rullo catena.



Cautela - Precauzione: utilizzare solo il lubrificante riportato nel §1.4., allo scopo di proteggere efficacemente la catena di trasmissione ed evitare la formazione di schizzi durante la marcia del veicolo.



ATTENZIONE: La lubrificazione della catena va effettuata secondo gli intervalli specificati nelle Tabelle Manutenzione Programmata del presente manuale (vedi § 1.2.). È necessario effettuare questa operazione anche dopo ogni guida sotto la pioggia e dopo ogni lavaggio della motocicletta. L'uso della motocicletta con la catena in cattive condizioni o non lubrificata può dar luogo ad incidenti.



1

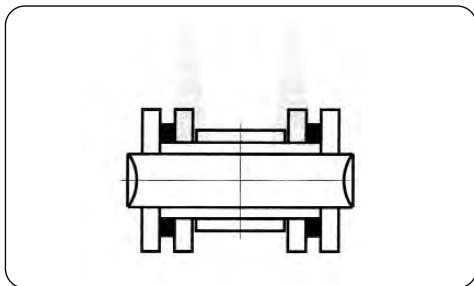



=1

1.12. Regime di minimo - Controllo

Eeguire il controllo con il motore alla temperatura di esercizio e verificare che il dispositivo “CHOKE” non sia inserito.

Il regime di minimo deve essere compreso tra 1150 e 1250 rpm.





Se occorre effettuare la regolazione, rivolgersi ai centri assistenza autorizzati.





1.13. Sostituzioni - informazioni generali

La sostituzione dei fusibili e delle lampadine può essere eseguita dal motociclista, seguendo correttamente le indicazioni fornite.

	Fusibile di ricarica batteria - Sostituzione (§1.13.1.)
	Fusibili - Sostituzione (§1.13.1.)
	Faro anabbagliante - Sostituzione lampadina (§1.13.2.)
	Faro abbagliante - Sostituzione lampadina (§1.13.3.)
	Luce targa - Sostituzione lampadina (§1.13.4.)

1.13.1. Fusibili - Sostituzione

► Il fusibile di ricarica batteria si trova sotto la sella pilota nella posizione indicata.





1

► La fusibiliera si trova sotto la sella passeggero. Per raggiungerla occorre rimuovere la sella pilota, quindi svitare l'aggancio della sella passeggero, ed estrarla.



► Sganciare e sollevare il coperchio della scatola portafusibili.





► Per identificare la posizione e la funzione dei fusibili, consultare le informazioni riportate nell'adesivo e nello schema elettrico allegato; le lettere di riferimento indicate in figura corrispondono a quelle riportate nello schema.

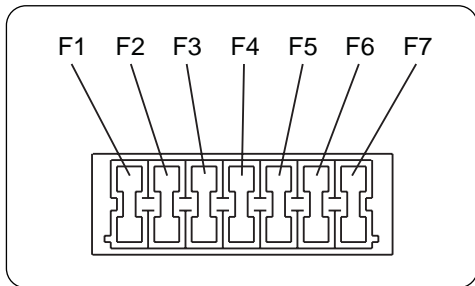

► Sostituire il fusibile bruciato e rimontare il coperchio. Tenere presente che nella busta porta attrezzi sono disponibili tre fusibili di scorta.



ATTENZIONE

Non utilizzare mai un fusibile con una taratura diversa da quella prescritta, allo scopo di evitare il danneggiamento dell'impianto elettrico della motocicletta con conseguente pericolo d'incendio.





1

1.13.2. Faro anabbagliante - Sostituzione lampadina

► Rimuovere le due viti laterali di fissaggio del faro anteriore. Prestare attenzione a sfilare il registro dalla propria sede nel momento in cui il fanale viene rimosso dal supporto.



► Prima di rimuovere il faro anteriore dal proprio supporto, scollegare il connettore posto nella parte posteriore del fanale.

► Adagiare il fanale su un tavolo allo scopo di potere effettuare le seguenti operazioni.





- ▶ Rimuovere la vite posteriore del fanale.
- ▶ Rimuovere la parte anteriore del fanale dal proprio guscio di supporto.



1

- ▶ Rimuovere la cuffia di protezione.





1

- ▶ Staccare il connettore del faro anabbagliante.
- ▶ Sganciare la molletta di ritegno.
- ▶ Estrarre la lampadina del faro anabbagliante.



Cautela - Precauzione: non toccare il vetro della lampadina con le mani. In caso di contatto pulire con un prodotto sgrassante.

- ▶ Inserire la lampadina nuova.
- ▶ Riagganciare la molletta di ritegno.
- ▶ Riattaccare il connettore del faro anabbagliante.
- ▶ Rimettere in posizione la cuffia di protezione.
- ▶ Rimontare la parte anteriore del fanale sul proprio guscio di supporto.
- ▶ Riavvitare la vite posteriore.
- ▶ Reinserrire il connettore del fanale.
- ▶ Riposizionare il fanale sul proprio supporto e riavvitare le due viti di fissaggio laterali, facendo attenzione a reinserire il registro regolazione faro nella propria sede.





1.13.3. Faro abbagliante - Sostituzione lampadina

- ▶ Rimuovere il faro anteriore dal proprio supporto come descritto al § 1.13.2.
- ▶ Estrarre la lampadina del faro abbagliante premendo lateralmente il connettore e tirandolo verso l'esterno.
- ▶ Staccare il connettore dalla lampadina.



Cautela - Precauzione: non toccare il vetro della lampadina con le mani. In caso di contatto pulire con un prodotto sgrassante.

- ▶ Inserire il connettore nella lampadina nuova.
- ▶ Reinscrivere la lampadina e fissarla spingendola leggermente nella propria sede.
- ▶ Rimontare il fanale sul proprio supporto seguendo le operazioni descritte al § 1.13.2.



1



1

1.13.4. Luce targa - Sostituzione lampadina

- ▶ Rimuovere le viti di fissaggio del guidacavi.
- ▶ Agendo secondo la modalità rappresentata in figura, abbassare il guidacavi distaccandolo dalla superficie di appoggio superiore.



- ▶ Sfilare il portalampada della luce targa dalla sua sede.
- ▶ Estrarre la lampadina sfilandola dal portalampada.
- ▶ Inserire la lampadina nuova.
- ▶ Reinserire il portalampada.
- ▶ Riposizionare il guidacavi a contatto con la superficie di appoggio superiore.
- ▶ Riavvitare le viti di fissaggio del guidacavi.





1.14. Batteria

Questo motociclo è equipaggiato con una batteria sigillata, installata sotto il codone. Tale elemento è esente da manutenzione, quindi non occorre controllare il liquido né aggiungere acqua distillata. Se la batteria sembra scarica (causando problemi elettrici o un avviamento difficoltoso), farla caricare al più presto possibile presso un concessionario MV Agusta. Tenere presente che la batteria tende a scaricarsi più rapidamente se il motociclo è equipaggiato con accessori elettrici optional.



ATTENZIONE

Se il corpo esterno della batteria è danneggiato possono verificarsi fuoriuscite di acido solforico, una sostanza velenosa ed estremamente corrosiva. Evitare qualsiasi contatto con la pelle, gli occhi e gli abiti e proteggere sempre gli occhi quando si lavora vicino alla batteria.

In caso di contatto, prestare i **PRIMI SOCCORSI** come segue.

- **CONTATTO ESTERNO:** Sciacquare con molta acqua.
- **CONTATTO INTERNO:** Bere grandi quantità di acqua o latte e chiamare immediatamente un medico.
- **OCCHI:** Sciacquare con acqua per 15 minuti e ricorrere immediatamente ad un medico.

La fuoriuscita di acido solforico comporta inoltre la formazione di idrogeno, il quale può provocare un'esplosione in presenza di una scintilla o di una fiamma.

Per effettuare la sostituzione della batteria è necessario rivolgersi ad un centro assistenza autorizzato MV Agusta.



Inattività prolungata

Se la motocicletta è destinata a non essere utilizzata per un periodo prolungato (un mese o più), è consigliabile scollegare i cavi della batteria o farla rimuovere da un meccanico qualificato. In caso di lunga inattività si raccomanda di far ricaricare la batteria presso un concessionario MV Agusta ogni 4-5 mesi, al fine di garantirne la durata nel tempo.



PERICOLO: L'inversione dei cavi della batteria può danneggiare l'impianto di carica e la batteria. I cavi rossi vanno collegati al morsetto positivo (+) della batteria e quelli neri vanno collegati al morsetto negativo (-). Per lo smontaggio della batteria scollegare **PER PRIMO** il morsetto del polo negativo, quindi quello del polo positivo. Per il rimontaggio procedere in modo inverso.





1.15. Pulizia della motocicletta

La pulizia periodica e accurata è importante per mantenere nel tempo il valore della motocicletta, proteggere la finitura delle sue superfici e controllare che non vi siano danni, usura e perdita di fluidi corrosivi.



Cautela - Precauzione: prima di effettuare il lavaggio otturare i tubi di scarico e proteggere le parti elettriche.



ATTENZIONE

Se la motocicletta è ancora calda per un uso recente, attendere che il motore e l'impianto di scarico si siano raffreddati.



Cautela - Precauzione: non utilizzare macchine di lavaggio con getti di acqua ad alta pressione o di vapore, in quanto possono provocare infiltrazioni di acqua e deterioramento dei componenti della motocicletta.



NOTA: I detersivi inquinano l'ambiente. Pertanto la pulizia del veicolo va effettuata in zone attrezzate per la raccolta e la depurazione dei liquidi di lavaggio.



1

Lavare con acqua, spugna e usare un detergente non aggressivo. Asciugare con un panno morbido. Nelle zone meno accessibili usare un getto d'aria.

**Cautela - Precauzione:**

- **Accertarsi di non utilizzare panni o spugne che siano stati a contatto con prodotti di pulizia forti o abrasivi, solventi, alcool o benzina.**
- **Per evitare danni irreversibili ai componenti della carrozzeria non usare detersivi alcalini o di elevata acidità, benzina, liquido per freni o altri solventi.**
- **In caso di dubbio sulla composizione chimica del detergente, testare l'effetto del prodotto su una piccola area prima di procedere con l'uso esteso.**

Periodicamente, trattare le parti verniciate con prodotti specifici. Se si percorrono strade trattate con prodotti corrosivi (sale) eseguire il lavaggio appena possibile, utilizzando acqua fredda; l'acqua calda favorisce l'azione corrosiva.

**ATTENZIONE**

Accertarsi che non ci sia olio o cera sui freni o sui pneumatici. Se necessario, pulire i dischi dei freni con un detergente per dischi freno e lavare i pneumatici con acqua calda ed un detergente neutro.

**ATTENZIONE**

Se i freni sono bagnati, possono provocare una riduzione della potenza di frenata ed incidenti. Dopo il lavaggio avviare il motore per qualche minuto ponendosi in marcia ad andatura ridotta, ed eseguire alcune frenate con cautela per asciugare le pastiglie e i dischi dei freni.

**ATTENZIONE**

La catena di trasmissione deve essere lubrificata subito dopo il lavaggio e l'asciugamento della motocicletta secondo le istruzioni riportate nel §1.11. del presente manuale.

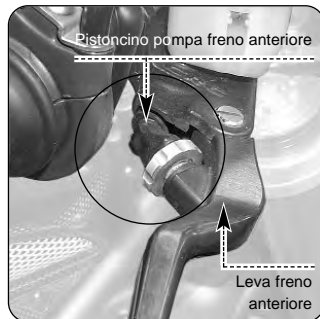
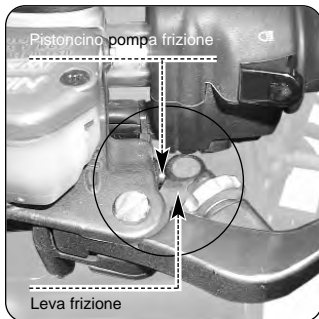
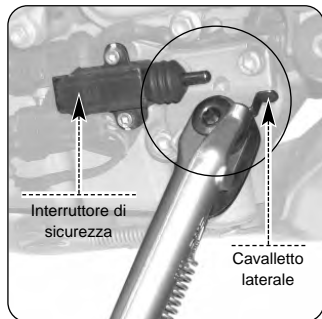

CAUTELA







Assicurarsi di mantenere sempre pulite le zone di contatto tra i seguenti componenti, come illustrato nelle figure sopra riportate:

- Cavalletto laterale ed interruttore di sicurezza
- Leva frizione e pistoncino pompa frizione
- Leva freno anteriore e pistoncino pompa freno anteriore

La pulizia di queste aree deve essere effettuata ogni 500 ÷ 1000 km come prescritto nella Tabella Manutenzione Programmata. In ogni caso, ad ogni utilizzo della moto si consiglia di verificarne lo stato di pulizia allo scopo di mantenere la corretta funzionalità delle parti interessate.

**1.16. Periodo di sosta prolungata**

Se si prevede di tenere la motocicletta ferma per un lungo periodo, è bene eseguire le operazioni di seguito elencate.

-  Vuotare il serbatoio carburante.
-  Togliere la batteria e conservarla opportunamente.
-  Togliere i cappucci delle candele e le candele. Versare un cucchiaino di olio motore in ciascun foro delle candele, dopodiché reinstallare le candele e i relativi cappucci e far ruotare a vuoto il motore per alcune volte.
-  Lubrificare tutti i cavi di comando ed i punti di rotazione di tutte le leve e dei pedali.
-  Pulire la motocicletta e trattare con prodotti specifici le parti verniciate (§1.15.).
-  Allo scopo di garantire l'integrità e le prestazioni dei pneumatici, parcheggiare la moto in un ambiente fresco, asciutto e buio, con una temperatura relativamente costante e inferiore a 25°C. Evitare il contatto diretto dei pneumatici con tubazioni o radiatori di riscaldamento, ed il contatto prolungato con olio o benzina. Evitare di collocare i pneumatici nelle vicinanze di motori elettrici o attrezzature passibili di generare scintille o scariche elettriche. Durante il periodo di sosta, mantenere la moto sollevata sul cavalletto posteriore.
-  Ricoprire la motocicletta con un apposito telo.

Al primo utilizzo della motocicletta ricordarsi di eseguire una verifica generale e far eseguire la manutenzione (§1.2.) se necessario.

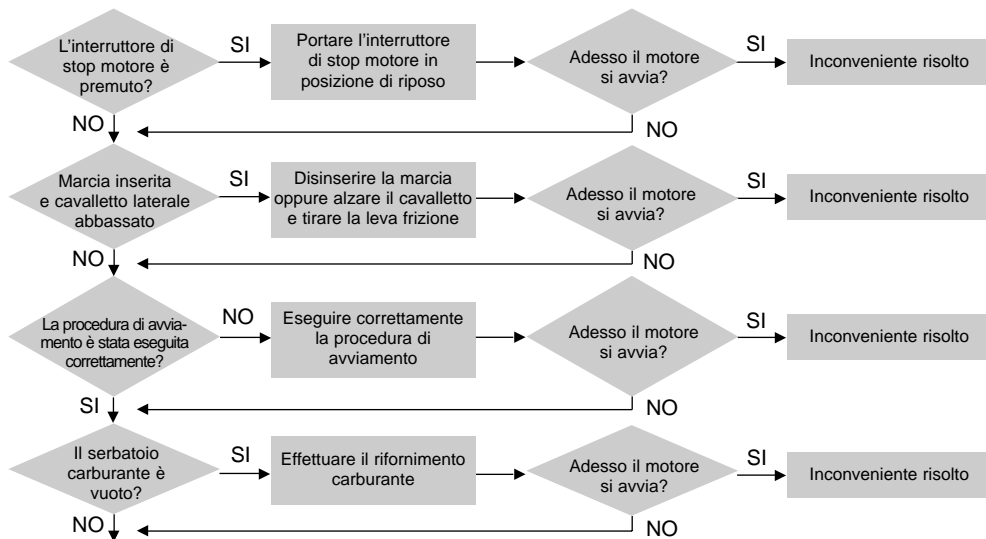
2.1. Inconvenienti al motore: **IL MOTORE NON SI AVVIA**

continua nella pagina successiva



continua dalla pagina precedente

2

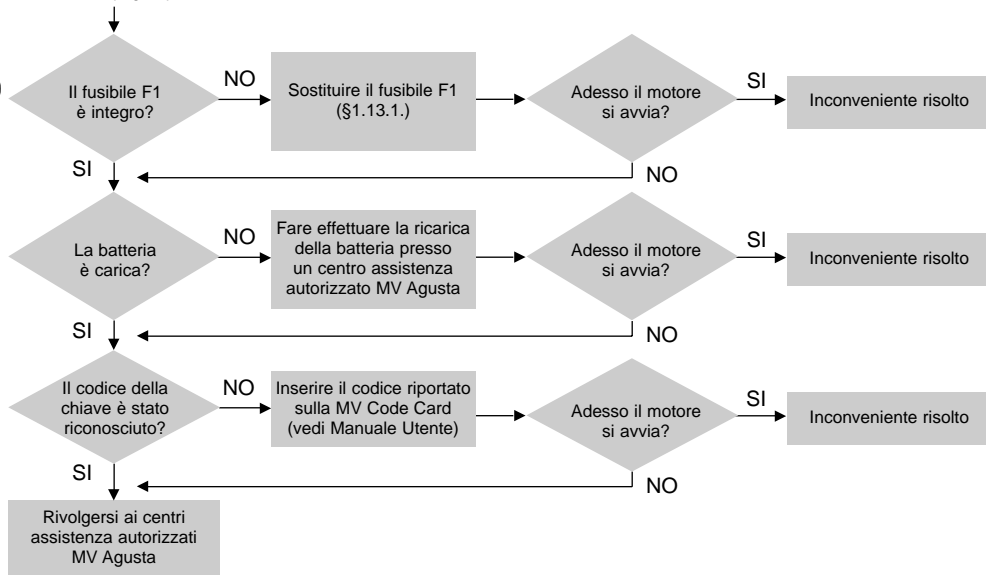



IL MOTORE SI SPENGE DURANTE LA MARCIA

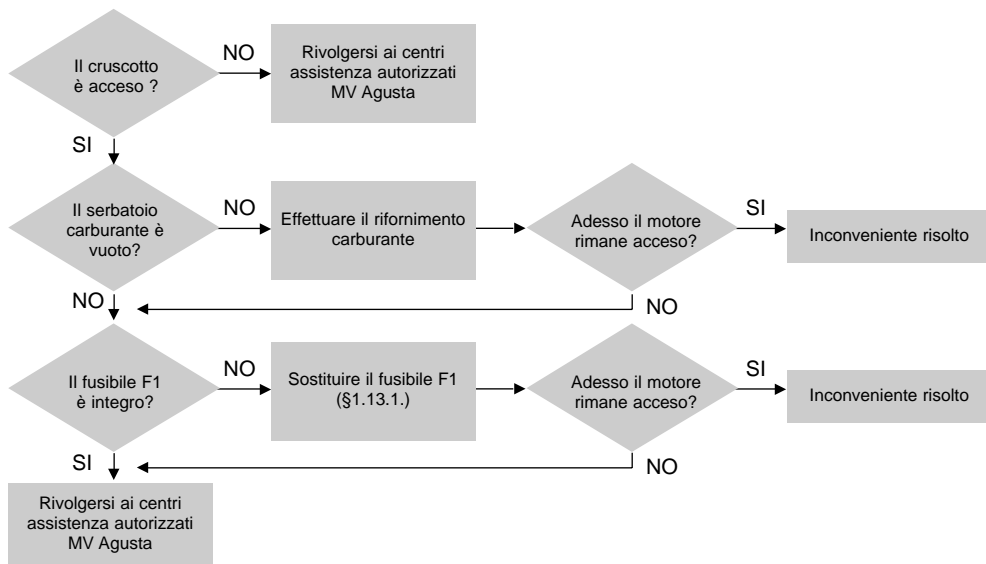



IL MOTORE SI SURRISCALDA

2

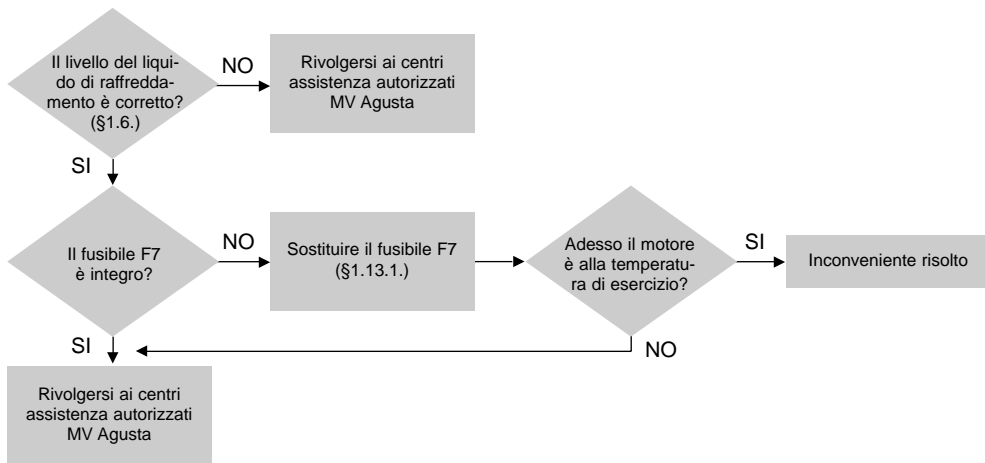



LA PRESSIONE DELL'OLIO È INSUFFICIENTE (Accensione spia pressione olio con motore in moto)

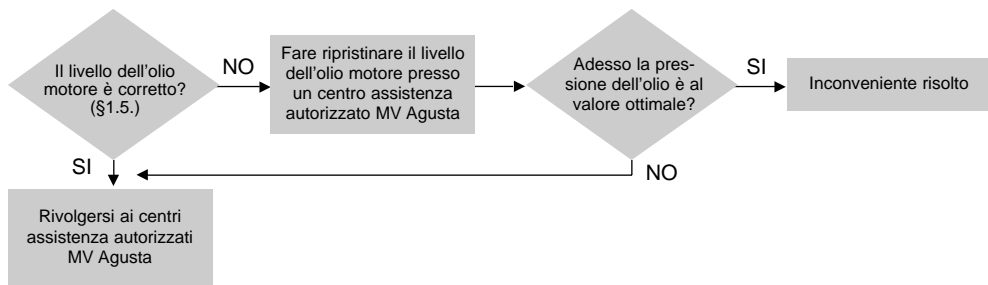



2.2. Inconvenienti all'impianto elettrico: **LE LUCI NON FUNZIONANO**

2

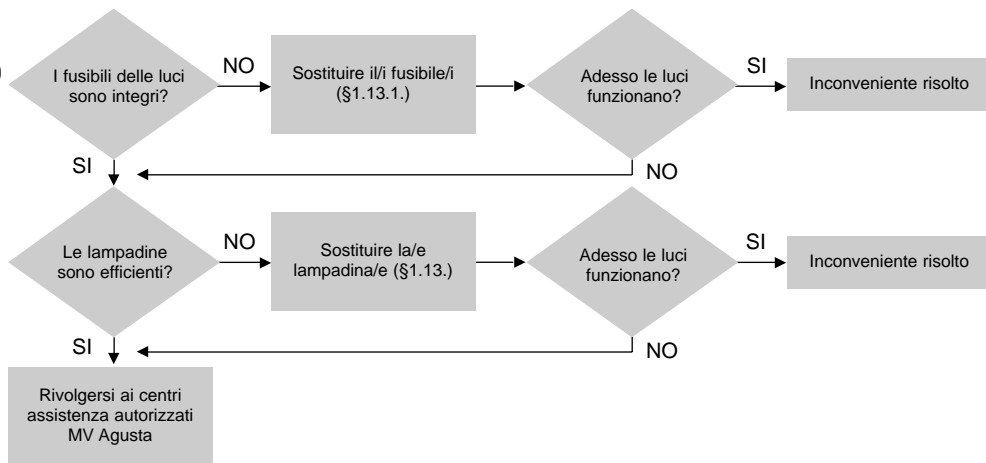



L'AVVISATORE ACUSTICO NON FUNZIONA

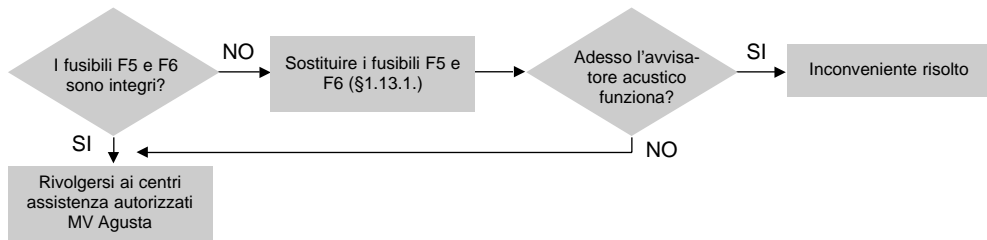

2

IL CONTACHILOMETRI NON FUNZIONA

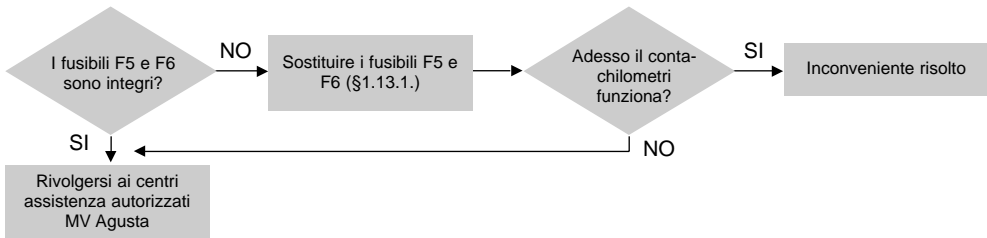



LE SPIE DEL CRUSCOTTO NON FUNZIONANO

2

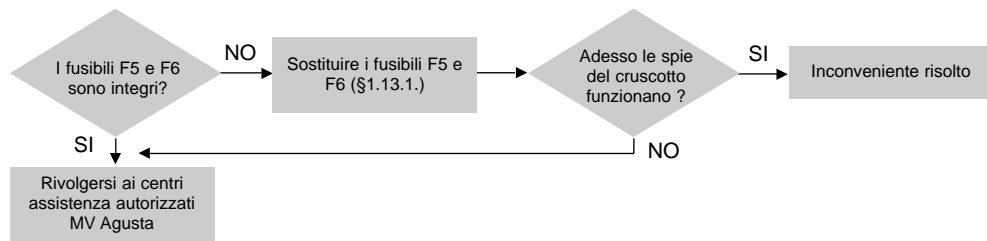

L'ALTERNATORE NON CARICA LA BATTERIA (Accensione spia carica batteria con motore in moto)

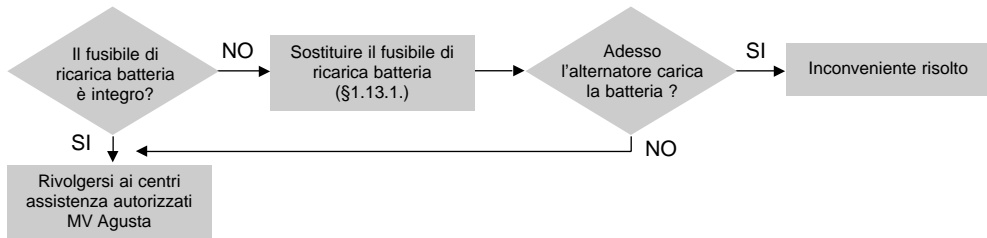



3.1. Descrizione generale della motocicletta

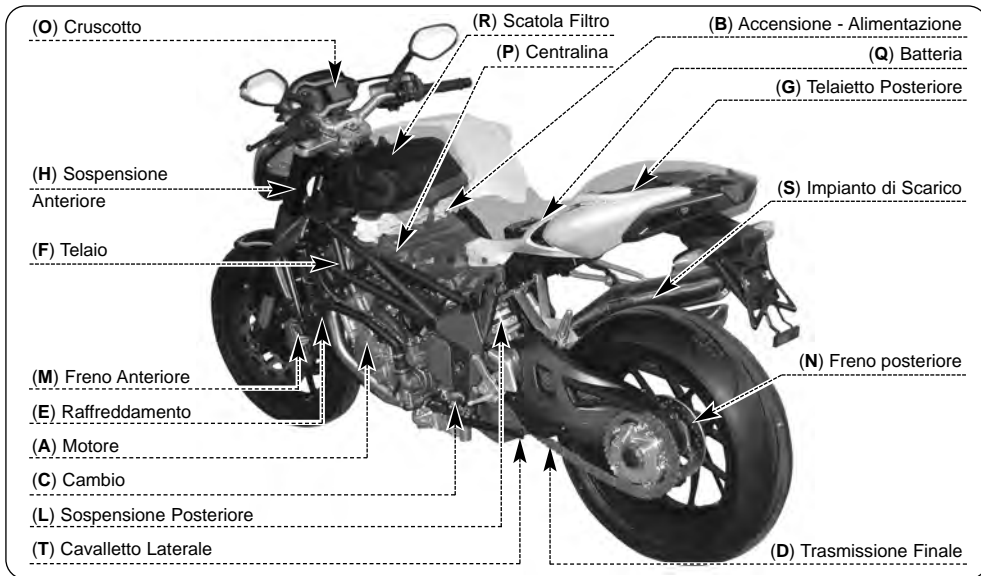



- A - Motore:** quattro tempi, quattro cilindri in linea. Distribuzione a doppio albero a camme in testa con valvole radiali. Lubrificazione a carter umido.
- B - Accensione - Alimentazione:** sistema integrato d'accensione - iniezione. Accensione elettronica a scarica induttiva. Iniezione elettronica "Multipoint".
- C - Cambio:** del tipo estraibile, a sei rapporti con ingranaggi sempre in presa.
- D - Trasmissione finale:** composta da pignone, corona e catena.
- E - Raffreddamento:** a liquido e olio con radiatori separati.
- F - Telaio:** a traliccio, in tubolare d'acciaio, con piastre laterali in alluminio.
- G - Telaietto posteriore:** a traliccio, in tubolare d'acciaio.
- H - Sospensione anteriore:** forcella oleodinamica a steli rovesciati, dotata di sistema esterno di regolazione.
- L - Sospensione posteriore:** ad azione progressiva con monobraccio oscillante e monoammortizzatore dotato di sistema esterno di regolazione.
- M - Freno anteriore:** doppio disco semi-flottante con pinze radiali a quattro pistoncini.
- N - Freno posteriore:** disco singolo con pinza a quattro pistoncini.
- O - Cruscotto:** dotato di spie segnalatrici e strumentazione analogica e digitale.
- P - Centralina :** con controllo elettronico del sistema integrato di accensione - iniezione.
- Q - Batteria :** sigillata ed esente da manutenzione.
- R - Scatola filtro:** dotata di sistema di filtrazione del flusso aria di aspirazione motore.
- S - Impianto di scarico :** dotato di convertitore catalitico per la riduzione delle emissioni inquinanti.
- T - Cavalletto laterale :** dotato di interruttore di sicurezza e doppia molla di richiamo.



3.1.1 Circuito freno anteriore

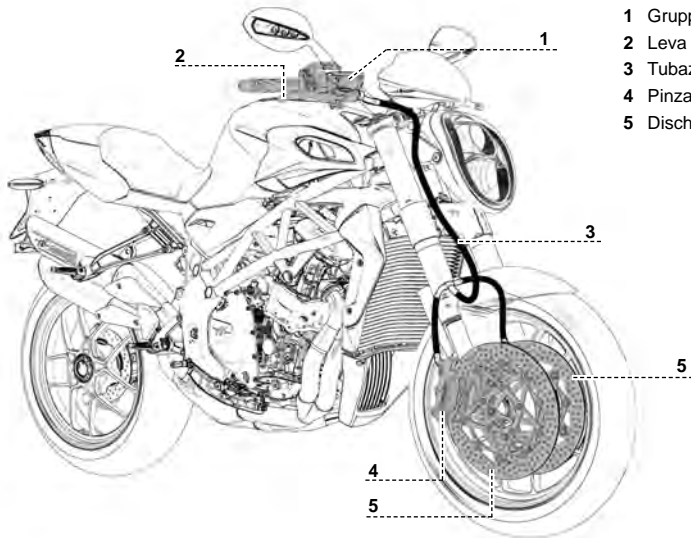

- 1 Gruppo pompa freno
- 2 Leva freno
- 3 Tubazione freno
- 4 Pinza freno
- 5 Dischi freno



3.1.2. Circuito freno posteriore

3

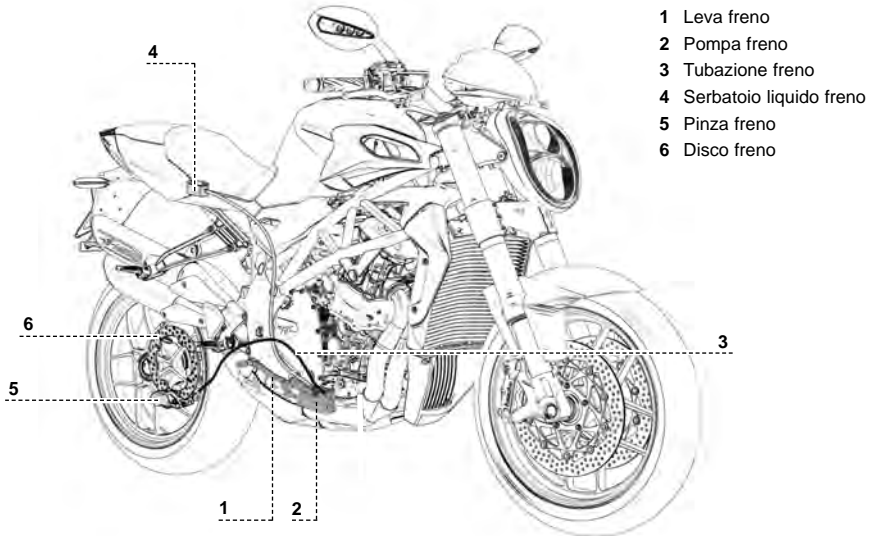



3.1.3. Circuito frizione

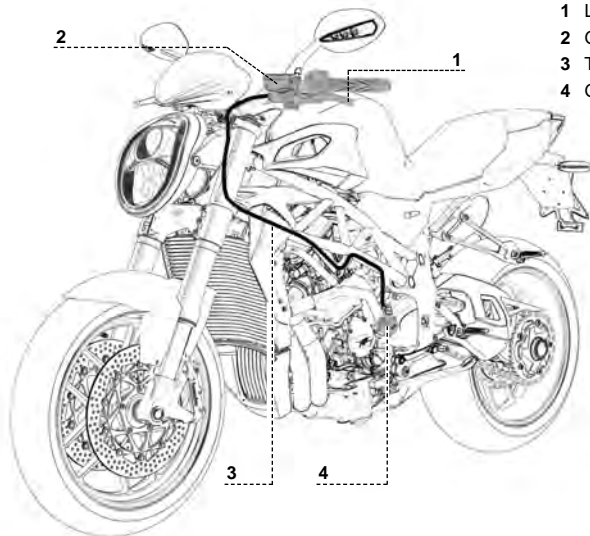

- 1 Leva frizione
- 2 Gruppo pompa frizione
- 3 Tubazione frizione
- 4 Gruppo cilindretto frizione



3.1.4. Lubrificazione motore

3

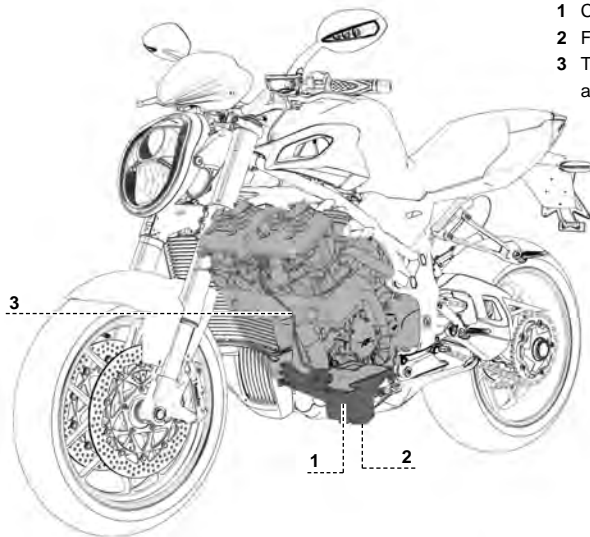

- 1 Coppa olio
- 2 Filtro olio
- 3 Tubazione mandata olio alla testa



3.1.5. Circuito di raffreddamento

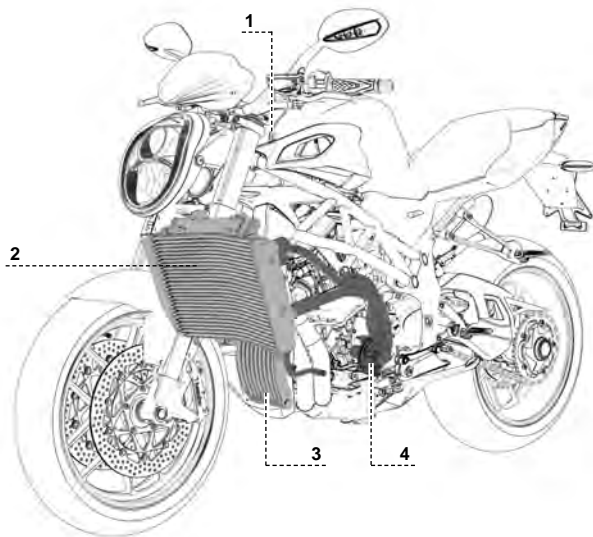

- 1 Vaso espansione
- 2 Radiatore superiore
- 3 Radiatore inferiore
- 4 Pompa liquido



3.1.6. Circuito di alimentazione

3

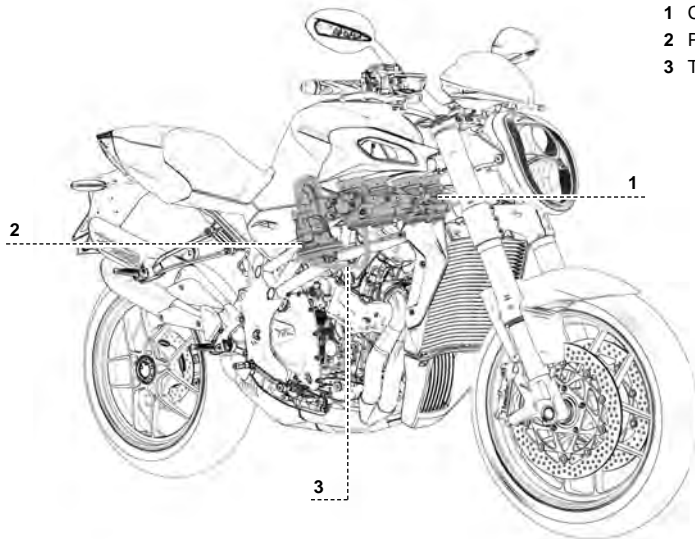

- 1 Corpi farfallati
- 2 Pompa carburante
- 3 Tubazione carburante

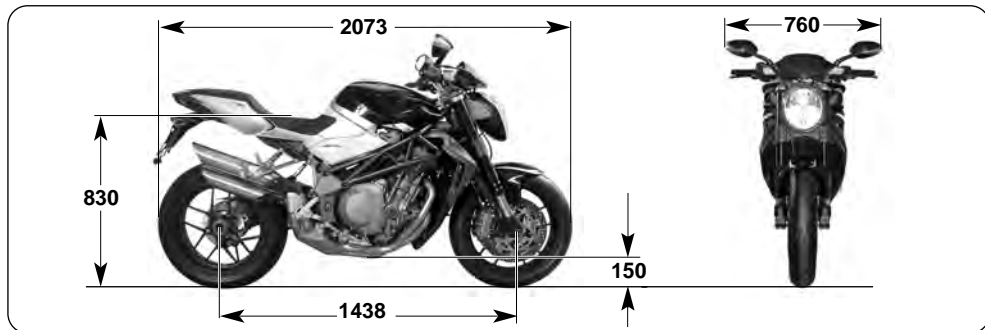

3

3.2. Dati tecnici

Descrizione	BRUTALE 1090 RR
CARATTERISTICHE	
Interasse (mm) (*)	1438
Lunghezza totale (mm) (*)	2073
Larghezza max. (mm)	760
Altezza sella (mm) (*)	830
Altezza min. da terra (mm) (*)	150
Avancorsa (mm) (*)	103,5

*: I dati dichiarati non sono vincolanti. Essi sono suscettibili di variazioni in funzione delle condizioni di assetto del veicolo.



Dati tecnici

Descrizione	BRUTALE 1090 RR
Peso a secco (Kg)	190
Capacità serbatoio carburante (lt) (*)	19
Riserva carburante (lt) (*)	4
Q.tà olio nel basamento (Kg)	3,5
MOTORE	
Tipo	Quattro cilindri, 4 tempi, 16 valvole
Alesaggio (mm)	79,0
Corsa (mm)	55,0
Cilindrata totale (cm ³)	1078
Rapporto di compressione	13:1
Avviamento	Elettrico
Raffreddamento	A liquido e olio con radiatori separati
Carter motore e coperchi	Pressofusi
Testa e cilindri	Fusi in conchiglia
Valvole	Bimetalliche / monometalliche
DISTRIBUZIONE	
Tipo	Doppio albero a camme in testa; valvole radiali

* : I dati dichiarati non sono vincolanti. Essi sono suscettibili di variazioni in funzione della temperatura esterna, della temperatura del motore e del punto di evaporazione della benzina utilizzata.

**Dati tecnici**

Descrizione	BRUTALE 1090 RR
LUBRIFICAZIONE	
Tipo	A carter umido
ACCENSIONE - ALIMENTAZIONE	
Tipo	Sistema di accensione/iniezione Magneti Marelli 5.SM con corpo farfallato Mikuni. Accensione elettronica a scarica induttiva. Iniezione elettronica "Multipoint" sequenziale fasata.
Candele	NGK CR9 EB
Distanza elettrodi (mm)	0.7 ÷ 0.8
FRIZIONE	
Tipo	Multidisco in bagno d'olio
TRASMISSIONE PRIMARIA	
Numero denti ingranaggio albero motore	Z = 50
Numero denti ingranaggio frizione	Z = 79
Rapporto di trasmissione	1.58
TRASMISSIONE SECONDARIA	
Numero denti pignone	Z = 15
Numero denti corona	Z = 41
Rapporto di trasmissione	2.73
CAMBIO VELOCITÀ	
Tipo	Estraibile a sei velocità con ingranaggi sempre in presa



Dati tecnici

Descrizione	BRUTALE 1090 RR
Rapporti cambio (rapporti totali)	
Prima	2.92 (12.59)
Seconda	2.12 (9.14)
Terza	1.78 (7.68)
Quarta	1.50 (6.47)
Quinta	1.32 (5.69)
Sesta	1.21 (5.22)
TELAIO	
Tipo	Tubolare a traliccio in tubi trafilati di acciaio 25 CrMo (saldati in TIG)
Piastre fulcro forcellone	Legha di alluminio
SOSPENSIONE ANTERIORE	
Tipo	Forcella oleodinamica a steli rovesciati con sistema di regolazione esterno e separato del freno in estensione, in compressione e del precarico molla
Ø steli (mm)	50
Corsa sull'asse gambe (mm)	125
SOSPENSIONE POSTERIORE	
Tipo	Progressiva, monoammortizzatore regolabile in estensione, in compressione (Alta velocità / Bassa velocità) e nel precarico molla
Forcellone	Legha di alluminio
Corsa ruota (mm)	120



Dati tecnici

Descrizione	BRUTALE 1090 RR
FRENO ANTERIORE	
Tipo	A doppio disco flottante con fascia frenante in acciaio
Ø disco (mm)	320
Flangia disco	Acciaio
Pinze (diametro pistoncini mm)	Radiale monoblocco a 4 pistoncini (Ø 34)
FRENO POSTERIORE	
Tipo	A disco in acciaio
Ø disco (mm)	210
Pinza (diametro pistoncini mm)	A 4 pistoncini (Ø 25.4)
CERCHIO ANTERIORE	
Materiale	Lega di alluminio
Dimensione	3.50" x 17"
CERCHIO POSTERIORE	
Materiale	Lega di alluminio
Dimensione	6.00" x 17"
PNEUMATICI	
Anteriore	120/70-ZR 17 (58 W)
Posteriore	190/55-ZR 17 (75 W)
Marca e tipo	DUNLOP - Sport Max Qualifier RR PIRELLI - Dragon Supercorsa Pro



Dati tecnici

Descrizione	BRUTALE 1090 RR
Pressione di gonfiaggio (*):	
Anteriore	2.3 bar (33 psi)
Posteriore	2.3 bar (33 psi)
IMPIANTO ELETTRICO	
Tensione impianto	12 V
Luce anabbagliante anteriore	12 V - 55 W
Luce abbagliante anteriore	12 V - 55 W
Luce di posizione posteriore	12 V - 5 W
Batteria	12 V - 8 Ah
Alternatore	350 W a 5000 giri/min.
CARROZZERIA	
Serbatoio	Materiale termoplastico
Convogliatori air-box	Materiale termoplastico
Fianchetti serbatoio	Materiale termoplastico
Fianchetti posteriori codino	Materiale termoplastico
Codino	Alluminio
Protezione strumentazione	Materiale termoplastico

* : Nell'eventualità di utilizzo di pneumatici di marche differenti da quelle consigliate, riferirsi al valore della pressione di gonfiaggio marcato dal costruttore sul fianco del pneumatico.

**Dati tecnici**

Descrizione	BRUTALE 1090 RR
Coperchio interruttore accensione	Materiale termoplastico
Parafango anteriore	Materiale termoplastico
Protezioni catena	Materiale termoplastico
Protezione radiatore olio	Materiale termoplastico
Portatarga	Materiale termoplastico
Specchietti retrovisori	Materiale termoplastico
Protezione tubo scarico	Alluminio



3





3.3. Riferimento colori componenti sovrastrutture

Le parti verniciate delle sovrastrutture presentano i seguenti colori di riferimento, in relazione al rispettivo codice colore della motocicletta:

1. - Fianchetto posteriore destro;
2. - Fianchetto posteriore sinistro;
3. - Fianchetto serbatoio destro;
4. - Fianchetto serbatoio sinistro:

Codici colore A-D-F:

Argento F4 AGO (Cod. Palinal 928XV025)

Codici colore B-E:

Bianco Perlato CRC (Cod. Palinal 927.PE20)

Codice colore C:

Antracite Metallizzato "Senna" (Cod. PPG GM WA9561)

5. - Parafango anteriore;
6. - Fianchetti airbox:

Codici colore A-D:

Rosso F4 AGO (Cod. Palinal 926R750)

Codici colore B-C-E:

Nero Intenso CRC (Cod. Palinal 929R486H)

Codice colore F:

Grigio Titanium (Cod. Palinal L821)

7. - Serbatoio benzina:

Codici colore A-D:

Rosso F4 AGO (Cod. Palinal 926R750) +
Argento F4 AGO (Cod. Palinal 928XV025)

Codici colore B-E:

Nero Intenso CRC (Cod. Palinal 929R486H) +
Bianco Perlato CRC (Cod. Palinal 927.PE20)

Codice colore C:

Nero Intenso CRC (Cod. Palinal 929R486H) +
Antracite Metallizzato "Senna" (Cod. PPG GM WA9561)

Codice colore F:

Grigio Titanium (Cod. Palinal L821) +
Argento F4 AGO (Cod. Palinal 928XV025)

8. - Protezione radiatore destra;
9. - Protezione radiatore sinistra;
10. - Copertura cruscotto;

Grigio Carbon metallizzato
(Cod. Palinal L921)



3





3.4. Riferimento colori componenti telaio e ciclistica

Le parti verniciate di telaio e ciclistica della motocicletta presentano i seguenti colori di riferimento:

1. - Telaio:

Codici colore A-B-C:

Bronzo Opaco B5

(Cod. Palinal 211F297)

Codici colore D-E:

Grigio Antracite metallizzato MV

(Cod. Palinal 211XH893)

Codice colore F:

Rosso Ciclistica

(Cod. Palinal 211XH987)

2. - Supporto fanale:

Codici colore A-B-C:

Bronzo Opaco B5 (Cod. Palinal 211F297)

Codici colore D-E-F:

Grigio Antracite metallizzato MV

(Cod. Yi-Mei AC MAT Black Silver)

3. - Motore:

Nero Opaco (Cod. Pulverit 3500/0085)

4. - Codino;

5. - Base di sterzo:

Grigio Carbon metallizzato

(Cod. Palinal L921)

6. - Piastra fulcro forcellone destra;

7. - Piastra fulcro forcellone sinistra;

8. - Forcellone posteriore:

Grigio Carbon metallizzato

(Akzo Nobel RPU MIC 09 BP 1663/5)

9. - Supporto pedana posteriore destro;

10. - Supporto pedana posteriore sinistro:

Grigio Alluminio fine metallizzato

(Cod. Palinal F444)



Nota informativa

MV Agusta S.p.A. è impegnata in una politica di continuo miglioramento dei propri prodotti; per questa ragione potrebbe essere possibile riscontrare leggere differenze tra quanto riportato nel presente documento ed il veicolo da Voi acquistato. I modelli MV Agusta vengono esportati in numerosi Paesi, nei quali valgono norme differenti in relazione al Codice della Strada ed alle procedure di omologazione. Contando sulla Vostra comprensione, MV Agusta S.p.A. ritiene quindi necessario riservarsi il diritto di apportare modifiche ai propri prodotti ed alla propria documentazione tecnica in qualsiasi momento e senza fornirne preavviso.

3

Vi consigliamo di visitare periodicamente il sito Internet www.mvagusta.it per ottenere informazioni ed aggiornamenti sui prodotti MV Agusta e sulla relativa documentazione.



Rispettiamo e difendiamo l'ambiente

Tutto ciò che facciamo ha ripercussioni sull'intero pianeta e sulle sue risorse.

MV Agusta, a tutela degli interessi della comunità, sensibilizza i Clienti e gli operatori dell'assistenza tecnica ad adottare modalità d'uso del mezzo e di smaltimento di sue parti, nel pieno rispetto delle normative vigenti in termini di inquinamento ambientale, smaltimento e riciclaggio dei rifiuti.

© 2010

È vietata la riproduzione anche parziale di questo documento senza il consenso scritto della MV Agusta S.p.A.

Part. n° 8000B3379

Edizione n° 2 - Luglio 2010



BRUTALE

1090

MV AGUSTA



Maintenance manual

English Version



CONTENTS

<i>chap.</i>	<i>Subject covered</i>	<i>page</i>
1	MAINTENANCE	3
1.1.	Symbols	3
1.2.	Tables of scheduled maintenance and checks	4
1.3.	Tools and accessories supplied	14
1.4.	Table of lubricants and fluids	15
1.5.	Checking the engine oil level	16
1.5.1.	Topping up the engine oil level	17
1.6.	Checking the coolant level	19
1.6.1.	Topping up the coolant level	20
1.7.	Checking the wear of the brake pads	22
1.8.	Checking the brake fluid level	23
1.9.	Checking the clutch fluid level	25
1.10.	Checking and replacing the tyres	26
1.11.	Checking and lubricating the drive chain	32
1.12.	Checking the idle speed	36
1.13.	Replacing parts - General information	37
1.13.1.	Replacing the fuses	37
1.13.2.	Replacing the low beam bulb	40
1.13.3.	Replacing the high beam bulb	43
1.13.4.	Replacing the license plate light bulb	44
1.14.	Battery	45
1.15.	Cleaning the motorcycle	47
1.16.	Prolonged inactivity	50

<i>chap.</i>	<i>Subject covered</i>	<i>page</i>
2	TROUBLESHOOTING FLOW CHART	51
2.1.	Engine problems	51
2.2.	Electrical equipment problems	56
3	TECHNICAL INFORMATION	59
3.1.	Motorcycle overview	59
3.1.1.	Front brake circuit	61
3.1.2.	Rear brake circuit	62
3.1.3.	Clutch circuit	63
3.1.4.	Engine lubrication	64
3.1.5.	Coolant circuit	65
3.1.6.	Fuel system	66
3.2.	Specifications	67
3.3.	Bodywork parts reference colours	75
3.4.	Frame parts reference colours	77



1.1. Symbols

Sections of text that are particularly important in terms of personal safety or possible damage to the motorcycle are marked with the following symbols:



Danger - Failure to observe these prescriptions, even in part, may pose a serious hazard to the driver's and other people's safety.



Caution - Failure to observe these prescriptions, even in part, may result in damage to the motorcycle.

The following symbols give an indication of who is supposed to perform the different adjustments and/or maintenance operations:



Information on operations that can be carried out by the user.



Information on operations that must be carried out only by authorized personnel.

The following symbols are used to provide further information:



The “” symbol points out the requirement to use a tool or a special equipment in order to correctly perform the described operation.



The “§” symbol refers the reader to the chapter identified by the number that follows.



1.2. Tables of scheduled maintenance and checks

The main periodic checks and maintenance operations are shown in the following tables. These operations are necessary to keep the motorcycle safe and in perfect running order.

The intervals indicated in the periodic maintenance and lubrication tables must be intended as a general guide under normal riding conditions. It could be necessary to reduce these intervals according to the climate, the ground conditions, the geographic position and the conditions of use.

Some of the operations can be carried out by the user, providing he or she possesses the requisite skills. If unskilled, have the operations performed by an authorized service centre.

As a rule maintenance operations must be performed while the motorcycle is on the rear stand after switching off the engine and setting the start switch to OFF. On the contrary, while checking the fluid levels it is advisable to keep the motorcycle in an upright position without using the rear stand.

After the first 36,000 km (22,400 mi) the operations must be performed at the same intervals shown in the tables.

**WARNING**

- **Impropriety or lack of recommended maintenance operations can lead to an increase of the risk of accidents and damage to the motorcycle.**
- **Always use genuine MV Agusta spare parts. Using non-genuine spare parts can accelerate the wear of your motorcycle and shorten its life.**
- **Failure to perform the recommended operations, as well as using non-genuine spare parts, could cause the warranty not to be operating.**
- **To replace or top up the lubricants and fluids of your motorcycle, use only the products given at paragraph 1.4.**

**WARNING**

If you use the motorcycle on race track, we recommend to have the bike checked before and after using it by skilled personnel belonging to the MV Agusta Service Centers network. Using the motorcycle on road track is allowed only occasionally and, however, not for competitive purpose, even during amateur events. Using the motorcycle on road track could cause a considerable increase of the wear of its components, which would bring to a reduction of their life duration with reference to a normal use on road or highway route.



GB 1

Tables of scheduled maintenance

km (mi) covered		0	1000 (600)	6000 (3800)	12000 (7500)	18000 (11200)	24000 (14900)	30000 (18600)	36000 (22400)
Service coupon		Pre-delivery	A	B	C	D	E	F	G
DESCRIPTION		OPERATION							
Engine oil		Check level	Every time vehicle is used						
		Renew	●	●	●	●	●	●	●
			At least once a year						
Engine oil filter		Replace (Use only MV Agusta genuine spare oil filters)	●	●	●	●	●	●	●
				Every time engine oil is changed					
Coolant		Check / Restore level	Every time vehicle is used						
		Check / Restore level	●	●	●	●	●	●	●
		Renew	At least every two years						
Cooling system		Check for leakage	●	●	●	●	●	●	●
Electric fans		Check operation	●	●	●	●	●	●	●
Valves		Check / Adjust			●		●		●
Timing chain		Check			●		●		
		Replace							●





Tables of scheduled maintenance

<i>km (mi) covered</i>		0	1000 (600)	6000 (3800)	12000 (7500)	18000 (11200)	24000 (14900)	30000 (18600)	36000 (22400)	
<i>Service coupon</i>		<i>Pre-delivery</i>	A	B	C	D	E	F	G	
<i>DESCRIPTION</i>		<i>OPERATION</i>								
Timing movable shoe		Check / Replace			●		●			
		Replace							●	
			Every time timing chain is replaced							
Timing chain stretcher		Check / Replace			●		●		●	
Spark plugs		Check / Replace		●		●		●		
		Replace			●		●		●	
Fuel filter		Check / Replace			●		●		●	
Throttle body		Check and Adjust	●	●	●	●	●	●	●	
Air filter		Check / Replace		●	●	●	●	●	●	
Brakes / Clutch fluid		Check level	Every time vehicle is used							
		Check level	●	●	●	●	●		●	●
		Renew						●		
			At least every two years							





GB 1

Tables of scheduled maintenance

<i>km (mi) covered</i>		<i>0</i>	<i>1000 (600)</i>	<i>6000 (3800)</i>	<i>12000 (7500)</i>	<i>18000 (11200)</i>	<i>24000 (14900)</i>	<i>30000 (18600)</i>	<i>36000 (22400)</i>	
<i>Service coupon</i>		<i>Pre-delivery</i>	<i>A</i>	<i>B</i>	<i>C</i>	<i>D</i>	<i>E</i>	<i>F</i>	<i>G</i>	
<i>DESCRIPTION</i>		<i>OPERATION</i>								
Brakes / Clutch		Check operation	Every time vehicle is used							
		Clean lever / master cyl. piston contact area	Every 500 ÷ 1000 km (300 ÷ 600 mi)							
		Check operation	●	●	●	●	●	●	●	●
		Check lines for leakage	●	●	●	●	●	●	●	●
Brake pads (front and rear)		Clean lever / master cyl. piston contact area	●	●	●	●	●	●	●	●
		Check wear	Every 1000 km (600 mi)							
Fuel lines and connections		Check / Replace		●	●	●	●	●	●	●
		Check for leakage		●	●	●	●	●	●	●
Throttle control		Replace	At least every 3 years							
		Check operation	Every time vehicle is used							
		Check operation	●	●	●	●	●	●	●	●
Choke control		Check / Adjust play	●	●	●	●	●	●	●	●
		Check operation	●	●	●	●	●	●	●	●





Tables of scheduled maintenance

<i>km (mi) covered</i>		<i>0</i>	<i>1000 (600)</i>	<i>6000 (3800)</i>	<i>12000 (7500)</i>	<i>18000 (11200)</i>	<i>24000 (14900)</i>	<i>30000 (18600)</i>	<i>36000 (22400)</i>
<i>Service coupon</i>		<i>Pre-delivery</i>	<i>A</i>	<i>B</i>	<i>C</i>	<i>D</i>	<i>E</i>	<i>F</i>	<i>G</i>
<i>DESCRIPTION</i>		<i>OPERATION</i>							
Flexible controls and transmissions		Check / Adjust	●	●	●	●	●	●	●
Drive chain 		Check	Every 1000 Km (600 mi)						
		Lubricate	Every 1000 Km (600 mi) and after riding under the rain						
		Check / Adjust	●	●	●	●	●	●	●
		Lubricate		●	●		●		●
Front sprocket / Tab washer 		Replace			●		●		●
		Check		●	●		●		●
		Replace	Every time drive chain is replaced						
Rear sprocket 		Check		●	●		●		●
		Replace				●		●	
			Every time drive chain is replaced						



Tables of scheduled maintenance

<i>km (mi) covered</i>		<i>0</i>	<i>1000 (600)</i>	<i>6000 (3800)</i>	<i>12000 (7500)</i>	<i>18000 (11200)</i>	<i>24000 (14900)</i>	<i>30000 (18600)</i>	<i>36000 (22400)</i>	
<i>Service coupon</i>		<i>Pre-delivery</i>	<i>A</i>	<i>B</i>	<i>C</i>	<i>D</i>	<i>E</i>	<i>F</i>	<i>G</i>	
<i>DESCRIPTION</i>		<i>OPERATION</i>								
Rear sprocket spring drive		Check / Replace			●		●		●	
Steering head tube ring		Check / Adjust	●		●		●		●	
Steering bearings		Check / Adjust	●		●		●		●	
		Lubricate					●			
Tyres		Check pressure	Every time vehicle is used; at least every 10 days							
		Check wear	Every time vehicle is used; at least every 500 Km (300 mi)							
		Check pressure	●	●	●	●	●	●	●	●
		Check wear		●	●	●	●	●	●	●
Wheel rims		Inspect visually		●	●	●	●	●	●	
			Every time tyre is replaced							
Front wheel bearings		Check		●	●	●	●	●		
			Every time tyre is replaced							
		Replace								●



Tables of scheduled maintenance

km (mi) covered		0	1000 (600)	6000 (3800)	12000 (7500)	18000 (11200)	24000 (14900)	30000 (18600)	36000 (22400)
Service coupon		Pre-delivery	A	B	C	D	E	F	G
DESCRIPTION		OPERATION							
Sidestand		Check operation							
		Every time vehicle is used							
Side stand switch		Check operation							
		Every time vehicle is used							
		Clean contact area with sidestand							
		Every 500 ÷ 1000 km (300 ÷ 600 mi)							
Rear wheel hub		Check / Lubricate needle bearing							
		Replace / Lubricate needle bearing							
Swingarm bearings		Check / Lubricate							
Drive chain pads on swingarm		Check / Replace							
Drive chain pads on frame plate		Check / Replace							
Rear shock absorber		Check / Adjust							
Front fork oil		Renew							



GB
1

Tables of scheduled maintenance

<i>km (mi) covered</i>		<i>0</i>	<i>1000 (600)</i>	<i>6000 (3800)</i>	<i>12000 (7500)</i>	<i>18000 (11200)</i>	<i>24000 (14900)</i>	<i>30000 (18600)</i>	<i>36000 (22400)</i>
<i>Service coupon</i>		<i>Pre-delivery</i>	<i>A</i>	<i>B</i>	<i>C</i>	<i>D</i>	<i>E</i>	<i>F</i>	<i>G</i>
<i>DESCRIPTION</i>		<i>OPERATION</i>							
Battery connections		Check and clean	●	●	●	●	●	●	●
Electrical equipment		Check operation	●	●	●	●	●	●	●
Instrument panel		Check operation	Every time vehicle is used						
		Check operation	●	●	●	●	●	●	●
Lights / Visual signals		Check operation / Replace bulbs	Every time vehicle is used						
		Check operation / Replace bulbs	●	●	●	●	●	●	●
Horn		Check operation	Every time vehicle is used						
		Check operation	●	●	●	●	●	●	●
Headlight		Check operation	Every time vehicle is used						
		Adjust	Every time geometry is changed and every time you seat a passenger						
		Check operation	●	●	●	●	●	●	●
Ignition switch		Check operation	Every time vehicle is used						
		Check operation	●	●	●	●	●	●	●





Tables of scheduled maintenance

<i>km (mi) covered</i>		<i>0</i>	<i>1000 (600)</i>	<i>6000 (3800)</i>	<i>12000 (7500)</i>	<i>18000 (11200)</i>	<i>24000 (14900)</i>	<i>30000 (18600)</i>	<i>36000 (22400)</i>	
<i>Service coupon</i>		<i>Pre-delivery</i>	<i>A</i>	<i>B</i>	<i>C</i>	<i>D</i>	<i>E</i>	<i>F</i>	<i>G</i>	
<i>DESCRIPTION</i>		<i>OPERATION</i>								
Locks		Check operation	Every time vehicle is used							
		Check operation	●	●	●	●	●	●	●	●
Screws and nuts		Check / Tighten	●	●	●	●	●	●	●	●
Hose clamps		Check / Tighten	●	●	●	●	●	●	●	●
General lubrication			●	●	●	●	●	●	●	●
General test			●	●	●	●	●	●	●	●



GB
1

1.3. Tools and accessories supplied

A bag in the glove compartment contains the following tools:

- 1 hexagonal bar (10 mm hexagon);
- 6 Allen keys (2,5 - 3 - 4 - 5 - 6 - 8 mm hexagons);
- 1 spanner for rear wheel eccentric with extension;
- 1 fuse puller;
- 3 fuses (5A - 7,5A - 15A).

The following accessories are also supplied:

- 1 spark plug wrench (16 mm hexagon);
- 1 document holder.





1.4. Table of lubricants and fluids

<i>Description</i>	<i>Recommended product</i>	<i>Specifications</i>
Engine lubrication oil	AGIP RACING 4T 10W/60 (*)	SAE 10W/60 - API SJ
Coolant	AGIP ECO - PERMANENT	Ethylene glycol diluted with 50 percent distilled water
Brake and clutch fluid	AGIP BRAKE FLUID DOT4	DOT4
Drive chain lubrication oil	MOTUL CHAIN LUBE ROAD	–

* : MV Agusta suggests to refer directly to its authorized dealers in order to purchase the recommended product. The AGIP Racing 4T 10W/60 engine oil has been expressly produced for the Brutale motorcycle engine. If the above described lubricant is not available, MV Agusta suggests to use a fully synthetic engine oil having characteristics equal or better than the ones prescribed in the following standards:

- Consistent with: API SJ
- Consistent with: ACEA A3
- Consistent with: JASO MA
- SAE Rating: SAE 20 W-50 o 10 W-60

NOTE

The above standard denominations must be written, alone or together, on the engine oil container label.





1.5. Checking the engine oil level

Check the oil level while the engine is not running, and has been allowed to cool down for at least ten minutes after a ride.

The check must be performed after placing the motorcycle in an upright position on a horizontal surface.

The level must be between the MAX and MIN marks on the crankcase.

If the oil level is below the MIN mark, top up as described in § 1.5.1.



WARNING

Do not start the engine if the oil level is below the MIN mark.

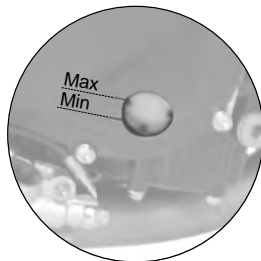



1.5.1. Topping up the engine oil level

To top up the engine oil level, remove the oil filler plug by using the 10 mm hexagonal bar supplied, assembled on a proper key (see figure). Pour an appropriate amount of engine oil of the recommended type. Never exceed the MAX level mark. At the end of the operation, place back the oil filler plug.



WARNING

Before reassembling the oil filler plug, grease its O-Ring by using AGIP Grease 30.

At last, perform the tightening of the oil filler plug at the tightening torque of 35 Nm, by using a dynamometric key.

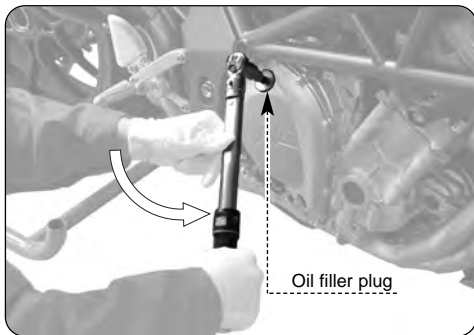

CAUTION

To avoid clutch sliding and damage to the engine, never add chemical additives to the engine oil, nor use an engine oil different from the one specified in the table at § 1.4. Make sure that no foreign body gets in the crankcase while topping up the engine oil.

**WARNING**

New or exhaust engine oil can be dangerous. Engine oil is highly toxic for people and domestic animals. Avoid ingestion and contact. It has been proved that prolonged contact with engine oil can cause skin cancer on guinea pigs. Even a brief contact with engine oil can cause skin irritation.

- In the event of an engine oil ingestion, immediately call a doctor and do not cause vomiting, in order to avoid inhalation of engine oil in lungs.

- Keep new or exhaust engine oil out of reach of children and domestic animals.
- While topping up the engine oil, wear a long-sleeved shirt and a pair of waterproof gloves to protect your skin.
- If the engine oil comes in touch with your skin, wash it away with soap and water.
- Correctly recycle or dispose of the exhaust engine oil, in order to avoid environmental pollution.



1.6. Checking the coolant level

Check the coolant level while the engine is off and cold.

The check must be performed after placing the motorcycle in an upright position on a horizontal surface.

Ensure that the coolant level is between the MIN mark and the lower side of the frame tube as shown in the figure.

If the coolant level is below the MIN mark, top up the coolant as described at paragraph 1.6.1.



WARNING

Do not start the engine if the coolant level is below the MIN mark.

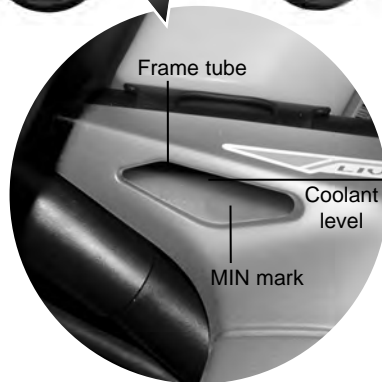



GB 1

1.6.1. Topping up the coolant level

To gain access to the coolant filler cap, extract the cover after removing its fixing screws. Remove the coolant filler cap and top up with the recommended coolant (see § 1.4).

Coolant filler cap

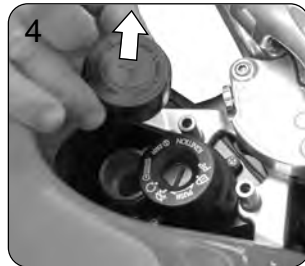
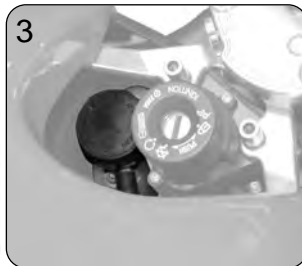
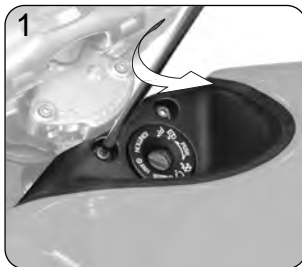

After topping up, carefully replace the previously removed parts.



WARNING: Perform the topping up of the coolant when the engine is off and cold. Never attempt to remove the coolant filler cap when the engine is hot, in order to avoid the risk of burns. The cooling system is under pressure!



CAUTION: To top up the coolant level and/or renew the coolant, use only the product specified in the table in section 6.3. Do not mix nor dilute the coolant with additives or different fluids. If the coolant specified in section 6.3. is not available, use a coolant having technical characteristics consistent with the prescribed product.



CAUTION: Coolant can damage painted and plastic parts. When you top up the coolant level, be careful not to spill coolant on any part of the motorcycle. If you do spill coolant on your motorcycle, immediately wipe it away using a clean cloth.

**WARNING**

Under certain conditions, ethylene glycol contained in the coolant can become flammable. When it is lighted, it produces an invisible flame.

Avoid spilling coolant on hot parts of the motorcycle, because the subsequent combustion of ethylene glycol could cause serious burns.

**WARNING**

Coolant is a highly toxic fluid. Avoid ingestion and contact with your skin or eyes. Keep coolant out of reach of children and domestic animals. In the event of a coolant ingestion, immediately call a doctor and do not cause vomiting, in order to avoid inhalation of coolant in lungs. If the coolant comes in touch with your skin or eyes, immediately wash it away with water.



GB 1

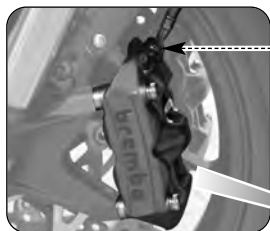

Front brake caliper

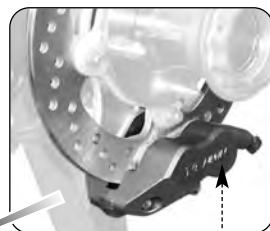

Rear brake caliper

Disc

Pads

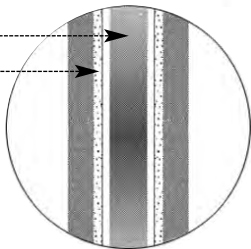

Wear limit 1 mm



1.7. Checking the wear of the brake pads

Periodically check the width of the friction material layer of the pads, making sure it never falls below the wear limit (1 mm).



WARNING

If the brake pads are excessively worn out, the effectiveness of the braking system decreases, increasing the risk of accidents. If the pads have worn to near the wear limit, have both pads replaced by an authorized service centre. Ensure that the new pads are suitably broken in.



Rear brake fluid reservoir



Front brake fluid reservoir

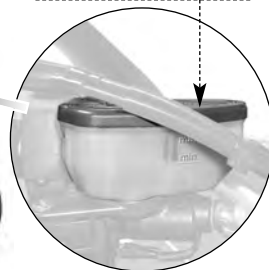

1 CB

1.8. Checking the brake fluid level



WARNING

Lack of maintenance of the braking system can increase the risk of accidents. Before riding, always check the braking system according to the instructions provided in the Quick Manual.

The level of the brake fluid decreases as the brake pads wear down. Ensure that the fluid level is always between the MAX and MIN marks. If the level falls below the MIN mark, contact an authorized service centre and have the brake system overhauled.

**WARNING**

Never use your motorcycle if the fluid level is below the MIN mark. The brakes may fail to properly operate, which could lead to an accident. If the brake fluid level is below the MIN mark, you must have the braking system overhauled by an authorized MV Agusta dealer.

**WARNING**

Have the topping up of the brake fluid performed only by skilled personnel. Brake fluid is highly toxic. Avoid contact and ingestion. Keep brake fluid out of reach of children and domestic animals. In the event of a brake fluid ingestion, immediately call a doctor and do not cause vomiting, in order to avoid inhalation of brake fluid in lungs. If the brake fluid comes in touch with your skin or eyes, immediately wash with water.

**WARNING**

Use only the brake fluid specified at paragraph 1.4. of this manual. Mixing different brake fluids can cause a dangerous chemical reaction, as well as the decrease of the braking efficiency, with subsequent increase of the risk of accidents.

**WARNING**

An insufficient amount of brake fluid may allow the introduction of air in the braking system. This could compromise the effectiveness of the braking system, with subsequent increase of the risk of accidents. Presence of air in the braking system can be identified in the moment you feel a characteristic “spongy effect” while pushing the brake lever. In this case, have a braking system bleeding performed by an authorized MV Agusta dealer before riding your motorcycle again.



1.9. Checking the clutch fluid level

The fluid level must be between the MAX and MIN marks.

If the level falls below the MIN mark, contact an authorized service centre and have the clutch control system repaired.



WARNING

Never use your motorcycle if the fluid level is below the MIN mark. The clutch may fail to properly operate, which could lead to an accident. If the clutch fluid level is below the MIN mark, have the clutch system overhauled by an authorized MV Agusta dealer.



WARNING

Use only the clutch fluid specified in the paragraph 1.4. of this manual.





1.10. Checking and replacing the tyres



WARNING

Before using the motorcycle, always check the pressure and wear of the tyres.

Checking the inflating pressure of the tyres is an essential requirement to ensure driving safety. Insufficiently inflated tyres can reduce the handling of the motorcycle and wear themselves out very quickly. On the other hand, an excessively high inflating pressure reduces the wideness of the surface in contact with the ground, and it can compromise the grip of the vehicle.

Before riding your motorcycle, it is therefore necessary to measure the tyre pressure at room temperature. The vehicle must be parked since three hours at least.



WARNING

An incorrect inflating pressure can lead to dangerous situations during riding. An insufficiently inflated tyre can cause the sliding of the tyre on the wheel rim or its detachment; this may lead to the deflation of the tyre with subsequent loss of control of the vehicle.



In fact, by checking the pressure soon afterwards using the motorcycle, you would obtain a higher value than the actual one. This could cause an incorrect adjustment of the tyre pressure.

Refer to the pressures given in § 2.2. and/or on the label applied to the steering head tube. In the event of long travels, you can increase the face value of the tyre pressure of 0.2 bar.

Moreover, it is extremely important to check the wear of the tyres before riding. In fact, a worn out tyre can be punctured more easily than a new one, and it can adversely affect handling and stability of the motorcycle.

Check that the depth of the tyre tread is not below the values prescribed by the Highway Code.

Verify the absence of crevices at the bottom of the tread design and fissures on the tyre sidewall. Moreover, verify the absence of nails and glass splinters in the tyre. If these conditions are not verified, have the tyre replaced by an authorized MV Agusta dealer.

**WARNING**

The limits of the tyre tread depth may vary from country to country. Always refer to the values prescribed by the law provisions of the nation in which you use your motorcycle.

**WARNING**

• If the tyres of your motorcycle are excessively worn out, have it replaced by your MV Agusta dealer. Besides being illegal, riding a motorcycle with excessively worn out tyres can reduce its stability and lead to the loss of control of the vehicle.

• If a tyre is punctured it must be replaced, not repaired. A repaired tyre provides a restricted performance and lower safety levels than a new one.



If you make a provisional or emergency repair to a tyre, you must ride at very low speed until you reach the nearest MV Agusta dealer and have the tyre replaced. With a provisionally repaired tyre, never exceed 60 km/h. Tyre repairing must never be performed if the tyre is punctured on its sidewall, or if the diameter of the puncture on the tread is greater than 6 mm.

- MV Agusta recommends not to use sealing fluids to repair a punctured tyre. These products can adversely affect the material of the tyre layers, as well as hide the minor damages caused by objects penetrated in the tyre.

- When it is necessary to replace the tyres, use only the type specified in paragraph 2.2. Moreover, avoid using tyres of a different brand or type on the front and on the rear wheel at the same time. Using tyres different from those specified can adversely affect the handling and stability of the motorcycle, increasing the risk of accidents.
- The wheel rims of your motorcycle have been designed for use with tubeless tyres only. Do not assemble an air tube tyre on rims designed for tubeless tyres. Otherwise, the tyre bead could not properly settle down on the wheel rim, leading to the deflation of the tyre and the loss of control of the vehicle.



- Do not assemble an air tube on a tubeless tyre. The overheating of the tyre could cause the explosion of the air tube, leading to the deflation of the tyre and the loss of control of the vehicle.
- Have the tyres replaced according to their direction of spin, which is highlighted by a small arrow on the tyre sidewall.

- New tyres should be run in for a short period before demanding their full performance. In fact, during this period the tyres could have a reduced grip on some kind of roads. We suggest to ride at reduced speed and exercise extreme caution during the first 100 km after the replacement of a tyre.

**□ Rear wheel disassembling****CAUTION**

If you have the rear wheel tyre replaced by a tyre-dealer, make sure that the following tools are used in the rear wheel disassembling and reassembling:

- 55 mm polygonal socket wrench
- Torque wrench

If the above mentioned operations are performed with tools other than those indicated, the rear wheel parts can be seriously damaged. Therefore, we strongly recommend not to have the tyres replaced by an improperly equipped workshop. Always have the tyres replaced by an authorized MV Agusta dealer.

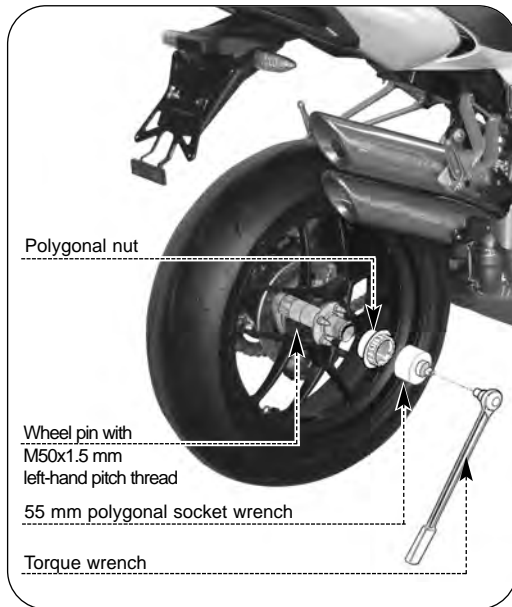



□ Checking the wheel rims

Before riding, always verify the absence of cracks, bending or buckling on the wheel rims.



WARNING

If you find that the wheel rim is damaged, have it replaced by an authorized MV Agusta dealer. Never attempt to repair the wheel rim, even in case of slight damage.

Every time you replace a tyre or a rim, you must have a wheel balancing performed by an authorized MV Agusta dealer. Wheel unbalance can adversely affect performance and handling of the motorcycle, as well as shorten the life of the tyres.



WARNING

When you have a wheel balancing performed, make sure to assemble only approved counterweights on the wheel rim. MV Agusta recommends not to use balancing or balancing/sealing fluids.



WARNING

Do not attempt to have a tubeless tyre removed without using the proper tools and protections for the wheel rim. Otherwise, you could damage the sealing surface of the rim, leading to the deflation of the tyre and the loss of control of the vehicle.



1.11. Checking and lubricating the drive chain

To perform these operations, you must put the motorcycle on the rear stand, upright on a horizontal surface and with the gear in neutral.

□ Checking the chain adjustment



WARNING: Before checking the chain adjustment, contact a MV Agusta authorized centre to verify that the value of the static setup of the rear suspension is correct. Also make sure that the chain is properly lubricated.

The axis of the chain lower portion must be **50 mm** from the lower chain guard. Manually turn the rear wheel and carry out the check at several points along the chain. The distance between the chain and the lower chain guard must remain almost constant as the wheel turns. If, on the other hand, the play on the chain varies considerably, it means that some chain links are flattened, seized or elongated. If the distance is greater than 50 mm, have the chain adjusted by your local MV Agusta dealer.

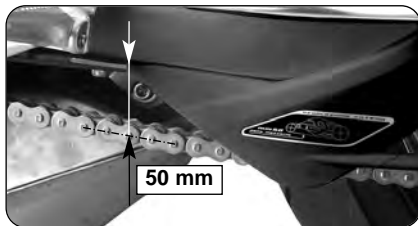

NOTE:

On request, it is possible to order to the MV Agusta Spare Parts Service a special elongated upper chain cover. The assembly of this component on your motorcycle gives a better protection than a standard component.



**WARNING**

Riding your motorcycle when the drive chain is in poor condition or improperly adjusted can lead to accidents. Before riding, always check the chain adjustment according to the procedures shown in this paragraph. If necessary, have the chain adjusted by your MV Agusta dealer.

**WARNING**

If any chain link is flattened, seized or elongated, have the chain replaced by a MV Agusta authorized service centre.

**WARNING**

If you notice damage or excessive wear of the chain and the related sprockets, have them replaced by an authorized MV Agusta dealer. Every time the chain is replaced, you must always replace the front and rear sprockets too.

**WARNING**

Using a chain with a fake link can be dangerous. An uncompletely riveted or fake link can accidentally split open and cause accidents, as well as damage to the engine. Never use a chain with a fake link.

**WARNING**

Every time it is requested to operate the rear wheel hub screws, contact an authorized MV Agusta dealer. In order to tighten the screws, apply a tightening torque equal to the value shown in the label placed on the swingarm. Applying a torque higher than the indicated value can cause the fast decay of the rear wheel hub, compromising the reliability of the vehicle and the safety of the pilot and the passenger.



□ Lubrication

To ensure proper operation, the drive chain needs to be properly lubricated.

▶ Preliminary cleaning - Before lubrication, the dirt accumulated on the chain must be dissolved using kerosene. The dirt must then be removed with a clean rag and/or an air jet.



CAUTION

The chain is of the O-ring type. To prevent it from damaging, never clean the chain with a steam or high pressure water jet, nor using gasoline or other solvents. The chain must be cleaned using kerosene only.



WARNING

Kerosene is highly toxic and flammable. Avoid contact and inhalation. Keep kerosene away from sparks and flames. Keep kerosene out of reach of children and domestic animals. Correctly dispose of exhaust kerosene, in order to avoid environmental pollution.



► **Lubrication** - Apply a slight and uniform film of lubricant over the whole length of the drive chain, taking care not to smear the surrounding parts, and in particular the tyres. Direct the lubricant jet on the internal links, in order to lubricate the surface of the O-Rings and penetrate inside the chain roller.



CAUTION

Only use the lubricant specified in the paragraph 1.4. of this manual, in order to protect the drive chain and avoid oil spurts when the vehicle is in motion.



WARNING

Chain lubrication must be performed according to the intervals specified in the tables of scheduled maintenance (see § 1.2.). It is also necessary to perform this operation after riding under the rain and after cleaning the motorcycle. Riding your motorcycle when the drive chain is in poor condition or improperly adjusted can lead to accidents.



1 CB

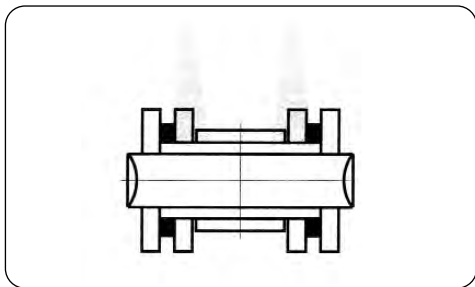

GB
1

1.12. Checking the idle speed

Check the idle speed when the engine has reached the operating temperature. Ensure that the choke control has not been activated.

The idle speed should range from 1,150 to 1,250 rpm.





If a tune-up is necessary, contact an authorized service centre.





1.13. Replacing parts - General information

The replacement of the fuses and the light bulbs can be carried out by the owner according to the indications provided below.

	Battery recharge fuse - Replacement (§1.13.1.)
	Fuses - Replacement (§1.13.1.)
	Low beam bulb - Replacement (§1.13.2.)
	High beam bulb - Replacement (§1.13.3.)
	License plate light bulb - Replacement (§1.13.4.)

1.13.1. Replacing the fuses

► The recharge fuse is located under the driver's saddle, in the position shown in the figure.

1 CB

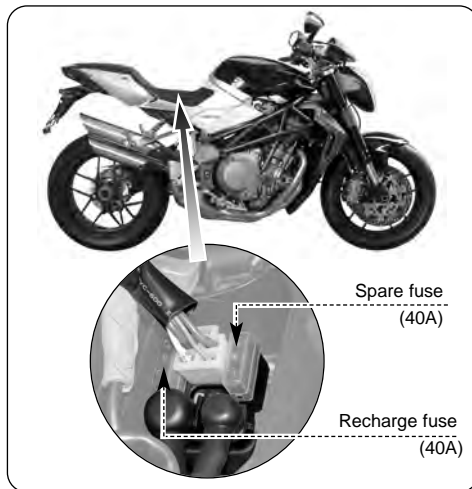



GB
1

- ▶ The fuse box is under the passenger saddle. To take it out, remove the driver's saddle, then unfasten the passenger saddle and take it out.



- ▶ Unfasten and lift the lid of the fuse box.





► To identify the position and function of the fuses, refer to the information shown on the adhesive label and in the enclosed electrical diagram. The reference letters in the figure correspond to those shown in the diagram.

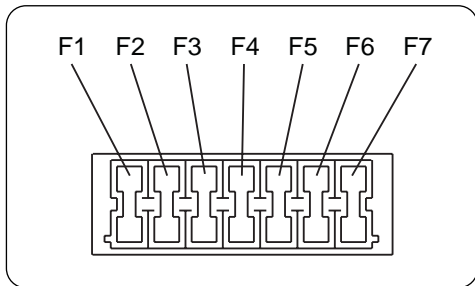

1 CB

► Replace the blown fuse and refit the cover. Remember that the tool bag contains three spare fuses.

**WARNING**

Never replace a fuse with a rating other than that prescribed, in order to avoid damage to the electrical equipment of the motorcycle which could lead to a fire.





1.13.2. Replacing the low beam bulb

► Remove the headlight lateral fixing screws. Pay attention in slipping off the adjuster from its seat when the headlight is being removed from its support.

- Before removing the headlight from its support, detach the connector on the rear side of the headlight.
- Lay down the headlight on a table, in order to perform the following operations.





- ▶ Remove the headlight rear screw.
- ▶ Remove the front part of the headlight from its supporting shell.

**1** CB

- ▶ Remove the protective headlight cover.



GB
1

- ▶ Detach the low beam bulb connector.
- ▶ Release the retaining spring.
- ▶ Extract the burnt-out low beam bulb.



CAUTION: Do not touch the bulb glass with bare hands. If you do, clean the bulb with an oil-free solvent.

- ▶ Insert the new bulb.
- ▶ Reattach the retaining spring.
- ▶ Reattach the low beam bulb connector.
- ▶ Reposition the protective headlight cover.
- ▶ Replace the front part of the headlight on its supporting shell.
- ▶ Fasten the headlight rear screw.
- ▶ Reattach the headlight connector.
- ▶ Replace the headlight on its support and insert the two lateral fixing screws, making sure to insert the headlamp adjuster in its proper seat on the headlight.





1.13.3. Replacing the high beam bulb

- ▶ Remove the headlight from its support as described in paragraph 1.13.2.
- ▶ To take the headlight lamp out, press the connector on the side and pull it outwards.
- ▶ Detach the connector from the burnt-out bulb.



CAUTION: Do not touch the bulb glass with bare hands. If you do, clean the bulb with an oil-free solvent.

- ▶ Insert the connector in the new bulb.
- ▶ Fit the lamp back in and slightly press it into its housing to secure it.
- ▶ Replace the headlight on its support, following the instructions described in paragraph 1.13.2.





1.13.4. Replacing the license plate light bulb

- ▶ Remove the cable rail fixing screws.
- ▶ Pull down the cable rail and detach it from the upper surface, operating as described in the picture.



- ▶ Pull out the license plate light bulb holder.
- ▶ Extract the burnt-out bulb.
- ▶ Fit the new bulb.
- ▶ Replace the bulb holder.
- ▶ Push back the cable rail in touch with the upper surface.
- ▶ Replace the cable rail fixing screws.





1.14. Battery

The battery is of the maintenance-free type and is installed under the tail section. This battery does not require checking of the fluid level or adding of distilled water.

If the battery seems to be run-down (causing electrical problems or a difficult starting), have it recharged by an authorized MV Agusta dealer as soon as possible. Remember that the battery runs down more quickly if your motorcycle is equipped with additive electrical accessories.



WARNING

If the battery casing is damaged, there may be a leakage of sulphuric acid, a HIGHLY TOXIC AND CORROSIVE substance. Avoid any contact with your eyes, skin and clothes. Always wear protective glasses when you have to work near the battery.

In the event of a contact with sulphuric acid, give the FIRST AID as described below:

- **CONTACT WITH EYES:** Wash away with water for about 15 minutes, and immediately call a doctor.
- **CONTACT WITH SKIN:** Wash away with a great amount of water.
- **INGESTION:** Drink great amounts of water or milk, and immediately call a doctor.

Furthermore, leakage of sulphuric acid can result in the formation of hydrogen gas which, if ignited by a spark or a flame, would cause an explosion.

Always have the battery replaced by your local MV Agusta dealer.

GB
1

Prolonged inactivity

If the motorcycle is to remain unused for a long time (a month or longer), it is advisable to disconnect the battery cables or have the battery removed by skilled personnel. In case of prolonged inactivity, to avoid shortening the life of the battery, it is essential to have it recharged by your MV Agusta dealer every 4-5 months.



WARNING: The inversion of the battery wires can damage the battery and the recharging system. The red wires must be connected to the positive terminal (+), while the black wires must be connected to the negative terminal (-).
When removing the battery, disconnect the negative terminal FIRST and then the positive terminal. When reinstalling the battery, use the reverse procedure.





1.15. Cleaning the motorcycle

Periodic careful cleaning is a key factor in preserving the value of the motorcycle, protecting its surface finish and checking for damages, wear and leakage of corrosive fluids.



CAUTION

Before washing the vehicle, stop up the exhaust pipes and protect the electrical parts.



WARNING

Do not wash your motorcycle soon afterwards riding. Attend a few minutes to allow the engine and the exhaust pipes to thoroughly cool.



CAUTION: Never use washing systems involving steam or high pressure water jets. These systems could cause water infiltration and damage the internal parts of your motorcycle.



INFORMATION: Spilling detergent can cause environmental pollution. Therefore, you should clean your motorcycle in an area equipped for collection and disposal of washing fluids.



GB 1 Wash the motorcycle with water, a mild detergent and a sponge. Wipe the vehicle with a soft cloth. Use an air jet to dry difficult-to-reach areas.

**CAUTION**

- **Avoid using clothes or sponges that have been in contact with strong or abrasive detergents, solvents, alcohol or gasoline.**
- **To avoid irreparable damage to the bodywork parts, never use alkaline or strongly acid detergents, petrol, brake fluid or other solvents.**
- **If you have doubts about the chemical composition of the detergent, test its effect by applying it on a little area of the bodywork before using it on the whole bike.**

Periodically treat the paintwork with high quality wax. After riding on roads treated with corrosive substances (salt), wash the vehicle as soon as possible with cold water. Do not use hot water as it enhances the corrosive action.

**WARNING**

Avoid smearing brakes or tyres with oil or wax. If necessary, clean the brake discs with a brake disc detergent or with acetone, and wash the tyres with warm water and a neutral detergent.

**WARNING**

The presence of water on the brakes can lead to a decrease of the braking effectiveness with subsequent risk of accidents. After completing the washing, run the engine for a few minutes and start off at reduced speed. Carefully apply the brakes a few times so as to dry the brake pads and discs.

**WARNING**

The drive chain must be correctly lubricated after washing the motorcycle, following the instructions provided at § 1.11. of this manual.

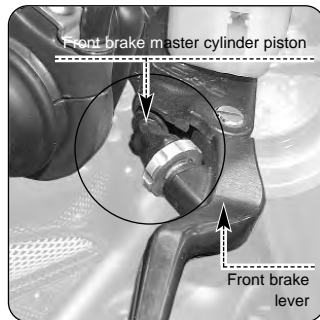
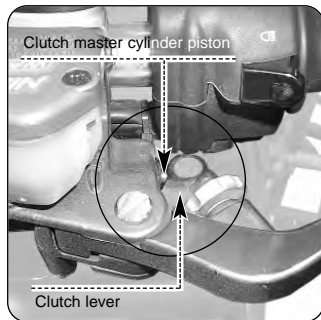
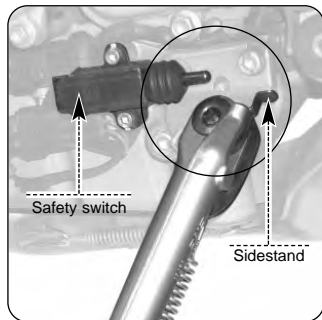

CAUTION

Make sure to always keep clean the contact areas between the following components, as shown in the above figures:







- Side stand and safety switch
- Clutch lever and clutch master cylinder piston
- Front brake lever and front brake master cylinder piston

Clean these areas every 500 ÷ 1000 km, as prescribed in the Scheduled Maintenance Table. In any case, we suggest to verify the cleanliness of the above areas every time you use the vehicle, in order to maintain the related parts in good working order.



1.16. Prolonged inactivity

If the motorcycle is to remain unused for a long time, it is advisable to carry out the following operations:

-  Empty the fuel tank.
-  Remove the battery and store it in a suitable place.
-  Remove the spark plug caps and the spark plugs. Pour a teaspoonful of engine oil in every spark plug hole, then place back the spark plugs and the corresponding caps. Make the engine run idle for a few times.
-  Lubricate all control cables and the joints of all pedals and levers.
-  Clean the motorcycle and treat the paintwork with high quality wax (§1.15.).
-  In order to ensure integrity and performance of the tyres, park your motorcycle in a fresh, dry and dark place, with a temperature relatively constant and lower than 25° C. Avoid direct contact of the tyres with heating pipes or radiators, and prolonged contact with oil or gasoline. Avoid parking with the tyres near to electrical motors or devices capable to produce sparks or electric discharge. During the period of inactivity, place your motorcycle on the rear stand.
-  Cover the vehicle with an adequate canvas cover.

When the motorcycle is first put back into service, remember to carry out a comprehensive check and, if necessary, to have the vehicle serviced (§1.2.).

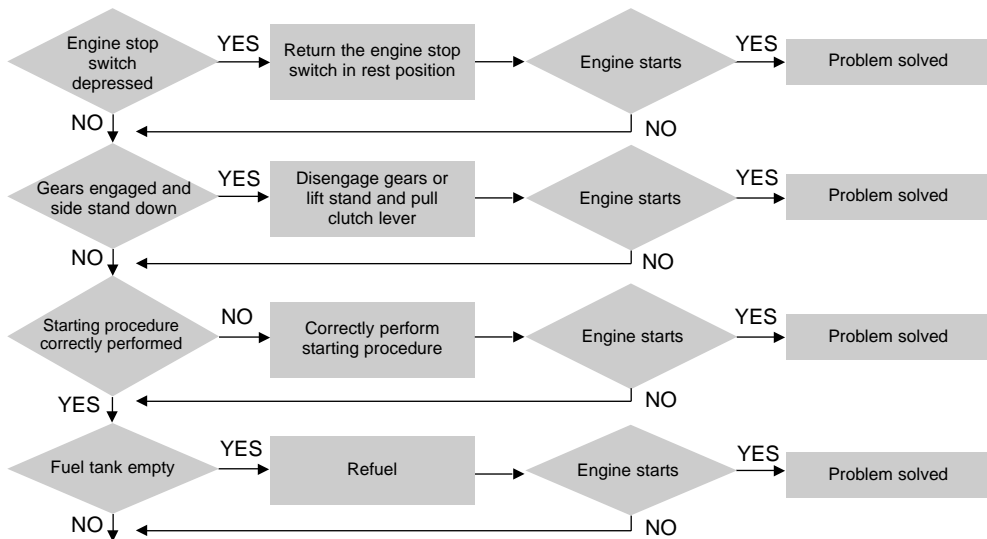
2.1. Engine problems: **ENGINE DOES NOT START**

continued on next page



continued from previous page

GB 2

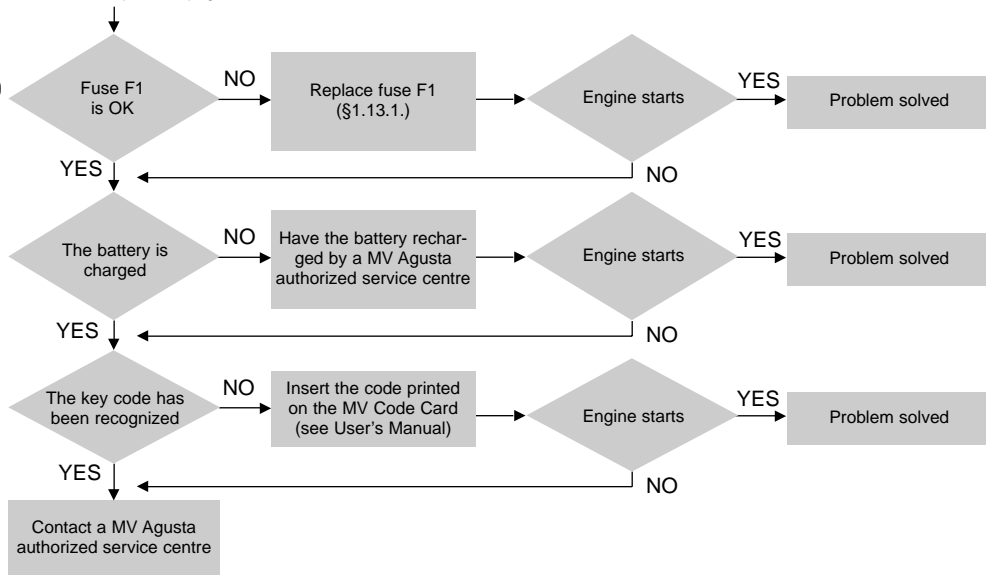



ENGINE SHUTS OFF DURING RIDING

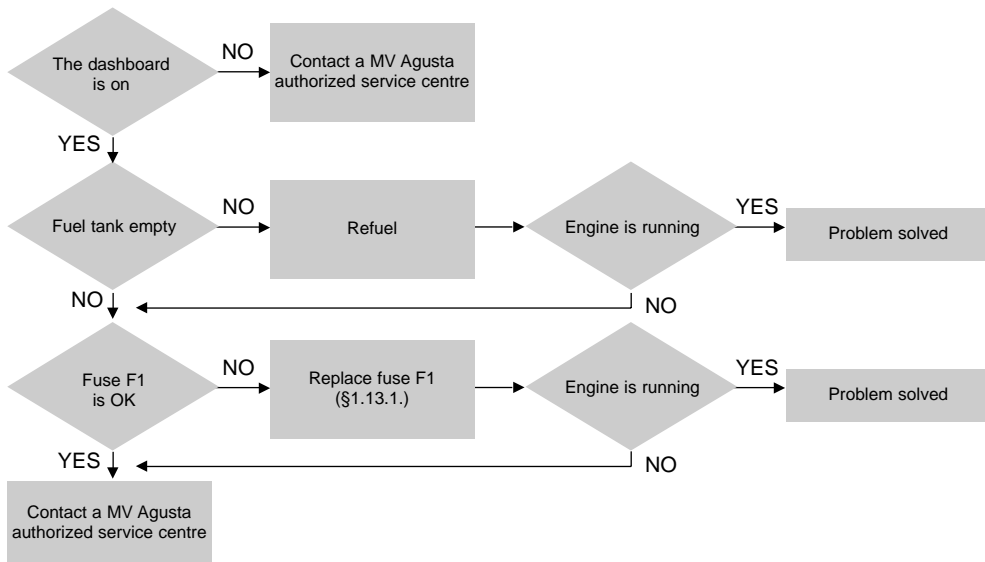



ENGINE OVERHEATS

GB 2

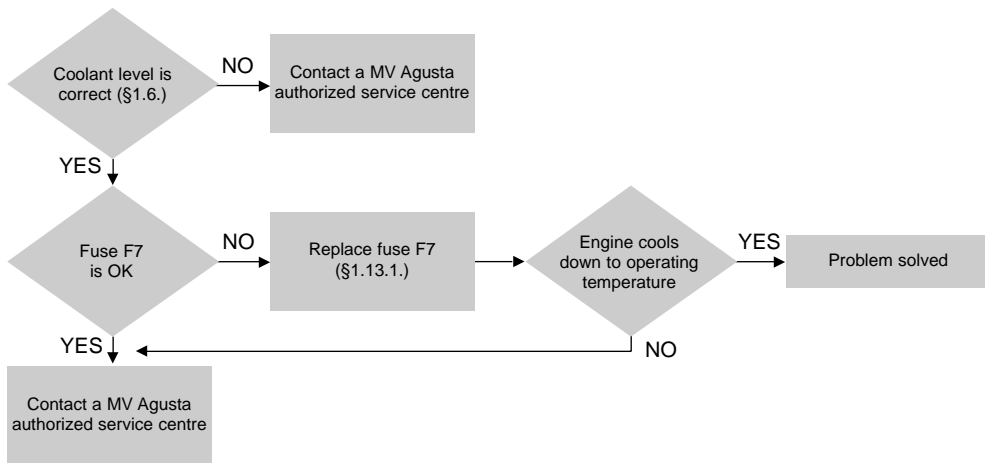



OIL PRESSURE IS TOO LOW (Engine oil pressure warning light is on with the engine running)

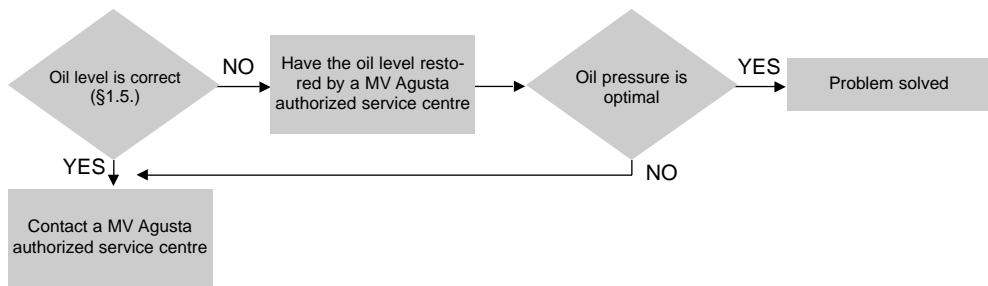



2.2. Electrical equipment problems: **LIGHTS DO NOT WORK**

GB 2

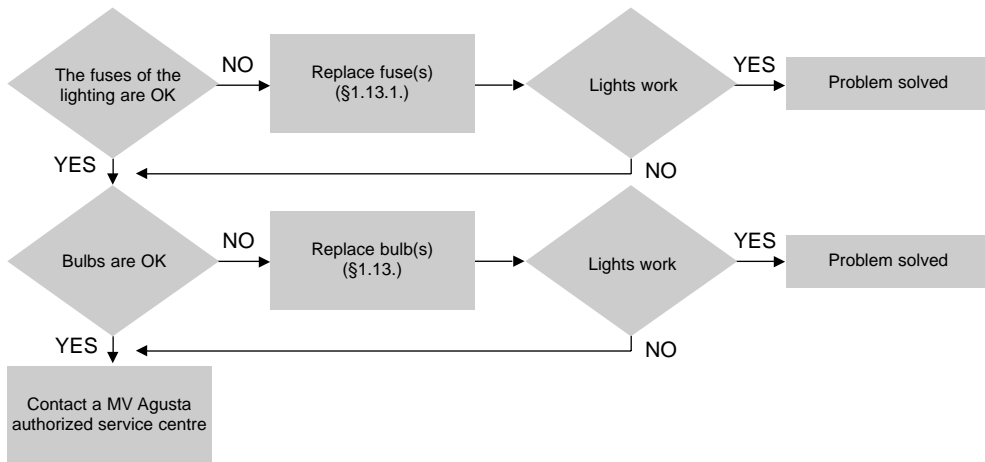



HORN DOES NOT WORK

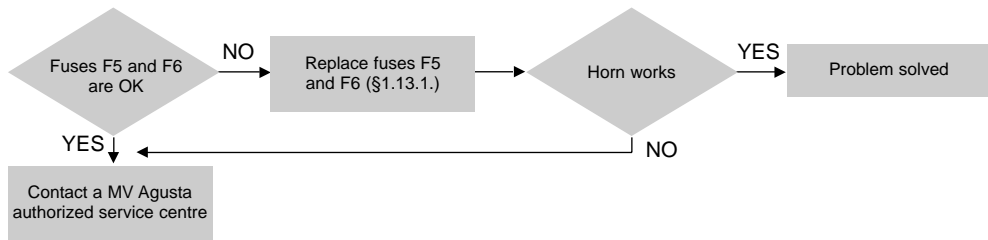

2 GB

SPEEDOMETER DOES NOT WORK

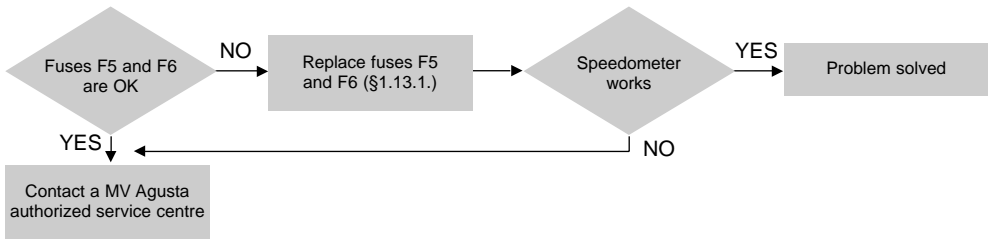



DASHBOARD WARNING LIGHTS DO NOT WORK

GB 2

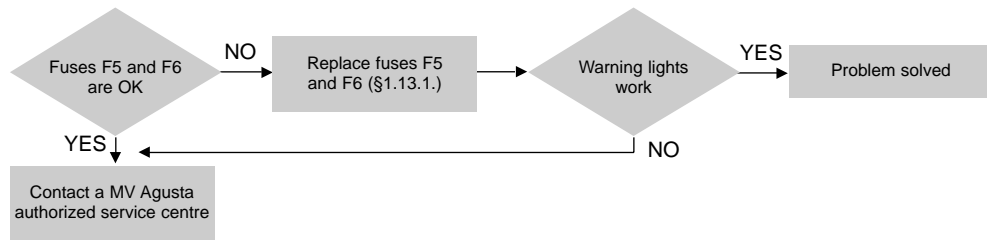

ALTERNATOR DOES NOT CHARGE BATTERY (Battery charge indicator is on with the engine running)

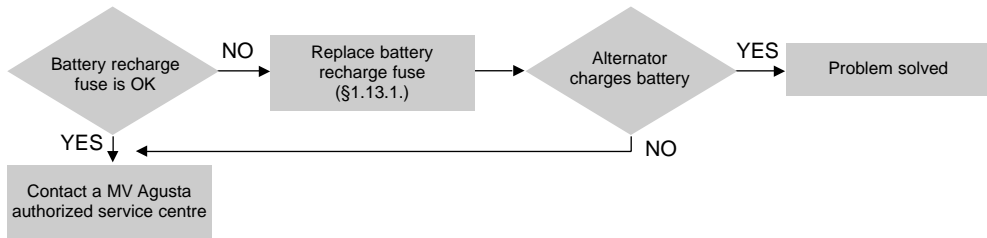



3.1. Motorcycle overview

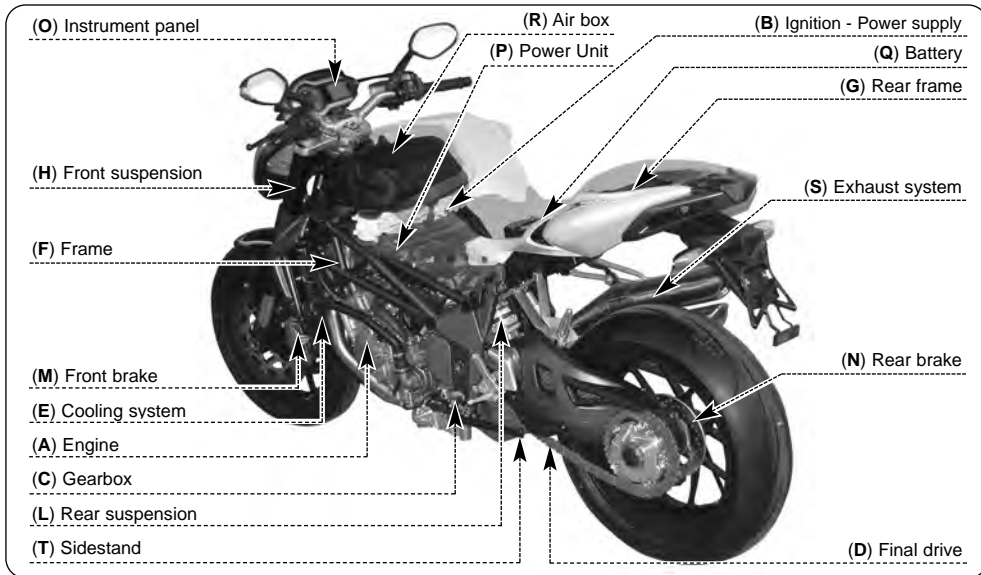



- A - Engine:** four-stroke, inline four-cylinder. Double-overhead camshaft valve train with radial valves. Wet sump lubrication.
- B - Ignition - Power supply:** integrated ignition-injection system. Inductive-discharge electronic ignition. "Multipoint" electronic injection.
- C - Gearbox:** removable, six-speed, with constant-mesh gears.
- D - Final drive:** consisting of drive sprocket, rear sprocket and chain.
- E - Cooling system:** with separate liquid and oil radiators.
- F - Frame:** tubular steel trellis with aluminium side plates.
- G - Rear frame:** tubular steel trellis.
- H - Front suspension:** upside-down hydraulic fork with external adjusting system.
- L - Rear suspension:** progressive, with single-sided swingarm and single shock absorber with external adjusting system.
- M - Front brake:** dual semi-floating disc with radial four-piston calipers.
- N - Rear brake:** single disc with four-piston caliper.
- O - Instrument panel:** with warning lights and analogue and digital instruments.
- P - Power unit:** with electronic control of the integrated ignition-injection system.
- Q - Battery:** sealed and maintenance-free.
- R - Air box:** equipped with filtering system of the engine intake air flow.
- S - Exhaust system:** equipped with catalytic converter for exhaust emission reduction.
- T - Sidestand:** equipped with safety switch and dual return spring.



3.1.1 Front brake circuit

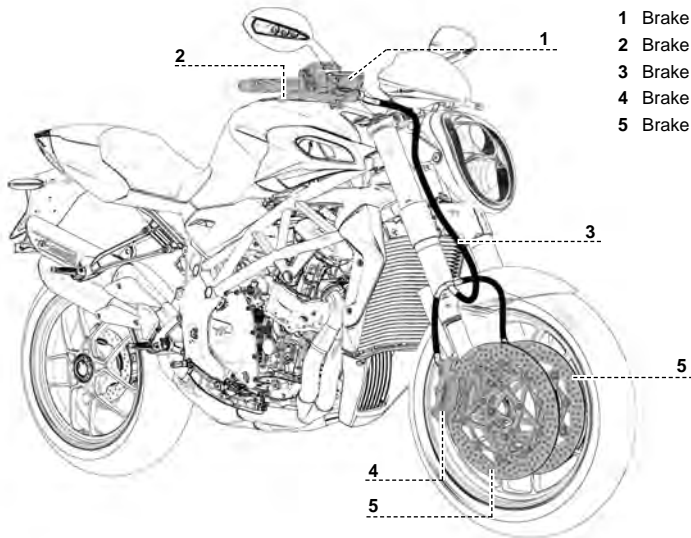

- 1 Brake master cylinder
- 2 Brake lever
- 3 Brake line
- 4 Brake caliper
- 5 Brake discs



3.1.2. Rear brake circuit

GB
3

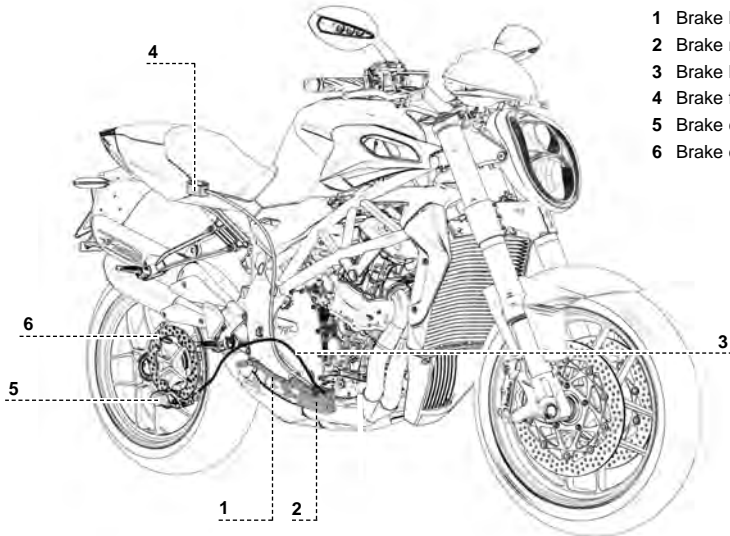

- 1 Brake lever
- 2 Brake master cylinder
- 3 Brake line
- 4 Brake fluid reservoir
- 5 Brake caliper
- 6 Brake disc



3.1.3. Clutch circuit

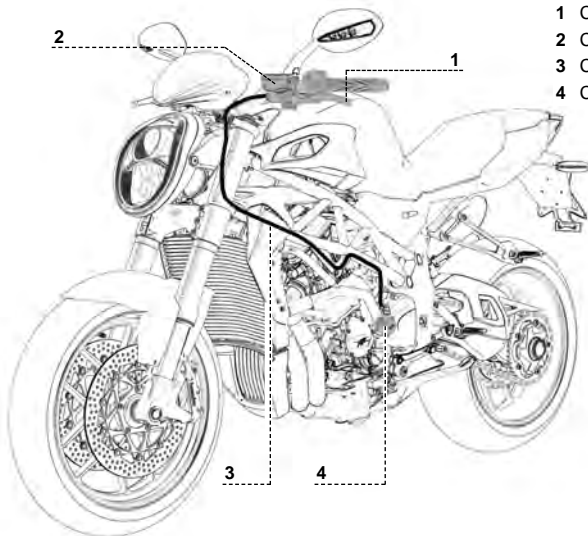

- 1 Clutch lever
- 2 Clutch master cylinder
- 3 Clutch line
- 4 Clutch cylinder assembly



3.1.4. Engine lubrication

GB
3

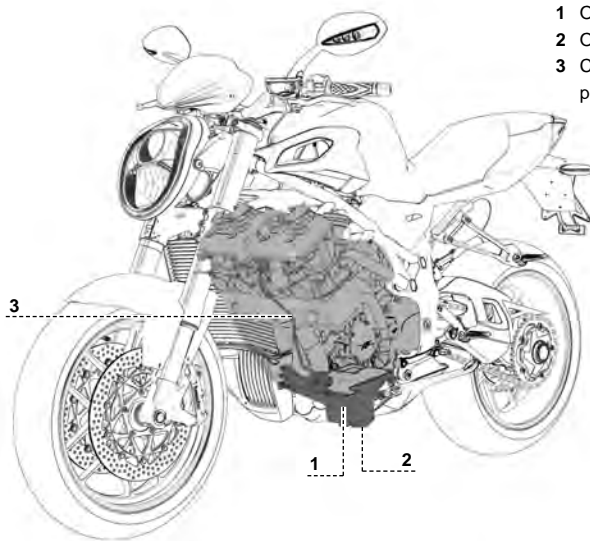

- 1 Oil sump
- 2 Oil filter
- 3 Cylinder head oil feed pipe



3.1.5. Coolant circuit

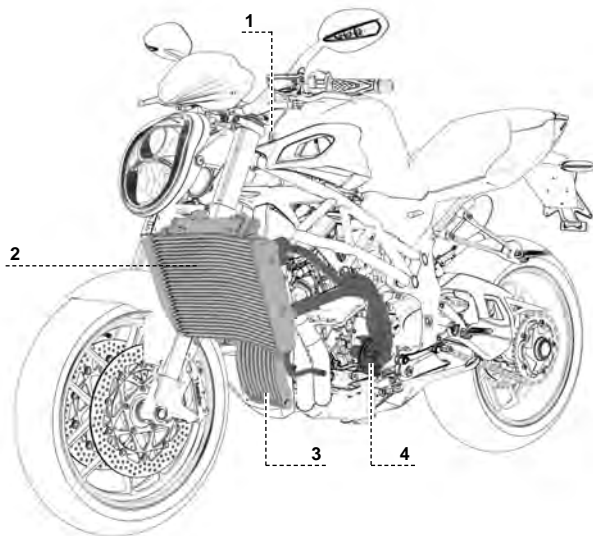

- 1 Expansion tank
- 2 Upper radiator
- 3 Lower radiator
- 4 Coolant pump



3.1.6. Fuel system

GB
3

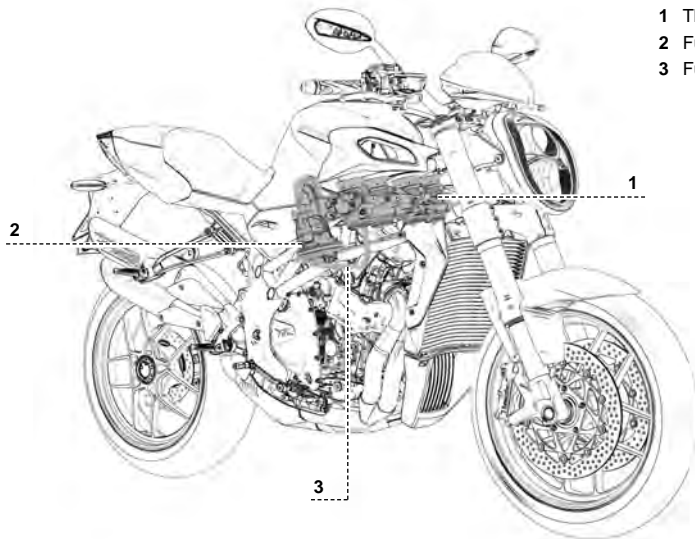

- 1 Throttle bodies
- 2 Fuel pump
- 3 Fuel line

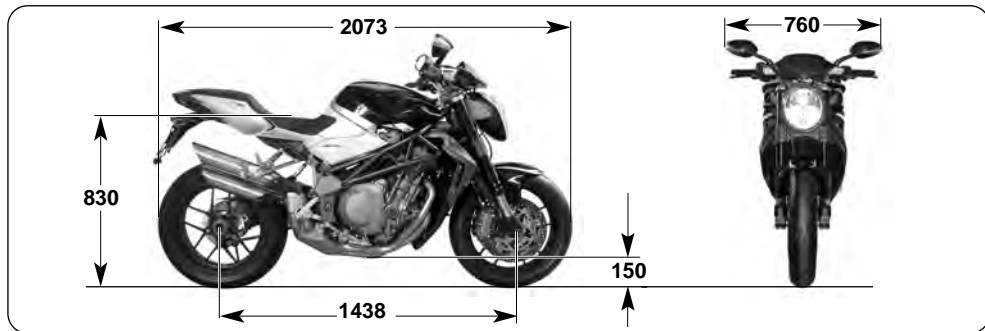

3 GB

3.2. Specifications

Description	BRUTALE 1090 RR
SPECIFICATIONS	
Wheelbase (mm) (*)	1438
Overall length (mm) (*)	2073
Max. width (mm)	760
Seat height (mm) (*)	830
Min. ground clearance (mm) (*)	150
Trail (mm) (*)	103,5

* : The indicated values must not be intended as binding informations. They can change according to the vehicle setup.

**Specifications**

Description	BRUTALE 1090 RR
Dry weight (Kg)	190
Fuel tank capacity (lt) (*)	19
Reserve fuel (lt) (*)	4
Oil in crankcase (Kg)	3,5
ENGINE	
Type	Four-cylinder, four-stroke, 16 valves
Bore (mm)	79,0
Stroke (mm)	55,0
Total displacement (cm ³)	1078
Compression ratio	13:1
Starting	Electric starter
Cooling system	Cooling with separate liquid and oil radiators
Crankcase and covers	Die-cast
Head and cylinders	Chill-cast
Valves	Bimetal / single-metal
VALVE TRAIN	
Type	Double-overhead camshaft, radial valves

* : The indicated data must not be intended as binding informations. They can change according to the environmental temperature, the engine temperature and the evaporation point of the gasoline.



Specifications

Description	BRUTALE 1090 RR
LUBRICATION	
Type	Wet sump
IGNITION - POWER SUPPLY	
Type	Magneti Marelli 5.SM starter-injection system with Mikuni throttle body. Induction-discharge electronic starter. "Multipoint" phased sequential electronic injection.
Spark plugs	NGK CR9 EB
Spark gap (mm)	0.7 ÷ 0.8
CLUTCH	
Type	Multiple-disc in oil bath
PRIMARY DRIVE	
Number of teeth on crankshaft gear	Z = 50
Number of teeth on clutch gear	Z = 79
Transmission ratio	1.58
SECONDARY DRIVE	
Number of teeth on front sprocket	Z = 15
Number of teeth on rear sprocket	Z = 41
Transmission ratio	2.73
TRANSMISSION	
Type	Removable, six-speed gearbox with constant-mesh gears



Specifications

Description	BRUTALE 1090 RR
Gear ratio (overall ratios)	
First gear	2.92 (12.59)
Second gear	2.12 (9.14)
Third gear	1.78 (7.68)
Fourth gear	1.50 (6.47)
Fifth gear	1.32 (5.69)
Sixth gear	1.21 (5.22)
FRAME	
Type	25 CrMo steel tubular trellis (TIG welded)
Swingarm pivot plates	Aluminium alloy
FRONT SUSPENSION	
Type	"Upside down" telescopic hydraulic fork with external and separated adjustment of rebound and compression damping and of spring preload
Rod diameter(mm)	50
Travel on leg axis (mm)	125
REAR SUSPENSION	
Type	Progressive, single shock absorber with adjustable rebound and compression (high/low speed) damping and spring preload
Swingarm	Aluminium alloy
Wheel travel (mm)	120



Specifications

Description	BRUTALE 1090 RR
FRONT BRAKE	
Type	Dual floating disc with steel braking band
Disc diameter (mm)	320
Disc flange	Steel
Calipers, piston diameters (mm)	Radial monobloc with 4 pistons (Ø 34)
REAR BRAKE	
Type	Single steel disc
Disc diameter (mm)	210
Caliper, piston diameter (mm)	4-piston (Ø 25.4)
FRONT RIM	
Material	Aluminium alloy
Dimensions	3.50" x 17"
REAR RIM	
Material	Aluminium alloy
Dimensions	6.00" x 17"
TYRES	
Front	120/70-ZR 17 (58 W)
Rear	190/55-ZR 17 (75 W)
Brand and type	DUNLOP - Sport Max Qualifier RR PIRELLI - Dragon Supercorsa Pro

**Specifications**

Description	BRUTALE 1090 RR
Inflating pressure (*):	
Front	2.3 bar (33 psi)
Rear	2.3 bar (33 psi)
ELECTRICAL EQUIPMENT	
Equipment voltage	12 V
Low beam	12 V - 55 W
High beam	12 V - 55 W
Front parking light	12 V - 5 W
Battery	12 V - 8 Ah
Alternator	350 W at 5000 rpm.
BODYWORK	
Fuel tank	Thermoplastic material
Air scoops	Thermoplastic material
Fuel tank side panels	Thermoplastic material
Tail piece side panels	Thermoplastic material
Tail piece	Aluminium
Dashboard cover	Thermoplastic material

* : If you use tyres of a brand different from the ones recommended, refer to the inflating pressure values marked by the manufacturer on the tyre sidewall.



Specifications

Description	BRUTALE 1090 RR
Ignition switch cover	Thermoplastic material
Front mudguard	Thermoplastic material
Chain guards	Thermoplastic material
Oil cooler guard	Thermoplastic material
License-plate holder	Thermoplastic material
Rearview mirrors	Thermoplastic material
Exhaust pipe guard	Aluminium



GB 3





3.3. Bodywork parts reference colours

Bodywork parts are painted with the following reference colours, according to the corresponding motorcycle colour combination:

1. - Rear right side panel;
2. - Rear left side panel;
3. - Right side panel tank;
4. - Left side panel tank:

Colour combinations A-D-F:

F4 AGO Silver Painting (Code Palinal 928XV025)

Colour combinations B-E:

CRC Pearly White (Code Palinal 927.PE20)

Colour combination C:

“Senna” Metal Antracite Painting (Code PPG GM WA9561)

5. - Front mudguard;
6. - Airbox side panels:

Colour combinations A-D:

F4 AGO Red Painting (Code Palinal 926R750)

Colour combinations B-C-E:

CRC Intense Black Painting (Code Palinal 929R486H)

Colour combination F:

Titanium Grey (Cod. Palinal L821)

7. - Fuel tank:

Colour combination A:

F4 AGO Red Painting (Code Palinal 926R750) +

F4 AGO Silver Painting (Code Palinal 928XV025)

Colour combinations B-E:

CRC Intense Black Painting (Code Palinal 929R486H) +

CRC Pearly White (Code Palinal 927.PE20)

Colour combination C:

CRC Intense Black Painting (Code Palinal 929R486H) +

“Senna” Metal Antracite Painting (Code PPG GM WA9561)

Colour combination F:

Titanium Grey (Code Palinal L821) +

F4 AGO Silver Painting (Code Palinal 928XV025)

8. - Radiator protection right;
9. - Radiator protection left;
10. - Instrument panel cover;

Carbon Grey Metalized

(Code Palinal L921)





3.4. Frame parts reference colours

Frame parts are painted with the following reference colours:

1. - Frame:

Colour combinations A-B-C:

B5 Matt Bronze Painting
(Code Palinal 211F297)

Colour combinations D-E:

MV Anthracite Grey Metalized
(Code Palinal 211XH893)

Colour combination F:

Frame Red
(Code Palinal 211XH987)

2. - Headlight holder:

Colour combinations A-B-C:

B5 Matt Bronze Painting (Code Palinal 211F297)

Colour combinations D-E-F:

MV Anthracite Grey Metalized
(Code Yi-Mei AC MAT Black Silver)

3. - Engine:

Matt Black Painting (Code Pulverit 3500/0085)

4. - Tail piece;

5. - Steering base:

Carbon Grey Metalized
(Code Palinal L921)

6. - Right frame side plate;

7. - Left frame side plate;

8. - Rear swingarm:

Carbon Grey Metalized
(Code Akzo Nobel RPU MIC 09 BP 1663/5)

9. - Right side rear footrest support;

10. - Left side rear footrest support:

Fine Gray Metalized Aluminium Painting
(Code Palinal F444)



Information

MV Agusta S.p.A. is committed to a policy of constant improvement; therefore, you may find slight differences between the information provided in this document and the vehicle you purchased. MV Agusta motorcycles are exported in several countries, in which different rules and regulations (concerning both the Highway Code and the homologation procedures) are in force. Relying on your understanding, MV Agusta S.p.A. deems it necessary to reserve the right to change its products and the related documentation at any time and without notice.

GB 3

We suggest to often visit the Internet site **www.mvagusta.it** in order to obtain informations and updates about the MV Agusta products and the related documentation.



Respect and defend natural environment

Everything we do affects the whole planet as well as its resources.

MV Agusta, in order to protect the interests of the community, awakens the Customers and the Technical Assistance operators to use the vehicle and dispose of its replaced parts respecting the laws in force concerning environmental pollution and waste disposal and recycling.

© 2010

This document may not, in whole or in part, be reproduced without prior consent, in writing, from MV Agusta S.p.A.

Part. No. 8000B3379

Edition No. 2 - July 2010



BRUTALE

1090

MV AGUSTA



Manuel d'entretien
Version Française



TABLE DES MATIÈRES

<i>Chap.</i>	<i>Sujets abordés</i>	<i>page</i>	<i>Chap.</i>	<i>Sujets abordés</i>	<i>page</i>
1	ENTRETIEN	3	2	PANNES	51
1.1.	Symboles	3	2.1.	Problèmes au moteur	51
1.2.	Tableau d'entretien et contrôle	4	2.2.	Problèmes de nature électrique	56
1.3.	Outils et accessoires équipant la moto	14	3	INFORMATIONS TECHNIQUES	59
1.4.	Tableau des lubrifiants et liquides	15	3.1.	Description générale de la moto	59
1.5.	Huile moteur - Contrôle du niveau	16	3.1.1.	Circuit de frein avant	61
1.5.1.	Huile moteur - Appoint	17	3.1.2.	Circuit de frein arrière	62
1.6.	Liquide de refroidissement - Contrôle	19	3.1.3.	Circuit d'embrayage	63
1.6.1.	Liquide de refroidissement - Appoint	20	3.1.4.	Graissage moteur	64
1.7.	Plaquettes de freins - Contrôle usure	22	3.1.5.	Circuit de refroidissement	65
1.8.	Liquide de freins - Contrôle du niveau	23	3.1.6.	Circuit d'alimentation	66
1.9.	Liquide d'embrayage - Contrôle du niveau	25	3.2.	Données techniques	67
1.10.	Pneumatiques - Contrôle et remplacement	26	3.3.	Référence couleurs des superstructures	75
1.11.	Chaîne - Contrôle et lubrification	32	3.4.	Référence couleurs composants du châssis et de la partie cycle	77
1.12.	Régime du ralenti - Contrôle	36			
1.13.	Remplacements - Informations générales	37			
1.13.1.	Fusibles - remplacement	37			
1.13.2.	Feu de route - Remplacement de l'ampoule	40			
1.13.3.	Feu de croisement - Remplacement de l'ampoule	43			
1.13.4.	Eclaireur de plaque - Remplacement ampoule	44			
1.14.	Batterie	45			
1.15.	Nettoyage de la moto	47			
1.16.	Période d'arrêt prolong	50			



1.1. Symboles

Les parties du texte particulièrement importantes qui concernent la sécurité de la personne et l'intégrité de la moto, sont mises en évidences par les pictogrammes suivants:



Danger - Attention: le non respect partiel ou total de ces prescriptions peut être source de danger pour soi-même et pour autrui.



Prudence - Précautions: le non respect partiel ou total de ces prescriptions peut être cause de dommages pour la moto.

Pour indiquer les personnes autorisées à exécuter les opérations de réglage et/ou d'entretien, celles-ci sont mises en évidences par les pictogrammes suivants:



Informations sur les opérations permises au motard.



Informations sur les opérations qui doivent être effectuées uniquement par le personnel autorisé.

Pour mettre en évidence les informations supplémentaires, les symboles suivants sont utilisés:



Le symbole  indique la nécessité d'utiliser un outil ou un appareil spécial pour l'exécution correcte de l'opération décrite.



Le symbole “§” renvoie au chapitre correspondant au numéro qui l'accompagne.



1.2. Tableau d'entretien et contrôle

Les opérations d'entretien et contrôle les plus importantes et leur fréquence, sont indiquées dans les tableaux correspondants. Il est indispensable d'effectuer ces opérations pour garder la moto efficace et sûre.

Les intervalles indiqués dans le tableau d'entretien périodique et de lubrification doivent être considérés uniquement comme un guide général en conditions d'utilisation normales. Il pourrait être nécessaire de réduire ces intervalles en fonction des conditions climatiques, du terrain, de la situation géographique et de l'utilisation individuelle.

Certaines opérations peuvent être effectuées par le propriétaire de la moto, à condition qu'il soit en possession des compétences nécessaires. Dans le cas contraire, faire effectuer les opérations par un centre de réparation agréé.

En général, les opérations d'entretien s'effectuent avec la moto montée sur la béquille arrière, avec le moteur coupé et le coupe-circuit sur "OFF". Pendant le contrôle du niveau de liquide, il est préférable de tenir la moto en position verticale sans utiliser la béquille arrière.

Au delà de 36.000 km (22.400 mi), les opérations s'effectuent à la fréquence indiquée dans le tableaux.



ATTENTION

- Un entretien inadéquat ou la non exécution des travaux d'entretien conseillés, augmente le risque d'accident ou de détérioration de la moto
- Utiliser toujours des pièces détachées d'origine MV Agusta. L'utilisation de pièces non d'origine peut accélérer l'usure de la moto et écourter sa durée de vie.
- La non exécution des opérations recommandées ou l'utilisation de pièces détachées non d'origine a pu rendre la garantie inadmissible.
- Le remplacement et/ou le rétablissement des lubrifiants et des liquides s'effectue en utilisant exclusivement les produits indiqués au §1.4.



ATTENTION

En cas d'utilisation sur piste, il est recommandé de faire contrôler la moto avant et après l'emploi par un personnel qualifié faisant partie du réseau des Centres d'Assistance MV Agusta.

L'utilisation sur piste n'est admise que de manière occasionnelle et en aucun cas à des fins de compétition, même à un niveau d'amateur.

L'utilisation de la moto sur piste entraîne une usure notable des pièces, et par là une réduction de la durée de vie du véhicule par rapport à une utilisation normale sur route ou auto-route.



FR 1

Tableau d'entretien programmé

Fréquence d'entretien Km (mi)		0	1000 (600)	6000 (3800)	12000 (7500)	18000 (11200)	24000 (14900)	30000 (18600)	36000 (22400)
Révision		Préparation à la route	A	B	C	D	E	F	G
DESCRIPTION	OPÉRATION								
Huile moteur	Contrôle niveau	Avant chaque utilisation du véhicule							
	Remplacement		●	●	●	●	●	●	●
Filtre à huile moteur	Remplacement (utiliser exclusivement des filtres à huile d'origine MV Agusta)		●	●	●	●	●	●	●
		Au minimum, tous les ans							
Liquide de refroidissement	Contrôle/appoint	Avant chaque utilisation du véhicule							
	Contrôle/appoint	●	●	●	●	●	●	●	●
	Vidange	Tous les 2 ans							
Circuit de refroidissement	Contrôle des fuites	●	●	●	●	●	●	●	●
Electroventilateurs	Contrôle fonctionnement	●	●	●	●	●	●	●	●
Soupapes	Contrôle/réglage				●		●		●
Chaîne de distribution	Contrôle				●		●		
	Remplacement								●





Tableau d'entretien programmé

Fréquence d'entretien Km (mi)		0	1000 (600)	6000 (3800)	12000 (7500)	18000 (11200)	24000 (14900)	30000 (18600)	36000 (22400)	
Révision		Préparation à la route	A	B	C	D	E	F	G	
DESCRIPTION		OPÉRATION								
Patin mobile distribution		Contrôle/remplacement			●		●			
		Remplacement							●	
			Dans tous les cas à chaque remplacement de la chaîne de distribution							
Tendeur de chaîne distribution		Contrôle/remplacement			●		●		●	
Bougies		Contrôle/remplacement		●		●		●		
		Remplacement			●		●		●	
Filtre à essence		Contrôle/remplacement			●		●		●	
Papillon		Contrôle et réglage	●	●	●	●	●	●	●	
Filtre à air		Contrôle/remplacement		●	●	●	●	●	●	
Liquide des freins et d'embrayage		Contrôle du niveau	Avant chaque utilisation du véhicule							
		Contrôle du niveau	●	●	●	●	●		●	●
		Remplacement						●		
			Minimum tous les 2 ans							



Tableau d'entretien programmé

Fréquence d'entretien Km (mi)		0	1000 (600)	6000 (3800)	12000 (7500)	18000 (11200)	24000 (14900)	30000 (18600)	36000 (22400)
Révision		Préparation à la route	A	B	C	D	E	F	G
DESCRIPTION	OPÉRATION								
Freins/embrayage	Contrôle fonctionnalité	Avant chaque utilisation du véhicule							
	Nettoyez secteur de contact levier/piston de maître-cylindre	Tous les 500 ÷ 1000 km (300 ÷ 600 mi)							
	Contrôle fonctionnalité	●	●	●	●	●	●	●	●
	Contrôle circuit	●	●	●	●	●	●	●	●
	Nettoyez secteur de contact levier/piston de maître-cylindre	●	●	●	●	●	●	●	●
Plaquettes des freins (avant + arrière)	Contrôle usure	Tous les 1000 Km (600 mi)							
	Contrôle/remplacement		●	●	●	●	●	●	●
Canalisations circuit du carburant	Contrôle défauts et fuites		●	●	●	●	●	●	●
	Remplacement	Minimum tous les 3 ans							
Commande d'accélérateur	Contrôle fonctionnalité	Avant chaque utilisation du véhicule							
	Contrôle fonctionnalité	●	●	●	●	●	●	●	●
	Vérification/réglage du jeu	●	●	●	●	●	●	●	●
Commande starter	Contrôle fonctionnalité	●	●	●	●	●	●	●	●



Tableau d'entretien programmé

Fréquence d'entretien Km (mi)		0	1000 (600)	6000 (3800)	12000 (7500)	18000 (11200)	24000 (14900)	30000 (18600)	36000 (22400)
Révision		Préparation à la route	A	B	C	D	E	F	G
DESCRIPTION		OPÉRATION							
Transmissions et commandes souples		Contrôle / réglage	●	●	●	●	●	●	●
Chaîne de transmission 		Contrôle	Tous les 1000 Km (600 mi)						
		Graissage	Tous les 1000 km (600 mi) et après conduite sous la pluie						
	Contrôle/réglage	●	●	●	●	●	●	●	●
	Graissage		●	●		●		●	
	Remplacement				●		●		●
Pignon / Rondelle d'arrêt		Contrôle		●	●		●		●
		Remplacement				●		●	
Dans tous les cas à chaque remplacement de la chaîne de transmission									
Couronne		Contrôle		●	●		●		●
		Remplacement				●		●	
Dans tous les cas à chaque remplacement de la chaîne de transmission									



FR 1

Tableau d'entretien programmé

Fréquence d'entretien Km (mi)		0	1000 (600)	6000 (3800)	12000 (7500)	18000 (11200)	24000 (14900)	30000 (18600)	36000 (22400)	
Révision		Préparation à la route	A	B	C	D	E	F	G	
DESCRIPTION		OPÉRATION								
Flecteur couronne		Contrôle/remplacement			●		●		●	
Ecrou de direction		Contrôle/réglage	●		●		●		●	
Roulements de direction		Contrôle / réglage	●		●		●		●	
		Lubrification					●			
Pneumatiques		Contrôle pression	A chaque utilisation du véhicule dans tous les cas tous les 10 jours							
		Contrôle usure	A chaque utilisation du véhicule dans tous les cas tous les 500 km (300 mi)							
		Contrôle pression	●	●	●	●	●	●	●	●
		Contrôle usure		●	●	●	●	●	●	●
Jantes		Contrôle visuel		●	●	●	●	●	●	
			Dans tous les cas à chaque remplacement des pneus							
Roulements roue AV		Contrôle		●	●	●	●	●		
			Dans tous les cas à chaque remplacement des pneus							
		Remplacement							●	





Tableau d'entretien programmé

Fréquence d'entretien Km (mi)		0	1000 (600)	6000 (3800)	12000 (7500)	18000 (11200)	24000 (14900)	30000 (18600)	36000 (22400)
Révision		Préparation à la route	A	B	C	D	E	F	G
DESCRIPTION		OPÉRATION							
Béquille latérale		Contrôle fonctionnalité	Avant chaque utilisation du véhicule						
		Contrôle fonctionnalité	●	●	●	●	●	●	●
Contacteur béquille		Contrôle fonctionnalité	Avant chaque utilisation du véhicule						
		Nettoyez le secteur de contact avec la béquille	Tous les 500 ÷ 1000 km (300 ÷ 600 mi)						
		Contrôle fonctionnalité	●	●	●	●	●	●	●
Moyeu AR		Contrôle/ lubrification des douilles à aiguilles			●		●		
		Remplacement/ lubrification des douilles à aiguilles							●
		Contrôle / Lubrification							●
Patin chaîne bras de suspension		Contrôle/Remplacement	●	●	●	●	●	●	●
Patin chaîne plateau cadre		Contrôle/Remplacement	●	●	●	●	●	●	●
Amortisseur arrière		Contrôle / Réglage		●	●		●		●
Huile fourche avant		Remplacement					●		



Tableau d'entretien programmé

Fréquence d'entretien Km (mi)		0	1000 (600)	6000 (3800)	12000 (7500)	18000 (11200)	24000 (14900)	30000 (18600)	36000 (22400)
Révision		Préparation à la route	A	B	C	D	E	F	G
DESCRIPTION	OPÉRATION								
Cosses de batterie	Contrôle et nettoyage		●	●	●	●	●	●	●
Installation électrique	Contrôle fonctionnalité	●	●	●	●	●	●	●	●
Appareillage de bord	Contrôle fonctionnalité	Avant chaque utilisation du véhicule							
	Contrôle fonctionnalité	●	●	●	●	●	●	●	●
Eclairage/signaux visuels	Contrôle fonctionnalité / Remplacement ampoule	Avant chaque utilisation du véhicule							
	Contrôle fonctionnalité / Remplacement ampoule	●	●	●	●	●	●	●	●
Avertisseur sonore	Contrôle fonctionnalité	Avant chaque utilisation du véhicule							
	Contrôle fonctionnalité	●	●	●	●	●	●	●	●
Phare avant	Contrôle fonctionnalité	Avant chaque utilisation du véhicule							
	Réglage	A chaque variation de l'assiette du véhicule et utilisation avec le passager							
	Contrôle fonctionnalité	●	●	●	●	●	●	●	●
Coupe-circuit	Contrôle fonctionnalité	Avant chaque utilisation du véhicule							
	Contrôle fonctionnalité	●	●	●	●	●	●	●	●



Tableau d'entretien programmé

Fréquence d'entretien Km (mi)		0	1000 (600)	6000 (3800)	12000 (7500)	18000 (11200)	24000 (14900)	30000 (18600)	36000 (22400)
Révision		Préparation à la route	A	B	C	D	E	F	G
DESCRIPTION		OPÉRATION							
Serrures		Contrôle fonctionnalité	Avant chaque utilisation du véhicule						
		Contrôle fonctionnalité	●	●	●	●	●	●	●
Serrage des vis et écrous		Contrôle / serrage	●	●	●	●	●	●	●
Colliers serre-tube		Contrôle / serrage	●	●	●	●	●	●	●
Lubrification générale			●	●	●	●	●	●	●
Essai sur route			●	●	●	●	●	●	●



1.3. Outils et accessoires équipant la moto

Une trousse à outils se trouve dans la boîte à gants, elle contient les outils suivants:

- 1 barre hexagonale (hexagone de 10 mm);
- 6 clés maîtresses hexagonales (hexagone de 2,5 - 3 - 4 - 5 - 6 - 8 mm);
- une clé pour excentrique roue AR. et sa rallonge;
- 1 extracteur pour fusibles;
- 3 fusibles (5A - 7,5A - 15A).

Les accessoires suivants sont également fournis:

- 1 clé à bougie (hexagonale 16 mm);
- 1 pochette pour les papiers.





1.4. Tableau des lubrifiants et liquides

Description	Produit préconisé	Caractéristiques
Huile moteur	AGIP RACING 4T 10W/60 (*)	SAE 10W/60 - API SJ
Liquide de refroidissement	AGIP ECO - PERMANENT	Glycol-éthylène dilué à 50% avec eau distillée
Liquide d'embrayage et freins	AGIP BRAKE FLUID DOT4	DOT4
Huile de graissage de la chaîne	MOTUL CHAIN LUBE ROAD	-

* : Pour la disponibilité du produit conseillé, MV Agusta conseille de s'adresser directement aux propres concessionnaires autorisés. L'huile moteur AGIP Racing 4T 10W/60 a été réalisée spécialement pour le moteur de la motocyclette Brutale. Au cas où le lubrifiant décrit ne serait pas possible à trouver, MV Agusta conseille d'utiliser des huiles complètement synthétiques avec des caractéristiques conformes ou supérieures aux normes suivantes:

- Conforme API SJ
- Conforme ACEA A3
- Conforme JASO MA
- Gradation SAE 20 W-50 ou 10 W-60

NOTE

Les caractéristiques indiquées ci-dessus doivent être indiquées seules ou avec d'autres sur l'emballage de l'huile.





FR 1 1.5. Huile moteur - Contrôle du niveau

Le contrôle se fait à froid, à moteur coupé. Si le contrôle a lieu à chaud, il faut que le moteur soit coupé depuis au moins dix minutes.

Ce contrôle s'effectue en mettant la moto sur un plan horizontal et en position de marche (position verticale).

Le niveau doit être compris entre les repères MAX et MIN inscrits sur le carter.

Dans le cas où le niveau d'huile se trouve en dessous du repère MIN, effectuer un appoint (voir 1.5.1).



Danger - Attention: ne pas démarrer si l'huile est sous le repère du MIN.

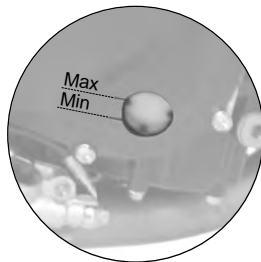



1.5.1. Huile moteur - Appoint

Pour rajouter de l'huile, dévisser le bouchon en employant la barre hexagonale de 10 mm fournie, montée sur une clef appropriée (voir la figure). Verser une quantité d'huile du type conseillé jusqu'à arriver à un niveau adéquat: dans tous les cas, ne pas dépasser le repère MAX. Enfin, revisser le bouchon.



ATTENTION

Avant de rassembler le bouchon d'huile, graissez sa bague en employant AGIP Grease 30.

Enfin, effectuez le serrage de le bouchon d'huile au couple de serrage de 35 Nm, en employant une clef dynamométrique.

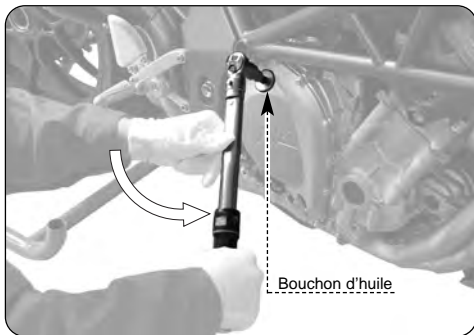

RAPPEL

Pour prévenir le patinage de l'embrayage et éviter d'endommager le moteur, ne pas mélanger d'additifs chimiques à l'huile ni utiliser d'huiles autres que celles indiquées au § 1.4. Veiller à ce qu'aucun corps étranger ne pénètre dans le carter pendant le remplissage.

FR
1**ATTENTION**

L'huile moteur, neuve ou usagée, peut être dangereuse. L'ingestion d'huile moteur neuve ou usagée peut être nocive pour les personnes et les animaux domestiques. En cas d'ingestion d'huile moteur, appeler immédiatement un médecin et ne pas provoquer le vomissement pour éviter l'aspiration du produit dans les poumons. Il a été constaté que le contact continu avec l'huile moteur provoque le cancer de la peau sur des cobayes. De brefs contacts avec l'huile moteur peuvent irriter la peau.

- Conserver l'huile moteur, neuve ou usée, loin de la portée des enfants et des animaux domestiques.
- Porter des vêtements à manches longues et des gants imperméables à l'eau toutes les fois que l'on effectue un ajout d'huile moteur.
- Se laver à l'eau et au savon si l'huile moteur entre en contact avec la peau.
- Recycler ou évacuer correctement l'huile moteur usagée.



1.6. Liquide de refroidissement - Contrôle du niveau

Le contrôle se fait à froid, à moteur coupé.
Ce contrôle s'effectue en disposant la motocyclette sur un plan horizontal et en position de marche (position verticale).

Le niveau doit être compris entre le repère MIN et le côté inférieur du tube de cadre comme représenté sur la figure.

Dans le cas où le niveau de liquide de refroidissement se trouve sous le repère MIN, ajouter un complément (voir § 1.6.1).



ATTENTION

Ne pas utiliser la moto si le niveau du liquide de refroidissement se trouve en dessous du repère MIN.

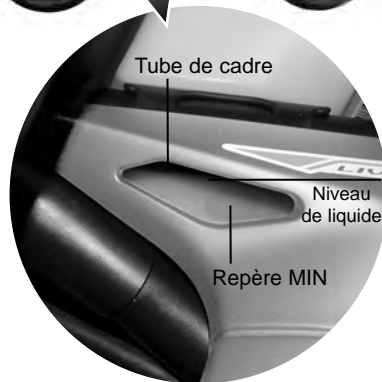

**FR 1**

1.6.1. Liquide de refroidissement - Apport

Pour accéder au bouchon, dévisser les vis de fixation pour enlever le couvercle.

Dévisser le bouchon et ajouter le liquide de refroidissement conseillé au § 1.4.

Bouchon de remplissage
liquide de refroidissement

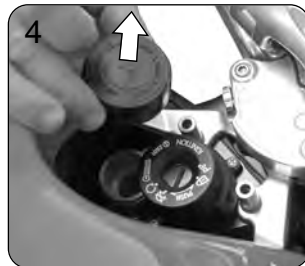
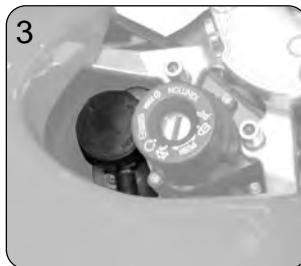
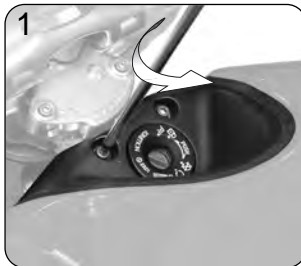

Une fois que le niveau est corrigé, remonter soigneusement les parties démontées précédemment.



ATTENTION: L'ajout de liquide de refroidissement s'effectue toujours à moteur froid. Ne jamais tenter de retirer le bouchon du réservoir de liquide refroidissement lorsque le moteur est chaud pour éviter les risques de brûlure. Le circuit est sous pression!



RAPPEL: Pour le rétablissement et/ou le vidange du liquide de refroidissement, utiliser exclusivement le produit spécifié au tableau § 1.4. Ne mélangez pas ou ne diluez pas le liquide réfrigérant avec des additifs ou des fluides différents. Au cas où le produit spécifié au tableau § 1.4. ne serait pas possible à trouver, utiliser un liquide réfrigérant avec des caractéristiques techniques conformes au produit prescrit.



RAPPEL: Les giclées de liquide de refroidissement peuvent endommager les peintures. Attention à ne pas renverser de liquide lorsque vous remplissez le circuit de refroidissement. Sécher immédiatement avec un chiffon propre le liquide de refroidissement éventuellement renversé.



ATTENTION

Dans certaines conditions, le glycol-éthylène contenu dans le liquide de refroidissement est inflammable et sa flamme est invisible. Eviter de mettre le liquide de refroidissement au contact des parties chaudes car la combustion du glycol-éthylène peut exposer à des risques de brûlures.



ATTENTION

Le liquide de refroidissement du moteur est nocif en cas d'ingestion ou s'il entre en contact avec les yeux ou la peau. Conserver le liquide de refroidissement loin de la portée des enfants et des animaux domestiques. En cas d'ingestion de liquide de refroidissement, appeler immédiatement un médecin et ne pas provoquer le vomissement pour éviter l'aspiration de produit dans les poumons. En cas de contact du liquide de refroidissement avec les yeux ou la peau, rincer immédiatement à l'eau.



FR 1

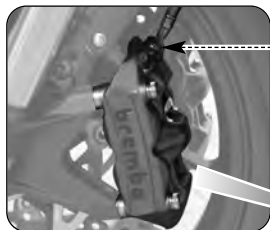

Etrier de frein avant

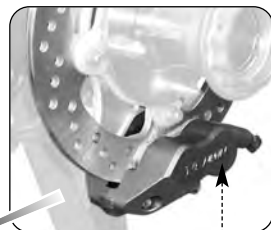

Etrier de frein arrière

Disque de frein

Plaquettes

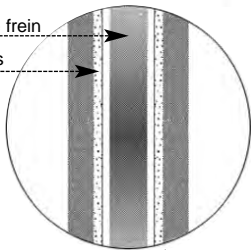

Usure limite 1 mm

1.7. Plaquettes de freins - Contrôle de l'usure

Contrôler périodiquement la largeur de la couche du matériel de frottement des plaquettes, en veillant à ne pas la laisser descendre en dessous de la limite d'usure (1 mm).



Danger – Attention: En cas d'utilisation de la moto avec les plaquettes de frein usées, la puissance de freinage diminue et le risque d'accident augmente. Si l'épaisseur restante est proche de la limite d'usure, s'adresser à un centre d'assistance agréé pour effectuer le remplacement des plaquettes. Soumettre les plaquettes à un rodage.



Réservoir de frein AR.



Réservoir de frein AV.

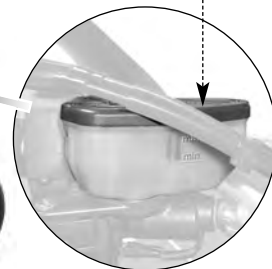

1.8. Liquide de freins - Contrôle du niveau



ATTENTION

Les contrôles non effectués et l'entretien négligé des freins augmentent les risques d'accident. Avant toute sortie avec la moto, contrôler le circuit de freinage en suivant les instructions données au Manual Rapide.

L'usure des plaquettes de freins provoque une baisse de niveau du liquide. Dans tous les cas, le niveau doit être compris entre les repères MAX et MIN. Si ce niveau descend en dessous du repère MIN, il faut s'adresser à un centre de réparation agréé pour un contrôle général du circuit de freinage.



ATTENTION: Ne pas utiliser la moto si le niveau se trouve en dessous du repère MIN. Dans ces conditions, le circuit de freinage pourrait ne pas fonctionner correctement avec comme conséquence un risque de perte de contrôle du véhicule et des accidents. Si le niveau de liquide se trouve en dessous du repère MIN, s'adresser à un Concessionnaire MV Agusta pour faire réviser le circuit de freinage.



ATTENTION: Faire rectifier le niveau du liquide de frein exclusivement par le personnel autorisé. Le liquide de frein est nocif ou mortel en cas d'ingestion et nocif s'il entre en contact avec les yeux ou la peau. Conserver le liquide de frein loin de la portée des enfants et des animaux domestiques. En cas d'ingestion de liquide de frein, appeler immédiatement un médecin et ne pas provoquer le vomissement pour éviter l'aspiration de produit dans les poumons. En cas de contact du liquide de frein avec les yeux ou la peau, rincer immédiatement à l'eau.



ATTENTION
Faire rectifier le niveau de liquide en utilisant uniquement le type de liquide conseillé au §1.4. de ce manuel. Les mélanges éventuels entre fluides de type différents peuvent provoquer une réaction chimique dangereuse et la diminution d'efficacité du freinage avec une augmentation du risque d'accident.



ATTENTION
Une quantité insuffisante de liquide de freins peut permettre l'entrée d'air dans le circuit et compromettre ainsi l'efficacité du freinage et augmenter les risques d'accidents. La présence d'air dans le circuit se traduit par une excessive souplesse du levier de frein. En présence d'air dans le circuit, faire purger celui-ci par un concessionnaire MV Agusta avant d'utiliser la moto.



1.9. Liquide d'embrayage - Contrôle du niveau

Le niveau doit être compris entre les repère MAX et MIN. Si ce niveau descend en dessous du repère MIN, il faut s'adresser à un centre de réparation agréé pour un contrôle général du circuit de commande de l'embrayage.



ATTENTION

Ne pas utiliser la moto si le niveau est en dessous du repère MIN. Dans ces conditions le circuit de commande d'embrayage pourrait ne pas fonctionner correctement et créer un risque de perte de contrôle du véhicule et des accidents. Si le niveau de liquide se trouve en dessous du repère MIN, s'adresser à un Concessionnaire MV Agusta pour effectuer l'appoint du fluide de commande d'embrayage.



ATTENTION

Faire rectifier le niveau du liquide de commande d'embrayage en utilisant uniquement le type de fluide conseillé au §1.4. de ce livret.





FR 1 1.10. Pneumatiques - Contrôle et remplacement



ATTENTION

Avant l'utilisation, toujours vérifier la pression des pneumatiques et leur état d'usure.

Le contrôle de la pression des pneumatiques est un facteur fondamental pour assurer la sécurité de conduite. Les pneumatiques insuffisamment gonflés aggravent la maniabilité de la moto et s'usent rapidement. Au contraire, des pneus surgonflés ont une plus petite superficie de contact au sol et peuvent réduire l'adhérence du véhicule.

Avant toute utilisation de la moto, il est donc indispensable de contrôler la pression des pneumatiques à température ambiante, c'est à dire avec la moto à l'arrêt depuis au moins trois heures.



ATTENTION

Un gonflage erroné des pneumatiques entraîne une série de dangers lors de l'utilisation de la moto. Une pression insuffisante peut faire déjancer le pneu avec pour conséquence un dégonflage et une perte de contrôle du véhicule.



Les résultats obtenus d'un contrôle juste après l'utilisation de la moto donnerait en effet des valeurs plus hautes par rapport à celles réelles et donc un réglage erroné de la pression. Le contrôle de la pression s'effectue en respectant les valeurs données au §2.2 et/ou sur l'étiquette qui se trouve sur la bulle. En cas de long trajets continus, augmenter la valeur de pression nominale de 0,2 bar.

De plus, avant utilisation, il est extrêmement important de contrôler l'usure des pneumatiques. En effet, des pneus usés ont tendance à subir des crevaisons plus facilement et influent négativement sur la stabilité et la maniabilité de la moto. Au cours du contrôle, s'assurer que l'épaisseur de la bande de roulement ne se trouve pas en dessous des valeurs prescrites par le code de la route et qu'il n'y a pas de fentes sur le fond de l'empreinte. En outre, il ne doit pas y avoir de clous ou de fragments de verre sur le pneumatique, ni de fissures sur son flanc. Dans le cas contraire, faire remplacer immédiatement le pneumatique chez un Concessionnaire MV Agusta.

**ATTENTION**

Les limites de profondeur de la bande de roulement du pneu peuvent varier d'un pays à l'autre. Toujours respecter les dispositions légales du pays d'utilisation.

**ATTENTION**

- Faire remplacer les pneus excessivement usés par un concessionnaire MV Agusta. L'usage de la moto avec des pneus usés, en plus d'être illégale, réduit la stabilité et peut provoquer la perte de contrôle de la moto.
- Si un pneu creève ou subit quelque dommage, il faut le remplacer et non pas le réparer. Un pneu réparé donne des résultats limités et des niveaux de sécurité inférieurs par rapport à un pneu neuf.



- En cas de réparation temporaire ou d'urgence d'un pneumatique, conduire lentement et avec précaution jusqu'au plus proche concessionnaire MV Agusta pour faire remplacer le pneu. Après la réparation d'un pneu, ne pas dépasser la vitesse de 60 km/h. La réparation ne peut pas être effectuée si le pneu est crevé sur le flanc ou si le trou sur la bande de roulement est supérieur à 6 mm.
- Pour la réparation temporaire d'un pneu crevé, MV Agusta déconseille l'utilisation de produits de réparation liquides. Ces produits peuvent influencer négativement sur le matériau formant la stratification des pneus et cacher les dommages secondaires provoqués par d'éventuels objets de pénétration.

- Remplacer les pneus en utilisant exclusivement ceux prescrits au §2.2. Eviter également d'utiliser simultanément des pneus de type ou de marques différentes à l'avant et à l'arrière. L'utilisation de pneus impropres peut influencer négativement sur la maniabilité et la stabilité de la moto, augmentant ainsi les risques d'accidents.
- Les jantes de la moto ont été conçues pour l'utilisation de pneus tubeless. Ne pas monter de pneus avec chambre à air sur les jantes pour pneus tubeless. Les talons pourraient ne pas se mettre en place correctement et les pneus s'affaisser en glissant sur les jantes provoquant une perte de contrôle du véhicule.



- Ne pas monter de chambre à air dans un pneu tubeless. La surchauffe du pneu pourrait faire éclater la chambre à air et provoquer l'affaissement du pneu et la perte de contrôle du véhicule.
- Faire monter les pneus conformément au sens de rotation indiqué par les flèches sur leurs flancs.

- Les pneus neufs doivent être soumis à une période de rodage avant d'être parfaitement efficaces. Durant cette période, il est possible que les pneus aient une adhérence limitée sur certaines surfaces. Nous conseillons donc de conduire à vitesse modérée et de prendre un maximum de précautions pendant au moins 100 km après le montage d'un pneu neuf.



❑ Démontage de la roue arrière



Rappel - Précautions: Au cas où il serait nécessaire de faire remplacer le pneumatique arrière dans un centre spécialisé. Veiller à ce que les outils suivants soient utilisés pour le démontage et le remontage de la roue:

- Clé à douille polygonale de 55 mm
- Clé dynamométrique

Si les opérations sont exécutées avec d'autres outils, les composants de la roue arrière pourraient se retrouver gravement endommagés. Nous conseillons donc de ne pas faire remplacer les pneus par un atelier qui ne possède pas les équipements adéquats. Dans tous les cas, il est préférable de s'adresser à un Concessionnaire MV Agusta.

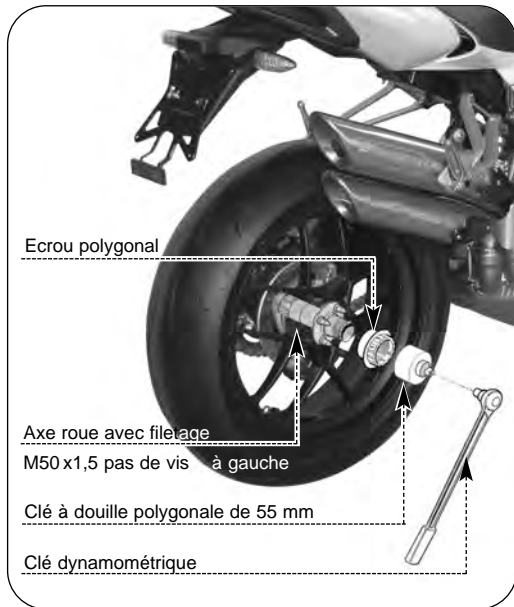



□ Contrôle des roues

Avant d'utiliser la moto, toujours contrôler que la jante ne présente pas de criques, torsions ou voiles.



ATTENTION

En présence de détériorations, faire remplacer la roue par un concessionnaire MV Agusta. Ne pas tenter d'effectuer de réparations des roues même si ce sont des réparations minimales.

En cas de remplacement du pneumatique ou de la roue, il faut faire effectuer l'équilibrage de la roue chez un concessionnaire MV Agusta. Le déséquilibre de la roue peut compromettre les performances et la maniabilité de la moto et réduire la durée des pneumatiques.



ATTENTION

Pour effectuer l'équilibrage des roues, il faut avoir recours exclusivement à des contrepoids homologués. Il est déconseillé d'utiliser des équilibrants liquides ou des équilibrants liquides/collants.



ATTENTION

Ne pas tenter de faire démonter un pneu tubeless sans l'outillage spécial nécessaire et les protections pour la jante. Dans le cas contraire, on risque d'endommager ou de déformer le bourrelet d'étanchéité de la jante, avec comme conséquence un risque d'affaissement du pneu et une perte de contrôle du véhicule.



1.11. Chaîne - Contrôle et lubrification

Pour effectuer les opérations suivantes, positionner la moto sur la béquille arrière, sur un plan horizontal et avec le sélecteur au point mort.

☐ Contrôle du réglage



ATTENTION: Avant de vérifier l'ajustement de la chaîne, s'adresser à un centre d'assistance autorisé MV Agusta pour vérifier que la valeur de l'assiette statique de la suspension arrière est correcte. S'assurer en outre que la chaîne est correctement lubrifiée.

L'axe du brin inférieur de la chaîne doit se trouver à **50 mm** du pare-chaîne inférieur. Effectuer le contrôle en plusieurs points de la chaîne en tournant manuellement la roue arrière. Le jeu doit rester pratiquement constant pendant que la roue tourne. Si la chaîne présente des fortes variations du jeu, cela signifie que certains maillons sont écrasés, grippés ou allongés. Si la distance entre la chaîne et le pare-chaîne inférieur est supérieure à 50 mm, il faut faire régler la chaîne.

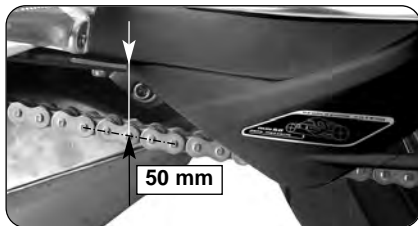

NOTE: Sur demande, il est possible de commander au Service Pièces Détachées MV Agusta une spéciale couverture de chaîne supérieure rallongée. Le montage de ce composant sur votre moto donne une meilleure protection qu'un composant standard.





ATTENTION

L'utilisation de la motocyclette avec la chaîne en mauvaise état ou mal réglée peut donner lieu à des accidents. Avant chaque utilisation de la moto, effectuer le contrôle de la chaîne en conformité au présent chapitre. Dans le cas où le réglage de la tension de la chaîne s'impose, s'adresser à un centre d'assistance autorisé MV Agusta.



ATTENTION

Si la chaîne présente des maillons écrasés, grippés ou allongés, il faut effectuer le remplacement de la chaîne par un centre d'assistance autorisé MV Agusta.



ATTENTION

En cas de détérioration ou d'usure excessive de la chaîne et des pignons, il faut s'adresser à un concessionnaire MV Agusta pour le remplacement. Toutes les fois que la chaîne est remplacée, même les pignons doivent être renouvelés.



ATTENTION

Il peut être dangereux d'utiliser une chaîne de type à faux maillon. Un maillon principal incomplètement riveté ou de type ouvrant de jonction, peut s'ouvrir et provoquer des accidents ou de sérieux dommages au moteur. Ne pas utiliser de chaînes avec un maillon ouvrant.



ATTENTION

Chaque fois qu'est requise d'actionner les vis du moyeu du roue arrière, contactez un concessionnaire autorisé MV Agusta. Afin de serrer les vis, appliquez un couple de serrage égal à la valeur montrée dans l'étiquette placée sur le monobras. L'application d'un couple plus haut que la valeur indiquée peut causer l'affaiblissement rapide du moyeu du roue arrière, compromettant la fiabilité du véhicule et la sûreté du pilote et du passager.



❑ Lubrification

La chaîne doit être correctement lubrifiée pour garantir le maximum d'efficacité.

► **Nettoyage préalable:** avant d'effectuer la lubrification, il est nécessaire de dissoudre les dépôts de saleté sur la chaîne en utilisant du mazout. Ces dépôts doivent ensuite être retirés avec un chiffon propre et/ou un jet d'air.



Rappel - Précaution: la chaîne est du type à joints toriques. Pour éviter la détérioration, ne pas effectuer le nettoyage de la chaîne avec des jets de vapeur ou d'eau sous haute pression, ni utiliser d'essence ou de solvants détergents dans le commerce. Le nettoyage de la chaîne s'effectue uniquement avec du mazout.



ATTENTION

Le mazout peut être dangereux. Il est inflammable. Le contact avec le mazout peut être nocif pour les enfants et les animaux domestiques.

Tenir les flammes libres et les objets à haute température loin du mazout. Garder les enfants et les animaux domestiques loin du mazout. Effectuer correctement le traitement du mazout usagé.



► **Lubrification:** appliquer une couche de lubrifiant légère et uniforme sur tout le développement de la chaîne en ayant soin de ne pas toucher les parties environnantes, en particulier les pneumatiques. Diriger le jet du lubrifiant sur les maillons internes, afin de lubrifier la surface des bagues et pénétrer à l'intérieur du rouleau à chaînes.



Rappel - Précaution: utiliser uniquement le lubrifiant spécifié au tableau § 1.4., afin de protéger la chaîne de transmission et éviter l'huile injecte quand le véhicule est en mouvement.



ATTENTION: La lubrification de la chaîne s'effectue selon les intervalles spécifiés dans le tableau d'Entretien Programmé de ce manuel (voir § 1.2). Il est nécessaire d'effectuer cette opération même après la conduite sous la pluie et après chaque lavage de la motocyclette. L'utilisation de la motocyclette avec la chaîne en mauvaises conditions ou non lubrifiée peut donner lieu à des accidents.

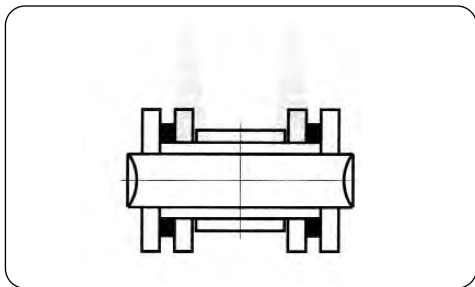

1

FR



FR 1 1.12. Régime du ralenti - Contrôle

Le contrôle s'effectue avec le moteur à température de marche en veillant à que le dispositif "CHOKE" ne soit pas actionné.

Le régime du ralenti doit être compris entre 1150 et 1250 tr/mn.

Pour ce réglage, il faut s'adresser aux centres de réparation agréés.





1.13. Remplacements - Informations générales

Le remplacement des fusibles et des ampoules peut être réalisé par le motard en suivant à la lettre les indications données:

	Fusible de charge batterie - Remplacement (§1.13.1.)
	Fusibles - Remplacement (§1.13.1.)
	Feu de croisement - Remplacement ampoule (§1.13.2.)
	Feu de route - Remplacement ampoule (§1.13.3.)
	Eclaireur de plaque - Remplacement ampoule (§1.13.4.)

1.13.1. Fusibles - Remplacement

► Le fusible de charge de la batterie se trouve sous la selle du pilote, dans la position indiquée.

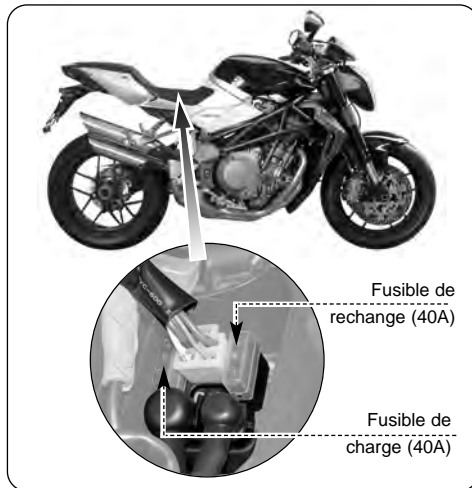



FR
1

► Le porte-fusibles se trouve en dessous de la selle passager. Pour l'atteindre, il faut enlever la selle conducteur, puis dévisser l'accroche de la selle passager, et l'extraire.



► Décrocher et soulever le couvercle de la boîte porte-fusibles.





► Pour déterminer la position et la fonction du fusible, consulter les informations données sur l'adhésif et sur le schéma électrique fourni. Les lettres de références indiquées sur la figure correspondent à celles du schéma.

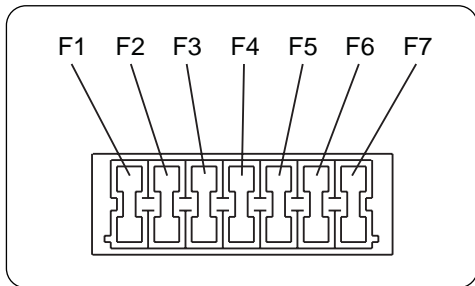

1 FR

► Remplacer le fusible grillé et remonter le couvercle.
Il faut se rappeler que la trousse à outils contient trois fusibles de rechange.



ATTENTION

Ne pas utiliser un fusible avec une capacité différente de celle indiquée, dans le but d'éviter la détérioration de l'installation électrique de la motocyclette avec danger d'incendie.





1.13.2. Feu de route - Remplacement de l'ampoule

► Enlever les deux vis latérales de fixation du feu avant. Veiller à extraire le registre de son logement au moment où le phare se détache du support.

► Avant de démonter le feu avant de son support, débrancher le connecteur situé dans la partie arrière du feu.

► Poser le feu sur une table afin d'y effectuer les opérations ci-dessous.





- ▶ Enlever la vis postérieure du feu.
- ▶ Enlever la partie avant du feu de sa coquille de montage.



1
FR

- ▶ Enlever le protecteur.





FR
1

- ▶ Débrancher le connecteur du feu de route.
- ▶ Décrocher le ressort de fixation.
- ▶ Extraire l'ampoule du feu de route.



Prudence - précautions: ne pas toucher le verre de l'ampoule avec les mains. En cas de contact, nettoyer avec un produit dégraissant.

- ▶ Introduire l'ampoule neuve.
- ▶ Raccrocher le ressort de fixation.
- ▶ Rebrancher le connecteur du feu de route.
- ▶ Remettre en place le protecteur.
- ▶ Remonter la partie antérieure du feu sur la coque de support.
- ▶ Revisser la vis postérieure.
- ▶ Rebrancher le connecteur du feu.
- ▶ Remettre en place le feu sur son support et revisser les deux vis de fixation latérales en ayant soin de remettre le registre de réglage du projecteur dans son logement.





1.13.3. Feu de croisement - Remplacement de l'ampoule

- ▶ Enlever le feu avant de son support comme il est décrit au § 1.13.2.
- ▶ Extraire l'ampoule du feu de route en appuyant sur le côté du connecteur et en le tirant vers l'extérieur.
- ▶ Débrancher le connecteur de l'ampoule.



Prudence - précautions: ne pas toucher le verre de l'ampoule avec les mains. En cas de contact, nettoyer avec un produit dégraissant.

- ▶ Introduire le connecteur dans l'ampoule neuve.
- ▶ Réinsérer l'ampoule et la fixer en la poussant légèrement dans son emplacement.
- ▶ Remonter le feu sur son support en procédant selon les indications du § 1.13.2.





1.13.4. Eclaireur de plaque - Remplacement ampoule

- ▶ Enlever les vis de fixation du guide-câbles.
- ▶ En agissant comme il est indiqué dans la figure, baisser le guide-câbles en le détachant de la surface d'appui supérieure.



- ▶ Extraire la douille de l'éclaireur de plaque de son logement.
- ▶ Extraire la douille en la sortant de la douille.
- ▶ Introduire l'ampoule neuve.
- ▶ Remettre en place la douille.
- ▶ Remettre en place le guide-câbles en contact avec la surface d'appui supérieure.
- ▶ Revisser les vis de fixation du guide-câbles.





1.14. Batterie

Cette motocyclette est équipée d'une batterie cachetée montée sous l'élément de carénage arrière. Elle est exempte d'entretien, il n'est donc pas nécessaire de contrôler le niveau de liquide ni d'ajouter de l'eau distillée.

Si la batterie semble déchargée (causant des problèmes électriques ou des démarrages difficiles), faites la charger le plus tôt possible auprès d'un concessionnaire MV Agusta. Il faut se rappeler que la batterie a tendance à se décharger plus rapidement si la motocyclette est équipée des accessoires électriques en option.



ATTENTION

Si le corps extérieur de la batterie est endommagé, il peut se produire des écoulements d'acide sulfurique, une substance toxique et hautement corrosive. Eviter tout contact avec la peau, les yeux et les vêtements. Toujours se protéger les yeux lorsqu'on travaille à proximité de la batterie.

En cas de contact, donner les **PREMIERS SECOURS** suivants:

- **CONTACT EXTERNE:** Rincer à l'eau abondante.
- **CONTACT INTERNE:** Boire de grandes quantités d'eau ou de lait et appeler immédiatement un médecin.
- **YEUX:** Rincer à l'eau pendant 15 mn et appeler immédiatement un médecin. L'écoulement d'acide sulfurique comporte également la formation d'hydrogène qui peut provoquer une explosion en présence d'une étincelle ou d'une flamme. Pour effectuer le remplacement de la batterie, il est nécessaire de s'adresser à un centre d'assistance autorisé MV Agusta.



Inactivité prolongée

Si la moto est destinée à ne pas être utilisée pendant une période prolongée (un mois ou plus), il est conseillé de débrancher les cosses de batterie ou de faire déposer celle-ci par un mécanicien qualifié. En cas de longue inactivité, il est recommandé de faire recharger la batterie par un concessionnaire MV Agusta tous les 4-5 mois, afin de garantir sa durée dans le temps.



DANGER: L'inversion des câbles de la batterie peut endommager le circuit de charge et la batterie. Les câbles rouges se branchent sur la borne du positif (+) et les noirs sur celle du négatif (-). Pour la dépose de la batterie, débrancher **EN PREMIER** la cosse du pôle négatif puis celle du positif. Pour le montage, procéder de manière inverse.





1.15. Nettoyage de la moto

Le nettoyage périodique et méticuleux est important pour préserver la valeur de la moto dans le temps, en protégeant la finition de toutes les superficies et en contrôlant qu'il n'y a pas d'usure ou de fuites de fluides corrosifs.



Rappel - Précaution: avant d'effectuer le lavage, obturer les tuyaux d'échappement et protéger les composants électriques.



ATTENTION

Si la moto est encore chaude à cause d'une utilisation récente, attendre que le moteur et le circuit d'échappement aient refroidi.



Rappel - Précaution: ne pas utiliser de machines de lavage à jet d'eau sous haute pression ou à vapeur, car elles peuvent provoquer des infiltrations d'eau et la détérioration des composants de la moto.



NOTE: Les détergents sont polluants pour l'environnement. Le nettoyage du véhicule doit donc être effectué dans des zones équipées pour la récolte et l'épuration des liquides de lavage



FR 1

Laver à l'eau, à l'éponge et utiliser un détergent non agressif. Sécher avec un chiffon doux. Dans les zones moins accessibles, utiliser un jet d'air comprimé.

**Rappel - Précautions:**

- Veiller à ne pas utiliser de chiffons ou d'éponges ayant été en contact avec des produits de nettoyage forts ou abrasifs, des solvants, alcool ou de l'essence.
- Pour éviter d'endommager irréparablement les composants de la carrosserie, ne pas se servir de détergents alcalins ou très acides, d'essence, de liquide de freins ou autres solvants.
- Si vous avez des doutes sur la composition chimique du détergent, examiner son effet en l'appliquant sur un secteur de la carrosserie avant de l'employer sur la moto.

Périodiquement, traiter les peintures avec un produit spécial. En cas de trajets sur routes traitées avec des produits corrosifs (sel), effectuer le lavage dès que possible en utilisant de l'eau froide: l'eau chaude favorise l'action corrosive.



ATTENTION: Veiller à ce qu'il n'y ait pas d'huile ou de cire sur les freins ou sur les pneus. Si nécessaire, nettoyer les disques des freins avec un détergent pour disques de frein ou avec de l'acétone et laver les pneus à l'eau chaude et avec un détergent neutre.



ATTENTION: Si les freins sont mouillés, la puissance de freinage peut s'en trouver diminuée. Après le lavage, démarrer le moteur quelques minutes, se mettre en route à vitesse réduite et effectuer quelques freinages avec précaution pour sécher les plaquettes et les disques des freins.



ATTENTION: La chaîne de transmission doit être lubrifiée juste après le lavage et le séchage de la moto selon les instructions données au § 1.11 de ce manuel.

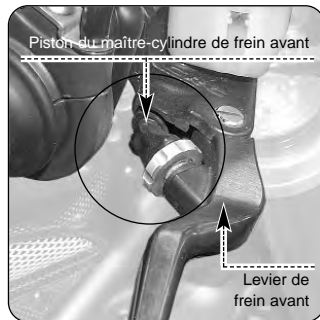
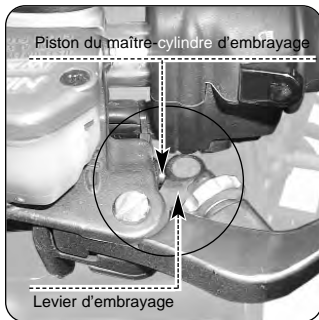
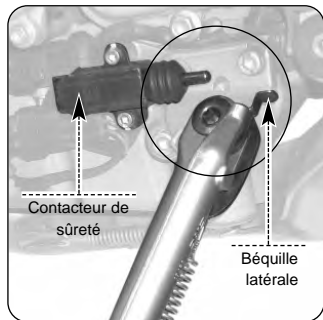

RAPPEL

Veillez à garder toujours propre les secteurs de contact entre les composants suivants, comme représenté sur les figures ci-dessus:

- Béquille latérale et contacteur de sûreté
- Levier d'embrayage et piston du maître-cylindre d'embrayage
- Levier de frein avant et piston du maître-cylindre de frein avant

Nettoyez ces secteurs chaque 500-1000 kilomètres, comme prescrit dans le Tableau d'entretien programmé. Dans tout le cas, nous suggérons de vérifier la propreté des secteurs ci-dessus chaque fois que vous utilisez le véhicule, afin de maintenir le fonctionnement correct des pièces relatives.



1.16. Période d'arrêt prolongé

Si l'on prévoit de laisser la moto à l'arrêt pendant une longue période, il est préférable d'effectuer les opérations ci-dessous.

	Vidanger le réservoir à carburant.
	Retirer la batterie et la conserver correctement.
	Retirer les capuchons des bougies et les bougies. Verser une cuillère à café d'huile moteur dans chacun des orifices de bougie puis remonter les bougies et leur capuchon et faire tourner le moteur à vide de quelques tours.
	Lubrifier tous les câbles de commande et les axes de rotation de tous les leviers et pédales.
	Nettoyer la moto et traiter les parties peintes avec des produits spéciaux (§1.15.).
	Afin de garantir l'intégrité et la qualité des pneus, garer la moto dans un endroit frais, sec et sombre avec une température relativement constante et inférieure à 25°C. Eviter le contact direct des pneus avec les canalisations ou les radiateurs de chauffage ainsi que le contact prolongé avec huile et essence. Eviter de ranger les pneus à proximité de moteurs électriques ou appareillages en mesure de générer des étincelles ou des décharges électriques. Pendant la période de stationnement, maintenir la moto soulevée sur la béquille arrière.
	Couvrir la moto avec une bâche appropriée.

Lors de la première utilisation de la moto, faire un contrôle général et faire effectuer l'entretien (§1.2.) si nécessaire.



2.1. Problèmes au moteur: **LE MOTEUR NE DÉMARRE PAS**

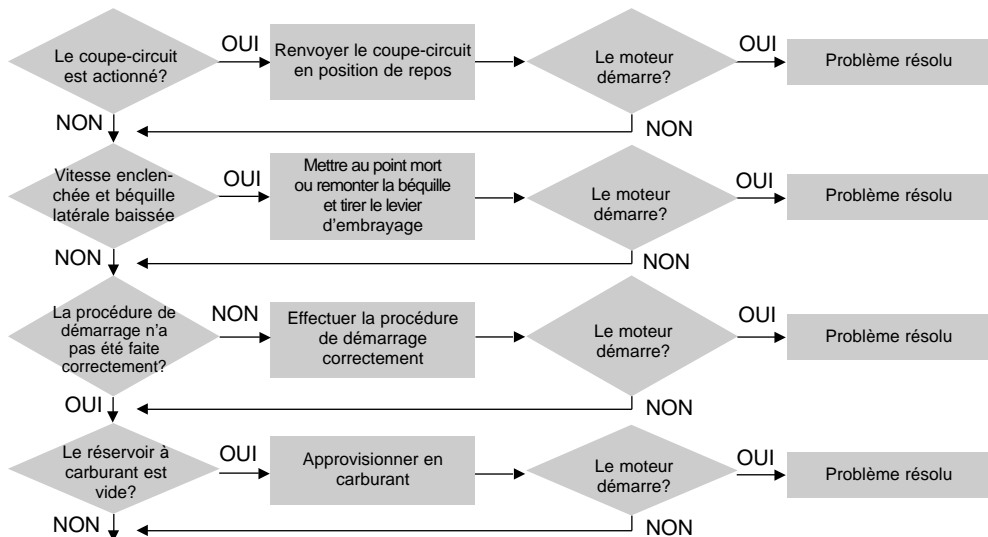

Suite page suivante





Suite de la page précédente

FR 2

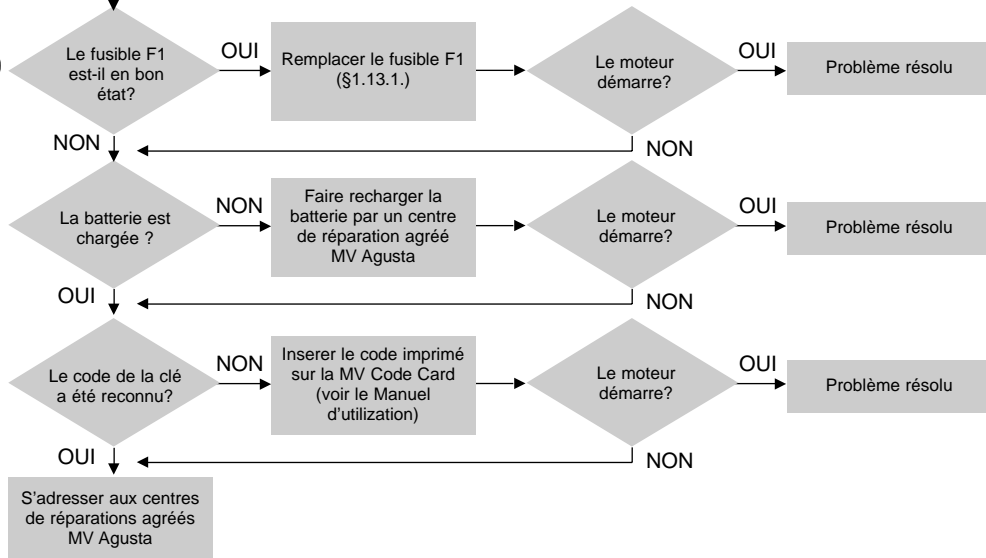



LE MOTEUR A COUPÉ TOUT EN COURANT

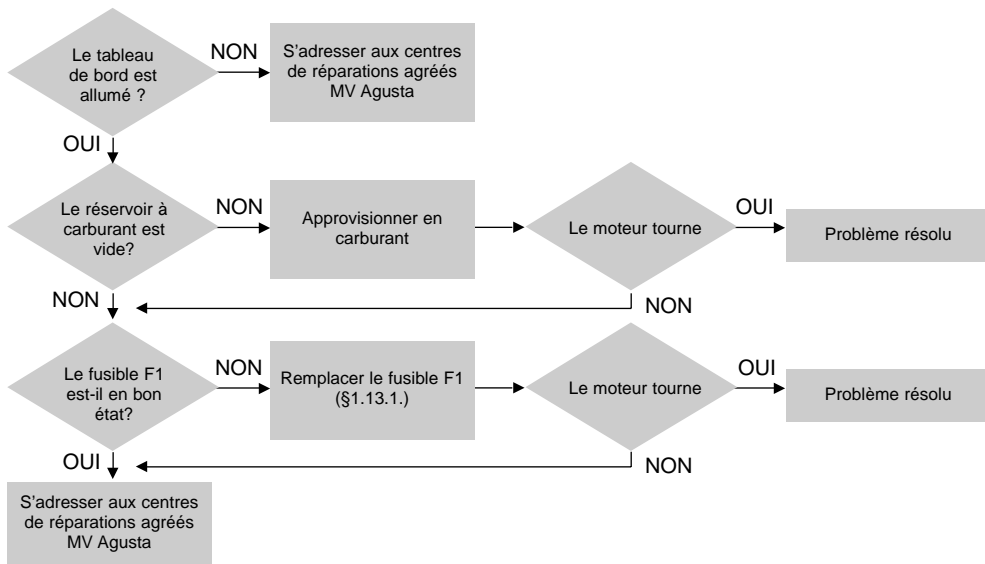



LE MOTEUR SURCHAUFFE (Température du liquide de refroidissement = 112°÷140° C)

FR 2

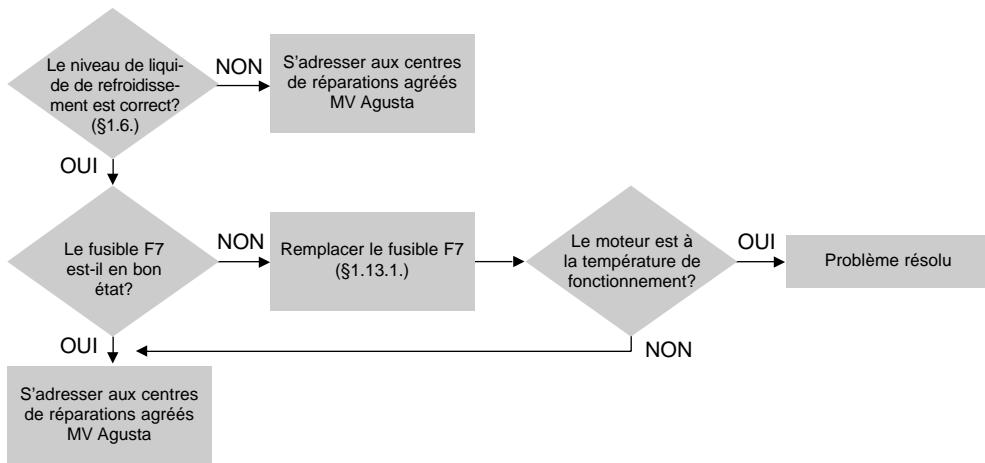



LA PRESSION D'HUILE EST INSUFFISANTE

(Le voyant de pression d'huile moteur est allumé avec le moteur courant)

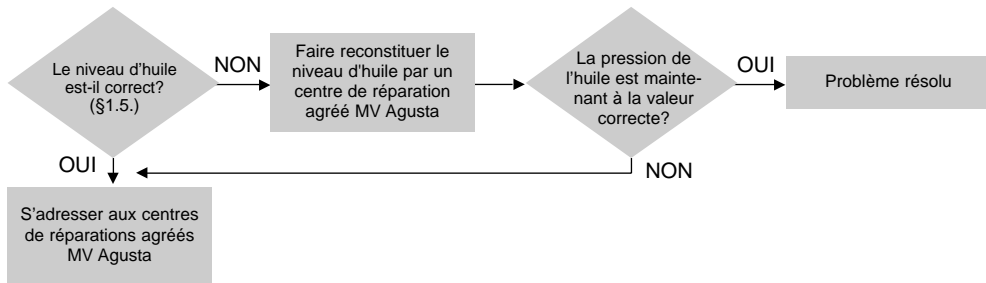



2.2. Problèmes de nature électrique: **LES FEUX NE FONCTIONNENT PAS**

FR 2

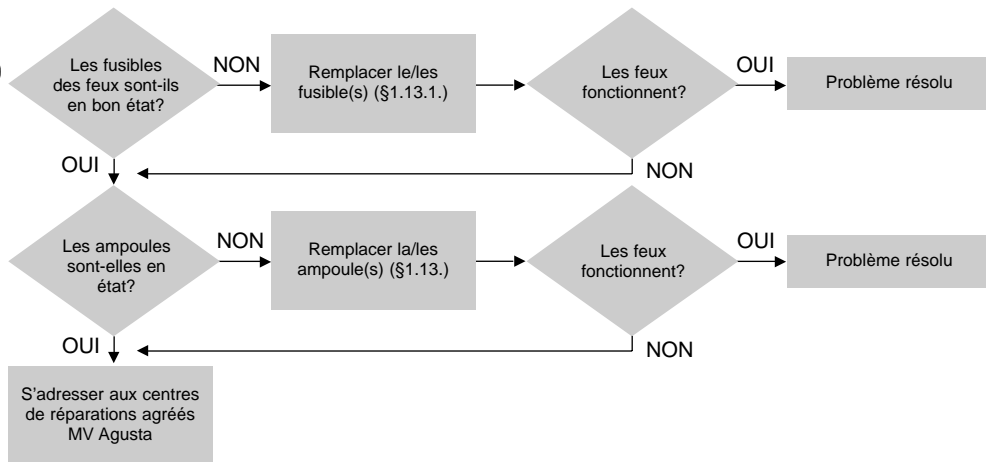



L'AVERTISSEUR SONORE NE FONCTIONNE PAS

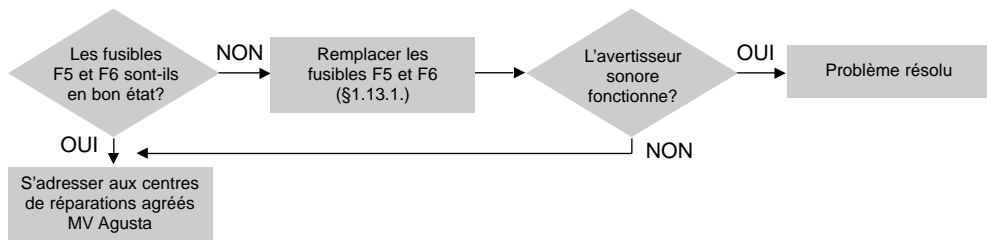

2 FR

LE COMPTEUR KILOMETRIQUE NE FONCTIONNE PAS

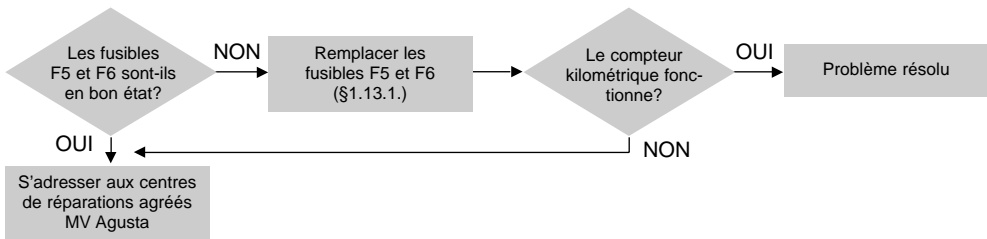

**LES VOYANTS DU TABLEAU DE BORD NE FONCTIONNENT PAS**

FR 2

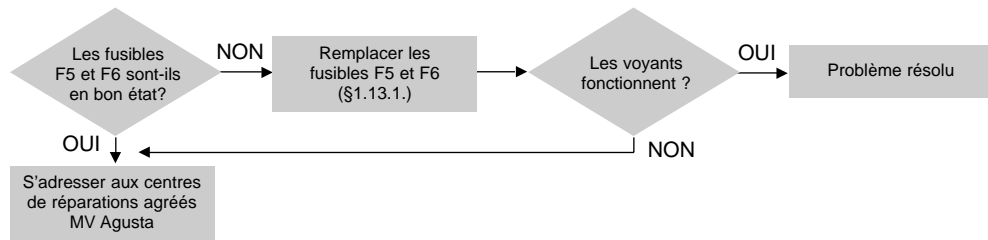
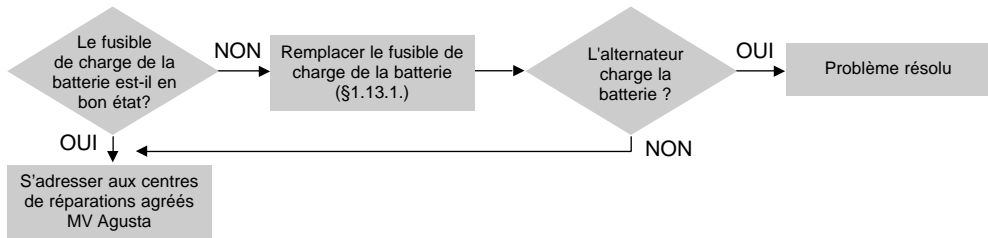
**L'ALTERNATEUR NE CHARGE PAS LA BATTERIE****(Le voyant limiteur de tours est allumé avec le moteur courant)**



3.1. Description générale de la moto

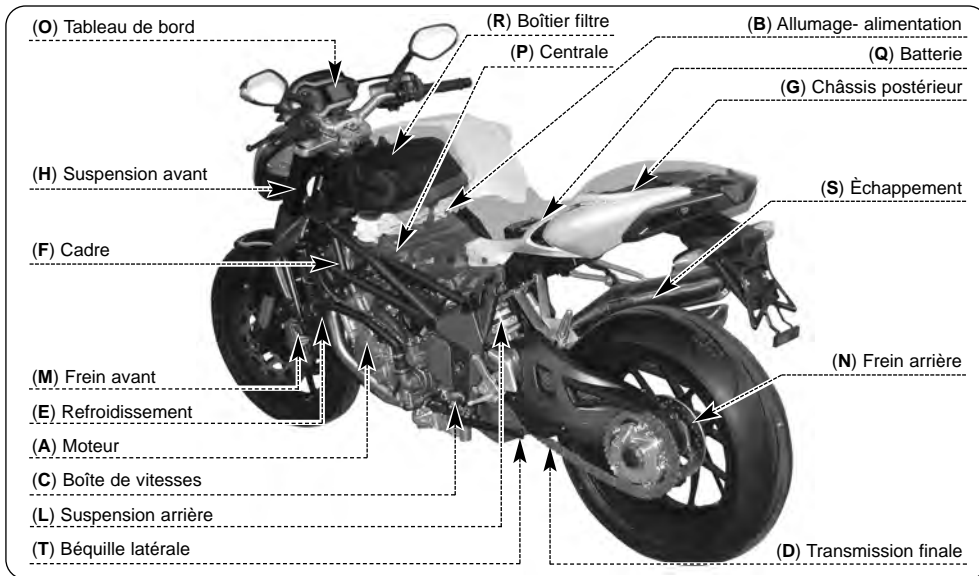



- A - Moteur:** quatre temps, quatre cylindres en ligne. Distribution par double arbre à cames en tête avec soupapes radiales. Graissage à carter humide.
- B - Allumage - alimentation:** Système intégré d'allumage - injection. Allumage électronique à décharge inductive. Injection électronique "Multipoint".
- C - Boîte de vitesses:** du type extractible, à six rapports avec pignons en prise constante.
- D - Transmission finale:** composée de pignon, couronne et chaîne.
- E - Refroidissement:** à liquide et huile avec radiateurs séparés.
- F - Cadre:** à treillis, en tube d'acier, avec plaques latérales en aluminium.
- G - Châssis postérieur:** à treillis, en tubes d'acier.
- H - Suspension avant:** fourche oléodynamique à tubes inversés, équipée d'un système extérieur de réglage.
- L - Suspension arrière:** à action progressive avec monobras oscillant et monoamortisseur équipé d'un système extérieur de réglage.
- M - Frein avant:** double disque semi-flottant avec étriers radiaux à quatre pistons.
- N - Frein arrière:** un seul disque avec étrier à quatre pistons.
- O - Tableau de bord:** équipé de voyants lumineux et d'appareillage analogique et digital.
- P - Centrale:** avec le contrôle électronique du système intégré d'allumage-injection.
- Q - Batterie:** scellée et sans entretien.
- R - Boîtier filtre:** équipé de système de filtrage du flux d'air d'aspiration du moteur.
- S - Échappement:** équipé de convertisseur catalytique pour la réduction des émissions d'échappement.
- T - Béquille latérale:** avec interrupteur de sûreté et double ressort de rappel.



3.1.1 Circuit de frein avant

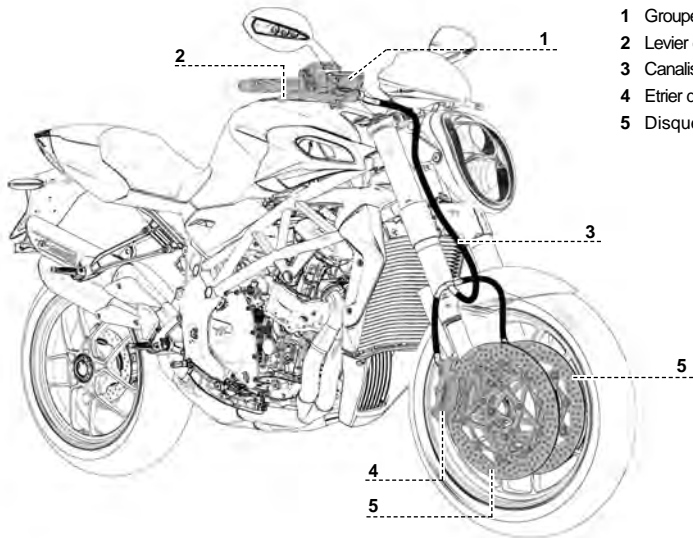

- 1 Groupe maître-cylindre
- 2 Levier de frein
- 3 Canalisation de frein
- 4 Etrier de frein
- 5 Disques de frein



3.1.2. Circuit de frein arrière

FR 3

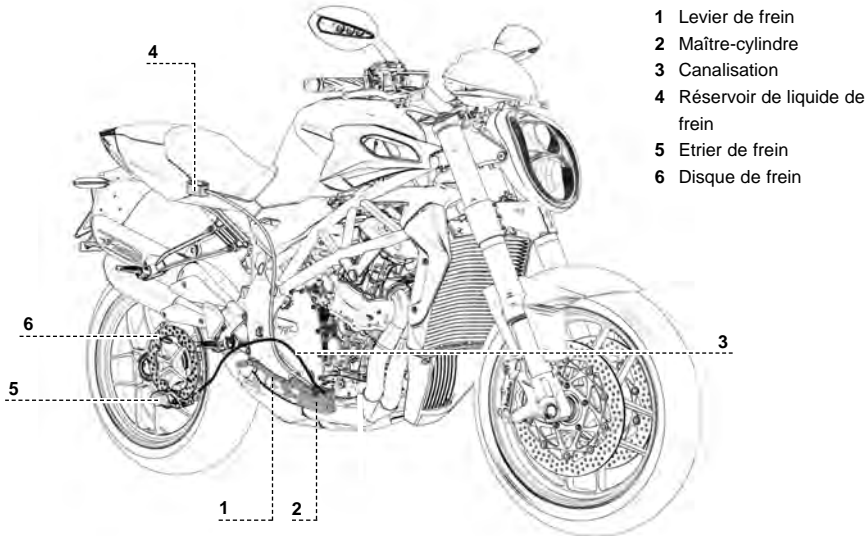



3.1.3. Circuit d'embrayage

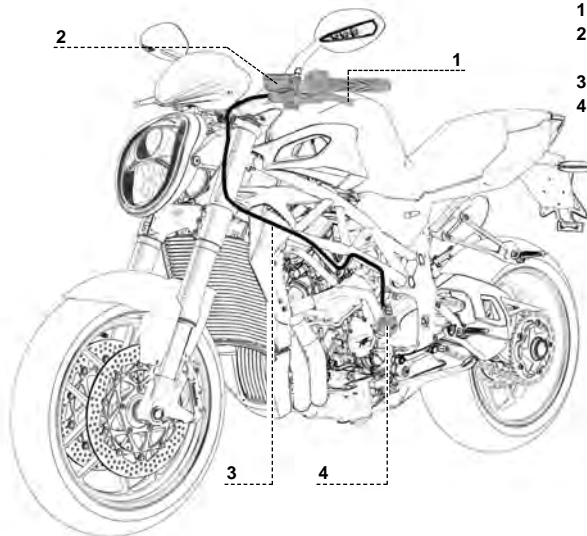

- 1 Levier d'embrayage
- 2 Groupe maître-cylindre d'embrayage
- 3 Canalisation
- 4 Groupe cylindre de débrayage



3.1.4. Graissage du moteur

FR 3

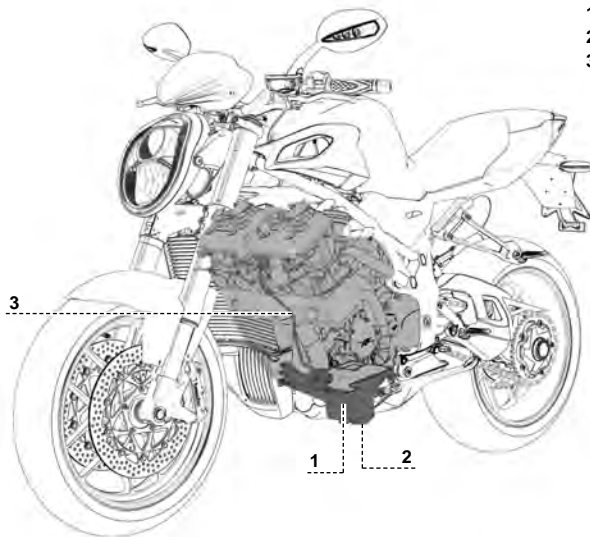

- 1 Carter d'huile
- 2 Filtre à huile
- 3 Canalisation de refoulement de l'huile à la culasse



3.1.5. Circuit de refroidissement

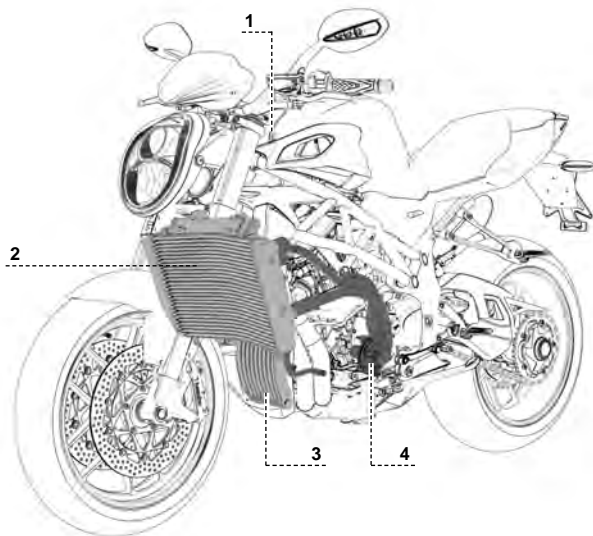

- 1 Vase d'expansion
- 2 Radiateur supérieur
- 3 Radiateur inférieur
- 4 Pompe de liquide



3.1.6. Circuit d'alimentation

FR 3

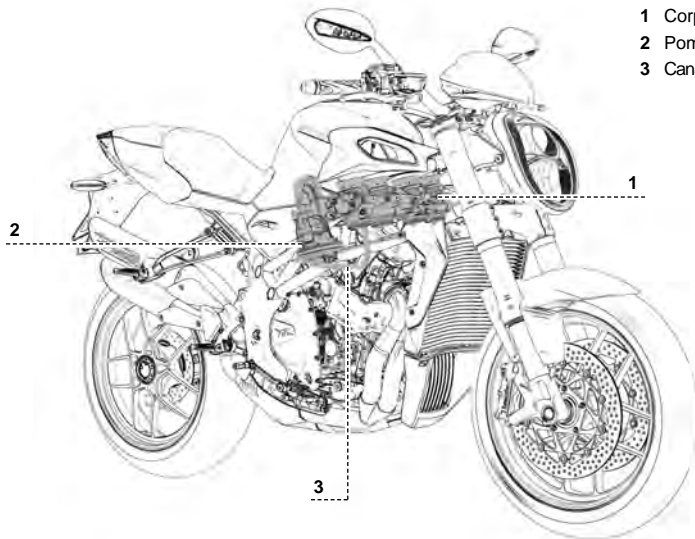

- 1 Corps de papillon
- 2 Pompe à carburant
- 3 Canalisation de carburant

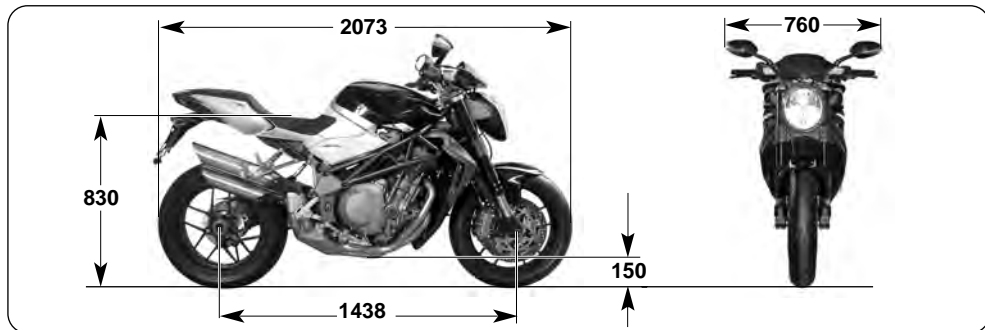

3.2. Données techniques

Description	BRUTALE 1090 RR
CARACTÉRISTIQUES	
Empattement (mm) (*)	1438
Longueur hors tout (mm) (*)	2073
Largeur hors tout (mm)	760
Hauteur de selle (mm) (*)	830
Garde au sol (mm) (*)	150
Chasse (mm) (*)	103,5

* : Les valeurs déclarées sont sans engagement. Elles sont susceptibles de variations en fonction des conditions d'assiette du véhicule.



Données techniques

Description	BRUTALE 1090 RR
Poids à vide (Kg)	190
Contenance du réservoir carburant (lt) (*)	19
Réserve de carburant (lt) (*)	4
Qté d'huile dans l'embase (Kg)	3,5
MOTEUR	
Type	Quatre cylindres 4 temps, 16 soupapes
Alésage (mm)	79,0
Course (mm)	55,0
Cylindrée totale (cm ³)	1078
Rapport de compression	13 :1
Démarreur	Electrique
Refroidissement	À liquide et huile avec radiateurs séparés
Carter moteur et couvercles	Moulés sous pression
Culasse et cylindres	Moulés en coquille
Soupapes	Bimétalliques / monométalliques
DISTRIBUTION	
Type	Double arbre à cames en tête, soupapes radiales

* : Les valeurs déclarées sont sans engagement. Elles sont susceptibles de variations en fonction de la température extérieure, de la température du moteur et du point d'évaporation de l'essence utilisée.



Données techniques

Description	BRUTALE 1090 RR
GRAISSAGE	
Type	A carter humide
ALLUMAGE – ALIMENTATION	
Type	Système de d'allumage-injection Magneti Marelli 5.SM avec corps papillon Mikuni. Allumage électronique à décharge inductive. Injection électronique "Multipoint" séquentielle a phase complète.
Bougies	NGK CR9 EB
Ecartement des électrodes (mm)	0.7 ÷ 0.8
EMBRAYAGE	
Type	Multidisque en bain d'huile
TRANSMISSION PRIMAIRE	
Nombre de dents du pignon de vilebrequin	Z = 50
Nombre de dents du pignon d'embrayage	Z = 79
Rapport de transmission	1.58
TRANSMISSION SECONDAIRE	
Nombre de dente du pignon	Z = 15
Nombre de dents de la couronne	Z = 41
Rapport de transmission	2.73
BOITE DE VITESSES	
Type	Extractible à six vitesses avec pignons en prise constante



Données techniques

Description	BRUTALE 1090 RR
Rapports boîte de vitesses (rapports totaux)	
Première	2.92 (12.59)
Seconde	2.12 (9.14)
Troisième	1.78 (7.68)
Quatrième	1.50 (6.47)
Quinquième	1.32 (5.69)
Sixième	1.21 (5.22)
CADRE	
Type	Tube à tresse en acier 25 CrMo (soudé en TIG)
Plaque d'ancrage du bras oscillant	Alliage d'aluminium
SUSPENSION AVANT	
Type	Fourche oléodynamique à tubes inversés avec système de réglage extérieur et séparé du freinage en détente, compression et de la précharge du ressort
Ø des tubes (mm)	50
Course sur l'axe des jambes (mm)	125
SUSPENSION ARRIÈRE	
Type	Progressive, monoamortisseur réglable en extension, en compression (Haute vitesse/Basse vitesse) et dans la précharge ressort
Bras oscillant	Alliage d'aluminium
Course de la roue (mm)	120



Données techniques

Description	BRUTALE 1090 RR
FREIN AVANT	
Type	A double disque flottant avec bande freinante en acier
Ø disque (mm)	310
Plateau de frein	Acier
Etriers (diamètre des pistons mm)	Radial monobloc a 4 pistons (Ø 34)
FREIN ARRIÈRE	
Type	A disque en acier
Ø disque (mm)	210
Etrier (diamètre des pistons mm)	A 4 pistons de (Ø 25.4)
JANTE AVANT	
Matériau	Alliage d'aluminium
Dimension	3.50" x 17"
JANTE ARRIÈRE	
Matériau	Alliage d'aluminium
Dimension	6.00" x 17"
PNEUMATIQUES	
Avant	120/70-ZR 17 (58 W)
Arrière	190/55-ZR 17 (75 W)
Marque et type	DUNLOP - Sport Max Qualifier RR PIRELLI - Dragon Supercorsa Pro



Données techniques

Description	BRUTALE 1090 RR
Pression de gonflage (*):	
Avant	2.3 bar (33 psi)
Arrière	2.3 bar (33 psi)
ÉQUIPEMENT ÉLECTRIQUE	
Tension du circuit	12 V
Feu de croisement avant	12 V - 55 W
Feu de route avant	12 V - 55 W
Feu de position arrière	12 V - 5 W
Batterie	12 V - 8 Ah
Alternateur	350 W a 5000 tr/mn
CARROSSERIE	
Réservoir	Matière thermoplastique
Convoyeurs air-box	Matière thermoplastique
Flancs réservoir	Matière thermoplastique
Flancs arrières queue	Matière thermoplastique
Queue	Aluminium
Protection tuyau d'échappement	Matière thermoplastique

*: Dans le cas de pneus d'une autre marque que celle préconisée, se référer à la valeur de pression de gonflage marquée par le constructeur sur le flanc du pneumatique.

**Données techniques**

Description	BRUTALE 1090 RR
Couvercle interrupteur d'allumage	Matière thermoplastique
Garde-boue avant	Matière thermoplastique
Protections chaîne	Matière thermoplastique
Protection radiateur huile	Matière thermoplastique
Support de plaque d'immatriculation	Matière thermoplastique
Rétroviseurs	Matière thermoplastique
Protection tuyau d'échappement	Aluminium



FR 3





3.3. Référence couleurs des superstructures

Les parties peintes des superstructures présentent les couleurs suivantes en fonction du code couleur respectif de la moto:

1. - Flanc arrière droit;
2. - Flanc arrière gauche;
3. - Panneau latéral réservoir droit;
4. - Panneau latéral réservoir gauche:

Codes couleur A-D-F:

Argent F4 AGO (Réf. Palinal 928XV025)

Codes couleur B-E:

Blanc Nacré CRC (Réf. Palinal 927.PE20)

Code couleur C:

Anthracite métallisé "Senna" (Réf. PPG GM WA9561)

5. - Garde-boue avant;
6. - Panneaux latérales airbox:

Codes couleur A-D:

Rouge F4 AGO (Réf. Palinal 926R750)

Codes couleur B-C-E:

Noir intense CRC (Réf. Palinal 929R486H)

Code couleur F:

Gris Titanium (Réf. Palinal L821)

7. - Réservoir:

Codes couleur A-D:

Rouge F4 AGO (Réf. Palinal 926R750) +

Argent F4 AGO (Réf. Palinal 928XV025)

Codes couleur B-E:

Noir intense CRC (Réf. Palinal 929R486H) +

Blanc Nacré CRC (Réf. Palinal 927.PE20)

Code couleur C:

Noir intense CRC (Réf. Palinal 929R486H) +

Anthracite métallisé "Senna" (Réf. PPG GM WA9561)

Code couleur F:

Gris Titanium (Réf. Palinal L821) +

Argent F4 AGO (Réf. Palinal 928XV025)

8. - Protection droit de radiateur;
9. - Protection gauche de radiateur;
10. - Couvercle tablar du bord;

Gris Carbon métallisé (Réf. Palinal L921)



FR 3





3.4. Référence couleurs composants du châssis et de la partie cycle

Les parties peintes du châssis et de la partie cycle de la moto présentent les couleurs de référence suivantes:

1. - Cadre:

Codes couleur A-B-C:

Bronze mat B5

(Réf. Palinal 211F297)

Codes couleur D-E:

Gris Anthracite métallisé MV

(Réf. Palinal 211XH893)

Code couleur F:

Rouge Cadre

(Réf. Palinal 211XH987)

2. - Support projecteur:

Codes couleur A-B-C:

Bronze mat B5 (Réf. Palinal 211F297)

Codes couleur D-E-F:

Gris Anthracite métallisé MV

(Réf. Yi-Mei AC MAT Black Silver)

3. - Moteur:

Noir mat (Réf. Pulverit 3500/0085)

4. - Queue;

5. - Socle de direction:

Gris Carbon métallisé

(Réf. Palinal L921)

6. - Fulcrum plaque bras oscillant droit;

7. - Fulcrum plaque bras oscillant gauche;

8. - Fourche arrière:

Gris Carbon métallisé

(Réf. Akzo Nobel RPU MIC 09 BP 1663/5)

9. - Support repose-pieds arrière droit;

10. - Support repose-pieds arrière gauche:

Gris aluminium fin métallisé

(Réf. Palinal F444)



Note d'information

MV Agusta S.p.A. poursuit une politique de continuelle amélioration de ses produits. Pour cette raison, de légères différences pourraient éventuellement se présenter entre les informations de ce livret et le véhicule que vous avez acheté. Les modèles MV Agusta s'exportent dans de nombreux pays où des normes différentes sont en vigueur en ce qui concerne le Code de la Route et les procédures d'homologation. En espérant pouvoir compter sur votre compréhension, il est indispensable à MV Agusta S.p.A. de se réserver le droit d'apporter des modifications à ses produits et à la documentation technique à tout moment sans fournir de préavis.

Nous suggérons de visiter souvent le site Internet www.mvagusta.it afin d'obtenir des informations et des mises à jour sur les produits MV Agusta et la documentation relative.



Respectons et défendons l'environnement

Toutes nos actions ont des répercussions sur la planète entière et sur ses ressources.

MV Agusta, au profit des intérêts de tous, sensibilise les Clients et les opérateurs du service après-vente pour leur faire adopter des modalités d'utilisation du véhicule et de traitement de ses parties dans le respect des normes en vigueur en terme de pollution, traitement et recyclage des déchets.

© 2010

Toute reproduction même partielle de ce document est formellement interdite sans autorisation écrite de MV Agusta S.p.A.

Part. n° 8000B3379

Edition n° 2 - Juillet 2010



BRUTALE

1090

MV AGUSTA



Wartungsanleitung
Deutsche Version



ALLGEMEINES INHALTSVERZEICHNIS

<i>Kap.</i>	<i>Inhalt</i>	<i>Seite</i>
1	WARTUNG	3
1.1.	Zeichenerklärung	3
1.2.	Tabelle Wartungs- und Kontrollarbeiten	4
1.3.	Mitgeliefertes Bordwerkzeug und Zubehör	14
1.4.	Schmiermitteltabelle	15
1.5.	Motoröl - Ölstandkontrolle	16
1.5.1.	Nachfüllen von Motoröl	17
1.6.	Kühlflüssigkeit - Kontrolle Kühlflüssigkeitsstand	19
1.6.1.	Kühlflüssigkeit - Nachfüllen von Kühlflüssigkeit	20
1.7.	Bremsbeläge - Kontrolle Abnutzung/ Verschleiß	22
1.8.	Bremsflüssigkeit -Kontrolle Bremsflüssigkeitsstand	23
1.9.	Flüssigkeit Kupplungsbetätigung -Kontrolle Flüssigkeitsstand	25
1.10.	Reifen - Kontrolle und Wechsel	26
1.11.	Kette - Kontrolle und Schmieren	32
1.12.	Leerlaufdrehzahl - Kontrolle	36
1.13.	Auswechseln - Allgemeine Informationen	37
1.13.1.	Sicherungen - Auswechseln	37
1.13.2.	Fahrlicht - Auswechseln der Birne	40
1.13.3.	Fernlicht - Auswechseln der Birne	43

<i>Kap.</i>	<i>Inhalt</i>	<i>Seite</i>
1.13.4	Vorderes Standlicht -Auswechseln der Birne	44
1.14.	Batterie	45
1.15.	Fahrzeugpflege	47
1.16.	Längeres Stilllegen	50
2	STÖRUNGEN	51
2.1.	Störungen am Motor	51
2.2.	Störungen an der elektrischen Anlage	56
3	TECHNISCHE INFORMATIONEN	59
3.1.	Allgemeine Beschreibung des Motorrads	59
3.1.1.	Bremskreislauf Vorderradbremse	61
3.1.2.	Bremskreislauf Hinterradbremse	62
3.1.3.	Kupplungskreislauf	63
3.1.4.	Motorschmierung	64
3.1.5.	Kühlkreislauf	65
3.1.6.	Benzin-Versorgungskreislauf	66
3.2.	Technische Daten	67
3.3.	Überbau - Farbkennziffern	75
3.4.	Rahmen- und Radfahrteile Farbkennziffern	77



1.1. Zeichenerklärung

Besonders wichtige Textstellen die sich auf die Sicherheit der Personen oder des Fahrzeugs beziehen, sind mit folgenden Symbolen gekennzeichnet:



Gefahr - Achtung: Die mangelnde oder unvollständige Beachtung dieser Vorschriften stellt eine schwere Unfallgefahr für den Arbeiter oder Dritte dar.



Vorsicht - Vorsichtsmaßnahme: Die Nichteinhaltung der Anweisungen kann schwere und dauerhafte Schäden am Fahrzeug verursachen.

Folgende Symbole werden benutzt, um anzuzeigen, wer die angegebenen Wartungs- und Einstellungsarbeiten ausführen darf:



Informationen zu Arbeiten, die vom Motorradfahrer ausgeführt werden dürfen.



Informationen zu arbeiten, die ausschließlich von ausgebildetem Fachpersonal ausgeführt werden dürfen.

Um weitere Informationen hervorzuheben, werden folgende Symbole verwendet:



Das Symbol zeigt an, dass für die richtige Durchführung der angegebenen Arbeit ein Spezialwerkzeug oder Sonderausrüstung benötigt werden.



Das Zeichen “§” gefolgt von einer Ziffer verweist auf das entsprechende Kapitel.



1.2. Tabelle Wartungs- und Kontrollarbeiten

Die wichtigsten Wartungs- und Kontrollarbeiten sowie deren zeitlicher Abstand sind in den entsprechenden Tabellen aufgeführt. Um das Motorrad funktionsfähig und sicher zu halten, müssen die angegebenen unbedingt Arbeiten ausgeführt werden.

Die angegebenen Zeitabstände für die Wartungsarbeiten haben allgemeinen Charakter und gelten für einen Einsatz des Fahrzeugs unter normalen Bedingungen. Abhängig von Wetterbedingungen, Straßenzustand, geografischen Voraussetzungen und persönlichem Einsatz des Fahrzeugs müssen die angegebenen Zeitabstände unter Umständen verkürzt werden.

Einige dieser Arbeiten können vom Fahrzeughalter selbst ausgeführt werden, sofern er über die entsprechenden Fähigkeiten und Kenntnisse verfügt. Andernfalls müssen diese Arbeiten vom Kundendienst vorgenommen werden.

Für die Wartungsarbeiten muß das Motorrad auf den hinteren Ständer gestellt, der Motor abgeschaltet und der Zündschlüssel auf "OFF" gestellt werden. Zur Kontrolle der Flüssigkeitsstände sollte das Fahrzeug ohne auf den hinteren Ständer zu stellen senkrecht gehalten werden.

Nach 36.000 km (22.400 mile) müssen die Arbeiten in den gleichen Abständen wie in der Tabelle angegeben ausgeführt werden.



ACHTUNG

- Eine falsche Wartung oder die Nichtausführung der empfohlenen Wartungsarbeiten erhöht das Unfallrisiko und die Gefahr einer Beschädigung des Motorrads.
- Ausschließlich Original MV Agusta Ersatzteile verwenden. Der Einsatz nicht originaler Ersatzteile kann zu vorzeitigem Verschleiß führen und verkürzt die Lebenszeit des Motorrads.
- Bei Nichtausführung der empfohlenen Wartungsarbeiten aus dem Wartungsprogramm oder bei Verwendung nicht originaler Ersatzteile konnte die Garantie veranlassen, unzulässig zu sein.
- Der Wechsel bzw. das Auffüllen von Schmiermitteln oder anderen Flüssigkeiten darf nur mit den in § 1.4. angegebenen Produkten erfolgen.



ACHTUNG

Vor und nach dem Befahren einer Rennstrecke sollten Sie Ihr Motorrad unbedingt von einem Fachmann in einer MV Agusta-Vertragswerkstatt überprüfen lassen. Das Fahren auf Rennstrecken sollte jedoch eine Ausnahme darstellen und niemals im Rahmen eines Profi- oder Amateur-Wettkampfes stattfinden. Der Einsatz auf einer Rennstrecke bedeutet für das Motorrad eine wesentlich stärkere Abnutzung der diversen Komponenten und verkürzt demnach auch deren Lebensdauer im Vergleich zur normalen Benutzung auf Straßen und Autobahnen.



Tabelle programmierte Wartungsarbeiten

Häufigkeit der Wartungsarbeiten km (mi)		0	1000 (600)	6000 (3800)	12000 (7500)	18000 (11200)	24000 (14900)	30000 (18600)	36000 (22400)
Coupon		Vor Auslieferung	A	B	C	D	E	F	G
BESCHREIBUNG		ARBEIT							
Motoröl		Ölstandkontrolle	Vor jedem Fahrtantritt						
		Ölwechsel	•	•	•	•	•	•	•
			Mindestens einmal jährlich						
Motorölfilter		Wechsel (Ausschließlich Original MV Agusta Motorölfilter verwenden)	•	•	•	•	•	•	•
				Bei jedem Ölwechsel					
Kühlfüssigkeit		Kontrolle / Auffüllen	Vor jedem Fahrtantritt						
		Kontrolle / Auffüllen	•	•	•	•	•	•	•
		Wechsel	Alle zwei Jahre						
Kühlanlage		Kontrolle Lecks	•	•	•	•	•	•	•
Gebälse		Funktionskontrolle	•	•	•	•	•	•	•
Ventile		Kontrolle/Einstellung			•		•		•
Kette Ventilsteuerung		Kontrolle			•		•		
		Austausch							•



Tabelle programmierte Wartungsarbeiten

Häufigkeit der Wartungsarbeiten km (mi)		0	1000 (600)	6000 (3800)	12000 (7500)	18000 (11200)	24000 (14900)	30000 (18600)	36000 (22400)	
Coupon		Vor Auslieferung	A	B	C	D	E	F	G	
BESCHREIBUNG		ARBEIT								
Bewegliche Führung der Ventilsteuerkette		Kontrolle / Austausch			●		●			
		Wechsel							●	
			Bei jedem Austausch der Ventilsteuerkette							
Kettenspanner Ventilsteuerung		Kontrolle / Austausch			●		●		●	
Zündkerzen		Kontrolle / Austausch		●		●		●		
		Wechsel			●		●		●	
Benzinfilter		Kontrolle / Austausch			●		●		●	
Vergaser		Kontrolle und Einstellung		●	●	●	●	●	●	
Luftfilter		Kontrolle / Austausch			●	●	●	●	●	
Bremsflüssigkeit und Kupplung		Kontrolle Flüssigkeitsstand	Vor jedem Fahrtantritt							
		Kontrolle Flüssigkeitsstand	●	●	●	●	●		●	●
		Wechsel						●		
			Mindestens alle zwei Jahre							





Tabelle programmierte Wartungsarbeiten

Häufigkeit der Wartungsarbeiten km (mi)		0	1000 (600)	6000 (3800)	12000 (7500)	18000 (11200)	24000 (14900)	30000 (18600)	36000 (22400)
Coupon		Vor Auslieferung	A	B	C	D	E	F	G
BESCHREIBUNG	ARBEIT								
Bremsen/ Kupplung	Funktionskontrolle	Vor jedem Fahrtantritt							
	Reinigung der Berührungsfläche zwischen Hebel / Hauptzylinderkolben	Alle 500 ÷ 1.000 km (300 ÷ 600 mile)							
	Funktionskontrolle	●	●	●	●	●	●	●	●
	Kontrolle Bremskreislauf	●	●	●	●	●	●	●	●
Bremsbeläge (vorne und hinten)	Reinigung der Berührungsfläche zwischen Hebel / Hauptzylinderkolben	●	●	●	●	●	●	●	●
	Abnutzungskontrolle	Alle 1.000 km (600 mile)							
Benzinleitungen	Kontrolle / Austausch		●	●	●	●	●	●	●
	Auf Beschädigungen und Lecks überprüfen		●	●	●	●	●	●	●
Gasgriff	Austausch	Alle 3 Jahre							
	Funktionskontrolle	Vor jedem Fahrtantritt							
	Funktionskontrolle	●	●	●	●	●	●	●	●
Starterzung	Prüfen/ Spiel einstellen	●	●	●	●	●	●	●	●
	Funktionskontrolle	●	●	●	●	●	●	●	●



Tabelle programmierte Wartungsarbeiten

Häufigkeit der Wartungsarbeiten km (mi)		0	1000 (600)	6000 (3800)	12000 (7500)	18000 (11200)	24000 (14900)	30000 (18600)	36000 (22400)
Coupon		Vor Auslieferung	A	B	C	D	E	F	G
BESCHREIBUNG	ARBEIT								
Chokehebel		●	●	●	●	●	●	●	●
Bowdenzüge		●	●	●	●	●	●	●	●
Antriebskette 		Alle 1.000 km (600 mile)							
		Alle 1.000 km (600 mile) und nach Fahrten bei Regen							
		●	●	●	●	●	●	●	●
			●	●		●		●	
Ritzel/ Sprengring			●	●		●		●	
					●		●		●
	Bei jedem Wechsel der Antriebskette								
Zahnkranz			●	●		●		●	
					●		●		●
	Bei jedem Wechsel der Antriebskette								





Tabelle programmierte Wartungsarbeiten

Häufigkeit der Wartungsarbeiten km (mi)		0	1000 (600)	6000 (3800)	12000 (7500)	18000 (11200)	24000 (14900)	30000 (18600)	36000 (22400)	
Coupon		Vor Auslieferung	A	B	C	D	E	F	G	
BESCHREIBUNG		ARBEIT								
Zahnkranz-Reißschutz		Kontrolle / Austausch			●		●		●	
Gewindering am Lenkrohr		Kontrolle/ Einstellung	●		●		●		●	
Lenklager		Kontrolle / Einstellung	●		●		●		●	
		Schmieren					●			
Reifen		Kontrolle Reifendruck	Vor Fahrtantritt, mindestens alle 10 Tage							
		Kontrolle Abnutzung	Vor Fahrtantritt, mindestens alle 500 km (300 mi)							
		Kontrolle Reifendruck	●	●	●	●	●	●	●	●
		Kontrolle Abnutzung		●	●	●	●	●	●	●
Radfelgen		Sichtkontrolle								
			Bei jedem Reifenwechsel							
Vorderradlager		Kontrolle								
			Bei jedem Reifenwechsel							
		Austausch								●



Tabelle programmierte Wartungsarbeiten

Häufigkeit der Wartungsarbeiten km (mi)		0	1000 (600)	6000 (3800)	12000 (7500)	18000 (11200)	24000 (14900)	30000 (18600)	36000 (22400)
Coupon		vor Auslieferung	A	B	C	D	E	F	G
BESCHREIBUNG	ARBEIT								
Seitenständer	Funktionskontrolle	Vor jedem Fahrtantritt							
	Funktionskontrolle	●	●	●	●	●	●	●	●
Seitenständerschalter	Funktionskontrolle	Vor jedem Fahrtantritt							
	Reinigung der Berührungsfläche mit Seitenständer	Alle 500 ÷ 1.000 km (300 ÷ 600 mile)							
	Funktionskontrolle	●	●	●	●	●	●	●	●
Hintere Radnabe	Kontrolle / Schmierens der Rollenbehälter				●		●		
	Austausch / Schmierens der Rollenbehälter								●
Gabellager	Kontrolle / Schmierens								●
Kettenführung an der Schwinge	Kontrolle / Austausch		●	●	●	●	●	●	●
Kettenführung am Rahmenblech	Kontrolle / Austausch		●	●	●	●	●	●	●
Hinterer Stoßdämpfer	Kontrolle / Einstellung		●		●		●		●
Vorderrad-Gabelöl	Austausch						●		



DE 1

Tabelle programmierte Wartungsarbeiten

Häufigkeit der Wartungsarbeiten km (mi)		0	1000 (600)	6000 (3800)	12000 (7500)	18000 (11200)	24000 (14900)	30000 (18600)	36000 (22400)
Coupon		Vor Auslieferung	A	B	C	D	E	F	G
BESCHREIBUNG	ARBEIT								
Batterieanschlüsse	Kontrolle und Reinigung		●	●	●	●	●	●	●
Elektrische Anlage	Funktionskontrolle	●	●	●	●	●	●	●	●
Instrumente	Funktionskontrolle	Vor jedem Fahrtantritt							
	Funktionskontrolle	●	●	●	●	●	●	●	●
Beleuchtung/Blinker	Funktionskontrolle / Auswechseln der Birne	Vor jedem Fahrtantritt							
	Funktionskontrolle / Auswechseln der Birne	●	●	●	●	●	●	●	●
Hupe	Funktionskontrolle	Vor jedem Fahrtantritt							
	Funktionskontrolle	●	●	●	●	●	●	●	●
Scheinwerfer	Funktionskontrolle	Vor jedem Fahrtantritt							
	Einstellung	Bei jeder Änderung an der Fahrzeigrimmung und jeder Gebrauch mit dem Passagier							
	Funktionskontrolle	●	●	●	●	●	●	●	●
Zündschloß	Funktionskontrolle	Vor jedem Fahrtantritt							
	Funktionskontrolle	●	●	●	●	●	●	●	●





Tabelle programmierte Wartungsarbeiten



Häufigkeit der Wartungsarbeiten km (mi)		0	1000 (600)	6000 (3800)	12000 (7500)	18000 (11200)	24000 (14900)	30000 (18600)	36000 (22400)	
Coupon		Vor Aus- lieferung	A	B	C	D	E	F	G	
BESCHREIBUNG		ARBEIT								
Schlösser		Funktionskontrolle	Vor jedem Fahrtantritt							
		Funktionskontrolle	●	●	●	●	●	●	●	●
Festziehen von Schrauben und Muttern		Kontrolle/ Festziehen	●	●	●	●	●	●	●	●
Schlauschellen		Kontrolle/ Festziehen	●	●	●	●	●	●	●	●
Allgemeines Schmieren			●	●	●	●	●	●	●	●
Abnahme Motorrad			●	●	●	●	●	●	●	●





1.3. Mitgeliefertes Bordwerkzeug und Zubehör

Im Staufach befindet sich eine Werkzeugtasche mit folgendem Inhalt:

- 1 Sechskantstab (Sechskant 10 mm);
- 6 Inbusschlüssel (Sechskant 2,5-3-4-5-6-8 mm);
- 1 Exzentrerschlüssel für Hinterrad mit Verlängerung;
- 1 Abzieher für Minisicherungen;
- 3 Sicherungen (5A - 7,5A - 15A).

Weiterhin wird folgendes Zubehör mitgeliefert:

- 1 Zündkerzenschlüssel (Sechskant 16 mm);
- 1 Dokumentenmappe.





1.4. Schmiermitteltabelle

Beschreibung	Empfohlenes Produkt	Technische Angaben
Motoröl	AGIP RACING 4T 10W/60 (*)	SAE 10W/60 - API SJ
Kühlflüssigkeit	AGIP ECO - PERMANENT	Glykolethylen mit 50% destilliertem Wasser verdünnt
Brems- und Kupplungsflüssigkeit	AGIP BRAKE FLUID DOT4	DOT4
Kettenöl	MOTUL CHAIN LUBE ROAD	–

* : Damit Sie die empfohlenen Produkte finden und kaufen können, empfiehlt Ihnen MV Agusta sich direkt an die autorisierten Vertragshändler zu wenden. Das Motoröl AGIP Racing 4T 10W/60 wurde speziell für den Motor des Motorrads Brutale entwickelt. Steht das empfohlene Schmiermittel nicht zu Verfügung, rät MV Agusta zum Gebrauch vollständig synthetischer Öle, die die gleichen oder bessere Eigenschaften als folgende Normen haben:

- Konform API SJ
- Konform ACEA A3
- Konform JASO MA
- Grad SAE 20 W-50 oder 10 W-60

ANMERKUNG

Die o. a. Spezifizierungen müssen entweder allein oder zusammen mit anderen auf dem Behälter des Motoröl aufgedruckt sein.





1.5. Motoröl - Ölstandkontrolle

Die Ölstandkontrolle muß bei kaltem und abgestelltem Motor vorgenommen werden. Bei warmem Motor muß der Motor seit mindestens zehn Minuten abgestellt sein.

Bei der Ölstandkontrolle muss das Fahrzeug auf einem ebenen Untergrund in Fahrtrichtung (senkrecht) stehen.

Der Ölstand muß zwischen den Zeichen MAX und MIN am Gehäuse liegen.

Liegt der Ölstand unterhalb der Markierung "MIN", muss Öl nachgefüllt werden (siehe § 1.5.1).



Gefahr - Achtung: Niemals den Motor starten, wenn der Ölstand unter Minimum ist.

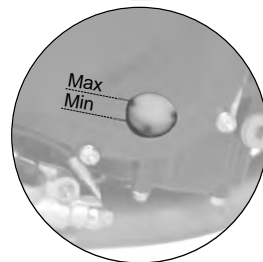



1.5.1. Nachfüllen von Motoröl

Zum Nachfüllen den Motorölstopfen abschrauben, indem Sie den 10mm-Sechskantstab verwenden, zusammgebaut auf einem korrekten Schlüssel (siehe Abbildung). Die nötige Ölmenge bis zum Erreichen des korrekten Einfüllstand einfüllen; in jedem Fall nie das angegebene MAX-Zeichen überschreiten. Am Ende den Motorölstopfen fest schließen.



ACHTUNG

Bevor Sie den Ölverschluss wieder zusammenbauen, fetten Sie seinen O-Ring, indem Sie AGIP Grease 30 verwenden.

Schließlich führen Sie das Festziehen des Ölverschlusses an die Anzugsmoment von 35 Nm durch, indem Sie einen Momentenschlüssel verwenden.

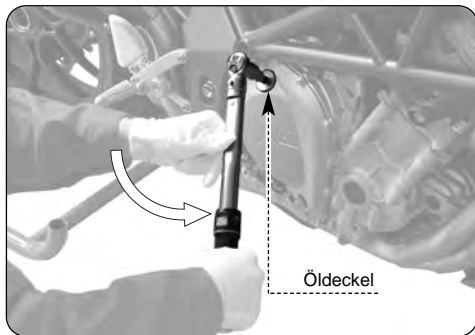

VORSICHT

Um ein Rutschen der Kupplung und eine Beschädigung des Motors zu vermeiden, niemals chemische Ölzusätze oder ein anderes als das in § 1.4. angegebene Öl verwenden. Sicherstellen, dass beim Nachfüllen keine Fremdkörper in das Motorgehäuse gelangen.

**ACHTUNG**

Frischöl und Altöl können gefährlich sein. Die Einnahme von Frischöl und Altöl ist für Personen und Haustiere gefährlich. Bei Einnahme von Motoröl sofort einen Arzt benachrichtigen und kein Erbrechen auslösen, um ein Einatmen des Produktes in die Lungen zu vermeiden. Ein ständiger Kontakt mit Motoröl kann Hautkrebs verursachen. Ein kurzer Kontakt mit Motoröl kann Hautreizungen verursachen.

- Frischöl und Altöl von Kindern und Haustieren fernhalten.
- Beim Nachfüllen von Motoröl langärmelige Kleidung und wasserundurchlässige Schutzhandschuhe anziehen.
- Bei Hautkontakt mit Motoröl die betroffenen Stellen mit reichlich Wasser und Seife waschen.
- Das Altöl muss entsprechend der gesetzlichen Vorschriften entsorgt oder recycelt werden.



1.6. Kühlflüssigkeit - Kontrolle Kühlflüssigkeitsstand

Die Kontrolle des Kühlflüssigkeitsstands muß bei kaltem und abgestelltem Motor vorgenommen werden. Bei der Kontrolle des Kühlflüssigkeitsstands muss das Fahrzeug auf einem ebenen Untergrund in Fahrtrichtung (senkrecht) stehen.

Der Kühlflüssigkeitsstand muß zwischen der MIN Markierung und der untereren Seite des Rahmenschlauches liegen, wie in der Abbildung gezeigt.

Liegt der Kühlflüssigkeitsstand unterhalb der Markierung "MIN", muss Kühlflüssigkeit nachgefüllt werden (siehe § 1.6.1).



ACHTUNG

Das Motorrad auf keinen Fall nutzen, wenn der Kühlflüssigkeitsstand unter der Markierung MIN liegt.

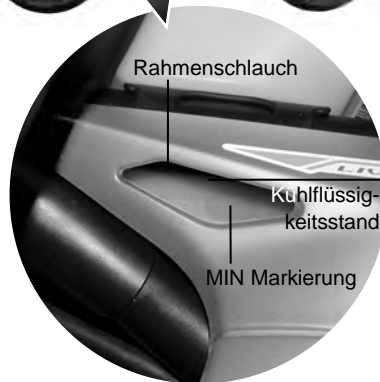



DE 1

1.6.1. Kühlflüssigkeit - Nachfüllen von Kühlflüssigkeit

Zur Abschraubung des Stopfen die Befestigungsschrauben des Deckels lösen und Deckel abheben.

Den Deckel abschrauben und die in § 1.4. angegebene Kühlflüssigkeit einfüllen.

Kühlflüssigkeitseinfüllstopfen

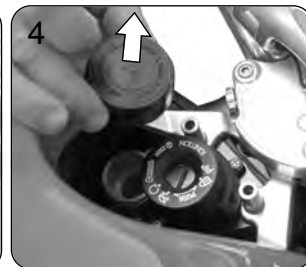
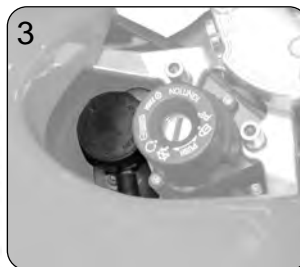
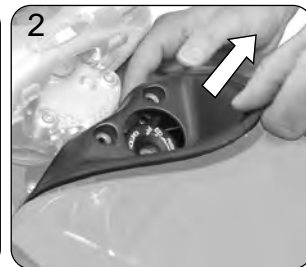
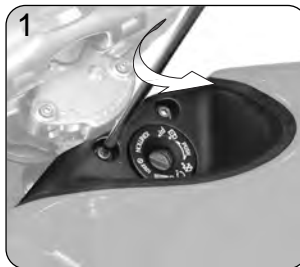

Nach dem Auffüllen die vorher abgebauten Teile sorgfältig wieder anbauen.



ACHTUNG: Die Kühlflüssigkeit darf nur bei kaltem Motor nachgefüllt werden. Um Verbrühungsgefahr zu vermeiden, niemals den Deckel aufschrauben, solange der Motor noch warm ist. Der Kühlkreislauf steht unter Druck!



VORSICHT: Zum Auffüllen des Kühlflüssigkeitsstands und/oder Wechsel des Kühlflüssigkeit ausschließlich das in der Tabelle § 1.4. angegebene Produkt verwenden. Mischen Sie noch verdünnen Sie das Kühlmittel nicht mit Zusätzen oder unterschiedlichen Flüssigkeiten. Wenn das Kühlmittel spezifiziert in der Tabelle § 1.4. ist nicht vorhanden, benutzt ein Kühlmittel mit den technischen Eigenschaften, die mit dem vorgeschriebenen Produkt gleichbleibend sind.



VORSICHT: Kühlflüssigkeitsspritzer können lackierte Oberflächen beschädigen. Beim Auffüllen des Kühlkreislaufes darauf achten, dass keine Kühlflüssigkeit verspritzt wird. Eventuell verspritzte Kühlflüssigkeit sofort mit einem sauberen Tuch abwischen.

**ACHTUNG**

Unter bestimmten Voraussetzungen kann sich die Kühlflüssigkeit entzünden und mit unsichtbarer Flamme brennen. Darauf achten, dass keine Kühlflüssigkeit auf heiße Motorteile gelangt. Bei Entzünden der Kühlflüssigkeit besteht Verbrennungsgefahr.

**ACHTUNG**

Kühlflüssigkeit ist giftig. Der Kontakt mit der Kühlflüssigkeit kann Hautverätzungen und Hautreizungen verursachen. Kühlflüssigkeit von Kindern und Haustieren fernhalten. Bei ungewollter Einnahme von Kühlflüssigkeit kein Erbrechen hervorrufen, um ein Einatmen des Produktes in die Lungen zu vermeiden. Bei Kontakt mit Augen oder Haut sofort mit reichlich Wasser abspülen und umgehend einen Arzt aufsuchen.

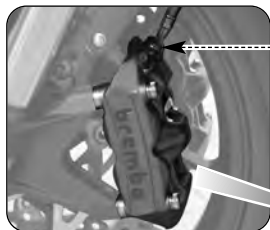
DE
1

Vordere Bremszange

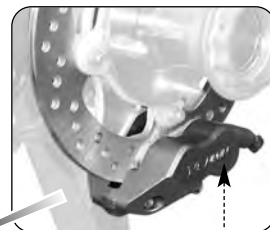

Hintere Bremszange

Bremsscheibe

Bremsbeläge

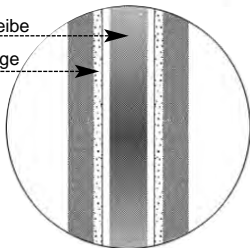

Abnutzungsgrenzwert 1 mm



1.7. Bremsbeläge - Kontrolle Abnutzung / Verschleiß

Die Tiefe der Schicht des Friktionsmaterials der Bremsbeläge muss regelmäßig überprüft werden. Die Tiefe der Schicht des Friktionsmaterials der Bremsbeläge darf nie weniger als 1 mm betragen.

Gefahr – Achtung: Wird das Motorrad mit abgenutzten Bremsbelägen gefahren, lässt die Bremswirkung nach, die Unfallgefahr wird größer. Ist die Bremsbelagstärke bis nahe der Abnutzungsgrenze verschlissen, wenden Sie zum Austausch der Bremsbeläge sich an einen autorisierten Kundendienst. Nach dem Auswechseln der Bremsbeläge auf eine entsprechende Einfahrzeit achten



Bremsflüssigkeitsbehälter Hinterradbremse

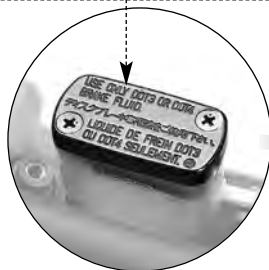

Bremsflüssigkeitsbehälter Vorderradbremse

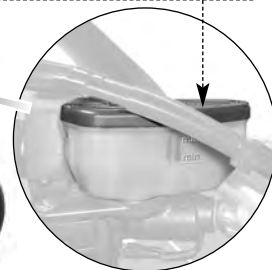

1 DE

1.8. Bremsflüssigkeit - Kontrolle Bremsflüssigkeitsstand



ACHTUNG

Bei fehlender Kontrolle oder unzureichender Wartung erhöht sich die Unfallgefahr. Vor jedem Fahrtantritt die Bremsanlage wie in der Quick Manual beschrieben überprüfen.

Ein leichtes Abfallen des Bremsflüssigkeitsstandes ist durch die Abnutzung der Bremsbeläge bedingt und daher normal. Der Bremsflüssigkeitsstand muss auf alle Fälle zwischen den Markierungen MIN und MAX liegen. Ist der Bremsflüssigkeitsstand unter das Zeichen MIN gefallen, wenden Sie sich an einen Kundendienst, um die Bremsanlage überprüfen zu lassen.

**ACHTUNG**

Das Motorrad nicht benutzen, wenn der Bremsflüssigkeitsstand unter die Markierung MIN abgefallen ist. Unter diesen Umständen kann es passieren, dass die Bremsanlage nicht richtig funktioniert. Es besteht erhöhte Unfallgefahr. Sie können die Kontrolle über das Fahrzeug verlieren. Ist der Bremsflüssigkeitsstand unter die Markierung MIN abgefallen, wenden Sie sich zum Überholen der Bremsanlage an einen MV Agusta Vertragshändler.

**ACHTUNG**

Das Nachfüllen von Bremsflüssigkeit darf nur von autorisiertem Fachpersonal vorgenommen werden. Die Bremsflüssigkeit ist giftig und kann bei Einnahme tödlich sein. Der Kontakt mit der Bremsflüssigkeit kann Hautverätzungen und Hautreizungen verursachen. Bremsflüssigkeit von Kindern und Haustieren fernhalten. Bei ungewollter Einnahme von Bremsflüssigkeit kein Erbrechen hervorrufen, um ein Einatmen des Produktes in die Lungen zu vermeiden.

**ACHTUNG**

Zum Auffüllen des Bremsflüssigkeitsstands ausschließlich die in der Tabelle § 1.4. angegebene Bremsflüssigkeit verwenden. Ein eventuelles Mischen unterschiedlicher Bremsflüssigkeiten kann gefährliche chemische Reaktionen verursachen und die Bremswirkung verringern, dadurch erhöht sich die Unfallgefahr.

**ACHTUNG**

Bei einem zu niedrigen Bremsflüssigkeitsstand kann Luft in die Bremsanlage eindringen, die Bremswirkung lässt nach und die Unfallgefahr wird größer. Luft in der Bremsanlage kann dadurch bemerkt werden, dass die Betätigung des Bremshebels "schwammiger" erscheint. Bei Luft in der Bremsanlage muss die Bremsanlage vor einem neuen Einsatz des Fahrzeugs bei einem MV Agusta Vertragshändler entlüftet werden.



1.9. Flüssigkeit Kupplungsbetätigung - Kontrolle Flüssigkeitsstand

Der Flüssigkeitsstand für die Kupplung muß zwischen den Zeichen MAX und MIN liegen. Ist der Flüssigkeitsstand für die Kupplung unter das Zeichen MIN gefallen, wenden Sie sich an einen Kundendienst, um die Kupplungsanlage überprüfen zu lassen.



ACHTUNG

Das Motorrad niemals benutzen, wenn der Flüssigkeitsstand für die Kupplung unter die Markierung MIN abgefallen ist. Die Kupplung könnte nicht richtig funktionieren. Es besteht erhöhte Unfallgefahr. Sie können die Kontrolle über das Fahrzeug verlieren. Ist der Flüssigkeitsstand für die Kupplung unter die Markierung MIN abgefallen, wenden Sie sich zum Überholen der Kupplungsanlage an einen MV Agusta Vertragshändler.



ACHTUNG

Zum Auffüllen des Flüssigkeitsstands für die Kupplung ausschließlich die in der Tabelle § 1.4 angegebene Kupplungsflüssigkeit verwenden.



**1.10. Reifen – Kontrolle und Wechsel****ACHTUNG**

**Vor Fahrtantritt stets den Reifendruck und Abnutzungs-
zustand der Reifen überprüfen.**

Die Kontrolle des Reifendrucks ist von grundlegender Bedeutung für die Fahrsicherheit. Bei einem zu niedrigen Reifendruck kann das Fahrzeug schwerer gelenkt werden und die Reifen verschleißeln schneller. Bei einem zu hohen Reifendruck verringert sich die Auflagefläche des Reifens und damit die Straßenhaftung.

Vor jedem Fahrtantritt muss daher stets der Reifendruck bei Raumtemperatur geprüft werden. D. h. das Motorrad muss seit mindestens drei Stunden geparkt sein.

**ACHTUNG**

Ein falscher Reifendruck bedeutet große Gefahr beim Fahren. Bei zu niedrigem Reifendruck kann der Reifen auf der Felge rutschen und sich von ihr ablösen. D. h. der Reifen wird völlig platt und Sie können die Kontrolle über das Fahrzeug verlieren.



Wird der Reifendruck sofort nach einer Fahrt gemessen, erhalten Sie höhere als die tatsächlichen Druckwerte. Dadurch könnte der Reifendruck falsch eingestellt werden. Beim Einstellen des Reifendrucks müssen die in § 2.2 angegebenen Werte eingehalten werden. Vor längeren Fahrten kann der Nominaldruck um 0,2 Bar erhöht werden. Sehr wichtig ist die Kontrolle des Reifenzustands vor Fahrtantritt. Stark abgenutzte Reifen sind anfälliger gegen Löcher und verschlechtern die Lenkbarkeit und die Stabilität des Motorrads. Bei der Überprüfung des Reifenzustands muss die Profiltiefe kontrolliert werden. Die Profiltiefe darf nicht geringer als die durch die Straßenverkehrsordnung angegebenen Werte sein. Am Boden der Profile dürfen keine Risse zu sehen sein. Die Reifendecke muss frei von Nägeln und Glassplittern sein. Die Reifenwände dürfen keine Risse aufweisen. Sind diese Voraussetzungen nicht gegeben, muss der Reifen umgehend bei einem MV Agusta Vertragshändler gewechselt werden.

**ACHTUNG**

Die vorgeschriebene Profiltiefe kann von Land zu Land unterschiedlich sein. Es müssen stets die vom jeweiligen Land gesetzlich vorgeschriebenen Werte eingehalten werden.

**ACHTUNG**

• Stark verschlissene Reifen von einem MV Agusta Vertragshändler wechseln lassen. Das Fahren des Motorrads mit stark abgenutzten Reifen ist illegal, die Fahrstabilität verringert sich. Sie können die Kontrolle über das Fahrzeug verlieren.

• Bei Schäden oder einem Loch im Reifen muss der Reifen gewechselt und nicht repariert werden. Ein reparierter Reifen bietet im Vergleich zu einem neuen Reifen nur eingeschränkte Leistungen und ein geringeres Sicherheitsniveau. Se si esegue una riparazione temporanea o di emergenza



Wird der Reifen provisorisch oder notdürftig repariert, muss bis zum nächstgelegenen MV Agusta Vertragshändler langsam und sehr vorsichtig gefahren werden. Lassen Sie dort den Reifen sofort wechseln. Nach einer Reifenreparatur nie schneller als 60 km/h fahren. Der Reifen kann nicht repariert werden, wenn die Reifenwand beschädigt oder das Loch auf der Lauffläche größer als 6 mm ist.

- Bei der provisorischen Reparatur eines Lochs im Reifen rät MV Agusta vom Gebrauch flüssiger Abdichtungsmittel ab. Diese Abdichtungsmittel können negative auf die einzelnen Schichten des Reifens einwirken und Nebenschäden, die durch eventuelle eingedrungene Gegenstände verursacht wurden, verdecken.

- Zum Reifenwechsel nur die in § 2.2 angegebenen Reifen verwenden. Unbedingt den Einsatz unterschiedlicher Reifenmarken und Profile an Vorder- und Hinterrad vermeiden. Der Einsatz ungeeigneter Reifen beeinträchtigt die Lenkbarkeit und Stabilität des Motorrads. Es besteht erhöhte Unfallgefahr.

- Die Felgen wurden für schlauchlose Reifen (Tubeless) entwickelt. Niemals Schlauchreifen an Felgen für schlauchlose Reifen abringen. Felgenränder und Reifenwulst können sich dann nicht richtig setzen. Die Reifen rutschen auf den Felgen und können den Druck verlieren. Sie können die Kontrolle über das Fahrzeug verlieren.



- Niemals Luftschläuche in einen schlauchlosen Reifen einbauen. Die Überhitzung des Reifens kann zum Platzen des Luftschlauchs führen. Die Reifen verlieren den Druck und Sie können die Kontrolle über das Fahrzeug verlieren.
- Beim Aufziehen der Reifen muss auf die durch Pfeile auf der Reifenwand angezeigte Laufrichtung geachtet werden.

- Neue Reifen benötigen eine Einlaufzeit, um ihre komplette Effizienz zu erreichen. Während der Einlaufzeit ist die Reifenhaftung bei bestimmten Straßenbelägen geringer. Wir empfehlen Ihnen daher während der ersten 100 km Fahrt mit einem neuen Reifen langsamer zu fahren.

**□ Ausbau des Hinterrads**

Vorsicht – Vorsichtsmassnahme:
Muss der Reifen bei einem
Reifenhändler gewechselt werden,
sicherstellen, dass für den Aus- und
Einbau folgende Werkzeuge verwen-
det werden:

- 55 mm Steckschlüssel
- Drehmomentschlüssel

Werden andere Werkzeuge benutzt,
können Radbauteile schwer beschä-
digt werden. Wir raten davon ab
Reifenwechsel in schlecht ausgerü-
steten Werkstätten vornehmen zu
lassen. Es ist auf alle Fälle ratsamer
sich für einen Reifenwechsel an
einen MV Agusta Vertragshändler zu
wenden.

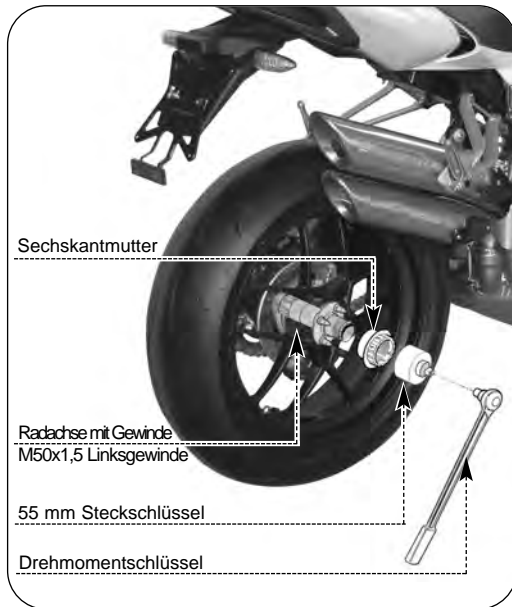



☐ Radkontrolle

Vor Fahrtantritt stets die Radfelge auf Risse, Verbiegungen und Verformungen überprüfen.



ACHTUNG

Werden Schäden festgestellt, muss das Rad von einem MV Agusta Vertragshändler gewechselt werden. Niemals versuchen auch nur kleine Schäden an den Rädern selbst zu beheben. Bei einem Reifenwechsel oder Austausch der Felge muss das Rad bei einem MV Agusta Vertragshändler ausgewuchtet werden. Ein nicht richtig ausgewichtetes Rad schränkt die Fahrzeuleistung und die Lebensdauer der Reifen ein.



ACHTUNG

Beim Auswuchten der Räder ausschließlich zugelassene Ausgleichsgewichte verwenden. Keine flüssigen Ausgleichs- oder Dichtungsmittel verwenden.



ACHTUNG

Niemals versuchen einen schlauchlosen Reifen ohne das entsprechende Spezialwerkzeug und Schutzvorrichtungen für die Felgen abzubauen. Andernfalls besteht die Gefahr, dass die Dichtungsfläche an der Felge beschädigt wird. Dadurch verliert der Reifen Luft und Sie die Kontrolle über das Fahrzeug.



1.11. Kette - Kontrolle und Schmieren

Für diese Arbeit muss das Motorrad auf ebenem Untergrund auf den hinteren Ständer gestellt und der Leerlauf eingelegt werden.

□ Kontrolle der Kettenspannung



ACHTUNG: Vor der Überprüfung der Kettenspannung, wenden Sie sich an den MV Agusta Kundendienst, um zu überprüfen, daß der Wert der statischen Einstellung der hinteren Federung korrekt ist. Auch überprüfen, ob die Kette richtig geschmiert wird.

Der untere Teil der Kette muss einem Abstand von **50 mm** vom unteren Kettenschutz haben. Die Kontrolle an mehreren Stellen an der Kette ausführen. Dazu muss das Hinterrad von Hand gedreht werden. Der Abstand muss während der Raddrehung gleich bleiben. Bestehen starke Unterschiede beim Spiel an der Kette, bedeutet dies, dass einige Kettenglieder gequetscht, verklemmt oder gedehnt sind. Ist der Abstand der Kette zum Kettenschutz kleiner oder größer als 50 mm, muss die Kettenspannung eingestellt werden.

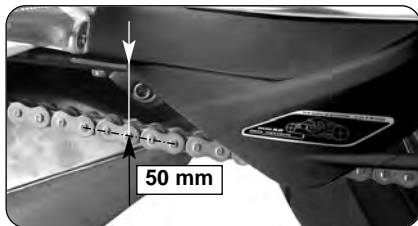

ANMERKUNG

Auf Antrag du kann bestellen, zum MV Agusta Ersatzteildienst, eine spezielle längliche obere Kettenschutz. Der Zusammenbau dieses Bestandteils auf Ihrem Motorrad gibt einen besseren Schutz als ein Standardbestandteil.





ACHTUNG

Beim Fahren des Motorrads mit einer verschlissenen oder schlecht eingestellten Kette erhöht sich die Unfallgefahr. Vor jedem Fahrtantritt prüfen, ob die Kettenspannung den Angaben in diesem Kapitel entspricht. Zum Einstellen der Kettenspannung wenden Sie sich bitte an einen MV Agusta Vertragshändler.



ACHTUNG

Bei gequetschten, verklemmten oder gedehnten Kettengliedern, muss die Kette durch eine MV Agusta Vertragshändler ersetzt werden.



ACHTUNG

Bei Schäden oder starker Abnutzung der Kette oder der entsprechenden Zahnräder muss die Kette durch einen MV Agusta Vertragshändler ausgetauscht werden. Bei jedem Kettenwechsel müssen auch die entsprechenden Zahnräder ausgetauscht werden.



ACHTUNG

Der Einbau einer Kette mit Kettenschloss ist gefährlich. Ein nicht richtig vernietetes Kettenglied oder Kettenschloss kann sich öffnen und Unfälle oder schwere Motorschäden verursachen. Niemals Ketten mit Kettenschlössern verwenden.



ACHTUNG

Jedesmal wenn es verlangt wird, um die Hinterradnabenschrauben laufen zu lassen, wenden Sie an einen autorisierten MV Agusta Kundendienst. Wenn Sie die Schrauben festziehen, wenden Sie ein Drehmoment an, die dem Wert gleich ist, der im Aufkleber auf dem Schwinge gezeigt wird. Die Anwendung einer Drehkraft stark als der angezeigte Wert kann den schnellen Zerfall der hintere Radnabe verursachen und die Zuverlässigkeit des Fahrzeugs und die Sicherheit des Piloten und des Passagiers gefährden.



☐ Schmieren

Damit die Kette richtig funktioniert, muss sie richtig geschmiert werden.

► Vorbereitende Reinigung: vorm Schmieren der Kette müssen alle Schmutzablagerungen an der Kette mit Kerosin aufgelöst werden. Diese Schmutzreste können anschließend mit einem sauberen Tuch bzw. einem Pressluftstrahl entfernt werden.



Vorsicht – Vorsichtsmassnahme: Die Kette ist eine Kette mit Dichtringen (O-Ringen). Um Schäden an der Kette zu vermeiden, darf diese nie mit Hochdruck-Dampf- oder Wasserstrahl gereinigt werden. Es dürfen auch kein Benzin oder handelsübliche Reinigungsmittel verwendet werden. Die Kette darf nur mit Kerosin gereinigt werden.



ACHTUNG

Kerosin kann gefährlich sein. Kerosin ist entzündlich. Der Kontakt mit Kerosin kann für Kinder und Haustiere schädlich sein. Offene Flammen und heiße Gegenstände vom Kerosin fernhalten. Kinder und Haustier vom Kerosin fernhalten. Benutztes Kerosin muss entsprechend der gesetzlichen Vorschriften entsorgt werden.



► **Schmieren:** einen leichten und gleichmäßigen Film des angegebenen Schmiermittels auf der gesamten Kette auftragen. Sorgfältig darauf achten, dass die umliegenden Fahrzeugteile, wie z. B. die Reifen, nicht verschmutzt werden. Den Strahl des Schmiermittels auf den internen Verbindungen verweisen, zwecks die Oberfläche der O-Ringe schmieren und innerhalb der Kettenrolle eindringen.



Vorsicht – Vorsichtsmassnahme: Ausschließlich das in der Tabelle § 1.4. angegebene Schmiermittel verwenden, um die Antriebskette zu schützen und zu vermeiden die Ölspritzern, wenn das Fahrzeug in Bewegung ist.



ACHTUNG: Das Schmieren der Kette muss in den in der Tabelle des Wartungsprogramms (§ 1.2) angegebenen Abständen erfolgen. Die Kette muss auch nach Fahrten bei Regen oder nach einer Fahrzeugreinigung geschmiert werden. Bei Fahrten mit nicht oder mit nicht ausreichend geschmierter Kette besteht Unfallgefahr.



1 DE

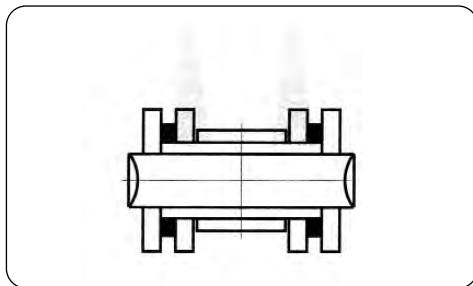



1.12. Leerlaufdrehzahl - Kontrolle

Die Kontrolle der Leerlaufdrehzahl muß mit Motor bei Betriebstemperatur ausgeführt werden. Überprüfen, dass der "CHOKE" ausgeschaltet ist.

Die Leerlaufdrehzahl muß zwischen 1150 und 1250 U/min liegen.





Wenden Sie sich zum Einstellen der Leerlaufdrehzahl an einen Kundendienst.





1.13. Auswechseln - Allgemeine Informationen

Das Auswechseln der Sicherungen und der Glühbirnen kann vom Fahrer selbst ausgeführt werden. Dazu genau die Anweisungen einhalten

	Sicherung Batterieladung - Auswechseln (§1.13.1.)
	Sicherungen Stromverbraucher -Auswechseln (§1.13.1.)
	Fahrlicht - Auswechseln der Birne (§1.13.2.)
	Fernlicht- Auswechseln der Birne (§1.13.3.)
	Vorderes Standlicht - Auswechseln der Birne (§1.13.4.)

1.13.1.Sicherungen - Auswechseln

► Die Nachladungs-Sicherung befindet sich unter der Fahrersitzbank; siehe Position in der Abb.

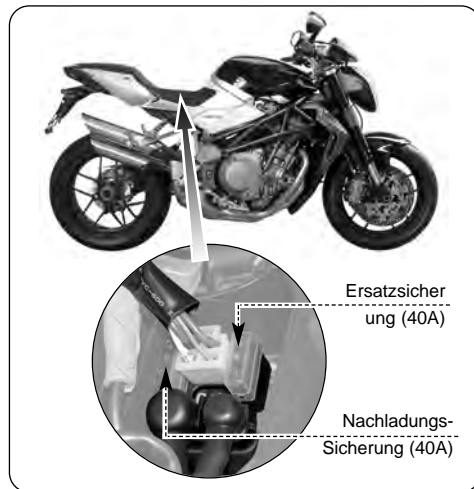



► Der Sicherungshalter befindet sich unter dem Beifahrersitzbank. Um an das Bauteil gelangen zu können, muss die Fahrersitzbank abmontiert werden. Anschließend Die Befestigung der Beifahrersitzbank abschrauben und die Sitzbank herausziehen.



► Den Deckel des Sicherungshalters aushaken und anheben.





► Die Sicherungsfunktion und -position auf dem Aufkleber und im beiliegenden elektrischen Schaltplan angegeben. Die Markierungs-buchstaben in der Abbildung entsprechen den Angaben im Schaltplan.

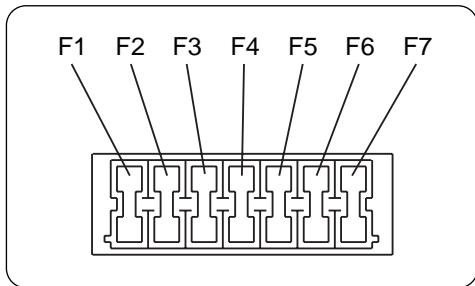

► Die durchgebrannte Sicherung auswechseln und den Deckel wieder aufsetzen. Bitte beachten Sie, dass sich im Bordwerkzeug-Beutel drei Ersatzsicherungen befinden.



ACHTUNG

Niemals eine andere Sicherung als mit der vorgeschriebenen Leistung verwenden, um Schäden an der Elektroanlage des Fahrzeugs und Brandgefahr zu vermeiden.





1.13.2. Fahrlicht - Auswechseln der Birne

► Die zwei seitlichen Befestigungsschrauben des vorderen Fahrlichtes abschrauben. Dabei achten, dass bei Abbau des Fahrlichtes von der Halterung der Register von seinem Sitz ausgezogen wird.

► Bevor das vordere Licht von seiner Halterung herausgezogen wird, den Stecker, der sich hinter das Fahrlicht befindet, ausschalten.

► Zur Durchführung folgender Operationen, das Licht auf einen Tisch legen.





- ▶ Die hintere Schraube am Scheinwerfer abschrauben.
- ▶ Das vordere Teil des Scheinwerfers aus der Halterungsschale entfernen.



1 DE

- ▶ Die Schutzhaube entfernen.





- ▶ Den Kabelstecker vom Abblendlicht-Scheinwerfer trennen.
- ▶ Die Rückhaltefeder aushaken.
- ▶ Die Lampe aus dem Abblendlicht-Scheinwerfer herausziehen.



Vorsicht -Vorsichtsmaßnahme: Das Lampenglas nicht mit bloßen Fingern anfassen. Andernfalls mit Fettlöser reinigen.

- ▶ Eine neue Lampe einsetzen.
- ▶ Die Rückhaltefeder wieder einhaken.
- ▶ Den Kabelstecker wieder am Abblendlicht-Scheinwerfer anschließen.
- ▶ Die Schutzhaube wieder anbringen.
- ▶ Das vordere Teil des Scheinwerfers in die Halterungsschale einsetzen.
- ▶ Die hintere Schraube festschrauben.
- ▶ Den Kabelstecker am Scheinwerfer anschließen.
- ▶ Den Scheinwerfer in seine Halterung einsetzen und die beiden seitlichen Befestigungsschrauben festschrauben. Darauf achten, dass die Scheinwerfer-Stellvorrichtung richtig in ihren Sitz eingesetzt wird.





1.13.3. Fernlicht - Auswechseln der Birne

- ▶ Das vordere Fernlicht wie unten § 1.13.2. beschrieben von seiner Halterung abnehmen.
- ▶ Seitlich auf den Kabelstecker drücken, den Kabelstecker nach außen ziehen und die Lampe des Fernlicht-Scheinwerfers herausziehen.
- ▶ Den Stecker von der Birne ausziehen.



Vorsicht -Vorsichtsmaßnahme: Das Lampenglas nicht mit bloßen Fingern anfassen. Andernfalls mit Fettlöser reinigen.

- ▶ Den Stecker in die neue Birne einstecken.
- ▶ Die Lampe wieder einsetzen und durch leichten Druck an ihrem Sitz befestigen.
- ▶ Das Fahrlicht auf die Halterung aufstellen und sämtlichen unter § 1.13.2. angegebenen Vorgängen befolgen.





1.13.4. Nummernschildbeleuchtung - Auswechseln der Birne

- ▶ Die Befestigungsschrauben der Kabelführung aus-schrauben.
 - ▶ Wie auf der Abbildung vorgeht, die Kabelführung herablassen und von der oberen Auflagefläche entfernen.
-
- ▶ Den Lampenhalter des Schildlichtes von seinem Sitz ausziehen.
 - ▶ Die Birne von dem Lampenhalter herausziehen.
 - ▶ Eine neue Birne einstecken.
 - ▶ Den Lampenhalter wieder einsetzen.
 - ▶ Die Kabelführung wieder mit der oberen Auflagefläche in Kontakt bringen.
 - ▶ Die Befestigungsschrauben der Kabelführung fest anziehen.





1.14. Batterie

Dieses Motorrad ist mit einer versiegelten (wartungsfreien) Batterie ausgestattet, die unter dem Heckteil angebracht ist. Die Batterie ist wartungsfrei, d. h. der Batteriefüllstandsstand braucht nicht überprüft bzw. nachgefüllt werden.

Bei schwachen bzw. entladener Batterie (elektrische Probleme, Startschwierigkeiten), muss sie so bald wie möglich bei einem MV Agusta Vertragshändler aufgeladen werden. Beachten Sie, dass die Batterie sich schneller entlädt, wenn elektrisches Sonder-Zubehör installiert wurde.



ACHTUNG

Ist das Batteriegehäuse beschädigt, kann Schwefelsäure austreten. Schwefelsäure ist giftig und stark ätzend. Jeglichen Kontakt mit Haut, Augen und Kleidung vermeiden. Bei Arbeiten an oder in der Nähe der Batterie stets eine Schutzbrille tragen.

Bei Kontakt mit Schwefelsäure muss wie folgt ERSTE HILFE geleistet werden:

- **ÄUßERLICHER KONTAKT:** mit reichlich fließendem Wasser abspülen.
- **INNERLICHER KONTAKT:** Grosse Mengen Wasser oder Milch trinken und sofort einen Arzt benachrichtigen.
- **AUGEN:** Mindestens 15 Minuten mit Wasser spülen und sofort einen Arzt aufsuchen.

Bei Austreten von Schwefelsäure bildet sich Wasserstoffgas, das bei offenen Flammen oder Funkenbildung explodieren kann.

Zum Wechseln der Batterie wenden Sie sich bitte an einen autorisierten MV Agusta Kundendienst.



Längeres Stilllegen

Soll das Fahrzeug für einen längeren Zeitraum (einen Monat oder mehr) nicht benutzt werden, sollten die Batteriekabel von der Batterie abgenommen werden bzw. die Batterie von einem Fachmann ausgebaut werden. Zur Erhaltung der Batterie-Lebensdauer sollte die Batterie bei längerem Stilllegen alle 4 – 5 Monate bei einem MV Agusta Vertragshändler nachgeladen werden.



GEFAHR: Ein Vertauschen der Polanschlüsse kann die Ladeanlage und die Batterie beschädigen. Die roten Kabel müssen an den Pluspol (+) der Batterie und die schwarzen Kabel an den Minuspol (-) angeschlossen werden. Beim Ausbau der Batterie muss **ALS ERSTES** die Polklemme vom Minuspol der Batterie und anschließend vom Pluspol abgenommen werden. Beim Wiedereinbau in umgekehrter Reihenfolge vorgehen.





1.15. Fahrzeugpflege

Eine regelmäßige Pflege ist wichtig, damit Ihr Motorrad über lange Zeit seinen Wert behält. Lack- und andere Oberflächen müssen gepflegt und geschützt werden. Stets auf eventuelle Schäden, Abnutzung und Austreten ätzender Flüssigkeiten achten.



Vorsicht – Vorsichtsmassnahme: Vorm Waschen müssen die Auspuffenden verstopft und die elektrischen Teile geschützt werden.



ACHTUNG

Ist das Motorrad noch von der letzten Fahrt warm, muss abgewartet werden, bis sich der Motor und die Auspuffanlage abgekühlt haben.



Vorsicht – Vorsichtsmassnahme: Keine Hochdruck-Wasserstrahl oder Dampfreinigungsgeräte verwenden, da andernfalls Wasser in Motorradbauteile eindringen und diese beschädigen kann.



ANMERKUNG: Die Reinigungsmittel verunreinigen die Umwelt. Aus diesem Grund sollte die Fahrzeugreinigung in Bereichen, die mit Sammlungs- und Klärungsanlagen der Reinigungswasser ausgestattet sind, vorgenommen werden.



Mit Wasser, Schwamm und einem milden Reinigungsmittel säubern. Mit einem weichen Tuch abtrocknen. An schwer zugänglichen Stellen einen Druckluftstrahl verwenden.



Vorsicht – Vorsichtsmassnahme:

- Sicherstellen, dass keine Lappen oder Schwämme benutzt werden, die mit starken oder scheuernden Reinigungsmitteln, Lösungsmitteln, Alkohol oder Benzin in Kontakt gekommen sind.
- Um die Karosserieteile nicht zu beschädigen keine alkalische oder ätzende Reinigungsmittel, Benzin, Bremsflüssigkeiten oder andere Lösungen benutzen.
- Wenn du Zweifel über den chemischen Aufbau von hast Reinigungsmittel, prüfen seinen Effekt, indem es ihn auf einem wenig Bereich der Karosserie anwendet, bevor es sie auf dem vollständigen Motorrad verwendet.

Die lackierten Teile müssen in regelmäßigen Abständen mit Spezialprodukten behandelt werden. Bei Fahrten auf Straßen, auf denen Streusalz ausgebracht wurde, muss das Motorrad so bald wie möglich gereinigt werden. Dann anschließend mit kaltem Wasser waschen. Warmes Wasser verstärkt die Korrosionswirkung.



ACHTUNG: Sicherstellen, dass kein Öl oder Wachs auf die Bremsen oder Reifen gelangt. Gegebenenfalls die Brems-scheiben mit einem Reinigungsmittel für Bremsscheiben oder Aceton reinigen und die Reifen mit heißem Wasser und einem milden Reinigungsmittel waschen.



ACHTUNG: Bei nassen Bremsen verringert sich die Bremsleistung und erhöht sich die Unfallgefahr. Nach dem Waschen des Fahrzeugs den Motor starten und langsam einige Minuten fahren. Einige Male vorsichtig bremsen, so dass die Bremsscheiben und Bremsbeläge trocknen können.



ACHTUNG: Die Antriebskette muss sofort nach der Reinigung und Trocknen des Fahrzeugs geschmiert werden. Das Schmieren der Kette muss entsprechend der Angaben in § 1.11 der vorliegenden Wartungsanleitung vorgenommen werden.

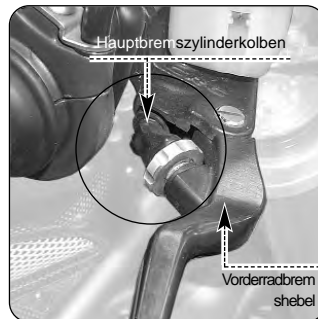
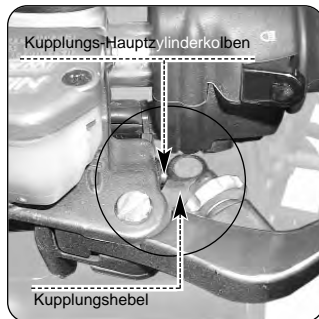
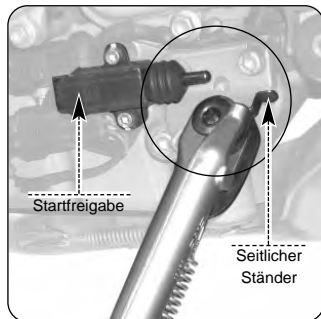

VORSICHT

Überprüfen Sie, sauber die Berührungsflächen zwischen den folgenden Bestandteilen immer zu halten, wie in den oben genannten Abbildungen gezeigt:







- Seitlicher Ständer und Startfreigabe
- Kupplungshebel und Kupplung-Hauptzylinderkolben
- Vorderradbremshebel und Hauptbremzylinderkolben

Säubern Sie diese Bereiche alle 500 ÷ 1000 Kilometer, wie in der programmierte Wartungsarbeitentabelle vorgeschrieben. Überprüfen Sie die Sauberkeit der oben genannten Bereiche, jedesmal wenn Sie den Träger benutzen, um das korrekte Arbeiten der in Verbindung stehenden Teile beizubehalten.



1.16. Längeres Stilllegen

Soll das Fahrzeug über längere Zeit stillgelegt werden, müssen folgende Vorkehrungen getroffen werden:

-  Den Benzintank entleeren.
-  Die Batterie ausbauen und in geeigneter Weise aufbewahren.
-  Die Kerzenstecker abziehen und die Zündkerzen ausbauen. Einen Teelöffel Motoröl in jede Kerzenbohrung einfüllen, anschließend die Kerzen wieder einbauen und die Kerzenstecker aufsetzen und den Motor einige Umdrehungen ausführen lassen.
-  Alle Bowden- und Seilzüge sowie die Drehpunkte der Hebel und Pedale schmieren.
-  Das Motorrad reinigen und die lackierten Teile mit Spezialprodukten behandeln (§1.15.).
-  Um die Integrität und Leistung der Reifen zu garantieren, sollte das Fahrzeug an einem kühlen, trockenen und dunklen Raum mit gleichbleibender Temperatur unter 25°C abgestellt werden. Die Reifen dürfen keinen direkten Kontakt mit Heizkörpern oder Heizungsleitungen und keinen längeren Kontakt mit Öl oder Benzin haben. Die Reifen sollten nicht in der Nähe von Elektromotoren oder Geräten aufbewahrt werden, bei denen elektrische Funkenbildung oder elektrische Entladungen entstehen. Während der Stillstandszeit muss das Motorrad auf den hinteren Ständer gestellt werden.
-  Das Motorrad mit einer zweckmäßigen Schutzplane abdecken.

Einsatz nach dem Stilllegen muß eine allgemeine Fahrzeugkontrolle vorgenommen und gegebenenfalls die entsprechenden Wartungsarbeiten (§1.2.) ausgeführt werden.



2.1. Störungen am Motor: **DER MOTOR SPRINGT NICHT AN**

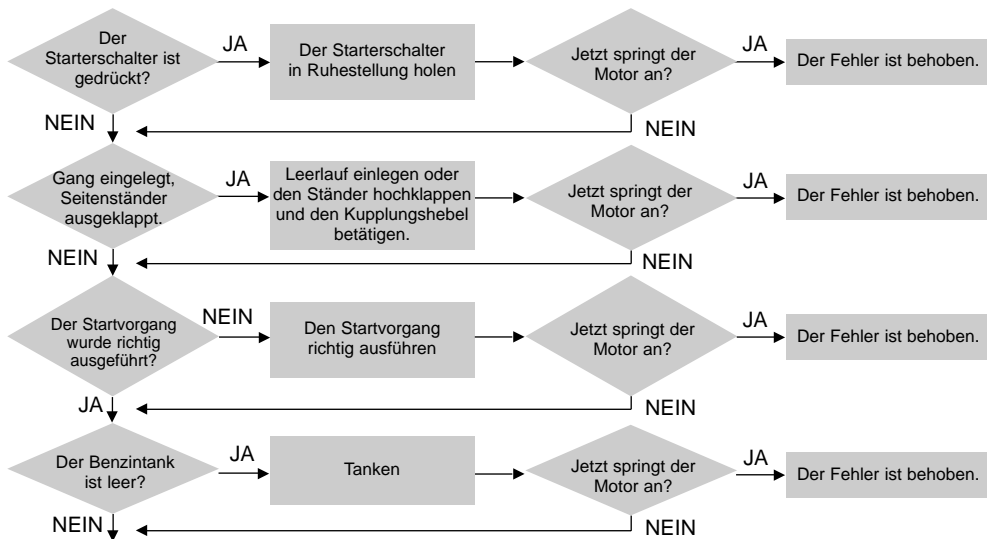

Weiter auf der nächsten Seite



Fortsetzung von der vorherigen Seite

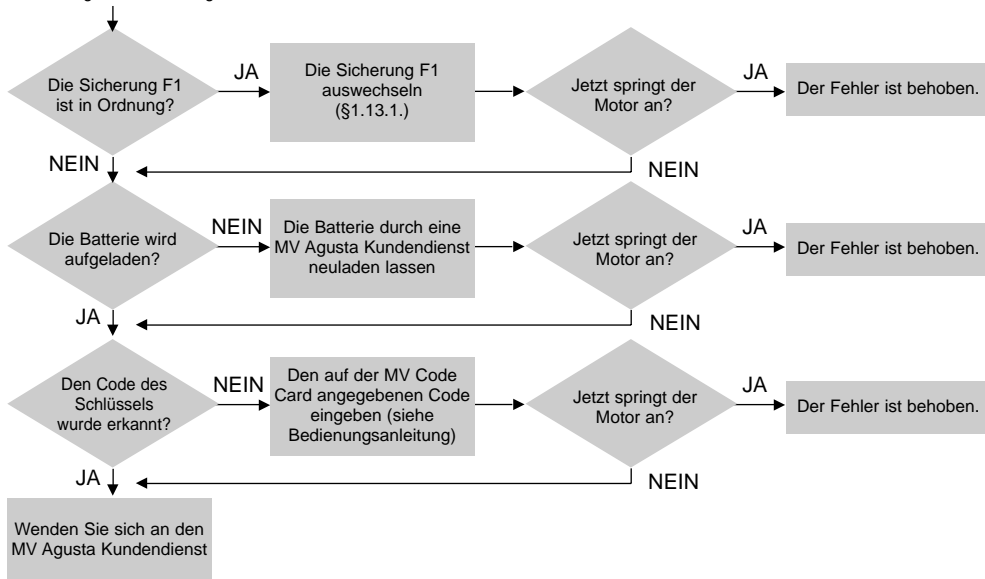



DER MOTOR STELLT BEIM LAUFEN AB

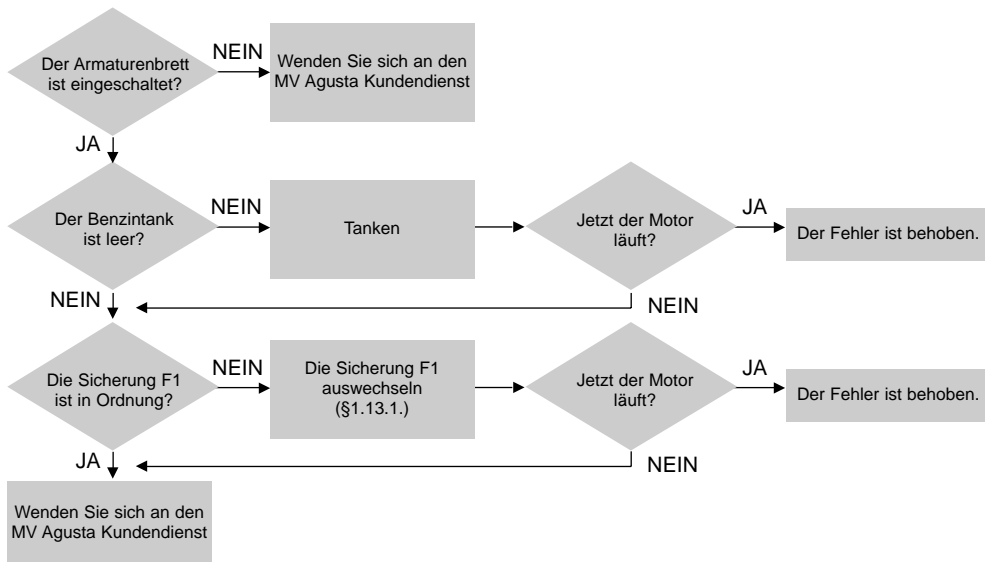



DER MOTOR WIRD ZU HEISS

DE 2

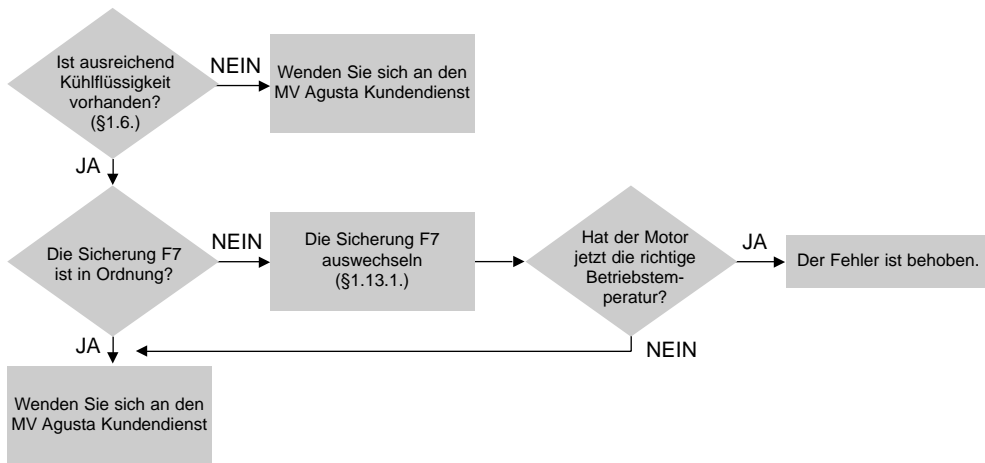



DER ÖLDRUCK IST ZU NIEDRIG (Das Motoröldruck-Kontrolllampe ist eingeschaltet, während der Motor läuft)

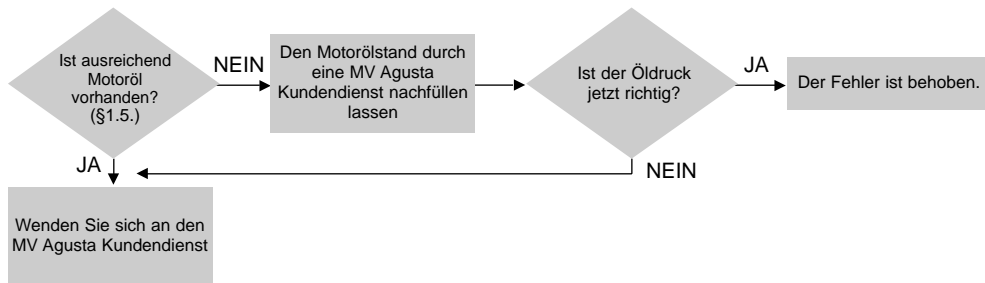



2.2. Störungen an der elektrischen Anlage: **DIE BELEUCHTUNG FUNKTIONIERT NICHT**

DE 2

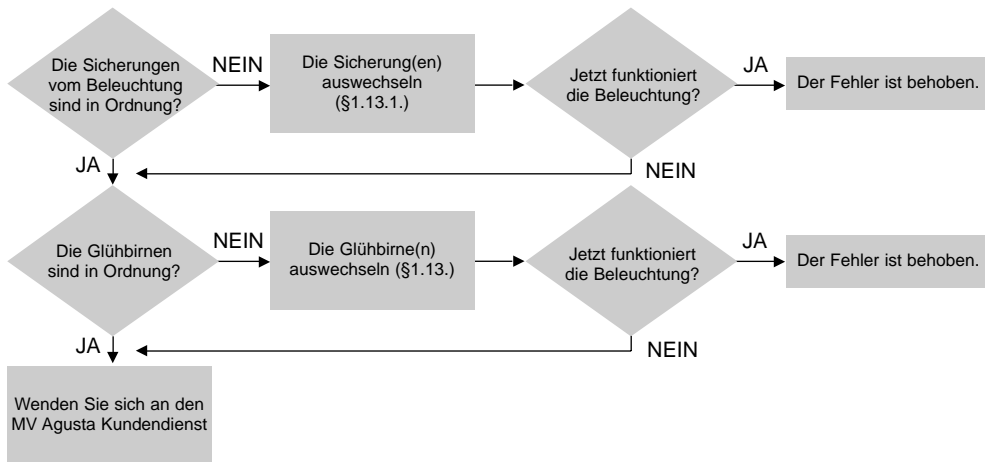



DIE HUPE FUNKTIONIERT NICHT

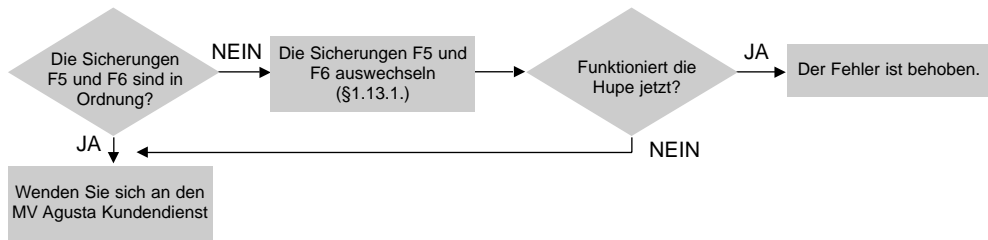

2 DE

DER KILOMETERZÄHLER FUNKTIONIERT NICHT

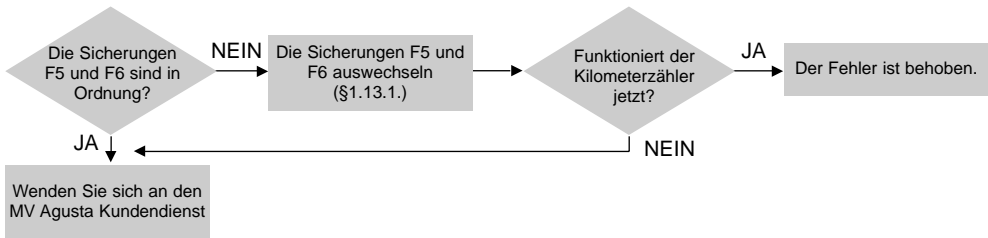



DIE KONTROLLEUCHTEN DES ARMATURENBRETTES FUNKTIONIER NICHT

DE 2

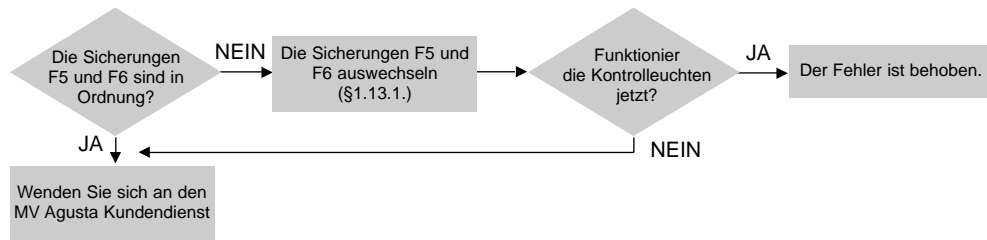

DIE LICHTMASCHINE LÄDT DIE BATTERIE NICHT AUF (Das Batterielade-Kontrolllampe ist eingeschaltet, während der Motor läuft)

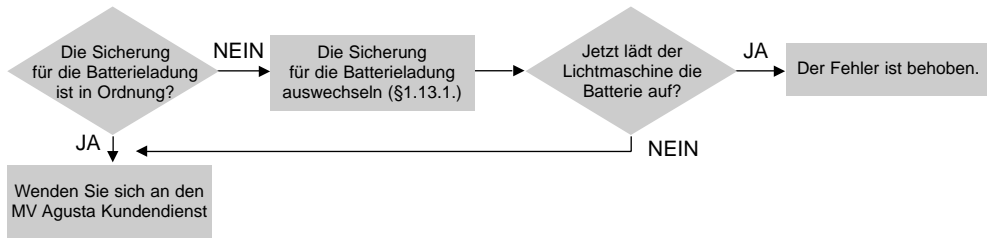



3.1. Allgemeine Beschreibung des Motorrads

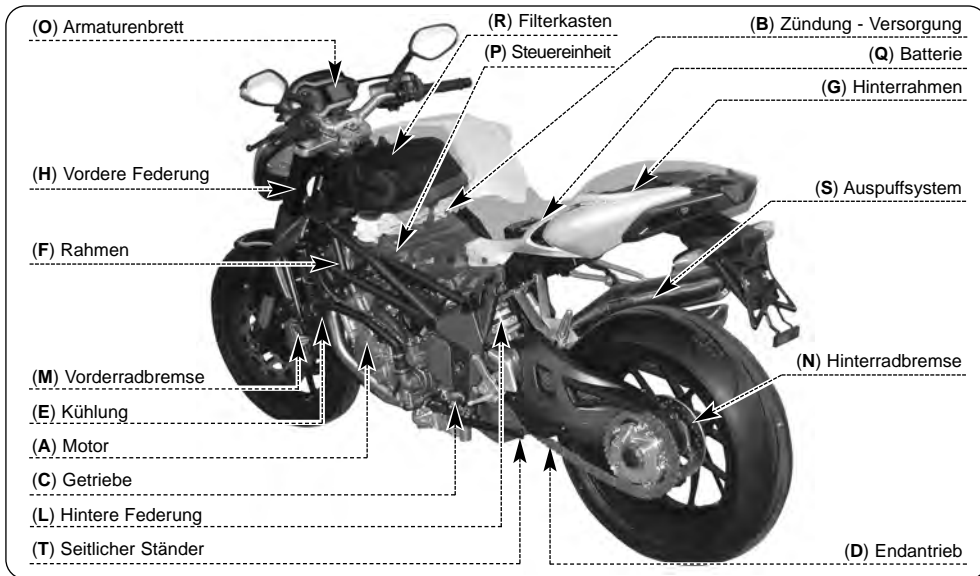



- A - Motor:** Viertaktmotor, 4-Zylinder in Reihe, Ventilsteuerung mit doppelter obenliegender Nockenwelle mit Radialventilen. Sumpfschmierung.
- B - Zündung - Versorgung:** Integriertes Zünd-Einspritzsystem. Elektronische Zündung mit induktiver Entladung. Elektronische Einspritzung "Multipoint".
- C - Getriebe:** Ausziehbar, Sechsganggetriebe mit ständig greifenden Zahnrädern.
- D - Endantrieb:** Bestehend aus Ritzel, Zahnkranz und Kette.
- E - Kühlung:** mit unterschiedlichen Öl- und Wasser-Wärmetauscher.
- F - Rahmen:** Gitterförmig, Stahlrohrrahmen mit Seitenplatten aus Aluminium.
- G - Hinterrahmen:** Gitterförmig, aus röhrenförmigem Stahl.
- H - Vordere Federung:** Hydraulische Gabel mit umgekehrten Gabelschäften. Mit Einstellungs-system.
- L - Hintere Federung:** Schwingarm mit progressiver Wirkung und Einzelstoßdämpfer mit Einstellungssystem.
- M - Vorderradbremse:** Doppelte Bremsscheibe mit halb-schwimmend gelagerten Bremssätteln mit Radialbremszange mit vier Bremskolben.
- N - Hinterradbremse:** Einzelscheibe mit Bremszange mit vier Bremskolben.
- O - Armaturenbrett:** Ausgestattet mit Kontrolleuchten und analogen und digitalen Instrumenten.
- P - Steuereinheit:** mit EPROM ausgestattet für die elektronische Kontrolle des integrierten Zünd-Einsspritzsystems.
- Q - Batterie:** versiegelt und wartungsfrei.
- R - Filterkasten:** mit Filteranlage des Motorsaugluftdurchflusses.
- S - Auspuffsystem:** Ausgestattet mit katalytischem Konverter für Abgasverkleinerung.
- T - Seitlicher Ständer:** mit Sicherheitsschalter und doppelte Rückzugsfeder.



3.1.1 Bremskreislauf Vorderradbremse

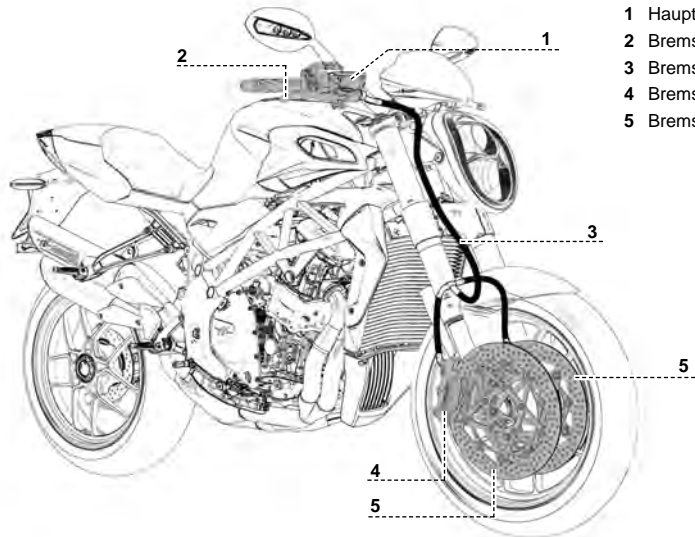

- 1 Hauptbremszylinder
- 2 Bremshebel
- 3 Bremsleitung
- 4 Bremssattel
- 5 Bremsscheiben



3.1.2. Bremskreislauf Hinterradbremse

DE 3

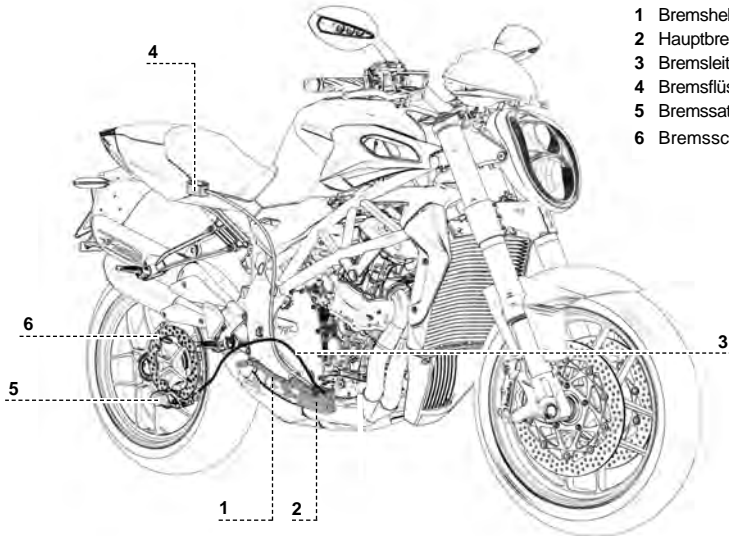

- 1 Bremshebel
- 2 Hauptbremszylinder
- 3 Bremsleitung
- 4 Bremsflüssigkeitsbehälter
- 5 Bremssattel
- 6 Bremsscheibe



3.1.3. Kupplungskreislauf

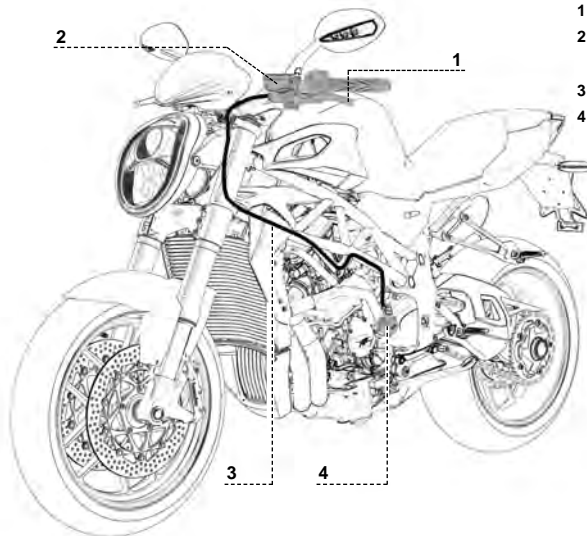

- 1 Kupplungshebel
- 2 Baugruppe Kupplungs-Hauptzylinder
- 3 Kupplungsleitung
- 4 Baugruppe kleiner Kupplungszyylinder



3.1.4. Motorschmierung

DE 3

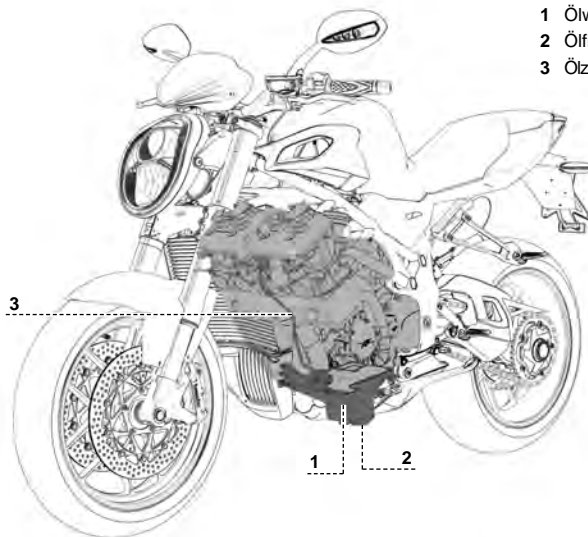

- 1 Ölwanne
- 2 Ölfilter
- 3 Ölzuleitung zum Zylinderkopf



3.1.5. Kühlkreislauf

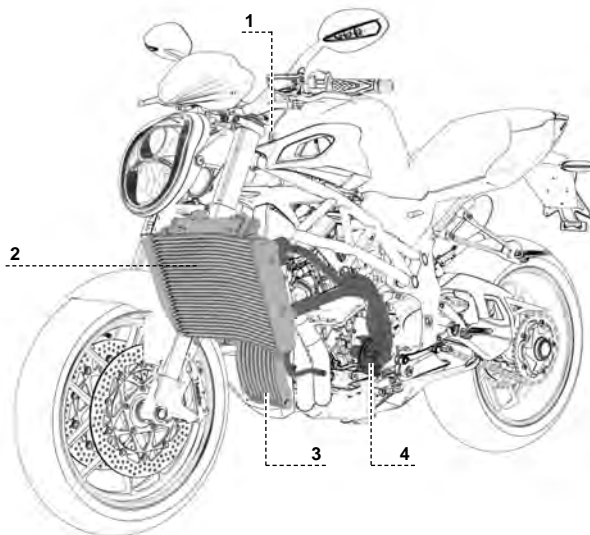

- 1 Ausdehnungsgefäß
- 2 Oberer Kühler
- 3 Unterer Kühler
- 4 Kühlmittelpumpe



3.1.6. Benzin-Versorgungskreislauf

DE 3

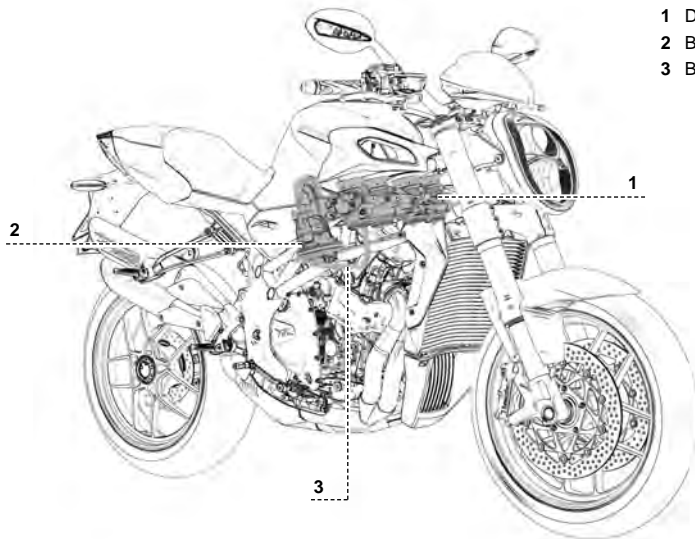

- 1 Drosselkörper
- 2 Benzinpumpe
- 3 Benzinleitung

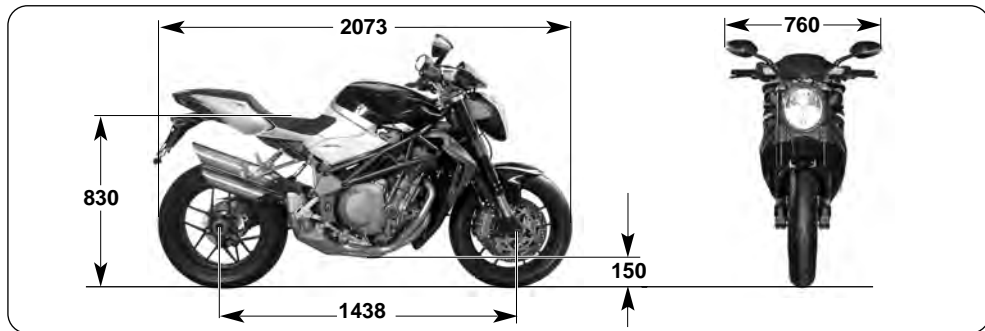

3.2. Technische Daten

Bezeichnung	BRUTALE 1090 RR
TECHNISCHE ANGABEN	
Radabstand (mm) (*)	1438
Gesamtlänge (mm) (*)	2037
Gesamtbreite (mm)	760
Sitzbankhöh (mm) (*)	830
Bodenfreiheit (mm) (*)	150
Vorlauf (mm) (*)	103,5

* : Die angegebenen Werte sind nicht verbindlich. Die angegebenen Werte können sich je nach Zustand und Trimmung des Fahrzeugs ändern.



Technische Daten

Bezeichnung	
BRUTALE 1090 RR	
Leergewicht (Kg)	190
Tankinhalt Benzintank (lt) (*)	19
Benzinreserve (lt) (*)	4
Ölmenge im Motorgehäuse (Kg)	3,5
MOTOR	
Typ	Vierzylinder-Viertaktmotor, 16 Ventile
Bohrung (mm)	79,0
Hub (mm)	55,0
Hubraum (cm ³)	1078
Verdichtungsverhältnis	13 : 1
Starten/Anlassen	Elektrisch
Kühlung	Mit unterschiedlichen Öl- und Wasser-Wärmetauscher
Motorgehäuse und Deckel	Druckguß
Zylinderkopf und Zylinder	Kokillenguß
Ventile	Bimetallisch / Monometallisch
VENTILSTEUERUNG	
Typ	Doppelte obenliegende Nockenwelle, Radialventile

* : Die angegebenen Werte sind nicht verbindlich. Die angegebenen Werte können sich je nach Außentemperatur, Motortemperatur und Verdampfungspunkt des verwendeten Benzins ändern.



Technische Daten

Bezeichnung	BRUTALE 1090 RR
SCHMIERUNG	
Typ	Sumpfschmierung
ZÜNDUNG - VERSORGUNG	
Typ	Zünd-/ Einspritzanlage Magneti Marelli 5.SM mit Drosselkörper Mikuni. Elektronische Zündung mit induktiver Entladung. Elektronische, sequentiell getaktete Multipoint-Einspritzung.
Zündkerzen	NGK CR9 EB
Elektrodenabstand (mm)	0.7 ÷ 0.8
KUPPLUNG	
Typ	Mehrscheiben-Ölbadkupplung
HAUPTANTRIEB	
Zahnzahl Zahnrad Kurbelwelle	Z = 50
Zahnzahl Zahnrad Kupplung	Z = 79
Übersetzungsverhältnis	1.58
ENDANTRIEB	
Zahnzahl Ritzel	Z = 15
Zahnzahl Zahnkranz	Z = 41
Übersetzungsverhältnis	2.73
GETRIEBE	
Typ	Ausziehbar, Sechsganggetriebe mit ständig greifenden Zahnrädern



Technische Daten

Bezeichnung	
BRUTALE 1090 RR	
Untersetzung Gänge (Gesamtverhältnis)	
Erster	2.92 (12.59)
Zweiter	2.12 (9.14)
Dritter	1.78 (7.68)
Vierter	1.50 (6.47)
Fünfter	1.32 (5.69)
Sechster	1.21 (5.22)
RAHMEN	
Typ	Gitterförmiger 25 CrMo-Stahlrohrrahmen (TIG-verschweißt)
Auflageblech Gabeldrehpunkt	Aluminiumlegierung
VORDERE FEDERUNG	
Typ	Hydraulische Gabel mit umgekehrten Gabelschäften. Mit Einstellungssystem für Ausdehnungs- und Kompressionsbremse sowie Federvorspannung
Ø Schaft (mm)	50
Hubhöhe an Gabelbeinachse (mm)	125
HINTERE FEDERUNG	
Typ	Progressiv, Einzelstoßdämpfer mit Einstellung in Zugstufe, Druckstufe (hohe/ niedrige Geschwindigkeit) und Federvorspannung
Gabel	Aluminiumlegierung
Radhub (mm)	120



Technische Daten

Bezeichnung	BRUTALE 1090 RR
VORDERRADBREMSE	
Typ	Doppelte Bremsscheibe mit halb-schwimmend gelagerten Bremssätteln
Ø Bremsscheibe (mm)	320
Bremsscheibenflansch	Stahl
Bremsszange Durchmesser Bremskolben mm	Radial monoblock mit 4 Bremskolben (Ø 34)
HINTERRADBREMSE	
Typ	Stahlscheiben
Ø Bremsscheibe (mm)	210
Bremsszange Durchmesser Bremskolben mm	Vier Bremskolben (Ø 25.4)
VORDERRADFELGE	
Material	Aluminiumlegierung
Ausmaß	3.50" x 17"
HINTERRADFELGE	
Material	Aluminiumlegierung
Ausmaß	6.00" x 17"
REIFEN	
Vorne	120/70-ZR 17 (58 W)
Hinten	190/55-ZR 17 (75 W)
Merke und Typ	DUNLOP - Sport Max Qualifier RR PIRELLI - Dragon Supercorsa Pro



Technische Daten

Bezeichnung	BRUTALE 1090 RR
Reifendruck (*):	
Vorne	2.3 bar (33 psi)
Hinten	2.3 bar (33 psi)
ELEKTRISCHE ANLAGE	
Spannung	12 V
Fahrlicht	12 V - 55 W
Fernlicht	12 V - 55 W
Rücklicht	12 V - 5 W
Batterie	12 V - 8 Ah
Lichtmaschine	350 W bei 5000 U/min
KAROSSERIE	
Tank	Thermoplastisches Material
Kühlerhaube Air-box	Thermoplastisches Material
Tank-Seitenteile	Thermoplastisches Material
Hintere Heck-Seitenteile	Thermoplastisches Material
Heckteil	Aluminium
Instrumentenverkleidung	Thermoplastisches Material

*: Beim Einsatz anderer Marken als der empfohlenen Reifenmarken muss der vom Reifenhersteller auf der Reifenwand auf-geprägte Reifendruck eingehalten werden.

**Technische Daten**

Bezeichnung	BRUTALE 1090 RR
Zündschloss-Deckel	Thermoplastisches Material
Vorderer Kotflügel	Thermoplastisches Material
Ketten-Abdeckung	Thermoplastisches Material
Ölkühlerschutz	Thermoplastisches Material
Nummernschildhalter	Thermoplastisches Material
Rückspiegel	Thermoplastisches Material
Auspuffrohr-Verkleidung	Aluminium



DE 3





3.3. Überbau - Farbkennziffer

Die lackierten Überbauteile haben im Verhältnis zu der entsprechenden Farbnummer des Motorrades folgende Farbkennziffer:

1. - Rechte Hintererwange;
2. - Linke Hintererwange;
3. - Rechte tank-seitenverkleidung;
4. - Linke tank-seitenverkleidung;

Farb-Codes A-D-F:

Silber F4 AGO (Kennziffer Palinal 928XV025)

Farb-Codes B-E:

Weiße Perle CRC (Kennziffer Palinal 927.PE20)

Farb-Code C:

Anthrazit metallisiert "Senna" (Kennziffer PPG GM WA9561)

5. - Vorderradkotflügel;
6. - Airbox Seitenabdeckung;

Farb-Codes A-D:

Rot F4 AGO (Kennziffer Palinal 926R750)

Farb-Codes B-C-E:

Intensiv schwarz CRC (Kennziffer Palinal 929R486H)

Farb-Code F:

Titanium-Grau (Kennziffer Palinal L821)

7. - Benzintank:**Farb-Codes A-D:**

Rot F4 AGO (Kennziffer Palinal 926R750) +
Silber F4 AGO (Kennziffer Palinal 928XV025)

Farb-Codes B-E:

Intensiv schwarz CRC (Kennziffer Palinal 929R486H) +
Weiße Perle CRC (Kennziffer Palinal 927.PE20)

Farb-Code C:

Intensiv schwarz CRC (Kennziffer Palinal 929R486H) +
Anthrazit metallisiert "Senna" (Kennziffer PPG GM WA9561)

Farb-Code F:

Titanium-Grau (Kennziffer Palinal L821) +
Silber F4 AGO (Kennziffer Palinal 928XV025)

8. - Rechte Kühlerschutz;
9. - Linke Kühlerschutz;
10. - Abdeckung Armaturenbrett;

Carbon-Grau metallisiert
(Kennziffer Palinal L921)



DE 3





3.4. Rahmen- und Radfahrteile Farbkennziffer

Die lackierten Rahmen- u. Radfahrteile haben folgende Farbkennzeichnung:

1. - Rahmen:

Farb-Codes A-B-C:

Matt-Bronze B5

(Kennziffer Palinal 211F297)

Farb-Codes D-E:

Anthrazit-Grau metallisiert MV

(Kennziffer Palinal 211XH893)

Farb-Code F:

Rahmen Rot

(Kennziffer Palinal 211XH987)

2. - Rücklicht-Halterung:

Farb-Codes A-B-C:

Matt-Bronze B5 (Kennziffer Palinal 211F297)

Farb-Codes D-E-F:

Anthrazit-Grau metallisiert MV

(Kennziffer Yi-Mei AC MAT Black Silver)

3. - Motor:

Schwarz matt (Kennziffer Pulverit 3500/0085)

4. - Heckteil;

5. - Gabelbrücke:

Carbon-Grau metallisiert

(Kennziffer Palinal L921)

6. - Fulcrum Platte Schwinge rechts;

7. - Fulcrum Platte Schwinge links;

8. - Hintere Schwinge:

Carbon-Grau metallisiert

(Kennziffer Akzo Nobel RPU MIC 09 BP 1663/5)

9. - Hintere rechte Fußrastenhalterung;

10. - Hintere linke Fußrastenhalterung:

Aluminium-Grau fein metallisiert

(Kennziffer Palinal F444)



Informationshinweis

MV Agusta S.p.A. verfolgt eine Politik ständiger Verbesserung ihrer Produkte. Aus diesem Grund kann es vorkommen, dass kleine Abweichungen zwischen dem vorliegenden Dokument und dem von Ihnen erworbenen Fahrzeug bestehen. Die Modelle MV Agusta werden in zahlreiche Länder exportiert, in denen unterschiedliche Straßenverkehrsordnungen und Zulassungsverfahren bestehen. In der Hoffnung auf Ihr Verständnis behält sich MV Agusta S.p.A. deshalb das Recht vor, jederzeit und ohne Vorankündigung, Änderungen an ihren Produkten und den technischen Dokumentationen vorzunehmen.

Wir schlagen vor, um den Internetplatz www.mvagusta.it häufig zu besichtigen, um Informationen und Updates über die MV Agusta-Produkte und die in Verbindung stehenden Unterlagen zu erhalten.



Die Umwelt schützen und respektieren

Alles was wir tun hat Auswirkungen auf den gesamten Planeten und seine Ressourcen. Zum Schutz der Gemeinschaft weist MV Agusta die Kunden und die Angestellten im Kundendienst darauf hin, wie das Motorrad umweltschonend genutzt und Motorradbauteile und Flüssigkeiten entsprechend der geltenden Umweltschutzgesetze entsorgt bzw. dem Recycling zugeführt werden können.

© 2010

Die vollständige oder teilweise Vervielfältigung dieses Dokuments ist ohne vorherige schriftliche Genehmigung der MV Agusta

Teilnr. 8000B3379

Ausgabe Nr. 2 - Juli 2010



BRUTALE

1090

MV AGUSTA



Manual de mantenimiento

Versión en Español



ÍNDICE GENERAL

<i>Cap.</i>	<i>Descripción temas</i>	<i>pág.</i>
1	MANTENIMIENTO	3
1.1.	Símbolos	3
1.2.	Tablas de mantenimiento y control	4
1.3.	Utillaje y accesorios del equipamiento base	14
1.4.	Tabla de lubricantes y líquidos	15
1.5.	Aceite motor - Control nivel	16
1.5.1.	Aceite motor - Reposición nivel	17
1.6.	Líquido refrigerante - Control nivel	19
1.6.1.	Líquido refrigerante - Reposición nivel	20
1.7.	Pastillas frenos - Control desgaste	22
1.8.	Fluido mando frenos - Control nivel	23
1.9.	Fluido mando embrague - Control nivel	25
1.10.	Neumáticos - Control y cambio	26
1.11.	Cadena - Control y lubricación	32
1.12.	Ralentí - Control	36
1.13.	Sustituciones - Información general	37
1.13.1.	Fusibles - Sustitución	37
1.13.2.	Faro cruce - Sustitución bombilla	40
1.13.3.	Faro carretera - Sustitución bombilla	43
1.13.4.	Luz matrícula - Sustitución bombilla	44
1.14.	Batería	45
1.15.	Limpieza de la motocicleta	47
1.16.	Periodo de larga inactividad	50

<i>Cap.</i>	<i>Descripción temas</i>	<i>pág.</i>
2	AVERIAS	51
2.1.	Inconvenientes en el motor	51
2.2.	Inconvenientes en la instalación eléctrica	56
3	INFORMACIÓN TÉCNICA	59
3.1.	Descripción general de la motocicleta	59
3.1.1.	Circuito freno delantero	61
3.1.2.	Circuito freno trasero	62
3.1.3.	Circuito embrague	63
3.1.4.	Lubricación motor	64
3.1.5.	Circuito de refrigeración	65
3.1.6.	Circuito de alimentación	66
3.2.	Datos técnicos	67
3.3.	Referencias de los colores de las superestructuras	75
3.4.	Referencias colores componentes del bastidor y parte ciclística	77



1.1. Símbolos

Las partes del texto de particular importancia, correspondientes a la seguridad de la persona y a la integridad de la motocicleta, están evidenciadas con los siguientes símbolos:



Peligro - Atención: la falta o el incompleto cumplimiento de estas prescripciones puede comportar un grave peligro para su incolumidad o para la de otras personas.



Prudencia - Precaución: la falta o el incompleto cumplimiento de estas prescripciones puede comportar un riesgo de daños a la motocicleta.

Para indicar las personas autorizadas al desarrollo de las operaciones de ajustes y/o mantenimiento, las mismas se encuentran marcadas con los símbolos siguientes:



Información de las operaciones permitidas al motociclista.



Información de las operaciones que deben ser llevadas a cabo sólo por personal autorizado.

Para poner en evidencia ulteriores informaciones se utilizan los siguientes símbolos:



El símbolo  indica que es necesario utilizar una herramienta o utillaje específico para realizar correctamente la operación descrita.



El símbolo “§” indica que nos remitimos al capítulo indicado por el número que lo sigue.



1.2. Tablas de mantenimiento y control

Las operaciones de mantenimiento y control más importantes y su frecuencia están indicadas en las tablas específicas. Es indispensable efectuar éstas operaciones para, mantener la motocicleta eficiente y segura.

Los intervalos indicados en la tabla de la manutención periódica y de lubricación se deben considerar solo como una guía general en normales condiciones de marcha. Podría ser necesario reducir tales intervalos en función a las condiciones climáticas, del terreno, de la situación geográfica y del uso individual.

Algunas operaciones las puede efectuar el propietario de la motocicleta siempre que posea los conocimientos necesarios. En caso contrario haga efectuar las operaciones en un centro de asistencia autorizado.

En general las operaciones de mantenimiento se efectúan con la motocicleta colocada sobre el caballete trasero, con motor apagado y con interruptor en posición "OFF". Durante la verificación de los niveles de los líquidos en cambio es preferible tener la moto en posición vertical sin utilizar el caballete trasero.

Superados los 36.000 km (22400 mi), las operaciones se deben efectuar con la frecuencia indicada en las correspondientes tablas.



PELIGRO

- Una **manutención no correcta o la falta de realización de trabajos de manutención aconsejados, aumenta el riesgo de accidentes o de daños a la moto.**
- **Utilizar siempre recambios originales MV Agusta. El uso de recambios no originales puede acelerar el desgaste de la moto y reducir la durabilidad.**
- **La falta de realización de las operaciones recomendadas o la utilización de recambios no originales podía hacer la garantía ser inválida.**
- **El cambio y/o el restablecimiento del nivel de los lubricantes se debe realizar exclusivamente con los productos indicados en el §1.4.**



ATENCIÓN

En caso de utilizar la motocicleta en pistas, se recomienda hacerla controlar por personal especializado perteneciente a la red de Centros de Asistencia MV Agusta antes y después del uso.

La conducción en pista sólo está permitida en casos ocasionales y, de todas formas, sin fines agonísticos, aunque sea en calidad de aficionados.

El uso de la moto en pista comporta un significativo aumento del consumo de varios componentes, con una menor duración de los mismos respecto del uso normal en carreteras y autopistas.





ES 1

Tabla de mantenimiento programado

Frecuencia Mantenimiento Km (mi)		0	1000 (600)	6000 (3800)	12000 (7500)	18000 (11200)	24000 (14900)	30000 (18600)	36000 (22400)
Cupón		Pre-entrega	A	B	C	D	E	F	G
DESCRIPCIÓN		OPERACIÓN							
Aceite motor		Control nivel	Antes de usar el vehículo						
		Sustitución	●	●	●	●	●	●	●
Filtro aceite motor		Sustitución (Utilizar exclusivamente filtros de aceite originales MV Agusta)	●	●	●	●	●	●	●
			A cada sustitución del aceite motor						
Líquido de refrigeración		Control/Restablecimiento nivel	Antes de usar el vehículo						
		Control/Restablecimiento nivel	●	●	●	●	●	●	●
		Sustitución	Cada dos años						
Instalación de refrigeración		Control pérdidas	●	●	●	●	●	●	●
Electroventilador		Control funcionamiento	●	●	●	●	●	●	●
Válvulas		Control / Regulación			●		●		●
Cadena distribución		Control			●		●		
		Sustitución							●





Tabla de mantenimiento programado

1 ES

Frecuencia Mantenimiento Km (mi)		0	1000 (600)	6000 (3800)	12000 (7500)	18000 (11200)	24000 (14900)	30000 (18600)	36000 (22400)	
Cupón		Pre-entrega	A	B	C	D	E	F	G	
DESCRIPCIÓN		OPERACIÓN								
Patín móvil distribución		Control / Sustitución			●		●			
		Sustitución							●	
			De cualquier manera a cada cambio de cadena de la distribución							
Tensor cadena distribución		Control / Sustitución			●		●		●	
Bujías		Control / Sustitución		●		●		●		
		Sustitución			●		●		●	
Filtro gasolina		Control / Sustitución			●		●		●	
Cuerpo mariposa		Comprobación y Ajuste	●	●	●	●	●	●	●	
Filtro aire		Control / Sustitución		●	●	●	●	●	●	
Fluido frenos y embrague		Control nivel	Antes de usar el vehículo							
		Control nivel	●	●	●	●	●		●	●
		Sustitución						●		
			Cada dos años							





Tabla de mantenimiento programado

Frecuencia Manutención Km (mi)		0	1000 (600)	6000 (3800)	12000 (7500)	18000 (11200)	24000 (14900)	30000 (18600)	36000 (22400)
Cupón		Pre-entrega	A	B	C	D	E	F	G
DESCRIPCIÓN	OPERACIÓN								
Frenos/Embrague	Control funcionalidad	Antes de usar el vehículo							
	Limpieza área de contacto palanca/pistón de la bomba	Cada 500 ÷ 1000 km (300 ÷ 600 mi)							
	Control funcionalidad	●	●	●	●	●	●	●	●
	Control circuito	●	●	●	●	●	●	●	●
Pastillas frenos (delantero + trasero)	Limpieza área de contacto palanca/pistón de la bomba	●	●	●	●	●	●	●	●
	Control desgaste	Cada 1000 km (600 mi)							
Tubería circuito carburante	Control / Sustitución		●	●	●	●	●	●	●
	Control defectos y pérdidas		●	●	●	●	●	●	●
	Sustitución	De cualquier manera cada 3 años							
Mando acelerador	Control funcionalidad	Antes de usar el vehículo							
	Control funcionalidad	●	●	●	●	●	●	●	●
	Comprobación/ajuste juego	●	●	●	●	●	●	●	●
Mando starter	Control funcionalidad	●	●	●	●	●	●	●	●



Tabla de mantenimiento programado

Frecuencia Manutención Km (mi)		0	1000 (600)	6000 (3800)	12000 (7500)	18000 (11200)	24000 (14900)	30000 (18600)	36000 (22400)	
Cupón		Pre-entrega	A	B	C	D	E	F	G	
DESCRIPCIÓN		OPERACIÓN								
Transmisiones y mandos flexibles		Control / Regulación	●	●	●	●	●	●	●	
Cadena de transmisión 		Control	Cada 1000 Km (600 mi)							
		Lubrificación	Cada 1000 km (600 mi) y después de conducción con lluvia							
	Control / Regulación	●	●	●	●	●	●	●	●	
	Lubrificación		●	●		●		●		
	Sustitución				●		●		●	
Piñón / Arandela de fijación		Control		●	●		●		●	
		Sustitución				●		●		●
		De cualquier manera a cada cambio de la cadena de transmisión								
Corona		Control		●	●		●		●	
		Sustitución				●		●		●
		De cualquier manera a cada cambio de la cadena de transmisión								



Tabla de mantenimiento programado

Frecuencia Mantenimiento Km (mi)		0	1000 (600)	6000 (3800)	12000 (7500)	18000 (11200)	24000 (14900)	30000 (18600)	36000 (22400)
Cupón		Pre-entrega	A	B	C	D	E	F	G
DESCRIPCIÓN		OPERACIÓN							
Aceite motor		Control nivel	Antes de usar el vehículo						
		Sustitución	●	●	●	●	●	●	●
			Cada año						
Filtro aceite motor		Sustitución (Utilizar exclusivamente filtros de aceite originales MV Agusta)	●	●	●	●	●	●	●
				A cada sustitución del aceite motor					
Líquido de refrigeración		Control/Restablecimiento nivel	Antes de usar el vehículo						
		Control/Restablecimiento nivel	●	●	●	●	●	●	●
		Sustitución	Cada dos años						
Instalación de refrigeración		Control pérdidas	●	●	●	●	●	●	●
Electroventilador		Control funcionamiento	●	●	●	●	●	●	●
Válvulas		Control / Regulación			●		●		●
Cadena distribución		Control			●		●		
		Sustitución							●



Tabla de mantenimiento programado

1 ES















Frecuencia Manutención Km (mi)		0	1000 (600)	6000 (3800)	12000 (7500)	18000 (11200)	24000 (14900)	30000 (18600)	36000 (22400)
Cupón		Pre-entrega	A	B	C	D	E	F	G
DESCRIPCIÓN	OPERACIÓN								
Caballete lateral	 Control funcionalidad	Antes de usar el vehículo							
	 Control funcionalidad	●	●	●	●	●	●	●	●
Interruptor caballete lateral	 Control funcionalidad	Antes de usar el vehículo							
	 Limpieza área de contacto con el caballete lateral	Cada 500 ÷ 1000 km (300 ÷ 600 mi)							
	 Control funcionalidad	●	●	●	●	●	●	●	●
Buje rueda trasera 	 Limpieza área de contacto con el caballete lateral	●	●	●	●	●	●	●	●
	 Control / Lubricación cojinetes de rodillo				●		●		
	 Sustitución/ Lubricación cojinetes de rodillo								●
Cojinetes horquilla	 Control / Lubricación								●
Patines cadena horquilla	 Control / Sustitución		●	●	●	●	●	●	●
Patines cadena placa bastidor	 Control / Sustitución		●	●	●	●	●	●	●
Amortiguador trasero	 Control / Regulación		●		●		●		●
Aceite horquilla delantera 	 Sustitución						●		









Tabla de mantenimiento programado

Frecuencia Mantenimiento Km (mi)		0	1000 (600)	6000 (3800)	12000 (7500)	18000 (11200)	24000 (14900)	30000 (18600)	36000 (22400)
Cupón		Pre-entrega	A	B	C	D	E	F	G
DESCRIPCIÓN	OPERACIÓN								
Conexiones batería	Control y limpieza		●	●	●	●	●	●	●
Instalación eléctrica	Control funcionalidad	●	●	●	●	●	●	●	●
Instrumentos	Control funcionalidad	Antes de usar el vehículo							
	Control funcionalidad	●	●	●	●	●	●	●	●
Luces / Señales visivas	Control funcionalidad / Sustitución bombilla	Antes de usar el vehículo							
	Control funcionalidad / Sustitución bombilla	●	●	●	●	●	●	●	●
Claxon	Control funcionalidad	Antes de usar el vehículo							
	Control funcionalidad	●	●	●	●	●	●	●	●
Faro delantero	Control funcionalidad	Antes de usar el vehículo							
	Regulación	A cada modificación del equilibrado y a cada uso con el pasajero							
	Control funcionalidad	●	●	●	●	●	●	●	●
Interruptor encendido	Control funcionalidad	Antes de usar el vehículo							
	Control funcionalidad	●	●	●	●	●	●	●	●



Tabla de mantenimiento programado

Frecuencia Mantenimiento Km (mi)		0	1000 (600)	6000 (3800)	12000 (7500)	18000 (11200)	24000 (14900)	30000 (18600)	36000 (22400)
Cupón		Pre-entrega	A	B	C	D	E	F	G
DESCRIPCIÓN		OPERACIÓN							
Cerraduras		Control funcionalidad	Antes de usar el vehículo						
		Control funcionalidad	●	●	●	●	●	●	●
Apriete tornillos y tuercas		Verificación / apriete	●	●	●	●	●	●	●
Abrazaderas 		Verificación / apriete	●	●	●	●	●	●	●
Lubricación general			●	●	●	●	●	●	●
Prueba motocicleta			●	●	●	●	●	●	●



ES
1

1.3. Utilaje y accesorios del equipamiento base

Se suministra, en el hueco portaobjetos, una bolsa que contiene las siguientes herramientas:

- n. 1 barra hexagonal (hexágono de 10 mm);
- n. 6 llaves macho hexagonal (hexágono de 2,5-3-4-5-6-8 mm);
- n. 1 llave para excéntrico rueda trasera y correspondiente prolongación;
- 1 extractor para fusibles;
- 3 fusibles (5A - 7,5A - 15A).

Se proporcionan además los siguientes accesorios:

- n. 1 llave para bujías (hexágono de 16 mm);
- n. 1 portadocumentos.





1.4. Tabla lubricantes y líquidos

Descripción	Características	Producto aconsejado
Aceite lubricación motor	AGIP RACING 4T 10W/60 (*)	SAE 10W/60 - API SJ
Líquido de refrigeración	AGIP ECO - PERMANENT	Glicol - Etilénico diluido con 50% de agua destilada
Fluido mando embrague y frenos	AGIP BRAKE FLUID DOT4	DOT4
Aceite lubricación cadena	MOTUL CHAIN LUBE ROAD	-

* : Para encontrar fácilmente los productos recomendados, MV Agusta aconseja dirigirse directamente a los propios concesionarios autorizados. El aceite para motor AGIP Racing 4T 10W/60 ha sido realizado especialmente para el motor de la motocicleta Brutale. En el caso que el lubricante descrito no se consiga, MV Agusta aconseja utilizar aceites completamente sintéticos con características conformes o superiores a las siguientes normas:

- Conforme API SJ
- Conforme ACEA A3
- Conforme JASO MA
- Gradación SAE 20 W-50 o 10 W-60

NOTA

Las especificaciones indicadas deben estar presentes, por sí solas o junto a otras, en el envase del aceite lubricante.





ES
1

1.5. Aceite motor - Control nivel

Efectúe el control en frío, con motor apagado. Si se efectúa en caliente, apague el motor y espere por lo menos 10 minutos.

Este control se debe realizar colocando la motocicleta en un plano horizontal y en posición de la marcha (posición vertical).

El nivel tiene que estar comprendido entre las referencias MAX y MIN indicadas en el cárter.

En el caso que el nivel del aceite se encuentre por debajo de la referencia MIN, añadir (ver § 1.5.1).



Peligro - Atención: no arranque el motor si el aceite está por debajo de la referencia de MIN.

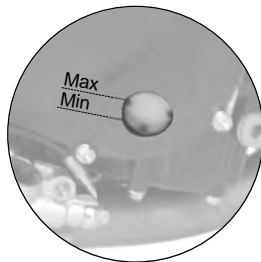



1.5.1. Aceite motor - Reposición nivel

Para restablecer el nivel es necesario destornillar la tapa del aceite usando la barra hexagonal de 10 mm suministrada, montada en una llave apropiada (véase figura). Echar una cantidad de aceite del tipo recomendado hasta alcanzar el nivel correcto; de cualquier manera no superar nunca la marca MAX. Enroscar nuevamente la tapa una vez terminada la operación.



PELIGRO

Antes de volver a montar el tapón del aceite, engrase su anillo usando AGIP Grease 30.

En el último, apriete el tapón del aceite en el par de apriete de 35 Nm, usando una llave dinamométrica.

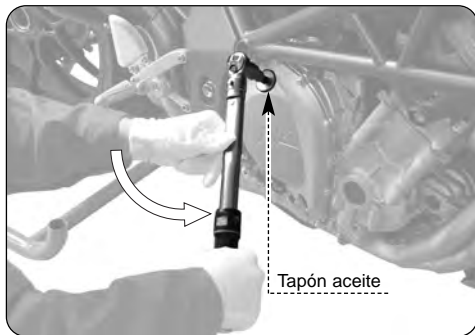

PRUDENCIA - PRECAUCION

Para evitar deslizamientos del embrague y consiguiente daño del motor, no mezclar aditivos químicos al aceite, ni utilizar aceites distintos del tipo indicado en el § 1.4. Asegurarse que no se introduzcan cuerpos extraños en el cárter durante el llenado.



ES
1



PELIGRO

El aceite nuevo o exhausto puede ser peligroso. La ingestión del aceite del motor, nuevo o exhausto puede ser nocivo para las personas y para los animales domésticos. En caso de ingestión del aceite del motor, llamar inmediatamente un médico y no provocar vómito para evitar la aspiración del producto en los pulmones. Ha sido constatado que el contacto continuado con el aceite produce cáncer en la piel en ratones para experimentación. Breves contactos con el aceite del motor pueden producir irritación de la piel.

- Tener el aceite del motor, nuevo o exhausto lejos del alcance de los niños y de animales domésticos.
- Ponerse ropa con mangas largas y guantes impermeables al agua cada vez que se efectúa el llenado del aceite del motor.
- Lavarse con agua y jabón, si el aceite del motor entra en contacto con la piel.
- Reciclar o eliminar correctamente el aceite motor exhausto.



1.6. Líquido refrigerante - Control nivel

Efectúe el control en frío, con el motor apagado. Este control se debe efectuar colocando la motocicleta en un plano horizontal y en posición de marcha (posición vertical).

El nivel tiene que estar comprendido entre la referencia de MIN y la parte más inferior del tubo del chasis según lo demostrado en la figura.

En el caso que el nivel del líquido refrigerante se encuentre por debajo de la marca MIN, añadir (ver § 1.6.1).



PELIGRO

No utilizar la motocicleta si el nivel del líquido refrigerante se encuentra por debajo de la marca MIN.

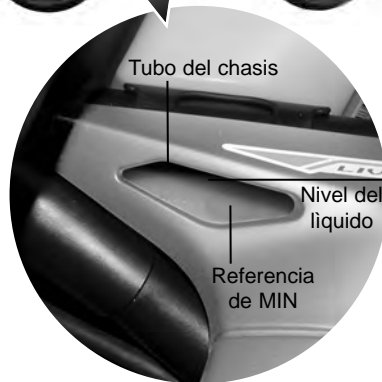



ES 1

1.6.1. Líquido refrigerante - Reposición nivel

Para acceder a la tapa extraer la cobertura quitando antes los tornillos de sujeción correspondiente. Desenroscar la tapa y llenar con líquido refrigerante aconsejado en el § 1.4.

Tapa llenado líquido refrigerante

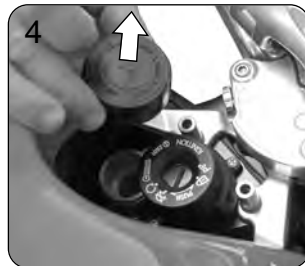
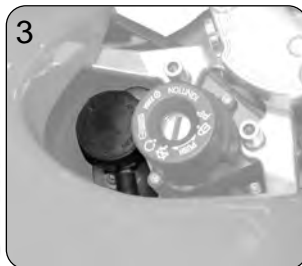
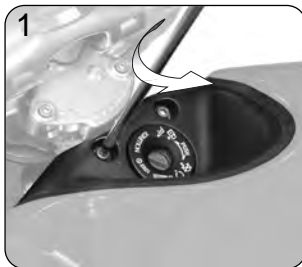

Después de la reposición del nivel, vuelva a montar cuidadosamente las piezas anteriormente desmontadas.



PELIGRO: El depósito se debe llenar con el motor frío. No intentar nunca quitar la tapa del depósito del líquido refrigerante cuando el motor está caliente para evitar quemaduras. El circuito se encuentra bajo presión.



PRUDENCIA - PRECAUCION:

Para restablecer el nivel del líquido refrigerante y/o substituir el líquido refrigerante, usar exclusivamente el producto específico de la tabla § 1.4. No mezcle ni no diluya el líquido refrigerante con aditivos o diversos líquidos. Si el líquido refrigerante especificado en la tabla § 1.4. no está disponible, utilice un líquido refrigerante con características técnicas conformes al producto prescrito.



PRUDENCIA - PRECAUCION:

Las salpicaduras del líquido refrigerante pueden dañar las superficies pintadas. Tener cuidado en no derramar el líquido cuando llenamos el circuito de refrigeración. Secar inmediatamente con un trapo limpio el líquido derramado.



PELIGRO:

En determinadas condiciones el glicol etílico contenido en el líquido refrigerante es inflamable y la llama es invisible. Evitar que el líquido refrigerante vaya a contacto con partes calientes, puesto que con la combustión del glicol etílico podría haber peligro de quemaduras.



PELIGRO:

El líquido refrigerante del motor es nocivo si es ingerido o a contacto con los ojos y la piel. Tener el líquido refrigerante del motor lejos del alcance de los niños y de los animales domésticos. En caso de ingestión del líquido refrigerante llamar inmediatamente un médico y no provocar vómito para evitar aspiraciones del producto en los pulmones. En caso de contacto del líquido refrigerante del motor con los ojos o la piel, lavar inmediatamente con agua.



ES 1

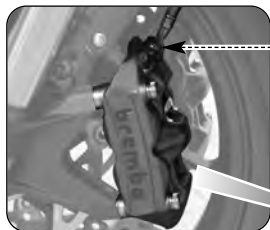

Pinza freno delantero

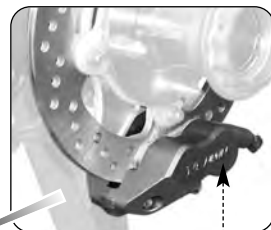

Pinza freno trasero

Disco freno

Pastillas

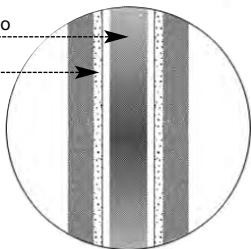

Límite de desgaste 1 mm

1.7. Pastillas frenos - Control desgaste

Verificar periódicamente el espesor de la capa del material de la fricción de las pastillas, teniendo cuidado en no superar el límite de desgaste (1 mm).



Peligro - Atención: Si se utiliza la moto con las pastillas de frenos desgastadas, la fuerza de la frenada disminuye y aumenta el riesgo de accidentes. Si el espesor residuo está cerca del límite de desgaste, dirigirse a un centro de asistencia autorizado para cambiar las pastillas. Someter las pastillas nuevas a un oportuno rodaje.



Depósito freno trasero

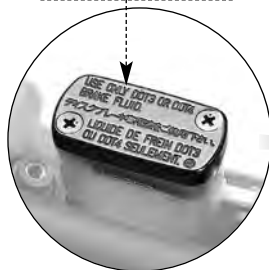

Depósito freno delantero



1.8. Fluido mando frenos - Control nivel



PELIGRO

La falta de control y una manutención incorrecta de los frenos aumenta el riesgo de accidentes. Antes de salir con la moto, controlar el sistema de frenos según las instrucciones indicadas en el Quick Manual.

El desgaste de las pastillas de los frenos provoca una normal disminución del nivel del fluido. De cualquier manera el nivel debe estar comprendido entre las marcas MAX y MIN. Si tal nivel desciende por debajo de la referencia MIN, es necesario dirigirse a un centro de asistencia autorizado para un control general de la instalación de frenado.

**PELIGRO**

No usar la motocicleta si el nivel se encuentra por debajo de la marca MIN; en tales condiciones el circuito de frenos podría funcionar no correctamente provocando la pérdida del control del vehículo y accidentes. Si el nivel del líquido se encuentra por debajo de la marca MIN, dirigirse a un concesionario MV Agusta para efectuar la comprobación del sistema de frenos.

**PELIGRO**

Hacer añadir líquido de frenos exclusivamente por personas autorizadas. El líquido de frenos es nocivo o mortal si es ingerido, y es nocivo a contacto con la piel y los ojos. Tener el líquido lejos del alcance de los niños y de animales domésticos. En el caso de ingestión del líquido de frenos llamar inmediatamente un médico y no provocar vómito para evitar aspiraciones en los pulmones. En el caso de contacto del líquido con los ojos o con la piel, lavarse inmediatamente con agua.

**PELIGRO**

Hacer añadir líquido de frenos utilizando exclusivamente el tipo de líquido recomendado en el § 1.4. de éste manual. Eventuales mezclas con tipos diferentes pueden provocar una reacción química peligrosa y la disminución de la eficiencia de la frenada, con consiguiente aumento del riesgo de accidentes.

**PELIGRO**

Una cantidad insuficiente del líquido de frenos puede permitir la entrada de aire en el circuito de frenos, perjudicando la eficiencia de la frenada con consiguiente aumento del riesgo de accidentes. La presencia de aire en el circuito hidráulico se podría notar en el caso que apretando la palanca del freno, se advirtiera poca resistencia. En el caso que haya aire en el circuito hidráulico, realizar el expurgo en un concesionario MV Agusta antes de utilizar el vehículo.



1.9. Fluido mando embrague - Control nivel

El nivel tiene que estar comprendido entre las referencias MAX y MIN. Si tal nivel desciende por debajo de la referencia MIN, es necesario dirigirse a un centro de asistencia autorizado para un control general de la instalación mando embrague.



PELIGRO

No utilizar la motocicleta si el nivel se encuentra por debajo de la marca MIN; en éstas condiciones el circuito de mando del embrague podría no funcionar correctamente, con el consiguiente riesgo de pérdida del control del vehículo y accidentes. Si el líquido se encuentra por debajo de la marca MIN, dirigirse a un concesionario MV Agusta para efectuar la comprobación del sistema de embrague.



PELIGRO

Realizar el llenado del líquido mando embrague utilizando solamente el tipo de líquido recomendado en el § 1.4. de éste manual.





1.10. Neumáticos - Control y cambio



ATENCIÓN

Antes de usar el vehículo verificar siempre la presión de los neumáticos y las condiciones de desgaste.

El control de la presión de los neumáticos es un factor fundamental para garantizar seguridad en la conducción. Los neumáticos no inflados suficientemente empeoran la manejabilidad de la moto y se desgastan rápidamente; de lo contrario, presiones muy altas determinan menor superficie de contacto con el suelo y pueden reducir la adherencia del vehículo.

Antes de usar la moto es por lo tanto indispensable efectuar el control de la presión con los neumáticos a temperatura ambiente, es decir con la moto estacionada por tres horas.



PELIGRO

Un errado inflado de los neumáticos produce serios peligros durante el uso de la moto. Una presión insuficiente puede provocar el deslizamiento del neumático en la llanta o el desprendimiento con consiguiente aflojamiento del neumático y pérdida de control del vehículo.



Efectuar controles inmediatamente después de haber usado la moto, se obtendrían valores más altos respecto a los efectivos y esto llevaría a una errada regulación de la presión de los neumáticos. El control de la presión de los neumáticos se debe realizar respetando los valores indicados en el § 2.2. y/o en la pegatina colocada el parabrisas. En el caso de largos recorridos aumentar el valor de la presión nominal de 0,2 bar.

Además antes del uso es extremadamente importante verificar las condiciones de desgaste de los neumáticos; los neumáticos desgastados están sometidos a pinchazos con mayor facilidad e influyen negativamente con la estabilidad y la manejabilidad de la moto. Durante la verificación asegurarse que la banda de rodadura no se encuentre por debajo del límite prescrito por el código del tránsito y que no tengan grietas. Además no deben tener clavos o fragmentos de vidrio, y los laterales no deben estar fisurados. Presentando alguna de estas condiciones hacer

cambiar inmediatamente el neumático por un concesionario MV Agusta.



PELIGRO

El límite de la profundidad puede variar de un país a otro. Respetar siempre las disposiciones de la ley del país donde se utiliza el vehículo.



PELIGRO

• Hacer cambiar los neumáticos excesivamente desgastados, por un concesionario MV Agusta. Además de ser ilegal, la utilización de la motocicleta con neumáticos excesivamente desgastados, reduce la estabilidad de la marcha y puede provocar la pérdida de control del vehículo.

• Si un neumático está pinchado o dañado no debe ser reparado, debe ser sustituido. Un neumático reparado garantiza prestaciones limitadas y nivel



de seguridad inferior respecto a un neumático nuevo. Si se realiza una reparación provisoria o de emergencia a un neumático, conducir lentamente y con cautela hasta el mas cercano concesionario MV Agusta y cambiar el neumático. Después de la reparación de un neumático no alcanzar nunca la velocidad de 60 Km/h. La reparación no se puede realizar si el neumático está pinchado lateralmente, o si el agujero en la banda de rodado es mayor de 6 mm.

- Para la reparación de un neumático pinchado, MV Agusta recomienda no utilizar pegamentos líquidos. Estos pegamentos pueden influir negativamente en el material de las capas del neumático y no evidenciar daños secundarios provocados por eventuales objetos de penetración.

- Sustituir los neumáticos utilizando exclusivamente los prescritos en el § 2.2. Evitar además utilizar al mismo tiempo neumáticos del tipo y marca distintos entre ellos en la rueda delantera y trasera. Utilizar neumáticos no correctos puede influir negativamente en la manejabilidad y la estabilidad de la motocicleta, aumentando el riesgo de accidentes.

- Las llantas de la motocicleta han sido proyectadas para la utilización de neumáticos tubeless. No instalar neumáticos del tipo con cámara de aire en llantas para neumáticos tubeless. Los talones del neumático podrían no ajustarse correctamente y salir de las llantas, provocando el desinflado de los mismos con pérdida de control del vehículo.



- No instalar una cámara de aire en un neumático tubeless. El recalentamiento del neumático podría provocar la explosión de la cámara de aire provocando el desinflado del mismo con pérdida de control del vehículo.
- Montar un neumático de acuerdo a la dirección de rotación indicado por la flecha ubicada en los laterales de cada neumático.

- Los neumáticos nuevos deben ser sometidos a un periodo de rodaje antes de alcanzar la completa eficiencia; durante ésta fase es por lo tanto posible que los neumáticos tengan una adherencia relativamente escasa en determinadas superficies. Recomendamos por lo tanto conducir a una velocidad moderada y usar extrema cautela en la conducción por unos 100 km después del montaje del neumático nuevo.



❑ Desmontaje de la rueda trasera



Prudencia - Precaución: En el caso fuera necesario cambiar el neumático trasero en un taller, cerciorares que en el desmontaje y el montaje de la rueda sean utilizados el siguiente útilaje:

- Llave tubular poligonal de 55 mm
- Llave dinamométrica

Si dichas operaciones se realizaran con herramientas distintas, los componentes de la rueda trasera podrían dañarse seriamente. Aconsejamos por lo tanto no sustituir el neumático en un taller sin utillaje adecuado; de cualquier manera es preferible dirigirse a un concesionario MV Agusta.

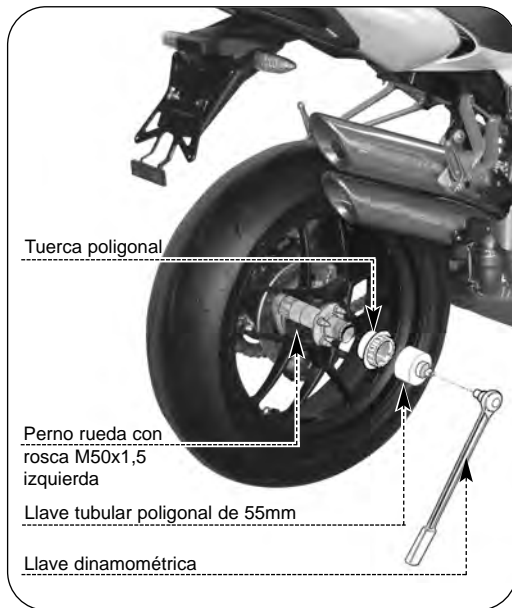



□ Control de las ruedas

Antes de utilizar el vehículo controlar siempre que la llanta de la rueda no tenga grietas, pliegues o deformaciones.



PELIGRO

Si se encontraran daños, cambiar la rueda en un concesionario MV Agusta. No intentar efectuar reparaciones en la rueda aunque sean pequeñas.

En el caso de cambio de neumáticos o de la rueda, es necesario efectuar el balanceo de la rueda en un concesionario MV Agusta. El desequilibrio de la rueda puede perjudicar el rendimiento y la manejabilidad del vehículo y reducir la durabilidad de los neumáticos.



PELIGRO

Para efectuar el balanceo de la rueda utilizar exclusivamente contrapesos homologados. No es recomendable utilizar balanceadores líquidos o balanceadores líquidos/sellantes.



PELIGRO

No intentar quitar un neumático tubeless sin el utillaje específico necesario y las protecciones para la llanta. De lo contrario, podría dañarse o deformarse la superficie de sellado de la misma llanta, provocando el desinflado del neumático con pérdida de control del vehículo.



1.11. Cadena - Control y lubricación

Para efectuar las siguientes operaciones colocar la motocicleta sobre el caballete trasero, en un plano horizontal y con el cambio en neutro.

□ Control de la regulación



PELIGRO: Antes de comprobar el ajuste de cadena, dirigirse a un centro autorizado MV Agusta para verificar que el valor del equilibrio estático de la suspensión posterior está correcto. También cerciorarse de que la cadena esté lubricada correctamente.

El eje de la parte inferior de la cadena debe estar a una distancia de **50 mm** del cubrecadena inferior. Efectuar el control en varios puntos de la cadena girando manualmente la rueda trasera. El juego debe quedar prácticamente constante mientras gira la rueda; si la cadena presenta fuertes variaciones del juego, esto indica que algunas eslabones están aplastados, bloqueados o alargados. Si la distancia de la cadena del cubrecadena inferior es mayor de 50 mm, es necesario ajustar la cadena.

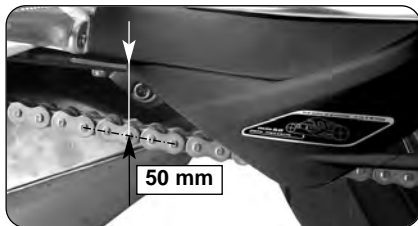

NOTA

A solicitud es posible pedir un especial cubrecadena superior alargado al Servicio Recambios MV Agusta.

El montaje de este componente en su motocicleta da una protección mejor que un componente estándar.





PELIGRO: Usar la motocicleta con la cadena en malas condiciones o mal regulada puede ser causa de accidentes. Antes de salir con la moto, efectuar el control de la cadena de acuerdo al presente capítulo. En el caso fuera necesaria la regulación de la tensión de la cadena, dirigirse a un centro asistencia autorizado MV Agusta.



PELIGRO: Si la cadena tiene eslabones aplastados, bloqueados o alargados, hacer la sustitución de la cadena por un centro asistencia autorizado MV Agusta.



PELIGRO: Si se detectan daños o desgaste excesivo de la cadena o de sus engranajes, es necesario dirigirse a un concesionario MV Agusta para la sustitución. Cada vez que se cambia una cadena, también los engranajes correspondientes deben ser sustituidos.



PELIGRO

Puede ser peligroso utilizar una cadena del tipo con falso eslabón. Un eslabón principal no remachada completamente o del tipo falso eslabón, puede abrirse y provocar accidentes o graves daños al motor. No utilizar nunca cadenas con falso eslabón.



PELIGRO

Cada vez que se solicita de funcionar los tornillos del cubo de la rueda posterior, dirigirse a un centro autorizado MV Agusta. Para apretar los tornillos, aplique un par de apriete igual al valor mostrado en la etiqueta puesta sobre el monobrazo. El uso de un par de apriete mayor que el valor indicado puede causar el decaimiento rápido del cubo de la rueda posterior, comprometiendo la confiabilidad del vehículo y la seguridad del piloto y del pasajero.



❑ Lubricación

La cadena debe estar correctamente lubricada para garantizar la máxima eficiencia.

► Limpieza preliminar: antes de efectuar la lubricación es necesario disolver los depósitos de suciedad en la cadena utilizando kerosene; estos depósitos deben ser sucesivamente eliminados con un trapo limpio y/o un chorro de aire.



Prudencia - Precaución: la cadena es del tipo con retenedores (O-RING); para evitar daños, no efectuar la limpieza de la cadena con chorros de vapor o agua con alta presión, ni utilizar gasolina o disolventes detergentes en comercio. La limpieza de la cadena se debe realizar exclusivamente con kerosene.





PELIGRO

El kerosene puede ser peligroso. El kerosene es inflamable. El contacto con el kerosene puede ser nocivo para los niños y los animales domésticos. Tener las llamas libres y objetos con temperatura elevada lejos del kerosene. Tener los niños y los animales domésticos lejos del kerosene. Eliminar de manera correcta el kerosene usado.



► **Lubricación:** aplicar una capa ligera y uniforme en toda la cadena teniendo cuidado en no echar en las zonas circunstantes, especialmente en los neumáticos. Dirigir el aerosol del lubricante en los eslabones internos, para lubricar la superficie de los anillos de sellado y penetrar dentro del rodillo de cadena.

 **Prudencia - Precaución:** utilizar solamente el lubricante específico de la tabla § 1.4., para proteger la cadena de transmisión y evitar chorros de aceite cuando el vehículo está en movimiento.

 **PELIGRO:** La lubricación de la cadena se debe realizar según los intervalos indicados en la Tabla de Manutención Programada de éste manual (ver § 1.2.). Es necesario efectuar ésta operación también después de haber conducido con lluvia o después de cada lavado de la motocicleta. Usar la motocicleta con la cadena en malas condiciones o no lubricadas puede generar accidentes.



1 ES

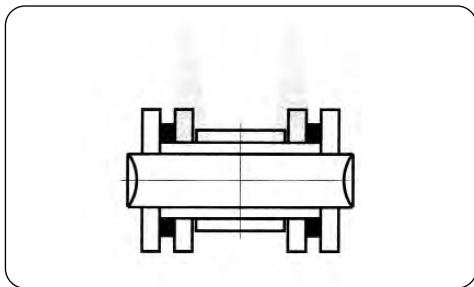



ES
1

1.12. Ralentí - Control

Efectúe el control con el motor a la temperatura de ejercicio y verifique que el dispositivo “CHOKE” no esté conectado.

El ralentí debe estar comprendido entre 1150 y 1250 rpm.





Si fuera necesario efectuar el ajuste, diríjase a los centros de asistencia autorizados.





1.13. Sustituciones - Información generales

La sustitución de los fusibles y de las bombillas pueden ser efectuadas por el motociclista, siguiendo correctamente las indicaciones proporcionadas.

	Fusible de recarga batería - Sustitución (§1.13.1.)
	Fusibles - Sustitución (§1.13.1.)
	Faro cruce - Sustitución bombilla (§1.13.2.)
	Faro carretera - Sustitución bombilla (§1.13.3.)
	Luz matrícula - Sustitución bombilla (§1.13.4.)

1.13.1. Fusibles - Sustitución

► El fusible de recarga batería se encuentra ubicado debajo del sillín del piloto en la posición indicada.

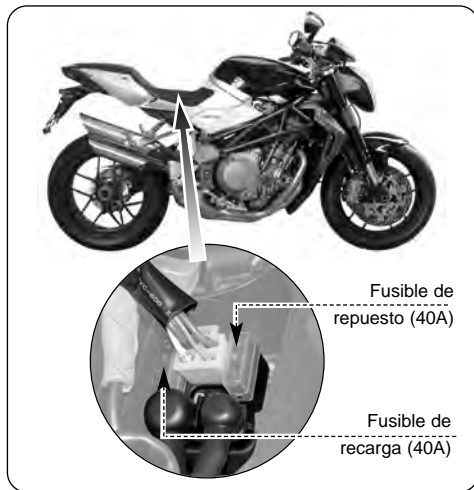



ES
1

► La caja de fusibles se encuentra bajo el sillín del acompañante. Para acceder a la caja de fusibles debe levantar el sillín del conductor y destornillar luego el sillín del acompañante.



► Desenganche y levante la tapa de la caja para acceder a los fusibles.





► Para identificar la posición y la función de los fusibles, consulte la información indicada en el adhesivo y en el esquema eléctrico adjunto; las letras de referencia indicadas en la figura corresponden a las indicadas en el esquema.

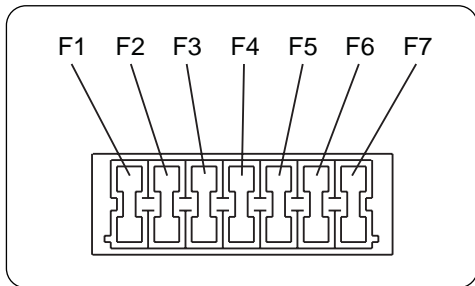

1 ES

► Sustituya el fusible quemado y vuelva a montar la tapa.
Tenga presente que en la bolsa porta herramientas hay tres fusibles de repuesto.



PELIGRO

No utilizar nunca fusibles con valores distintos de los indicados, para evitar el daño a la instalación eléctrica de la motocicleta con peligro de incendio





1.13.2. Faro cruce - Sustitución bombilla

► Quitar los dos tornillos laterales que fijan el farol delantero. Tener cuidado en la extracción del regulador de su propio asiento en el momento en el cual el faro es extraído del soporte.

► Antes de quitar el faro delantero del soporte, desconectar los conectores ubicados en la parte posterior del faro.

► Colocar el faro en una mesa con el fin de poder efectuar las siguientes operaciones.





- ▶ Quitar el tornillo posterior del faro.
- ▶ Quitar la parte delantera del faro de su soporte.



1 ES

- ▶ Quitar la protección.





ES 1

- ▶ Desconectar el conector del faro luz de cruce.
- ▶ Desenganchar el muelle de retención.
- ▶ Extraer la bombilla del faro luz de carretera.

 **Prudencia - Precaución: no toque el vidrio de las bombillas con las manos. En caso de contacto limpie con un producto desengrasante.**

- ▶ Colocar una bombilla nueva.
- ▶ Enganchar nuevamente el muelle de retención.
- ▶ Conectar nuevamente el conector del faro luz de cruce.
- ▶ Colocar nuevamente en su posición la protección.
- ▶ Montar nuevamente la parte delantera del faro en su soporte.
- ▶ Enroscar nuevamente el tornillo posterior.
- ▶ Conectar nuevamente el conector del faro.
- ▶ Colocar nuevamente el faro en su soporte y enroscar los dos tornillo de fijación lateral, prestando atención en colocar el regulador en su alojamiento.





1.13.3. Faro carretera - Sustitución bombilla

- ▶ Extraer el faro delantero de su soporte como descrito en § 1.13.2.
- ▶ Quite la bombilla de la luz larga presionando el conector desde el costado y tirándola hacia fuera.
- ▶ Desconectar de la bombilla el conector.



Prudencia - Precaución: no toque el vidrio de las bombillas con las manos. En caso de contacto limpie con un producto desengrasante.

- ▶ Introducir el conector en la bombilla nueva.
- ▶ Coloque la bombilla empujándola hasta el fondo.
- ▶ Montar nuevamente el faro en su soporte siguiendo las operaciones descritas en § 1.13.2.





1.13.4. Luz matrícula - Sustitución bombilla

- ▶ Quitar el tornillo de fijación del guía cables.
- ▶ Actuando de la manera representado en la figura, bajar el guía cables separándolo de la superficie de apoyo superior.



- ▶ Extraer el portalámparas de la luz placa de identificación.
- ▶ Extraer la bombilla del portalámparas.
- ▶ Introducir la bombilla nueva.
- ▶ Introducir nuevamente el portalámparas.
- ▶ Colocar nuevamente el guía cables a contacto con la superficie de apoyo superior.
- ▶ Enroscar nuevamente el tornillo de fijación del guía cables.





1.14. Batería

Esta motocicleta está equipada con una batería hermética instalada debajo de la cola. La batería no precisa mantenimiento, por lo tanto no es necesario ni verificar el líquido ni añadir agua destilada.

Si la batería parece estar descargada (provocando problemas eléctricos o dificultad de arranque), hacerla cargar lo antes posible en un concesionario MV Agusta. Tener presente que la batería se descarga más rápido si la motocicleta posee accesorios eléctricos opcionales.



PELIGRO

Si la parte externa de la batería está dañada puede verificarse salida de ácido sulfúrico, sustancia venenosa y extremadamente corrosiva. Evitar contactos con la piel, los ojos y la ropa y proteger siempre los ojos cuando trabajamos cerca de la batería.

En caso de contacto, prestar los **PRIMEROS AUXILIOS** de la siguiente manera.

- **CONTACTO EXTERNO:** Enjuagar con mucha agua.
- **CONTACTO INTERNO:** Tomar mucha agua o leche y llamar inmediatamente un médico.
- **OJOS:** Lavar con agua por 15 minutos y dirigirse inmediatamente a un médico. La salida del ácido sulfúrico provoca la formación de hidrógeno, el cual puede provocar una explosión en presencia de chispas o llamas.

Para efectuar la sustitución de la batería es necesario dirigirse a un centro autorizado MV Agusta.



ES 1

Larga inactividad

Si la motocicleta no será utilizada por largo tiempo (un mes o más), se recomienda desconectar los cables de la batería o desmontarla por un mecánico calificado. En caso de larga inactividad se recomienda hacer cargar la batería por un concesionario MV Agusta cada 4-5 meses, para garantizar la durabilidad.



PELIGRO: Invertir los cables de la batería puede dañar el circuito de recarga y la misma batería. Los cables rojos se deben conectar al borne positivo (+) de la batería y los negros se deben conectar al borne negativo (-). En el desmontaje de la batería desconectar **ANTES** el borne del polo negativo, y luego el del polo positivo. Para el montaje proceder de manera contraria al desmontaje.





1.15. Limpieza de la motocicleta

La limpieza periódica y cuidadosa es importante para mantener en el tiempo el valor de la motocicleta, proteger el acabado de la superficie y controlar que no haya daños, desgastes o pérdida de líquido corrosivo.



Prudencia - Precaución: antes de efectuar el lavado tapar los tubos de escape y proteger las partes eléctricas.



PELIGRO
Si la motocicleta está aún caliente, esperar que el motor y el escape estén fríos.



Prudencia - precaución: No utilizar máquinas de lavado con chorros de agua de alta presión o de vapor, puesto que pueden provocar infiltraciones de agua y dañar componentes de la motocicleta.



NOTA: Los detergentes contaminan el medioambiente. Por lo tanto la limpieza del vehículo debe ser realizada en una area equipada para la recolección y la depuración del líquido utilizado para el lavado.





Lavar con agua y esponja y no usar detergentes agresivos. Secar con un trapo suave. En las zonas menos accesibles usar un chorro de aire.



Prudencia - Precaución:

- Asegurarse que los trapos usados no hayan estado en contacto con productos de limpieza fuertes o abrasivos, disolventes, alcohol o gasolina.
- Para evitar daños irreversibles en los componentes de la carrocería no usar detergentes alcalinos o con elevada acidez, gasolina, líquido para frenos o otros disolventes.
- Si tienes dudas sobre la composición química del detergente, prueba su efecto aplicándolo en una poca área de la carrocería antes de usarlo en la motocicleta entera.

Periódicamente, tratar las partes pintadas con productos específicos. Si recorremos calles tratadas con productos corrosivos (sal) efectuar el

lavado apenas posible, utilizando agua fría; el agua caliente favorece la acción corrosiva.



PELIGRO: Asegurarse que no haya aceite o cera en los frenos o en los neumáticos. Si fuera necesario limpiar los discos de los frenos con un detergente para discos de frenos o acetona y lavar los neumáticos con agua caliente y detergente neutro.



PELIGRO: Si los frenos están mojados pueden provocar una reducción de la potencia de la frenada y accidentes. Después del lavado poner en marcha el motor por algunos minutos y saliendo despacio. Efectuar algunas frenadas con cuidado para secar las pastillas y discos de frenos.



PELIGRO: La cadena de la transmisión se debe lubricar después del lavado y el secado de la motocicleta de acuerdo a las instrucciones indicadas en el § 1.11. de éste manual.

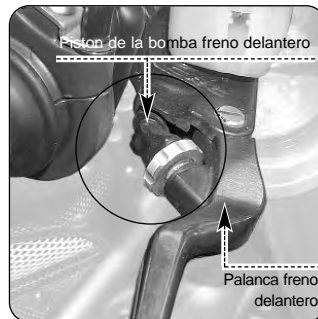
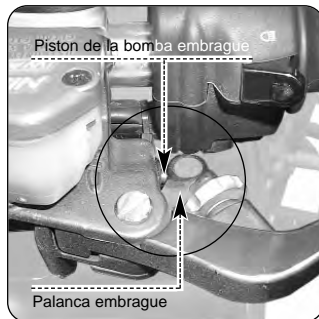
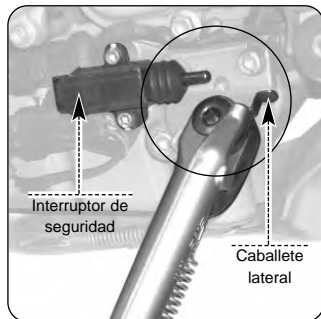

PRUDENCIA - PRECAUCION

Guarde siempre limpias las áreas de contacto entre los componentes siguientes, según lo demostrado en las figuras antedichas:







- Caballete lateral y interruptor de seguridad
- Palanca embrague y piston de la bomba embrague
- Palanca freno delantero y piston de la bomba freno delantero

Limpie estas áreas cada 500 ÷ 1000 kilómetros, según lo prescrito en la Tabla de mantenimiento programado. En cualquier caso, sugerimos verificar la limpieza de las áreas antedichas cada vez que usted utiliza el vehículo, para mantener el funcionamiento correcto de las piezas relacionadas.



1.16. Periodo de larga inactividad

Si tiene previsto tener la motocicleta parada durante mucho tiempo, es conveniente efectuar las siguientes operaciones:

-  Vacíe el depósito combustible.
-  Quite la batería y consérvela convenientemente.
-  Quite los capuchones de las bujías y las bujías. Echar una cucharada de aceite motor en cada orificio de las bujías, luego volver a instalar las bujías y los correspondientes capuchones y dejar girar algunas veces el motor.
-  Lubricar todos los cables de mando y los puntos de rotación de todas las levas y pedales.
-  Limpie la motocicleta y trate con productos específicos las partes pintadas (§1.15.).
-  Con el objeto de garantizar la integridad y las prestaciones de los neumáticos, estacionar la moto en un ambiente fresco, seco u oscuro con una temperatura casi constante e inferior a 25 °C. Evitar el contacto directo de los neumáticos con tubos o caloríferos de la calefacción, y el contacto prolongado con aceite y gasolina. Evitar colocar los neumáticos en las cercanías de motores eléctricos o herramientas donde se puedan desprender chispas o descargas eléctricas. Durante el tiempo de parada, tener la moto sobre el caballete trasero.
-  Tape la motocicleta con un telón adecuado.

Cuando vuelva a utilizar la motocicleta recuerde que debe efectuar la verificación general y, si fuera necesario, haga efectuar el mantenimiento (§1.2.).

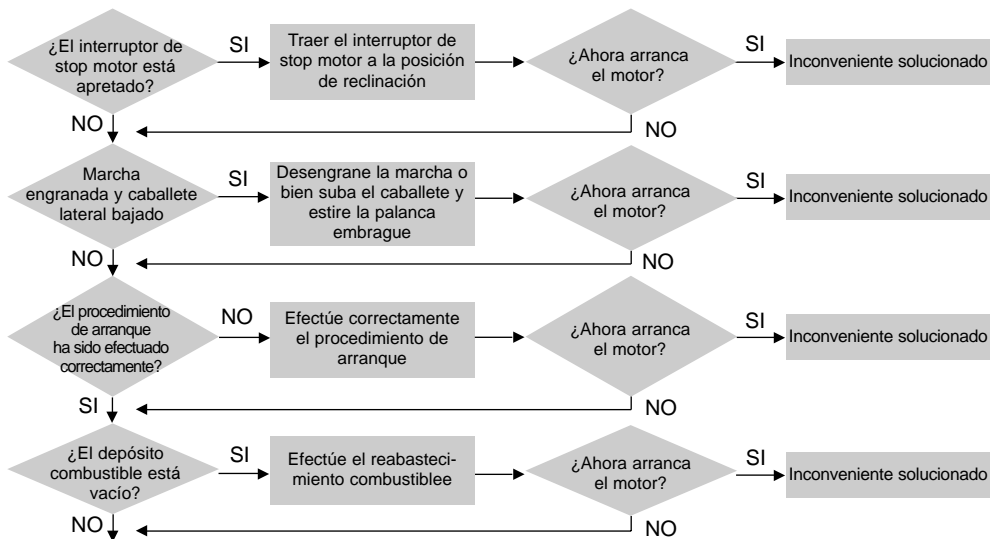
2.1. Inconvenientes en el motor: **EL MOTOR NO ARRANCA**

sigue en la página siguiente



sigue de la página anterior

ES 2

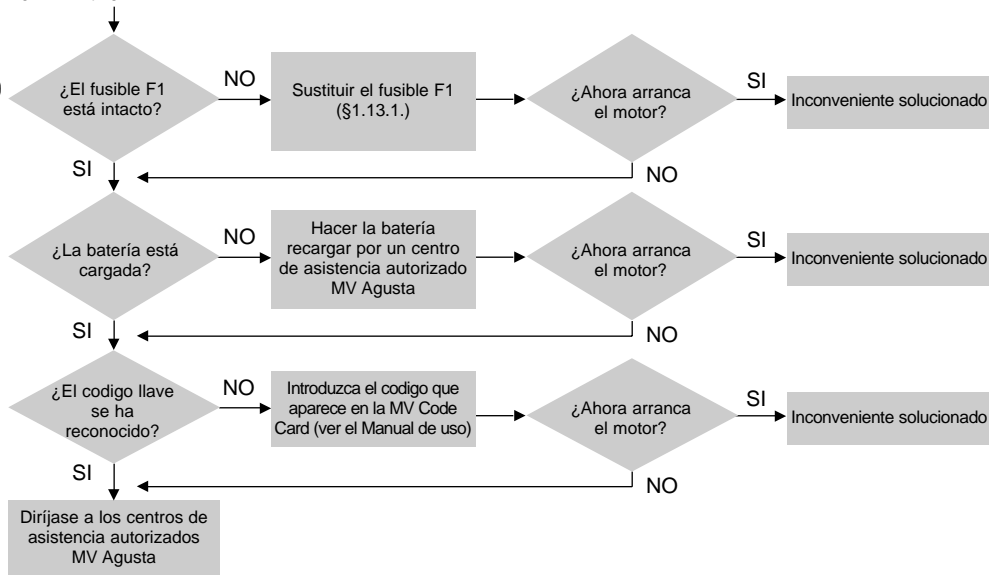



EL MOTOR SE APAGA MIENTRAS QUE ESTÁ FUNCIONANDO

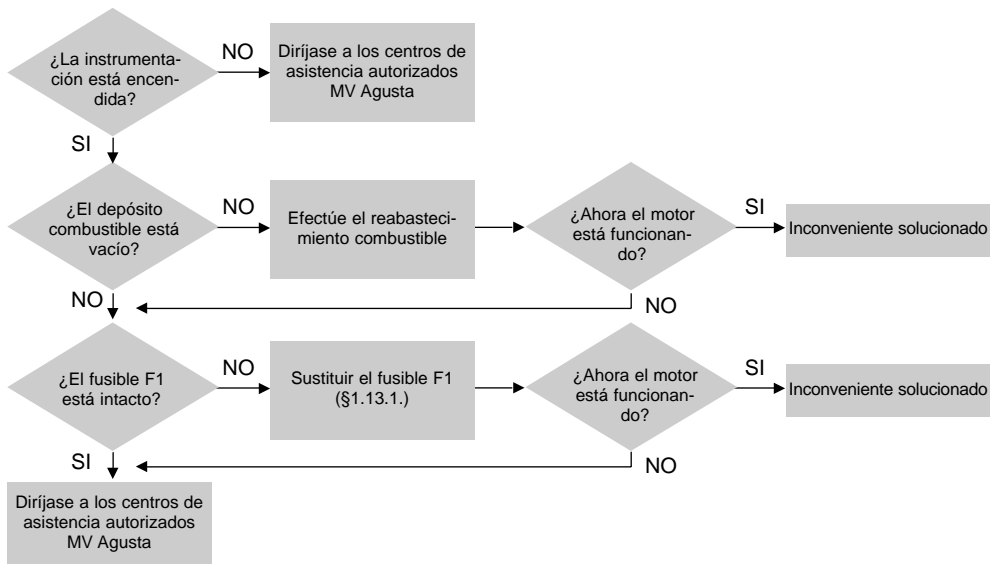



EL MOTOR SE RECALIENTA

ES 2

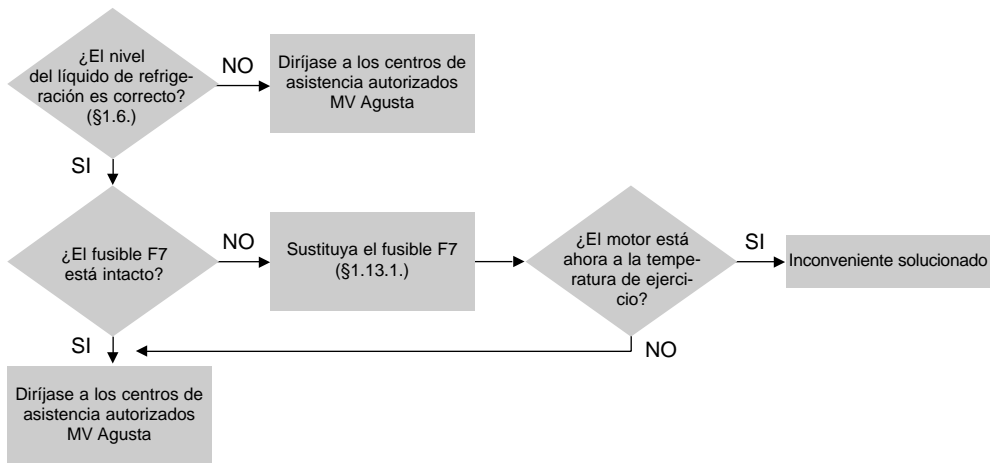



LA PRESIÓN DEL ACEITE ES INSUFICIENTE (El testigo de la presión del aceite está encendido mientras que el motor está funcionando)

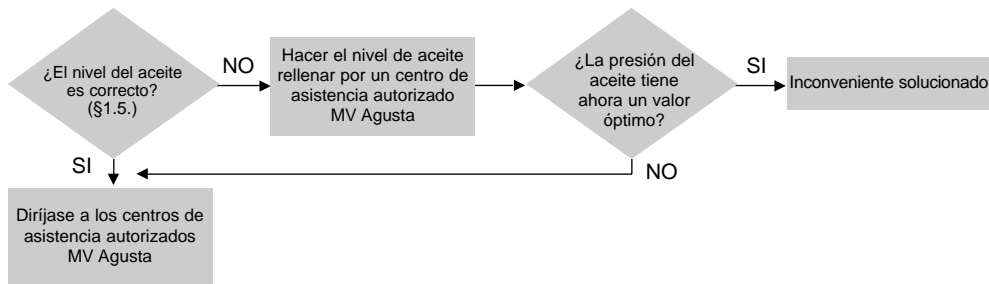



2.2. Inconvenientes en la instalación eléctrica: **LAS LUCES NO FUNCIONAN**

ES 2

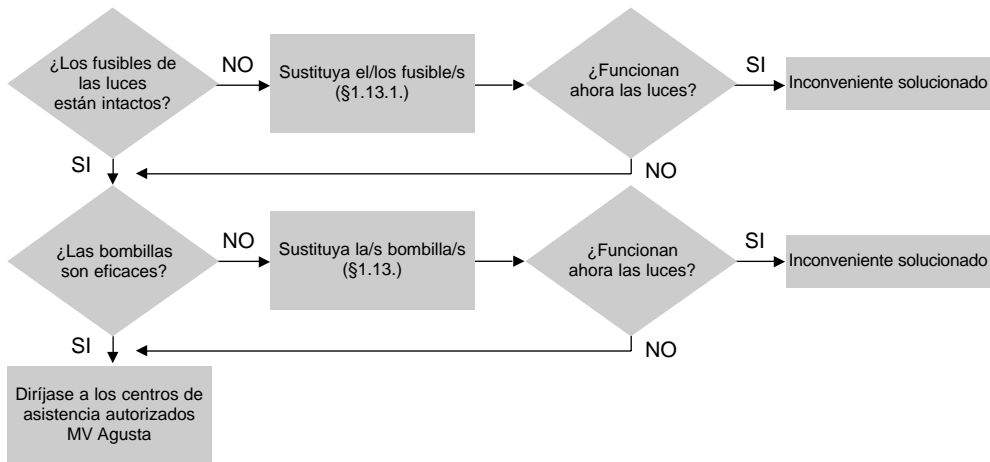



EL CLAXON NO FUNCIONA

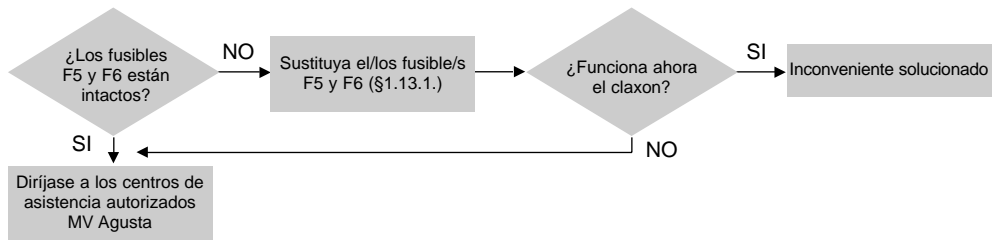

2 ES

EL CUENTAKILÓMETROS NO FUNCIONA

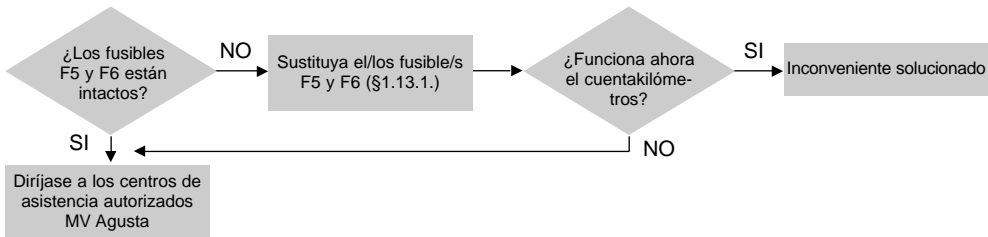



LOS TESTIGOS DE LA INSTRUMENTACIÓN NO FUNCIONAN

ES 2

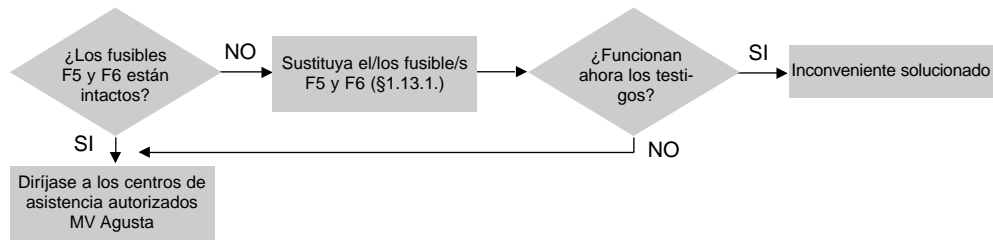

EL ALTERNADOR NO CARGA LA BATERÍA (El testigo carga batería está encendido mientras que el motor está funcionando)

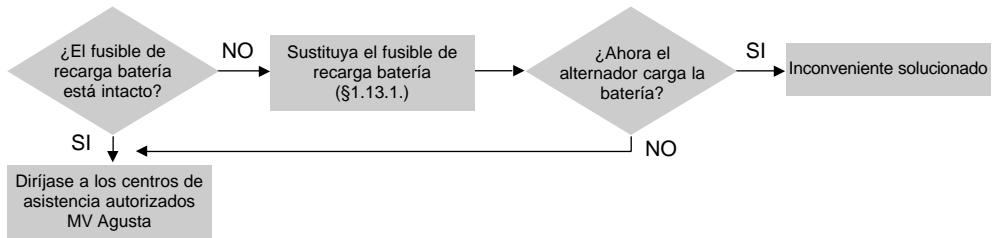



3.1. Descripción general de la motocicleta

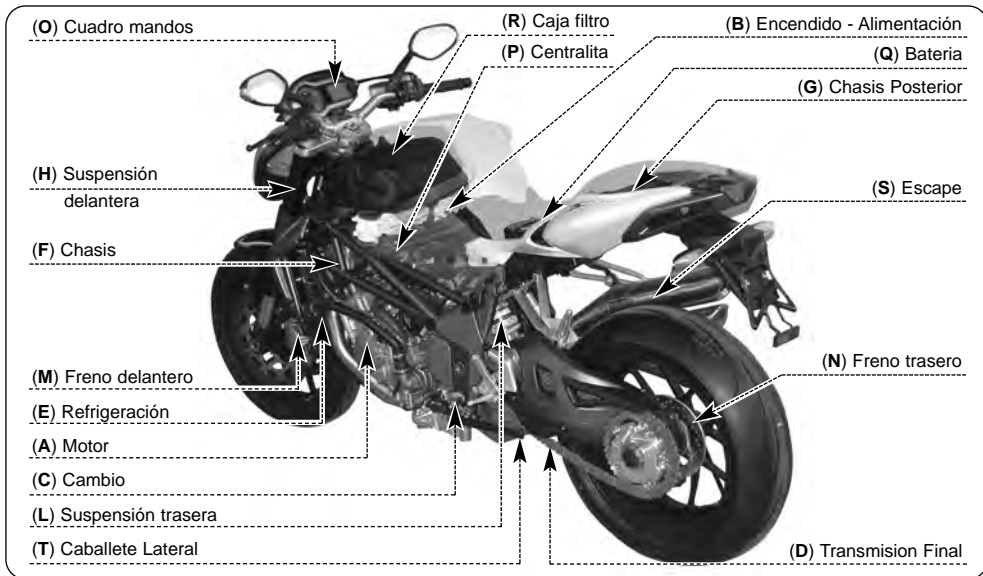

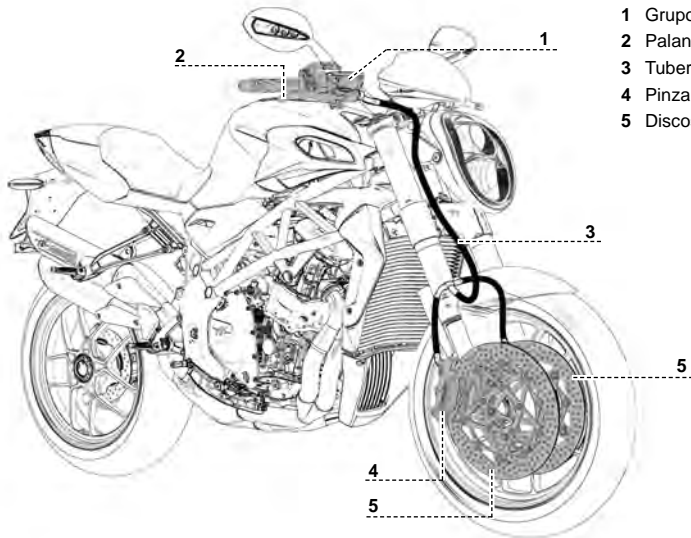

- A - Motor:** cuatro tiempos, cuatro cilindros en línea. Distribución mediante doble árbol de levas en cabeza con válvulas radiales. Lubricación por cárter húmedo.
- B - Encendido - alimentación:** sistema integrado de encendido - inyección. Encendido electrónico por descarga inductiva. Inyección electrónica "Multipoint".
- C - Cambio:** del tipo extraíble, de 6 velocidades con engranajes siempre en toma.
- D - Transmisión final:** compuesta por piñón, corona y cadena.
- E - Refrigeración:** con radiadores separados del agua y del aceite.
- F - Chasis:** entramado, en tubular de acero, con placas laterales en aluminio.
- G - Chasis Posterior:** castillete en tubos de acero.
- H - Suspensión delantera:** horquilla oleodinámica con vástagos vueltos, equipada con sistema exterior de regulación.
- L - Suspensión trasera:** de acción progresiva con monobrazo oscilante y monoamortiguador equipado con sistema exterior de regulación.
- M - Freno delantero:** doble disco semi-flotante con pinzas radiales de cuatro pistones.
- N - Freno trasero:** disco único con pinza de cuatro pistones.
- O - Cuadro mandos:** equipado con testigos indicadores e instrumentos analógicos y digitales.
- P - Centralita:** provista de EPROM para el control electrónico integrado de encendido-inyección.
- Q - Batería:** sellada y sin mantenimiento.
- R - Caja filtro:** provisto de sistema de filtro del flujo aire de aspiración motor.
- S - Escape:** equipado con convertidor catalítico para la reducción del gas de escape.
- T - Caballete Lateral:** provisto de interruptor de seguridad y doble muelle de retorno.

3.1.1 Circuito freno delantero

- 1 Grupo bomba freno
- 2 Palanca freno
- 3 Tubería freno
- 4 Pinza freno
- 5 Discos freno



3.1.2. Circuito freno trasero

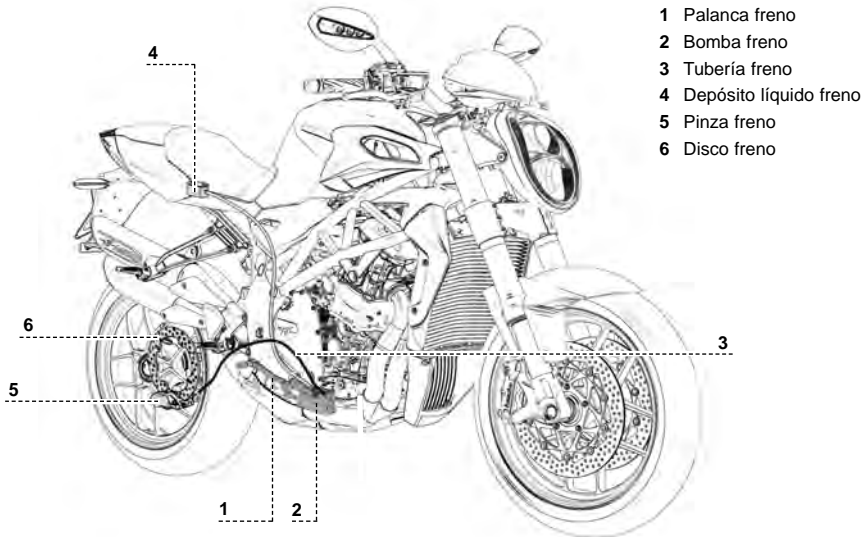



3.1.3. Circuito embrague

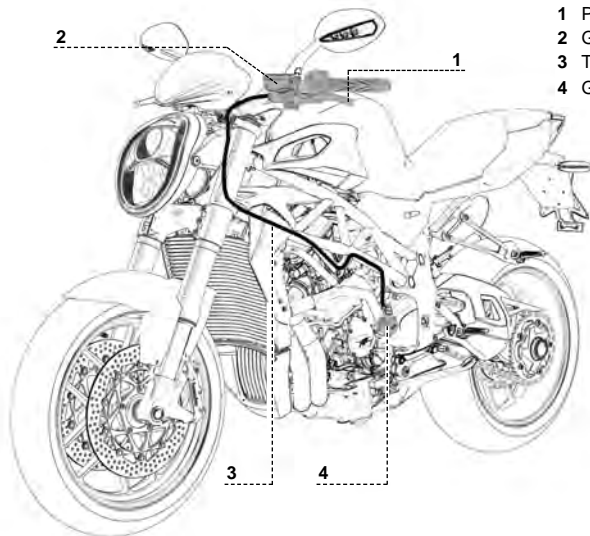

- 1 Palanca embrague
- 2 Grupo bomba embrague
- 3 Tubería embrague
- 4 Grupo cilindro embrague



3.1.4. Lubricación motor

ES
3

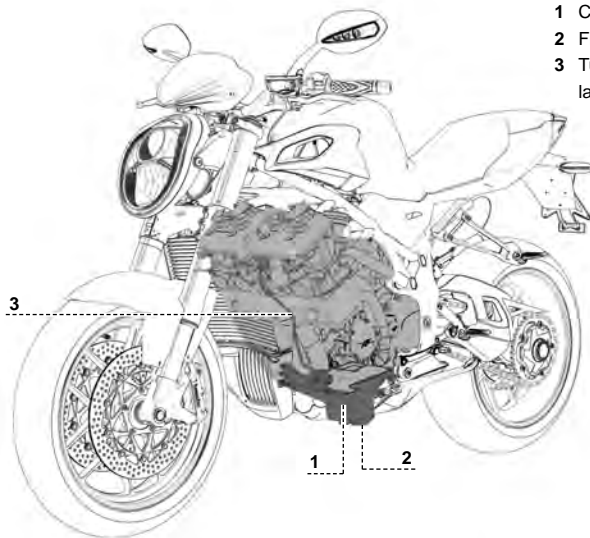

- 1 Cárter motor
- 2 Filtro aceite
- 3 Tubería envío aceite en la culata



3.1.5. Circuito de refrigeración

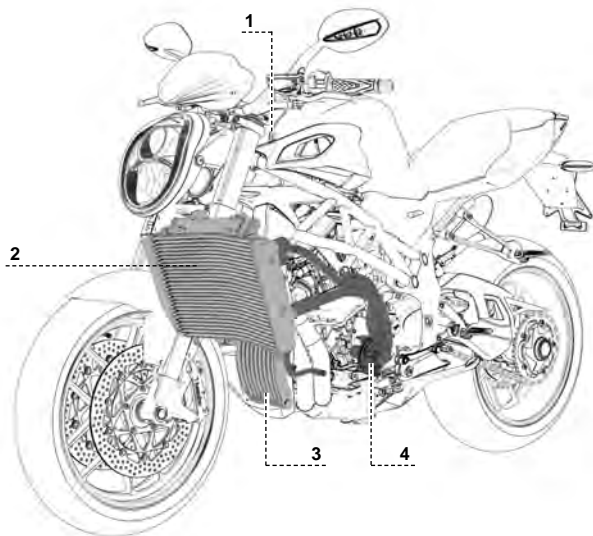

- 1 Depósito de expansión
- 2 Radiador superior
- 3 Radiador inferior
- 4 Bomba líquido



3.1.6. Circuito de alimentación

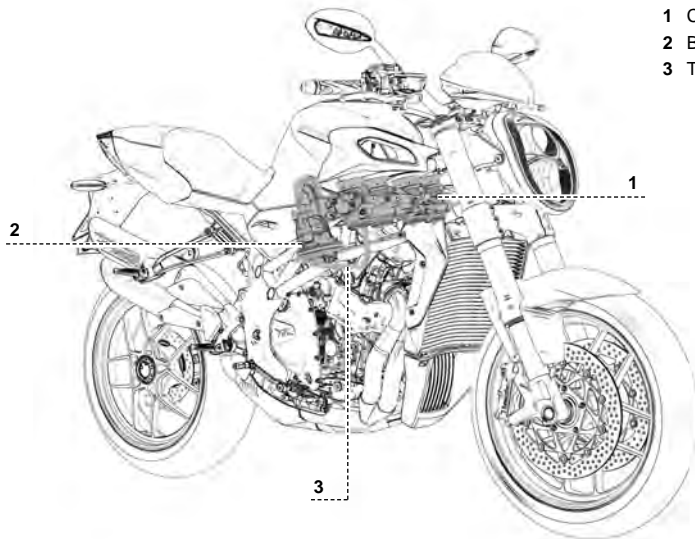

- 1 Cuerpo mariposa
- 2 Bomba carburante
- 3 Tubería carburante

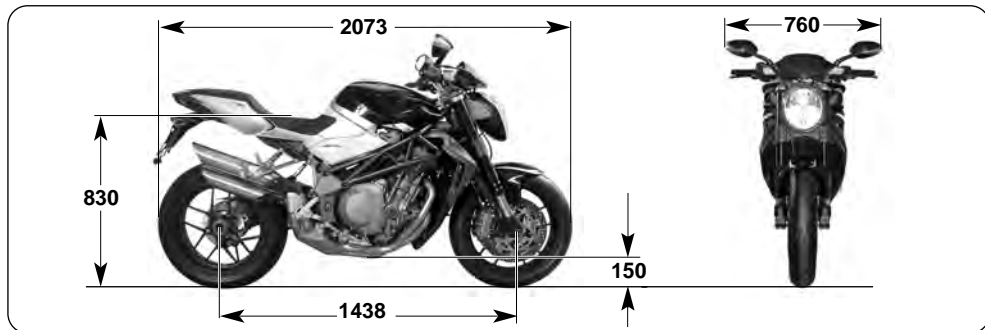

3 ES

3.2. Datos técnicos

Descripción	BRUTALE 1090 RR
CARACTERÍSTICAS	
Distancia entre ejes (mm) (*)	1438
Longitud total (mm) (*)	2073
Ancho máx. (mm)	760
Altura asiento (mm) (*)	830
Altura mín. desde el suelo (mm) (*)	150
Avance carrera (mm) (*)	103,5

*: Los datos no son vinculantes. Los mismos son susceptibles a cambios en función de las variaciones aportadas al vehículo.



Datos técnicos

Descripción	BRUTALE 1090 RR
Peso en seco (Kg)	190
Capacidad depósito combustible (lt) (*)	19
Reserva combustible (lt) (*)	4
Cant. aceite en la bancada (Kg)	3,5
MOTOR	
Tipo	Cuatro cilindros 4 tiempos, 16 válvulas
Alisado (mm)	79,0
Carrera (mm)	55,1
Cilindrada total (cm ³)	1078
Relación de compresión	13: 1
Arranque	Eléctrico
Refrigeración	Con radiadores separados del agua y del aceite
Cárter motor y tapas	Fundido a presión
Culata y cilindros	Fundidos en coquilla
Válvulas	Bimetálicas / monometálicas
DISTRIBUCIÓN	
Tipo	Doble árbol de levas en cabeza; válvulas radiales

* : Los datos no son vinculantes. Los mismos son susceptibles a cambios en función de la temperatura externa, de la temperatura del motor y del punto de evaporación de la gasolina utilizada.

**Datos técnicos**

Descripción	BRUTALE 1090 RR
LUBRIFICACIÓN	
Tipo	Por cárter húmedo
ENCENDIDO - ALIMENTACIÓN	
Tipo	Sistema de encendido-inyección Magneti Marelli 5.SM con cuerpo mariposa Mikuni. Encendido electrónico con descarga inductiva. Inyección electrónica "Multipoint" secuencial en fase.
Bujías	NGK CR9 EB
Distancia electrodos (mm)	0.7 ÷ 0.8
EMBRAGUE	
Tipo	Multidisco en baño de aceite
TRANSMISIÓN PRIMARIA	
Número dientes engranaje cigüeñal	Z = 50
Número dientes engranaje embrague	Z = 79
Relación de transmisión	1.58
TRANSMISIÓN SECUNDARIA	
Número dientes piñón	Z = 15
Número dientes corona	Z = 41
Relación de transmisión	2.73
CAMBIO VELOCIDAD	
Tipo	Extraíble de seis velocidades con engranajes siempre en toma

**Datos técnicos**

Descripción	BRUTALE 1090 RR
Relaciones cambio (relaciones totales)	
Primera	2.92 (12.59)
Segunda	2.12 (9.14)
Tercera	1.78 (7.68)
Cuarta	1.50 (6.47)
Quinta	1.32 (5.69)
Sexta	1.21 (5.22)
CHASIS	
Tipo	Tubular con castillete de refuerzo de acero 25 CrMo (soldado en TIG)
Placas fulcro horquilla	Aleación de aluminio
SUSPENSIÓN DELANTERA	
Tipo	Horquilla oleodinámica con vástagos vueltos equipada con sistema de regulación exterior y separado del freno en extensión, en compresión y de la precarga muelle
Ø vástagos (mm)	50
Carrera sobre el eje patas (mm)	125
SUSPENSIÓN TRASERA	
Tipo	Progresiva, monoamortiguador regulable en extensión, en compresión (Alta velocidad / Baja velocidad) y en la precarga del muelle
Horquilla	Aleación de aluminio
Carrera rueda (mm)	120

**Datos técnicos**

Descripción	BRUTALE 1090 RR
FRENO DELANTERO	
Tipo	De doble disco flotante con faja de frenado en acero
Ø disco (mm)	320
Brida disco	Acero
Pinzas (diámetro pistones mm)	Radial monobloque a 4 pistones (Ø 34)
FRENO TRASERO	
Tipo	De disco en acero
Ø disco (mm)	210
Pinza (diámetro pistones mm)	De 4 pistones (Ø 25.4)
LLANTA DELANTERA	
Material	Aleación de aluminio
Dimensiones	3.50" x 17"
LLANTA TRASERA	
Material	Aleación de aluminio
Dimensiones	6.00" x 17"
NEUMÁTICOS	
Delantero	120/70-ZR 17 (58 W)
Trasero	190/55-ZR 17 (75 W)
Marca y tipo	DUNLOP - Sport Max Qualifier RR PIRELLI - Dragon Supercorsa Pro

**Datos técnicos**

Descripción	BRUTALE 1090 RR
Presión de hinchado (*):	
Delantero	2.3 bar (33 psi)
Trasero	2.3 bar (33 psi)
INSTALACIÓN ELÉCTRICA	
Tensión instalación	12 V
Luz cruce delantera	12 V - 55 W
Luz carretera delantera	12 V - 55 W
Luz de posición trasera	12V 5W
Batería	12V - 8Ah
Alternador	350 W a 5000 rpm
CARROCERÍA	
Depósito	Material termoplástico
Transportadores air-box	Material termoplástico
Laterales deposito gasolina	Material termoplástico
Laterales traseros colín	Material termoplástico
Colín	Aluminio
Protección equipo	Material termoplástico

* : En la eventualidad que se utilice neumáticos diferentes de los recomendados, tener en cuenta el valor de presión de inflado marcado por el constructor en el lateral del neumático.

**Datos técnicos**

Descripción	BRUTALE 1090 RR
Tapa interruptor de encendido	Material termoplástico
Guardabarros delantero	Material termoplástico
Protecciones cadena	Material termoplástico
Protección radiador aceite	Material termoplástico
Portamatricula	Material termoplástico
Espejo retrovisores	Material termoplástico
Protección tubo de escape	Aluminio



ES 3





3.3. Referencias de los colores de las superestructuras

Las partes pintadas de las superestructuras tienen los siguientes colores, en relación al correspondiente código del color de la motocicleta:

1. - Lateral trasero derecho;
2. - Lateral trasero izquierdo;
3. - Lateral depósito derecho;
4. - Lateral depósito izquierdo:

Códigos de color A-D-F:

Plata F4 AGO (Código Palinal 928XV025)

Códigos de color B-E:

Blanco Perla CRC (Código Palinal 927.PE20)

Código de color C:

Antracita Metalizado "Senna" (Cód. PPG GMWA9561)

5. - Guardabarros delantero;
6. - Lateral airbox:

Códigos de color A-D:

Rojo F4 AGO (Código Palinal 926R750)

Códigos de color B-C-E:

Negro intenso CRC (Código Palinal 929R486H)

Código de color F:

Gris Titanium (Código Palinal L821)

7. - Depósito gasolina:

Códigos de color A-D:

Rojo F4 AGO (Código Palinal 926R750) +

Plata F4 AGO (Código Palinal 928XV025)

Códigos de color B-E:

Negro intenso CRC (Código Palinal 929R486H) +

Blanco Perla CRC (Código Palinal 927.PE20)

Código de color C:

Negro intenso CRC (Código Palinal 929R486H) +

Antracita Metalizado "Senna" (Cód. PPG GMWA9561)

Código de color F:

Gris Titanium (Código Palinal L821) +

Plata F4 AGO (Código Palinal 928XV025)

8. - Protección derecho de radiador;
9. - Protección izquierdo de radiador;
10. - Cubierta tablero;

Gris Carbon metalizado (Código Palinal L921)





3.4. Referencias colores componentes del bastidor y parte ciclística

Las partes pintadas del bastidor y parte ciclística de la motocicleta tienen las siguientes referencias de colores:

1. - Bastidor:

Códigos de color A-B-C:

Bronce mate B5

(Código Palinal 211F297)

Códigos de color D-E:

Gris Antracita metalizado MV

(Código Palinal 211XH893)

Código de color F:

Rojo Bastidor

(Código Palinal 211XH987)

2. - Soporte faro delantero:

Códigos de color A-B-C:

Bronce mate B5 (Código Palinal 211F297)

Códigos de color D-E-F:

Gris Antracita metalizado MV

(Código Yi-Mei AC MAT Black Silver)

3. - Motor:

Negro mate (Código Pulverit 3500/0085)

4. - Colín;

5. - Base de dirección:

Gris Carbon metalizado

(Código Palinal L921)

6. - Placa derecha articulación horquilla;

7. - Placa izquierda articulación horquilla;

8. - Horquilla trasera:

Gris Carbon metalizado

(Código Akzo Nobel RPU MIC 09 BP 1663/5)

9. - Soporte trasero derecho reposapiés;

10. - Soporte trasero izquierdo reposapiés:

Metalizado gris aluminio final

(Código Palinal F444)



Nota informativa

MV Agusta S.p.A. está comprometida en una política de continuo mejoramiento de sus productos; por este motivo es posible encontrar ligeras diferencias entre el contenido de éste documento y el vehículo adquirido por Ustedes. Los modelos MV Agusta son exportados en muchos Países, en los cuales el Código del Tránsito y a los procedimientos de homologación son distintos a los nuestros.

Confiamos en Vuestra comprensión. MV Agusta S.p.A. considera por lo tanto necesario reservarse el derecho de aportar modificaciones a sus productos y a la documentación técnica en cualquier momento y sin ningún aviso previo.

Sugerimos para visitar a menudo el sitio Internet **www.mvagusta.it** para obtener informaciones y actualizaciones sobre los productos MV Agusta y la documentación relacionada.



Respetemos y defendamos el medioambiente

Todo lo que hacemos tiene repercusiones para todo el planeta y en sus recursos.

MV Agusta, a tutela de los intereses de la comunidad, sensibiliza los Clientes y los operadores de la asistencia técnica a adoptar una utilización del vehículo y de eliminación de sus partes, respetando plenamente las normativas vigentes en términos de contaminación del medio ambiente, eliminación y reciclaje de los desechos.

© 2010

Está prohibida la reproducción aunque sea parcial de éste documento sin el consentimiento escrito por MV Agusta S.p.A.

Part. n° 8000B3379

Edición n° 2 - Julio 2010





MV Agusta Motor S.p.A. - Via G. Macchi. 144
21100 - Schiranna (VA) - ITALY
www.mvagusta.it
Part. N. 8000B3379 Ed. n° 2