



LT-F400/F

OWNER'S MANUAL

This owner's manual contains important safety information. Please read it carefully.

Never allow anyone under 16 years old to ride this ATV.

Part No. 99011-27H61-03A
April, 2008 (TK) EN

California Proposition 65 Warning

WARNING

Engine exhaust, some of its constituents, and certain product components contain or emit chemicals known to the State of California to cause cancer and birth defects or other reproductive harm.

This manual should be considered a permanent part of the vehicle and should remain with the vehicle when resold or otherwise transferred to a new owner or operator. The manual contains important safety information and instructions which should be read carefully before operating the vehicle.

IMPORTANT

▲ **WARNING /CAUTION /NOTE**

Please read this manual and follow its instructions carefully. To emphasize special information, the symbol ▲ and the words WARNING, CAUTION and NOTE have special meanings. Pay special attention to the messages highlighted by these signal words:

▲ **WARNING**

Indicates a potential hazard that could result in death or injury.

CAUTION

Indicates a potential hazard that could result in vehicle damage.

NOTE: Indicates special information to make maintenance easier or instructions clearer.

- WARNINGS and CAUTIONS are arranged like this:

▲ **WARNING-or-CAUTION**

This first part will identify a **POTENTIAL HAZARD.**

This second part will describe **WHAT CAN HAPPEN** if you ignore the **WARNING** or **CAUTION.**

This third part will describe **HOW TO AVOID THE HAZARD.**

FOREWORD

- This owner's manual contains important safety and maintenance information. Read it carefully before you ride your new ATV. Failure to follow the warnings contained in this manual can result in INJURY or DEATH.
 - Do not allow anyone **under age 16** to ride this ATV.
 - In the USA, anyone who purchases a new Suzuki ATV, and everyone in the purchaser's immediate family who is old enough to ride the ATV purchased (see label), is entitled to take a training course at no additional charge. Others can take the training course for a small fee. When a non-business purchaser or age-appropriate family member completes training, the purchaser will receive a \$100 check if it is their first ATV or a \$50 check if they have owned an ATV before. Limit one check per ATV purchased. Ask an authorized Suzuki dealer for details or in the USA call 1-800-887-2887 for training information.
 - It is important that this manual remain with the vehicle when you sell it. The next owner will need this manual also. Store the owner's manual in the box under the seat.
- Review the "Tips and Practice Guide" handbook supplied with this owner's manual (owner's in U.S.A.). This special handbook contains a variety of safety tips, helpful hints, and practice exercises that can increase your riding enjoyment and safety.
 - All information, illustrations and specifications contained in this manual are based on the latest product information available at the time of publication. Due to improvements or other changes, there may be some discrepancies between information in this manual and your ATV. Suzuki reserves the right to make production changes at any time, without notice and without incurring any obligation to make the same or similar changes to vehicles previously built or sold.
 - Suzuki Motor Corporation believes in conservation and protection of Earth's natural resources. To that end, we encourage every vehicle owner to recycle, trade in, or properly dispose of, as appropriate, used motor oil, coolant, other fluids, batteries and tires.

- The proper care and maintenance that your ATV requires is outlined in this manual. By following these instructions explicitly you will ensure a long trouble-free operating life for your ATV. This ATV also conforms to the U.S. Environmental Protection Agency (EPA) and California Air Resources Board (CARB) emission regulations which apply to new ATVs. The proper adjustment of engine components is necessary for this ATV to comply with the EPA and CARB regulations. Therefore, please follow the maintenance instructions closely to ensure emission compliance. Your authorized Suzuki dealer has experienced technicians that are trained to provide your machine with the best possible service with the right tools and equipment.

SUZUKI MOTOR CORPORATION

© COPYRIGHT SUZUKI MOTOR CORPORATION 2008

NOTICE TO OWNER'S

AN ATV IS NOT A TOY AND CAN BE HAZARDOUS TO OPERATE. An ATV handles differently from other vehicles including motorcycles and cars. A collision or rollover can occur quickly, even during routine maneuvers such as turning and driving on hills or over obstacles, if you fail to take proper precautions.

SEVERE INJURY OR DEATH can result if you do not follow these instructions:

- Read this manual and all labels carefully and follow the operating procedures described.
- Never operate an ATV without proper instruction. **Take a training course.** Beginners should receive training from a licensed instructor. Contact an authorized ATV dealer or call 1-800-887-2887 to find out about the training courses nearest you.
- Always follow this age recommendation:
 - A child **under 16 years old** should never operate an ATV with engine size greater than 90 cc.
- Never carry a passenger on an ATV.

- Always avoid operating an ATV on paved surfaces, including sidewalks, paths, parking lots, drive ways, and streets.
- Never operate an ATV on any public street, road or highway, even a dirt or gravel one.
- Never operate an ATV without wearing an approved motorcycle helmet that fits properly. You should also wear eye protection (goggles or face shield), gloves, boots, long-sleeved shirt or jacket, and long pants.
- Never consume alcohol or drugs before or while operating this ATV.
- Never operate at excessive speeds. Always go at a speed that is proper for the terrain, visibility and operating conditions, your skill and experience.
- Never attempt wheelies, jumps, or other stunts.
- Always inspect your ATV each time you use it to make sure it is in safe operating condition. Always follow the inspection and maintenance procedures and schedules described in this manual.
- Always keep both hands on the handlebars and both feet on the footrests of the ATV during operation.
- Always go slowly and be extra careful when operating on unfamiliar terrain. Always be alert to changing terrain conditions when operating the ATV.
- Never operate on excessively rough, slippery or loose terrain until you have learned and practiced the skills necessary to control the ATV on such terrain. Always be especially cautious on these kinds of terrain.
- Always follow proper procedures for turning as described in this manual. Practice turning at low speeds before attempting to turn at faster speeds. Do not turn at excessive speed.
- Never operate the ATV on hills too steep for the ATV or for your abilities. Practice on smaller hills before attempting larger hills.
- Always follow proper procedures for climbing hills as described in this manual. Check the terrain carefully before you start up any hill. Never climb hills with excessively slippery or loose surfaces. Shift your weight forward. Never open the throttle suddenly or make sudden gear changes. Never go over the top of any hill at high speed.

- Always follow proper procedures for going down hills and for braking on hills as described in this manual. Check the terrain carefully before you start down any hill. Shift your weight backward. Never go down a hill at high speed. Avoid going down a hill at an angle that would cause the vehicle to lean sharply to one side. Go straight down the hill where possible.
- Always follow proper procedures for crossing the side of a hill as described in this manual. Avoid hills with excessively slippery or loose surfaces. Shift your weight to the uphill side of the ATV. Never attempt to turn the ATV around on any hill until you have mastered the turning technique described in this manual on level ground. Avoid crossing the side of a steep hill if possible.
- Always use proper procedures if you stall or roll backwards when climbing a hill. To avoid stalling, use the proper gear and maintain a steady speed when climbing a hill. If you stall or roll backwards, follow the special procedure for braking described in this manual. Dismount on the uphill side or to a side if pointed straight uphill. Turn the ATV around and remount, following the procedure described in this manual.
- Always check for obstacles before operating in a new area. Never attempt to operate over large obstacles, such as large rocks or fallen trees. Always follow proper procedures when operating over obstacles as described in this manual.
- Always be careful when skidding or sliding. Learn to safely control skidding or sliding by practicing at low speeds and on level, smooth terrain. On extremely slippery surfaces, such as ice, go slowly and be very cautious in order to reduce the chance of skidding or sliding out of control.
- Never operate an ATV in fast flowing water or in water deeper than that specified in this manual. Remember that wet brakes may have reduced stopping ability. Test your brakes after leaving water. If necessary, apply them several times to let friction dry out the linings.
- Always be sure there are no obstacles or people behind you when you operate in reverse. When it is safe to proceed in reverse, go slowly.
- Always use tires of the size and type specified in this manual. Always maintain proper tire pressure as described in this manual.
- Never modify an ATV through improper installation or use of accessories.

- Never exceed the stated load capacity for an ATV. Cargo should be properly distributed and securely attached. Reduce speed and follow instructions in this manual for carrying cargo or pulling a trailer. Allow greater distance for braking.

FOR MORE INFORMATION ABOUT ATV SAFETY, owners in the USA can call the Consumer Product Safety Commission at 1-800-638-2772, or the ATV Distributors' Safety Hotline at 1-800-852-5344.

⚠ WARNING

Indicates a potential hazard that could result in death or injury.



TABLE OF CONTENTS

FUEL AND OIL RECOMMENDATIONS	1
CONTROLS, EQUIPMENT AND ADJUSTMENTS	2
RIDING YOUR ATV	3
ACCESSORY USE AND VEHICLE LOADING	4
INSPECTION AND MAINTENANCE	5
TROUBLESHOOTING	6
PREPARATION FOR WINTER RIDING	7
TRANSPORTING	8
CLEANING PROCEDURE AND STORAGE PROCEDURE	9
CONSUMER INFORMATION	10
SPECIFICATIONS	
INDEX	

FUEL AND OIL RECOMMENDATIONS

FUEL	1-2
ENGINE OIL	1-3
FRONT DIFFERENTIAL GEAR OIL (LT-F400F) AND FINAL GEAR OIL	1-4

FUEL AND OIL RECOMMENDATIONS

FUEL

Your vehicle requires regular unleaded gasoline, with a minimum pump octane rating of 87 ((R+M)/2 method). In some areas, the only fuels that are available are oxygenated fuels.

Oxygenated fuels which meet the minimum octane requirement and the requirements described below may be used in your ATV without jeopardizing the New Vehicle Limited Warranty or the Emission Control System Warranty.

NOTE: Oxygenated fuels are fuels which contain oxygen-carrying additives such as MTBE or alcohol.

Gasoline containing MTBE

Unleaded gasoline containing MTBE (Methyl Tertiary Butyl Ether) may be used in your ATV if the MTBE content is not greater than 15%. This oxygenated fuel does not contain alcohol.

Gasoline/Ethanol Blends

Blends of unleaded gasoline and ethanol (grain alcohol), also known as GASOHOL, may be used in your ATV if the ethanol content is not greater than 10%.

Gasoline/Methanol

Fuels containing 5% or less methanol (wood alcohol) may be suitable for use in your ATV if they contain co-solvents and corrosion inhibitors.

DO NOT USE fuels containing more than 5% methanol under any circumstances. Fuel system damage or ATV performance problems resulting from the use of such fuels are not the responsibility of Suzuki and may not be covered under the New Vehicle Limited Warranty or the Emission Control System Warranty.

Fuel Pump Labeling

In some states, pumps that dispense oxygenated fuels are required to be labeled for the type and percentage of oxygen, and whether important additives are present. Such labels may provide enough information for you to determine if a particular blend of fuel meets the requirements listed above. In other states, pumps may not be clearly labeled as to the content or type of oxygen and additives. If you are not sure that the fuel you intend to use meets these requirements, check with the service station operator or the fuel supplier.

NOTE:

- To help minimize air pollution, Suzuki recommends that you use oxygenated fuels.
- Be sure that any oxygenated fuel you use has octane ratings of at least 87 pump octane ((R+M)/2 method).
- If you are not satisfied with the driveability or fuel economy of your ATV when you are using an oxygenated fuel, you should switch back to regular unleaded gasoline.
- If you are not satisfied with the driveability of your ATV when you are using an oxygenated fuel, or if engine pinging is experienced, substitute another brand as there are differences between brands.

CAUTION

Spilled gasoline containing alcohol can harm your ATV.

Alcohol can damage painted surfaces.

Be careful not to spill any fuel when filling the fuel tank. Wipe spilled gasoline up immediately.

ENGINE OIL

Oil quality is a major contributor to your engine's performance and life. Always select good quality engine oil. Suzuki recommends the use of SUZUKI PERFORMANCE 4 MOTOR OIL or equivalent engine oil. Use oil with an API (American Petroleum Institute) classification of SF/SG or SH/SJ, or with a JASO classification of MA.

SAE	API	JASO
10W-40	SF or SG	–
10W-40	SH or SJ	MA

API: American Petroleum Institute
JASO: Japanese Automobile Standards Organization

SAE Engine Oil Viscosity

Suzuki recommends the use of SAE 10W-40 engine oil. If SAE 10W-40 engine oil is not available, select an alternative according to the following chart.

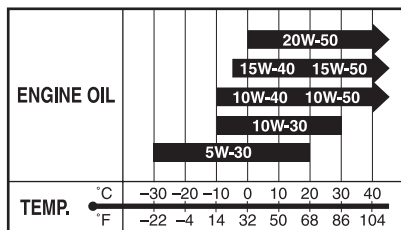

NOTE: In very cold weather (below 14°F (-10°C)), use SAE 5W-30 for good starting and smooth operation.

JASO T903

The JASO T903 standard is an index to select engine oils for 4-stroke motorcycle and ATV engines. Motorcycle and ATV engines lubricate clutch and transmission gears with engine oil. JASO T903 specifies performance requirements for motorcycle and ATV clutches and transmissions.

There are two classes, MA and MB. The oil container shows the classification as follows.

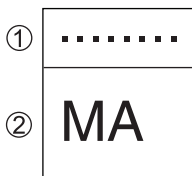

- ① Code number of oil sales company
- ② Oil classification

Energy Conserving

Suzuki does not recommend the use of “ENERGY CONSERVING” oils. Some engine oils which have an API classification of SH or higher have an “ENERGY CONSERVING” indication in the API classification doughnut mark. These oils can affect engine life and clutch performance.

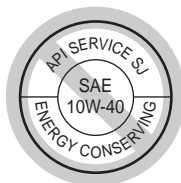

Not recommended



Recommended

FRONT DIFFERENTIAL GEAR OIL (LT-F400F) AND FINAL GEAR OIL

Use a SAE 90 hypoid gear oil which is rated GL-5 under the API classification system. If you normally operate the vehicle where ambient temperature is below 0°C (32°F), use a SAE 80 hypoid gear oil.

CONTROLS, EQUIPMENT AND ADJUSTMENTS

LOCATION OF PARTS	2-2
KEY	2-5
IGNITION SWITCH	2-6
SPEEDOMETER AND INDICATOR LIGHTS	2-7
RANGE LEVER	2-8
SELECTION LEVER (LT-F400F)	2-9
GEARSHIFT LEVER	2-10
LEFT HANDLEBAR	2-10
RIGHT HANDLEBAR	2-13
THROTTLE LIMITER	2-14
REAR BRAKE PEDAL	2-14
FUEL VALVE	2-15
RECOIL STARTER	2-16
FUEL TANK CAP	2-16
SEAT LOCK	2-18
FLAG BRACKET	2-18
BOX	2-19

CONTROLS, EQUIPMENT AND ADJUSTMENTS

LOCATION OF PARTS

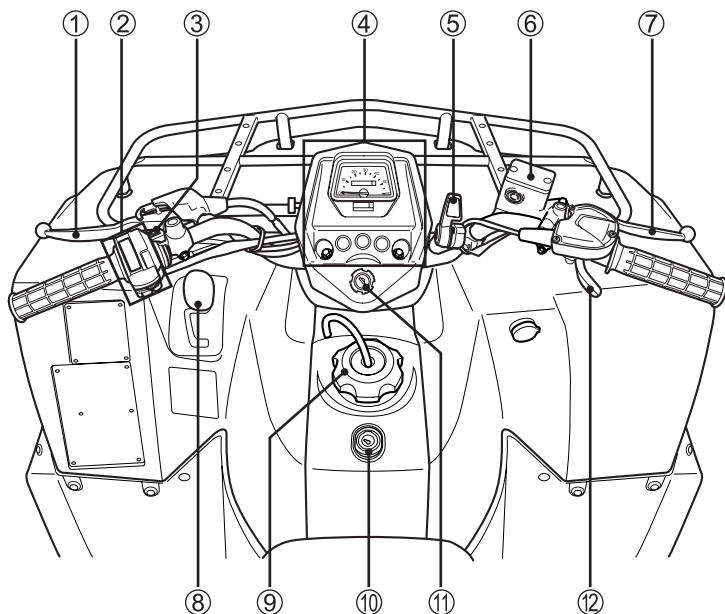

- ① Rear brake lever
- ② Left handlebar switches
- ③ Choke lever
- ④ Speedometer and indicator lights
- ⑤ Selection lever (LT-F400F)
- ⑥ Front brake fluid reservoir
- ⑦ Front brake lever
- ⑧ Range lever
- ⑨ Fuel tank cap
- ⑩ Fuel gauge
- ⑪ Ignition switch
- ⑫ Throttle lever

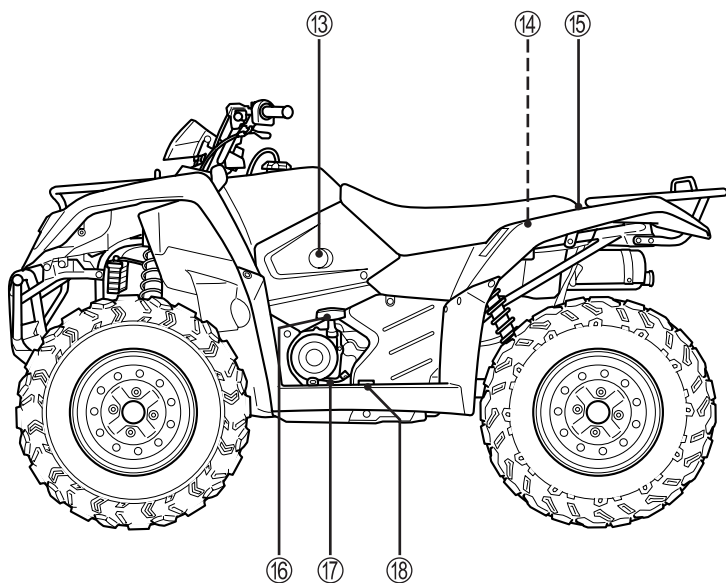

- ⑬ Fuel valve
- ⑭ Box
- ⑮ Seat lock
- ⑯ Recoil starter
- ⑰ Gearshift lever
- ⑱ Footrests

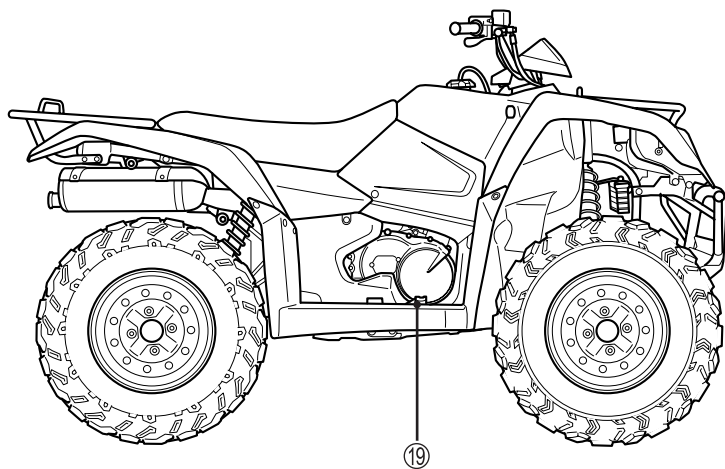

①9 Rear brake pedal

⚠ WARNING

Indicates a potential hazard that could result in injury or death.

KEY

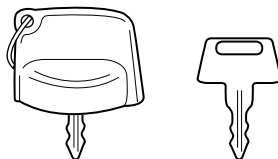

Two keys come with this vehicle. Keep the spare key in a safe place. An identifying number is stamped on the keys. Use this number when making a replacement key.

Please write down your key number in the box provided for your future reference.

Key No.:

IGNITION SWITCH

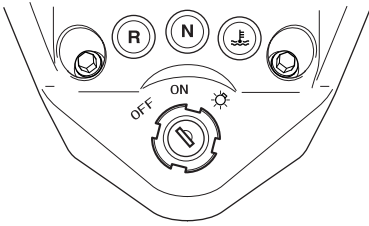

The ignition switch has three positions.

“OFF” position

All electrical circuits are cut off. The engine will not start. The key can be removed.

“ON” position

The ignition circuit is on and the engine can be started. The key cannot be removed in this position.

“☀️ (LIGHTS)” position

The ignition circuit is on and the headlight and taillight turn on. The key cannot be removed in this position.

CAUTION

Leaving the ignition switch in the “☀️” position for a long time can damage the ATV’s battery.

The battery will run down if the lights are on for a long time when the engine is not running.

Always leave the ignition switch in the “OFF” position when not operating the ATV.

SPEEDOMETER AND INDICATOR LIGHTS

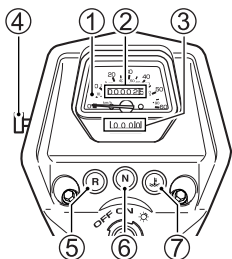

Speedometer ①

The speedometer shows approximate vehicle speed.

Odometer ②

The odometer shows the total distance that the vehicle has been ridden.

Trip Meter ③

The trip meter is a resettable odometer. It can be used to show the distance traveled on short trips or between fuel stops. Turning the **knob** ④ counterclockwise will reset the trip meter to zero.

Reverse Indicator “R” ⑤

A red light will come on when the transmission is in reverse gear.

Neutral Indicator “N” ⑥

A green light will come on when the transmission is in neutral. The light will go out when you shift into any gear other than neutral.

Oil temperature Indicator “”

⑦

A red light will come on if the engine oil gets too hot. The light will come on during starting to check bulb operation. The light should be off during normal operation.

CAUTION

Operating the ATV while the oil temperature indicator is lit can damage your ATV.

Continued operation of the ATV with high engine oil temperature may result in engine damage or premature wear.

If the oil temperature indicator comes on, stop the engine and allow it to cool before restarting. Refer to the note below.

NOTE:

- *High engine speed, low vehicle speeds, or heavy load can increase engine oil temperature. Decrease engine speed, reduce load and select an appropriate transmission gear to lower the temperature.*
- *Debris or mud in front of the engine or packed between the engine fins can reduce cooling ability. Remove any debris or mud preventing any debris or mud preventing air flow to the engine.*

RANGE LEVER



Select a range position according to how you intend to use the vehicle.

L (low range):

Carrying heavy loads or trailer towing. Compared to HIGH range, this position provides lower speed and greater torque to the wheels.

H (high range):

Normal riding with light loads.

R (reverse):

Select this position to reverse the vehicle.

NOTE: The gearshift lever can be operated in "L" and "H" range. Select proper gear position with range lever and gearshift lever.

WARNING

Operating the range lever when the ATV is moving can be hazardous.

If you shift into reverse gear when the LT-F400/F is moving, it could stop suddenly, throwing you from the ATV. If you shift from high range to low range when the LT-F400/F is moving, it could reduce speed suddenly, throwing you from the ATV.

Always come to a complete stop and keep the brakes applied while shifting.

SELECTION LEVER (LT-F400F)

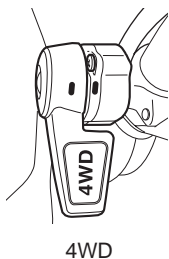
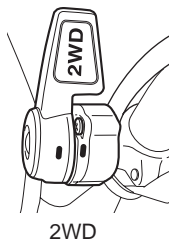

The selection lever is used for changing the manner in which engine power is supplied to the wheels. Select 2WD or 4WD according to surface conditions.

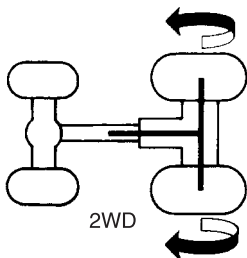

2WD: Engine power is supplied only to the rear wheels. Use this position for normal riding on dry, hard surfaces.

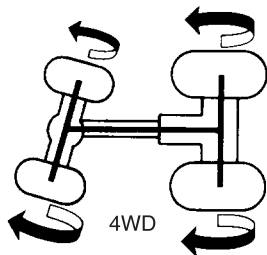

4WD: Engine power is supplied to the front and rear wheels, and the right front wheel and left front wheel can turn at different speeds. This position provides more traction than 2WD and should be used for riding on slippery surfaces.

To shift the selection lever:

1. Stop the vehicle completely.
2. Move the selection lever to the desired position.

WARNING

Shifting the selection lever when the ATV is moving can be hazardous.

Removing a hand while riding can lose control. Shifting the selection lever while ATV is moving can damage the shifting mechanism.

Always come to a complete stop before shifting.

GEARSHIFT LEVER

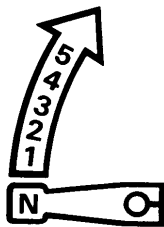
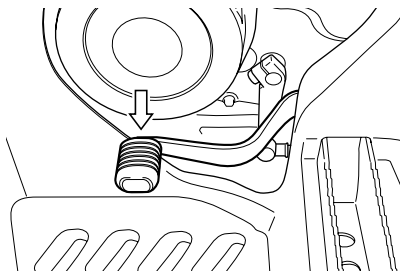

This vehicle has a 5-speed transmission which operates as shown in the illustration. The shift lever is attached to a ratchet type mechanism in the transmission. Each time you select a gear, the gearshift lever will return to its normal position ready to select the next gear. Engage first gear by pressing the lever from the neutral position. You can shift into higher gears by lifting on the shift lever once for each gear. The ratchet mechanism makes it impossible to upshift or downshift more than one gear at a time.

LEFT HANDLEBAR

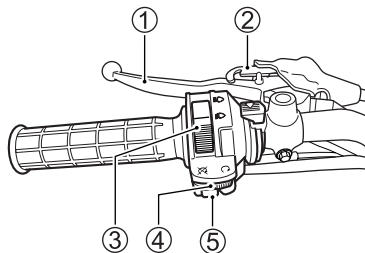

Rear Brake Lever ①

Apply the rear brake by squeezing the rear brake lever towards the grip.

Parking Brake Lock ②

Use this lock to set and lock the parking brake. Use the parking brake to help prevent the LT-F400/F from moving when it is parked, being started, or at idle. To lock the parking brake, squeeze the rear brake lever and engage this lock. To release the parking brake, simply squeeze the lever until the lock button releases.

NOTE: If it is hard to squeeze the rear brake lever to the position you can engage the lock, depress the rear brake pedal and squeeze the rear brake lever.

Dimmer Switch ③

Use the dimmer switch to select the high or low headlight beam when the ignition switch is in the “☀️ (LIGHTS)” position. When you move the dimmer switch to the “☰▷” position, the high beam will light and the high beam indicator light will come on. When you move the dimmer switch to the “☷▷” position, the low beam will light.

CAUTION

Improper dimmer switch operation can damage the ATV.

Holding the dimmer switch between “☷▷” and “☷▷” position will light both “☷▷” and “☷▷” headlight beam. This operation can damage the ATV.

Use the dimmer switch only at “☷▷” or “☷▷” position.

CAUTION

Sticking some tape or placing objects in front of the headlight can damage the headlight.

Sticking some tape or placing objects in front of the headlight can obstruct headlight heat radiation. This can result in headlight damage.

Do not stick any tapes to the headlight. Do not place objects in front of the headlight.

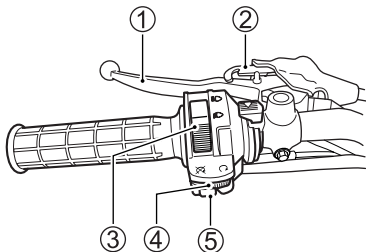

Engine Stop Switch ④

“~~⊗~~” position

The ignition circuit is off and the engine cannot start or run.

“⊙” position

The ignition circuit is on and the engine can run.

Electric Starter Button “⊗” ⑤

Use this button to turn the starter motor. Before starting the engine, turn the ignition switch to the “ON” position and shift the transmission into neutral. Push the electric starter button to start the engine.

NOTE: The engine can be started in any gear, if it is hard to shift into neutral, by squeezing the rear brake lever fully (you will hear the starter interlock switch “click.”).

CAUTION

Engaging the starter motor for more than five seconds at a time can damage the ATV.

The starter motor and wiring harness may overheat.

If the engine does not start after several attempts, check the fuel supply and ignition system. Refer to the TROUBLE-SHOOTING section in this manual.

CHOKE LEVER “I”

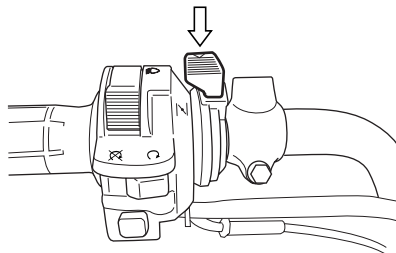

The carburetor of this vehicle has a choke system to provide easy starting when the engine is cold. The choke system works by moving the choke lever to the ENGAGE position. The choke system works best when the throttle is in the closed position. When the engine is warm, you do not need to use the choke system for starting.

NOTE: Refer to the RIDING YOUR ATV section of the manual for the engine starting procedure.

RIGHT HANDLEBAR

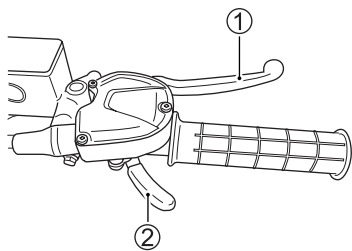

Front Brake Lever ①

Apply the front brake by squeezing the front brake lever towards the grip.

Throttle Lever ②

Control the engine speed with the position of the throttle lever. Operate this lever with your thumb. Push it forward to increase engine speed. Release it to decrease engine speed.

THROTTLE LIMITER

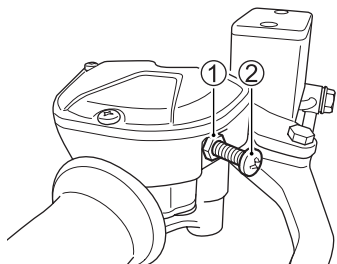

Use the throttle limiter to restrict maximum engine power by limiting throttle lever travel. Adjust this limiter according to the rider's skill and experience.

To adjust the throttle limiter:

1. Loosen the lock nut ①.
2. Turn the throttle limiter screw ② clockwise to restrict maximum engine power or counter-clockwise to increase the maximum engine power.
3. Tighten the lock nut ①.

REAR BRAKE PEDAL

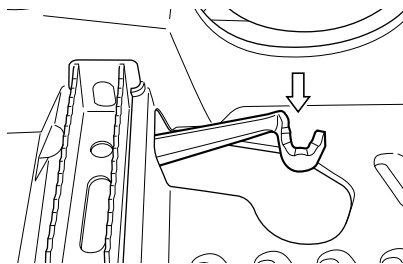

Pressing the rear brake pedal will apply the rear brake.

NOTE: The rear brake may also be applied by squeezing the rear brake lever.

FUEL VALVE

This vehicle is equipped with an automatic type, diaphragm style fuel valve. There are three positions: "ON," "RES" and "PRI."

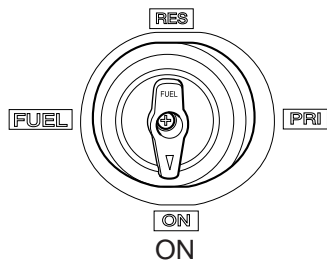

"ON" Position

The normal position for the fuel valve lever is in the "ON" position. In this position, no fuel will flow from the fuel valve to the carburetor unless the engine is running or being started.

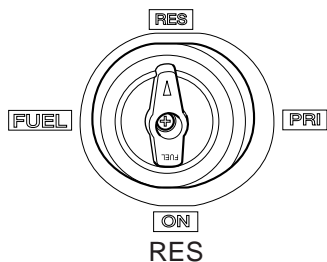

"RES" (RESERVE) Position

If the fuel level in the tank is too low, turn the lever to the "RES" position to use the reserve fuel supply. In this position, no fuel will flow from the fuel valve to the carburetor unless the engine is running or being started.

Reserve fuel supply: 2.9 L (0.8 US gal)

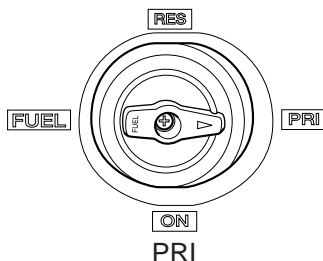

"PRI" (PRIME) Position

In this position, fuel can flow from the fuel valve to the carburetor. This position is used for checking the fuel supply system. Turn the fuel valve to the "PRI" position when the engine is hard to start below freezing point.

⚠ WARNING

Leaving the fuel valve in the "PRI" position when the engine is off can be hazardous.

The carburetor may overflow and fuel may run into the engine. This can cause a fire or cause severe damage to the ATV when you start the engine.

Always leave the fuel valve in the "ON" or "RES" position when the engine is not running.

RECOIL STARTER

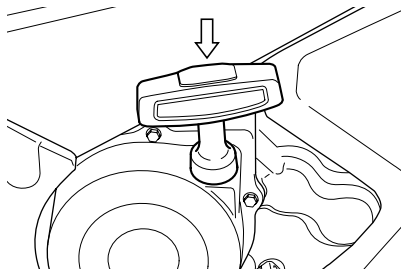

This vehicle has a recoil starter which can start the vehicle's engine if the electric starter does not work. To use the recoil starter, grip the starter rope handle located on the engine magneto cover. Pull the rope gently until you feel the starter engage. Pull the rope forcefully to start the engine. Immediately after the engine starts, be sure to gently return the starter rope to its normal position.

NOTE:

- *The engine can be started in any gear, if it is hard to shift into neutral, by squeezing the rear brake lever fully (you will hear the starter interlock switch "click.")*
- *Switch off the headlight when starting the engine with the recoil starter.*

FUEL TANK CAP

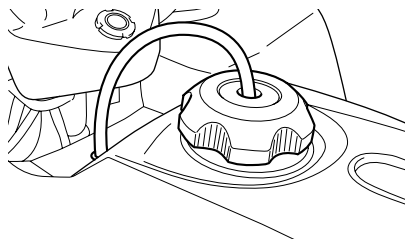

To open the fuel tank cap, remove the end of the vent tube from the vehicle body. Turn the fuel tank cap counterclockwise. To close the fuel tank cap, turn it clockwise and tighten it securely. Be sure that the vent tube is securely connected to the cap and is properly routed as shown.

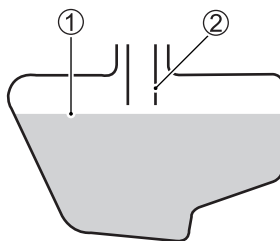

- ① Fuel level
- ② Filler neck

⚠ WARNING

Overfilling the fuel tank can be hazardous.

If you overfill the fuel tank, fuel may overflow when it expands. Fuel expands due to engine heat or heating by the sun. Fuel that overflows can catch fire.

Stop adding fuel when the fuel level reaches the bottom of the filler neck.

⚠ WARNING

Improper fueling of the ATV can be hazardous.

Failure to follow safety precautions when refueling could result in a fire or cause you to breathe toxic fumes.

Refuel in a well ventilated area. Make sure the engine is off and avoid spilling fuel on a hot engine. Do not smoke, and make sure there are no open flames or sparks in the area. Avoid breathing gasoline vapors. Keep children and pets away when you refuel the ATV.

FUEL GAUGE “”

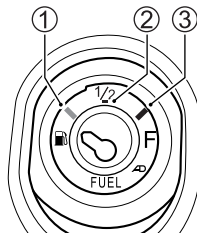

The fuel gauge shows the approximate amount of gasoline remaining in the fuel tank. The symbol mark in the fuel gauge shows as follows.

- Position ① –Fuel valve must be turned to RES position soon.
- Position ② –Fuel tank has half amount of gasoline.
- Position ③ –Fuel tank has full amount of gasoline.

SEAT LOCK

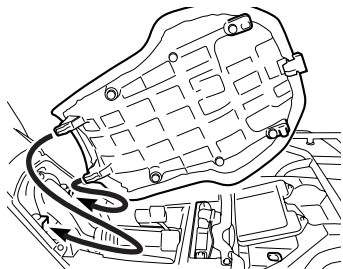
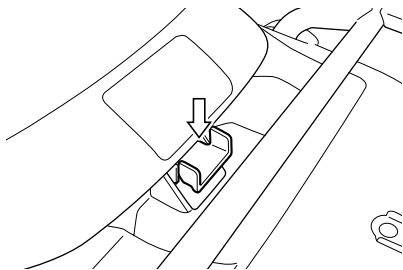

To remove the seat, move the seat lock lever upward. Raise the rear end of the seat and slide it backward. To lock the seat, slide the seat hook into the seat hook retainer and push down firmly.

⚠ WARNING

Improperly installing the seat can be hazardous.

Failure to install the seat properly could allow the seat to move and cause loss of rider control.

Make sure to properly position and securely attach the seat when you install it.

FLAG BRACKET

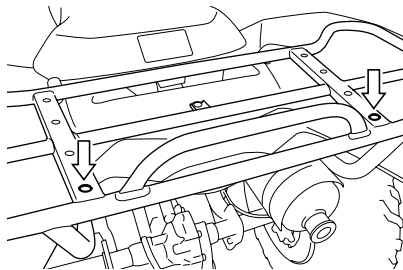

A bracket is provided so you can mount a flag on your LT-F400/F.

BOX

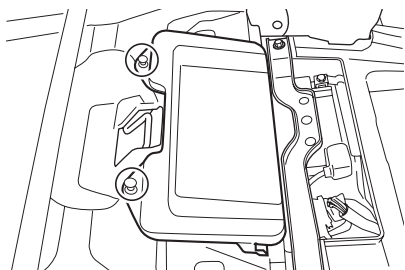

Small and light articles such as the tool kit, owner's manual, rain gear or a wind breaker can be placed in the box.

NOTE:

- *The box can get very hot since the heated engine is under the box. Do not keep any flammable items, low heat-resistant items, foods or drink in the box.*
- *Do not keep valuable items in the box when leaving the vehicle unattended.*





RIDING YOUR ATV

WHAT YOU SHOULD KNOW BEFORE RIDING	3-2
INSPECTION BEFORE RIDING	3-4
WHAT TO WEAR	3-6
BREAK-IN	3-7
STARTING THE ENGINE	3-8
STARTING OFF AND SHIFTING	3-10
BRAKING	3-15
TURNING	3-16
SKIDDING OR SLIDING	3-17
OPERATION ON HILLS	3-18
RIDING OVER OBSTACLES	3-23
RIDING THROUGH WATER	3-24
RIDING IN COLD WEATHER	3-25
RIDING IN REVERSE	3-29

WARNING

Indicates a potential hazard that could result in injury or death.

WHAT YOU SHOULD KNOW BEFORE RIDING

Before you ride, you should read all of the following information carefully. If you are properly prepared, you will have a safer and more enjoyable ride.

WARNING

Operating this ATV without proper instruction can be hazardous.

Your risk of having an accident greatly increases if you do not know how to operate the ATV properly in different situations and on different types of terrain.

Beginning and inexperienced operators should complete the certified training course offered by Suzuki. You should regularly practice the skills learned in the course and the operating techniques described in this owner's manual. For more information about the training course, contact your authorized Suzuki ATV dealer or in the USA call 1-800-887-2887.

⚠ WARNING

Operation of this ATV by children under age 16 can be hazardous.

Use by children under age 16 can lead to their severe injury or death. Children under age 16 may not have the size, strength, skills, or judgment needed to operate this ATV safely.

Do not allow any child under age 16 to ride this ATV.

⚠ WARNING

Operating this ATV after consuming alcohol or drugs can be hazardous.

Alcohol and drugs could seriously affect your judgment and cause you to react more slowly. They can also affect your balance and perception. Operating this ATV after consuming alcohol or drugs can result in an accident.

Never consume alcohol or drugs before or while riding this ATV.

Before you begin riding, you should find a good place to practice the skills you need to ride safely. Find a flat, open area with enough space to practice new skills.

Make sure that it is legal to ride in the area you have selected. Review local laws to make sure you are not trespassing. Check with your ATV dealer or call your local park ranger or police department if you do not know where you can ride.

Protect your riding areas. When you ride, remember to keep the terrain in good condition. Don't destroy plant life. Don't litter and don't bother wildlife. With your help, your riding areas can remain open for you to use in the future.

After you have found a good place to practice, review the controls on your ATV before riding. Learn to find these controls without looking for them. You will not have time to look for them when you are riding.

INSPECTION BEFORE RIDING

WARNING

Failure to inspect the ATV before operating it can be hazardous. Failure to perform proper maintenance can also be hazardous.

Failure to inspect and maintain your ATV increases the chances of an accident or equipment damage.

Always inspect your ATV each time you use it to make sure it is in safe operating condition. Refer to the **INSPECTION AND MAINTENANCE** section in this owner's manual.

WARNING

Operating this ATV with improper tires, or with improper or uneven tire pressure can be hazardous.

If you use improper tires or improper or uneven tire pressure, you may lose control of the ATV. This will increase your risk of an accident.

Always use tire of the size and type specified in this owner's manual. Always maintain proper tire pressure as described in the **INSPECTION AND MAINTENANCE** section.

WARNING

Operating this ATV with improper modifications can be hazardous.

Improper installation of accessories or modification of this vehicle may cause changes in handling. In some situations, this could lead to an accident.

Never modify this ATV through improper installation or use of accessories. Refer to the **ACCESSORY USE AND VEHICLE LOADING** section in this manual.

WARNING

Overloading this ATV can be hazardous.

Overloading could cause changes in vehicle handling which could lead to an accident.

Never exceed the stated load capacity for this ATV. Refer to the ACCESSORY USE AND VEHICLE LOADING section in this manual.

Check the condition of the ATV to help make sure that you do not have mechanical problems, or you might get stranded somewhere when you ride. Before riding the ATV, be sure to check the following items. Be sure your LT-F400/F is in good condition for the personal safety of the rider and protection of the vehicle.

WARNING

Checking maintenance items when the engine is running can be hazardous.

You could be severely injured if your hands or clothing gets caught in moving engine parts.

Shut the engine off when performing maintenance checks, except when checking the light, engine stop switch, and throttle.

WHAT TO CHECK	CHECK FOR
Steering	<ol style="list-style-type: none">1. Smoothness2. No restriction of movement3. No play or looseness
Brakes	<ol style="list-style-type: none">1. Fluid level in the reservoir to be above "LOWER" line2. No fluid leakage or damage3. Proper pedal and lever play4. No "sponginess"5. Parking brake effectiveness
Tire	<ol style="list-style-type: none">1. Proper pressure2. Enough tread depth3. No cracks, rips or other damage
Fuel	<ol style="list-style-type: none">1. Enough fuel for the intended run2. Fuel hose connected securely3. No damage to fuel tank or cap4. Tank cap closed securely
Lighting	Proper operation of all lights – Headlight, Brake/Taillight
Engine stop switch	Proper operation
Engine oil	Correct level
Gear oil	Correct level
Throttle	<ol style="list-style-type: none">1. Proper cable play2. Smooth response3. Quick return to idle position
Gearshift lever	<ol style="list-style-type: none">1. No damage2. Smooth operation
General condition	<ol style="list-style-type: none">1. Bolts and nuts are tight2. No rattle from any parts of the machine with the engine running3. No visible evidence of damage

WHAT TO WEAR

▲ WARNING

Operating this ATV without wearing an approved motorcycle helmet, eye protection and protective clothing can be hazardous.

Operating without an approved motorcycle helmet or eye protection increases your chances of a severe head injury or death in the event of an accident. Operating without protective clothing increases your chances of severe injury in the event of an accident.

Always wear an approved motorcycle helmet that fits properly. Always wear eye protection (goggles or face shield). You should also wear gloves, boots, long sleeve shirt or jacket, and long pants.



A helmet is the most important piece of gear you should wear. A helmet can help prevent a serious head injury. Choose a helmet that fits snugly. Ask your dealer for help in selecting a good quality helmet that fits properly.

You should wear eye protection when you ride. If a rock or branch hits you in the eyes, you could be severely injured. Wear goggles or a face shield.

Wear proper clothing when you ride. The proper clothes can help protect you from injury. Wear a good pair of gloves, strong boots that fit over the ankle, long pants, and a long sleeve shirt.

BREAK-IN

The first month is the most important in the life of your vehicle. Proper operation during this break-in period will help assure maximum life and performance from your new vehicle. The following guidelines explain proper break-in procedures.

Maximum Throttle Opening Recommendation

During the first 10 hours of operation, you should always use less than 1/2 throttle.

Vary the Engine Speed

Vary the engine speed during the break-in period. This allows the parts to "load" (aiding the mating process) and then "unload" (allowing the parts to cool). Although it is essential to place some stress on the engine components during break-in, you must be careful not to load the engine too much.

Avoid Constant Low Speed

Operating the engine at constant low speed (light load) can cause parts to glaze and not seat properly. Allow the engine to accelerate freely through the gears, without exceeding the maximum recommended throttle opening.

Allow the Engine Oil to Circulate Before Riding

Allow enough idling time after warm or cold engine starting before revving the engine or placing the transmission in gear. This allows time for the lubricating oil to reach all critical engine components.

Observe Your Initial and Most Critical Service

The initial service (break-in maintenance) is the most important service your vehicle will receive. During break-in operation, all of the engine components will have mated together and seated. Maintenance required as part of the initial service includes correction of all adjustments, tightening of all fasteners and replacement of dirty oil. Timely performance of this service will help make sure you get the best service life and performance from the engine.

▲ WARNING

Indicates a potential hazard that could result in injury or death.

STARTING THE ENGINE

Before attempting to start the engine, make sure to follow these steps:

1. Set the parking brake.
2. Shift the transmission to neutral.
3. Turn the key to the "ON" position.
4. Set the engine stop switch to the "O" position.
5. Set the fuel valve to the "ON" position.

This vehicle has two systems for engine starting. You can use the electric starter or the recoil starter. To use the electric starter, simply push the electric starter button. When you use the recoil starter, follow the procedure below.

- Pull the starter rope slowly until you feel the starter engage. With the starter engaged, pull the rope forcefully to start the engine.

NOTE: When the engine idling is too low with rattling just after engine starting, open the throttle lightly once to rise the idling speed.

When the Engine is Cold:

If the ambient temperature is below 5°C (40°F):

1. Move the choke lever to the ENGAGE position.
2. Push the electric starter button or use the recoil starter as described above to start the engine.
3. Immediately after the engine starts, return the choke lever halfway.
4. When the engine is sufficiently warmed up, move the choke lever to the "OFF" position.

NOTE: If the ATV is used under extremely cold conditions, ask your authorized Suzuki dealer to start the engine smoothly under the extremely cold conditions.

When the temperature is below 0°C (32°F):

1. Check the battery condition.
2. Check the spark plug condition.

When the temperature is below -10°C (14°F):

1. Change engine oil to SAE 5W/30.
2. Attach an engine block heater.

Under extremely cold conditions:

1. Change the carburetor starter jet from standard jet to richer jet.

NOTE: Turn the fuel valve to the "PRI" position when the engine is hard to start below freezing point. Return the fuel valve to "ON" or "RES" after starting the engine.

WARNING

Leaving the fuel valve in the “PRI” position when the engine is off can be hazardous.

The carburetor may overflow and fuel may run into the engine. This can cause a fire or cause severe damage to the ATV when you start the engine.

Always leave the fuel valve in the “ON” or “RES” position when the engine is not running.

If the ambient temperature is at or above 5°C (40°F):

1. Move the choke lever to the ENGAGE position halfway.
2. Push the electric starter button or use the recoil starter as described above to start the engine.
3. When the engine is sufficiently warmed up, move the choke lever to the “OFF” position.

NOTE: If the ambient temperature is above 20°C (68°F), operation of the choke is not necessary to start the engine. Operation of the choke can make the engine hard to start due to too rich fuel/air mixture.

When the Engine is Warm:

Operation of the carburetor choke system should not be necessary. Open the throttle slightly and push the electric starter button or use the recoil starter as described above to start the engine.

NOTE: Operation of the choke is not necessary to start the engine. Operation of the choke can make the engine hard to start due to too rich fuel/air mixture.

CAUTION

Engaging the starter motor for more than five seconds at a time can damage the ATV.

The starter motor and wiring harness may overheat.

If the engine does not start after several tries, check the fuel supply and ignition system.

WARNING

Running your ATV indoors where there is little or no ventilation can be hazardous.

When breathed in, exhaust gases from the ATV can cause death or severe injury.

Always run your ATV outdoors where there is fresh air.

STARTING OFF AND SHIFTING

WARNING

Carrying a passenger on this ATV can be hazardous.

Carrying a passenger can greatly reduce your ability to balance and steer this ATV. If you carry a passenger, you can lose control, and both you and the passenger can be severely injured.

Never carry a passenger. The ATV has a long seat so you can change position to maneuver the ATV. It is not for carrying passengers.



WARNING

Operating this ATV on paved surfaces, including sidewalks, paths, parking lots, driveways, and streets can be hazardous.

ATV tires are designed for off-road use. Paved surfaces may seriously affect handling and control of the ATV, and may cause the vehicle to go out of control.

Avoid operating the ATV on paved surfaces whenever possible. If you must ride on a paved surface, go slowly and do not make sudden turns or stops.

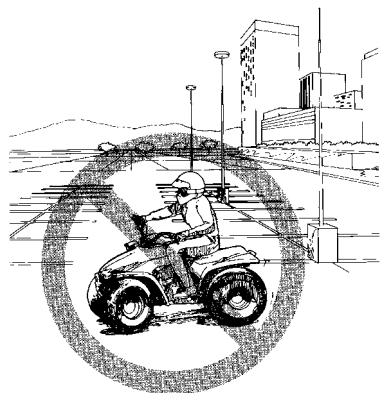

⚠ WARNING

Operating this ATV on public streets, roads or highways can be hazardous.

You can collide with another vehicle if you ride on public roads.

- Never operate this ATV on any public street, road or highway, even a dirt or gravel one.
- In many states it is illegal to operate ATVs on public streets, roads and highways.

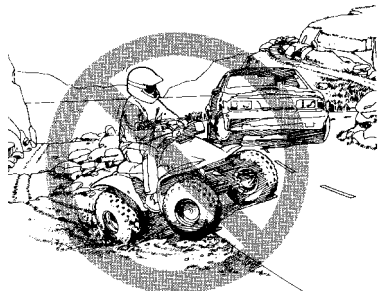

⚠ WARNING

Operating this ATV at excessive speeds can be hazardous.

Riding at excessive speeds increases your chances of losing control of the ATV, which can result in an accident.

Always go at a speed that is proper for the terrain, visibility and operating conditions, your skills and experience.

⚠ WARNING

Attempting wheelies, jumps, and other stunts can be hazardous.

Stunt riding increases the chance of an accident, including an overturn.

Never attempt stunts, such as wheelies or jumps. Don't try to show off.

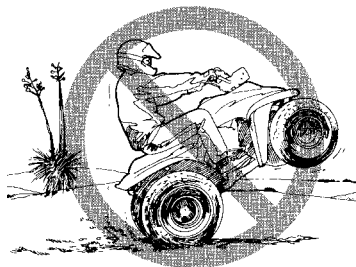

▲ WARNING

Removing your hands from the handlebars or feet from the footrests during operation can be hazardous.

If you remove even one hand or foot from the ATV, you can reduce your ability to control the ATV. This could cause you to lose your balance and fall off the ATV. If you remove a foot from a footrest, your foot or leg may come in contact with the rear wheels. This could injure you or cause an accident.

Always keep both hands on the handlebars and both feet on the foot pegs of your ATV during operation.

▲ WARNING

Failure to use extra care when operating on excessively rough, slippery, or loose terrain can be hazardous.

Failure to use extra care can cause loss of traction or vehicle control. This could result in an accident, including an overturn.

Do not operate under these conditions until you have learned and practiced the skills necessary to control the ATV on such terrain. Always be especially cautious on these kinds of terrain.



▲ WARNING

Failure to use extra care when operating this ATV on unfamiliar terrain can be hazardous.

You can come upon hidden rocks, bumps, or holes, without enough time to react. This could cause the ATV to overturn or go out of control.

Go slowly and be extra careful when operating on unfamiliar terrain. Always be alert to changing terrain conditions when operating the ATV.

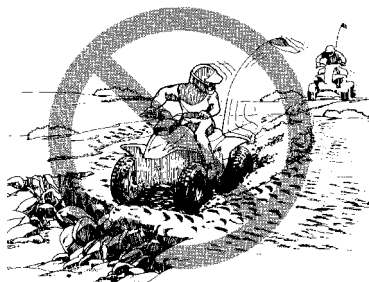

▲ WARNING

The ATV can start moving as soon as you release the parking brake.

Unexpected movement can cause you to lose control of the ATV.

Make sure you shift into neutral and apply the rear brake before you release the parking brake.

After making sure that the engine is warm, apply the rear brake and then release the parking brake. To release the parking brake, simply squeeze the rear brake lever until the parking brake lock releases.

While holding the rear brake, engage first gear by lifting up on the gearshift lever. To start moving, release the brake, then gradually open the throttle. When the vehicle's speed has increased, release the throttle and lift the gearshift lever to engage second gear. You can select third, fourth and top gear in succession by repeating this shifting sequence.

Reduce vehicle speed before shifting down. To shift down, release the throttle and shift down to engage a lower gear.

The table below shows the approximate speed range for each gear with the Range Lever set to High Range.

Shifting up schedule

Gear position	km/h	miles/h
1st → 2nd	12	7
2nd → 3rd	20	12
3rd → 4th	30	19
4th → 5th	40	25

Shifting down schedule

Gear position	km/h	miles/h
5th → 4th	30	19
4th → 3rd	20	12

WARNING

Opening the throttle suddenly can be hazardous.

The front wheels can lift off the ground and cause loss of control of the ATV.

Always open the throttle gradually when you accelerate.

WARNING

Shifting incorrectly can be hazardous.

Downshifting at too high of a speed can cause sudden slowing and may pitch the rider forward. Also, engine and drivetrain damage can occur if you do not shift correctly.

Slow down before downshifting and always release the throttle every time you shift gears.

BRAKING

To stop the LT-F400/F, first release the throttle lever. Next, apply the front and rear brakes evenly and at the same time. As vehicle speed decreases, shift down through the gears.

⚠ WARNING

Braking while turning the ATV can be hazardous.

Use of the brake when turning could cause the ATV to slide or roll over.

Use the brakes to slow down before you begin to turn.

⚠ WARNING

Braking hard on slippery surfaces can be hazardous.

The ATV can skid and go out of control if you brake too hard.

Apply the brakes lightly and with care on slippery surfaces.

⚠ WARNING

Operating the parking brake lock when the ATV is moving can be hazardous.

The rear wheels can lock, causing a skid and an accident.

Use the parking brake only after you stop the ATV.

⚠ WARNING

Braking on hills can be hazardous.

As the LT-F400F is four-wheel drive, using either the front brake alone or the rear brake alone will actually brake all four wheels. Therefore, any application of the brakes will result in braking force being applied to the downhill wheels. This could cause the vehicle to overturn.

Be extra careful when braking on a hill.

TURNING

WARNING

Turning the ATV improperly can be hazardous.

If you turn the ATV improperly, it may cause a collision or overturn.

Always follow proper procedures for turning as described in this section. Practice turning at low speeds before attempting to turn at faster speeds. Never turn at excessive speeds.

To turn the LT-F400/F, the rider must use the proper technique. Because this vehicle has a solid rear axle, both rear wheels always turn at the same speed. This means that if the rear wheels are getting equal traction, the vehicle will tend to move straight ahead. This is because the rear wheels will travel the same distance. For the vehicle to turn, the outside rear wheel must travel a greater distance than the inside rear wheel. To make this happen, the rider must create less traction for the inside wheel, allowing it to slip somewhat. This allows it to travel a shorter distance than the outside wheel. This happens even though both wheels are still turning at the same speed.

To turn the LT-F400/F, use the following technique:

- Move your body weight forward and to the inside of the turn.
- Turn the handlebars while looking in the direction of the turn.

For HIGHER SPEEDS or SHARPER TURNS:

Use the same technique that you use for turning at low speeds, but move your body weight farther toward the inside of the turn to maintain your balance. Natural turning forces (which can push the vehicle to the outside of the turn) increase as speed or turn sharpness increases. This means you must lean your body farther into the turn as you go faster or turn more sharply. This prevents the vehicle from tipping over to the outside of the turn. If your ATV starts to tip while turning, lean your body farther into the turn while gradually reducing the throttle and making the turn wider, if possible.

SKIDDING OR SLIDING

WARNING

Skidding or sliding improperly can be hazardous.

You may lose control of your ATV, or regain traction unexpectedly, which may cause the ATV to overturn.

- **Learn to safely control skidding or sliding by practicing at low speeds and on level, smooth terrain.**
- **On extremely slippery surfaces, such as ice, go slowly and be very cautious in order to reduce the chance of skidding or sliding out of control.**

You may experience skidding or sliding when you are not braking. You may be able to overcome it by using the techniques listed below.

If your front wheel skids:

Gain front wheel traction by reducing the throttle opening and leaning your body weight slightly forward.

If your rear wheel skids:

If space permits, steer in the direction of the skid. Shift your body weight away from the skid slightly. Avoid using the throttle or brakes until you regain directional control of the vehicle.

OPERATION ON HILLS

▲ WARNING

Operating this ATV on excessively steep hills can be hazardous.

The ATV can overturn more easily on extremely steep hills than on level surfaces or small hills.

Never operate the ATV on hills too steep for the ATV or for your abilities. Practice on smaller hills before trying larger hills.

Climbing a Hill

▲ WARNING

Climbing hills improperly can be hazardous.

Climbing hills improperly can cause loss of control or cause the ATV to overturn.

- Always follow the proper procedures for climbing hills as described in this section.
- Always check the terrain carefully before you start up any hill.
- Never climb hills with excessively slippery or loose surfaces.
- Shift your weight forward.
- Never open the throttle suddenly or make sudden gear changes. The ATV could flip over backwards.
- Never go over the top of any hill at high speed. An obstacle, a sharp drop, or another vehicle or person could be on the other side of the hill.

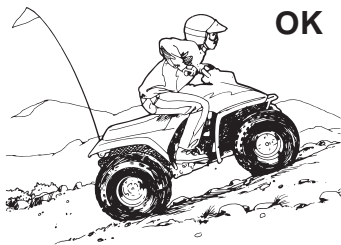

▲ WARNING

Braking on hills can be hazardous.

As the LT-F400F is four-wheel drive, using either the front brake alone or the rear brake alone will actually brake all four wheels. Therefore, any application of the brakes will result in braking force being applied to the downhill wheels. This could cause the vehicle to overturn.

Be extra careful when braking on a hill.

To climb a hill with the LT-F400/F, follow the directions below.

1. Speed up and maintain a steady speed before reaching the bottom of the hill. Shift down to increase approach speed, if necessary. Remember that you must ride at a steady speed all the way to the top of the hill.
2. Shift body weight forward by sliding forward on the seat. Lean slightly forward. For steep hills, stand on the footrests and lean out over the front wheel.
3. Maintain a steady speed while climbing the hill.
4. Slow down when you reach the top of the hill.

▲ WARNING

Stalling, rolling backwards or improperly dismounting the ATV while climbing a hill can be hazardous.

The ATV could overturn if you do not climb a hill properly.

Use the proper gear and maintain a steady speed when climbing a hill. Always follow the proper procedures for climbing hills as described in this section.

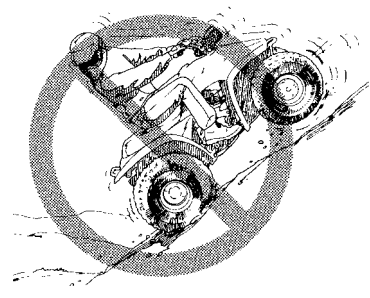

You may start to climb a hill and may be unable to make it to the top. If this happens, use the correct procedure described below to turn around to get back down the hill.

If you still have forward movement and enough space to turn around safely, follow these instructions.

1. Turn around on the hill before you lose forward speed. As you turn on the side of the hill, lean your body weight uphill.
2. Once you have turned around, ride down the hill as described in the DESCENDING A HILL section.

If you lose forward movement, or begin to roll backwards, follow these instructions.

1. Lean farther forward, uphill.
2. Apply the front brake to stop the ATV.
3. After the vehicle has stopped, apply the rear brake as well as the front brake.
4. Set the parking brake and dismount to the left side while still leaning uphill.
5. Use one of the following procedures to turn the vehicle around.
 - a. If you are able to, drag the rear end of the LT-F400/F around until the vehicle points downhill. Stay on the uphill side of the vehicle while dragging it around.

- b. Turn the handlebars fully to the left. Stand on the uphill side of the vehicle. Release the parking brake and pump the hand brake to let the LT-F400/F roll slowly backwards. This will turn the vehicle sideways to the hill. Reset the parking brake. Turn the handlebars to the right. Stay on the uphill side. Release the parking brake and pump the hand brake to let the ATV slowly roll until it points downhill. Reset the parking brake.

6. Remount the vehicle, apply the brakes, release the parking brake and ride down the hill as instructed in the DESCENDING A HILL section.

If the front brake does not slow the vehicle, dismount to the side immediately.

Descending a Hill

⚠ WARNING

Going down a hill improperly can be hazardous.

Going down a hill improperly can cause loss of control or cause the ATV to overturn.

Always follow the proper procedures for going down hills as described in this section.

OK

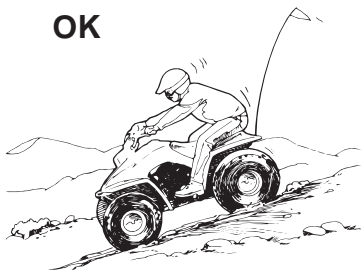

⚠ WARNING

Braking on hills can be hazardous.

As the LT-F400/F is four-wheel drive, using either the front brake alone or the rear brake alone will actually brake all four wheels. Therefore, any application of the brakes will result in braking force being applied to the downhill wheels. This could cause the vehicle to overturn.

Be extra careful when braking on a hill.

To ride down a hill with the LT-F400/F, follow the instructions below.

1. Check the terrain carefully for any obstacles before you start down the hill.
2. Point the LT-F400/F straight downhill.
3. Transfer body weight to the rear by sliding back on the seat.
4. Shift the transmission into a low gear and ride down the hill slowly with the throttle released.
5. Apply the rear brake to control downhill speed.

NOTE: Operating any brake control will brake at both front and rear wheels.

6. Avoid going down a hill at an angle that would cause the vehicle to lean sharply to one side. Go straight down the hill where possible.

Traversing a Slope

WARNING

Crossing hills or turning on hills improperly can be hazardous.

Crossing hills or turning on hills improperly can cause loss of control or cause the ATV to overturn.

Never attempt to turn the ATV around on any hill until you have mastered the turning technique as described in the **CLIMBING A HILL section. Practice this technique on level ground. Be very careful when turning on any hill. Avoid crossing the side of a steep hill if possible.**

OK

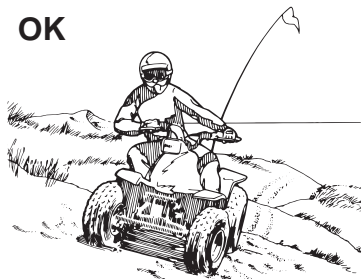

When traversing a slope, you should:

1. Lean your body uphill.
2. Steer slightly uphill, if necessary, to maintain a straight course.

RIDING OVER OBSTACLES

WARNING

Improperly operating this ATV over obstacles can be hazardous.

Improperly crossing obstacles can cause loss of control or a collision. It can also cause the ATV to overturn.

Follow the procedure in this section carefully when crossing over obstacles.

If you come to an obstacle that you cannot avoid, you may be able to cross over it using the following procedure.

1. With the obstacle straight in front of you, approach at walking speed.
2. Rise up slightly on the footrests.
3. Pull up on the handlebars and apply a little throttle as the front wheels reach the obstacle.
4. Lean forward and release the throttle after the front wheels have cleared the obstacle.
5. Return to your normal riding position after the rear wheels clear the obstacle.

Remember that some obstacles are too high for your ATV or for your abilities. If you are not sure that you can safely cross over an obstacle, back up and ride around the obstacle.

RIDING THROUGH WATER

WARNING

Operating this ATV through deep or fast flowing water can be hazardous.

The ATV tires may float, causing loss of traction and loss of control. This could lead to an accident.

- Never operate this ATV in fast flowing water or in water deeper than described in this section.
- Remember that wet brakes may have reduced stopping ability. Test your brakes after leaving the water. If necessary, apply them several times to let friction dry out the linings.

You can ride the LT-F400/F through shallow water. Make sure it is not more than 30 cm (12 in) deep and is not moving fast. Choose a good place to cross before you ride through any water. Look for a spot where the banks are gently sloped on both sides and the bottom of the stream is hard. If you are unfamiliar with the area, park the LT-F400/F and inspect the stream first to find a suitable spot for crossing. When crossing, operate the ATV at a slow, steady speed. Be careful not to damage banks when crossing.

CAUTION

Operating the ATV in water, sand, or mud causes rapid brake wear.

Excessive brake wear can cause the brakes to be less effective.

After repeated operation of the ATV in these condition, bring it to your Suzuki dealer to have the brakes inspected and cleaned.

RIDING IN COLD WEATHER

Pre-ride Inspection

Check that the throttle and all control levers move freely. Make sure that the footrests shift lever, and rear brake pedal are free of ice or snow.

CAUTION

Using engine power to free up frozen wheels can damage your ATV.

Severe damage to the drive train may occur if you use engine power to free frozen wheels.

Before riding, manually move the ATV forward and backward to make certain that all wheels roll freely.

With the transmission in neutral, move the ATV forward and backward to check that the wheels roll freely. If you cannot move the ATV, the tires may be frozen to the ground, or the brakes may be frozen to the wheels. If the tires are frozen to the ground, pour warm water around them to melt the ice. If the brakes are frozen, bring the ATV to a warmer area to thaw out the brakes.

CAUTION

Use of an automotive-size battery to jump-start an ATV can damage the ATV.

A high-amperage battery can damage the electrical system.

Use only the specified battery to start the engine. Refer to the maintenance section of your owner's manual for the proper battery charging procedure.

NOTE: If the ATV will be used frequently in temperatures below 14°F (-10°C), we recommend that you change the oil to 5W-30 and install an engine block heater.

After the engine has warmed up, check the brakes. Do this inspection on level ground and do not exceed walking speed. Be sure to check the operation of both front and rear brakes. If the brakes do not work adequately, stop riding the ATV. Bring the ATV to a warmer area to allow the brakes to thaw out. After the brakes thaw, dry them by applying them several times while riding slowly. If the brakes do not regain full stopping power, have your local Suzuki dealer check them before you continue riding your ATV.

WARNING

Operating the ATV without a properly functioning brake system can be hazardous.

Wet or frozen brakes will increase stopping distance. This will increase your chance of having an accident.

Be sure to inspect the brakes before each use of the vehicle in cold weather as described above.

Any water that enters the brakes while you ride may freeze after you park your ATV. The frozen water can prevent the wheels from turning or the brakes from working. After riding through water, mud, snow, or slush it is important to dry the brakes before parking the ATV. To dry the brakes, apply them several times while riding slowly. Before your next ride, be sure to do a pre-ride inspection as described earlier in this section.

Dressing for Cold Weather Riding

WARNING

Operating your ATV in cold weather without proper clothing can be hazardous.

Continued exposure to cold temperatures can lead to hypothermia. Hypothermia is a condition where your body's inner temperature drops low enough to cause injury or death.

Always dress for the worst weather conditions you might encounter. Be prepared for bad weather and ATV breakdowns.

Riding in cold weather can be hazardous. At a temperature of 10°F (-12°C), the wind chill created by going just 15 km/h (9 miles/h) makes you as cold as if you were standing still at a temperature of -9°F (-23°C). At this temperature, exposed flesh will freeze in just a few minutes.

Continued exposure to cold temperatures can also lead to hypothermia. Hypothermia occurs when your body's inner temperature drops. Symptoms include numbness in the extremities (hands, feet, arms, and legs), and shivering. Damp clothing contributes to hypothermia because cold water on your skin will drain heat from your body's core.

We strongly recommend that if you do any cold-weather riding, you familiarize yourself with the symptoms, treatment, and prevention of hypothermia. Information is available at libraries and through government agencies.

Plan your winter rides with safety and comfort in mind. Dress for the worst conditions you might encounter. Be prepared for bad weather and ATV breakdowns. Wear warm, water-resistant clothing such as thermal underwear, snowmobile suits, lined gloves and boots, and wool socks.

WARNING

Wearing loose clothing when riding your ATV can be hazardous.

Loose clothing, such as a long scarf or shawl, can get caught in an ATV's moving parts.

Never wear loose clothing when riding your ATV.

Riding your ATV on Snow and Ice

WARNING

Riding on snow-covered terrain without care can be hazardous.

The snow may be covering rocks, holes, ice or other hazards that can cause a loss of control. Severe injury or death could occur if you lose control of the ATV.

Go slowly and be extra careful when riding on snow-covered terrain. Always be alert to changing terrain conditions when operating the ATV.

WARNING

Riding on a frozen lake or river can be hazardous.

Serious injury or death can occur if the ice breaks and you fall into the cold water.

Check with local authorities to verify the thickness of the ice and areas to avoid.

WARNING

Failure to use extra care when operating on slippery surfaces such as hard-packed snow and ice can be hazardous.

Failure to use extra care can cause loss of traction or loss of vehicle control. This could result in an accident, including an overturn.

Do not operate on slippery surfaces until you have learned and practiced the skills necessary to control the ATV on such terrain. Always use extra care on slippery surfaces. Avoid snow- or ice-covered hills whenever possible.

Practice riding your ATV in an open snow- or ice-covered area, at slow speeds, before heading out on snow- or ice-covered trails. Learn how your ATV responds to steering and braking on the type of terrain you will encounter on your ride.

Your eyes may be sensitive to sunlight when you ride over snow or ice on a bright, sunny day. Snow or ice reflects more light into your eyes than dirt or grass does. Tinted eye protection will reduce the amount of light reaching your eyes. Always use clear eye protection when riding at night. On overcast days, you may find it helpful to use yellow-tinted eye protection.

RIDING IN REVERSE

WARNING

Improperly riding this ATV in reverse can be hazardous.

You could hit an obstacle or person behind you, resulting in injury.

When you select reverse gear, make sure there are no obstacles or people behind. When it is safe, back up slowly.

To engage reverse gear, follow these directions.

1. Stop the vehicle and shift into neutral.
2. Apply the front and rear brakes and move the range lever to the reverse position.
3. Look to make sure there is nothing in your way behind you.
4. Slowly release the brakes and apply the throttle.

WARNING

Sudden application of the throttle or making abrupt turns in reverse gear can be hazardous.

Throttle surges or abrupt turns could cause you to lose control of the ATV.

When you ride in reverse, go slowly and turn carefully.

WARNING

Indicates a potential hazard that could result in injury or death.



ACCESSORY USE AND VEHICLE LOADING

ATV WINCH LEAD WIRES 4-4

ACCESSORY USE AND VEHICLE LOADING

There are many types of accessories for sale. However, Suzuki can not have direct control over the quality or suitability of non-Suzuki accessories. Suzuki can not test each accessory that is available. If you add the wrong accessories or misuse the vehicle with some accessories installed, it can make the ATV less safe to ride.

Use caution when choosing and installing accessories for your Suzuki. Your Suzuki dealer may be able to help you choose accessories and install them correctly. The guidelines below should help you decide how to equip your ATV and how to use it correctly when you use accessories or carry cargo.

WARNING

Operating this ATV with improper modifications can be hazardous.

Improper installation of accessories or modification of the vehicle may cause changes in handling which could lead to an accident.

Never modify the ATV with improper installation or use of improper accessories. All parts and accessories added to the ATV should be genuine Suzuki parts or their equivalent that have been designed for use on this ATV. Install and use them according to their instructions. If you have any questions, contact your Suzuki dealer.

Suzuki dealers offer a variety of genuine Suzuki accessories for your ATV. Please contact your Suzuki dealer for details.

Accessory Use and Vehicle Loading Guidelines.

1. The combined weight of the rider, gear, trailer tongue weight and any accessories or cargo must never exceed the vehicle's load capacity of 172 kg (380 lbs).
2. Check accessory mounting brackets and other attachment hardware to make sure they provide a rigid, non-movable mount.
3. Accessories added to the handlebars of the machine should be as light as possible. The extra weight can cause the vehicle to be harder to steer.
4. Do not add accessories or cargo which interfere with controls or other equipment.
5. Do not carry heavy or bulky cargo. Cargo racks are designed to carry light items.
6. Distribute cargo weight evenly between the front and rear of the vehicle as well as both sides of the vehicle. Locate cargo weight as close to the center of the vehicle as possible. (e.g. load cargo to the rear of front racks and to the front of rear racks). Do not let cargo stick out beyond the edges of the racks.

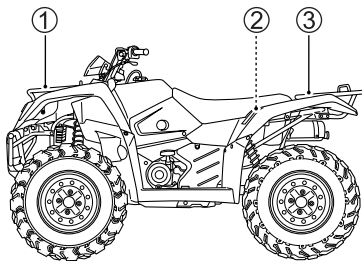

- ① Front cargo rack: 30 kg (66 lbs)
 - ② Box: 2 kg (4.4 lbs)
 - ③ Rear cargo rack: 60 kg (132 lbs)
7. Secure your load well. Shifting weight can affect your ability to handle the vehicle safely.
 8. Ride at slow speeds and avoid hills when carrying cargo. Carrying loads can affect the stability and handling of your ATV.
 9. Allow enough stopping distance. Stopping distance increases when you carry loads. Use engine braking as much as possible.

ATV WINCH LEAD WIRES

LT-F400F has lead wires in the wiring harness that can be used to attach a Suzuki genuine accessory ATV winch, rated line pull: 1360 kg (3000 lbs). The part number of the Suzuki ATV winch for this vehicle is 99000-990YW-016. Consult your Suzuki dealer for details about attaching the accessory ATV winch.



INSPECTION AND MAINTENANCE

MAINTENANCE SCHEDULE	5-2
NOTICE	5-3
TOOL	5-5
BATTERY	5-5
SPARK PLUG	5-7
IDLE SPEED ADJUSTMENT	5-9
THROTTLE CABLE ADJUSTMENT	5-9
CHOKE CABLE ADJUSTMENT	5-10
FUEL HOSE	5-10
ENGINE OIL	5-11
AIR CLEANER	5-16
AIR CLEANER DRAIN TUBE	5-19
GEAR OIL CHANGE	5-20
TIRES	5-21
BRAKES	5-24
FRONT BRAKE	5-25
REAR BRAKE	5-28
REAR BRAKE LINING WEAR LIMIT	5-30
FRONT AND REAR WHEEL REMOVAL	5-31
SPARK ARRESTER	5-32
DRIVE SHAFT BOOTS (LT-F400F)	5-33
LIGHT BULB REPLACEMENT	5-33
FUSE	5-35
OUTPUT TERMINAL	5-36
GENERAL LUBRICATION	5-37
TRAILER TOWING	5-38

INSPECTION AND MAINTENANCE

WARNING

Indicates a potential hazard that could result in injury or death.

MAINTENANCE SCHEDULE

Perform maintenance according to odometer reading or time interval, whichever comes first.

Item	Interval	km	Initial 200	Every 1000	Every 2000
		miles	Initial 100	Every 600	Every 1200
		months	Initial 1	Every 3	Every 6
Air cleaner element			–	C	C
* Exhaust pipe nuts and muffler mounting bolts			T	T	T
* Valve clearance			I	–	I
Spark plug			–	–	I
			Replace every 6000 km (4000 miles)		
Spark arrester			–	–	C
Fuel hose			–	I	I
			* Replace every 4 years		
Engine oil and oil filter			R	–	R
Front differential gear oil (LT-F400F)/ Final gear oil			–	–	I
			Replace every 2 years		
Throttle cable play			I	I	I
Idle speed			I	I	I
* Clutch			–	–	I
Drive shaft boots (LT-F400F)			I	I	I
* Brakes			I	I	I
Brake fluid			–	I	I
			* Replace every 2 years		
Brake hose			–	–	I
			* Replace every 4 years		
Tires			–	I	I
* Steering			I	I	I
* Suspensions			–	–	I
* Chassis bolts and nuts			T	T	T
* General lubrication			–	L	L

I= Inspect and clean, adjust, lubricate or replace, as necessary,
C= Clean, T= Tighten, R= Replace, L= Lubricate

NOTICE

MAINTENANCE, REPLACEMENT OR REPAIR OF THE EMISSION CONTROL DEVICES AND SYSTEMS MAY BE PERFORMED BY ANY ATV REPAIR ESTABLISHMENT OR INDIVIDUAL USING ANY ATV PART WHICH HAS BEEN CERTIFIED UNDER THE PROVISIONS IN THE CLEAN AIR ACT Sec. 207 (a)(2).

It is very important to inspect and maintain your LT-F400/F regularly. Follow the guidelines in the chart. The intervals between periodic services in miles (kilometers) and months are shown. At the end of each interval, be sure to perform the maintenance listed.

WARNING

Improper maintenance or failure to perform recommended maintenance can be hazardous.

If you perform improper maintenance or do not maintain your ATV, you may have an accident.

Keep your ATV in good condition. Ask your Suzuki dealer or a qualified mechanic to do the maintenance items marked with an asterisk (*). You may perform the unmarked maintenance items by referring to the instructions in this section, if you have mechanical experience. If you are not sure how to do any of the jobs, ask your Suzuki dealer to do the maintenance.

CAUTION

If you use your ATV under severe conditions, it will need maintenance more often than shown in the chart.

Operating your ATV under severe conditions causes more wear on your ATV. Severe conditions include operating under frequent full throttle, or in dusty, wet, sandy, or muddy areas. These conditions can cause the ATV to wear more quickly.

Perform maintenance more often than shown in the chart. If you have any questions regarding maintenance intervals, consult your Suzuki dealer.

CAUTION

Using poor quality replacement parts can damage your ATV.

Poorly-made replacement parts can cause your ATV to wear more quickly and may shorten its useful life.

When replacing parts on your vehicle, use only genuine Suzuki replacement parts or their equivalent.

TOOL

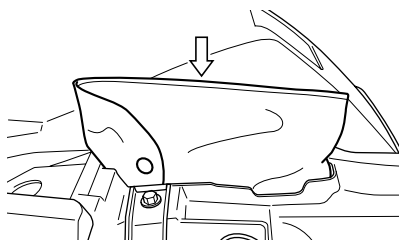

A tool kit is provided with your ATV. It is located under the seat.

BATTERY

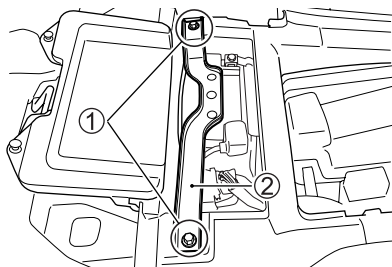

The battery is located under the seat. This battery is a sealed type battery and requires no maintenance. Have your dealer check the battery's state of charge periodically. To remove the battery, loosen the bolts ① and remove the bracket ②.

If the battery is discharged, recharge the battery. The standard charging rate is $1.4A \times 5$ to $10hr$ and the maximum charging rate is $6.0A \times 1hr$.

⚠ WARNING

Battery posts, terminals, and related accessories contain lead and lead compounds which can be hazardous.

When working near the battery, you can come in contact with lead and lead compounds.

Wash hands after handling.

⚠ WARNING

Hydrogen gas produced by batteries can be hazardous.

Batteries produce flammable hydrogen gas which can explode if exposed to flames or sparks.

Keep flames and sparks away from the battery. Never smoke when working near the battery.

CAUTION

Exceeding the maximum charging rate for the ATV battery can damage your ATV.

If you charge the battery at a rate too high, it will decrease the life of the battery.

Never exceed the maximum charging rate.

CAUTION

Reversing the battery lead wires can harm your ATV.

Reversing the battery lead wires can damage the charging system and the battery.

The red lead must go to the (+) positive terminal and the black (or black with white tracer) lead must go to the (-) negative terminal.

SPARK PLUG

Spark Plug Removal

1. Remove the seat by referring to the SEAT LOCK section.
2. Remove the left side frame cover.

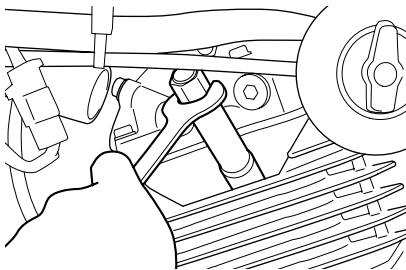
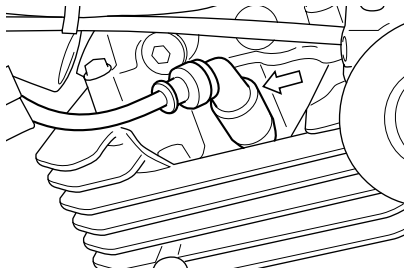

3. Disconnect the spark plug cap.
4. Remove the spark plug with a spark plug wrench.

Your LT-F400/F comes equipped with an NGK CR7E or DENSO U22ESR-N. To determine if the standard spark plug is right for your usage, check the color of the plug's porcelain center electrode insulator after vehicle operation. A light brown color indicates that the plug is correct. A white or dark insulator indicates that the engine may need adjustment, or another plug type may be needed. Consult your Suzuki dealer if your plug insulator is not a light brown color.

CAUTION

Failure to use the proper spark plug can be hazardous.

An improper spark plug may have an incorrect fit or heat range for your engine. This may cause severe engine damage which may not be covered under warranty.

Use one of the spark plugs listed below or equivalent. Consult your Suzuki dealer if you are not sure which spark plug is correct for your type of vehicle usage.

NGK	DENSO	REMARKS
CR6E	U20ESR-N	If the standard plug tends to run cold.
CR7E	U22ESR-N	Standard
CR8E	U24ESR-N	If the standard plug tends to run hot.

NOTE: If the above-named plugs are not available, consult your Suzuki dealer.

To install a spark plug, turn it in as far as possible with your fingers, then tighten it with a wrench.

CAUTION

Improper installation of the spark plug can damage your ATV.

An overly tight or cross threaded plug will damage the aluminum threads of the cylinder head.

Carefully turn the spark plug by hand into the threads. If the spark plug is new, tighten it with a wrench about 1/2 turn past finger tight. If you are reusing the old spark plug, tighten it with a wrench about 1/8 turn past finger tight.

CAUTION

Dirt can damage your ATV if it enters an open spark plug hole.

Dirt can damage engine parts that move.

Cover the spark plug hole while the spark plug is out of the hole.

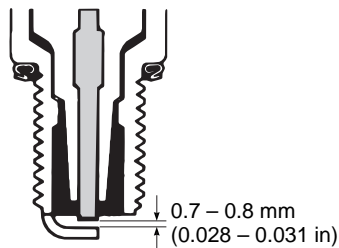

To maintain a hot, strong spark, keep the plug free from carbon. Adjust the gap to 0.7 – 0.8 mm (0.028 – 0.031 in) for good ignition. Use a thickness gauge to check the gap.

IDLE SPEED ADJUSTMENT

To adjust the idle speed properly, you need a tachometer. If you do not have one, ask your Suzuki dealer to perform this adjustment.

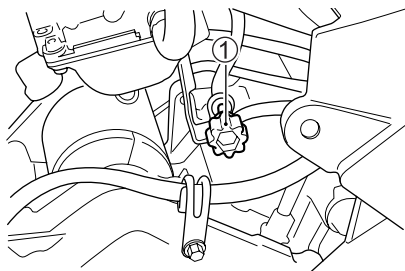

To adjust the idle speed:

1. Start the engine and warm it up.
2. Turn the throttle stop screw ① in or out so that the engine idles at 1400 – 1600 r/min.

⚠ WARNING

Improper adjustment of the idle speed can be hazardous.

An idle that is too high can cause the ATV to lurch forward when you shift to first gear. This may cause an accident. Excessive engine wear may also result if idle speed is adjusted improperly or when the engine is not fully warmed up.

Adjust the idle to the correct speed. Make sure the engine is fully warm before adjusting the idle speed.

THROTTLE CABLE ADJUSTMENT

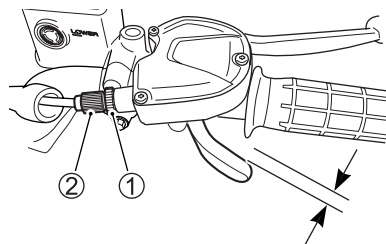

To adjust the throttle cable play:

1. Remove the boot.
2. Loosen the lock nut ①.
3. Turn the adjuster ② in or out so that the throttle lever end has proper play of 3.0 – 5.0 mm (0.12 – 0.20 in).
4. Tighten the lock nut ①.
5. Recheck the throttle cable play. Readjust it if it is not within the specified limits.
6. Replace the boot.

⚠ WARNING

Operating the vehicle with an inadequate throttle cable play can be hazardous.

Inadequate throttle cable play can cause engine speed to rise suddenly when you turn the handlebar. This can lead to loss of rider control.

Adjust the throttle cable play so that engine idle speed does not rise due to handlebar movement.

CHOKE CABLE ADJUSTMENT

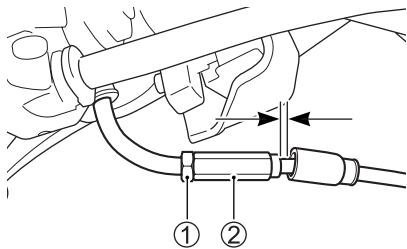

To adjust the choke cable play:

1. Remove the boot.
2. Loosen the lock nut ①.
3. Turn the adjuster ② in or out to obtain the proper amount of outer cable free play 0.5 – 1.0 mm (0.02 – 0.04 in). Measure choke cable free play by pulling on the outer cable.
4. After adjusting the play, tighten the lock nut ①.
5. Replace the boot.

FUEL HOSE

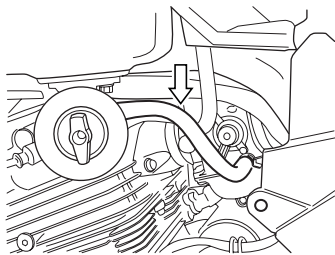

Replace the fuel hose every 4 years, even if it appears to be in good condition. Damage from aging may not always be visible.

ENGINE OIL

Long engine life depends much on the selection of a quality oil and the periodic changing of the oil. Daily oil level checks and periodic changes are two of the most important maintenance items to be performed.

ENGINE OIL LEVEL CHECK

Follow the procedure below to inspect the engine oil level.

1. Start the engine and run it for a few minutes.
2. Stop the engine and wait three minutes.

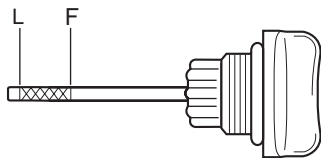

3. Check the engine oil level with the engine oil dipstick. The dipstick comes out together with the oil filler cap as shown. The level found in the dipstick should be between "L" (Low) and "F" (Full) lines.

The oil level inspection should be performed under the following conditions:

- Park the vehicle on level ground.
- The oil filler cap threads are not run in but touching the filler hole upper edge.

CAUTION

Operating the vehicle with an incorrect amount of oil can damage your ATV.

Too little or too much oil can damage your engine.

Place the ATV on level ground. Check the oil level with the engine oil dipstick before each use of the vehicle. Be sure the engine oil level is always above the "L" (low) line and not higher than the "F" (full) line.

ENGINE OIL AND FILTER CHANGE

Change the engine oil and oil filter at the scheduled times. The engine should always be warm when the oil is changed so the oil will drain easily. The procedure is as follows:

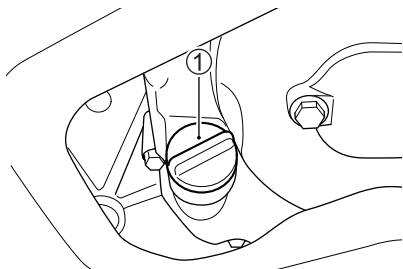

1. Park the vehicle on level ground.
2. Remove the oil filler cap ①.

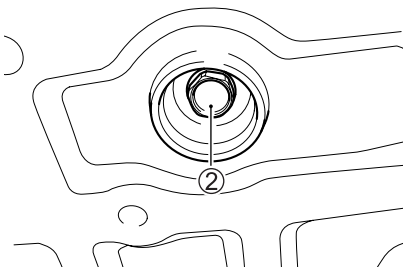

3. Remove the drain plug ② from the bottom of the engine and drain the oil into a drain pan.

WARNING

New and used oil can be hazardous.

Children and pets may be harmed by swallowing new or used oil. Continuous contact with used engine oil has been found to cause skin cancer in laboratory animals. Brief contact with used oil may irritate skin.

Keep new and used oil and used oil filters away from children and pets. To minimize your exposure to used oil, wear a long-sleeve shirt and moisture-proof gloves (such as dishwashing gloves) when changing oil. If oil contacts your skin, wash thoroughly with soap and water. Launder any clothing or rags if wet with oil. Recycle or properly dispose of used oil and filters.

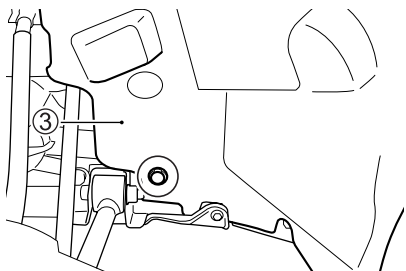
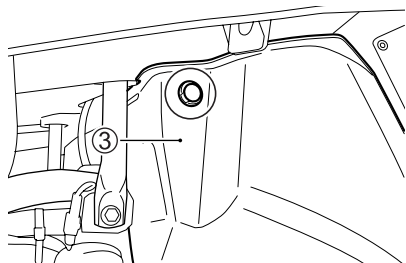
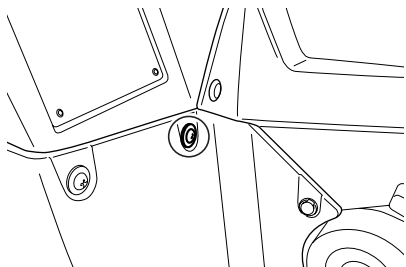

4. Remove the screw and fasteners. Remove the left inner cover ③.

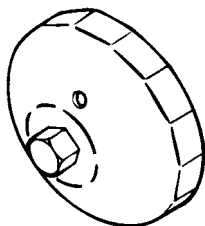

Available from Suzuki dealer
Oil filter wrench
(Part No. 09915-40610)

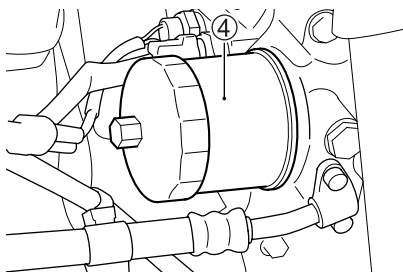

5. Turn the oil filter ④ counter-clockwise with a Suzuki "cap type" oil filter wrench or a "strap type" filter wrench of the proper size.

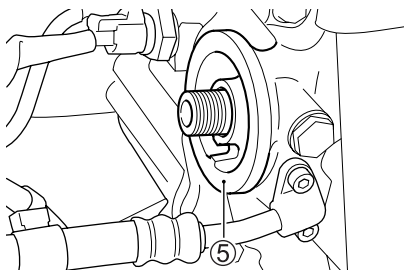

6. Wipe off the mounting surface ⑤ on the engine where the new filter will be seated with a clean rag.

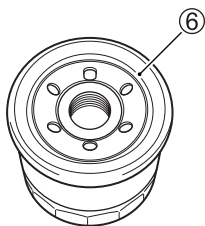

7. Smear a little engine oil around the rubber gasket ⑥ of the new oil filter.

CAUTION

Failure to use the correct oil filter can damage your ATV.

Engine damage may occur if you use oil filter with the wrong design or thread specifications.

Be sure to use a genuine SUZUKI oil filter or an equivalent filter designed for your ATV.

8. Screw the new filter by hand until the filter gasket contacts the mounting surface (a small resistance will be felt).

NOTE: To tighten the oil filter properly, it is important to accurately identify the position at which the filter gasket first contacts the mounting surface.

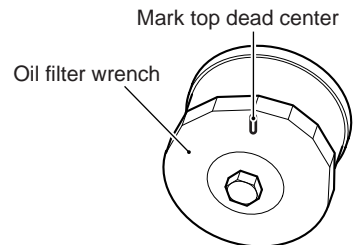

In the position at which the filter gasket first contacts the mounting surface.

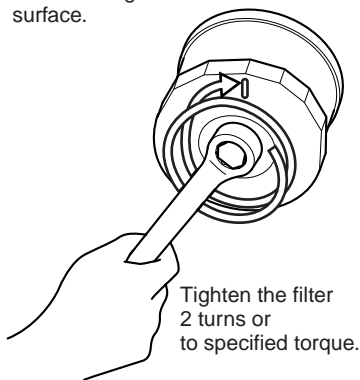

9. Mark the top dead center position on the “cap type” filter wrench or on the oil filter. Use an oil filter wrench to tighten the filter 2 turns or to specified torque.

Oil filter tightening torque:
20 N·m (2.0 kgf·m, 14.5 lb·ft)

10. Reinstall the drain plug and tighten it securely. Pour about 3.2 L (3.4 US qt) of the specified oil in the filler hole. (See FUEL AND OIL RECOMMENDATIONS section).

CAUTION

Failure to use the correct oil can damage your ATV.

Engine damage may occur if you use oil that does not meet Suzuki's specifications.

Be sure to use the oil specified in the FUEL AND OIL RECOMMENDATIONS section.

11. Start the engine (while the vehicle is outside on level ground) and allow it to idle for three minutes.
12. Turn the engine off and wait for three minutes. Recheck the oil level with the engine oil dipstick. The oil level should be at the “F” (full) mark. If it is lower than the “F” mark, add oil until it reaches the “F” mark. Inspect the area around the drain plug and oil filter for leaks.

AIR CLEANER

The air cleaner element must be kept clean to provide good engine power and gas mileage. If you use your vehicle under normal, low-stress conditions, you should service the air cleaner at the intervals specified. If you ride in dusty, wet, or muddy conditions, you will need to inspect the air cleaner element much more frequently. Use the following procedure to remove the element and inspect it.

WARNING

Operating the engine without the air cleaner element in place can be hazardous.

A flame can spit back from the carburetor to the air intake box without the air cleaner element to stop it. Severe engine damage can also occur if dirt enters the engine due to running the engine without the air cleaner element.

Never run the engine without the air cleaner element in place.

WARNING

Indicates a potential hazard that could result in injury or death.

CAUTION

Failure to inspect the air cleaner element frequently if the vehicle is used in dusty, wet, or muddy conditions can damage your ATV.

The air cleaner element can become clogged under these conditions, and engine damage may result.

Always check the air cleaner element after riding in severe conditions. Clean or replace the element as necessary. If water gets in the air cleaner case, immediately clean the element and the inside of the case.

Removing the Element

1. Remove the seat.

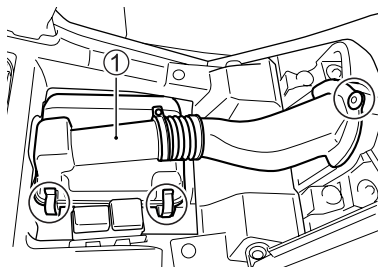

2. Remove the fastener. Unhook the hooks and take off the air cleaner case cover ①.

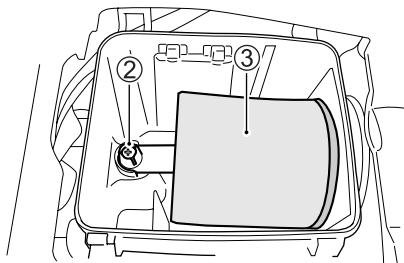

3. Remove the screw ②, then remove the element assembly ③.

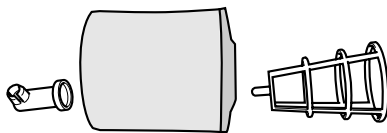

4. Pull out the foam element from the element frame.

Washing the Element

Wash the element as follows:

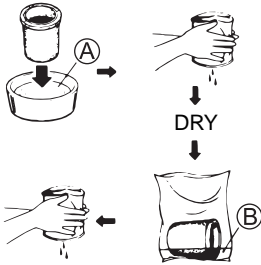

1. Fill a wash pan larger than the element with a non-flammable cleaning solvent (A). Dip the element in the solvent and wash it.
2. Squeeze the element by pressing it between the palms of both hands to remove excess solvent. Do not twist or wring the element, or it will develop cracks.
3. Dry the element.
4. Put the element in a plastic bag. Pour in some air filter oil (B) and work the oil into the element.
5. Squeeze the element to remove excess oil.

CAUTION

A torn air filter can damage your ATV.

Dirt and dust may get inside the engine if the element is torn.

Carefully examine the element for tears before and after cleaning it. Replace the element with a new one if it is torn.

6. Clean any dirt or debris from inside the air cleaner case. Be sure no dirt enters the carburetor.

CORRECT



INCORRECT



7. Reinstall the cleaned element in reverse order of removal. Be sure that the element is securely in position and is properly sealed.

⚠ WARNING

Oil and solvent can be hazardous.

Children and pets can be harmed from contact with oil and solvent.

Be sure to keep oil and solvent away from children and pets. Dispose of used oil and solvent properly.

CAUTION

Failure to position the air cleaner element properly can damage your ATV.

Air can bypass the air cleaner element if the element is not positioned properly. This will cause the engine parts to wear more rapidly.

Be sure to position the air cleaner element properly.

AIR CLEANER DRAIN TUBE

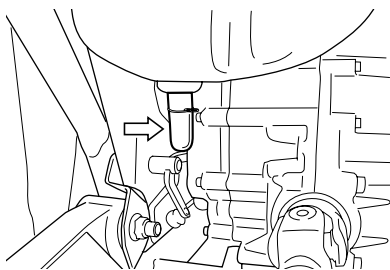

Periodically check the drain tube shown by the arrow to see if any gasoline or oil has accumulated. If you notice any gasoline or oil, remove the drain tube cap, drain the gasoline or oil into a suitable container, and replace the cap.

⚠ WARNING

Failure to properly dispose of the drained oil or gasoline can be hazardous.

Oil and gasoline are flammable and are harmful if swallowed.

Be sure to drain the fluid into a suitable container and immediately dispose of it properly.

GEAR OIL CHANGE

Inspect and change the gear oil according to the MAINTENANCE SCHEDULE. When changing the gear oil, use SAE90 hypoid gear oil which is rated GL-5 under the API classification system. If you operate the LT-F400F where the ambient temperature is normally below 0°C (32°F), use SAE 80 hypoid gear oil. The procedure for changing the front and rear gear oil is as follows:

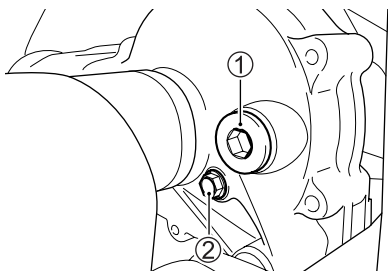

Front differential gear oil (LT-F400F)

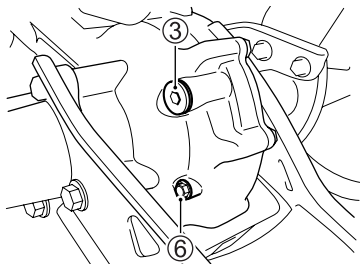

Final gear oil

1. Park the vehicle on level ground.
2. Remove the cover under the gear case.
3. Remove the oil filler cap ① for the front differential gear or the filler cap ③ for the final gear.

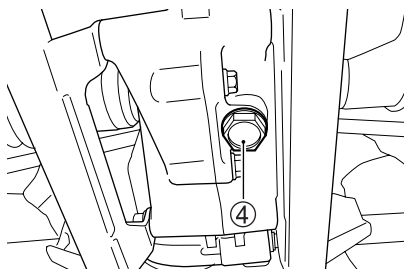

Front differential gear oil (LT-F400F)

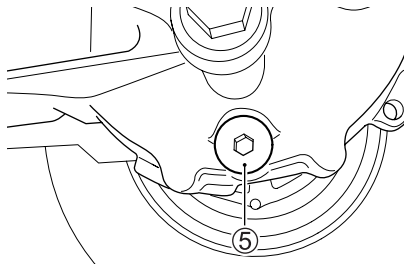

Final gear oil

4. Remove the drain plug ④ or ⑤ from the bottom of the gear case and drain the oil into a drain pan.
5. Reinstall the drain plug and tighten it securely after all the oil has been drained out. Remove the bolt ② or ⑥. Pour fresh oil through the filler hole until the oil flows out from the oil level hole ② or ⑥.
6. Tighten oil filler caps securely.

Front differential gear oil:
300 ml (10.1 US oz)

Final gear oil:
350 ml (11.8 US oz)

WARNING

New and used oil can be hazardous.

Children and pets may be harmed by swallowing new or used oil. Continuous contact with used gear oil has been found to cause skin cancer in laboratory animals. Brief contact with used oil may irritate skin.

Keep new and used oil away from children and pets. To minimize your exposure to used oil, wear a long-sleeve shirt and moisture-proof gloves (such as dishwashing gloves) when changing oil. If oil contacts your skin, wash thoroughly with soap and water. Launder any clothing or rags if wet with oil. Recycle or properly dispose of used oil.

TIRES

The LT-F400/F is equipped with low pressure tubeless tires of the size and type listed below:

	Front	Rear
Size	AT25 x 8-12☆☆☆	AT25 x 10-12☆☆☆
Type	MAXXIS M913S	MAXXIS M909S

WARNING

Operating this ATV with improper tires, or with improper or uneven tire pressure can be hazardous.

If you use improper tires or improper or uneven tire pressure, you may lose control of the ATV.

Always use the size and type tires specified. Always maintain proper tire pressure as described in this section.

Tire Tread Condition

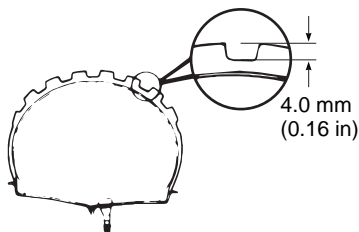

⚠ WARNING

The use of very worn tires can be hazardous.

The traction of the vehicle will be decreased with worn tires. This increases your risk of having an accident.

Replace the front and rear tires when the depth on the tread is 4.0 mm (0.16 in) or less.

Tire Pressure

A low pressure gauge is provided in the tool kit, so you can measure the air pressure in your LT-F400/F's tires. Check the air pressure in all tires before each use of the vehicle. Improper air pressure can affect handling, steering response, traction, tire life and rider comfort. Be sure that the tires are inflated to the pressures shown below. Tire pressure should only be measured or adjusted when the tires are cold, or misleading measurements can result.

LOAD	TIRE PRESSURE	
	FRONT	REAR
Up to 172 kg (380 lbs)	32.5 kPa 0.325 kgf/cm ² 4.7 psi	30 kPa 0.30 kgf/cm ² 4.4 psi

⚠ WARNING

Overfilling the tires can be hazardous.

If you put too much air into a tire, the tire may burst, causing severe injury.

Check the air pressure from time to time while inflating the tire gradually, until the specified pressure is obtained.

Tire Replacement

Your ATV has low-pressure tubeless tires. Air is sealed by the contact surfaces of the inner wheel rim and the tire bead. If either the inner wheel rim or tire bead is damaged, air may leak. Be extremely careful not to damage these sections when replacing tires.

It is very important to use the proper tools when repairing or replacing tires to prevent damage to the tire bead or wheel rims. Have this work done by your Suzuki dealer or a qualified tire repair station.

When breaking the tire bead loose from the wheel, be extremely careful not to damage the inner wheel surface or the tire bead.

WARNING

Using tires that have been installed incorrectly can be hazardous.

The ATV may have unusual handling if the tires are installed incorrectly.

The tires are intended to rotate in a specific direction, as indicated by the arrows on the sidewall of each tire. Install tires so they rotate in the proper direction.

Tubeless Tire Repair

Should a leak or flat tire occur due to a puncture, the tire may be repaired using a plug type patch. If the damage is from a cut, or if the puncture cannot be repaired using a plug, the tire should be replaced. When operating your LT-F400/F in areas where transportation or service facilities are not readily available, it is strongly recommended that you bring a plug type repair kit and a tire pump with you.

BRAKES

The ATV is equipped with front disk and rear drum brakes.

⚠ WARNING

Failure to properly inspect and maintain your ATV's brake systems can be hazardous.

Improper maintenance of the brakes increases your chances of having an accident.

Be sure to inspect the brakes before each use of the vehicle according to the **INSPECTION BEFORE RIDING** section. Always maintain your brakes according to the **MAINTENANCE SCHEDULE**.

⚠ WARNING

Operating the ATV in harsh conditions can be hazardous if you do not inspect brake wear often.

Operating in mud, water, sand or other extreme conditions can cause accelerated brake wear. This could lead to an accident.

If you operate your vehicle under these conditions, the brakes must be inspected more often than recommended in the **MAINTENANCE SCHEDULE**.

FRONT BRAKE

Brake Fluid

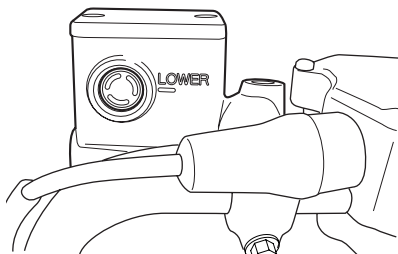

Be sure to check the brake fluid level in the front brake fluid reservoir. Inspect for brake pad wear and leaks.

▲ WARNING

Brake fluid is harmful or fatal if swallowed, and harmful if it comes in contact with skin or eyes.

If swallowed, do not induce vomiting. Immediately contact a poison control center or a physician. If brake fluid gets in eyes, flush eyes with water and seek medical attention. Wash thoroughly after handling. Solution can be poisonous to animals.

Keep out of the reach of children and animals.

▲ WARNING

Failure to use proper brake fluid can be hazardous.

The use of any fluid except DOT4 brake fluid from a sealed container can damage the brake system and lead to an accident.

Use only DOT4 brake fluid from a sealed container. Never use or mix with different types of brake fluid.

▲ WARNING

Failure to keep the brake fluid reservoir full can be hazardous.

The brakes may not work correctly without the proper amount of brake fluid. This could lead to an accident.

Inspect the brake fluid level before each use. If there is frequent loss of fluid, take your vehicle to a SUZUKI dealer for inspection.

CAUTION

Spilled brake fluid can damage your ATV.

Brake fluid can damage painted surfaces and plastic parts.

Be careful not to spill any fluid when filling the brake fluid reservoir. Wipe spilled fluid up immediately.

Front Brake Pads

Inspect the front brake pads as follows.

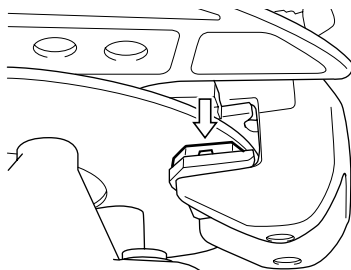

1. Inspect the brake pads to see if they are worn down to the grooved wear limit line.
2. If you find that the pads are worn to the grooved wear limit line, bring the vehicle to your authorized Suzuki dealer to have the brake pads replaced.

⚠ WARNING

Failure to maintain the brake pads and replace them when recommended can be hazardous.

Riding with unevenly worn brake pads will increase your chances of having an accident.

If you need to replace brake pads, have your Suzuki dealer do this work. Inspect and maintain the brake pads as recommended.

⚠ WARNING

Riding this ATV after brake system repair or brake pad replacement without pumping the brake lever can be hazardous.

If you do not pump the brake lever before starting, you can not get enough braking performance and may result in an accident.

Pump the brake lever several times until brake pads are pressed against the brake disks and proper lever stroke and firm feel are restored.

⚠ WARNING

Replacing only one of the two brake pads can be hazardous.

Replacing only one brake pad can result in uneven braking action.

Replace both pads together.

REAR BRAKE

Adjust the rear brake by adjusting the brake pedal first and then adjust the brake lever.

⚠ WARNING

Misadjusting the rear brake pedal and lever can be hazardous.

The rear brake lever and brake pedal operate the rear brake in a complementary manner. When one of these is misadjusted, the brake system as a whole will not operate properly. Misadjusting the rear brake lever and brake pedal can cause brake dragging or inadequate braking performance.

Adjust both the brake pedal and brake lever within the specified range.

Brake Pedal

Adjust the brake pedal as follows:

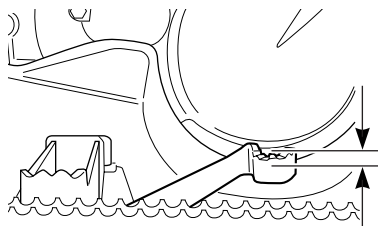

20 – 30 mm
(0.8 – 1.2 in)

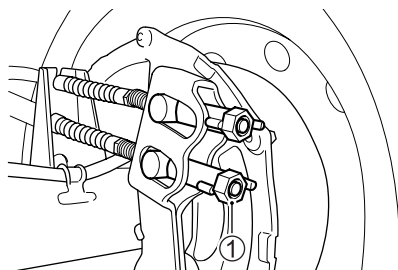

Turn the adjuster ① clockwise or counterclockwise so that there is 20 – 30 mm (0.8 – 1.2 in) of free travel.

Brake lever (Parking Brake)

The rear brake lever play as measured at the lever holder should be 3 – 5 mm (0.1 – 0.2 in) when the lever is lightly pulled in toward the grip. This adjustment is necessary for proper operation of the rear brake lever and the parking brake.

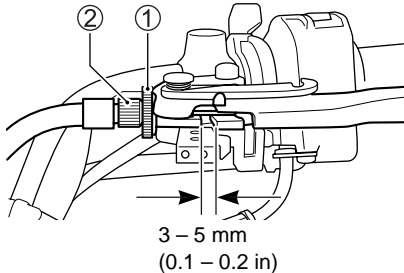

Check the play every time before riding and adjust it if necessary, as follows:

1. Loosen the lock nut ① and turn in the adjuster ② as far as it will go.

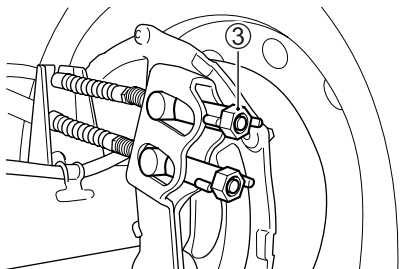

2. Turn the adjuster ③ clockwise or counterclockwise to obtain the specified play.
3. Minor adjustment can be made with the adjuster ②.
4. Tighten the lock nut ①.

5. After adjusting the play, check that the rear wheels roll freely with the brake disengaged, the transmission in neutral and the rear wheels off the ground.
6. Set the parking brake and check that the rear wheels are locked by trying to move the vehicle back and forth while it is in neutral.
7. Readjust the rear brake lever adjusting nut if the rear wheels could not roll freely in step 5. or if the rear wheels did not lock in step 6.

WARNING

Failure to adjust the parking brake can be hazardous.

If the brake grabs or fails to lock the wheels when engaged, you may have an accident.

After adjusting the parking brake, lift the rear wheels off the ground and make sure they spin freely with the brake released. Also make sure the rear wheels are locked when the parking brake is set.

REAR BRAKE LINING WEAR LIMIT

This vehicle has brake lining wear limit indicator on the rear brake. To check wear of the brake lining, perform the following.

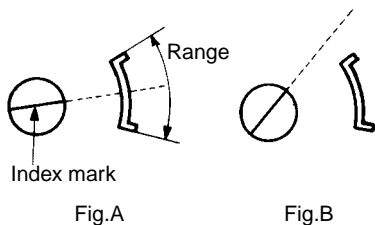
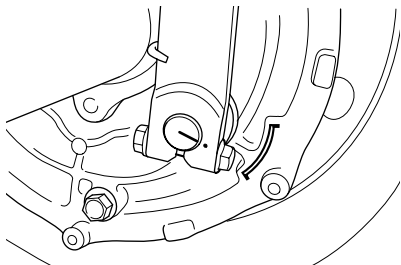

1. Check that the brake system is properly adjusted.
2. While fully applying the brake, check to see that the extension line of the index mark is within the range (Fig.A).
3. If the extension line is beyond the range (Fig.B), have the brake shoes replaced by your Suzuki dealer to insure safe operation.

WARNING

Failure to check brake lining wear and replace brake shoes as recommended can be hazardous.

Riding with worn brake shoes or brake shoes that are unevenly worn will increase your chances of having an accident.

Inspect brake lining wear and replace brake shoes as recommended. Always replace brake shoes in sets.

FRONT AND REAR WHEEL REMOVAL

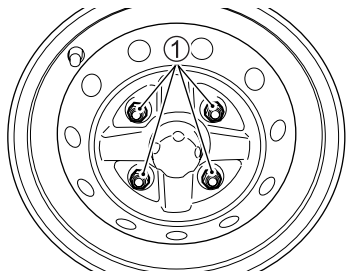

1. Park the vehicle on level ground and set the parking brake.
2. Loosen the wheel nuts ① on the wheel to be removed.
3. Lift up the front or rear end of the vehicle by placing a jack or block under the final gear case.
4. Remove the wheel nuts.
5. Remove the wheel. To reinstall the wheel, reverse these steps. Use the tightening torque chart to determine the tightness of the wheel nuts. Tighten the nuts in a cross-wise pattern.

Tightening Torque

FRONT	60 N·m 6.0 kgf·m 43 lb·ft
REAR	60 N·m 6.0 kgf·m 43 lb·ft

WARNING

Failure to tighten the wheel nuts to the specified torque can be hazardous.

If the wheel nuts are not properly tightened, the wheel can come off, causing an accident.

Be sure to tighten the wheel nuts to the specified torque. If you do not have a torque wrench or do not know how to use one, ask your authorized Suzuki dealer to check the nuts.

SPARK ARRESTER

The muffler has a spark arrester which must be periodically cleaned to maintain good efficiency. At the intervals shown in the maintenance chart, clean the spark arrester as follows.

WARNING

A hot muffler can harm you.

You can be burned if you touch the hot muffler.

Wait until the muffler cools to avoid burns.

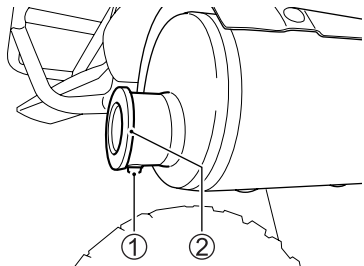

1. Remove the bolt ① and pull out the spark arrester ②.

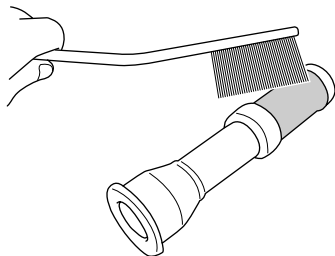

2. Use a brush to remove carbon deposits from the spark arrester screen. Be careful not to damage the spark arrester screen. Check that the screen has no holes or tears. Replace the screen if necessary.
3. Reinstall the spark arrester in reverse order of removal.

DRIVE SHAFT BOOTS (LT-F400F)

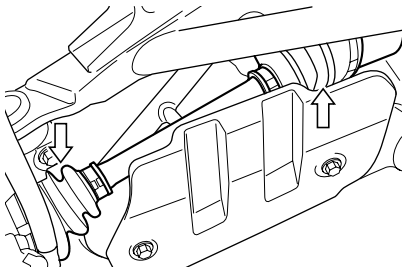

Check the drive shaft rubber boots for damage and grease leak. Ask your Suzuki dealer if replacement is necessary.

LIGHT BULB REPLACEMENT

The wattage rating of each bulb is shown in the following chart. When replacing a burned-out bulb, always use the same wattage rating.

Headlight	12V 35/35W (HS1) × 2
Brake light/ Taillight	12V 21/5W

CAUTION

Failure to use a light bulb with the correct wattage rating can damage your ATV.

The electrical system can overload, or the bulb may burn out sooner.

Use only the light bulbs shown in the chart as replacement bulbs.

HEADLIGHT

To replace the headlight bulb, use the following procedure:

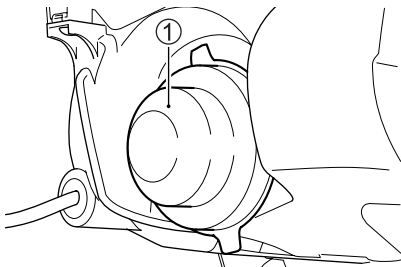

1. Remove the rubber cap ①.

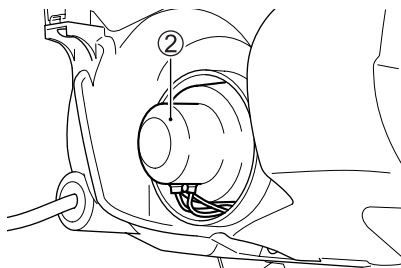

2. Remove the socket cover ②.

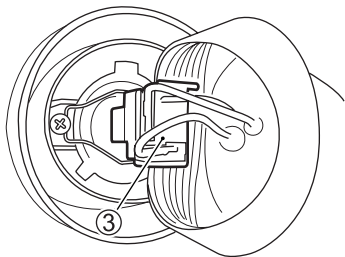

3. Disconnect the socket ③.

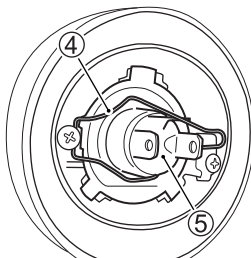

4. Unhook the bulb holder spring ④ and pull out the bulb ⑤.
5. To replace the headlight bulb, reverse the above sequence.

CAUTION

Touching the headlight bulb glass with a bare hand may damage the bulb.

The bulb's life may be shortened by oil from your fingers if you touch it.

When replacing the headlight bulb, be careful not to touch the glass. Grasp the new bulb with a clean cloth.

BRAKE/TAILLIGHT

Replace the brake/taillight bulb as follow:

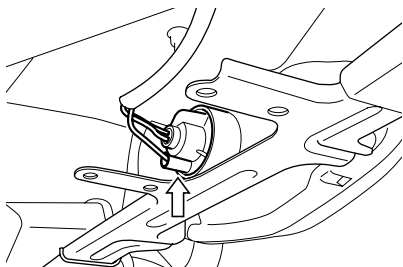

1. Turn the socket counterclockwise and pull it off.

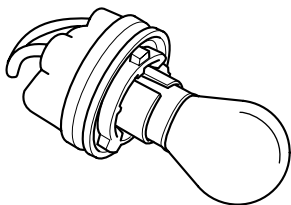

2. Push the bulb in and turn it to the left. Remove the bulb.
3. To install a new bulb, push the bulb in firmly and turn it to the right while pushing in.

FUSE

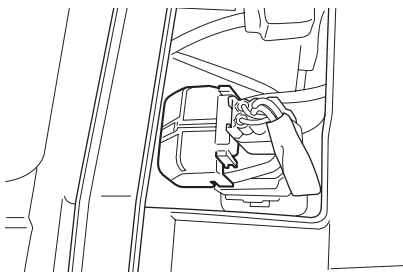

The main fuse is located under the seat. One 30A spare fuse is located inside the fuse box cover.

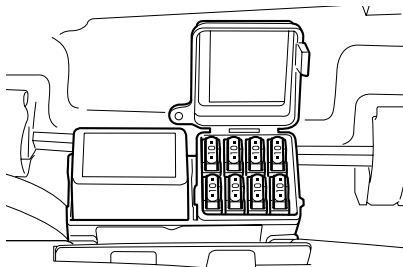

The fuses are located under the seat. 10A spare fuses are provided inside the fuse box.

The fuses are designed to open when a circuit overload exists in individual electrical system circuits. If any electrical system fails to operate, then the fuses must be checked.

FUSE LIST

- 30A MAIN fuse protects the all electrical circuits.
- 10A HEAD-HI fuse protects the headlight high beam and high beam indicator light.
- 10A HEAD-LO fuse protects the headlight low beam.
- 10A TAIL fuse protects the tail-light and speedometer light.
- 10A IGNITION fuse protects the indicator light, brake light and CDI unit.
- 10A FAN fuse protects the cooling fan motor.
- 10A P-SOURCE fuse protects the electrical accessories.

CAUTION

Failure to install the correct fuse can damage your ATV.

Installing a fuse of incorrect rating or using aluminum foil or wire instead of a fuse may seriously damage the electrical system.

Always replace a blown fuse with a fuse of the same type and rating. If the new fuse blows in a short time, consult your Suzuki dealer immediately.

OUTPUT TERMINAL

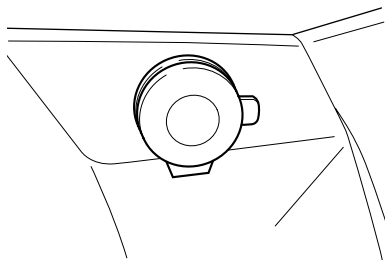

LT-F400/F has an output terminal for attaching 12V electrical accessories. Total electrical accessory wattage should be less than 120W. Check electrical accessory voltage and wattage before attaching accessories to the output terminal.

CAUTION

Using improper electrical accessories can damage your ATV.

Exceeding 120W or using other than 12V accessory can seriously damage the electrical system and accessory.

Check voltage and wattage before connecting electrical accessories.

GENERAL LUBRICATION

Proper lubrication is important for safe, smooth operation and long life of your vehicle. Be sure that all lubrication is performed during periodic maintenance on the vehicle. Shorten intervals when you use your ATV in severe conditions. Your authorized Suzuki dealer should do general lubrication as shown in the MAINTENANCE CHART. He/she will lubricate things such as wheel bearings, rear axle housings, swing arm bearings, steering shaft holder, odometer cable, choke cable, etc.

CAUTION

Lubricating switches can damage your ATV.

Lubricating switches can damage the switches.

Do not apply grease and oil to the switches.

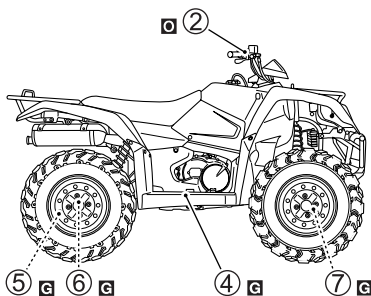
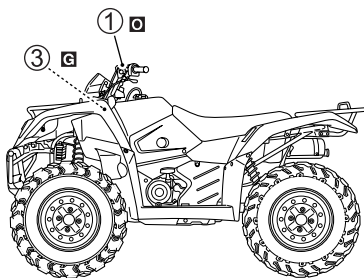

□ Motor oil

▣ Grease

- ① Brake lever holder
- ② Throttle lever
- ③ Steering shaft holder
- ④ Brake pedal
- ⑤ Brake cam
- ⑥ Rear axle spline
- ⑦ Drive shaft spline (LT-F400F)

▲ WARNING

Indicates a potential hazard that could result in injury or death.

TRAILER TOWING

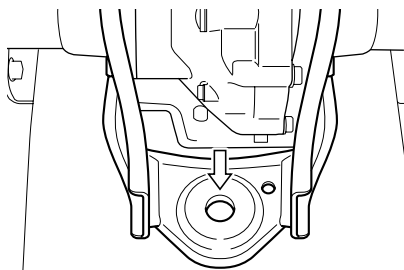

You may use your LT-F400/F to tow a light trailer but always observe the requirements and recommendation in this section.

CAUTION

Towing a trailer during the break-in period can damage your ATV.

Trailer towing adds stress to the engine, drive train, and brakes.

Never tow a trailer during the first 10 hours that you ride your ATV.

TRAILER TOWING EQUIPMENT

Use a trailer and trailer towing equipment that are compatible. Use only a No.1 trailer hitch ball (48 mm (1-7/8 in) in diameter). Never use a trailer hitch bracket that provides a trailer coupler location lower than the center of the rear wheels. We strongly advise you to use a genuine Suzuki trailer or an equivalent ATV trailer.

VEHICLE/TRAILER LOADING

To load your vehicle and trailer properly, you must know how to measure Gross Trailer Weight and Trailer Tongue Weight.

Gross Trailer Weight is the weight of the trailer plus cargo in it. You can measure Gross Trailer Weight by putting each wheel of the fully loaded trailer on a bathroom scale. Add the weights shown on the scales.

Tongue Weight is the downward force exerted on the hitch by the trailer coupler when the trailer is fully loaded and the coupler is at its normal towing height. This weight can be measured using a bathroom scale.

The weight of your loaded trailer (Gross Trailer Weight) should never exceed 180 kg (400 lbs) when towing on uneven surfaces. When towing at low speed along a straight level path, you may tow up to the vehicle towing limit of 450 kg (992 lbs). Spread the cargo in your trailer so that the Tongue Weight is about 10% of the Gross Trailer Weight. You can do this by placing about 60% of the total cargo weight in the front half of the trailer. Make sure the cargo weight is even between the right and left sides of the trailer.

WARNING

Overloading your trailer can be hazardous.

An overloaded trailer can affect the handling of the ATV.

Never overload your trailer.

WARNING

Improper distribution of cargo in your trailer can be hazardous.

Improper cargo distribution can affect the handling of the ATV.

Always make sure that Trailer Tongue Weight is about 10% of Gross Trailer Weight.

WARNING

Allowing cargo to shift in a trailer while moving can be hazardous.

Cargo weight shifting while moving can affect your ability to handle the ATV safely.

Make sure that the load in your trailer is properly secured and will not shift while moving.

WARNING

Riding your ATV without extra caution when towing a trailer can be hazardous.

Trailer towing can affect the handling and braking of your ATV.

Tow only at low speeds and never exceed second gear. Avoid sudden acceleration and stopping of the ATV. Do not make quick maneuvers. Avoid uneven surfaces and do not tow on hills unless they are very small. Never carry passengers in the trailer. Allow more stopping distance than when you are not towing a trailer.



TROUBLESHOOTING

FUEL SYSTEM CHECK	6-2
IGNITION SYSTEM CHECK	6-3

TROUBLESHOOTING

This troubleshooting guide is provided to help you find the cause of some common complaints.

CAUTION

Failure to troubleshoot a problem correctly can damage your ATV.

Improper repairs or adjustments may damage the vehicle instead of fixing it. Such damage may not be covered under warranty.

If you are not sure about the proper action, consult your Suzuki dealer about the problem.

COMPLAINT:

Engine is hard to start or does not start at all.

Something is probably wrong with the fuel system or ignition system.

FUEL SYSTEM CHECK

1. Make sure there is adequate fuel in the fuel tank.
2. Make sure there is enough fuel reaching the carburetor from the fuel tank.
 - a. Turn the fuel valve lever to the "ON" position.

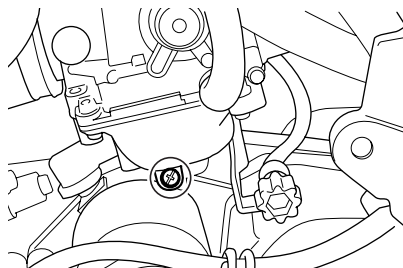

- b. Loosen the drain screw which is located under the carburetor. Drain the fuel from the carburetor into a container.

⚠ WARNING

Draining fuel from the carburetor can be hazardous.

Fuel can catch on fire if you do not handle it properly.

When draining the carburetor, always shut the engine off. Do not smoke, and never drain or refuel in an area where there are open flames or sparks. Do not spill the fuel or you may create a fire hazard. Dispose of drained fuel properly.

- c. Tighten the drain screw.
- d. Push the electric starter button for a few seconds to turn the engine.
- e. Loosen the drain screw and check that the carburetor is filled back up with fuel.
- f. If fuel is reaching the carburetor, the ignition system should be checked next.

IGNITION SYSTEM CHECK

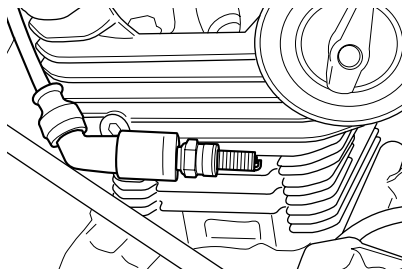

1. Remove the spark plug and reattach it to the spark plug lead.
2. Put the engine stop switch in the "O" position and ignition switch in the "ON" position. While holding the spark plug base firmly against the engine, pull the recoil starter rope or push the electric starter button. If the ignition system is operating properly, a blue spark should jump across the spark plug gap. If there is no spark, take your machine to your authorized Suzuki dealer.

WARNING

Performing the spark test improperly can be hazardous.

You could get a high voltage electrical shock if you are not familiar with this procedure.

Do not perform this check if you are not familiar with the procedure. Do not point the spark plug near the spark plug hole during this test. Do not do this test if you have a heart condition or wear a pacemaker.

COMPLAINT: Engine stalls

1. Make sure there is enough fuel in the fuel tank.
2. Check to see that the spark plug is not fouled. Remove the plug and clean it. Replace it, if necessary.
3. Make sure the fuel valve is not clogged. Also check to be sure the air vent hose connected to the fuel tank is not clogged.
4. Check the engine idle speed. If necessary, adjust it using a tachometer. The correct idle speed is 1400 – 1600 r/min.



PREPARATION FOR WINTER RIDING

ENGINE OIL CHANGE7-2

PREPARATION FOR WINTER RIDING

Use of some engine oils in cold weather may make the engine hard to start. It may also cause clutch drag and stiff transmission operation. Select the right oil for cold weather according to the chart in the FUEL AND OIL RECOMMENDATIONS section.

ENGINE OIL CHANGE

Dirt and dust in the oil will affect engine performance, especially when the weather is cold. Change the engine oil before using your ATV in cold weather (below freezing) even if the oil that is in the engine is the right type for colder temperatures.



TRANSPORTING

TRANSPORTING 8-2

TRANSPORTING

TRANSPORTING

It is best to transport the LT-F400/F in the normal position. It may also be transported on its back wheels, but this is not as stable as the normal position.

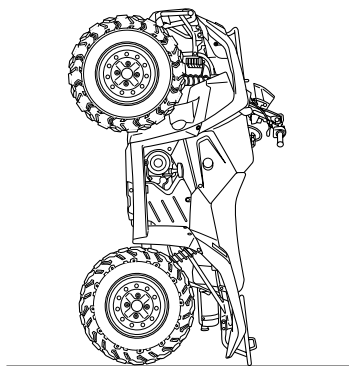
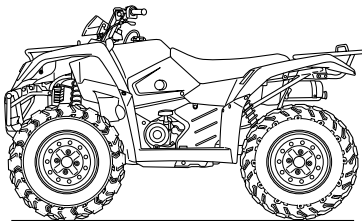

CAUTION

Failure to properly secure the ATV when transporting it can be hazardous.

Failure to properly secure the vehicle may result in an accident or damage to the vehicle.

When transporting the LT-F400/F, lock the parking brake lever and tie down the vehicle securely with straps, rope, or some other suitable means. Use extra tie downs when you transport the vehicle in the standing position.

Before transporting the LT-F400/F, drain the fuel from the carburetor as follows:

1. Turn the fuel valve to the "ON" position.
2. Drain fuel from the carburetor into an empty container by loosening the carburetor drain screw.
3. When the fuel has drained, retighten the drain screw.

⚠ WARNING

Draining fuel from the carburetor can be hazardous.

Fuel can catch on fire if you do not handle it properly.

When draining the carburetor, always shut the engine off. Do not smoke, and never drain or refuel in an area where there are open flames or sparks. Do not spill the fuel or you may create a fire hazard. Dispose of drained fuel properly.





CLEANING PROCEDURE AND STORAGE PROCEDURE

PREPARATION FOR CLEANING	9-2
WASHING YOUR ATV	9-3
INSPECTION AFTER CLEANING	9-4
STORAGE PROCEDURE	9-4
MAINTENANCE DURING STORAGE	9-5
PROCEDURE FOR RETURNING TO SERVICE	9-5

CLEANING PROCEDURE AND STORAGE PROCEDURE

A thorough cleaning of your ATV is a necessary part of maintenance and will help keep your ATV looking and performing its best. Proper cleaning can also extend the life of your ATV.

It is important to clean and inspect your ATV after every ride if it is used in mud, brush, grass, water, salt water, or very dusty conditions.

The build-up of mud, brush, grass, etc, especially on the engine and exhaust system, can reduce engine cooling, conceal damage, or increase wear of certain parts. It is important to remove all debris during cleaning.

PREPARATION FOR CLEANING

Wash the ATV before any mud dries on the ATV.

Block or seal the end of the exhaust pipe (muffler) using a piece of plastic wrap, cloth rag or another method to prevent water from entering the engine.

CAUTION

High pressure washers can damage your ATV.

High pressure washers such as those found at coin-operated car washes have enough pressure to damage the parts of your ATV. It may cause rust, corrosion and increase wear.

Do not use high pressure washers to clean your ATV.

WASHING YOUR ATV

With some care, your ATV can be washed in a similar manner to washing an automobile.

NOTE: Avoid spraying or allowing water to flow over the following places:

- *Ignition switch*
- *Spark plug*
- *Fuel tank cap*
- *Carburetor*
- *Brake master cylinder*
- *Snorkel air intake for air filter and carburetor (The snorkel air intake opening is located at the highest point on the ATV, usually in front of the seat.)*
- *Oil cooler fins*

Use a garden hose at low pressure to remove the majority of dirt or other debris. Hand wash your ATV with mild soap or detergent and water. Try to thoroughly remove all dirt and debris without excessive water pressure, even at remote areas such as linkages or mounting brackets. Cloth rags, washing mitts or cleaning brushes can be used. Be careful with brushes as they may scratch plastic or painted surfaces. Rinse the ATV thoroughly with clean water. Dry all areas using a chamois or soft absorbent cloth.

CAUTION

Improper cleaning can damage the oil cooler.

Oil cooler fins can be damaged by spraying high pressure water on them.

Do not spray high pressure water on the oil cooler fins.

CAUTION

Cleaning the ATV improperly can damage ATV parts.

Cleaning with any alkaline or strong acid cleaner gasoline, brake fluid, or any other solvent will damage the ATV parts.

Clean only with soft cloth and warm water with mild detergent.

INSPECTION AFTER CLEANING

Remove the rags or wrapping from the exhaust pipe. Check the drain tubes on the bottom of the air filter box and drain any water that has collected in them. For extended life of your ATV, lubricate it according to the "GENERAL LUBRICATION" section.

WARNING

Operating the ATV with wet brakes can be hazardous.

Wet brakes may not provide as much stopping power as dry brakes. This could lead to an accident.

Test your brakes after washing the ATV, while riding at slow speed. If necessary, apply brakes several times to let friction dry out the linings.

Follow the procedures in the "INSPECTION BEFORE RIDING" section to check your ATV for any problems that may have arisen during your last ride.

STORAGE PROCEDURE

If you don't plan on using your LT-F400/F for a long time, it will need special servicing requiring appropriate materials, equipment and skill. For this reason, Suzuki recommends that you trust this maintenance work to your dealer. If you wish to service the machine for storage yourself, follow the general guidelines below:

VEHICLE

Place the vehicle on level ground and wash the entire vehicle.

FUEL

Drain the fuel from the fuel tank using a hand pump or siphon. Drain the fuel from the carburetor using the carburetor drain screw.

WARNING

Draining the fuel tank can be hazardous.

Fuel can catch on fire if you do not handle it properly.

When draining the fuel tank, always shut the engine off. Do not smoke, and never drain fuel in an area where there are open flames or sparks. Keep pets and children away from fuel, and dispose of drained fuel properly.

ENGINE

Remove the spark plug and pour one tablespoon of motor oil into the spark plug hole. Reinstall the spark plug and crank the engine a few times to spread the oil in the cylinder.

BATTERY

- Remove the battery from the vehicle.
- Clean the outside of the battery with mild soap and remove corrosion from the terminals and wiring harness.
- Store the battery in a room above freezing.

TIRES

Inflate tires to the normal pressure.

EXTERNAL

- Spray all vinyl and rubber parts with rubber protectant.
- Spray unpainted surfaces with rust preventative.
- Coat painted surfaces with car wax.

MAINTENANCE DURING STORAGE

Once a month, recharge the battery. The standard charging rate is 1.4A x 5 to 10hr.

PROCEDURE FOR RETURNING TO SERVICE

- Clean the entire vehicle.
- Drain all the engine oil. Install a new oil filter and fill the engine with fresh oil as outlined in this manual.
- Remove the spark plug. Turn the engine a few times by pulling the recoil starter. Reinstall the spark plug.
- Reinstall the battery.
- Make sure that the vehicle is properly lubricated.
- Perform the INSPECTION BEFORE RIDING as listed in this manual.
- Start the vehicle as outlined in this manual.



CONSUMER INFORMATION

EMISSION CONTROL WARRANTY	10-2
SERIAL NUMBER LOCATION	10-2
LOCATION OF LABELS	10-3

CONSUMER INFORMATION

EMISSION CONTROL WARRANTY

WARRANTIES

The warranties for your ATV are explained in a separate warranty policy booklet given to you at the time of sale. Please read this booklet carefully so you can understand your rights and responsibilities.

The following warranties are provided with your ATV:

- New ATV Limited Warranty
- ATV Federal Emission Control System Limited Warranty

SERIAL NUMBER LOCATION

You need to know the frame and engine serial numbers to get title documents for your ATV. You also need these numbers to help your dealer when you order parts.

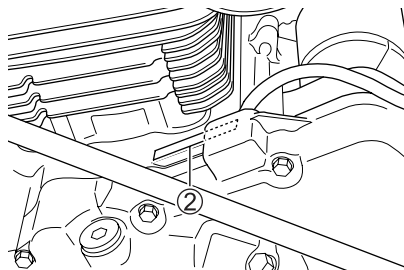
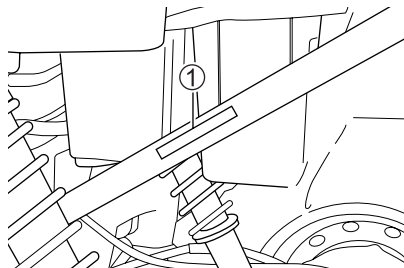

The frame number ① is stamped on the left side of the frame. The engine serial number ② is stamped on the left side of the crankcase assembly.

Write down the serial numbers here for your future reference.

Frame No.:

Engine No.:

LOCATION OF LABELS

Read and follow all of the warnings labeled on your ATV. Make sure you understand all of the labels. Keep the labels on the ATV. Do not remove them for any reason. If a label comes off or becomes difficult to read, you can get a replacement by contacting your Suzuki dealer.

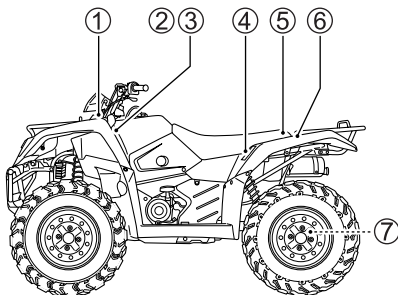

①

WARNING

NEVER carry a passenger on cargo rack or on ATV.
NEVER tow from cargo rack.
MAXIMUM CARGO CAPACITY: 66lbs(30kg)

②

WARNING

Failure to stop vehicle completely before doing the following could result in your being thrown from the ATV.

To engage reverse:

- Stop vehicle completely.
- Shift transmission to neutral.
- Bring engine to idle. Apply brake.
- Shift range lever fully toward rear.

To engage Hi-Lo range:

- Stop vehicle completely.
- Bring engine to idle.
- Operate range lever while applying brake.

Hi-range: Normal riding.

Lo-range: Severe load conditions.

Read owner's manual for additional information.

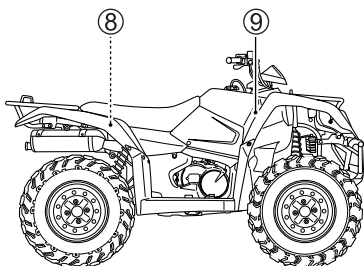
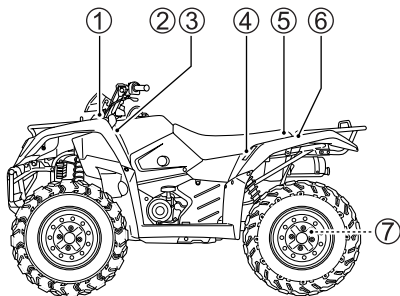

③

⚠ WARNING



Operating this ATV if you are under the age of 16 increases your chance of severe injury or death.

NEVER operate this ATV if you are under age 16.

⚠ WARNING

Improper ATV use can result in SEVERE INJURY or DEATH



ALWAYS USE AN APPROVED HELMET AND PROTECTIVE GEAR



NEVER USE ON PUBLIC ROADS



NEVER CARRY PASSENGERS



NEVER USE WITH DRUGS OR ALCOHOL

NEVER operate:

- without proper training or instruction
- at speeds too fast for your skills or the conditions
- on public roads - a collision can occur with another vehicle
- with a passenger - passengers affect balance and steering and increase risk of losing control

ALWAYS:

- use proper riding techniques to avoid vehicle overturns on hills and rough terrain and in turns
- avoid paved surfaces - pavement may seriously affect handling and control

LOCATE AND READ OWNER'S MANUAL. FOLLOW ALL INSTRUCTIONS AND WARNINGS.

④

⚠ WARNING

Improper tire pressure or overloading can cause loss of control.

Loss of control can result in severe injury or death.

ALWAYS maintain proper tire pressure as shown below.

- Cold tire pressure :
 - Front : **4.7 psi (32.5 kPa)**
 - Rear : **4.4 psi (30 kPa)**

NEVER exceed the maximum weight capacity of **380 lbs (172 kg)**.

Tire Size :	Front	AT25×8-12	☆☆
	Rear	AT25×10-12	☆☆

⑤

⚠ WARNING

NEVER ride as a passenger.



Passengers can cause a loss of control, resulting in **SEVERE INJURY** or **DEATH**.

⑥

⚠ WARNING

NEVER carry a passenger on cargo rack or on ATV.

NEVER tow from cargo rack.

MAXIMUM CARGO CAPACITY: 132lbs(60kg)

⑦

⚠ WARNING

Exceeding vehicle towing limit could lead to an accident. Reduce speed when towing a trailer. Read owner's manual for details.

Trailer Tongue Weight should be about 10 % of the Gross Trailer Weight, and should not exceed 45 kg (99 lbs).

MAXIMUM TOWING CAPACITY: 450 kg (992 lbs)

⑧

The owner's manual contains important safety information and instructions which should be read carefully before operating the vehicle.

If the vehicle has been resold, obtain the owner's manual from the previous owner or contact your local SUZUKI dealer for assistance.

⑨

CAUTION

Accessory must not exceed 120W rating and must be 12V type. Exceeding 120W or using other than 12V accessory can damage ATV electrical system and accessory.

SPECIFICATIONS

DIMENSIONS AND CURB MASS

Overall length	2060 mm (81.1 in)
Overall width.....	1145 mm (45.1 in)
Overall height	1220 mm (48.0 in)
Wheelbase	1270 mm (50.0 in)
Ground clearance.....	250 mm (9.8 in)
Front track	880 mm (34.6 in)
Rear track	900 mm (35.4 in)
Seat height	840 mm (33.1 in)
Curb mass	263 kg (579 lbs) ... LT-F400
	279 kg (615 lbs) ... LT-F400F

ENGINE

Type	Four-stroke, air-cooled with SACS, OHC
Number of cylinders	1
Bore	82.0 mm (3.228 in)
Stroke	71.2 mm (2.803 in)
Displacement.....	376 cm ³ (22.9 cu. in)
Compression ratio	9.0 : 1
Carburetor	KEIHIN CVK32, single
Air cleaner	Polyurethane foam element
Starter system.....	Electric and recoil starter
Lubrication system	Wet sump

DRIVE TRAIN

Clutch	Wet multi-plate, automatic, centrifugal type	
Transmission	5-speed forward constant mesh	
Transfer.....	2-speed forward with reverse	
Gearshift pattern	All up, foot lever operated	
Primary reduction ratio	2.392 (67/28)	
Secondary reduction	1.133 (17/15)	
Final reduction ratio (Front and Rear)	3.600 (36/10)	
Transfer reduction ratios, Low	2.435 (35/13 x 19/21)	
	High	1.296 (35/27)
Transmission gear ratios, Low	3.083 (37/12)	
	2nd	1.933 (29/15)
	3rd	1.388 (25/18)
	4th	1.095 (23/21)
	Top.....	0.913 (21/23)
	Reverse	2.833 (34/12)
Drive system.....	Shaft drive	

CHASSIS

Front suspension	Independent, double wishbone, coil spring, oil damped
Rear suspension	Swingarm type, coil spring, oil damped
Front wheel travel	170 mm (6.7 in)
Rear wheel travel.....	170 mm (6.7 in)
Caster.....	3°
Trail.....	14 mm (0.55 in)
Toe-in.....	10 mm (0.39 in)
Camber.....	0.3°
Steering angle.....	47° (right and left)
Turning radius.....	3.1 m (10.2 ft)
Front brake	Disk brake, twin
Rear brake.....	Drum brake
Front tire size.....	AT25 x 8-12☆☆, Tubeless
Rear tire size	AT25 x 10-12☆☆, Tubeless

ELECTRICAL

Ignition type.....	Electronic ignition (CDI)
Spark plug.....	NGK CR7E or DENSO U22ESR-N
Battery.....	12V 43.2 kC (12Ah)/10HR
Fuse	30/10/10/10/10/10/10A
Generator	Three-phase A.C. generator
Headlight	12V 35/35W (HS1) x 2
Brake/Taillight.....	12V 21/5W
Speedometer light	12V 1.7W
Oil temperature indicator light	12V 3.4W
Neutral indicator light.....	12V 3.4W
Reverse indicator light.....	12V 3.4W

CAPACITIES

Fuel tank, including reserve.....	16.0 L (4.2 US gal)
Reserve	2.9 L (0.8 US gal)
Engine oil, change.....	3000 ml (3.2 US qt)
With filter change.....	3200 ml (3.4 US qt)
Differential gear oil	300 ml (10.1 US oz)
Final gear oil.....	350 ml (11.8 US oz)

INDEX

- A**
AIR CLEANER 5-16
AIR CLEANER DRAIN
TUBE..... 5-19
ATV WINCH LEAD
WIRES..... 4-4
- B**
BATTERY 5-5
BOX..... 2-19
BRAKES..... 5-24
BRAKING 3-15
BREAK-IN 3-7
- C**
CHOKE CABLE
ADJUSTMENT 5-10
- D**
DRIVE SHAFT BOOTS
(LT-F400F) 5-33
- E**
EMISSION CONTROL
WARRANTY 10-2
ENGINE OIL..... 1-3,5-11
ENGINE OIL CHANGE 7-2
- F**
FLAG BRACKET 2-18
FRONT AND REAR WHEEL
REMOVAL 5-31
FRONT BRAKE 5-25
FRONT DIFFERENTIAL
GEAR OIL (LT-F400F) AND
FINAL GEAR OIL 1-4
FUEL 1-2
FUEL HOSE 5-10
FUEL SYSTEM CHECK 6-2
FUEL TANK CAP 2-16
FUEL VALVE 2-15
FUSE 5-35
- G**
GEAR OIL CHANGE 5-20
GEARSHIFT LEVER 2-10
GENERAL
LUBRICATION 5-37
- I**
IDLE SPEED
ADJUSTMENT 5-9
IGNITION SWITCH 2-6
IGNITION SYSTEM
CHECK 6-3
INSPECTION AFTER
CLEANING 9-4
INSPECTION BEFORE
RIDING 3-4

K	
KEY	2-5
L	
LEFT HANDLEBAR.....	2-10
LIGHT BULB	
REPLACEMENT	5-33
LOCATION OF LABELS	10-3
LOCATION OF PARTS	2-2
M	
MAINTENANCE DURING	
STORAGE.....	9-5
MAINTENANCE	
SCHEDULE.....	5-2
N	
NOTICE.....	5-3
O	
OPERATION ON HILLS.....	3-18
OUTPUT TERMINAL	5-36
P	
PREPARATION FOR	
CLEANING.....	9-2
PROCEDURE FOR RETURNING	
TO SERVICE.....	9-5
R	
RANGE LEVER	2-8
REAR BRAKE	5-28
REAR BRAKE LINING	
WEAR LIMIT.....	5-30
REAR BRAKE PEDAL.....	2-14
RECOIL STARTER	2-16
RIDING IN COLD	
WEATHER.....	3-25
RIDING IN REVERSE	3-29
RIDING OVER	
OBSTACLES.....	3-23
RIDING THROUGH	
WATER.....	3-24
RIGHT HANDLEBAR	2-13
S	
SEAT LOCK	2-18
SELECTION LEVER	
(LT-F400F)	2-9
SERIAL NUMBER	
LOCATION	10-2
SKIDDING OR SLIDING	3-17
SPARK ARRESTER.....	5-32
SPARK PLUG.....	5-7
SPEEDOMETER AND	
INDICATOR LIGHTS.....	2-7
STARTING OFF AND	
SHIFTING.....	3-10
STARTING THE	
ENGINE.....	3-8
STORAGE	
PROCEDURE.....	9-4

T

THROTTLE CABLE	
ADJUSTMENT	5-9
THROTTLE LIMITER	2-14
TIRES.....	5-21
TOOL.....	5-5
TRAILER TOWING	5-38
TRANSPORTING.....	8-2
TURNING	3-16

W

WASHING YOUR ATV.....	9-3
WHAT TO WEAR.....	3-6
WHAT YOU SHOULD KNOW BEFORE RIDING	3-2



WARNING

Indicates a potential hazard that could result in injury or death.







G

GENERAL USE MODEL

**This ATV is for
RECREATIONAL or
UTILITY USE,
NO OPERATOR UNDER AGE 16.**

OPERATOR ONLY-NO PASSENGERS

This category G (GENERAL USE) ATV is for off road use only, for recreation and utility purposes.

Training courses to teach ATV riding are available. For information contact your dealer.

Check with your dealer to find out about state or local laws regarding ATV operation.

This hang tag is not to be removed before sale.

WARNING

Improper ATV use can result in SEVERE INJURY or DEATH



ALWAYS USE
AN APPROVED
HELMET AND
PROTECTIVE
GEAR



NEVER USE
ON PUBLIC
ROADS



NEVER CARRY
PASSENGERS



NEVER USE
WITH DRUGS
OR ALCOHOL

NEVER operate :

- without proper training or instruction
- at speeds too fast for your skills or the conditions
- on public roads - a collision can occur with another vehicle
- with a passenger - passengers affect balance and steering and increase risk of losing control

ALWAYS :

- use proper riding techniques to avoid vehicle overturns on hills and rough terrain and in turns
- avoid paved surfaces - pavement may seriously affect handling and control

LOCATE AND READ OWNER'S MANUAL.
FOLLOW ALL INSTRUCTIONS AND WARNINGS.



K9

SUZUKI MOTOR CORPORATION

300 TAKATSUKA, MINAMI, HAMAMATSU, JAPAN

Printed in USA

www.quad-forum.sk