

LEFT & RIGHT SIDE VIEWS



INDEX

1. SPECIFICATIONS	4
2. PERFORMANCE CURVES	6
3. GENERAL INSTRUCTIONS	7
Breaking-in	7
Fuel and Oil	7
Genuine Parts	7
4. SPECIAL TOOLS	8
5. NECESSARY MATERIALS	10
Thread Lock Cement	10
Grease	10
6. TROUBLESHOOTING	11
If Engine Is Hard to Start	11
If Abnormal Noises Are Heard in Engine	12
If Engine Over Heats	12
Defective Clutch	13
Gear Shifting Troubles	13
Poor Stability and Steering	14
7. TUNE-UP	15
Oil Pump	15
Spark Plug	15
Transmission Oil	16
Clutch	16
Carburetor Throttle Cable Play	17
Ignition Timing	17
Battery	18
Air Cleaner	19
Muffler	19
8. ENGINE	20
Removal from Frame	20
Disassembly and Assembly	23
Necessary Points on Assembly	30
Engine Lubrication System	34
Carburetor	36
Kick Starter System	38
Transmission System	39
Clutch System	40
Air Cleaner	41
9. ELECTRICAL	42
Ignition System	42
Charging System	42
Battery	43
10. BODY	44
Front Forks	44
Front and Rear Wheel	46
Rear Shock Absorber	48
11. SPECIFICATIONS FOR INSPECTION OR REPAIR	49
Engine	49
Electrical	50
Body	51
12. TIGHTENING TORQUE	52

1. SPECIFICATIONS

DIMENSIONS

Overall Length	1,625 mm (63.9 in)
Overall Width	775 mm (30.5 in)
Overall Height	985 mm (38.8 in)
Wheelbase	1,095 mm (43.1 in)
Ground Clearance	125 mm (4.9 in)
Tire, Front	5.4 - 10, 4PR
Rear	5.4 - 10, 4PR
Dry Weight	75 kg (165 lbs)

PERFORMANCE

Maximum Speed	56 - 64 kph (35 - 40 mph)
---------------	---------------------------

ENGINE

Type	2-stroke, air cooled gasoline engine
Cylinder	Single, inclined forward
Bore x Stroke	41.0 x 37.8 mm (1.61 x 1.49 in)
Piston Displacement	49 cc (3.0 cu-in)
Compression Ratio (corrected)	6.3
Maximum Horse Power	4 hp/6,000 rpm
Maximum Torque	0.5 kg-m (3.62 ft-lb)/5,000 rpm
Starter	Kick (primary)

FUEL SYSTEM

Carburetor	VM 14SC
Air Cleaner	Wet polyurethane filter
Fuel Tank Capacity	3.5 ltr (0.92/0.77 US/Imp gal)

LUBRICATION SYSTEM

Engine	Suzuki CCI Lubrication system
Gear-Box	500 cc (1.06/0.88 US/Imp pt)
Engine Oil Tank Capacity	0.7 ltr (1.5/1.2 US/Imp pt)

IGNITION SYSTEM

Type	Flywheel magneto
Ignition Timing	20° (1.50 mm) B.T.D.C.
Spark Plug	NGK BP-6HS or Nippon Denso W20FP

TRANSMISSION SYSTEM

Clutch Type	Multi-plate, wet disc
Number of Speeds	4 Speed, constant mesh
Gear Shifting	Left foot operated, return change
Gear Ratios (Overall Reduction Ratio)	
1st	3.666 = 44/12 (32.87)
2nd	2.200 = 33/15 (19.72)
3rd	1.578 = 30/19 (14.15)
4th	1.240 = 31/25 (11.11)
Primary Reduction Ratio	3.842 = 73/19
Final Reduction Ratio	2.333 = 35/15

SUSPENSION

Front Suspension	Telescopic forks, with coil spring
Rear Suspension	Swinging arm, with hydraulic damper and coil springs

STEERING

Steering Angle	43° (right and left)
Caster Angle	63°
Trail	60 mm (2.4 in)
Turning Radius	1.7 m (5.6 ft)

BRAKES

Front Brake	Right hand, internal expanding
Rear Brake	Right foot, internal expanding

ELECTRICAL EQUIPMENT

Generator	Flywheel magneto
Battery	6V 4AH
Fuse	15A
Head Lamp	6V 15/15W
Tail/Brake Lamp	6V 3/10W (3/21 CP)
Neutral Indicator Lamp	6V 3W
Speedometer Lamp	6V 3W
Turn Signal Lamp	6V 8W x 4
High Beam Indicator Lamp	6V 1.7W
Turn Signal Indicator Lamp	6V 1.7W

* The specifications subject to change without notice.

2. PERFORMANCE CURVES

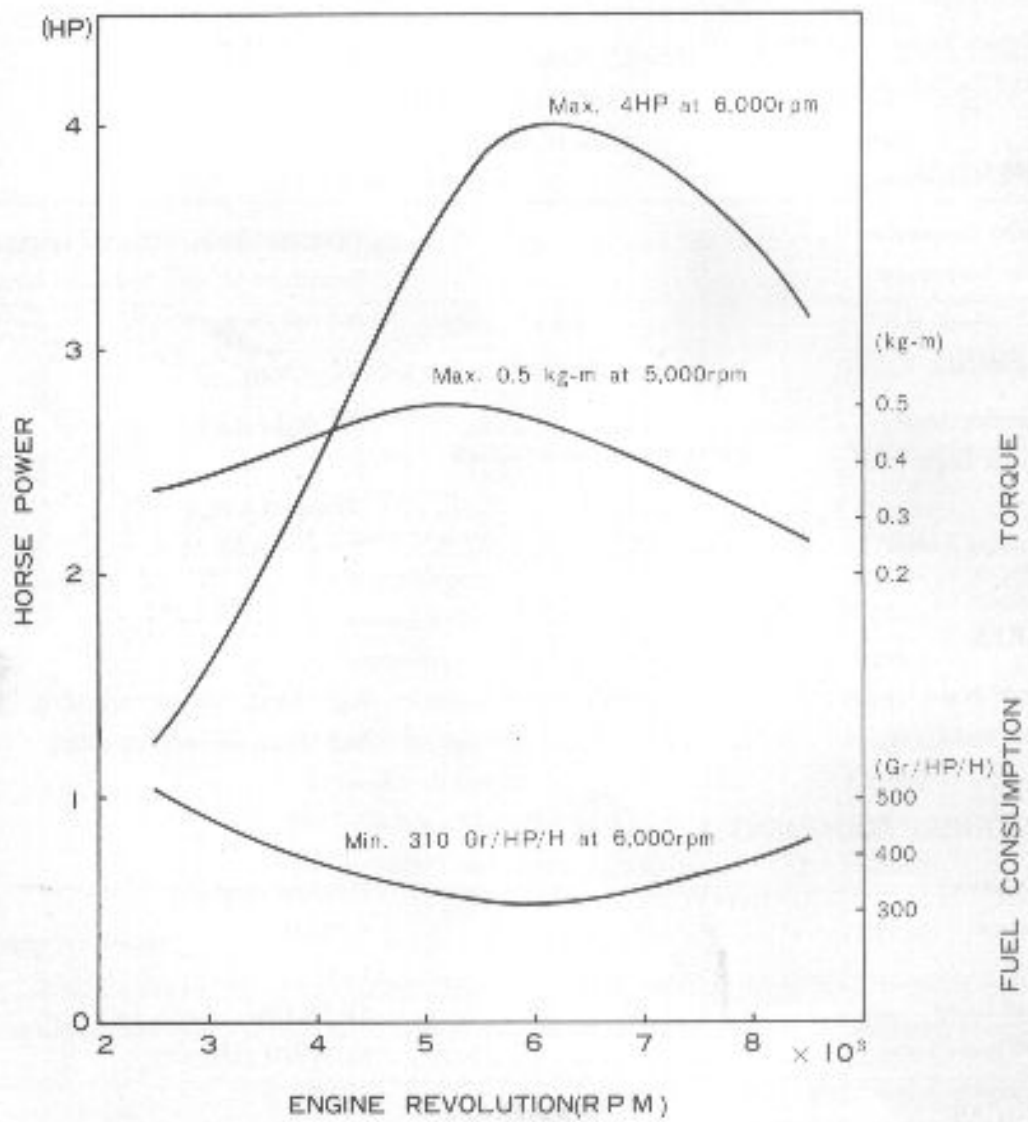

3. GENERAL INSTRUCTIONS

To keep the motorcycle in peak condition, please advise your customers to follow these tips which will give top performance at all times.

Breaking-in

The life of the motorcycle depends on the breaking-in of the engine and the way in which the motorcycle is treated. Therefore, breaking-in carefully is important to prevent excessive wear of the parts, noise and to prolong engine life. During the breaking-in period, do not operate the motorcycle at high speed nor allow the engine to run with the throttle wide open. Keep to the specified breaking-in speed limits. Gradually raise the speed as the covered mileage increases.

First 500 miles (800 km)	30 mile/h (45 km/h)
up to 1,000 miles (1,600 km)	35 mile/h (55 km/h)

Fuel and oil

The engine's moving parts such as crankshaft, crankshaft bearings, con-rod, piston and cylinder wall are positively lubricated by fresh oil which is separately pressure-delivered from the variable displacement oil pump. This unique force oiling system is called the "SUZUKI CCI". Put gasoline-only in the fuel tank and lubrication oil in the oil tank. Recommended fuel and oil are as follows.

FUEL GASOLINE OF 85 - 95 OCTANE
OIL SUZUKI CCI OIL

- * If Suzuki CCI oil is not available, non-diluent (non-self mixing type) two stroke oil, SAE # may be used.

TRANSMISSION OIL SUZUKI TRANSMISSION OIL

- * If Suzuki Transmission Oil is not available, a good quality SAE 20W/40 multi-grade motor oil should be used.



Genuine parts

When replacing parts, always use genuine Suzuki parts, which are precision-made under severe quality controls. If imitation parts (not genuine parts) are used, good performance cannot be expected from the motorcycle and in the worst case, they can cause a breakdown. The Suzuki warranty will also be voided.

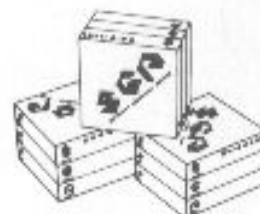

4. SPECIAL TOOLS

Special tools listed below are used to disassemble, assemble and for maintenance and service. These special tools make certain jobs easier which can not be done with ordinary tools and prevent the parts from damage. It is recommended that these special tools are purchased as shop equipment.

Ref. No.	Tool No.	Tool Name	Use for
1	09910 - 20113	Piston holder	Locking crank shaft
2	09910 - 80113	Crankcase separating tool	Separating crankcase
3	09913 - 50110	Oil seal remover	Removal of oil seals
4	09913 - 70122	Bearing & oil seal installing tool	Installation of bearings & oil seals
5	09913 - 80110	Bearing & oil seal installing tool	Installation of bearings & oil seals
6	09920 - 70111	Soap ring opener	Removal or Installation of snap rings
7	09930 - 10111	Spark plug wrench	Removal or Installation of spark plug
8	09930 - 20111	Point wrench with 0.35 mm gauge	Adjustment of contact point
9	09930 - 30113	Rotor remover	Removal of flywheel
10	09930 - 40113	Engine sprocket & flywheel holder	Locking engine sprocket or flywheel
11	09931 - 00111	Dial gauge	Checking ignition timing
12	09940 - 10122	Steering stem lock nut wrench	Tightening or loosening steering stem nut or front fork lower tube
13	09900 - 09002	Impact screw driver	Loosening cross-head screw
14	09900 - 25001	Pocket tester	Checking electrical equipments
15	09900 - 27002	Timing tester	Adjustment of ignition timing
16	09910 - 10110	6 mm Stud installing tool	Installing 6 mm stud bolt
17	09900 - 28401	Hydrometer	Checking battery capacity
18	09900 - 28103	Electro tster	Checking electric system

Piston holder

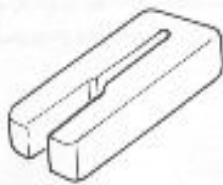

①

Crankcase separating tool

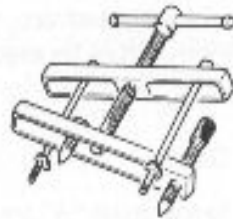

②

Oil seal remover

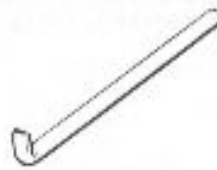

③

Bearing and oil seal installing tool



④

Bearing and oil seal installing tool



⑤

Snap ring opener (small)

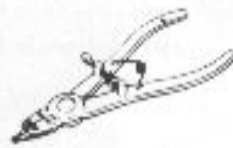

⑥

Spark plug wrench

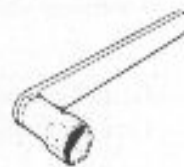

⑦

Point wrench with 0.35mm gauge



⑧

Rotor remover



⑨

Engine sprocket & flywheel holder

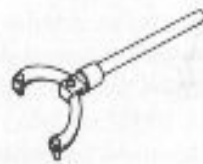

⑩

Dial gauge

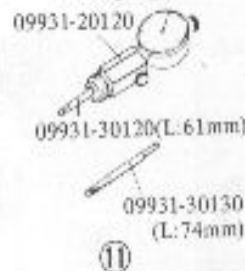

⑪

Steering stem lock nut wrench



⑫

Impact driver set

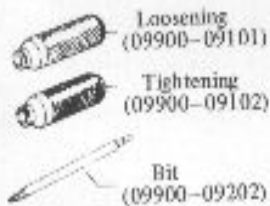

⑬

Pocket tester



⑭

Timing tester



⑮

6mm stud installing tool

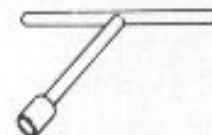

⑯

Hydrometer



⑰

Electro tester



⑱

5. NECESSARY MATERIALS

RV50 requires the following material in addition to the general service equipment, tools, lubricants, cleaning solvent, every cloth and so forth. For further details, refer to the pertinent items in this manual.

Thread Lock Cement

This cement is applied to the front fork upper bracket bolts and outer tube nuts.



Optional part No. 99000 - 32040

Grease

Special grease "A" type should be used for lubrication of the crankshaft and other oil seals.



Suzuki special grease "A" part No. 99000 - 25010

6. TROUBLESHOOTING

When trouble occurs with a motorcycle, it is important to find the source of the trouble as rapidly as possible. It is also necessary to perform only the work required to repair the machine without bothering with parts which are functioning correctly. The list of possible troubles and their causes given below should help the service man to repair motorcycles quickly without loss of effort.

If Engine Is Hard to Start

Check fuel level. When a sufficient fuel is in the tank, check the following points.

Order and Description	Check Points	Remedy
1. Check to see that there is a spark at the spark plug. (Turn engine with kick starter).	* If there is a good spark in the spark plug, check the following points. 1. Ignition timing 2. Incorrect heat range of plug 3. Carburetion 4. Engine compression loss	Adjust Replace Adjust Repair as necessary
	* If the spark is weak 1. Damage in spark plug 2. Incorrect spark plug gap 3. Damage in spark plug cap 4. Dirty contact points 5. Bad insulation in condenser 6. Damage in ignition coil or primary coil	Replace Adjust Replace Clean and adjust Replace Replace
	* If there is no spark 1. Damage in spark plug 2. Dirty or wet spark plug 3. Incorrect spark plug gap 4. Dirty or incorrect contact point gap 5. Bad insulation in condenser 6. Damage in ignition coil or primary coil 7. Damage in ignition switch 8. Damage in wiring harness	Replace Clean or replace Adjust Clean and adjust Replace Replace Replace Repair or replace
2. Check to see that fuel flows into carburetor.	* If fuel does not reach the carburetor 1. Fuel strainer clogged 2. Fuel pipe clogged or damaged 3. Tank cap air vent clogged 4. Fuel cock clogged	Remove and clean Clean or replace Clean with wire Clean

<p>3. Check to see that engine compression is correct (Turn engine with kick starter).</p>	<p>* If engine compression is low</p> <ol style="list-style-type: none"> 1. Cylinder and piston rings worn 2. Piston rings stick on piston 3. Cylinder head gasket damaged 4. Cylinder base gasket damaged 5. Piston damaged 6. Spark plug improperly tightened 7. Spark plug gasket faded 8. Cylinder head improperly tightened 9. Gas leakage from crankcase 10. Cylinder or cylinder head damaged 11. Oil seals damaged 	<p>Repair or replace</p> <p>Repair or replace</p> <p>Replace</p> <p>Replace</p> <p>Replace</p> <p>Tighten securely</p> <p>Replace</p> <p>Retighten securely</p> <p>Repair or replace</p> <p>Replace</p> <p>Replace</p>
--	---	--

If Abnormal Noises Are Heard in Engine

	Check Points	Remedy
	<ol style="list-style-type: none"> 1. Too big a clearance between piston and cylinder 2. Too big a clearance between piston rings and grooves 3. Piston rings stiff with carbon 4. Con-rod big end worn 5. Con-rod small end bearing worn 6. Piston rings damaged 7. Ignition timing too advanced 8. Defective primary pinion and gear 9. Crankshaft bearings worn 10. Defective transmission gear 11. Defective transmission bearings 	<p>Repair or replace</p> <p>Replace piston</p> <p>Clean</p> <p>Replace</p> <p>Replace</p> <p>Replace</p> <p>Adjust</p> <p>Replace</p> <p>Replace</p> <p>Replace</p> <p>Replace</p>

If Engine Overheats

If engine overheats during high speed running after it is broken in, check to see whether the oiling system is in good condition, the brake is dragging, or cylinder cooling fins are dirty. Inspect the following points.

Description	Check Points	Remedy
<p>1. Check to see if oiling system functions properly,</p>	<ol style="list-style-type: none"> 1. Improperly adjusted oil pump control lever 2. Air in oil lines 3. Oil tank breather pipe choked 4. Incorrect oil used 	<p>Adjust</p> <p>Remove air</p> <p>Rectify</p> <p>Use recommended oil</p>

2. Check to see if engine compression is higher than standard	† Too high compression 1. Carbon deposits in combustion chamber 2. Too thin a cylinder head gasket	Remove carbon deposit Replace
3. Check carbon deposit	† Check carbon deposit in muffler, exhaust pipe, exhaust port and combustion chamber	Disassemble and remove carbon deposit
4. Check to see that piston rings move smoothly in grooves	* Piston rings stiff by carbon deposit	Remove carbon deposit
5. Check to see that the clutch works properly	Clutch slippage	Adjust
6. Check to see that the ignition timing is correct		Adjust
7. Drive chain too tight		Adjust
8. Incorrect spark plug heat range		Replace with colder or hotter plug
9. Too lean fuel mixture		Adjust carburetor

Defective Clutch

Description	Check Points	Remedy
1. Clutch slippage	1. Improperly adjusted clutch 2. Clutch springs worn 3. Clutch plates worn	Adjust Replace Replace
2. If clutch drags	1. Improper weight oil 2. Uneven clutch spring tension	Replace Replace

Gear Shifting Troubles

Description	Check Points	Remedy
1. Gear engagement	† If gears do not engage, 1. Gear shifting cam groove damaged 2. Gear shifting forks not moved smoothly on cam 3. Gear shifting fork damaged 4. Gears seized	Replace shifting cam Rectify with emery paper Replace Replace
2. Gear shifting lever	† If gear shifting lever does not return to normal position.	

	<ol style="list-style-type: none"> 1. Gear shifting shaft return spring damaged 2. Friction between gear shifting shaft and crankcase 	<p>Replace</p> <p>Repair bent shaft or replace</p>
3. Jumping out of gear	<p>* If the gears disengage while running</p> <ol style="list-style-type: none"> 1. Gear shifting fork worn or bent 2. Gear dog teeth worn 3. Gear shifting cam worn or damaged 	<p>Replace</p> <p>Replace gear</p> <p>Repair bent shaft or replace</p>

Poor Stability and Steering

Description	Check Points	Remedy
1. Handlebar is stiff	<ol style="list-style-type: none"> 1. Steering stem lock nut tight 2. Steering stem bent 3. Steel balls damaged 	<p>Adjust</p> <p>Repair or replace</p> <p>Replace</p>
2. Handlebar is not stable	<ol style="list-style-type: none"> 1. Incorrect wheel alignment 2. Play in front wheel fitting 3. Steel balls damaged 4. Fork stem bent 5. Bearing races worn or damaged 6. Front fork bent 7. Swinging arm bent 8. Fork spring worn 	<p>Replace</p> <p>Repair</p> <p>Replace</p> <p>Repair or replace</p> <p>Replace</p> <p>Repair or replace</p> <p>Repair</p> <p>Replace</p>
3. Wheel is not true	<ol style="list-style-type: none"> 1. Up-and-down play in hub bearings 2. Wheel rim deformed 3. Loose spokes 4. Chain too tight 5. Loose swinging arm fitting 6. Frame warped 7. Incorrect tire pressure 	<p>Replace</p> <p>Repair or replace</p> <p>Repair</p> <p>Adjust</p> <p>Tighten</p> <p>Replace</p> <p>Correct</p>

7. TUNE-UP

In order to maintain the full performance originally built in the motorcycle, a periodic motorcycle tune-up is essential.

If any deficiency is encountered during operation of the motorcycle, it must be diagnosed immediately, and rectified.

Oil Pump

By turning the throttle grip, align the dent mark on the throttle valve with the upper part of the carburetor main bore. Holding the throttle grip in that position, adjust the oil pump cable with the adjuster so that the aligning marks align.

To adjust:

- 1) Loosen the adjuster lock nut.
- 2) Turn the cable adjuster in or out until proper adjustment is obtained.
- 3) Be sure to secure the adjuster with the lock nut.

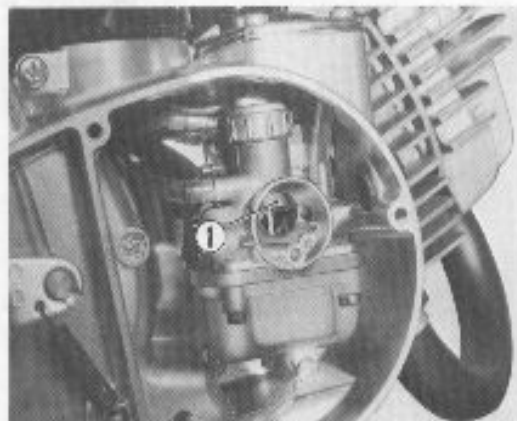

① Dent mark

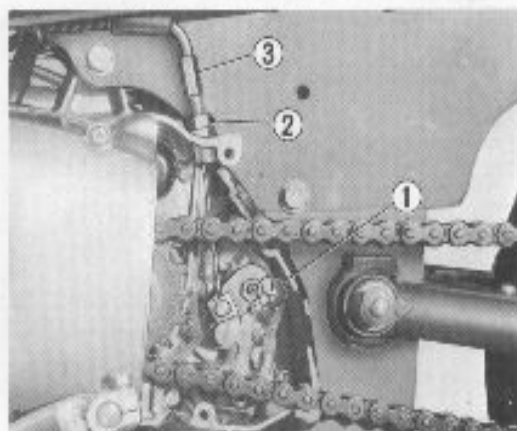

① Aligning marks ② Adjuster lock nut
③ Cable adjuster

Spark Plug

Spark plug gap: Measure the gap using a thickness gauge.

The standard spark plug gap is as follows:

Standard spark plug gap	0,6 ~ 0,7 mm (0,024 ~ 0,028 in)
-------------------------	----------------------------------

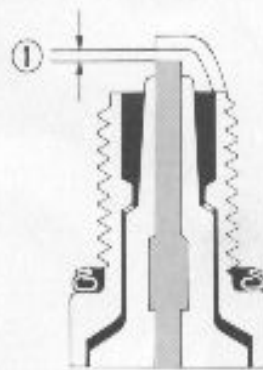

① Spark plug gap

Heat range : The NGK BP6HS or Nippon Denso W20FP spark plug is standard for this motorcycle. However, the spark plug may be affected by changes in temperature, altitude, carburetion or ignition timing. If for some reason the standard spark plug shows signs of overheating try a colder spark plug; according to the table below.

Conversely if the plug is wet or dirty with carbon a hotter plug may be used.

	NGK	Nippon Denso	Remarks
Hotter type	BP4H	W14FP	Apt to get wet
Standard	BP6HS	W20FP	
Colder type	BP7HS	W24FP	Apt to overheat

Caution : When installing the spark plug, screw it in with your fingers, to prevent stripping the threads, then tighten with a torque wrench to 2.5 ~ 3.0 kg-m (18.0 ~ 21.6 ft-lb).

Transmission Oil

Oil in the transmission deteriorates and its lubrication performance decreases if it is used too long. It should therefore be changed periodically.

To change:

- 1) Remove the oil filler cap and oil drain plug located on the bottom of the engine and drain the transmission case.

Note: If possible, do this while the engine is warm and the oil viscosity is low.

- 2) Reinstall the drain plug

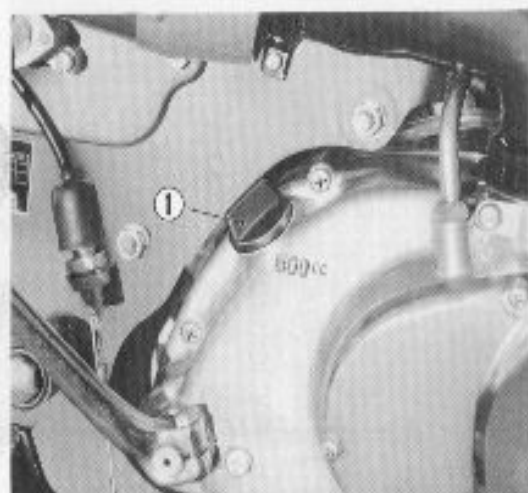

1 Oil filler cap



1 Drain plug

- 3) Measure 500 cc (1.06/0.88 US/Imp pt) of the recommended oil (See page 7.) in a measuring beaker and pour it into the transmission chamber slowly.

16

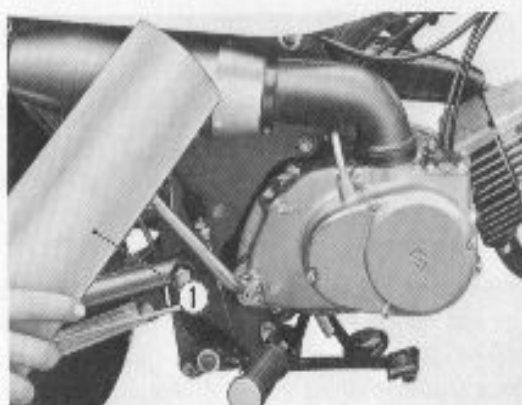

1 Measuring beaker

- 4) Refit the oil filler cap.

Clutch

Clutch adjustment is made in two stages, i.e., adjustment of play in the clutch cable and the clutch release mechanism.



1 Clutch cable adjuster

- 2) Loosen the release screw locking nut temporarily with a 10 mm open end wrench and turn in the release adjusting screw until it stops slightly and then back it out $\frac{1}{4}$ turn.



1 Release adjusting screw 2 Release screw locking nut

- 3) Secure the release screw locking nut,

- 4) Finally adjust the clutch cable adjuster again until 3 ~ 5 mm (0.4 ~ 0.7 in.) of play is left at the bottom of the clutch lever.

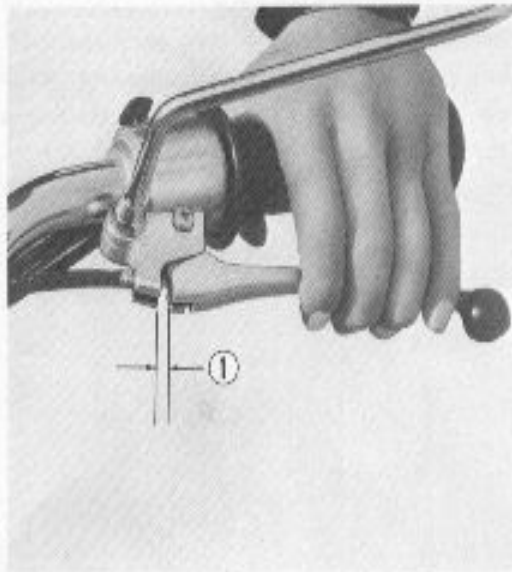

① Clutch lever play

Carburetor Throttle Cable Play

This section describes the adjustment of throttle cable play.

If there is no play, the engine speed will not stay constant when the handlebar is turned. If there is excessive play, the throttle valve can not be opened all the way, causing poor engine performance.

To adjust the throttle cable play:

- 1) Remove the carburetor top cover and tug on the throttle cable to check the amount of play.
- 2) If it is found to be out of adjustment, loosen the lock nut and screw the adjuster in or out until 0.5 mm adjustment is obtained.
- 3) Secure the adjuster again with the lock nut and reinstall the carburetor top cover.

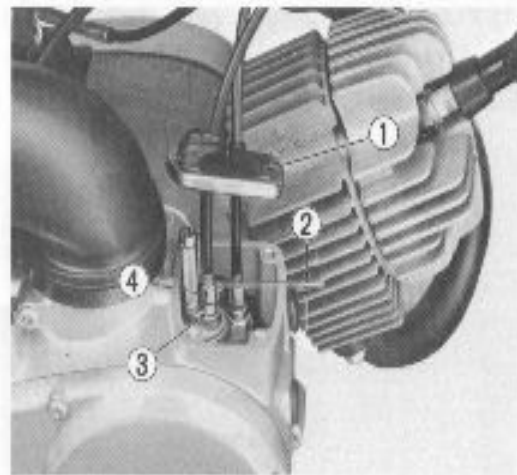

① Carburetor top cover ② Throttle cable play
③ Lock nut ④ Throttle cable adjuster

Ignition Timing

Incorrect ignition timing decreases engine performance and shortens the life of the engine.

Before checking or adjusting the ignition timing, be sure that the contact point gap is set to 0.35 mm (0.014 in.).

To adjust the contact point gap:

- 1) Remove the magneto inspection cap.
- 2) Turn the flywheel rotor by hand and find the position where the contact point gap is largest.
- 3) Adjust the gap to 0.35 mm (0.014 in.) by loosening the contact point fixing screw and then moving the stationary contact point with a screw driver.
- 4) Retighten the screw securely.

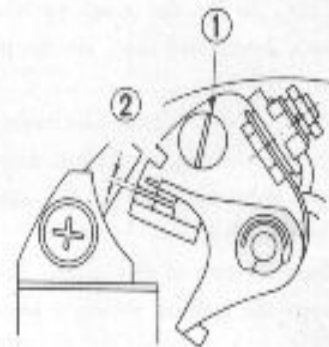

① Contact point fixing screw ② Contact point gap

To adjust the ignition timing:

- 1) Remove the spark plug from the cylinder head and screw in the dial gauge, special tool #09931 - 00111.



① Dial gauge

- 2) Connect one of the lead wires of timing tester, special tool 09900 - 27002, to the black wire which is free near the fuse box and other one to the ground as shown in the figure.



① Black wire ② Ground ③ Timing tester

- 3) Find T.D.C. on the dial gauge by turning the crankshaft slowly and then, set the needle to "0" position.
- 4) Turn the crankshaft slowly clockwise, i.e., reverse direction of engine rotation, and stop the crankshaft being turned where the sound of the timing tester fades.
- 5) Read the indication of dial gauge. This indication shows the ignition timing in piston travel from T.D.C.

Standard ignition timing:	1.50 mm B.T.D.C. (20 Degree)
---------------------------	---------------------------------

The magneto is originally set so that the correct ignition timing point can usually be obtained by only adjusting the contact point gap within the range of 0.3 ~ 0.4 mm. However, if the magneto base is removed or the point is renewed, the relative positions between the base, point and crankcase may change and they require re-adjustment of the magneto base, in this case, adjust the base as shown in the figure.

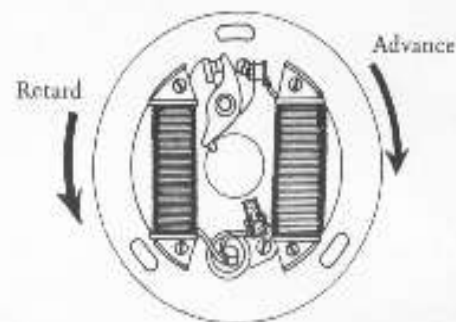

① Magneto base

Battery

The battery solution must be kept above the lower limit line at all times. If the solution level is found below the lower limit line, add the pure distilled water up to the upper limit line. Do not add diluted sulphuric acid.

Refer to page 43 for the method of initial charge or recharge.

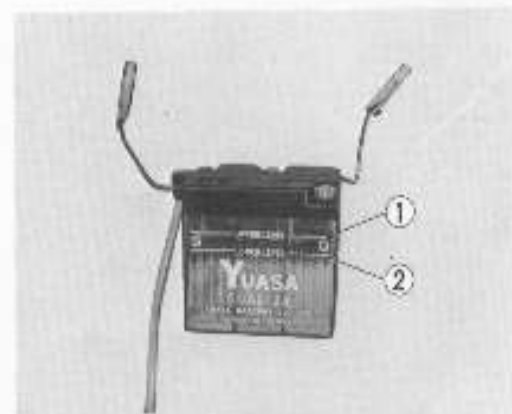

① Upper limit line ② Lower limit line

Air Cleaner

If the air cleaner is clogged with dust, the air flow is reduced causing increased fuel consumption and a fall off in power.

To clean:

- 1) Unscrew the air cleaner case bolt and move it forward slightly.

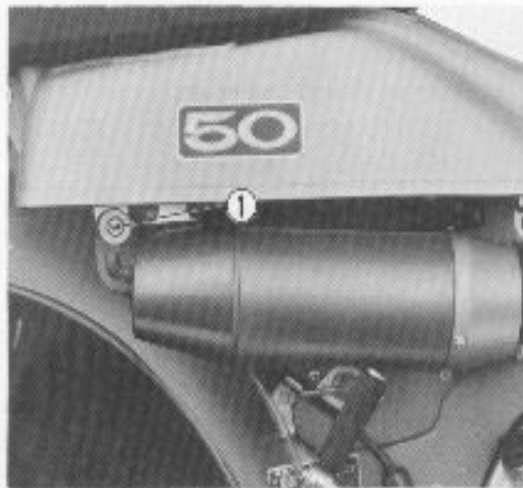

① Air cleaner fixing bolt

- 2) Unscrew the three screws and remove the air cleaner case.
- 3) Unscrew the polyurethane filter cover bolt and pull out the filter.

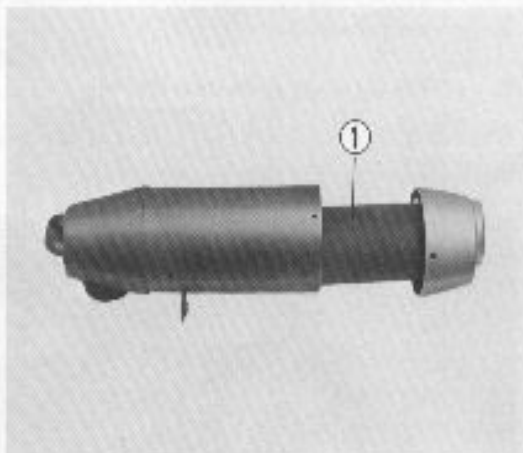

① Polyurethane filter

- 4) Wash the filter with clean gasoline.
- 5) After wringing gasoline out of the filter soak it according to the removal procedures in the reverse order.

Muffler

The existence of carbon or tar in the muffler decreases exhaust efficiency, causing poor engine performance.

To clean:

- 1) Unscrew the locking screw at the end of the muffler and pull out the baffle pipe.

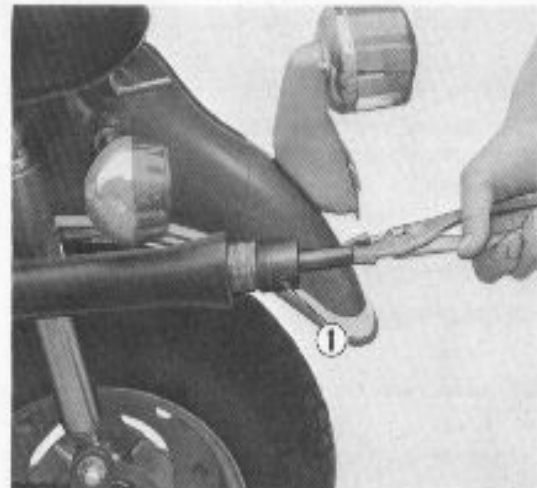

① Baffle pipe

- 2) Remove carbon deposits by gently striking the baffle pipe.
- 3) Wash the baffle pipe with gasoline or cleaning solvent.
- 4) Loosen the muffler drain plug and drain the tar.

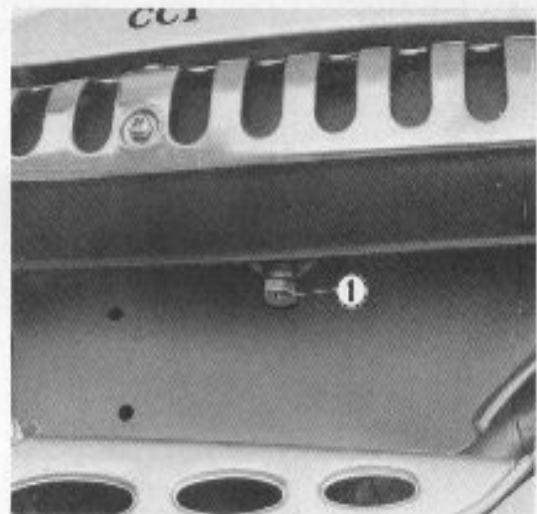

① Drain plug

- 6) Fit the drain plug and baffle pipe.

8. ENGINE

The engine is made as a single-unit including the clutch and transmission and is mounted to the frame by three mounting bolts.

The engine may be removed by disconnecting the wiring system, fuel system, exhaust system, air intake system and final drive system, and removing the engine mounting bolts. However, the following parts can be removed from the engine without taking the engine from the frame.

Cylinder head, cylinder, piston, carburetor, clutch assembly, gear shifting shaft, flywheel magneto, contact breaker assembly and oil pump

Prior to removal, thoroughly clean the engine with a steam cleaner or cleaning solvent to remove road dirt. The removal procedure is as follows.

Removal from Frame

1. Removing seat

Required tool:

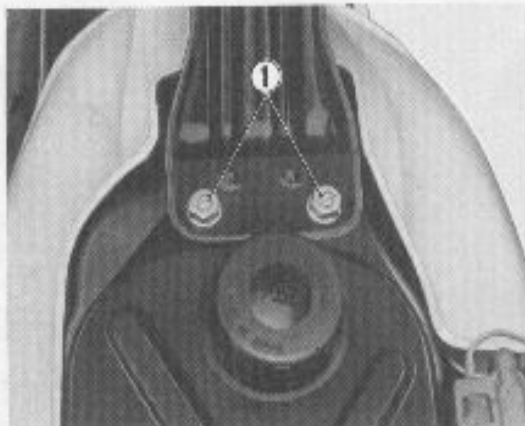

① Seat bolt

2. Disconnecting battery ground cord

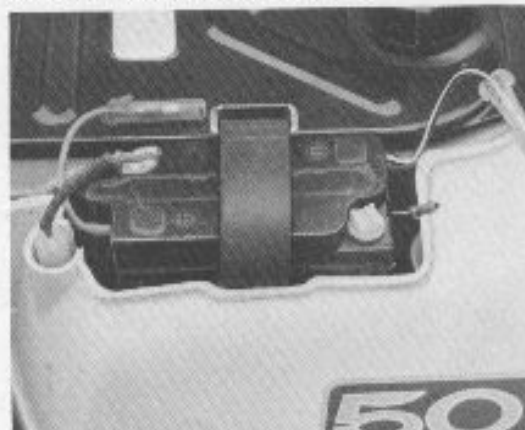

3. Removing frame cover

Required tool:



4. Removing plug cap

5. Disconnecting lead wires from engine

When disconnecting lead wires, be sure to use both hands as shown in the figure.



6. Removing air cleaner intake pipe

Required tool:



Slacken the intake pipe clamp screw on engine side and pull out the pipe.

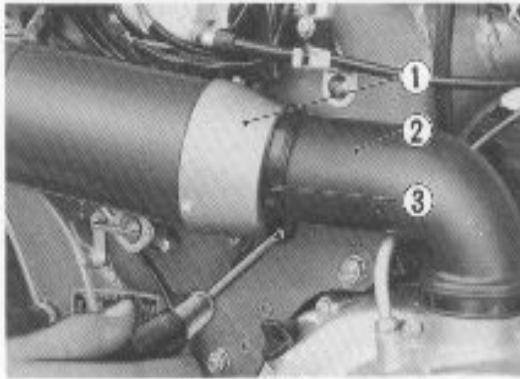

① Air cleaner ② Air cleaner intake pipe
③ Intake pipe clamp

7. Removing carburetor inspection cap

Required tool:

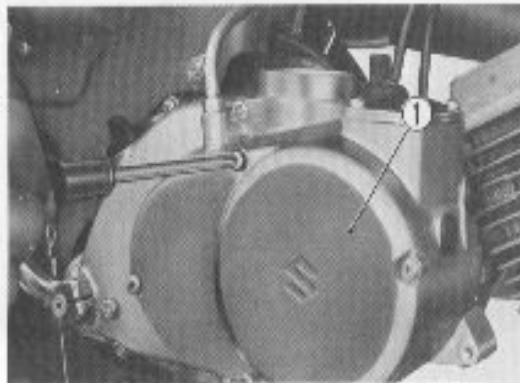

① Carburetor inspection cap

8. Slackening carburetor clip bolt

Required tool:

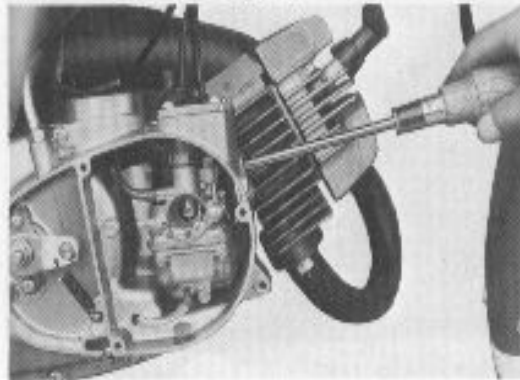

9. Disconnecting fuel and air vent hoses

Turn the fuel cock lever to the "0" position to prevent fuel flow and pull out the fuel and air vent hoses from the carburetor.

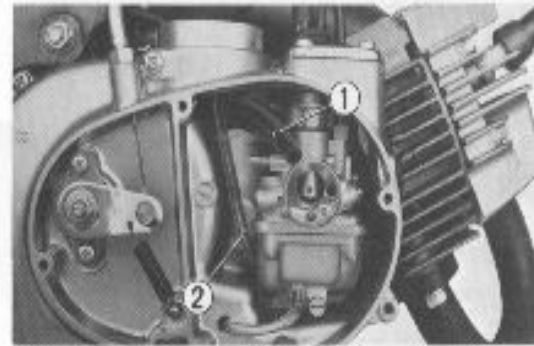

① Fuel hose ② Air vent hoses

10. Removing carburetor

Required tool:

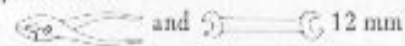

Pull out the carburetor and then remove the throttle and the starter valve.

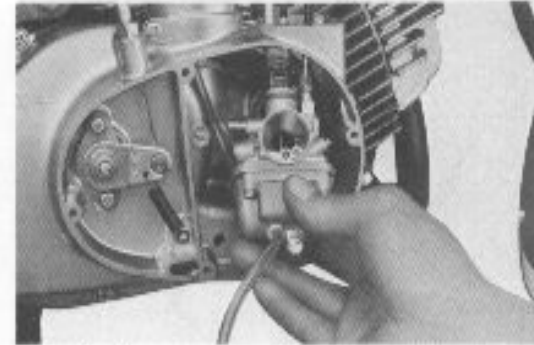

① Throttle valve ② Starter valve

11. Removing clutch releasing lever

Required tool:

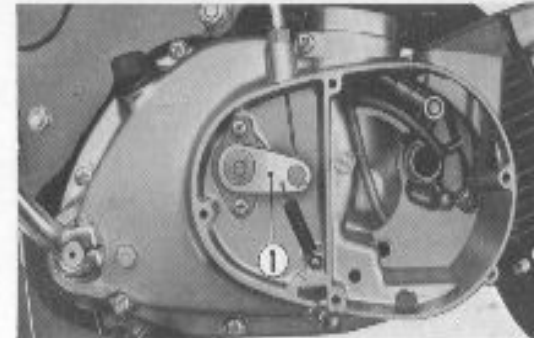
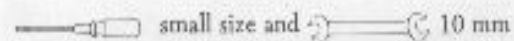

① Clutch releasing lever

12. Removing clutch cable



13. Disconnecting engine oil pipe

Required tool:



Disconnect the engine oil pipe from the oil tank outlet and block the outlet with a rubber cap.



① Oil tank ② Engine oil pipe

14. Removing muffler cover

Required tool:



① Muffler cover

15. Removing muffler

Required tool:

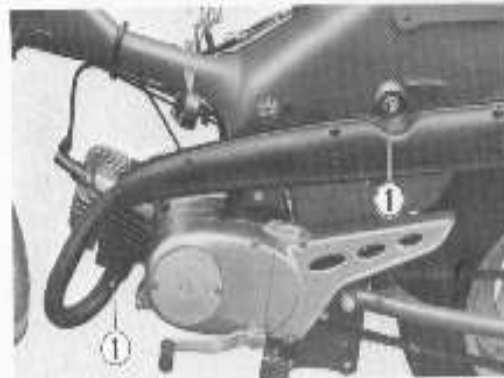
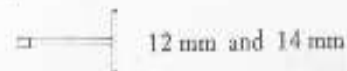

① Muffler bolt

16. Removing drive chain

Required tool:



Remember the direction of the chain joint clip and take care not to lose it.

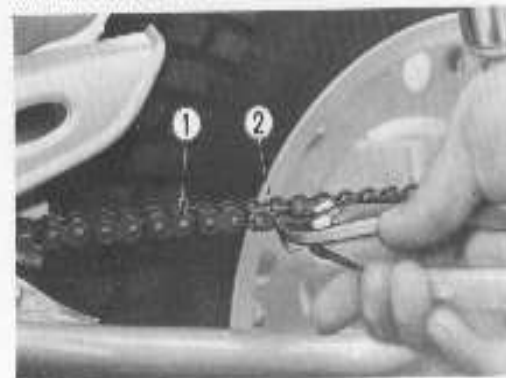

① Drive chain ② Chain joint clip

17. Removing engine sprocket cover

Required tool:



① Engine sprocket cover

18. Removing oil pump cover

Required tool:



① Oil pump cover

19. Disconnecting oil pump cable

Disconnect the oil pump cable at the oil pump control lever by removing the cable end as shown in the illustration.

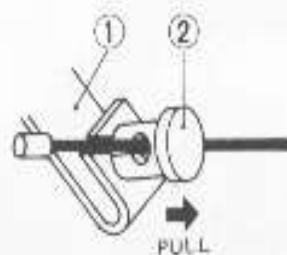

① Oil pump control lever ② Cable end

20. Removing engine mounting bolts

Required tool:

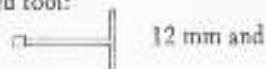

Tightening torque:

150 ~ 250 kg·cm (11 ~ 18 lbf)

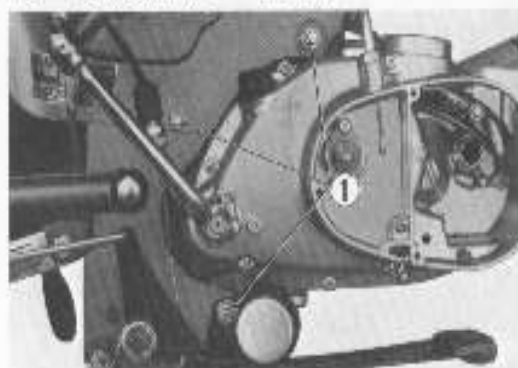

① Engine mounting bolt

Disassembly and Assembly

This section explains the work necessary for separating the crankcase. When disassembling the engine, take the following steps. For reassembling the engine after inspection or repair, follow the reverse order of disassembly.

1. Draining transmission oil

Required tool:

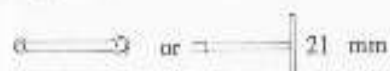

Place the engine on the working bench and drain out transmission oil by removing the drain plug.



2. Removing left crankcase cover

Required tool:



Before removing the left crankcase cover, remove the gear shifting lever.



① Left crankcase cover

3. Removing flywheel rotor fixing nut

Required tool:



Special tool

#09930-40113

Tightening torque:

300 - 400 kg-cm (22 - 29 ft-lb)

Hold the flywheel with the engine sprocket and flywheel holder and remove the rotor fixing nut.

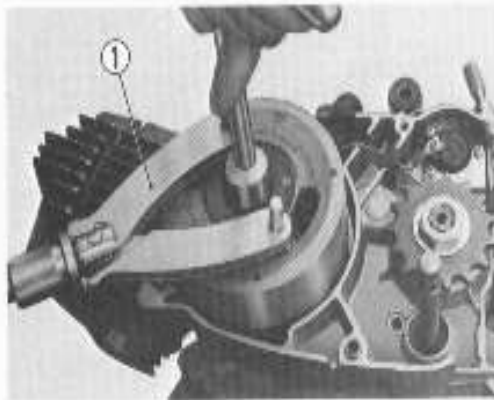

① Engine sprocket and flywheel holder

4. Removing flywheel rotor

Required tool:



Special tool

#09930-30113

To remove the flywheel from the crankshaft, screw the rotor remover counter-clockwise and turn the handle clockwise.

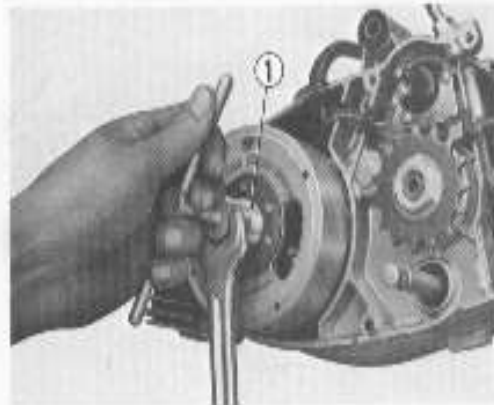

① Rotor remover

5. Removing magneto stator

Required tool:



Take off the magneto stator removing three screws and disconnect the neutral switch wire from the switch body.

24

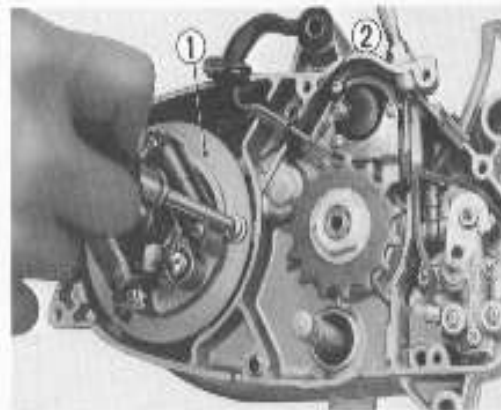

① Magneto stator ② Neutral switch wire

6. Flattening engine sprocket washer

Required tool:

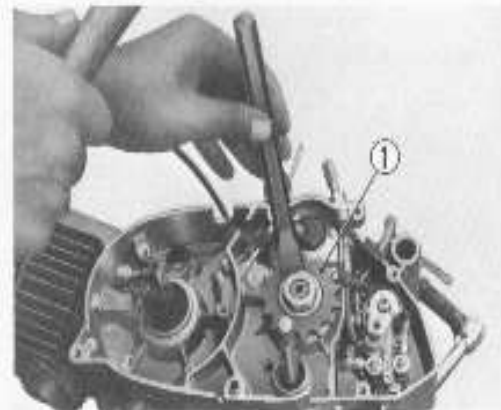
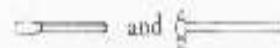

① Engine sprocket

7. Removing engine sprocket

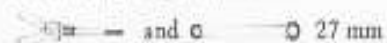

Special tool

#09930-40113

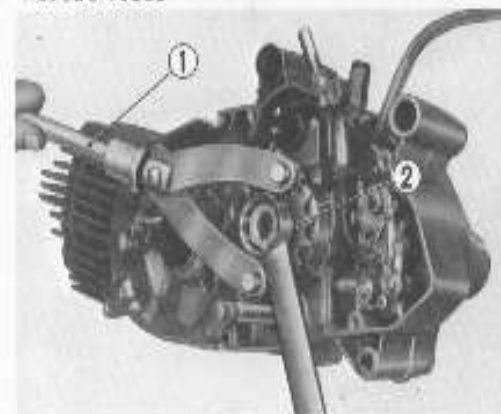

① Engine sprocket and flywheel holder
② Engine sprocket

B. Removing neutral switch body

Required tool:

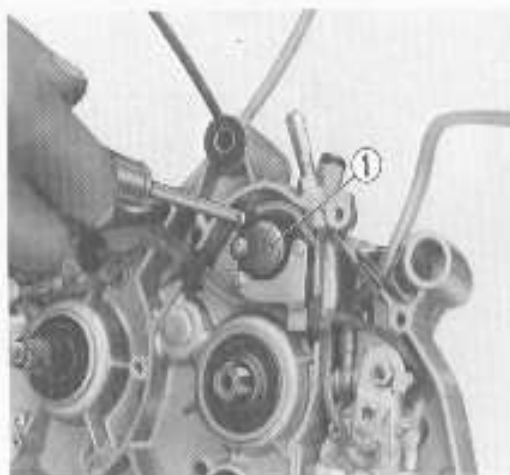

① Neutral switch body

9. Removing neutral switch contact point

Required tool:

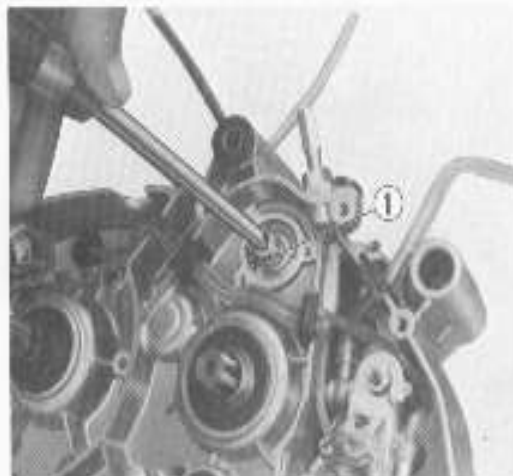

① Neutral switch contact point

10. Removing cylinder head and cylinder

Required tool:



Tightening torque:

60 ~ 100 kg-cm (4.4 ~ 7.3 ft-lb)

Slacken the cylinder head nuts in reverse of tightening sequence.



* The figures on the cylinder head indicate the tightening order.

11. Removing piston pin circlip

Required tool:

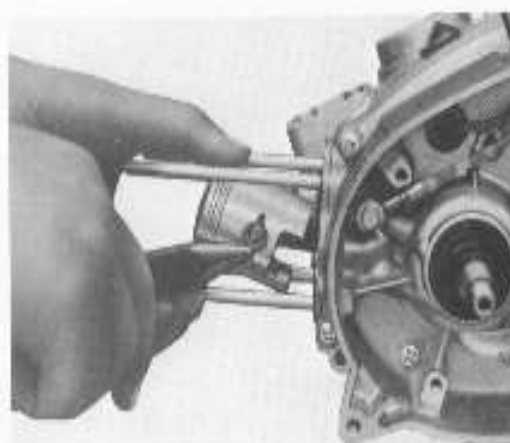

12. Removing piston pin

Push the end of the piston pin with a rod.

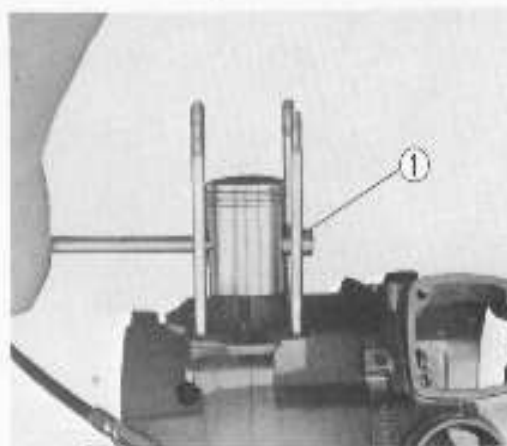

① Piston pin

13. Removing right crankcase cover

Required tool:

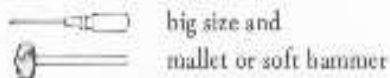

After removing the kick starter lever, loosen the right crankcase cover fixing screws and remove the cover hitting with a mallet or a soft hammer.

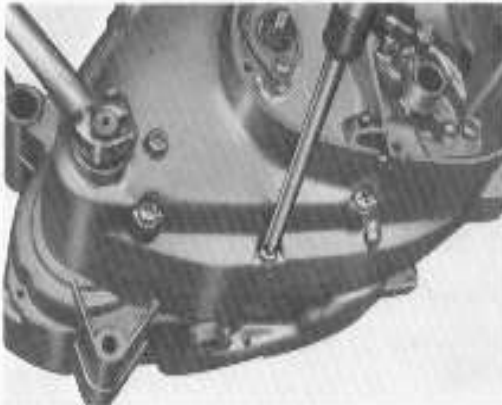

14. Loosening clutch sleeve hub nut

Required tool:



Special tool
#09910-20113

Place the piston holder between the connecting rod and the crankcase in order to lock the counter-shaft and slacken the clutch sleeve hub nut.

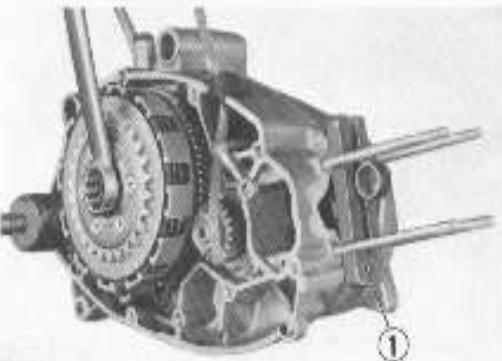

① Piston holder

15. Disassembling clutch

Required tool:



16. Removing kick starter spring

Required tool:



Pull out the kick starter spring guide and remove the spring as shown in the figure.



① Kick starter spring guide ② Kick starter spring

17. Removing snap ring

Required tool:

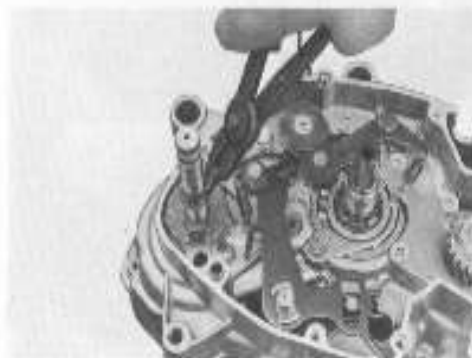

① Snap ring opener

18. Flattening primary pinion lock washer

Required tool:



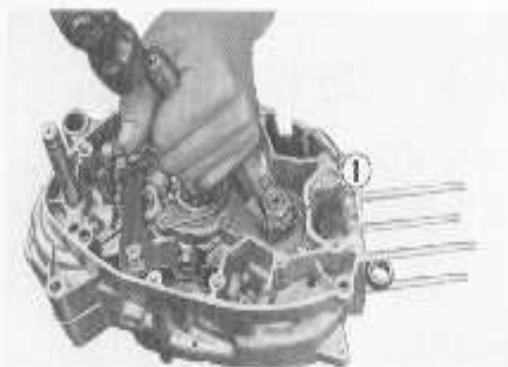

① Primary pinion

19. Removing primary pinion lock nut

Required tool:



Special tool
#09910-20113

Place the piston holder between the connecting rod and the crankcase in order to lock the crankshaft and loosen the primary pinion lock nut.

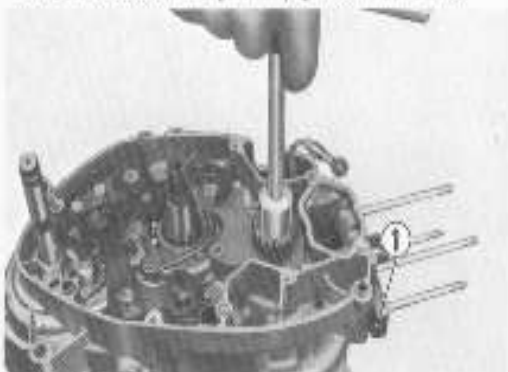

① Piston holder

20. Removing primary pinion key

Required tool:



① Primary pinion key

21. Removing shifting cam stop

Required tool:

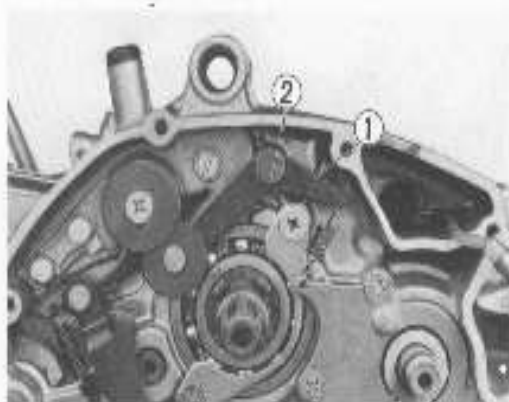

① Shifting cam stop ② Shifting cam stop bolt

22. Removing gear shifting shaft



① Gear shifting shaft

23. Removing shifting cam guide

Required tool:

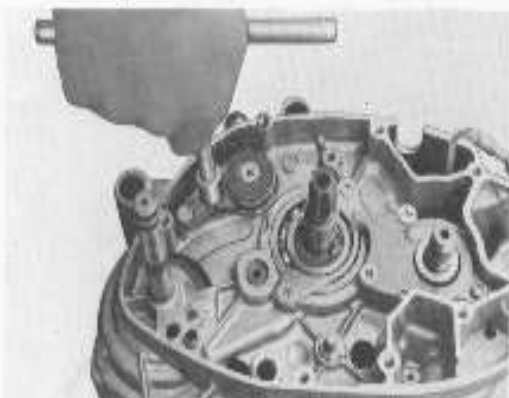

① Shifting cam guide ② Shifting cam
③ Lock washer

24. Disconnecting engine oil pipe

Required tool:



Tightening torque:

20 ~ 30 kg·cm (1.4 ~ 2.2 ft·lb)

Disconnect the engine oil pipes by loosening each union bolt on both sides of the crankcase respectively.

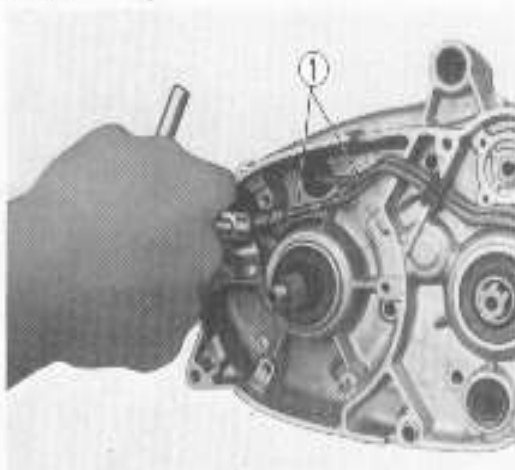

① Engine oil pipe

25. Loosening crankcase and oil pump screws

Required tool:



Special tool

#09900-09002

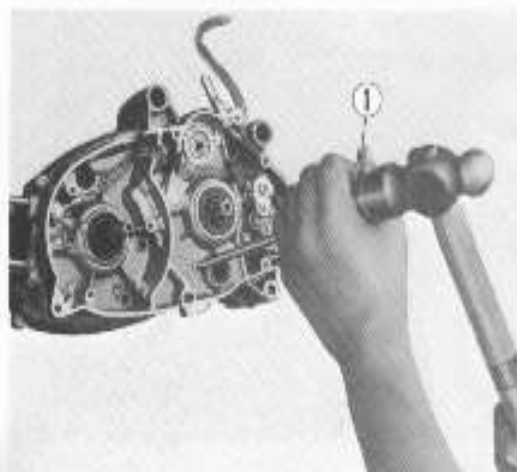

① Impact screw driver

26. Separating crankcase

Required tool:



Special tool

#09910-80113

Set the crankcase separating tool on the left crankcase as shown in the figure. Separate the crankcase into right and left halves by screwing the handle of the special tool in. At the same time, push in the engine oil pipe at the right side of the case so as not to damage it.

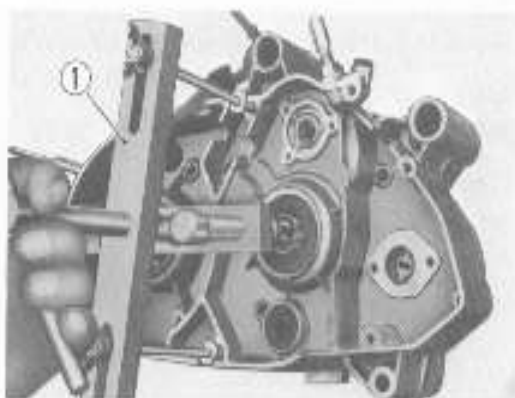

① Crankcase separating tool

27. Removing oil pump

Required tool:



Push out the engine oil pipe guide on the left crankcase paying attention not to damage the pipe and then remove the oil pump.

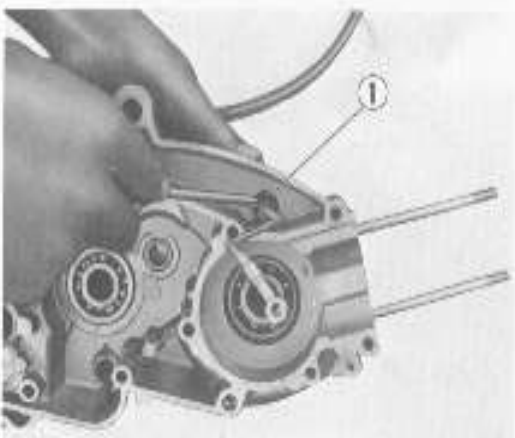

① Engine oil pipe guide

28. Removing transmission gears

Required tool:



Remove the transmission gears together with the gear shifting cam from the right crankcase.

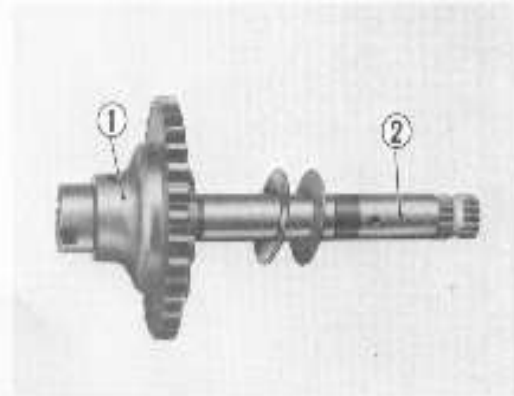
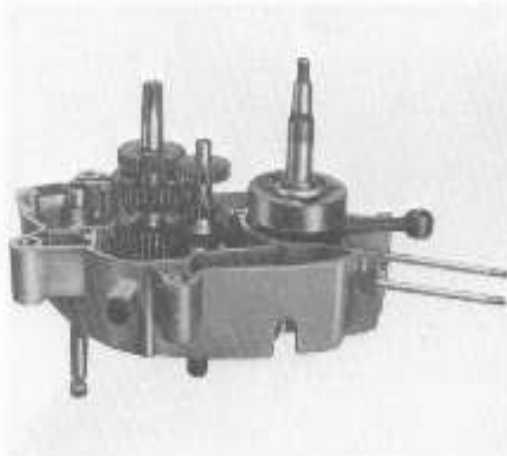

① Kick starter pinion ② Kick starter shaft

31. Removing third drive and second driven gears

Required tool:



Remove the snap rings with the snap ring opener and pull out the gears.



① Snap ring opener

29. Removing crankshaft

Required tool:



Hit the rightside end of the crankshaft gently with a mallet or a soft hammer.

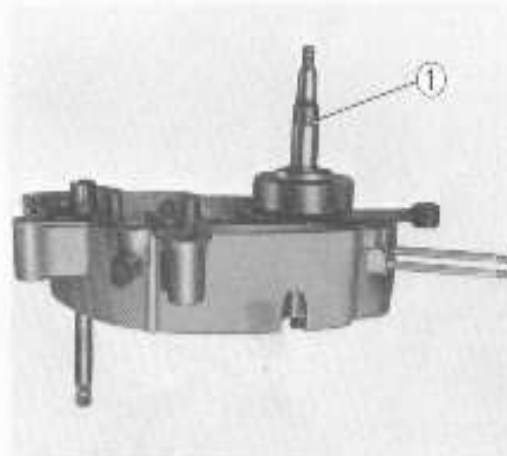

① Crankshaft

32. Removing oil seals

Required tool:

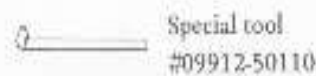

① Oil seal remover

30. Removing kick startershaft

Pull out the kick starter shaft and remove the kick starter pinion from the kick startershaft.

Necessary Points on Assembly

This section describes tips on assembly in order to eliminate difficulties which will be encountered and the work to be done when assembling the engine.

1. Transmission and crankshaft

For the installation of gears, circlips, washers and bearings, refer to the illustration.

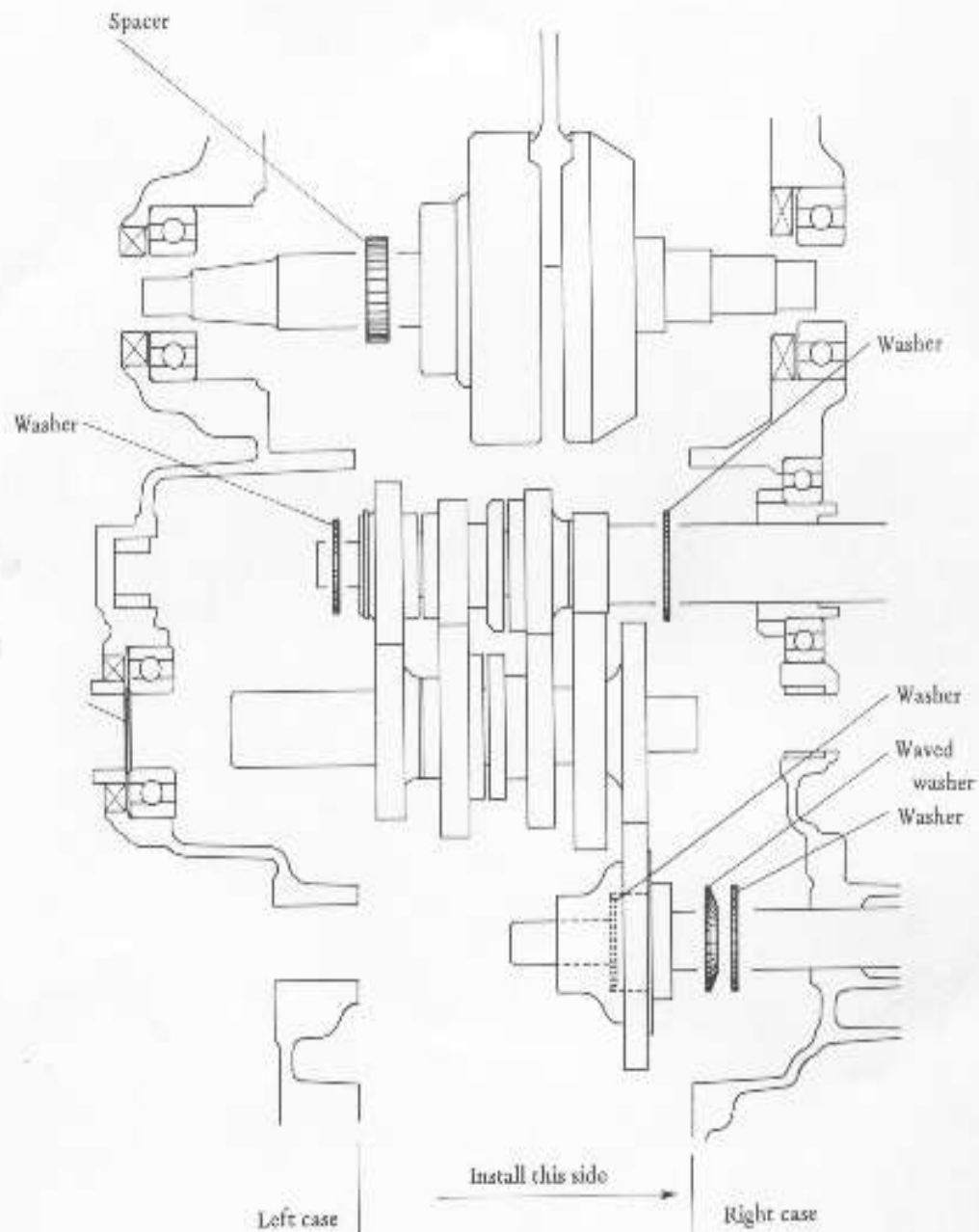

1) Apply engine or transmission oil to the bearings and gears.

2) Apply a little grease to the lips of oil seals.

2. Gear shifting cam

To assemble the shifting forks to the gear shifting cam:

- 1) Insert the short pin into the hole which is located opposite direction of the neutral switch contact point positioning groove.
- 2) Apply engine oil to the shifting fork pins.

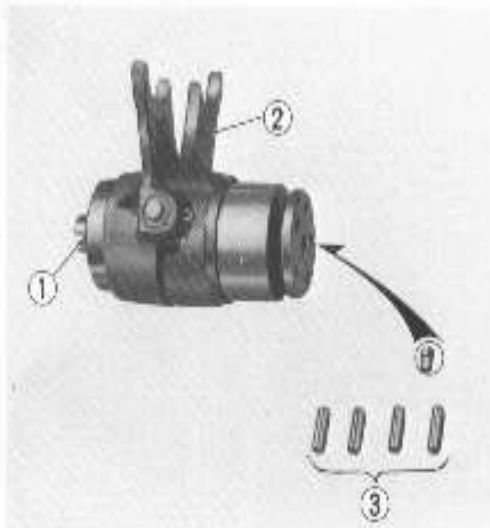

① Neutral switch contact point positioning groove
② Shifting fork ③ Shifting fork pin

3. Kick starter shaft

For installation of gear, washers, pawl and etc., refer to the illustration.

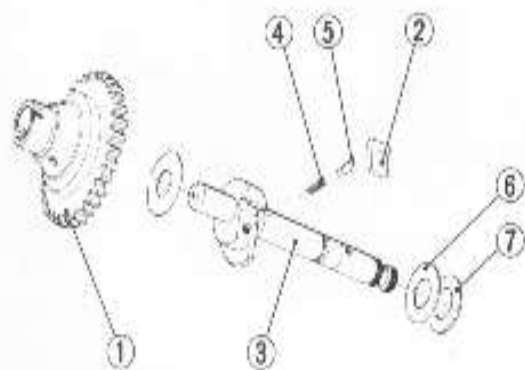

① Kick starter drive gear ② Pawl ③ Kick starter shaft
④ Roller ⑤ Washer ⑥ Washer ⑦ Washer

4. Crankcase

- 1) Before joining the left and right crankcases, clean their mating surfaces and replace the gasket with a new one.
- 2) The crankcase screws should be tightened according to the tightening order and used in the position as shown in the figure.

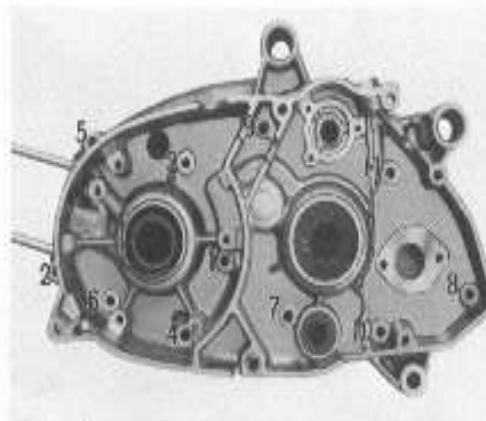

* The figures indicate the tightening order.

5. Piston rings

A Keystone type ring and a flat ring are used for the first and the second ring of RV50, respectively; therefore, the first and second ring must not be interchanged.

- 1) Before installing the flat piston ring, install the expander ring in the second groove of the piston.
- 2) Install the Keystone type piston ring in the first groove of the piston.

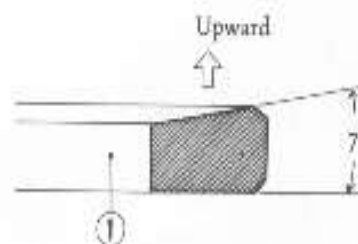

① Keystone type ring

- 3) Be sure to align the piston ring and expander ring open ends with the dowel pin on the piston ring grooves.

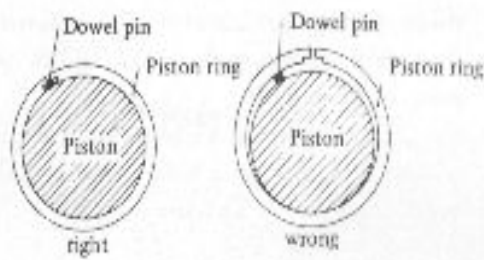

6. Piston

The piston pin hole is off-center and the piston skirt is cut according to the shape of the scavenging passage on the crankcase, therefore, the piston should be installed in the proper direction.

- 1) The arrow mark on the piston head indicates the exhaust side.



① Arrow mark

- 2) Apply engine oil to the piston rings and side wall of the piston before installing the cylinder.
- 3) Insert the piston in the cylinder while paying attention that the ring open ends do not rotate out of their located position.

7. Cylinder

In case of installing a rebored cylinder, be sure to check if the edges of the ports and skirt are chamfered. If the edges are sharp, chamfer them with a

scraper or emery paper. This will prolong life of the piston and the piston rings. The designed chamfer is as illustrated in the figure.

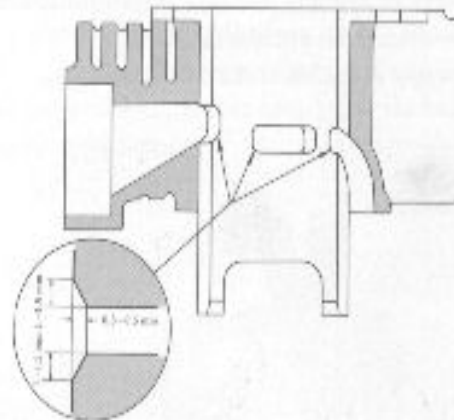

8. Cylinder head

When installing the cylinder head, tighten 4 cylinder head fixing nuts evenly in the sequence as illustrated below.

Tightening torque:

60 ~ 100 kg-cm (4.4 ~ 7.3 ft-l)

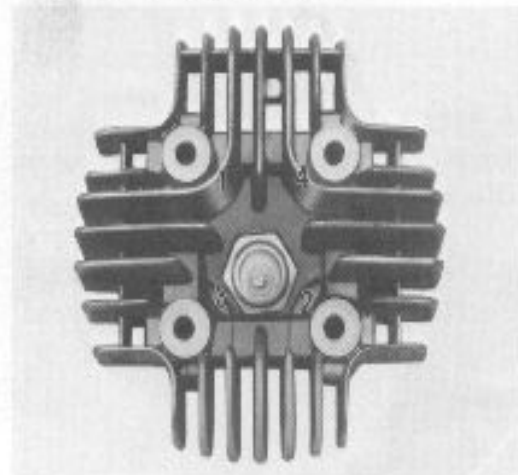

9. Oil reservoir plate

When fitting the oil reservoir plate to the right crankcase, the screws should be used as shown in the figure, otherwise the head of the screw will come in contact with the primary driven gear. The flat headed screws must be used in the cover holes.

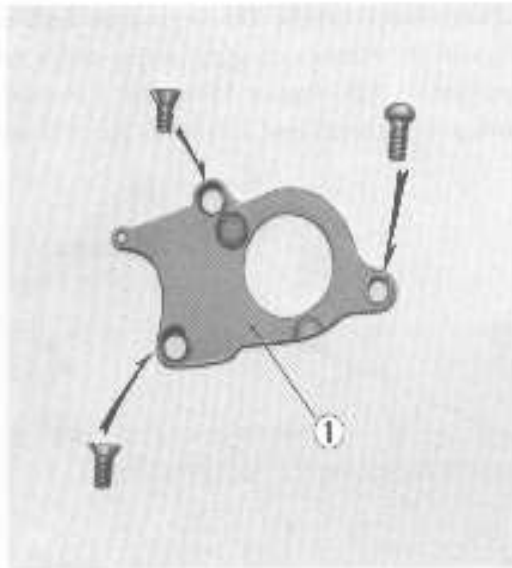

① Oil reservoir plate

10. Engine oil pipe

When the engine assembly is completed, the oil passages have to be filled with oil. If the engine is started and kept on running in this condition, the engine may suffer lack of lubrication causing bearing failure or piston seizure. Therefore, it is necessary to fill the pipe with engine oil and bleed out all air.

- 1) Slacken the bolt or screw shown in the figure to expel air in the oil pipe from the oil tank.
- 2) When the air bubbles have disappeared, screw in the bolt or screw securely.

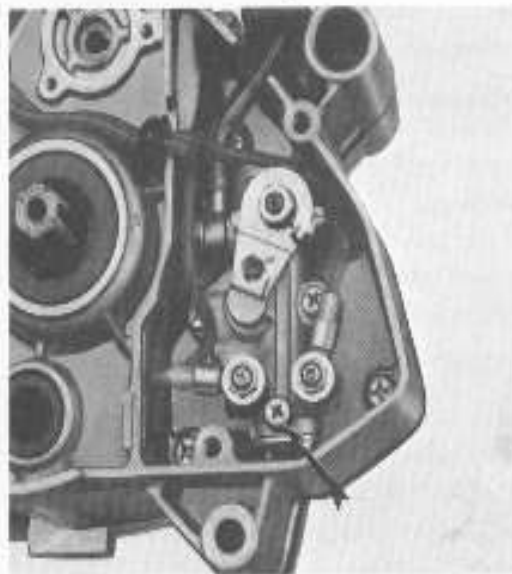

- 3) Loosen the screws located on the engine oil outlet union bolts.
- 4) Supply the specified engine oil to the outlets with a oil filler as shown in the figure.

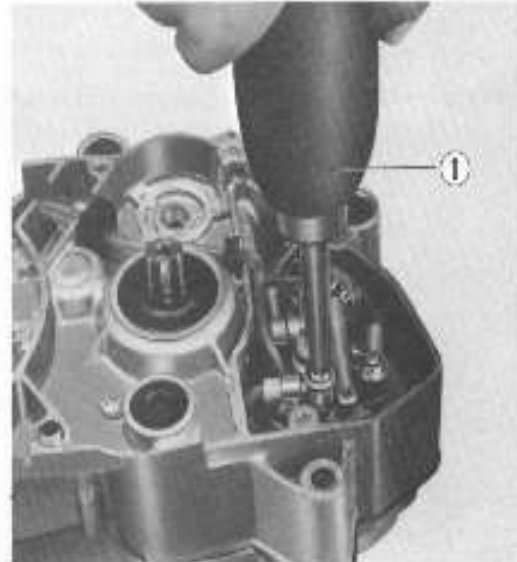

① Oil filler

11. Kick starter shaft return spring

- 1) Turn the kick starter shaft clockwise all the way.
- 2) Insert one end of the spring into the hole on the right crankcase and insert the other end into the hole on the starter shaft with the spring twisted half a turn, using a pliers.

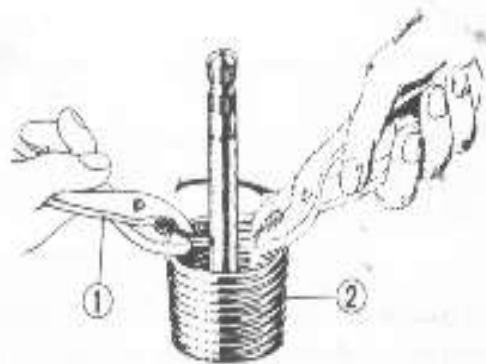

① Pliers ② Kick starter return spring

Engine Lubrication System

The engine lubrication is the Suzuki CCI system as in all other Suzuki models. The oil pump has 2 outlets connecting with respective oil feeding pipes and lubricate all the moving parts of the engine except the crankshaft right end bearing which is lubricated by transmission oil. The oil pump driving force is transmitted from the crankshaft to the pump through the primary pinion, primary gear, kick starter gear, idle gear and kick starter pinion as illustrated below.

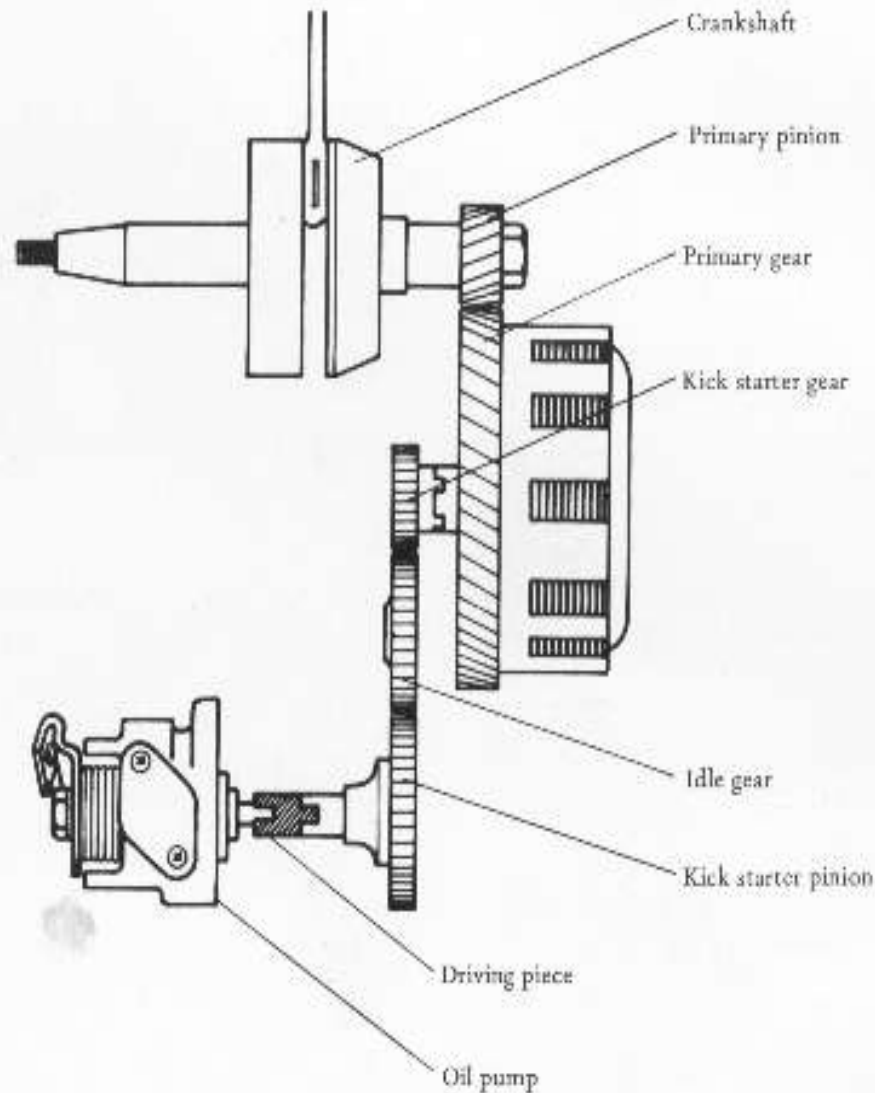

The plunger and the differential plunger are always pressed to the right side by the spring and their movements to the right are restricted by the cam or the stationary base fitted on the right side of the pump body. The plunger is worm geared in its center part which engages the driving worm. When the driving worm turns, the plunger also turns together with the differential plunger and moves left and right according to the cam shape, which is machined on the right end of the plunger.

The discharge and suction of oil in the pump take place by a change in the inside volume caused by the strokes of plunger and differential plunger.

The cam fitted on tight side of the pump body is to change the travel of the plungers and is connected with the oil pump control lever which moves according to the throttle grip is fully opened and less oil is delivered when the grip is closed.

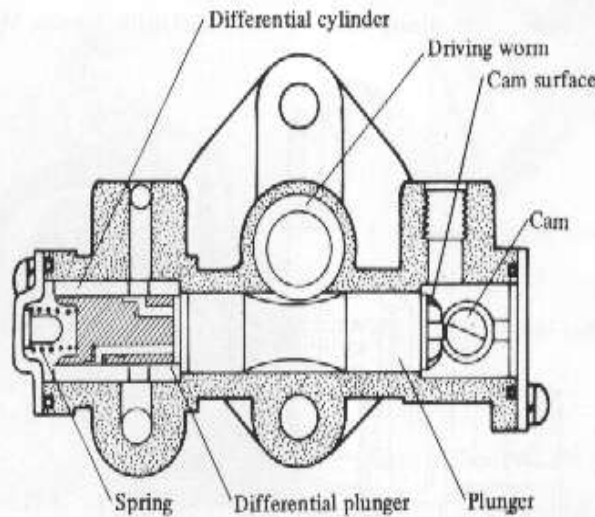

This graph shows the relation between control lever opening and oil discharge when the driving worm speed is running at 400 rpm.

For the machine having the engine number up to RV50-44515;

For the machine having the engine number or and from RV50-44516;

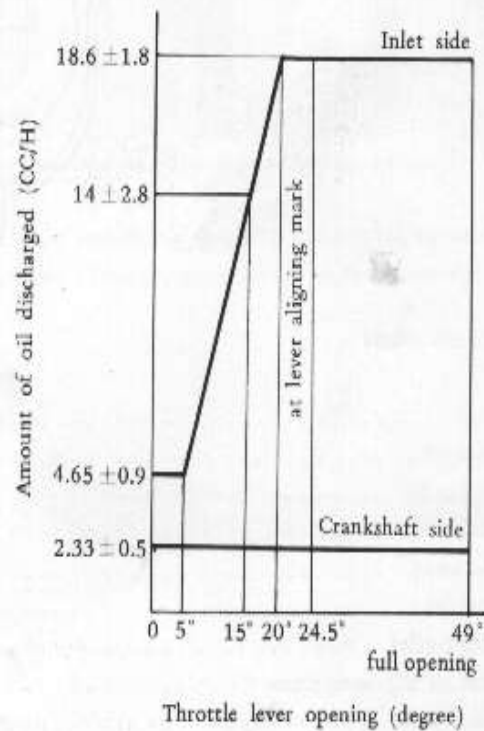
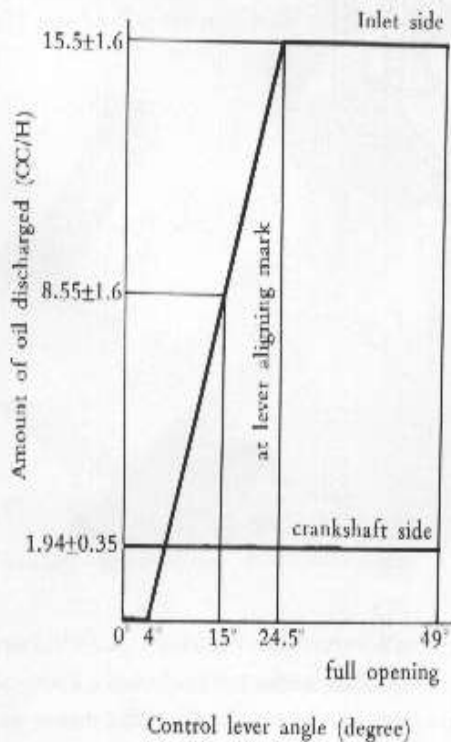

* Under normal temperature and atmospheric pressure

Carburetor

An "Amal" type carburetor is used. The best feature of this carburetor is that the air/fuel ratio which the engine requires is produced by varying the air and fuel passages according to the throttle valve opening.

As air enters the carburetor, it passes under the throttle valve where a vacuum pressure is produced due to the restriction caused by the throttle valve extending into the main air passageway. The fuel discharge outlet is located in this venturi area so that the vacuum pressure can draw out the fuel. This carburetor incorporates not only both a main and slow system, but also a easy start system.

For further details of the carburetor, please refer to the SUZUKI'S Service Manual "Carburetor and Carburetion" of 1971.

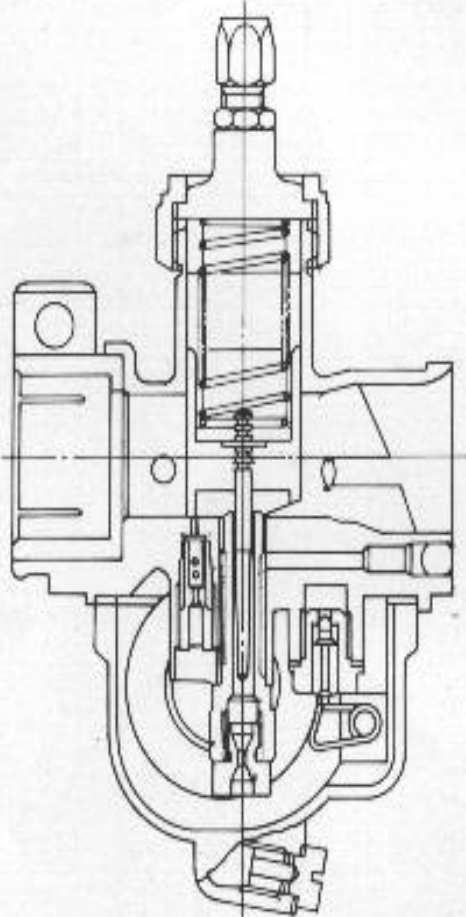



Specifications

Type	VM14SC
Main jet	#65
Jet needle	3E3 - 4th
Needle jet	E-3
Cut away	2.5
Pilot jet	#15
Pilot outlet	0.9
Pilot air adjusting screw	1/4 turns back
Valve seat	1.2
Starter jet	#40
Float level	24 mm

Adjustment of carburetion

Adequate carburetion is determined according to the result of various tests mainly in consideration of engine power, fuel consumption and fuel cooling effect to the engine, and jets settings are done so as to satisfy and balance all these conditions. Therefore, it is not recommended to replace the jet with other sizes than original or to change the setting position of adjustable parts except when adjusting the mixture ratio due to a different altitude or climate conditions. When adjustment is essential, carry out the job referring to the following

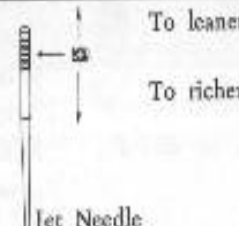
1) Fuel-air mixture ratio can be changed by following method.

Throttle opening	Method to change the ratio	Standard setting
Slight	Pilot air adjusting screw 	1 1/4
Medium		4th position from top groove
High		Number 65

2) The fuel level inside the float chamber should be set in its correct position. To adjust the fuel level, measure the height of the float from the mixing chamber body as follows.

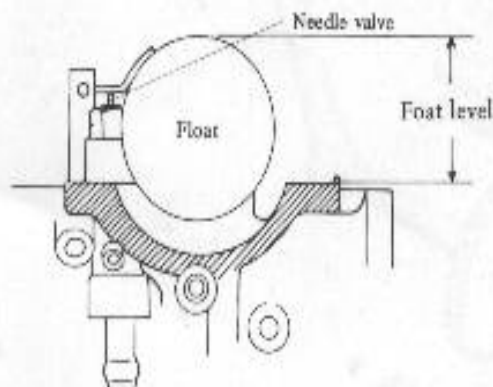

- * Remove the float chamber.
- * Hold the carburetor upside down with the float fitted to the mixing chamber body.
- * Lower the float gradually and stop it when the float tongue touches the upper end of the needle valve.
- * Measure the distance between the float chamber fitted surface and bottom of the float as shown in the figure.

The float level should be 24 mm.

Adjustment of idle speed

The engine idling speed may be adjusted by turning the throttle valve stop screw and pilot air adjusting screw in the following procedure.

- 1) Warm up the engine for about 5 minutes.
- 2) Screw the pilot air adjusting screw in.

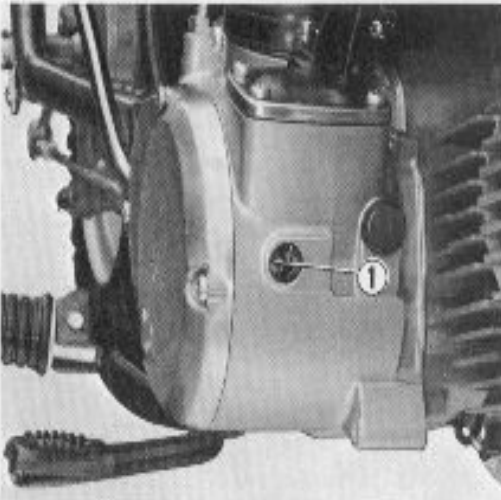

1 Pilot air adjusting screw

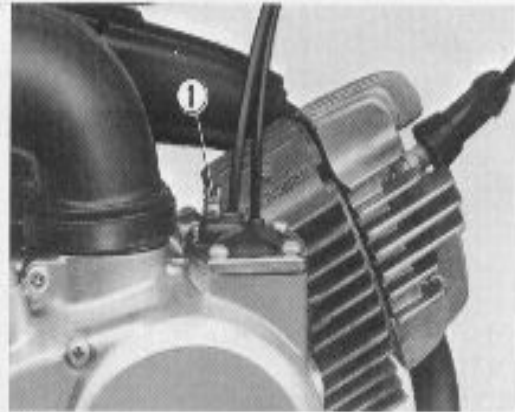

1 Throttle valve stop screw

- 3) Adjust the throttle stop screw so that the engine will maintain 800 rpm.

- 4) Open the pilot air screw gradually from its fully closed position and set it when the engine reaches its highest speed.
- 5) Drop the engine speed by turning the throttle valve stop screw.
- 6) Repeat the steps 4) and 5) two or three times, and the proper idle speed will be obtained.

Kick Starter System

As the kick starter system is the primary kick starting type, the engine can be started regardless of the gear position when the clutch is disengaged. The kick starting torque is transmitted to crankshaft through the kick starter pinion, the kick starter idle gear, the kick starter gear, the primary gear and the primary pinion as shown in the illustration.

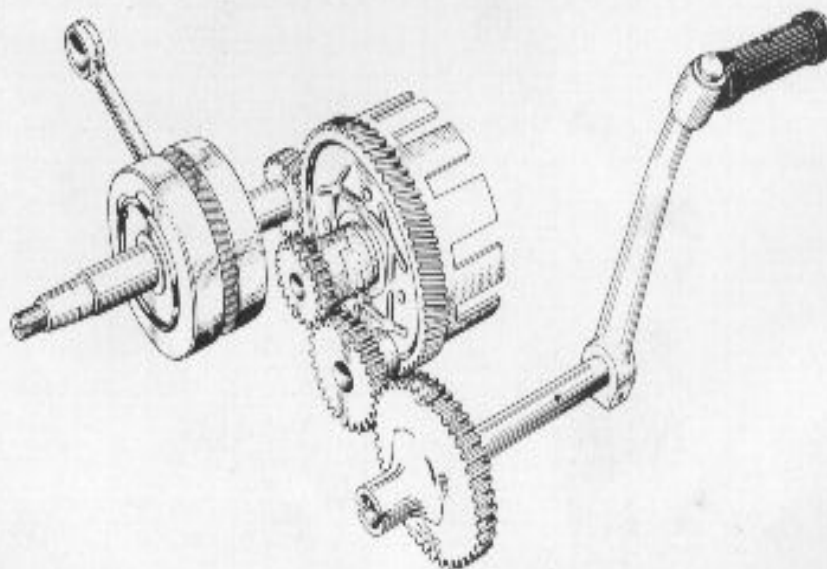

Inside the kick starter pinion is installed a ratchet mechanism consisting of a pawl, pawl roller and pawl spring. When the kick starter lever is depressed, the kick starter shaft turns in counter-clockwise direction as seen from the lever end of the shaft. When the kick starter shaft turns counter-clockwise, the kick starter pawl clutches with the teeth machined on the inside of the kick starter pinion and the kick starter pinion turns, as the pawl moves at a right angle to it.

Once the engine is started and the kick starter lever is released, the kick starter shaft is returned to its original position by the return spring and the pawl is pushed back out of the way by the kick starter shaft stopper so that the engine revs are not transmitted to the kick starter shaft.

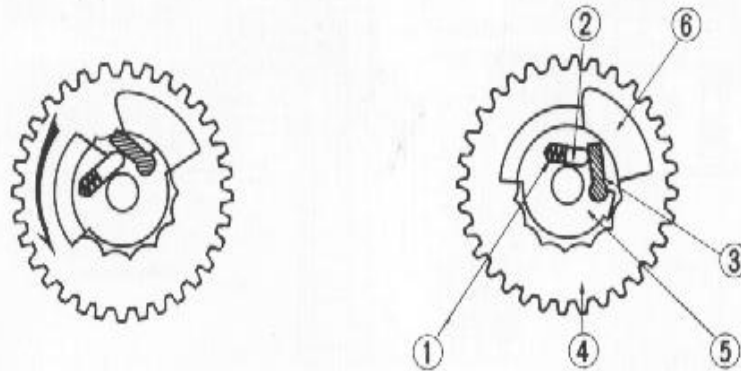

① Kick starter pawl spring ② Kick starter pawl roller ③ Kick starter pawl ④ Kick starter pinion
 ⑤ Kick starter shaft ⑥ Kick starter shaft stopper

Transmission System

The transmission is a constant mesh 4 speed. Construction and operating methods are explained in this section.

Engine power is transmitted to the drive shaft through the clutch, countershaft, gears on countershaft and gears on the drive shaft. From the drive shaft to the rear wheel, the power is further transmitted through the drive sprocket, drive chain and driven sprocket. Each set of drive and driven gears is used for each speed and these two gears are always paired so that one gear is free and the other gear is fixed on the related shaft in its turning direction.

The sliding gears shown in the illustration can move and clutch their facing free gears with dogs, which enable the free gears to be fixed with the shaft.

This movement is done by the gear shifting forks.

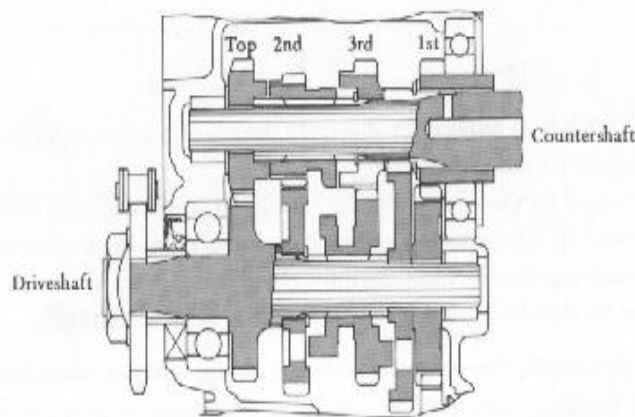

Neutral position

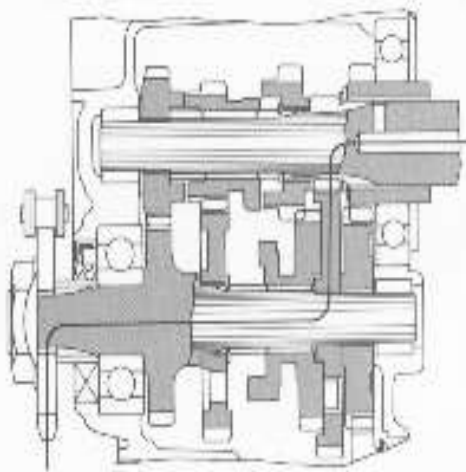

1st position

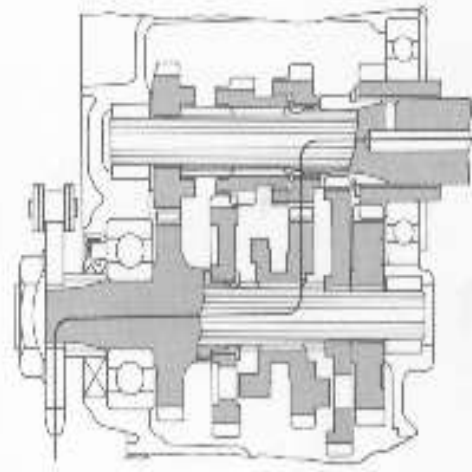

3rd position

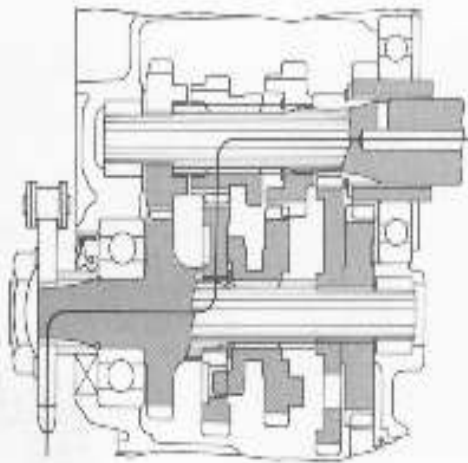

2nd position

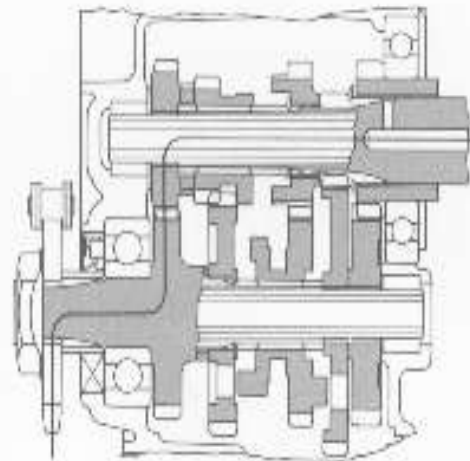

4th position

Clutch System

The function of the clutch is to transmit or disengage the power produced by the engine for the driving of the rear wheel through the transmission gears.

The drive plates are turned by the clutch housing rotating in accordance with the engine revolutions. The driven plates are meshed in the sleeve hub on the countershaft, and are unable to transmit power in this state. But when pressed together between the drive plates by the force of the clutch spring acting through the pressure plate, the frictional force produced allows power to be transmitted.

When the clutch is disengaged, the spring force acting on the pressure plate does not act on the clutch plates, therefore, the frictional force is decreased and the transmission of power between the plates is cut off.

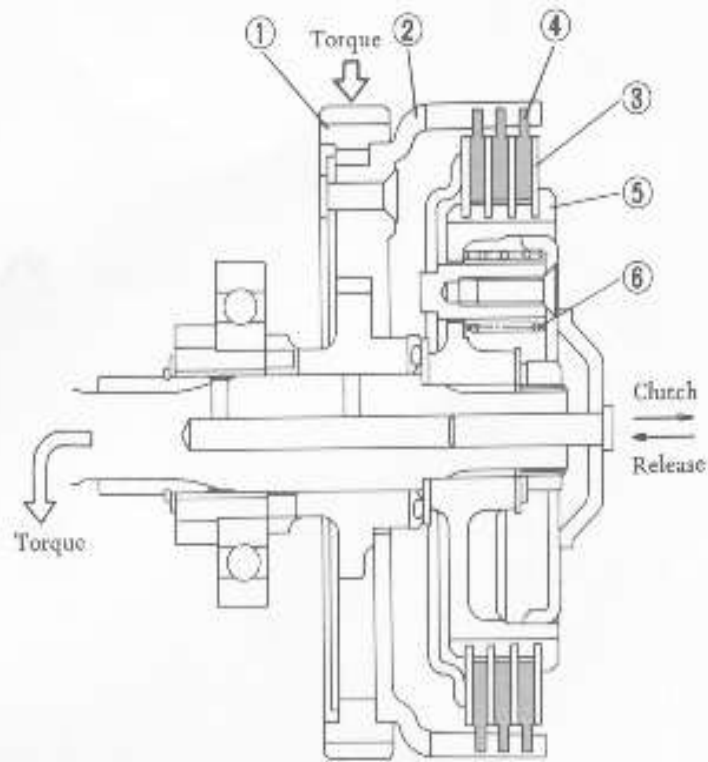

1 Primary gear 2 Clutch housing 3 Driven plate 4 Pressure plate 5 Clutch hub 6 Clutch spring

Air Cleaner

The element is made of washable spongy plastics and contains oil in it so as to further prevent dust from penetration. The construction is shown in the figure.

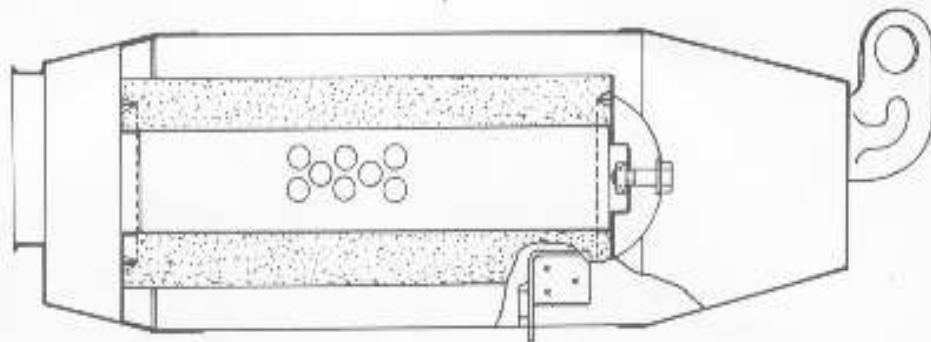

9. ELECTRICAL

Ignition System

The flywheel magneto type ignition system has the electrical wiring as shown in the figure. When the flywheel magneto is rotated a current is generated within the primary coil mounted on the stator. With the breaker points closed the current generated in the primary coil flows to ground through the points as the primary coil is grounded, giving no influence on the primary coil in the ignition coil. When the contact points open the current induced in the primary coil flows into the primary coil in the ignition coil allowing a high voltage to be induced within the secondary coil, thereby causing a spark to jump across the spark plug electrodes.

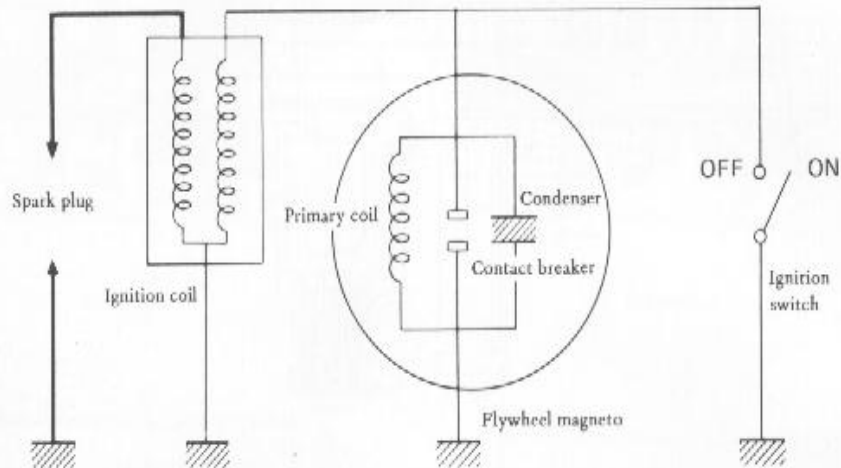

Charging System

The charging system using a flywheel magneto is shown in the figure. The charging coil and the lamp coil are fitted on the magneto stator and generate alternating current when the flywheel rotor turns. The charging system has two circuits, one is engaged by setting the ignition switch to the day time circuit and another to the night time circuit.

The alternating current generated in the charging coil flows to the rectifier and is rectified to direct current. The direct current charges the battery.

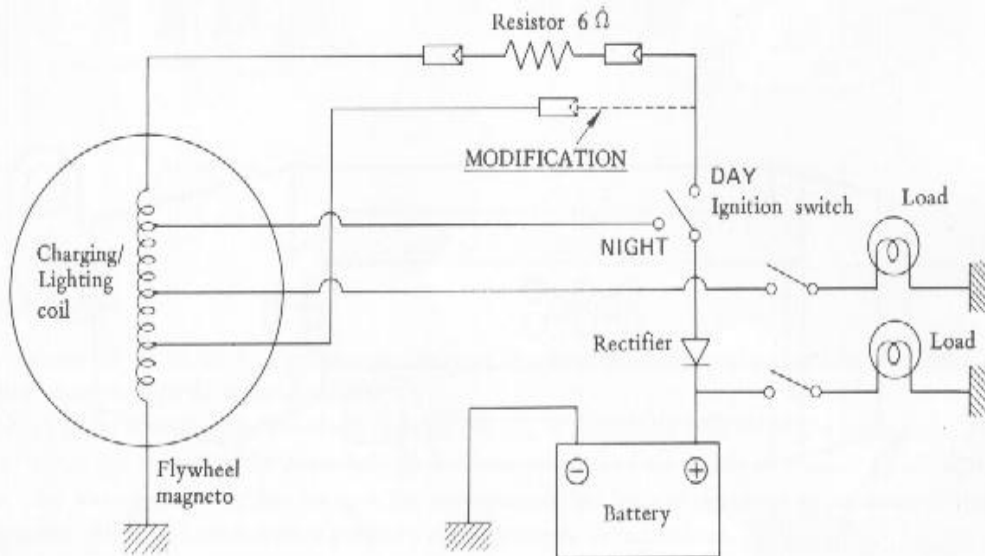

Note: If it is necessary to decrease charging capacity to the battery in day time position, the capacity can decrease with the modification as shown in the diagram.

Battery

The battery used on this model is either a YUASA or FURUKAWA made. Both are same type, 6N4-2A, and can be interchanged.

Initial charge

The battery is the dry-charged type unlike that of a large capacity battery, however, it must be initially charged at the specified rate before the battery is put in use since the plates may be oxidized to a certain extent during storage.

Initial charging rate	0.4A 10 - 12 Hours
Specific gravity of electrolyte	1.280 at 20°C (68°F)

Recharge

To check the battery condition in capacity, measure the specific gravity of the electrolyte by a hydrometer and refer to the following list.

SPECIFIC GRAVITY at 20°C (68°F)	CONDITION	NECESSARY MEASURE
1.250 - 1.280	OK	
1.220 - 1.250	Under charged	Recharge
Below 1.220	Run down	Replace or recharge

Caution: Be sure to remove the battery from the motorcycle in order to prevent the rectifier from being damaged due to excessive voltage given when recharging the battery.

10. BODY

Front Forks

The front suspension is the telescopic type. The construction is shown in the illustration.

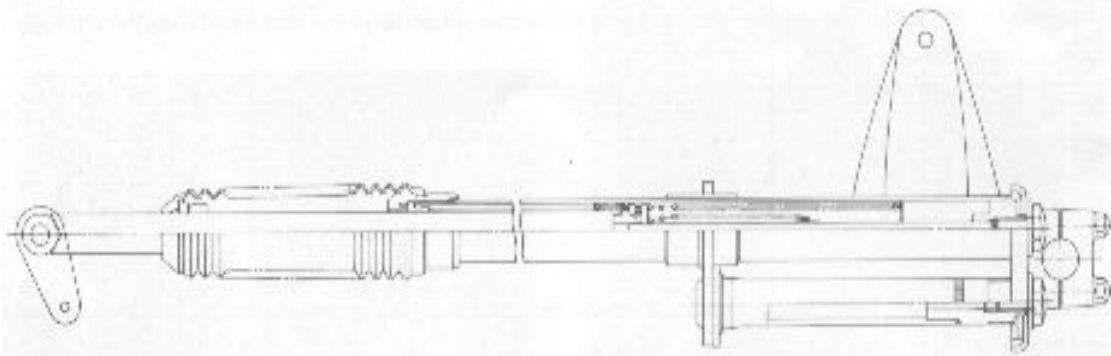

Disassembly and assembly

1. Removing front wheel

Remove the front wheel accordance with "Front and Rear wheel" on page 46.

2. Removing the front fender

Required tool:

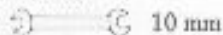

3. Disconnecting horn terminals

4. Removing the headlamp housing

Required tool:

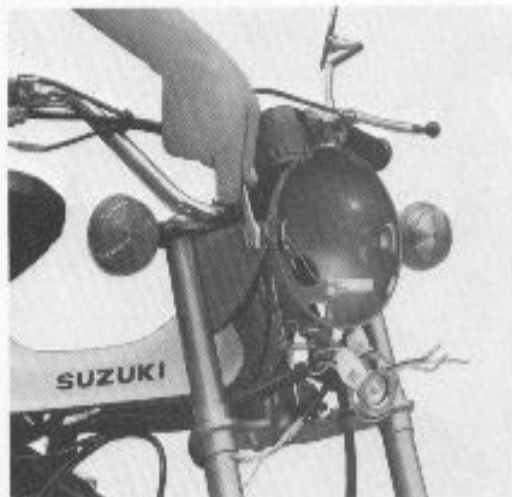
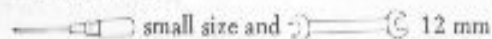

5. Loosening upper bracket fixing bolts

Required tool:



Tightening torque:

200 ~ 300 kg-cm (14 ~ 22 ft-lb)

After loosening the bolts, remove the upper bracket together with the handlebar and speedometer from the front forks.

When assembling the upper bracket, apply thread lock cement to the thread portion of the bolts.



① Upper bracket bolt

6. Removing steering stem lock nut

Required tool:



Special tool
#09940-10122

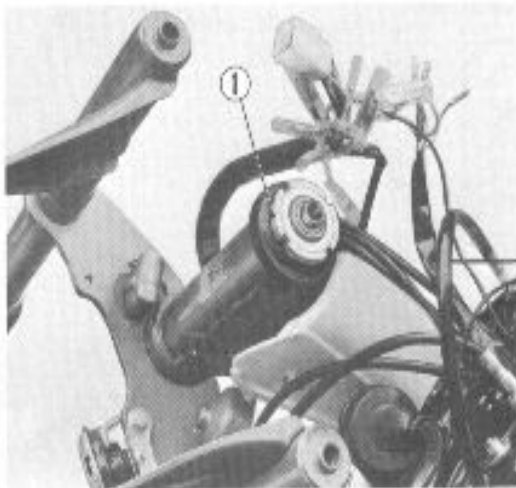

① Steering stem lock nut

When assembling the front forks, apply a liberal amount of grease on the steering ball races and assemble the steel balls 22 on the upper side and 18 on the lower side.

Exercise care installing the steering stem into the head pipe so that the steel balls are not dropped.

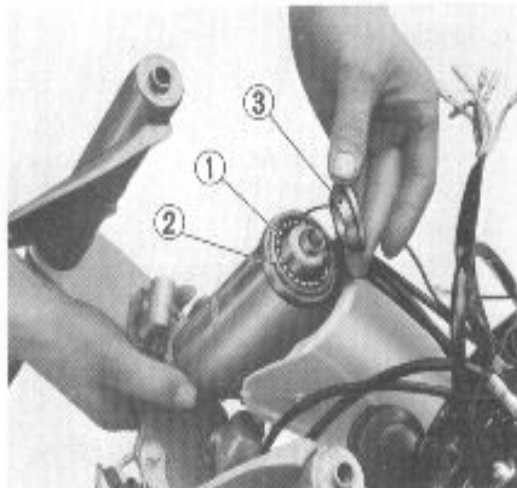

① Steel ball ② Steel ball race ③ Steel ball cone race

Install the top cone race and dust seal. Screw in the steering stem lock nut so that there is no clearance between the steering stem and head pipe in the vertical direction so that the steering stem turns smoothly through the full range of travel.



7. Removing inner tube

Required tool:



Special tool
#09940-10122



Special tool
#09920-70111

Remove the inner tube nut,

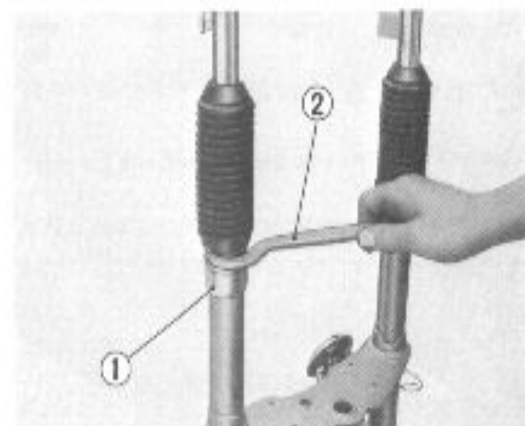

① Inner tube nut ② Steering stem lock nut wrench

When assembling the inner tube to the outer tube apply a liberal amount of grease to the springs.

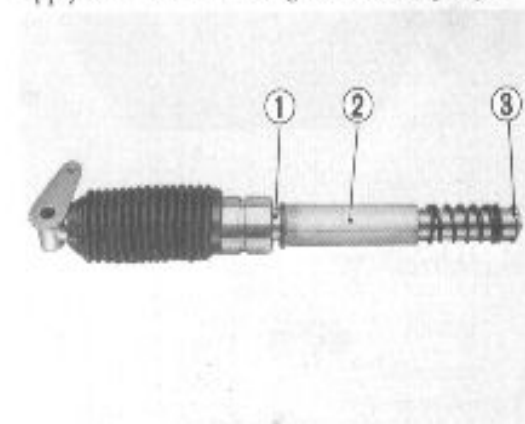

① Inner tube ② Inner tube guide
③ Spring guide

Front and Rear Wheels

The RV50 is equipped with 5.4 - 10 4PR low pressure tires. These tires are designed specifically for both off-the-road and paved road use.

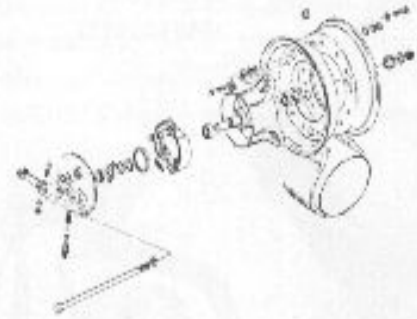
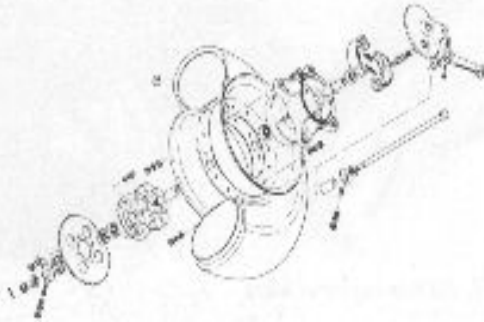

Disassembly and assembly

♦ Front wheel

1. Loosening front axle nut

Required tool:

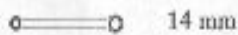

Remove the front axle nut and pull out the axle.

2. Removing front wheel



3. Removing rim from wheel hub

Required tool:



Tightening torque:

150 ~ 200 kg-cm (11 ~ 14 ft-lb)

Deflate the tire and loosen the wheel hub nuts.

46



4. Splitting rim

Required tool:



Tightening torque:

150 ~ 200 kg-cm (11 ~ 14 ft-lb)

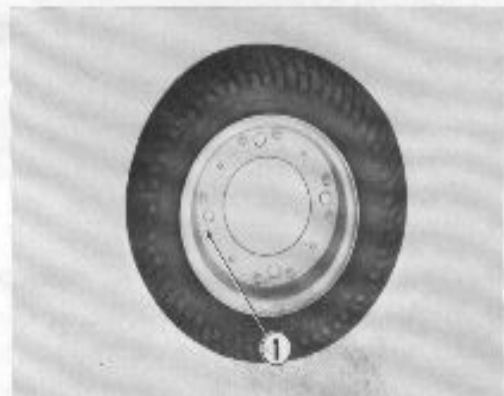

○ Wheel nut

* Rear wheel

1. Removing torque link nut

Required tool:

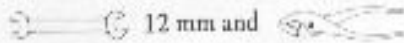

Tightening torque:

90 ~ 140 kg-cm (6.6 ~ 10 ft-lb)

Pull out the "β" type pin and loosen the torque link nut.

2. Loosening brake adjusting nut

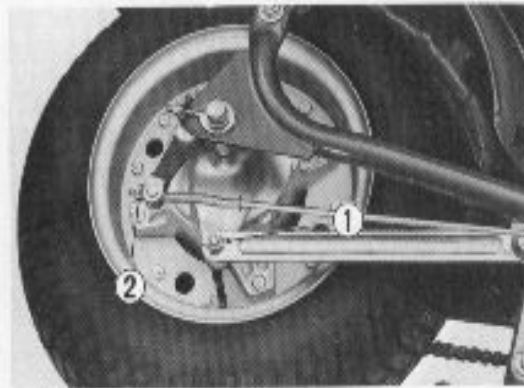

① "β" type pin ② Brake adjusting nut

3. Removing cotterpin and rear axle nut

Required tool:

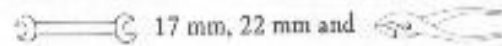

Tightening torque:

270 ~ 430 kg-cm (20 ~ 31 ft-lb)

Pull out the rear axle nut and remove the rear wheel

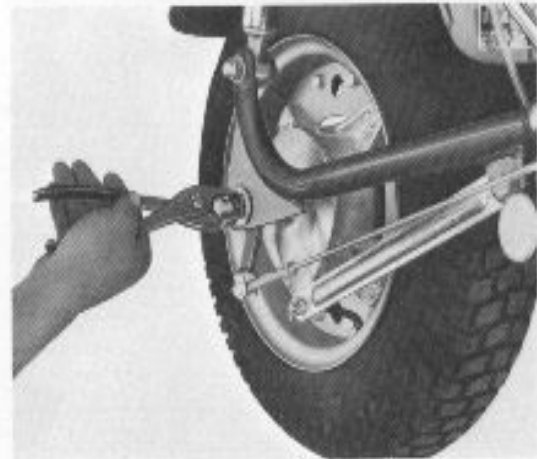

4. Disassembling rear wheel

Carry out the same procedure as the front wheel.

In order to have the wheel tire turn without slipping on the rim, a large friction force is required on the mating surface of rim and tire. This force is caused by the inside air pressure which presses the tire edge to the rim. As the tire used on this model is inflated with a low pressure, the force of the tire to press the rim is also small. In order to get enough friction force without high air pressure, the wheel is specially designed and care is made. However, the rim might slip if the maintenance is not done properly, therefore, be sure to do the following necessary points when assembling or disassembling the wheel.

Caution:

1. Do not use any tool such as a tire lever to insert between rim and tire when taking off the tire from the rim.
2. The tire should be removed from the rim by splitting it in half.
3. The edge of tire and rim (where they meet) should be always kept clean in order to have them stick rigidly by their surfaces.
4. When joining the rim, be sure not to pinch the inner tube. It is good practice to inflate the tire slightly.
5. After assembling the wheel and fitting it to the brake drum, inflate the tire to a pressure of about 2.0 kg/cm (29 psi) so that the tire settles properly in the rim. Then deflate it until the normal pressure.

Road condition	Front	Rear
Paved road	0.8 kg/cm (11 psi)	1.0 kg/cm (14 psi)
Off-the-road	0.6 kg/cm (8 psi)	0.8 kg/cm (11 psi)

6. When installing the front and rear wheels to the front forks and rear swinging arms, be sure to put them in correctly with the air valves faced toward the right side respectively.

Rear Shock Absorber

The hydraulic damper is of sealed construction and works at a damping resistance of 30 and 6 kg/0.5 m/sec in its tension and compression strokes respectively. The construction is shown in the figure and the graph show the relationship of spring load and travel.

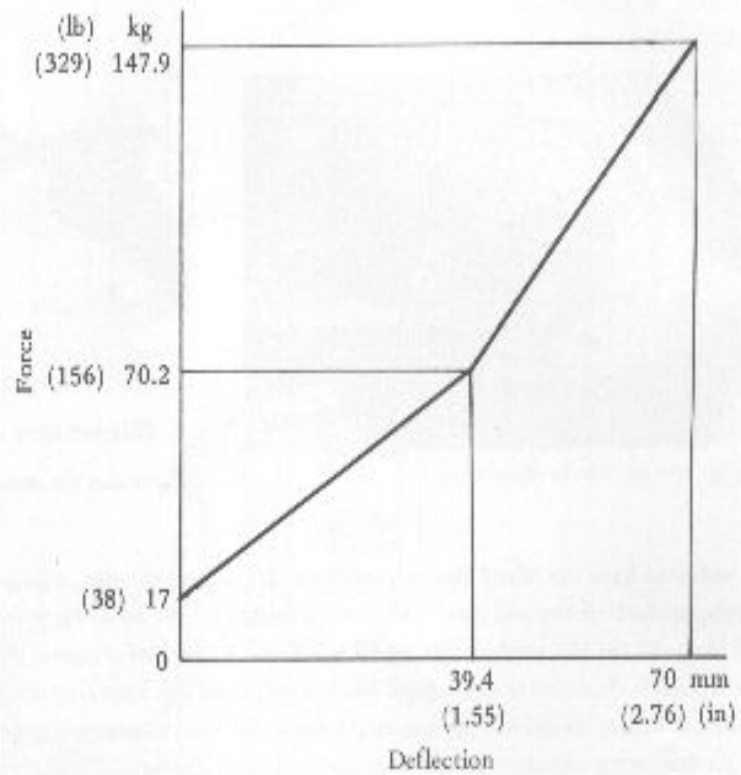
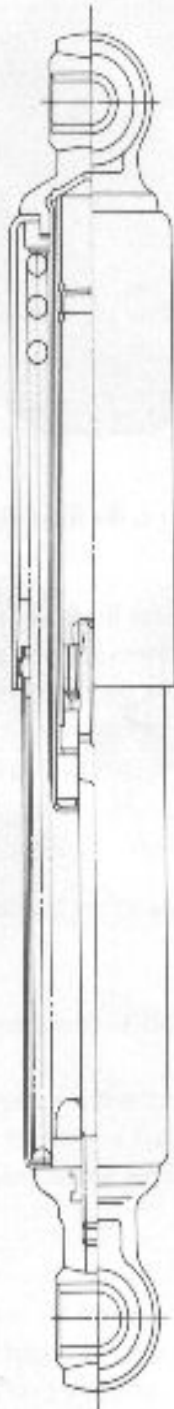

11. SPECIFICATIONS FOR INSPECTION AND REPAIR

Engine

Part	Item	Standard	Limit	Operation	Remarks
Cylinder head	Warp on the joining surface	below 0.03 mm (0.001 in)		Rectify	Put emery paper on a flat surface plate and grind the head on the paper by sliding it evenly back and forth
Cylinder	Wear		0.05 mm (0.002 in)	Rebore	Measurement is the difference between largest and smallest diameter of the bore.
	Cylinder-piston clearance	0.075 mm (0.002 in)	0.125 mm (0.0049 in)		Measure the piston diameter at 23 mm (0.9 in) above the piston skirt in the direction perpendicular to the piston pin hole.
Piston ring	Open end	0.10 - 0.30 mm (0.004 - 0.012 in)	1.0 mm (0.004 in)	Replace	Measure the gap with a thickness gauge when the ring is inserted into the lower part of cylinder.
Crankshaft	Con-rod small end shake		3 mm (0.12 in)	Replace	Check the shake at TDC with dial guage.
	Radial run out	below 0.06 mm (0.0024 in)		Rectify or replace	Check run out at left and right ends with dial gauge when both journal positions are held.
Clutch drive plate	Thickness	3 mm (0.12 in)	2.8 mm (0.11 in)	Replace	
	Warp	below 0.4 mm (16/1,000 in)		Replace	
Clutch driven plate	Warp	below 0.1 mm (0.004 in)		Replace	

Part	Item	Standard	Limit	Operation	Remarks
Flywheel magneto	Resistance, primary coil	2.0Ω		Replace	Measure between black colored wire and the ground when inserting a insulating material to the points.
	Resistance, charging coil	0.7Ω		Replace	Measure between green colored wire and ground
	Condenser capacity	0.18μF		Replace	
	Lighting coil output			Replace	With the ignition switch in night time position
	Charging capacity in day time			Replace	With fully charged battery
	Charging capacity in day time			Replace	With fully charged battery
	Charging capacity in night time			Replace	With fully charged battery
	Ignition performance	over 7 mm (0.276 in)		Replace	The testing gap is to be connected in series with spark plug.
	Contact point gap	0.3 ~ 0.4 mm (0.012 ~ 0.016 in)		Adjust	
Ignition coil	Resistance, primary coil	2.5Ω		Replace	
	Resistance secondary coil	8.3Ω		Replace	
Rectifier	Conductivity	Not in reverse direction		Replace	
Resistor	Resistance	5.6 ~ 6.4Ω		Replace	

Body

Part	Item	Standard	Limit	Operation	Remarks
Brake shoe	Wear		Front & Rear 106 mm (4.17 in)	Replace	Measure the diameter when the shoes are installed in place
Brake drum	Wear	Front & Rear 110 mm (4.33 in)	Front & Rear 110.7 mm (4.36 in)	Replace	
Drive chain	Slack	15-20 mm (0.6-0.8 in)		Adjust	
Tire	Wear in Depth		Front & Rear 1.6 mm (0.06 in)	Replace	

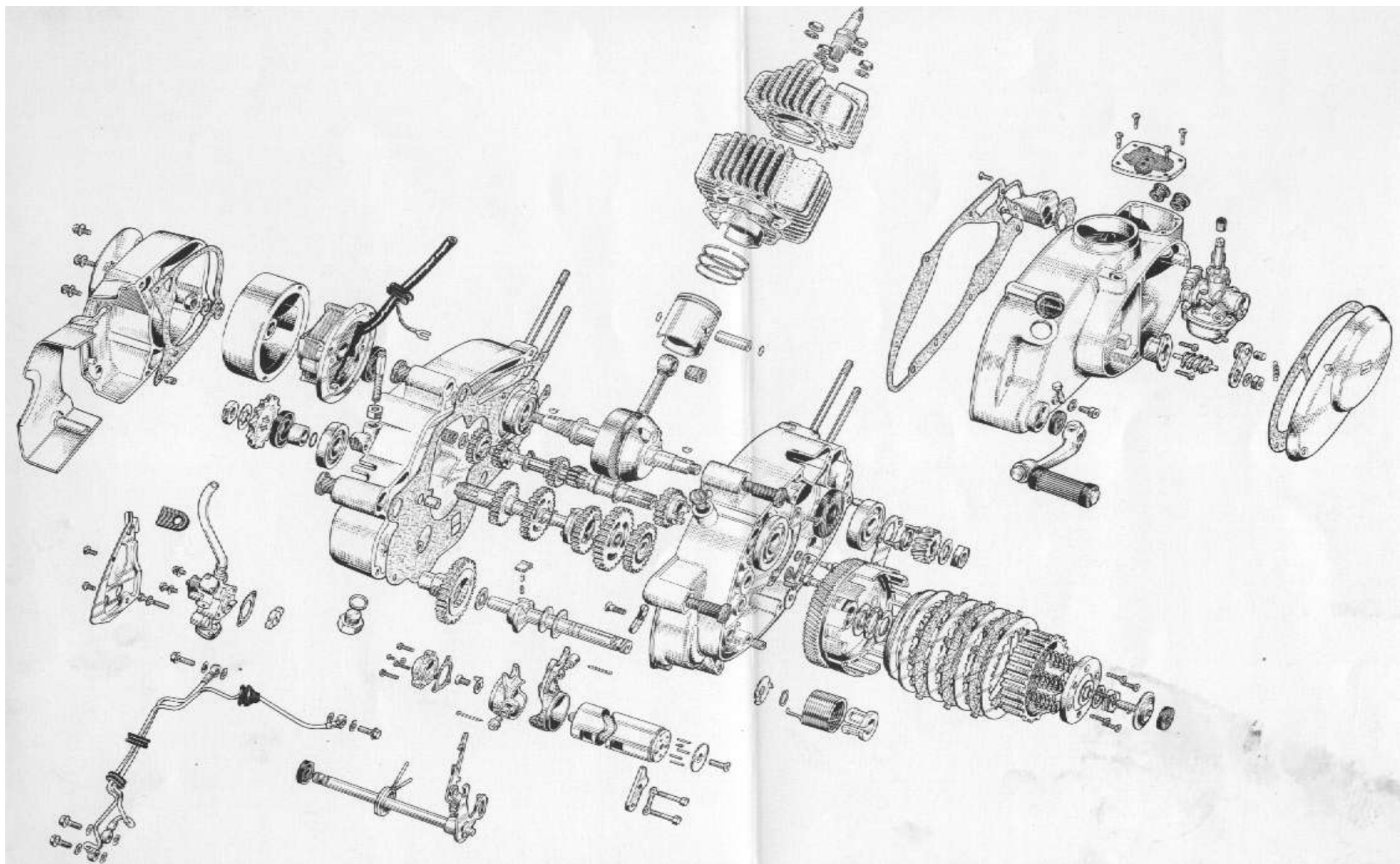

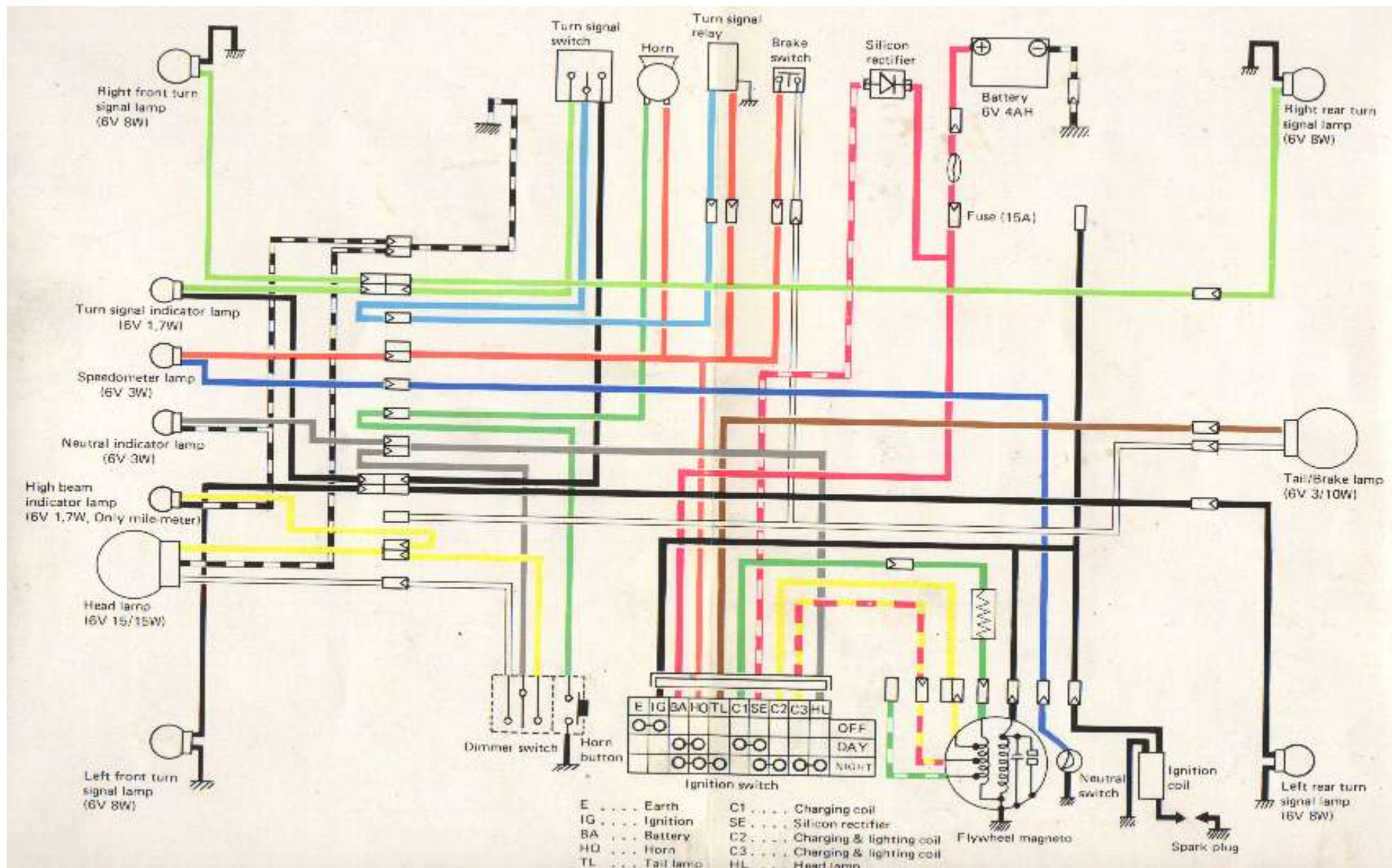

WIRING DIAGRAM SCHEMA DE CABLAGE VERDRÄHTUNGSSCHEMA

(For Norway)

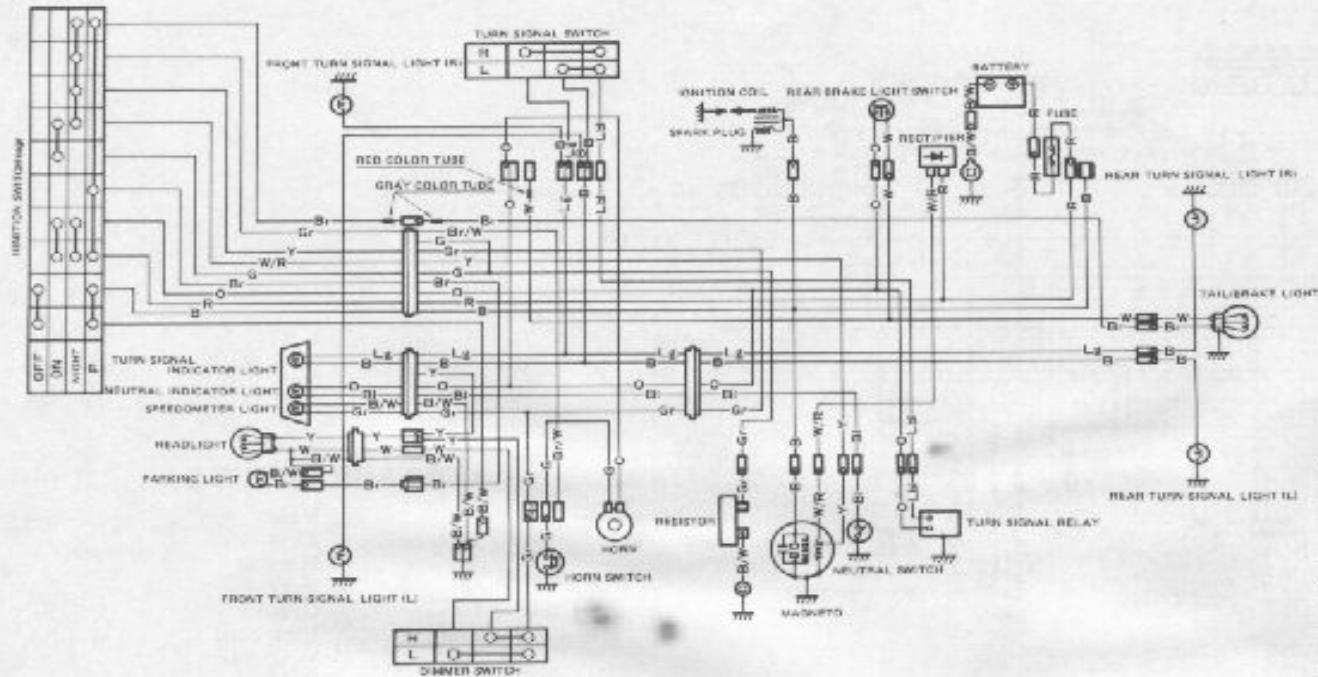

WIRE COLOR

B	Black
Bl	Blue
Br	Brown
G	Green
Gr	Gray
Lbl	Light blue
Lg	Light green
O	Orange
R	Red
W	White
Y	Yellow
B/W	Black with White tracer
Br/W	Brown with White tracer
W/R	White with Red tracer
Y/R	Yellow with Red tracer

(Pour la Belgique)

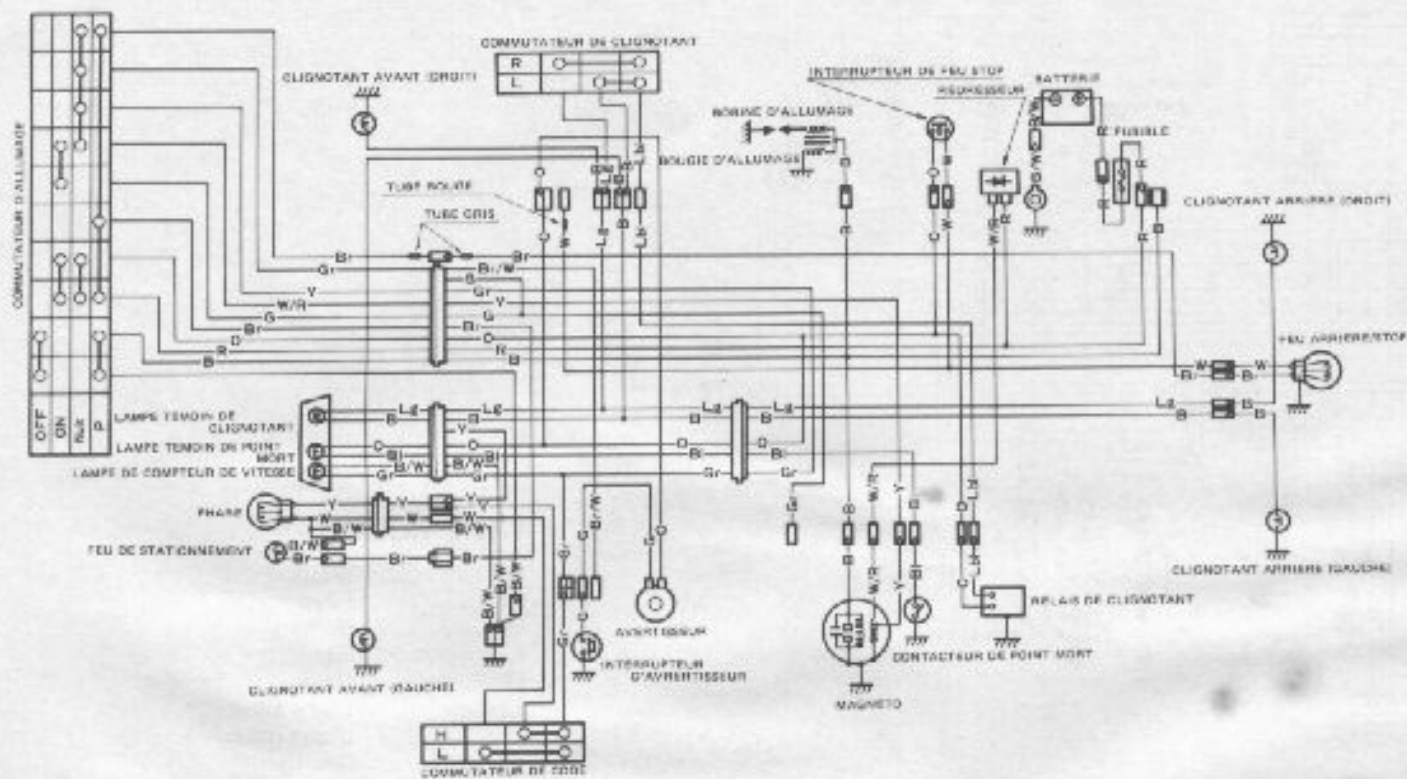

COULEUR DES FILS

B	Noir
Bl	Bleu
Br	Marron
G	Vert
Gr	Gris
Lbl	Bleu clair
Lg	Vert clair
O	Orange
R	Rouge
W	Blanc
Y	Jaune
B/W	Noir avec filet blanc
Br/W	Marron avec filet blanc
W/R	Blanc avec filet rouge
Y/R	Jaune avec filet rouge

(Pour la Suisse)
(Für Schweiz)

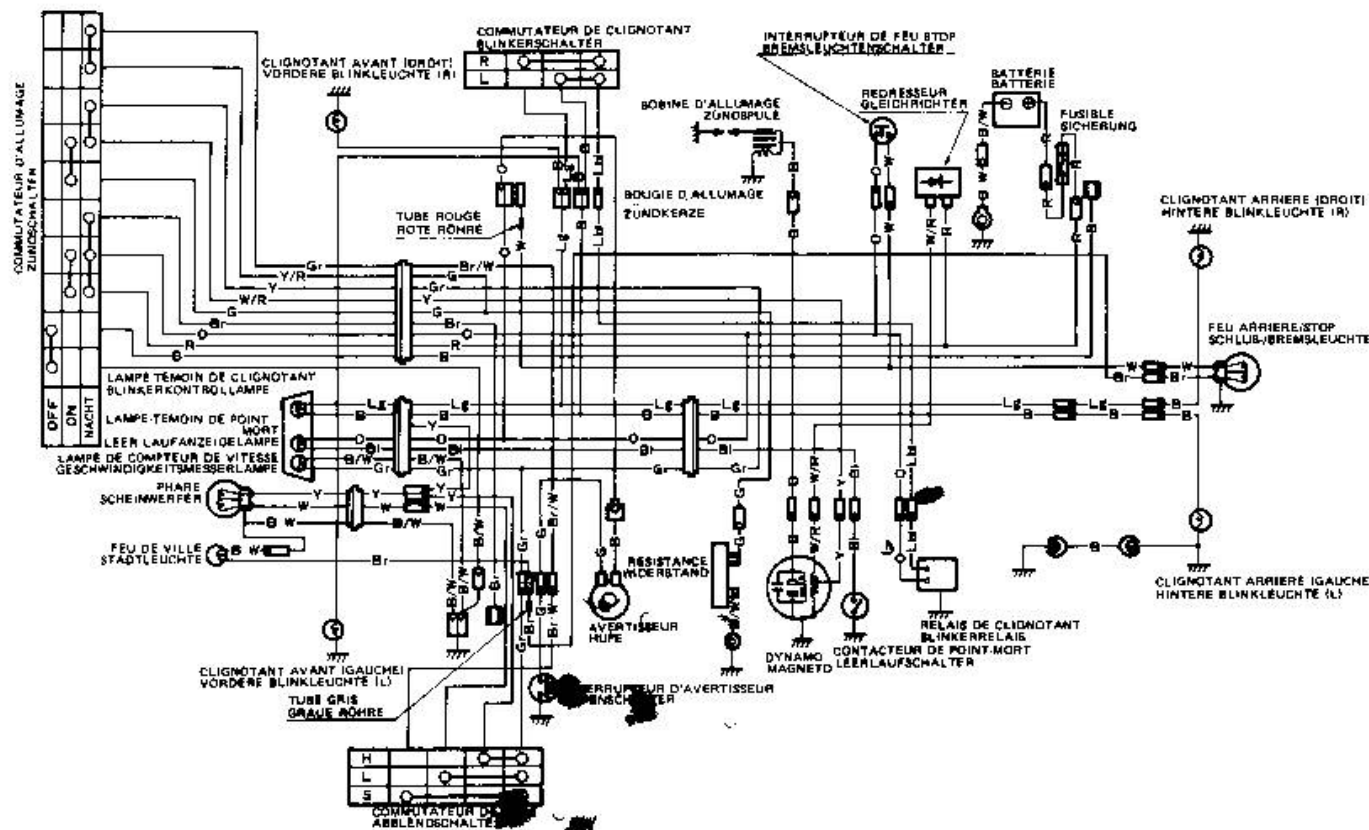

COULEUR DES FILS

B	Noir
Bl	Bleu
Br	Marron
G	Vert
Gr	Gris
Lbl	Bleu clair
Lg	Vert clair
O	Orange
R	Rouge
W	Blanc
Y	Jaune
B/W	Noir avec filet blanc
Br/W	Marron avec filet blanc
W/R	Blanc avec filet rouge
Y/R	Jaune avec filet rouge

DRAHTFARBE

B	Schwarze
Bl	Blau
Br	Braun
G	Grün
Gr	Grau
Lbl	Hellblau
Lg	Hellgrün
O	Orange
R	Rot
W	Weiß
Y	Gelb
B/W	Schwarz mit Weiß
Br/W	Braun mit Weiß
W/R	Weiß mit Rot
Y/R	Gelb mit Rot

(Pour la Autriche)
(Für Österreich)

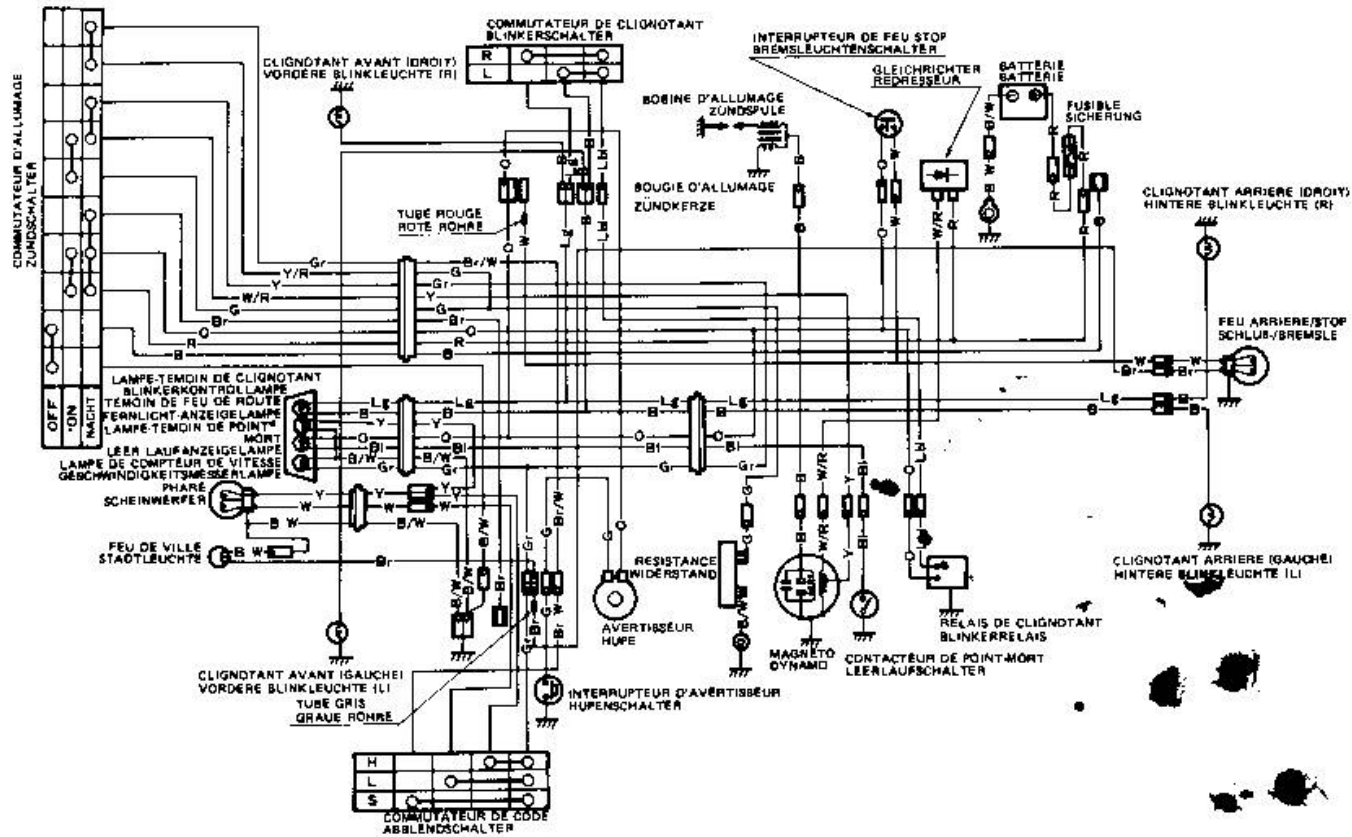

COULEUR DES FILS

B	Noir
Bl	Bleu
Br	Marron
G	Vert
Gr	Gris
Lbl	Bleu clair
Lg	Vert clair
O	Orange
R	Rouge
W	Blanc
Y	Jaune
B/W	Noir avec filet blanc
Br/W	Marron avec filet blanc
W/R	Blanc avec filet rouge
Y/R	Jaune avec filet rouge

DRAHTFARBE

B	Schwarze
Bl	Blau
Br	Braun
G	Grün
Gr	Grau
Lbl	Hellblau
Lg	Hellgrün
O	Orange
R	Rot
W	Weiß
Y	Gelb
B	Schwarz mit Weiß
Br/W	Braun mit Weiß
W/R	Weiß mit Rot
Y/R	Gelb mit Rot

(Für BRD)

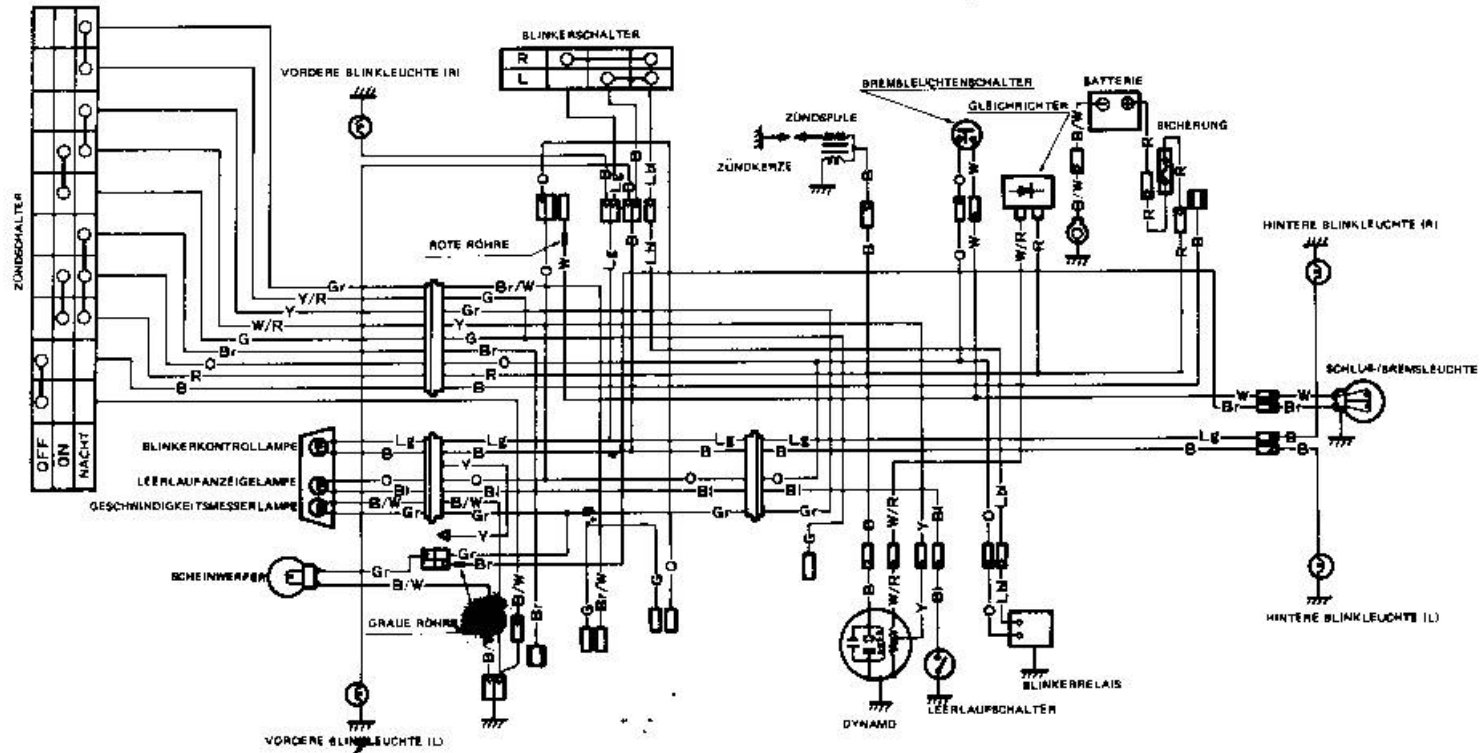

DRAHTFARBE

B	Schwarze	R	Rot
Bl	Blau	W	Weiß
Br	Braun	Y	Gelb
G	Grün	B/W	Schwarz mit Weiß
Gr	Grau	Br/W	Braun mit Weiß
Lbl	Hellblau	W/R	Weiß mit Rot
Lg	Hellgrün	Y/R	Gelb mit Rot
O	Orange			

(For other markets)
(Pour les autres marchés)

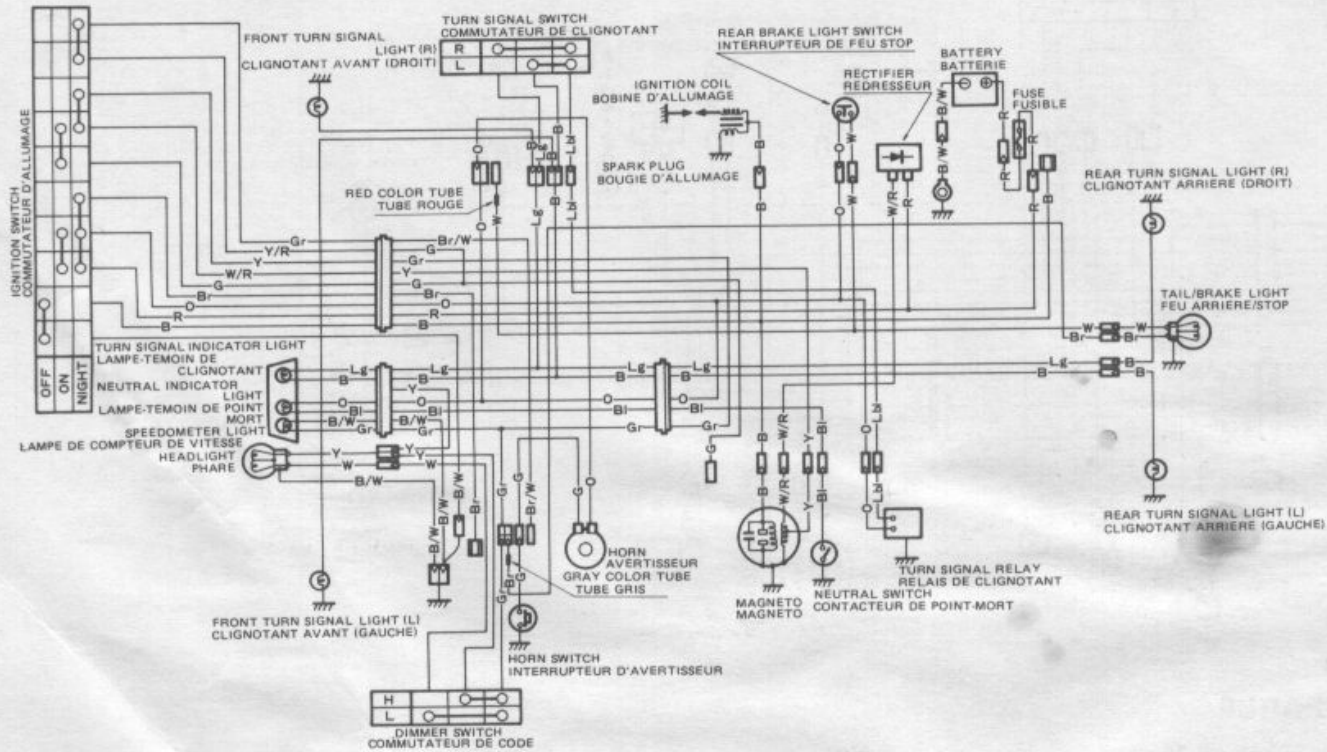

WIRE COLOR

B	Black
Bl	Blue
Br	Brown
G	Green
Gr	Gray
Lbl	Light blue
Lg	Light green
O	Orange
R	Red
W	White
Y	Yellow
B/W	Black with White tracer
Br/W	Brown with White tracer
W/R	White with Red tracer
Y/R	Yellow with Red tracer

COULEUR DES FILS

B	Noir
Bl	Bleu
Br	Marron
G	Vert
Gr	Gris
Lbl	Bleu clair
Lg	Vert clair
O	Orange
R	Rouge
W	Blanc
Y	Jaune
B/W	Noir avec filet blanc
Br/W	Marron avec filet blanc
W/R	Blanc avec filet rouge
Y/R	Jaune avec filet rouge

TECHNISCHE DATEN

ABMESSUNGEN UND GEWICHT

Gesamtlänge	1 625 mm
Gesamtbreite	775 mm
Gesamthöhe	985 mm
Achsabstand	1 095 mm
Bodenfreiheit	125 mm
Leergewicht	75 kg

MOTOR

Typ	Luftgekühlter Zweitakt-Benzinmotor
Einlasssystem	Zungenventil
Zylinderzahl	1
Bohrung	41,0 mm
Hub	37,8 mm
Hubraum	49 cm ³
Verdichtungsverhältnis	6,3 : 1
Vergaser	MIKUNI VM14SC, Einzelvergaser
Luftfilter	Polyurethanschaum-Einsatz
Anlassersystem	Primärkickstarter
Schmiersystem	SUZUKI "CCI"

SCHALTGETRIEBE

Kupplung	Lamellenaßkupplung
Getriebe	4-Gang-Dauereingriffgetriebe
Gangwechselschema	Alle hinunter
Primäruntersetzung	3,842 (73/19)
Enduntersetzung	2,133 (32/15)
	2,769 (36/13) (Für BRD)
	2,923 (38/13) (Für Belgien und Österreich)
Ganguntersetzung	1. Gang.. 3,666 (44/12)
	2. Gang.. 2,200 (33/15)
	3. Gang.. 1,578 (30/19)
	4. Gang.. 1,240 (31/25)
Antriebskette	DAIDO oder TAKASAGO #420, 96 Glieder
	DAIDO oder TAKASAGO #420, 98 Glieder (Für Belgien, BRD und Österreich)

FAHRGESTELL

Vorderradaufhängung	Teleskopgabel, ölgedämpft
Hinterradaufhängung	Schwinge, ölgedämpft
Steuerwinkel	43° (rechts und links)
Vorlauf	63°
Nachlauf	60 mm
Wenderadius	1,7 m
Vorderradbremse	Innenausdehnungsbremse
Hinteradbremse	Innenausdehnungsbremse
Vorderreifengröße	5,4-10 4PR
Hinterreifengröße	5,4-10 4PR 5,4-10 8PR (Für BRD und Österreich)

ELEKTRISCHE AUSRÜSTUNG

Zündung	Magnetzündler
Zündzeiteinstellung	20° vor oberem Totpunkt
Zündkerze	NGK BP6HS oder Nippon Denso W20FP
Batterie	6V 14,4 kC (4 Ah)/10 Stunden
Lichtmaschine	Schwungrad Dynamo
Sicherung	15A
Scheinwerfer	6V 25/25W 6V 15W (Für BRD)
Rück-/Bremsleuchte	6V 5/21W
Blinkerlampe	6V 21W 6V 10W (Für Österreich)
Drehzahlmesserlicht	6V 3W

Leerlauf-Anzeigelampe	6V 3W
Blinkerkontrollampe	6V 3W
Parking (Stadt) leuchte	6V 4W (Au-erhald für BRD)

FÜLLMENGEN

Benzintank einschließlich	
Reserve	3,5 L
Reserve	0,5 L
Motoröltank	0,7 L
Vordergabelöl	90 ml
Getriebeöl	500 ml

concessionnaire Suzuki avant de procéder au changement. La sélection d'une bougie incorrecte peut occasionner des dégâts importants du moteur. Des bougies de marques autres que NGK ou Nippon Denso peuvent également entraîner de difficultés de fonctionnement. Avant de choisir une marque, consulter le concessionnaire Suzuki.

ZÜNDKERZE

Eine stark mit Kohlenstoffablagerungen oder sonstwie verschmutzte Zündkerze kann keine kräftigen Funken erzeugen. Kohlenstoffablagerungen mit einem Draht oder einer Nadel entfernen und einer Dickenlehre auf 0,6 – 0,8 mm im Fall von NGK und NIPPON DENSO einstellen.

Bei der normalen Zündkerze für dieses Motorrad handelt es sich um die NGK BP6HS oder NIPPON DENSO W20FP. Falls die normale Zündkerze für eine bestimmte Fahrweise ungeeignet ist, d.h. eine Neigung zum Überhitzen zeigt (das Porzellan sieht weißlich aus) oder naß wird (schwarzes Aussehen), diese auf die folgende Weise auswechseln.

VORSICHT: Die normalen Zündkerzen für dieses Motorrad sind sorgfältig so ausgewählt worden, daß sie für die meisten Betriebslagen voll geeignet sind. Falls die Farbe der Zündkerze anzeigt, daß eine andere Art von Zündkerze mit Ihrem Suzuki-Fachhändler zu besprechen. Die Wahl einer ungeeigneten Zündkerze kann

beträchtlichen Schaden am Motor verursachen. Benutzung von nicht von NGK oder Nippon Denso hergestellten Zündkerzen kann auch zu Schwierigkeiten beim Betrieb führen. Daher sollten Sie Ihren bevollmächtigten Suzuki-Händler vor Wahl einer anderen Zündkerzen-marke befragen.

Plug replacement guide

Guide replacement de la bougie

Anleitung zum Auswechseln von Zündkerzen

NGK	ND	GUIDE	GUIDE	WIE ZU VERWENDEN
BP5HS	W16FP	To replace standard plug tending to get wet. Si la bougie normale a tendance à être humide, remplacez-la par cette bougie. Zum Auswechseln gegen normale Zündkerzen, die zum Naßwerden neigen.		
BP6HS	W20FP	Standard	Normale	Normal-Zündkerze
BP7HS	W22FP	To replace standard plug tending to overheat. Si la bougie normale a tendance à chauffer, remplacez-la par cette bougie. Zum Auswechseln gegen Zündkerzen, die zum Überhitzen neigen.		

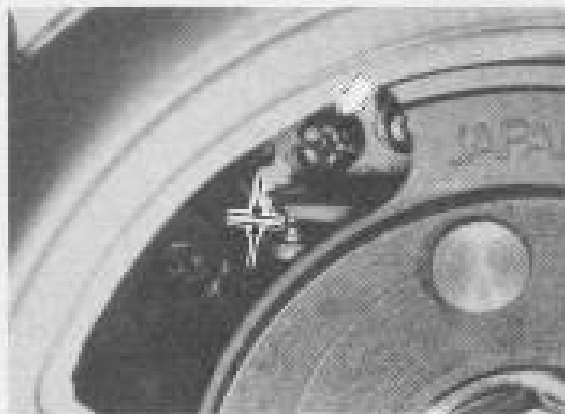
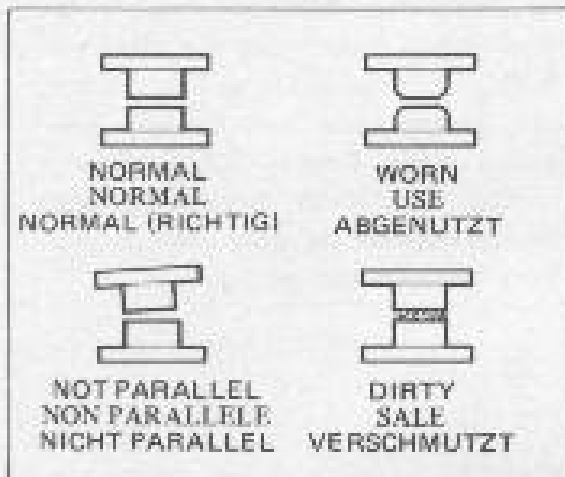

IGNITION TIMING

Check the ignition point gap and timing at the initial 1 000 km (600 miles) and every 3 000 km (2 000 miles) thereafter. Replace the contact points every 12 000 km (8 000 miles).

IGNITION CONTACT POINTS

Inspect the point faces for oil residue, dirt, burning or pitting. If the contact faces are dirty, clean with a suitable electric contact spray product or with a clean piece of thin cardboard. Pitted or burnt contacts can be repaired by filing smooth or if severely damaged by replacement.

After thorough cleaning, inspect the contacts for proper alignment. Bend the moveable arm if necessary to re-align the point faces.

Check the contact point gap as follows:

- (1) Remove the spark plug.
- (2) Turn the flywheel over slowly until the points are at the widest position.
- (3) Measure the point gap with a feeler gauge. The gap should be 0.3 – 0.4 mm (0.012 – 0.016 in). Loosen screw and increase or decrease the gap as necessary.

- (4) Re-tighten the point screws and re-check the gap.

AVANCE A L'ALLUMAGE

Vérifiez l'écartement des points d'allumage et l'avance à l'allumage au cours de l'inspection après les 1 000 km (600 milles) initiaux et ensuite tous les 3 000 km (2 000 milles). Remplacer points de contact tous les 12 000 km (8 000 milles).

POINTS DE CONTACT D'ALLUMAGE (RUPTEUR)

Vérifiez l'aspect des surfaces de points de contact pour noter la présence de traces d'huile, de piqûres ou de brûlures. Si les surfaces des points de contact sont sales, nettoyez-les à l'aide d'un morceau de carton fin et propre ou d'un produit atomisé de nettoyage. On peut réparer des contacts piqués ou brûlés à l'aide d'une lime douce ou s'ils sont trop endommagés, il faut les changer.

Après nettoyage minutieux, vérifiez le bon alignement des points de contact. Courbez légèrement le bras mobile au besoin pour reprendre l'alignement.

Vérifiez l'écartement des points de contact de la manière suivante.

- (1) Déposez la bougie.
- (2) Tournez le volant lentement jusqu'à ce que les points soient à leur écartement maximum.
- (3) Mesurez l'écartement à l'aide d'un palpeur. L'écartement doit être de 0,3 à 0,4 mm (0,012 à 0,016 in). Desserrez la vis et augmentez ou réduisez le jeu.
- (4) Resserrez les vis des points de contact et vérifiez à nouveau l'écartement.

ZÜNDZEITPUNKTEINSTELLUNG

(Außer für der Malaischen Bund)

Die Zündkerzenpunktöffnung und die Zündzeitpunkteinstellung bei der Wartung nach den ersten 1 000 km, und danach alle 3 000 km prüfen. Man soll alle 12 000 km die Kontaktstelle wechseln.

ZÜNDKONTAKTSPITZEN

Die Spitzen auf Ölrückstände, Schmutz, verbrannte oder zerfressene Stellen prüfen. Wenn die Kontaktflächen schmutzig sind, müssen sie mit einem geeigneten Spray oder mit einem sauberen und dünnem Stück Pappe gereinigt werden. Angefressene oder verbrannte Kontakte können durch Abfeilen repariert werden, oder sind auszuwechseln, falls der Schaden zu groß hierfür ist.

Nach sorgfältiger Reinigung sind die Kontakte auf genaues Ausrichten zu prüfen. Falls notwendig kann der bewegliche Arm gebogen werden, um die Kontaktflächen ordnungsgemäß auszurichten.

Der Abstand der Kontaktflächen ist wie folgt zu prüfen:

- (1) Die Zündkerze herausnehmen.
- (2) Das Schwungrad langsam solange drehen, bis der Abstand zwischen den Unterbrecherkontakten am größten ist.

- (3) Den Kontaktabstand mittels einer Spaltlehre messen. Der Abstand soll 0,3 bis 0,4 mm betragen. Die Schraube lösen und den Abstand wie notwendig vergrößern oder verringern.
- (4) Die Kontaktpunktschraube wieder anziehen und den Abstand nochmals prüfen.

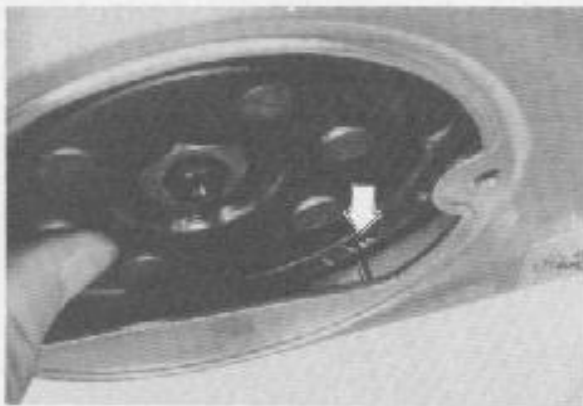

IGNITION TIMING PROCEDURE

Incorrect ignition timing decreases engine performance and shortens the life of the engine. Therefore, it is necessary to check the ignition timing periodically. When adjusting the ignition timing, adjust the contact point gap first and then adjust the ignition timing. If the ignition timing is adjusted first, adjusting the point gap will make the ignition timing incorrect again.

- (1) Remove the magneto inspection cap by loosening two fitting screws.
- (2) Turn the flywheel rotor by hand and find the position where the contact point gap is the largest.

- (3) Check the point gap with the feeler gauge (0.35 mm thick).
- (4) Turn the flywheel rotor counterclockwise to the point at which the contact points just begin to open.
- (5) Check to see if the index mark on the crankcase left cover aligns with the aligning mark on the flywheel rotor when the contact points just begins to open. If the aligning mark, is on the right side of the index mark, ignition timing is retarded. If the aligning mark is on the left side of the index mark, ignition timing is advanced.
- (6) If ignition timing is slightly retarded, adjust by setting the point gap larger than standard but not more than 0.4 mm (0.016 in).
- (7) If ignition timing is slightly advanced, adjust by setting the point gap smaller than standard but not less than 0.3 mm (0.012 in).
- (8) Check again to make sure the aligning mark aligns perfectly with the index mark.
If ignition timing can not be adjusted correctly by changing the point gap within the limits 0.3 – 0.4 mm (0.012

– 0.016 in), adjustment inside the magneto is required. Take your motorcycle to your Suzuki dealer's workshop and have it adjusted.

METHODE DU REGLAGE D'ALLUMAGE

Le mauvais minutage d'allumage baisse la performance du moteur et diminue sa vie. Il est donc nécessaire de vérifier le minutage d'allumage périodiquement. Quand vous réglez le minutage d'allumage, réglez d'abord l'écart des contacts et ensuite le minutage d'allumage. Si le minutage d'allumage est réglé d'abord, le réflage de l'écart des contacts perturbera encore une fois le minutage d'allumage.

- (1) Enlever le bouchon magnétique d'inspection en desserrant deux vis de fixation.
- (2) Tournez le rotor du volant à la main et trouvez la position à laquelle l'ouverture du point de contact est la plus large.
- (3) Vérifiez l'écart des contacts avec la jauge d'écart (0,35 mm d'épaisseur).
- (4) Tournez le rotor du volant contre le sens d'horloge jusqu'au point où les contacts commencent justement à s'ouvrir.

- (5) Vérifiez si la marque d'indice du couvercle gauche de la caisse de manivelle s'aligne avec la marque d'alignement du rotor du volant quand les contacts commencent justement à s'ouvrir. Si la marque d'alignement est au côté droit de la marque d'indice, minutage d'allumage est retardé. Si la marque d'alignement est au côté gauche de la marque d'indice, le minutage d'allumage est avancé.
- (6) Si le minutage est légèrement retardé, réglez l'écart des contacts plus large que la valeur nominale, mais pas plus que 0,4 mm (0,016 in).
- (7) Si le minutage est légèrement avancé, réglez l'écart des contacts plus étroit que la valeur nominale mais pas moins que 0,3 mm (0,012 in).
- (8) Vérifiez encore une fois l'alignement de la marque d'indice et la marque d'alignement jusqu'à ce qu'il devienne parfait. Si jamais le minutage ne peut pas être réglé par le réglage de l'écart des contacts dans les limites de 0,3 – 0,4 mm (0,012 – 0,016 in), le réglage à l'intérieur du magneto est nécessaire. Emmenez votre motocyclette chez votre négociant de Suzuki et faites régler cela.

ZÜNDZEITEINSTELLUNG

Falsche Einstellung des Zündzeitpunktes vermindert die Motorleistung und verringert seine Lebensdauer. Es ist daher notwendig, den Zündzeitpunkt in regelmäßigen Abständen zu überprüfen. Vor dem Einstellen des Zündzeitpunktes muss zunächst der Kontaktabstand überprüft und reguliert werden. Falls der Zündzeitpunkt zuerst eingestellt wird, macht das danach folgende Einstellen des Kontaktabstandes die Einstellung des Zündzeitpunktes wieder unrichtig.

- (1) Die Lichtmaschineninspektionhaube durch Lösen der zwei Befestigungsschrauben abnehmen.
- (2) Den Schwungradanker mit der Hand drehen, bis der Kontaktabstand am größten ist.
- (3) Den Kontaktabstand mit einer 0,35 mm dicken Fühlerlehre prüfen.
- (4) Den Schwungradanker mit der Hand entgegen dem Uhrzeigersinn bis zu der Stellung zu drehen, an welcher sich die Kontaktpunkte gerade zu öffnen beginnen.
- (5) Untersuchen, ob die Anzeigemarke auf der linken Seite des Gehäuses der Einstellmarke auf dem Schwungradanker genau gegenübersteht, wenn sich die Unterbrecherkontakte gerade öffnen. Falls sich die Einstellmarke rechts von der Anzeigemarke befindet, ist der Zündzeitpunkt verzögert. Falls

sich die Einstellmarke links von der Anzeigemarke befindet, ist der Zündzeitpunkt verfrüht.

- (6) Falls der Zündzeitpunkt geringfügig verzögert ist, kann dies durch Vergrößern des Kontaktabstandes bis zu höchstens 0,4 mm berichtigt werden.
- (7) Falls der Zündzeitpunkt geringfügig verfrüht ist, kann dies durch Verringerung des Kontaktabstandes bis zu höchstens 0,3 mm berichtigt werden.
- (8) Nach diesen Einstellungen ist wieder zu prüfen, dass die Einstellmarke sich genau gegenüber der Anzeigemarke befindet. Falls der Zündzeitpunkt nicht durch Verändern des Kontaktabstandes zwischen 0,3 bis 0,4 mm richtig eingestellt werden kann, ist eine Regulierung im Innern der Lichtmaschine notwendig. Bringen Sie in diesem Fall Ihr Motorrad zu Ihrem Suzuki Fachhändler, so daß er die richtige Einstellung vornehmen kann.

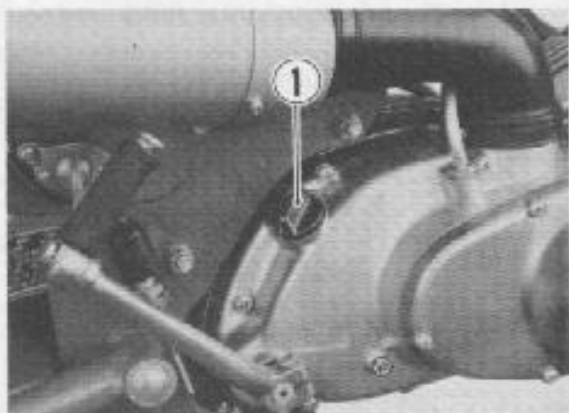

① Oil filler cap ① Öleinfülldeckel
① Remplissage d'huile

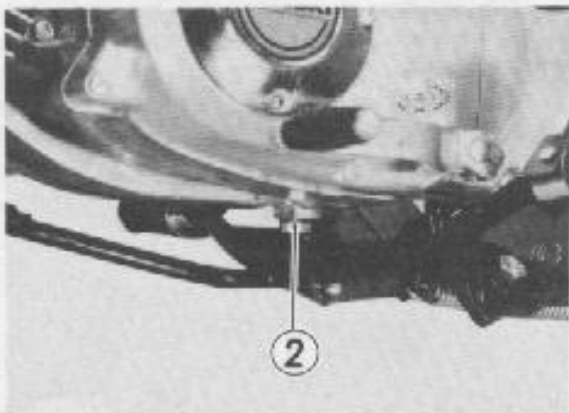

② Drain plug ② Ablaufschraube
② Bouchon de vidange

TRANSMISSION OIL

It is necessary to perform an oil change at the initial 1 000 km (600 miles) and every 3 000 km (2 000 miles) thereafter. When changing oil, drain the used oil from the crankcase while the engine is still warm. This will ensure complete and rapid draining.

- (1) Remove the drain plug located under the crankcase and allow oil to drain completely.
- (2) When the oil has drained, refit the drain plug.
- (3) Measure 700 ml (1.48/1.23 US/Imp pt) of SAE 20W/40 multigrade motor oil and pour it into the transmission slowly.
- (4) Refit the oil filler cap.

HUILE DE BOITE DE VITESSES

Il faut renouveler l'huile au bout des premiers 1 000 km (600 miles) et ensuite tous les 3 000 km (2 000 miles). Pour le changement d'huile, vider le carter d'huile usée pendant que le moteur est encore chaud. Cette façon de procéder permettra une vidange rapide et complète.

- (1) Déposer le bouchon de vidange situé sous le carter moteur et laisser patir toute l'huile.
- (2) Après purge complète, remettre en place le bouchon de vidange.
- (3) Mesure une quantité de 700 ml (1,48/1,23 US/Imp pt) d'huile de moteur multigrade SAE 20W/40 et la verser lentement dans la boîte de vitesses.
- (4) Remettre en place le bouchon de remplissage d'huile.

GETRIEBEÖL

Nach den ersten 1 000 km und danach alle 3 000 km muß das Getriebeöl gewechselt werden. Das alte Öl wenn möglich in warmem Zustand ablaufen lassen, um komplettes und schnelles Ablaufen zu garantieren.

- (1) Ablaufschraube unter dem Kupplungsgehäuse entfernen und das Öl komplett ablaufen lassen.
- (2) Nach Ablaufen des Öls, die Ablaufschraube wieder einsetzen.
- (3) 700 ml SAE 20W/40 multigrad Motoröl abmessen und langsam in das Getriebe einfließen lassen.
- (4) Öleinfülldeckel wieder aufsetzen.

VERGASER

Eine ungehinderte Vergasung des Kraftstoffs ist die Grundlage für die Leistung, die Sie von Ihrer Maschine erwarten können. Der Vergaser wurde im Werk auf optimale Vergasung eingestellt. Versuchen Sie nicht, die Einstellung zu verändern. Zwei Punkte sind jedoch vorhanden, deren Einstellung Ihre Beachtung erfordert: die Leerlaufdrehzahl und das Gasseilzugspiel.

Einstellen der Leerlaufdrehzahl:

- (1) Den Motor anlassen und warmlaufen lassen.
- (2) Nachdem der Motor warmgelaufen ist, die Leerlaufbegrenzungsschraube unter dem Vergaser entweder hineinoder herausdrehen, so daß der Motor bei $1\ 300 \pm 150$ U/min läuft.

VORSICHT:

*SUZUKI empfiehlt, daß diese Einstellung von Ihrem autorisierten SUZUKI Fachhändler durchgeführt werden soll.

* Falls ein Drehzahlzähler zur Verfügung steht, dann kann diese Einstellung gemäß nachfolgender Beschreibung selbst durchgeführt werden.

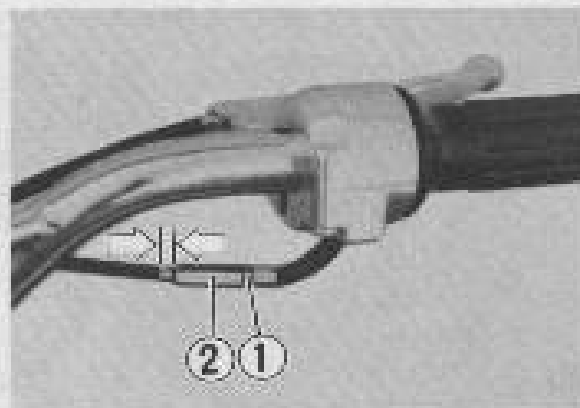

- | | |
|----------------|-------------------------------|
| ① Lock nut | ① Gegenmutter |
| ② Adjuster | ② Kupplungsseilzugseinsteller |
| ① Contre-écrou | |
| ② Régleur | |

THROTTLE CABLE ADJUSTMENT

- (1) Loosen lock nut.
- (2) Adjust the cable slack by turning adjuster in or out to obtain the correct slack 0.5 – 1.0 mm (0.02 – 0.04 in).
- (3) After adjusting the slack, tighten the lock nut.

CAUTION: This adjustment could affect the oil pump lever adjustment. Thereafter, readjust the oil pump lever cable as necessary.

AJUSTEMENT DU CÂBLE D'ACCELERATEUR

- (1) Desserrer le contre-écrou.
- (2) Ajuster le mou du câble en tournant le régleur dans un sens ou dans l'autre pour obtenir le mou correct entre 0,5 – 1,0 mm.
- (3) Après avoir ajusté le mou, resserrer le contre-écrou.

ATTENTION: Ce réglage peut affecter l'ajustement du levier de la pompe à huile. C'est pourquoi, il faut, le cas échéant, régler à nouveau le câble du levier de la pompe à huile.

EINSTELLUNG DES GASSEILS

- (1) Die Gegenmutter lockern.
- (2) Das Seilspiel mittels des Einstellers auf den richtigen Spielraum (0,5 – 1,0 mm) einstellen.
- (3) Nach dem Einstellen des Spielraums die Gegenmutter anziehen.

VORSICHT: Diese Einstellung könnte die Einstellung des Ölpumpeneinstellhebels verstellen.

Stellen Sie daher das Kabel des Ölpumpenhebels falls notwendig neu ein.

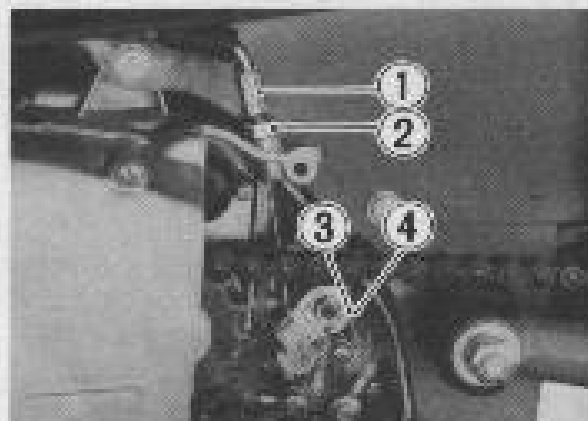
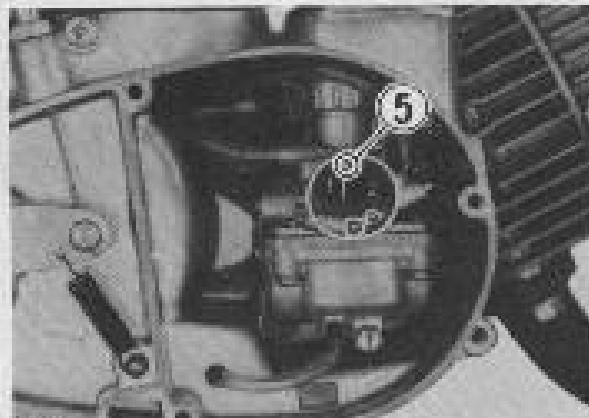

- ① Adjuster
 - ② Lock nut
 - ③ Mark
 - ④ Index mark
 - ⑤ Throttle valve dent mark
- ① Tendeur
 - ② Contre-écrou
 - ③ Repère
 - ④ Index
 - ⑤ Repère du boisseau
- ① Einsteller
 - ② Kontermutter
 - ③ Einstellmarke
 - ④ Indexmarke
 - ⑤ Drosselklappen- Zackenmarkierung

OIL PUMP

Adjust the oil pump control cable with the cable adjuster at initial 1 000 km (600 miles) and every 3 000 km (2 000 miles) so that aligning mark aligns to the index mark when the throttle valve dent mark is at the upper part of the carburetor alignment hole by turning throttle grip. Be sure to secure the adjuster with the lock nut.

The engine oil is fed by the oil pump to the inside of engine. The amount of oil fed to these areas is regulated by engine speed and the oil pump control lever which is controlled by the amount of throttle opening.

CAUTION: Oil pump cable adjustment must be done after throttle cable adjustment.

POMPE A HUILE

Régler le câble de commande de la pompe à huile à l'aide du tendeur après les 1 000 km (600 milles) initiaux et ensuite, tous les 3 000 km (2 000 milles). Régler de telle sorte que le repère d'alignement s'aligne avec le repère lorsque le repère à encoche du papillon des gaz se trouve à la partie supérieure du trou d'alignement du carburateur (procéder à ce réglage en tournant la poignée des gaz. Veiller à bloquer le tendeur avec l'écrou.

Grâce à la pompe à huile, l'huile de moteur est alimentée à l'intérieur de ce dernier. La quantité d'huile fournie aux différentes pièces internes est réglée par le régime du moteur et le levier de commande de la pompe d'huile, contrôlé par l'ouverture et la fermeture du papillon.

ATTENTION: Le réglage du câble de la pompe à huile doit se faire après celui du câble du papillon des gaz.

OLPUMPE

Das Ölpumpen-Kontrollkabel ist mittels des Kabeleinstellers nach den ersten 1 000 km und danach alle 3 000 km so einzustellen, daß die Einstellmarke auf die Indexmarke ausgerichtet ist, wenn bei Drehen des Gasgriffes die Drosselklappen-Zachenmarkierung sich am oberen Teil des Vergaserrichtloches befindet. Übersehen Sie nicht, nach beendeter Einstellung den Kabeleinsteller durch Anziehen der Gegenmutter zu sichern.

Das Motoröl wird von der Ölpumpe in das Innere des Motors gepumpt. Die Menge des gepumpten Motoröls wird durch die Motorgeschwindigkeit und den Ölpumpenkontrollhebel, der seinerseits wieder durch die Drosselöffnung reguliert wird, bestimmt.

VORSICHT: Die Regulierung des Ölpumpen kontrollkabels muß nach der Einstellung des Gaszugkabels erfolgen.

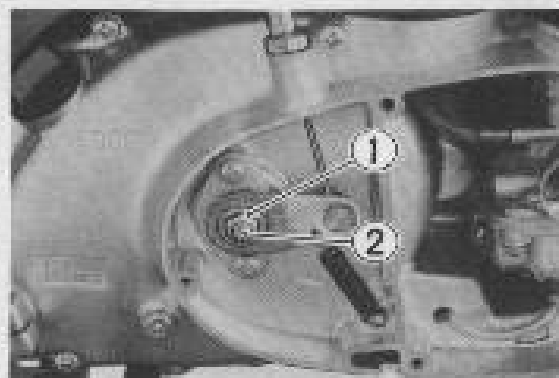
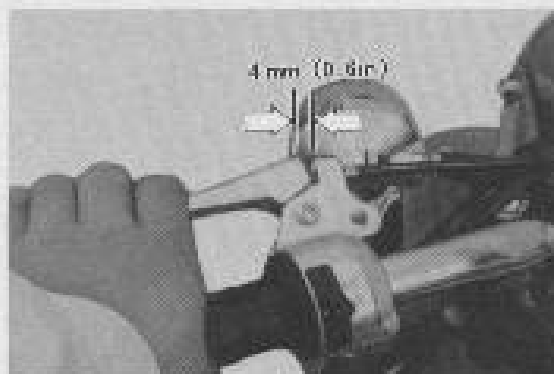

- ① Lock nut
- ② Adjuster
- ① Contre-écrou
- ② Tendeur
- ① Kontermutter
- ② Einsteller

CLUTCH ADJUSTMENT

The play of the clutch cable should be 4 mm (0.16 in) as measured at the clutch lever holder before the clutch begins to disengage. If you find the play of the clutch incorrect, adjust it in the following way:

- (1) Loosen the clutch cable adjuster lock nut.
- (2) Turn the clutch cable adjuster to provide the specified play (4 mm).
- (3) Tighten the lock nut.

At the same intervals, lubricate the clutch cable with motor oil.

EMBAYAGE

Régler l'embrayage à l'aide du tendeur du câble d'embrayage. Le jeu de l'embrayage doit être de 4 mm (0,16 in) quand on le porte-levier d'embrayage, avant que l'embrayage ne commence à se libérer. Si l'on constate que le jeu de l'embrayage n'est pas correct, le régler de la façon suivante.

- (1) Desserrer le contre-écrou du tendeur du câble d'embrayage.
- (2) Tourner le tendeur de façon à obtenir le jeu spécifié (4 mm).
- (3) Resserrer le contre-écrou.

KUPPLUNG

Die Kupplung mit Hilfe des Kupplungsseilzugeinstellers einstellen.

Das Spiel der Kupplung sollte, am Kupplungshebelhalter vor Ausrücken der Kupplung gemessen, 4 mm betragen. Bei falschem Kupplungsspiel wird dieses auf die folgende Weise korrigiert:

- (1) Die Kontermutter des Kupplungsseilzugeinstellers lösen.
- (2) Den Kupplungsseilzugeinsteller entsprechend drehen, um das vorgeschriebene Spiel (4 mm) zu erhalten.
- (3) Die Kontermutter festziehen.



FUSE

If there is a sudden halting of the engine while running or any electrical system failure then the fuse must be checked. In case the fuse blows there is one spare fuse, a 15A fuse.

CAUTION: Always be sure to replace the blown fuse with the correct amperage fuse. Never use a substitute, for example aluminum foil or wire, to replace a blown fuse. If the spare period of time it means that you could have a major electrical problem. You should consult your SUZUKI dealer immediately.

FUSIBLE

S'il se produit une halte soudaine du moteur en cours de fonctionnement ou une panne quelconque du circuit électrique, il convient alors de vérifier les fusibles. En cas où le fusible saute, il y a un fusible de rechange de 15A.

ATTENTION: Veiller à remplacer un fusible sauté par un autre de même ampérage. Ne jamais utiliser de substitut comme une feuille d'aluminium ou un fil pour effectuer le remplacement. Si le fusible remplacé saute après un court laps de temps, ce peut être le signe d'un problème important dans l'équipement électrique. Dans ce cas, consulter immédiatement un distributeur Suzuki.

SICHERUNG

Dort ist eine Sicherung Eingesetzt. Wenn der Motor während des Laufens plötzlich stehenbleibt oder die elektrische Anlage aussetzt, sind die Sicherungen zu prüfen. Falls die Sicherung durchgebrannt ist, gegen die vorhandene 15A Ersatzsicherung auswechseln.

VORSICHT: Immer darauf achten, daß eine durchgebrannte Sicherung gegen eine neue Sicherung mit der korrekten Amperezahl ausgewechselt wird. Niemals einen Ersatzgegenstand, wie z.B. ein Aluminiumblech oder einen Draht, zum Austausch einer durchgebrannten Sicherung verwenden. Falls auch die Ersatzsicherung nach dem Anzeichen für einen schweren elektrischen Schaden. Ziehen Sie umgehend ihren Suzuki-Fachhändler zu Rate.

TROUBLESHOOTING

If the engine refuses to start, perform the following inspections to determine the cause.

- (1) Is there enough fuel in the fuel tank?
- (2) Is the fuel reaching the carburetor from the fuel cock?
- (3) Disconnect the fuel line from the carburetor, and crank the engine for a brief moment and see if fuel still flows.
- (4) If it has been determined that fuel is reaching the carburetor, the ignition system should be checked next.

WARNING:

Do not allow the fuel to spill, catch the fuel in a container.



- (1) Remove a spark plug and re-attach it to the spark plug lead.
- (2) While holding the spark plug firmly against the engine, crank the engine with the ignition switch in the "ON" position. If the ignition system is operating properly, a blue spark should jump across the spark plug gap. If there is no spark, consult your Suzuki Dealer for repairs.

WARNING:

Do not hold the spark plug close to the open spark plug hole in the cylinder head as gasoline vapor inside the cylinder could be ignited, creating a fire hazard.

ENGINE STALLING

- (1) Check the fuel supply in the fuel tank.
- (2) Check the ignition system for intermittent spark.
- (3) Check the engine idle speed.

It is best to consult your Suzuki dealer before attempting to troubleshoot any problem. If the machine is still within the warranty, then the Suzuki dealer should definitely be consulted before any repairs are attempted on the machine by yourself. Tampering with the machine while in warranty may affect warranty consideration.

FEHLERSUCHE

FEHLERSUCHE

Was machen Sie, wenn der Motor nicht anspringt, plötzlich auf der Straße stehenbleibt oder an Leistung verliert?

- (1) Ist genügend Kraftstoff im Tank?
- (2) Gelangt der Kraftstoff zum Vergaser?
- (3) Den Kraftstoffschlauch vom Vergaser entfernen, den Motor für einen kurzen Moment ankurbeln und stehen, ob immer noch Kraftstoff fließt.
- (4) Nachdem festgestellt worden ist, daß Kraftstoff den Vergaser erreicht, muß das Zündsystem geprüft werden.

WARNUNG:

Lassen Sie den Kraftstoff nicht auslaufen, sondern fangen Sie ihn in einem Behälter auf.

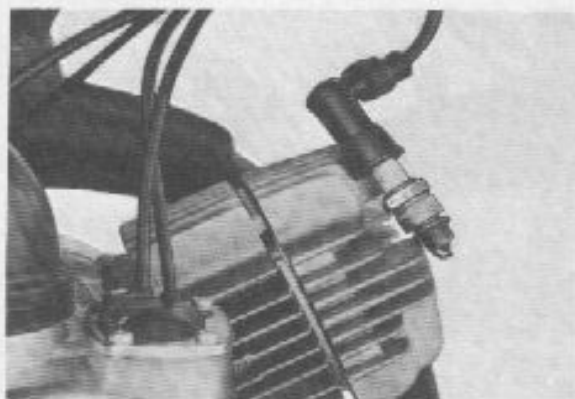

- (1) Eine Zündkerze heraus-schrauben und wieder am Zündkabel anbringen.
- (2) Die Zündkerze fest gegen den Motor halten und den Anlaßknopf bei auf "ON" (Ein) gestelltem Zündschalter. Wenn das Zündsystem einwandfrei funktioniert, sollte ein blauer Funke zwischen den Elektroden überspringen. Ist dies nicht der Fall, wenden Sie sich wegen Reparaturarbeiten an Ihren Suzuki-Fachhändler.

WARNUNG:

Halten Sie die Zündkerze weit vom offenen Zündkerzenloch im Zylinderkopf entfernt, da Kraftstoffdämpfe im Zylinder andernfalls entzündet werden können, was Feuer verursachen kann.

SELBSTANHALTEN DES MOTORS

- (1) Den Kraftstoffstand im Benzintank prüfen.
- (2) Das Zündsystem auf richtiges Überspringen des Funkens prüfen.
- (3) Die Leerlaufgeschwindigkeit des Motors prüfen.

Wir empfehlen, Ihren bevollmächtigten Suzuki-Fachhändler zu befragen, bevor Sie versuchen, Fehler zu beheben. Falls die Garantiefrist noch nicht angelaufen ist, sollte der Suzuki-Fachhändler unbedingt befragt werden, bevor Sie versuchen, Reparaturen selbst vorzunehmen.







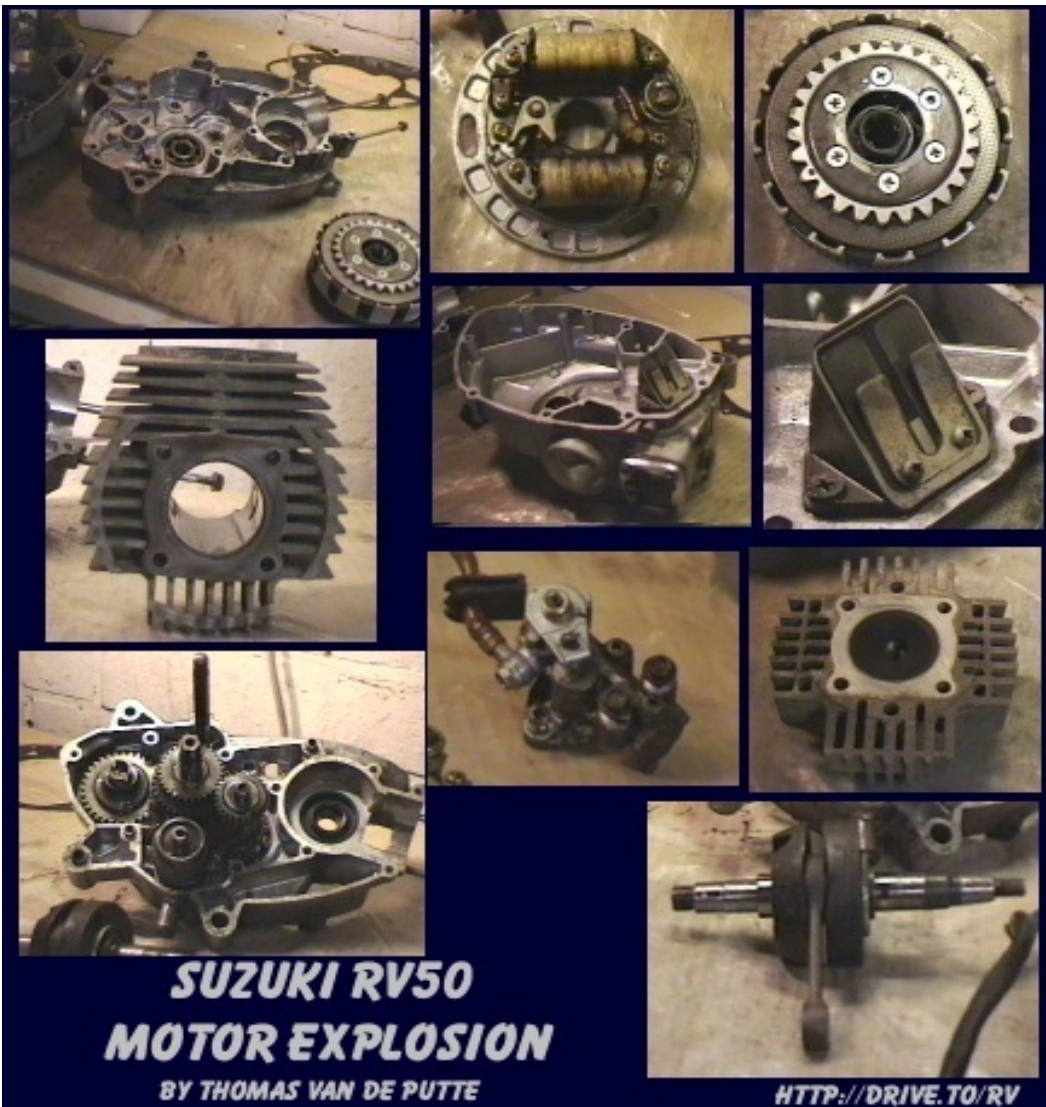

SUZUKI RV50
MOTOR EXPLOSION
BY THOMAS VAN DE PUTTE

[HTTP://DRIVE.TO/RV](http://drive.to/rv)









Welke code is voor jouw land

E - 01	General	E - 21	Belgium
E - 02	England	E - 22	West Germany
E - 03	U.S.A	E - 24	Australia
E - 04	France	E -25	The Nederlands
E- 06	South Africa	E - 26	Denmark
E - 07	Middle Naer East	E - 27	New Zeeland
E - 08	Malaysia	E - 28	Canada
E - 09	Central & South America	E - 30	Singapore
E - 10	Comumbia or Argentina	E -31	The Philippines
E - 12	Indonesia	E - 34	Itary
E - 13	South East Asia	E - 39	Austria
E - 14	Thailand	E - 41	Greece
E - 15	Finland	E - 44	Argentina
E - 16	Norway	E - 49	Papua New Guinea
E - 17	Sweden	E - 94	Barbados
E - 18	Switzerland		

RV50 "X"

E21 BELGIE 1981

