

VL800/C/T

OWNER'S MANUAL

This owner's manual contains
important safety information.
Please read it carefully.



Way of Life!

California Proposition 65 Warning

WARNING

Engine exhaust, some of its constituents, and certain product components contain or emit chemicals known to the State of California to cause cancer and birth defects or other reproductive harm.

This manual should be considered a permanent part of the motorcycle and should remain with the motorcycle when resold or otherwise transferred to a new owner or operator. The manual contains important safety information and instructions which should be read carefully before operating the motorcycle.

IMPORTANT

WARNING/CAUTION/NOTE

Please read this manual and follow its instructions carefully. To emphasize special information, the symbol ▲ and the words WARNING, CAUTION and NOTE have special meanings. Pay special attention to the messages highlighted by these signal words:

▲ WARNING

Indicates a potential hazard that could result in death or injury.

CAUTION

Indicates a potential hazard that could result in motorcycle damage.

NOTE: Indicates special information to make maintenance easier or instructions clearer.

WARNINGs and CAUTIONs are arranged like this:

▲ WARNING-or-CAUTION

The first part will describe a **POTENTIAL HAZARD** and **WHAT CAN HAPPEN** if you ignore the **WARNING** or **CAUTION**.

The second part will describe **HOW TO AVOID THE HAZARD**.

FOREWORD

Motorcycling is one of the most exhilarating sports and to ensure your riding enjoyment, you should become thoroughly familiar with the information presented in this Owner's Manual before riding the motorcycle.

The proper care and maintenance that your motorcycle requires is outlined in this manual. By following these instructions explicitly you will ensure a long trouble-free operating life for your motorcycle. This motorcycle also conforms to the U.S Environmental Protection Agency emission regulations which apply to new motorcycles. The proper adjustment of engine components is necessary for this motorcycle to comply with the EPA regulations. Therefore, please follow the maintenance instructions closely to ensure emission compliance. Your authorized Suzuki dealer has experienced technicians that are trained to provide your machine with the best possible service with the right tools and equipment.

SUZUKI MOTOR CORPORATION

All information, illustrations, and specifications contained in this manual are based on the latest product information available at the time of publication. Due to improvements or other changes, there may be some discrepancies between information in this manual and your motorcycle. Suzuki reserves the right to make production changes at any time, without notice and without incurring any obligation to make the same or similar changes to vehicles previously built or sold.

Suzuki Motor Corporation believes in conservation and protection of Earth's Natural resources. To that end, we encourage every vehicle owner to recycle, trade in, or properly dispose of, as appropriate, used motor oil, engine coolant, and other fluids, batteries, and tires.



© COPYRIGHT SUZUKI MOTOR CORPORATION 2008

TABLE OF CONTENTS

THE SPORT OF MOTORCYCLING

1

FUEL, OIL AND COOLANT RECOMMENDATIONS

2

CONTROLS, EQUIPMENT AND ADJUSTMENTS

3

BREAK-IN AND INSPECTION BEFORE RIDING

4

RIDING TIPS

5

ACCESSORY USE AND MOTORCYCLE LOADING

6

INSPECTION AND MAINTENANCE

7

TROUBLESHOOTING

8

STORAGE PROCEDURE AND MOTORCYCLE CLEANING

9

CONSUMER INFORMATION

10

SPECIFICATIONS

INDEX

THE SPORT OF MOTORCYCLING

MOST ACCIDENTS CAN BE AVOIDED	1-2
IF YOU DON'T HAVE A HELMET - BUY A HELMET, AND WEAR IT EVERY TIME YOU RIDE	1-3
IF A COLLISION IS IMMINENT, DO SOMETHING!	1-3
SPECIAL SITUATIONS REQUIRE SPECIAL CARE	1-4
KNOW YOUR LIMITS	1-4
BE EXTRA SAFETY-CONSCIOUS ON BAD WEATHER DAYS	1-5
PRACTICE AWAY FROM TRAFFIC	1-5
INSPECTION BEFORE RIDING	1-5
ACCESSORIES AND LOADING	1-5
CARRYING A PASSENGER	1-6
MOTORCYCLE SAFETY FOUNDATION'S "RIDING TIPS AND PRACTICE GUIDE" HANDBOOK (FOR OWNERS IN USA)	1-6
BE STREET SMART	1-6
CONCLUSION	1-6

THE SPORT OF MOTORCYCLING

Your motorcycle and this owner's manual have been designed by people like you who enjoy motorcycling. People become motorcyclists for many reasons. For starters, street riding is fun and invigorating. But no matter why you became a motorcyclist, or how experienced you are, you will eventually face some challenging situations.

In preparing for these challenges, you will be fine-tuning your coordination, concentration, and attitude. Learning the skills and strategies associated with motorcycling is the basis for safely participating in this sport. Many motorcyclists find that as they become better riders, they also get more enjoyment from the freedom unique to motorcycling.

Please remember:

MOST ACCIDENTS CAN BE AVOIDED

The most common type of motorcycle accident in the U.S. occurs when a car traveling toward a motorcycle turns left in front of the motorcycle. Is that because other drivers are out to get motorcyclists? No. Other drivers simply don't always notice motorcyclists. Ride defensively. Wise motorcyclists use a strategy of assuming they are invisible to other drivers, even in broad daylight. Pay careful attention to other motorists, especially at intersections, because they may not be paying attention to you. Select a lane position that gives you the best view of others, and other motorists the best view of you. Wear bright, reflective clothing. Put reflective strips on your helmet.

IF YOU DON'T HAVE A HELMET - BUY A HELMET, AND WEAR IT EVERY TIME YOU RIDE

Most accidents occur within a few miles of home, and almost half occur at speeds of less than 30 mph. So even if you're just going on a quick errand, be prepared-strap on your helmet before you take off.

Helmets do not reduce essential vision or hearing. Generally, helmets do not cause or intensify injury if you crash. Helmets simply help your skull protect your intelligence, your memory, your personality, and your life.

Your eyesight is equally valuable. Wearing suitable eye protection can help keep your vision unblurred by the wind and save your eyes from airborne hazards like bugs, dirt, or pebbles kicked up by tires.

IF A COLLISION IS IMMINENT, DO SOMETHING!

Many riders fear locking up their brakes or haven't learned to swerve to avoid an accident. Many inexperienced riders (and too many seasoned riders) use only their rear brake in an emergency, resulting in unnecessary impacts in some cases and unnecessarily high impact speeds in other cases. Your rear brake can only provide about 30% of your motorcycle's potential stopping power. The front and rear brakes can and should be used together to maximize braking effectiveness.

Experienced motorcyclists learn to "cover" the front brake lever by lightly resting a couple of fingers over the lever when riding in traffic and near intersections to give their reaction time a head start.

Emergency stopping and swerving are techniques that you should practice and master before you find yourself in an emergency situation. The best place to practice such techniques is in a controlled environment such as the Motorcycle Safety Foundation's (MSF) rider training courses. The MSF's Motorcycle Rider Courses (fundamental techniques) and Experienced Rider Courses (advanced strategies) present hands-on instruction of the basic principles of motorcycling and a variety of accident avoidance maneuvers. Even a seasoned motorcyclist can improve his or her riding skills, and pick up a few new skills, through these courses. Some insurance companies even offer discounts to course graduates.

SPECIAL SITUATIONS REQUIRE SPECIAL CARE

Of course, there are some times when full-force braking is not the correct technique. When the road surface is wet, loose, or rough, you should brake with care. When you're leaned over in a corner, avoid braking. Straighten up before braking. Better yet, slow down before entering a corner.

In these situations, the traction available between your tires and the road surface is limited. Over-braking when traction is limited will cause your tires to skid, possibly resulting in loss of directional control or causing you and your motorcycle to fall over.

KNOW YOUR LIMITS

Always ride within the boundaries of your own skills. Knowing these limits and staying within them will help you avoid accidents.

A major cause of accidents involving only a motorcycle (and no cars) is going too fast through a turn. Before entering a turn, select an appropriately low cornering speed.

Even on straight roads, ride at a speed that is appropriate for the traffic, visibility and road conditions, your motorcycle, and your experience.

Riding a motorcycle safely requires that your mental and physical skills are fully part of the experience. You should not attempt to operate a motor vehicle, especially one with two wheels, if you are tired or under the influence of alcohol or other drugs. Alcohol, illegal drugs, and even some prescription and over-the-counter drugs can cause drowsiness, loss of coordination, loss of balance, and especially the loss of good judgment. If you are tired or under the influence of alcohol or other drugs, PLEASE DO NOT RIDE your motorcycle.

BE EXTRA SAFETY-CONSCIOUS ON BAD WEATHER DAYS

Riding on bad weather days, especially wet ones, requires extra caution. Braking distances increase on a rainy day. Stay off the painted surface marks, manhole covers, and greasy appearing areas, as they can be especially slippery. Use extra caution at railway crossings and on metal gratings and bridges. When it starts to rain, any oil or grease on the road rises to the surface of the water. Pull over and wait a few minutes until this oil film is washed away before riding. Whenever in doubt about road conditions, slow down!

PRACTICE AWAY FROM TRAFFIC

Your riding skill and your mechanical knowledge form the foundation for safe riding practices. We suggest that you practice riding your motorcycle in a nontraffic situation until you are thoroughly familiar with your machine and its controls. Again, consider taking one of the MSF's Rider Courses. Even experts will be pleased with the caliber of the information presented in these courses. As the MSF says: "The more you know, the better it gets!"

INSPECTION BEFORE RIDING

Review the instructions in the INSPECTION BEFORE RIDING section of this manual. Perform an entire pre-ride inspection before you head out on the road. Spending a few minutes preparing your machine for a ride can help prevent accidents due to mechanical failure or costly, inconvenient breakdowns far from home.

ACCESSORIES AND LOADING

The accessories you use with your motorcycle and the manner in which you load your gear onto the bike might create hazards. Aerodynamics, handling, balance, and cornering clearance can suffer, and the suspension and tires can be overloaded. Read the ACCESSORY USE AND MOTORCYCLE LOADING section.

CARRYING A PASSENGER

Carrying a passenger, when done correctly, is a great way to share the joy of motorcycling. You will have to alter your riding style somewhat since the extra weight of a passenger will affect handling and braking. You may also need to adjust tire pressures and suspension; please refer to the Tire Pressure and Loading section and the Suspension section for more details.

A passenger needs the same protection that you do, including a helmet and proper clothing. The passenger should not wear long shoe laces or loose pants that could get caught in the wheel or the chain. Passengers must be tall enough that their feet reach the footrests.

MOTORCYCLE SAFETY FOUNDATION'S "RIDING TIPS AND PRACTICE GUIDE" HANDBOOK (FOR OWNERS IN USA)

This special handbook, supplied with your owner's manual, contains a variety of safety tips, helpful hints, and practice exercises. This manual can increase your riding enjoyment and safety. You should read it thoroughly.

BE STREET SMART

Always heed speed limits, local laws, and the basic rules of the road. Set a good example for others by demonstrating a courteous attitude and a responsible riding style.

CONCLUSION

Traffic, road and weather conditions vary. Other motorist's actions are unpredictable. Your motorcycle's condition can change. These factors can best be dealt with by giving every ride your full attention.

Circumstances beyond your control could lead to an accident. You need to prepare for the unexpected by wearing a helmet and other protective gear, and learning emergency braking and swerving techniques to minimize the damage to you and your machine.

The best way to learn basic riding skills and evasive maneuvers or refresh your own riding skills is to take one of the courses offered by the Motorcycle Safety Foundation. Your authorized Suzuki dealer can help you locate the fundamental or advanced riding skills course nearest you, or owners in the USA can call toll-free 1-800-446-9227.

Good riding on your new Suzuki!

FUEL, OIL AND COOLANT RECOMMENDATIONS

FUEL	2-2
ENGINE OIL	2-3
GEAR OIL	2-4
ENGINE COOLANT SOLUTION	2-5

FUEL, OIL AND COOLANT RECOMMENDATIONS

FUEL

Your motorcycle requires regular unleaded gasoline with a minimum pump octane rating of 87 ((R+M)/2 method). In some areas, the only fuels that are available are oxygenated fuels.

Oxygenated fuels which meet the minimum octane requirement and the requirements described below may be used in your motorcycle without jeopardizing the New Vehicle Limited Warranty or the Emission Control System Warranty.

NOTE: Oxygenated fuels are fuels which contain oxygen-carrying additives such as MTBE or alcohol.

Gasoline containing MTBE

Unleaded gasoline containing MTBE (Methyl Tertiary Butyl Ether) may be used in your motorcycle if the MTBE content is not greater than 15%. This oxygenated fuel does not contain alcohol.

Gasoline/Ethanol Blends

Blends of unleaded gasoline and ethanol (grain alcohol), also known as "GASOHOL", may be used in your vehicle if the ethanol content is not greater than 10%.

Gasoline/Methanol Blends

Fuels containing 5% or less methanol (wood alcohol) may be suitable for use in your motorcycle if they contain co-solvents and corrosion inhibitors.

DO NOT USE fuels containing more than 5% methanol under any circumstances. Fuel system damage or motorcycle performance problems resulting from the use of such fuels are not the responsibility of Suzuki and may not be covered under the New Vehicle Limited Warranty or the Emission Control System Warranty.

Fuel Pump Labeling

In some states, pumps that dispense oxygenated fuels are required to be labeled for the type and percentage of oxygenate, and whether important additives are present. Such labels may provide enough information for you to determine if a particular blend of fuel meets the requirements listed above. In other states, pumps may not be clearly labeled as to the content or type of oxygenate and additives. If you are not sure that the fuel you intend to use meets these requirements, check with the service station operator or the fuel supplier.

NOTE:

- To help minimize air pollution, Suzuki recommends that you use oxygenated fuels.
- Be sure that any oxygenated fuel you use has octane ratings of at least 87 pump octane ((R+M)/2 method).
- If you are not satisfied with the driveability of your motorcycle when you are using an oxygenated fuel, or if engine ping-ing is experienced, substitute another brand as there are differences between brands.

CAUTION

Spilled gasoline containing alcohol can harm your motorcycle. Alcohol can damage painted surfaces.

Be careful not to spill any fuel when filling the fuel tank. Wipe spilled gasoline up immediately.

ENGINE OIL

Oil quality is a major contributor to your engine's performance and life. Always select good quality engine oil. Suzuki recommends the use of SUZUKI PERFORMANCE 4 MOTOR OIL or equivalent engine oil. Use oil with an API (American Petroleum Institute) classification of SF/SG or SH/SJ, or with a JASO classification of MA.

SAE	API	JASO
10W-40	SF or SG	-
10W-40	SH or SJ	MA

API: American Petroleum Institute
JASO: Japanese Automobile Standards Organization

SAE Engine Oil Viscosity

Suzuki recommends the use of SAE 10W-40 engine oil. If SAE 10W-40 engine oil is not available, select an alternative according to the following chart.

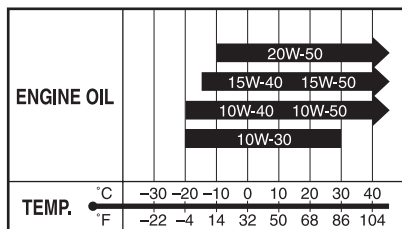

JASO T903

The JASO T903 standard is an index to select engine oils for 4-stroke motorcycle and ATV engines. Motorcycle and ATV engines lubricate clutch and transmission gears with engine oil. JASO T903 specifies performance requirements for motorcycle and ATV clutches and transmissions.

There are two classes, MA and MB. The oil container shows the classification as follows.

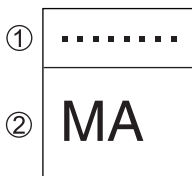

- ① Code number of oil sales company
- ② Oil classification

Energy Conserving

Suzuki does not recommend the use of “ENERGY CONSERVING” oils. Some engine oils which have an API classification of SH or higher have an “ENERGY CONSERVING” indication in the API classification doughnut mark. These oils can affect engine life and clutch performance.

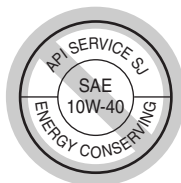

Not recommended



Recommended

GEAR OIL

Use an SAE90 hypoid gear oil which is rated GL-5 under the API classification system. If you operate the motorcycle where ambient temperature is below 0°C (32°F), use SAE80 hypoid gear oil.

ENGINE COOLANT SOLUTION

Use engine coolant that is compatible with an aluminum radiator, mixed with distilled water at a 50:50 mixture ratio for engine coolant solution. An engine coolant mixture other than 50:50 can affect cooling efficiency or rust inhibiting performance.

Engine Coolant

Engine coolant should be used at all times in your motorcycle's radiator, even if the temperature in your area does not go down to the freezing point. Engine coolant acts as a rust inhibitor and water pump lubricant as well as an anti-freeze solution.

WARNING

Engine coolant is harmful or fatal if swallowed or inhaled.

Do not drink antifreeze or coolant solution. If swallowed, do not induce vomiting. Immediately contact a poison control center or a physician. Avoid inhaling mist or hot vapors; if inhaled, remove to fresh air. If coolant gets in eyes, flush eyes with water and seek medical attention. Wash thoroughly after handling. Solution can be poisonous to animals. Keep out of the reach of children and animals.

CAUTION

Spilled engine coolant can damage painted surfaces.

Do not spill any fluid when filling the radiator. Wipe spilled engine coolant up immediately.

Water for Mixing

Use distilled water only. Water other than distilled water can corrode and clog the aluminum radiator.

Required amount of engine coolant/water solution capacity (total): 1500 ml (3.2 US pt)

Engine coolant	750 ml (1.6 US pt)
Water	750 ml (1.6 US pt)



CONTROLS, EQUIPMENT AND ADJUSTMENTS

LOCATION OF PARTS	3-2
KEY	3-5
IGNITION SWITCH	3-5
INSTRUMENT PANEL	3-7
LEFT HANDLEBAR	3-13
RIGHT HANDLEBAR	3-15
FUEL TANK CAP	3-17
GEARSHIFT LEVER	3-18
REAR BRAKE PEDAL	3-18
HELMET HOLDER	3-19
SIDE STAND	3-19
SUSPENSION ADJUSTMENT	3-20

CONTROLS, EQUIPMENT AND ADJUSTMENTS

LOCATION OF PARTS

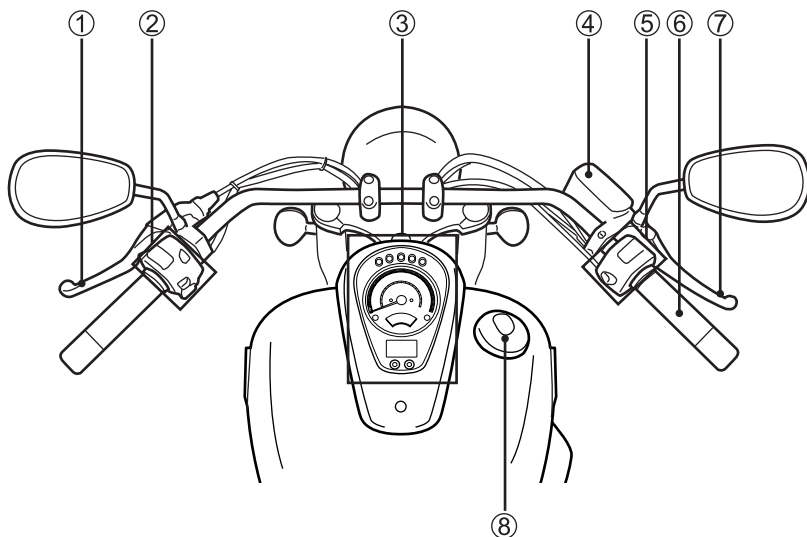

- ① Clutch lever
- ② Left handlebar switches
- ③ Instrument panel
- ④ Front brake fluid reservoir
- ⑤ Right handlebar switches
- ⑥ Throttle grip
- ⑦ Front brake lever
- ⑧ Fuel tank cap

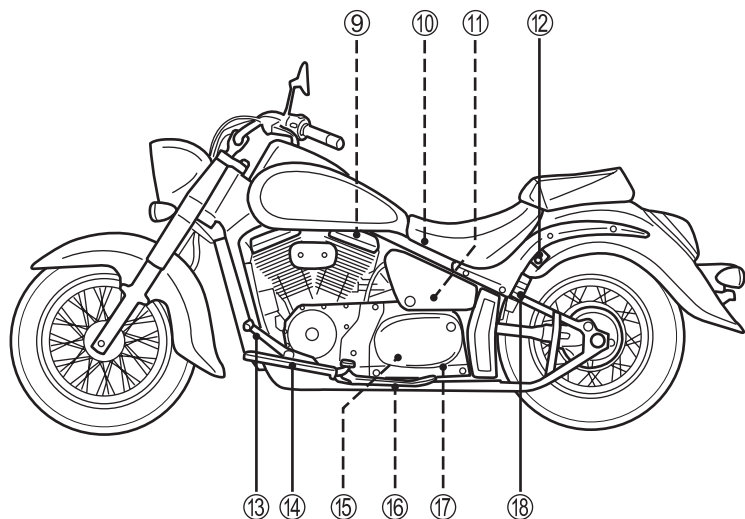

VL800

- ⑨ Spark plugs
- ⑩ Battery and main fuse
- ⑪ Tools
- ⑫ Helmet holder
- ⑬ Gearshift lever
- ⑭ Footrests
- ⑮ Engine coolant reservoir
- ⑯ Side stand
- ⑰ Fuses
- ⑱ Passenger footrests

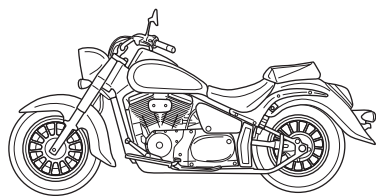

VL800C

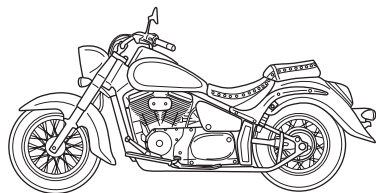

VL800T

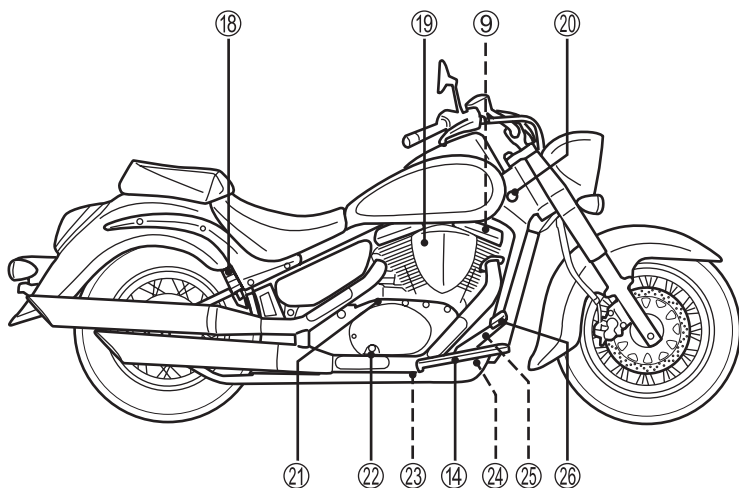

VL800

- ①⑨ Air cleaner
- ②⑩ Ignition switch
- ③⑪ Engine oil filler cap
- ④⑫ Engine oil inspection window
- ⑤⑬ Engine oil drain plug
- ⑥⑭ Engine oil filter
- ⑦⑮ Rear brake light switch
- ⑧⑯ Rear brake pedal

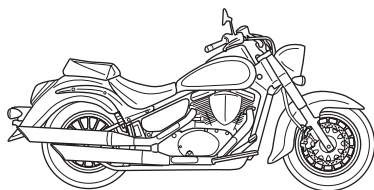

VL800C

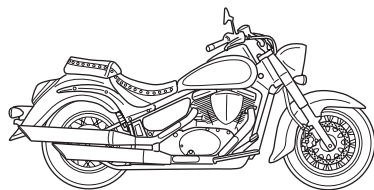

VL800T

KEY

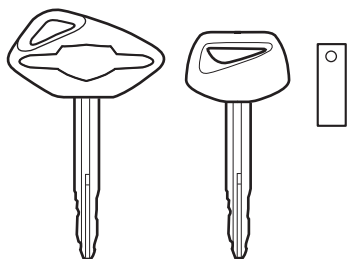

Two keys come with this motorcycle. Keep the spare key in a safe place. An identifying number is stamped on the plate. Use this number when making a replacement key.

Please write down your key number in the box provided for your future reference.

Key number:

IGNITION SWITCH

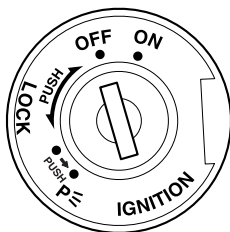

The ignition switch has 4 positions.

“OFF” position

All electrical circuits are cut off. The engine will not start. The key can be removed.

“ON” position

The ignition circuit is completed and the engine can be started. The headlight, front turn signal light and taillight will automatically turn on. The key cannot be removed in this position.

NOTE: Start the engine promptly after turning the key to the “ON” position, or the battery will lose power due to consumption by the headlight and taillight.

“LOCK” position

All electrical circuits are off. The key can be removed and the steering will be locked. Turn the steering all the way to the left and push down the key and turn it to the “LOCK” position.

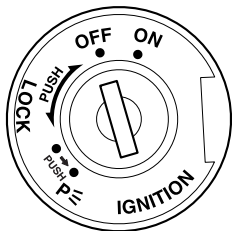

“P” (PARKING) position

The taillight will come on to increase visibility for temporary road side parking at night. The key can be removed and the steering will be locked.

▲ WARNING

Turning the ignition switch to the “P” (PARKING) or “LOCK” position while the motorcycle is moving can be hazardous. Moving the motorcycle while the steering is locked can be hazardous. You could lose your balance and fall, or you could drop the motorcycle.

Stop the motorcycle and place it on the side stand before locking the steering. Never attempt to move the motorcycle when the steering is locked.

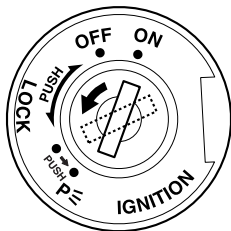

The key hole can be covered by turning the lid.

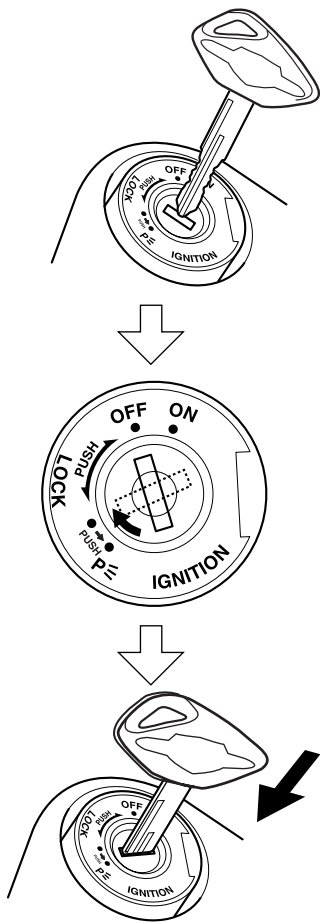

Align the lid hole position with the key hole position when inserting the key.

INSTRUMENT PANEL

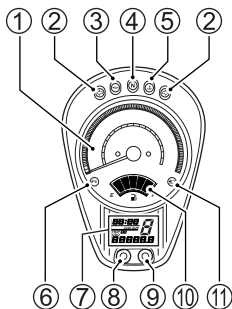

SPEEDOMETER ①

The speedometer indicates the road speed in kilometers per hour and miles per hour.

TURN SIGNAL INDICATOR LIGHT “←→” ②

When the turn signals are being operated either to the right or to the left the indicator will flash at the same time.

If a turn signal light is not operating properly due to bulb filament or circuit failure, the indicator light flickers more frequently than normal to notify the rider of the existence of a failure.

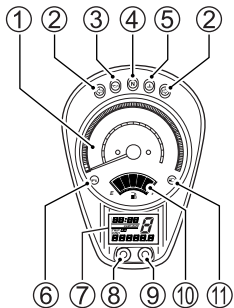

OIL PRESSURE INDICATOR LIGHT “” ③

This indicator light comes on when the engine oil pressure is below the normal operating range.

CAUTION

Riding the motorcycle with the oil pressure indicator light lit can damage the engine and transmission.

Whenever the oil pressure indicator lights up, indicating low oil pressure, stop the engine immediately. Check the oil level and determine if the proper amount of oil is in the engine. If the light still does not go out, have your authorized SUZUKI dealer or a qualified mechanic troubleshoot your motorcycle.

NEUTRAL INDICATOR LIGHT “N” ④

The green light will come on when the transmission is in neutral. The light will go out when you shift into any gear other than neutral.

COOLANT TEMPERATURE INDICATOR LIGHT “” ⑤

This indicator light comes on when the coolant temperature indicates more than 120°C (248°F).

CAUTION

Running the engine with high engine coolant temperature can cause serious engine damage. If the engine coolant temperature indicates greater than 120°C (248°F) and the indicator light comes on, stop the engine to let it cool.

Do not run the engine until the coolant temperature indicates 120°C (248°F) or below.

FUEL INJECTION SYSTEM INDICATOR “FI” ⑥

The image shows the letters 'F' and 'I' in a bold, italicized, sans-serif font. The 'F' is on the left and the 'I' is on the right, with a small gap between them. They are centered between two horizontal lines, one above and one below.

If the fuel injection system fails, the red indicator light ⑥ comes on and the display indicates “FI” at the clock display in the following two modes;

- A. The display ⑦ indicates “FI” intermittently, and the red indicator light ⑥ comes on and remains lit.
- B. The display ⑦ indicates “FI” continuously and the red indicator light ⑥ blinks while cranking the engine.

The engine may continue to run in mode A, but the engine will not run in mode B.

CAUTION

Riding the motorcycle with the display indicating a problem with the fuel injection system and with the indicator light lit can damage the engine.

Whenever the red indicator light is lit and the display indicates “FI”, have your authorized Suzuki dealer or a qualified mechanic inspect the fuel injection system as soon as possible.

NOTE:

- If the display indicates “FI” intermittently and the red indicator light comes on and remains lit, keep the engine running and bring your motorcycle to an authorized Suzuki dealer. If the engine stalls, try restarting the engine after turning the ignition switch off and on.
- If the display indicates “FI” continuously and the red indicator light blinks, the engine will not start.

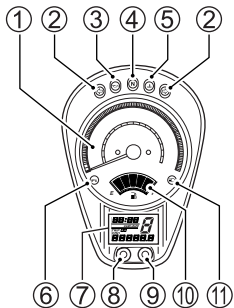

CHEC

When the display indicates “CHEC”, check following items;

- Make sure that the engine stop switch is in the “ \odot ” position.
- Make sure that the transmission is in neutral or the side stand is fully up.

If the display still indicates “CHEC” after checking the above items, inspect the ignition fuse and the connection of the lead wire couplers.

COMBINATION SYSTEM DISPLAY ⑦

The display has five functions, clock, odometer, two trip meters and gear position. When the ignition switch is turned to the “ON” position, the display indicates the test pattern shown below for two seconds.



To change the display, push the button ⑧. The display changes in the order below.

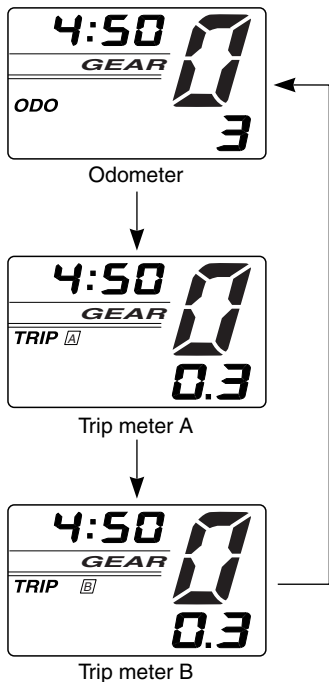

Clock

The clock has a 12-hour display. Follow the procedure below to adjust the clock.

1. Push the buttons, ⑧ and ⑨, simultaneously for 2 seconds until the hour display blinks.
2. Adjust the hour display by pushing the button ⑨.

NOTE: When the button ⑨ is held in the display advances continuously.

3. Push the button ⑧ to highlight the minute display.
4. Adjust the minute display by pushing the button ⑨.
5. Push the button ⑧ to return to the clock mode.

Odometer

The odometer registers the total distance that the motorcycle has been ridden. The odometer ranges from 0 to 999999 miles.

⚠ WARNING

Operating the display while riding can be hazardous. Removing a hand from the handlebars can reduce your ability to control the motorcycle.

Always keep both hands on the handlebars during operation.

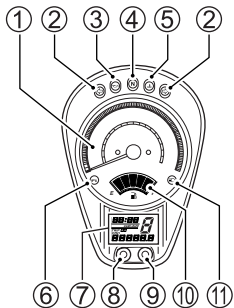

Trip Meters

The two trip meters are resettable odometers. They can register two kinds of distances at the same time. For instance, trip meter A can register the trip distance and trip meter B can register the distance between fuel stops.

To reset a trip meter to zero, push the button ⑨ for 2 seconds while the display indicates the trip meter A, or B, you want to reset.

NOTE: When the trip meter exceeds 9999.9, the trip meter will return to 0.0 and start counting again.



Gear Position Indicator

The gear position indicator indicates gear position. This indicator displays “0” when the transmission is in neutral.

NOTE: When the display indicates “CHEC”, the gear position indicator does not indicate a number but indicates “-”.

FUEL METER “” ⑩

The fuel meter indicates the amount of fuel remaining in the fuel tank. The fuel meter displays all 5 segments when the fuel tank is full. The segment comes on when the fuel level drops below 3.5 L (3.7 US qt). The segment flicker when the fuel drops below 1.5 L (1.6 US qt).

Fuel tank	Approximately 1.5 L	Approximately 3.5 L	Full
Fuel gauge			

HIGH BEAM INDICATOR LIGHT

“” ⑪

This blue indicator light will come on when the headlight high beam is turned on.

LEFT HANDLEBAR

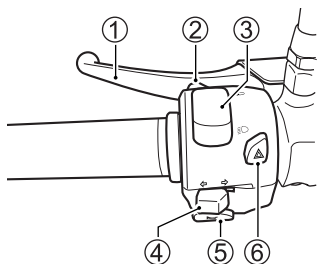

Clutch Lever ①

The clutch lever is used for disengaging the drive to the rear wheel when starting the engine or shifting transmission gears. Squeezing the lever disengages the clutch.

Headlight Flasher Switch ②

Press the switch to flash the headlight.

Dimmer Switch ③





“” position



The headlight low beam and tail-light turn on.

“” position

The headlight high beam and tail-light turn on. The high beam indicator light also turns on.

CAUTION

Holding the dimmer switch between “” and “” position will light both “” and “” headlight beam. This operation can damage the motorcycle.

Use the dimmer switch only at “” or “” position.

CAUTION

Sticking some tape or placing objects in front of the headlight can damage the headlight.

Do not stick any tapes to the headlight. Do not place objects in front of the headlight.

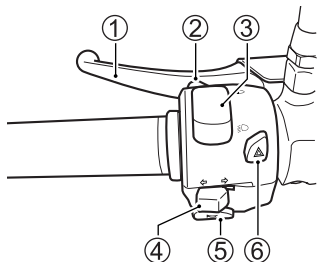

Turn Signal Switch “←→” ④

Moving the switch to the “←” position will flash the left turn signals. Moving the switch to the “→” position will flash the right turn signals. The indicator light will also flash intermittently. To cancel turn signal operation, push the switch in.

▲ WARNING

Failure to use the turn signals, and failure to turn off the turn signals can be hazardous. Other drivers may misjudge your course and this may result in an accident.

Always use the turn signals when you intend to change lanes or make a turn. Be sure to turn off the turn signals after completing the turn or lane change.

Horn Button “🔊” ⑤

Press the button to sound the horn.

Hazard Warning Switch “▲” ⑥

All four turn signal lights and indicators will flash simultaneously when the switch is turned on with the ignition switch in the “ON” or “P” position. Use the hazard warning lights to warn other traffic during emergency parking or when your vehicle could otherwise become a traffic hazard.

RIGHT HANDLEBAR

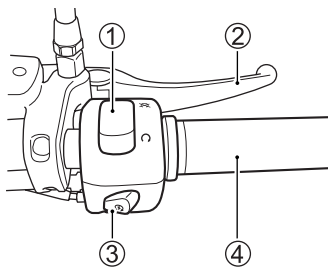

Engine Stop Switch ①

“~~X~~” position

The ignition circuit is off. The engine cannot start or run.

“Q” position

The ignition circuit is on and the engine can run.

Front Brake Lever ②

Apply the front brake by squeezing the front brake lever toward the grip. The brake light will come on when the lever is squeezed.

Front Brake Lever Adjustment

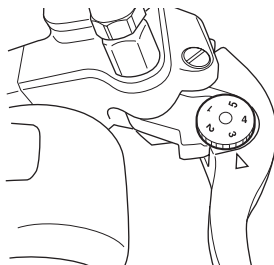

The distance between the throttle grip and the front brake lever is adjustable to 5 positions. To change the position, push the brake lever forward and turn the adjuster to the desired position. Be sure the adjuster stops in the proper position; a projection of the brake lever holder should fit into the depression of the adjuster. This motorcycle is delivered from the factory with its adjuster set on position 3.

⚠ WARNING

Adjusting the front brake lever position while riding can be hazardous. Removing a hand from the handlebars can reduce your ability to control the motorcycle.

Always keep both hands on the handlebars while riding.

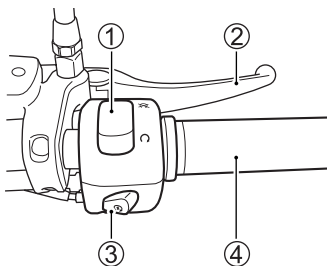

Electric Starter Button “ $\text{\textcircled{S}}$ ” ③

Use this button to operate the starter motor. With the ignition switch in the “ON” position, the engine stop switch in the “ $\text{\textcircled{Q}}$ ” position, and the transmission in neutral, pull in the clutch lever and push the electric starter button to start the engine.

NOTE: This motorcycle has a starter interlock system for the ignition and starter circuit. The engine can only be started if:

- *The transmission is in neutral and the clutch is disengaged, or*
- *The transmission is in gear, the side stand is fully up and the clutch is disengaged.*

NOTE: The headlight will go off when the electric starter button is pushed.

CAUTION

To prevent electrical system damage, do not operate the starter motor longer than five seconds at a time.

If the engine does not start after several attempts, check the fuel supply and ignition system. Refer to the TROUBLE-SHOOTING section in this manual.

Throttle Grip ④

Engine speed is controlled by the position of the throttle grip. Turn it toward you to increase engine speed. Turn it away from you to decrease engine speed.

FUEL TANK CAP

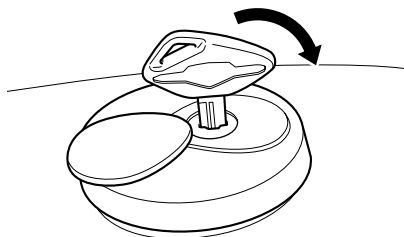

To open the fuel tank cap, insert the ignition key into the lock and turn it clockwise. With the key inserted, lift the cap up with key. To close the fuel tank cap, push the cap down firmly with the key in the cap lock.

NOTE: Place the motorcycle on the side stand to fill up the fuel tank to specified 15.5 L (4.1 US gal).

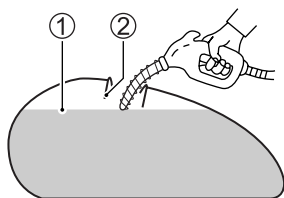

- ① Fuel level
- ② Filler neck

⚠ WARNING

Overfilling the fuel tank can cause the fuel to overflow when it expands due to heat from the engine or the sun. Spilled fuel can catch on fire.

Never fill the fuel above the bottom of the filler neck.

⚠ WARNING

Fuel and fuel vapor are highly flammable and toxic. You can be burned or poisoned when refueling.

- Stop the engine and keep flames, sparks and heat sources away.
- Refuel only outdoors or in a well ventilated area.
- Do not smoke.
- Wipe up spills immediately.
- Avoid breathing fuel vapor.
- Keep children and pets away.

GEARSHIFT LEVER

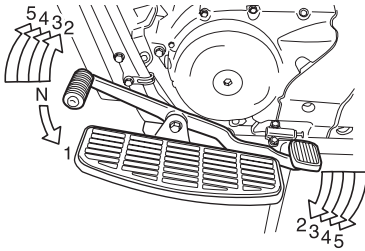

This motorcycle has 5-speed transmission which operates as shown. To shift properly, pull the clutch lever and close the throttle at the same time you operate the gearshift lever. Lift the front end of the gear shift lever or depress the rear end of the gearshift lever to upshift. Depress the front end of the gearshift lever to downshift. Neutral is located between 1st and 2nd gear. When neutral is desired, depress or lift the lever halfway between 1st and 2nd gear.

NOTE: When the transmission is in neutral, the green indicator light on the instrument panel will be lit. However, even though the light is lit, cautiously and slowly release the clutch lever to make sure that the transmission is positively in neutral.

REAR BRAKE PEDAL

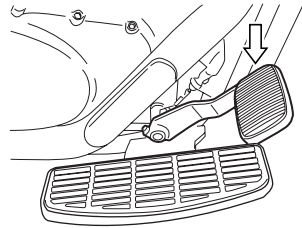

Pressing the rear brake pedal will apply the rear brake. The brake light will come on when the rear brake is operated.

HELMET HOLDER

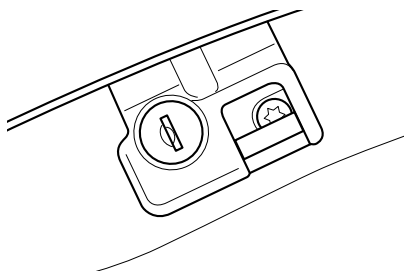

The helmet holder is located on the left side below the rear seat. Insert the ignition key into the lock and turn it clockwise to open the latch. Hook your helmet fastener ring to the latch and turn the key back to lock the holder.

⚠ WARNING

Riding with a helmet fastened to the helmet holder can interfere with rider control.

Never carry a helmet fastened to the helmet holder. Fix the helmet securely atop the seat if you must carry it.

SIDE STAND

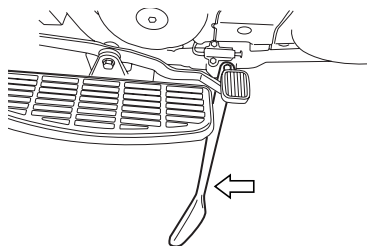

The motorcycle has a side stand. To place the motorcycle on the side stand, place your right foot on the end of the side stand and push down firmly until the stand pivots fully through its arc and comes to rest against its stop.

An interlock system is provided to cut off the ignition circuit when the side stand is down and the transmission is in any gear other than neutral.

The side stand/ignition interlock system works as follows:

- If the side stand is down and the transmission is in gear, the engine cannot be started.
- If the engine is running and the transmission is shifted into gear with the side stand down, the engine will stop running.
- If the engine is running and the side stand is put down with the transmission in gear, the engine will stop running.

⚠ WARNING

Riding with the side stand incompletely retracted can result in an accident when you turn left.

- Check operation of the side stand/ignition interlock system before riding.
- Always retract the side stand completely before starting off.

CAUTION

Park the motorcycle on firm, level ground to help prevent it from falling over.

If you must park on an incline, aim the front of the motorcycle uphill and put the transmission into 1st gear to reduce the possibility of rolling off the side stand.

SUSPENSION ADJUSTMENT

REAR SUSPENSION

Spring Pre-load Adjustment

The rear suspension spring pre-load is adjustable to compensate for rider, load, riding style and road conditions. The adjustment can be performed in seven positions. To change the spring pre-load setting, follow the procedure below.

1. Place the motorcycle on the side stand.

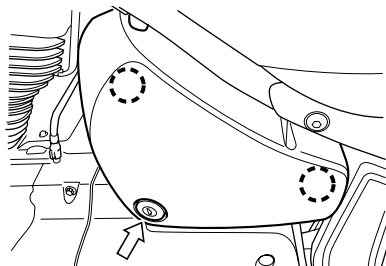

2. Insert the ignition key into the lock and turn it counterclockwise. Unhook the hooks and remove the right frame cover.

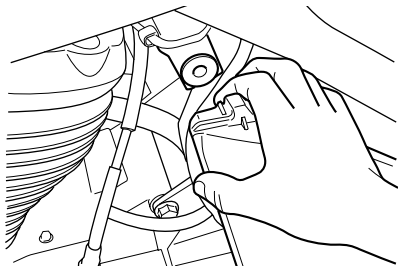

3. Pull the hook to open the box lid.

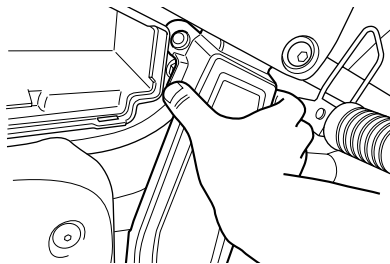

4. Unhook the hooks and remove the cover.

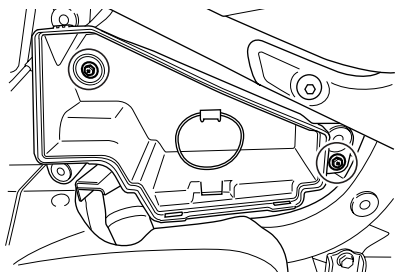

5. Loosen the bolts and remove the tool box.

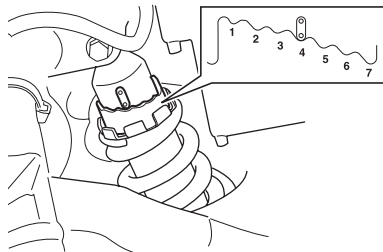

6. Twist the spring tension ring to the desired position with an adjuster. Position 1 provides the softest spring tension and position 7 provides the stiffest. This motorcycle is delivered from the factory with its adjuster set on position 4.

NOTE: Use a hook type spring adjuster or Suzuki spring adjuster, Part number 09822-00003 to adjust the rear suspension spring. The Suzuki spring adjuster is available from your Suzuki dealer.

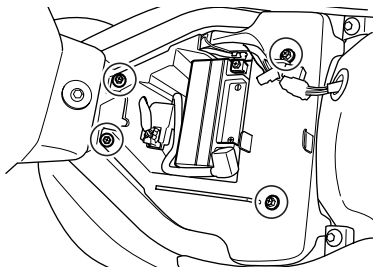

NOTE: If it is hard to adjust the spring pre-road, remove the bolts and move the battery box.



BREAK-IN AND INSPECTION BEFORE RIDING

BREAK-IN	4-2
INSPECTION BEFORE RIDING	4-3

BREAK-IN AND INSPECTION BEFORE RIDING

BREAK-IN

The first 800 km (500 miles) is the most important in the life of your motorcycle. Proper operation during this break-in period will help assure maximum life and performance from your new motorcycle. The following guidelines explain proper break-in procedures.

Maximum Throttle Opening Recommendation

The table below shows the maximum throttle opening recommendation during the break-in period.

Up to 800 km (500 miles)	Less than 1/2 throttle
Up to 1600 km (1000 miles)	Less than 3/4 throttle

Vary the Engine Speed

Vary the engine speed during the break-in period. This allows the parts to “load” (aiding the mating process) and then “unload” (allowing the parts to cool). Although it is essential to place some stress on the engine components during break-in, you must be careful not to load the engine too much.

Breaking in the New Tires

New tires need proper break-in to assure maximum performance, just as the engine does. Wear in the tread surface by gradually increasing your cornering lean angles over the first 160 km (100 miles) before attempting maximum performance. Avoid hard acceleration, hard cornering, and hard braking for the first 160 km (100 miles).

WARNING

Failure to perform break-in of the tires could cause tire slip and loss of control.

Use extra care when riding on new tires. Perform proper break-in of the tires as described in this section and avoid hard acceleration, hard cornering, and hard braking for the first 160 km (100 miles).

Allow the Engine Oil to Circulate before Riding

Allow enough idling time after warm or cold engine start-up before revving the engine or placing the transmission in gear. This allows time for the lubricating oil to reach all critical engine components.

Observe Your Initial and Most Critical Service

The initial service (1000 km maintenance) is the most important service your motorcycle will receive. During break-in operation, all of the engine components will have mated together and seated. Maintenance required as part of the initial service includes correction of all adjustments, tightening of all fasteners and replacement of dirty oil. Timely performance of this service will help make sure you get the best service life and performance from the engine.

INSPECTION BEFORE RIDING

WARNING

Failure to inspect and maintain your motorcycle properly increases the chance of an accident or equipment damage.

Always perform a pre-ride inspection before each ride. Refer to the table on page 4-4 for check items. For further details, refer to the INSPECTION AND MAINTENANCE section.

WARNING

Using worn, improperly inflated, or incorrect tires will reduce stability and can cause an accident.

Follow all instructions in the TIRES section in this owner's manual.

Check the condition of the motorcycle to help make sure that you do not have mechanical problems or get stranded somewhere when you ride. Before riding the motorcycle, be sure to check the following items. Be sure your motorcycle is in good condition for the personal safety of the rider, passenger and protection of the motorcycle.

WARNING

Checking maintenance items when the engine is running can be hazardous. You could be severely injured if your hands or clothing gets caught in moving parts.

Shut the engine off when performing maintenance checks, except when checking the engine stop switch and throttle.

WHAT TO CHECK	CHECK FOR:
Steering	<ul style="list-style-type: none"> • Smoothness • No restriction of movement • No play or looseness
Brakes	<ul style="list-style-type: none"> • Proper pedal and lever operation • Correct fluid level • No fluid leakage • No "sponginess" • Proper pedal and lever play • Brake pad wear • Brake shoe wear
Tires	<ul style="list-style-type: none"> • Proper pressure • Enough tread depth • No cracks, rips, or other damage
Fuel tank	Tank cap locked securely
Lighting	Operation of all lights and indicators
Engine stop switch	Proper operation
Horn	Correct function
Engine oil	Correct level
Cooling system	<ul style="list-style-type: none"> • Proper coolant level • No leaks or damage
Gear oil	Correct level
Throttle	<ul style="list-style-type: none"> • Proper play • Smooth response • Quick return to idle position
Gearshift lever	<ul style="list-style-type: none"> • No damage • Smooth operation
Clutch	<ul style="list-style-type: none"> • Smooth and progressive action • Proper lever play
Side stand/ignition interlock system	Proper operation
General condition	<ul style="list-style-type: none"> • Bolts and nuts tightness • No rattle from any parts of machine with the engine running • No visible evidence of damage

RIDING TIPS

STARTING THE ENGINE	5-2
STARTING OFF AND SHIFTING	5-3
USING THE TRANSMISSION	5-4
RIDING ON HILLS	5-5
STOPPING AND PARKING	5-5
CARRYING A PASSENGER	5-7

RIDING TIPS

STARTING THE ENGINE

Before attempting to start the engine, make sure:

- The transmission is in neutral.
- The engine stop switch is in the “” position.

NOTE: This motorcycle has interlock switches for the ignition circuit and the starter circuit. The engine can only be started if:

- *The transmission is in neutral and the clutch is disengaged, or*
- *The transmission is in gear, the side stand is fully up, and the clutch is disengaged.*

When the Engine is Cold:

1. Close the throttle completely.
2. Squeeze the clutch lever and push the electric starter button.
3. After the engine starts, let the engine run until engine sufficiently warms up.

When the Engine is Warm:

Close the throttle completely and push the electric starter button.

When a Warm Engine is Hard to Start:

Open the throttle 1/8 to 1/4 turn and push the electric starter button.

WARNING

Running the engine indoors or in a garage can be hazardous. Exhaust gas contains carbon monoxide, a gas that is colorless and odorless and can cause death or severe injury.

Only run the engine outdoors where there is fresh air.

CAUTION

Running the engine too long without riding may cause the engine to overheat. Overheating can result in damage to internal engine components and discoloration of exhaust pipes.

Shut the engine off if you cannot begin your ride promptly.

STARTING OFF AND SHIFTING

WARNING

Riding this motorcycle at excessive speed increases your chances of losing control of the motorcycle. This may result in an accident.

Always ride within the limits of your skills, your motorcycle, and the riding conditions.

WARNING

Removing your hands from the handlebars or feet from the footrests during operation can be hazardous. If you remove even one hand or foot from the motorcycle, you can reduce your ability to control the motorcycle.

Always keep both hands on the handlebars and both feet on the footrests of your motorcycle during operation.

WARNING

Sudden side winds, which can occur when being passed by larger vehicles, at tunnel exits or in hilly areas, can upset your control.

Reduce your speed and be alert to side winds.

Make sure that the side stand is in the fully up position. Pull the clutch lever in and pause momentarily. Engage first gear by depressing the gearshift lever downward. Turn the throttle grip a little toward you and at the same time release the clutch lever gently and smoothly. As the clutch engages, the motorcycle will start moving forward. To shift to the next higher gear, accelerate gently, then close the throttle and pull the clutch lever in simultaneously. Lift the gearshift lever upward to select the next gear and release the clutch lever as you open the throttle again. Select higher gears in this manner until top gear is reached.

NOTE: This motorcycle has a side stand/ignition interlock switch. If you shift the transmission into gear when the side stand is down, the engine will stop running.

USING THE TRANSMISSION

The transmission is provided to keep the engine operating smoothly in its normal operating speed range. The gear ratios have been carefully chosen to meet the characteristics of the engine. The rider should always select the most suitable gear for the prevailing conditions. Never slip the clutch to control road speed, but rather downshift to allow the engine to run within its normal operational range. The table below shows the approximate speed range for each gear.

Shifting up schedule

Gear position	miles/h	km/h
1st → 2nd	12	20
2nd → 3rd	19	30
3rd → 4th	25	40
4th → Top	31	50

Shifting down schedule

Gear position	miles/h	km/h
Top → 4th	19	30

Disengage the clutch when the motorcycle speed drops below 20 km/h (12 miles/h).

WARNING

Downshifting when engine speed is too high can:

- cause the rear wheel to skid and lose traction due to increased engine braking, resulting in an accident; or
- force the engine to overrev in the lower gear, resulting in engine damage.

Reduce speed before downshifting.

WARNING

Downshifting while the motorcycle is leaned over in a corner may cause rear wheel skid and loss of control.

Reduce your speed and downshift before entering a corner.

RIDING ON HILLS

- When climbing steep hills, the motorcycle may begin to slow down and show lack of power. At this point you should shift to a lower gear so that the engine will again be operating in its normal power range. Shift rapidly to prevent the motorcycle from losing momentum.
- When riding down a steep hill, the engine may be used for braking by shifting to a lower gear.
- Be careful, however, not to allow the engine to overrev.

STOPPING AND PARKING

1. Turn the throttle grip away from you to close the throttle completely.
2. Apply the front and rear brakes evenly and at the same time.
3. Downshift through the gears as motorcycle speed decreases.
4. Select neutral with the clutch lever squeezed toward the grip (disengaged position) just before the motorcycle stops. The neutral position can be confirmed by observing the neutral indicator light.

WARNING

Inexperienced riders tend to underutilize the front brake. This can cause excessive stopping distance and lead to a collision. Using only the front or rear brake can cause skidding and loss of control.

Apply both brakes evenly and at the same time.

WARNING

Hard braking while turning may cause wheel skid and loss of control.

Brake before you begin to turn.

WARNING

Hard braking on wet, loose, rough, or other slippery surfaces can cause wheel skid and loss of control.

Brake lightly and with care on slippery or irregular surfaces.

WARNING

Following another vehicle too closely can lead to collision. As vehicle speeds increase, stopping distance increases progressively.

Be sure you have a safe stopping distance between you and the vehicle in front of you.

5. Park the motorcycle on a firm, flat surface where it will not fall over.
6. Turn the ignition switch to the "OFF" position.
7. Turn the handlebars all the way to the left and lock the steering for security.
8. Remove the keys.

NOTE: If an optional anti-theft lock such as U-shape lock, brake disk lock and chain is used to avoid theft, be sure to remove anti-theft lock before moving the motorcycle.

WARNING

A hot muffler can burn you. The muffler will be hot enough to burn you for some time after stopping the engine.

Park the motorcycle where pedestrians or children are not likely to touch the muffler.

CARRYING A PASSENGER

Before you invite someone to be a passenger on your motorcycle, you need to be thoroughly familiar with motorcycle operation. Adjust tire pressures and suspension according to the Tire Pressure and Loading section and the Suspension section of this manual.

The passenger should always hold onto your waist or hips, or onto the seat strap or grab bar, as equipped. Ask your passenger not to make any sudden movements. When you lean going around a corner, the passenger should lean with you. The passenger should always keep his or her feet on the footrests, even when you are stopped at a light.

To help prevent burn injuries, warn your passenger not to contact the muffler when mounting or dismounting your motorcycle.





ACCESSORY USE AND MOTORCYCLE LOADING

ACCESSORY USE	6-2
ACCESSORY INSTALLATION GUIDELINE	6-2
LOADING LIMIT	6-3
LOADING GUIDELINES	6-4
MODIFICATION	6-4

ACCESSORY USE AND MOTORCYCLE LOADING

ACCESSORY USE

The addition of unsuitable accessories can lead to unsafe operating conditions. It is not possible for Suzuki to test each accessory on the market or combinations of all the available accessories; however, your dealer can assist you in selecting quality accessories and installing them correctly. Use extreme caution when selecting and installing the accessories on your motorcycle and consult your Suzuki dealer if you have any questions.

WARNING

Improper accessory installation can make your motorcycle unsafe and can lead to an accident.

Use Suzuki genuine accessories or equivalent, designed and tested for your motorcycle. Follow the guidelines in this section.

ACCESSORY INSTALLATION GUIDELINE

- Install aerodynamic affecting accessories, such as a fairing, windshield, backrests, saddlebags, and travel trunks, as low as possible, as close to the motorcycle and as near to the center of gravity as is feasible. Check that the mounting brackets and other attachment hardware are rigidly mounted.
- Inspect for proper ground clearance and bank angle. Inspect that the accessory does not interfere with the operation of the suspension, steering or other control operations.
- Accessories fitted to the handlebars or the front fork area can create serious stability problems. The extra weight will cause the motorcycle to be less responsive to your steering control. The weight may also cause oscillations in the front end and lead to instability problems. Accessories added to the handlebars or front fork of the machine should be as light as possible and kept to a minimum.
- Certain accessories displace the rider from his or her normal riding position. This limits the freedom of movement of the rider and may limit control ability.

- Additional electrical accessories may overload the existing electrical system. Severe overloads may damage the wiring harness or create a hazardous situation due to the loss of electrical power during the operation of the motorcycle.
- Do not pull a trailer or sidecar. This motorcycle is not designed to pull a trailer or sidecar.

LOADING LIMIT

WARNING

Overloading or improper loading can cause loss of motorcycle control and this may result in an accident.

Follow loading limits and loading guidelines in this manual.

- Never exceed the GVWR (Gross Vehicle Weight Rating) of this motorcycle. The GVWR is the combined weight of the machine, accessories, payload, rider and passenger. When selecting your accessories, keep in mind the weight of the riders as well as the weight of the accessories. The additional weight of the accessories may not only create an unsafe riding condition but may also affect the steering ease.

GVWR: 490 kg (1080 lbs) at the tire pressure (cold)

Front: 200 kPa
(2.00 kgf/cm², 29 psi)

(VL800T/C)
225 kPa
(2.25 kgf/cm², 33 psi)

Rear: 250 kPa
(2.50 kgf/cm², 36 psi)

LOADING GUIDELINES

This motorcycle is primarily intended to carry small items when you are not riding with a passenger. Follow the guidelines below to carry a passenger or cargo:

- Balance the load between the left and right side of the motorcycle and fasten it securely.
- Place cargo weight as close to the center of the motorcycle as possible.
- Do not attach large or heavy items to the handlebars, front forks or rear fender.
- Check that both tires are properly inflated to the specified tire pressure for your loading conditions. Refer to page 7-31.
- Improperly loading your motorcycle can reduce your ability to balance and steer the motorcycle. You should ride at reduced speeds, less than 130 km/h (80 mph), when you are carrying cargo or have added accessories.
- Adjust suspension settings as necessary.

MODIFICATION

Modification of the motorcycle, or removal of original equipment may render the vehicle unsafe or illegal. Obey all applicable equipment regulations in your area.

INSPECTION AND MAINTENANCE

NOTICE	7-2
MAINTENANCE SCHEDULE	7-2
TOOLS	7-5
GENERAL LUBRICATION	7-5
BATTERY	7-6
AIR CLEANER	7-7
SPARK PLUG	7-11
ENGINE OIL	7-15
ENGINE IDLE SPEED INSPECTION	7-19
THROTTLE CABLE ADJUSTMENT	7-20
FUEL HOSE	7-20
CLUTCH ADJUSTMENT	7-22
ENGINE COOLANT	7-23
FINAL GEAR OIL	7-24
BRAKES	7-25
TIRES	7-30
SIDE STAND/IGNITION INTERLOCK SYSTEM	7-34
FRONT WHEEL REMOVAL	7-35
REAR WHEEL REMOVAL	7-37
LIGHT BULB REPLACEMENT	7-39
FUSES	7-42

INSPECTION AND MAINTENANCE

NOTICE

MAINTENANCE, REPLACEMENT OR REPAIR OF THE EMISSION CONTROL DEVICES AND SYSTEMS MAY BE PERFORMED BY ANY MOTORCYCLE REPAIR ESTABLISHMENT OR INDIVIDUAL USING ANY MOTORCYCLE PART WHICH HAS BEEN CERTIFIED UNDER THE PROVISIONS IN THE CLEAN AIR ACT Sec. 207 (a)(2).

MAINTENANCE SCHEDULE

It is very important to inspect and maintain your motorcycle regularly. Follow the guidelines in the chart. The intervals between periodic services in kilometers, miles and months are shown. At the end of each interval, be sure to perform the maintenance listed.

WARNING

Improper maintenance or failure to perform recommended maintenance increases the chance of an accident or motorcycle damage.

Always follow the inspection and maintenance recommendations and schedules in this owner's manual. Ask your SUZUKI dealer or a qualified mechanic to do the maintenance items marked with an asterisk (*). You may perform the unmarked maintenance items by referring to the instructions in this section, if you have mechanical experience. If you are not sure how to do any of the jobs, have your SUZUKI dealer or a qualified mechanic do them.

⚠ WARNING

Never run the engine indoors or in a garage. Exhaust gas contains carbon monoxide, a gas that is colorless and odorless and can cause death or severe injury.

Only run the engine outdoors where there is fresh air.

CAUTION

Using poor quality replacement parts can cause your motorcycle to wear more quickly and may shorten its useful life.

Use only genuine SUZUKI replacement parts or their equivalent.

NOTE: The MAINTENANCE CHART specifies the minimum requirements for maintenance. If you use your motorcycle under severe conditions, perform maintenance more often than shown in the chart. If you have any questions regarding maintenance intervals, consult your SUZUKI dealer or a qualified mechanic.

MAINTENANCE CHART

Interval: This interval should be judged by odometer reading or number of months, whichever comes first.

Element	Interval	km	1000	6000	12000	18000	24000
		mile	600	4000	7500	11000	14500
		months	2	12	24	36	48
Air cleaner element			–	I	I	R	I
* Exhaust pipe bolts and muffler bolts			T	–	T	–	T
* Valve clearance			I	–	I	–	I
Spark plug			–	I	R	I	R
Fuel hose			–	I	I	I	I
			* Replace every 4 years				
Engine oil			R	R	R	R	R
Engine oil filter			R	–	–	R	–
Throttle cable play			I	I	I	I	I
* Throttle valve synchronization			I (CA only)	–	I	–	I
* Evaporative emission control system (California model only)			–	–	I	–	I
			Replace vapor hose every 4 years				
PAIR (air supply) system			–	–	I	–	I
Engine coolant			Replace every 2 years				
Radiator hose			–	I	I	I	I
Clutch			–	I	I	I	I
Final gear oil			R	–	I	–	I
* Brakes			I	I	I	I	I
Brake hose			–	I	I	I	I
			* Replace every 4 years				
Brake fluid			–	I	I	I	I
			* Replace every 2 years				
Tires			–	I	I	I	I
* Steering			I	–	I	–	I
* Front forks			–	–	I	–	I
* Rear suspension			–	–	I	–	I
* Chassis bolts and nuts			T	T	T	T	T

NOTE: I= Inspect and clean, adjust, replace or lubricate as necessary, R= Replace, T= Tighten

NOTE: (California model only) and (CA. only) means that the item or the maintenance interval is to be applied only for the California model.

TOOLS

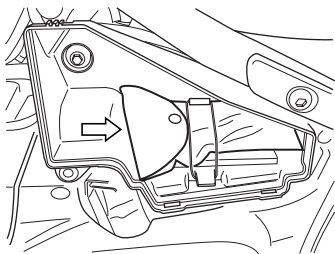

A tool kit is provided with your motorcycle. The toolbox is located on the left side of the motorcycle. To open the toolbox, refer to the **SUSPENSION ADJUSTMENT** section.

GENERAL LUBRICATION

Proper lubrication is important for safe, smooth operation and a long life for your motorcycle. Be sure that all lubrication is performed during periodic maintenance on the motorcycle. Increase frequency when you use your motorcycle in severe conditions.

CAUTION

Lubricating switches can damage the switches.

Do not apply grease and oil to the switches.

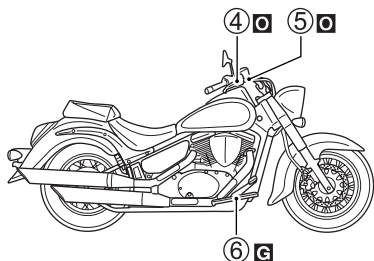
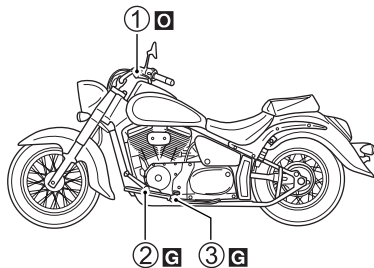

- ⓪... Motor oil
- ⓐ... Grease

- ① Clutch lever holder
- ② Gearshift link pivots
- ③ Side stand pivot and spring hook
- ④ Brake lever holder
- ⑤ Throttle cable
- ⑥ Brake pedal pivot

BATTERY

The battery is a sealed type battery and requires no maintenance. The standard charging rate is $1.2A \times 5$ to 10 hours and the maximum rate is $5.0A \times 1$ hour.

⚠ WARNING

Battery posts, terminals, and related accessories contain lead and lead compounds.

Wash hands after handling.

⚠ WARNING

Hydrogen gas produced by batteries can explode if exposed to flames or sparks.

Keep flames and sparks away from the battery. Never smoke when working near the battery.

CAUTION

Exceeding the maximum charging rate for the battery can shorten its life.

Never exceed the maximum charging rate.

Battery Removal

1. Place the motorcycle on the side stand.

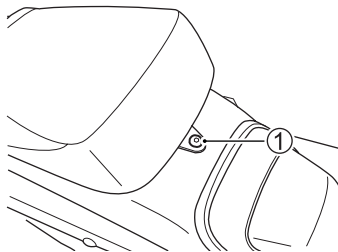

2. Remove the bolt ①.

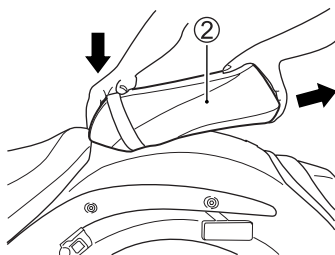

3. Push down the front end of the rear seat ② and pull the seat backward.

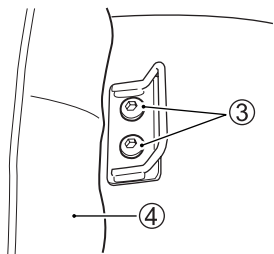

4. Remove the bolts ③ and front seat ④.

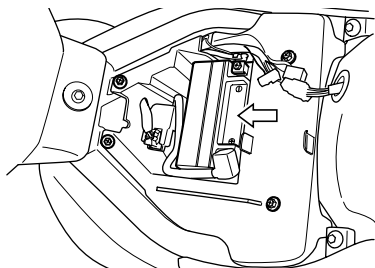

5. Remove the battery.

NOTE: Remove the negative terminal first and then remove the positive terminal.

6. To reinstall the battery, reverse the procedure above.

CAUTION

Reversing the battery lead wires can damage the charging system and the battery.

The red lead must go to the positive (+) terminal and the black (or black with white tracer) lead must go to the negative (-) terminal.

AIR CLEANER

The air cleaner element must be kept clean to provide good engine power and gas mileage. If you use your motorcycle under normal low stress conditions, you should service the air cleaner at the intervals specified. If you ride in dusty, wet, or muddy conditions, you will need to inspect the air cleaner element much more frequently. Use the following procedure to remove the element and inspect it.

⚠ WARNING

Operating the engine without the air cleaner element in place could allow a flame to spit back from the engine to the air cleaner, or could allow dirt to enter the engine. This could cause a fire or severe engine damage.

Never run the engine without the air cleaner element properly installed.

CAUTION

Clean or replace the air cleaner element frequently if the motorcycle is used in dusty, wet or muddy conditions. The air cleaner element will clog under these conditions, and this may cause engine damage, poor performance, and poor fuel economy.

Clean the air cleaner case and element immediately if water gets in the air cleaner case.

Air Cleaner Element Removal

1. Place the motorcycle on the side stand.

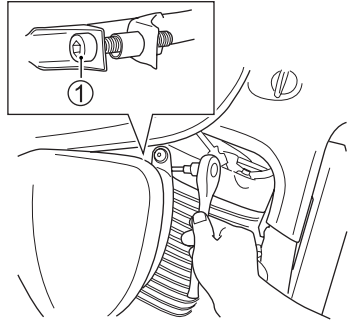

2. Loosen the clamp bolt ①.

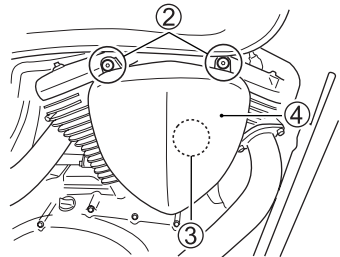

3. Remove the bolts ② and unhook the hook ③. Pull the air cleaner ④.

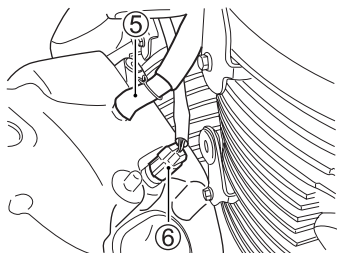

4. Disconnect the tube ⑤ and coupler ⑥.

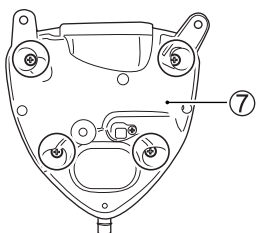

5. Remove the screws. Remove the air cleaner case ⑦.

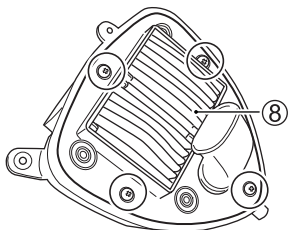

6. Remove the screws. Remove the air cleaner element ⑧.

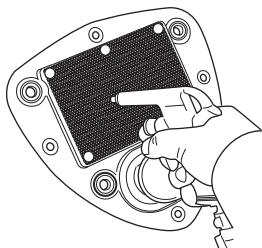

7. Carefully use an air hose to blow the dust from the air cleaner element.

NOTE: Always apply air pressure to the mesh side of the air cleaner element only. If you apply air pressure to the fabric side, dirt will be forced into the pores of the element, restricting the air flow through the element.

CAUTION

A torn air cleaner element will allow dirt to enter the engine and can damage the engine.

Carefully examine the air cleaner element for tears during cleaning. Replace it with a new one if it is torn.

8. Reinstall the air cleaner element in reverse order of removal. Be sure that the air cleaner element is securely in position and is properly sealed.

CAUTION

Failure to position the air cleaner element properly can allow dirt to bypass the air cleaner element. This will cause engine damage.

Be sure to properly install the air cleaner element.

Air Cleaner Drain Plug

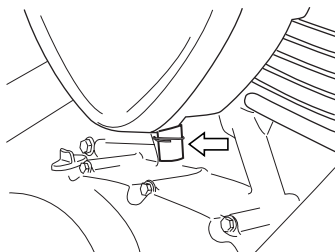

Remove the plug and drain water and oil at the periodic maintenance interval. The air cleaner drain plug is located beneath the air cleaner box.

SPARK PLUG

Your motorcycle comes equipped with DENSO X22EPR-U9, X22ESR-U (California) or NGK DPR7EA-9, DR7EA (California) spark plugs. To determine if the standard spark plug is right for your usage, check the color of the plug's porcelain center electrode insulator after motorcycle operation. A light brown color indicates that the plug is correct. A white or dark insulator indicates that the engine may need adjustment, or another plug type may be needed. Consult your authorized Suzuki dealer or a qualified mechanic if your plug insulator is not a light brown color.

CAUTION

An improper spark plug may have an incorrect fit or heat range for your engine. This may cause severe engine damage which will not be covered under warranty.

Use one of the spark plugs listed below or equivalent. Consult your authorized SUZUKI dealer or a qualified mechanic if you are not sure which spark plug is correct for your type of usage.

NGK	DENSO	REMARKS
DPR7EA-9	X22EPR-U9	Standard
DPR8EA-9	X24EPR-U9	If the standard plug is apt to overheat, replace with this plug.

California model

NGK	DENSO	REMARKS
DR7EA	X22ESR-U	Standard
DR8EA	X24ESR-U	If the standard plug is apt to overheat, replace with this plug.

NOTE: If the above-named plugs are not available, consult your authorized Suzuki dealer.

NOTE: This motorcycle uses resistor-type spark plug to avoid jamming electronic parts. Improper spark plug selection may cause electronic interference with your motorcycle's ignition system, resulting in motorcycle performance problems. Use only the recommended spark plugs.

Spark Plug Removal

1. Place the motorcycle on the side stand.
2. Remove the air cleaner by referring to the AIR CLEANER section.

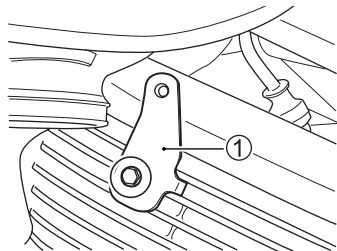

3. Remove the bolt and air cleaner bracket ①.

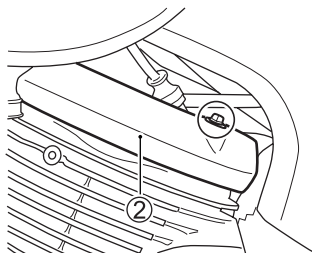

FRONT

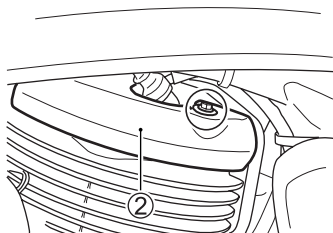

REAR

4. Remove the bolt and open the cover ②.

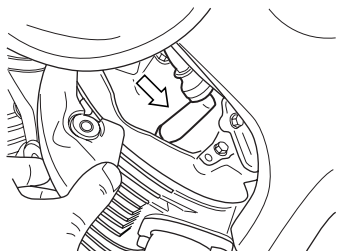

FRONT

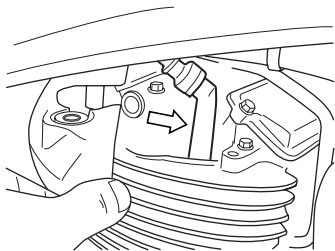

REAR

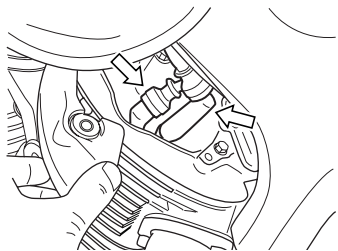

FRONT (California model)

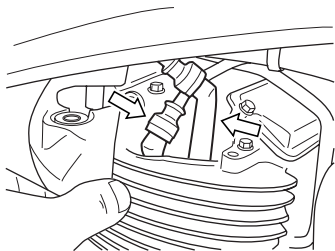

REAR (California model)

5. Pull off the spark plug caps.
6. Remove the spark plugs with a spark plug wrench.

SPARK PLUG CLEANING

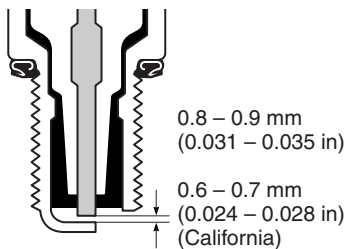

To maintain a hot, strong spark, keep the plugs free from carbon. Adjust the gap to 0.8 – 0.9 mm (0.031 – 0.035 in), 0.6 – 0.7 mm (0.024 – 0.028 in) (California) for good ignition. Use a thickness (feeler) gauge to check the gap.

Installation

CAUTION

A crossthreaded or overtightened spark plug will damage the aluminum threads of the cylinder head.

Follow the procedure below to tighten the spark plug properly.

Carefully turn the spark plug by hand into the threads until it is finger tight. If the spark plug is new, tighten it with a wrench about 1/2 turn past finger tight. If you are reusing the old spark plug, tighten it with a wrench about 1/8 turn past finger tight.

CAUTION

Dirt can damage your engine if it enters an open spark plug hole.

Cover the spark plug hole whenever the spark plug is removed.

ENGINE OIL

Engine life depends on oil amount and quality. Daily engine oil level checks and periodic changes are two of the most important maintenance items to be performed.

Engine Oil Level Check

Follow the procedure below to inspect the engine oil level.

1. Start the engine and allow it to idle for a few minutes.
2. Stop the engine and wait approximately three minutes.

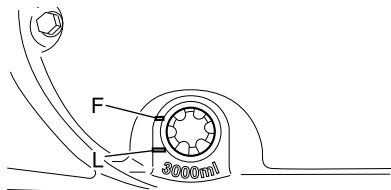

3. Hold the motorcycle vertically and inspect the engine oil level through the engine oil level inspection window. The engine oil level should be between the "L" (low) and "F" (full) lines.

CAUTION

The engine oil level must be between the "L" (Low) line and "F" (Full) line, or engine damage may occur.

Check the oil level, through the inspection window, with the motorcycle held vertically on level ground before each use of the motorcycle.

ENGINE OIL AND FILTER CHANGE

Change the engine oil and oil filter at the scheduled times. The engine should always be warm when the engine oil is changed so the engine oil will drain easily. The procedure is as follows:

1. Place the motorcycle on level ground on the side stand.

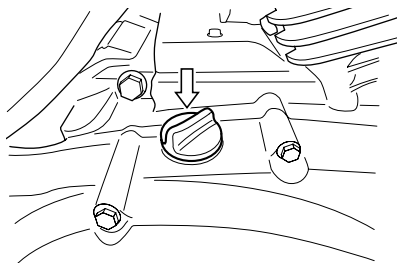

2. Remove the oil filler cap.

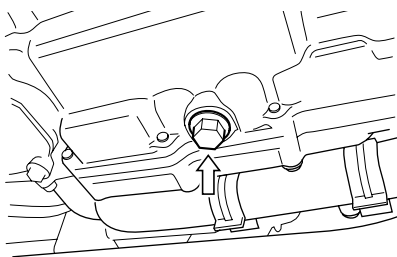

3. Remove the drain plug from the bottom of the engine and drain the engine oil into a drain pan.

▲ WARNING

Engine oil and exhaust pipes can be hot enough to burn you.

Wait until the engine oil drain plug and exhaust pipes are cool enough to touch with bare hands before draining oil.

⚠ WARNING

New and used oil can be hazardous. Children and pets may be harmed by swallowing new or used oil. Repeated, prolonged contact with used engine oil may cause skin cancer. Brief contact with used oil may irritate skin.

- Keep new and used oil away from children and pets.
- Wear a long-sleeve shirt and waterproof gloves.
- Wash with soap if oil contacts your skin.

NOTE: Recycle or properly dispose of used oil.

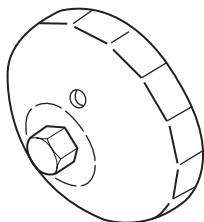

Oil filter wrench
(Part No. 09915-40620)

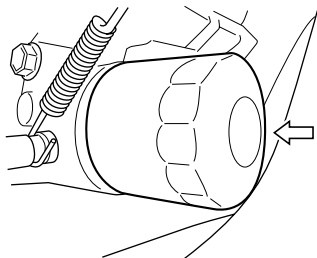

4. Turn the oil filter with a Suzuki “cap type” oil filter wrench or a “strap type” filter wrench of the proper size and remove the oil filter.

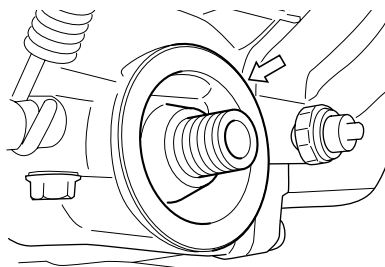

5. Wipe off the mounting surface on the engine where the new filter will be seated with a clean rag.

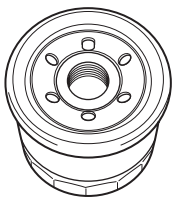

6. Smear a little engine oil around the rubber gasket of the new oil filter.

CAUTION

Using an oil filter with the wrong design or thread specifications can cause oil leaks or engine damage.

Use a genuine SUZUKI oil filter or an equivalent filter designed for your motorcycle.

7. Screw the new filter by hand until the filter gasket contacts the mounting surface (a small resistance will be felt).

NOTE: To tighten the oil filter properly, it is important to accurately identify the position at which the filter gasket first contacts the mounting surface.

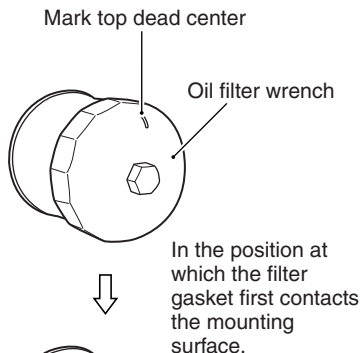

In the position at which the filter gasket first contacts the mounting surface.

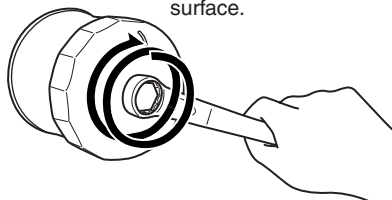

Tighten the filter 2 turns or to specified torque.

8. Mark the top dead center position on the "cap type" filter wrench or on the oil filter. Use an oil filter wrench to tighten the filter 2 turns or to specified torque.

Oil filter tightening torque:
20 N·m (2.0 kgf·m, 14.5 lbf·ft)

9. Reinstall the drain plug and gasket. Tighten the plug securely with a wrench.

10. Reinstall the drain plug and tighten it securely. Pour about 3400 ml (3.6 US qt) of the specified oil in the filler hole. (See FUEL, OIL AND COOLANT RECOMMENDATION section.)

NOTE: About 3000 ml (3.2 US qt) of oil will be required when changing oil only.

CAUTION

Engine damage may occur if you use oil that does not meet SUZUKI's specifications.

Use the oil specified in the FUEL, OIL AND COOLANT RECOMMENDATION section.

11. Reinstall the oil filler cap. Start the engine (while the motorcycle is outside on level ground) and allow it to idle for a few minutes.
12. Turn the engine off and wait approximately 3 minutes. Hold the motorcycle vertically and recheck the oil level on the engine oil inspection window. The oil level should be at the "F" (full) mark. If it is lower than the "L" mark, add oil until it reaches the "F" mark. Inspect the areas around the drain plug and oil filter for leaks.

ENGINE IDLE SPEED INSPECTION

Inspect the engine idle speed. The engine idle speed should be 1000 – 1200 r/min when the engine is warm.

NOTE: If the engine idle speed is not within the specified range, ask your Suzuki dealer or a qualified mechanic to inspect and repair the motorcycle.

THROTTLE CABLE ADJUSTMENT

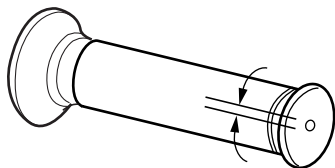
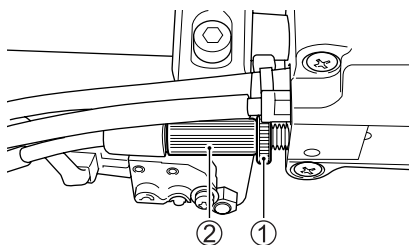

2.0 – 4.0 mm
(0.08 – 0.16 in)

To adjust the cable play:

1. Loosen the lock nut ①.
2. Turn the adjuster ② so that the throttle grip has 2.0 – 4.0 mm (0.08 – 0.16 in) play.
3. Tighten the lock nut ①.

▲ WARNING

Inadequate throttle cable play can cause engine speed to rise suddenly when you turn the handlebar. This can lead to loss of rider control.

Adjust the throttle cable play so that engine idle speed does not rise due to handlebar movement.

FUEL HOSE

Fuel Tank Lift

1. Place the motorcycle on the side stand. Remove the seat by referring to the BATTERY section.

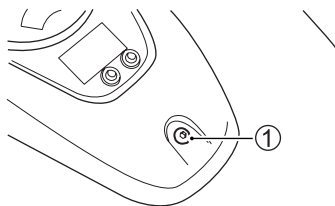

2. Remove the bolt ①.

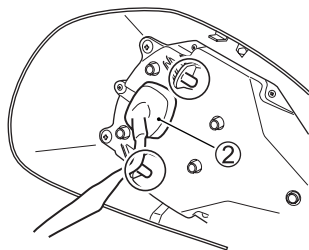

3. Unhook the hooks. Disconnect the coupler ② and remove the instrument panel assembly.

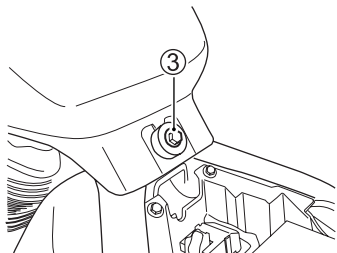

4. Remove the bolt ③. Raise the rear end of the fuel tank and slide it backward.

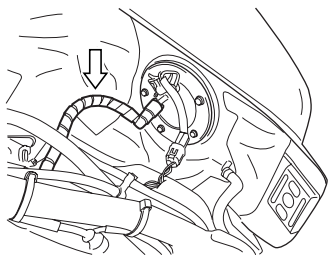
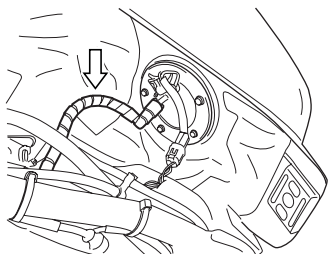

(For California)

5. Inspect the fuel hose for damage and fuel leakage. If any defects are found, the fuel hose must be replaced.

NOTE: Lifting up the fuel tank too much can result in the fuel hose becoming bent or twisted. Lift the fuel tank as little as possible and disconnect the fuel hose. The fuel tank in the above illustration is lifted to show the fuel hose and coupler clearly.

CLUTCH ADJUSTMENT

Clutch cable play should be 10 – 15 mm (0.4 – 0.6 in) measured at the clutch lever end. Adjust clutch cable play according to the following procedure:

Minor Adjustment

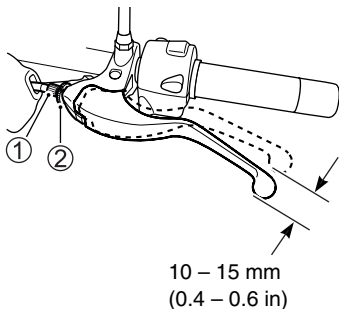

Loosen the lock nut (2). Turn the clutch cable adjuster (1) to provide the specified play.

Major Adjustment

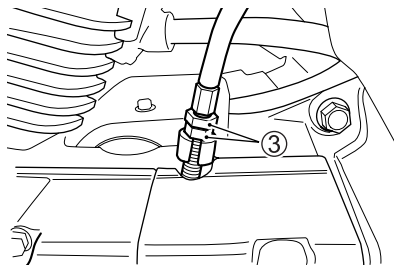

1. Loosen the lock nuts (3). Turn the lock nuts (3) counterclockwise.

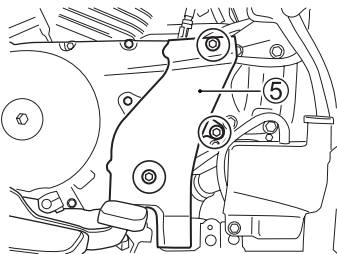
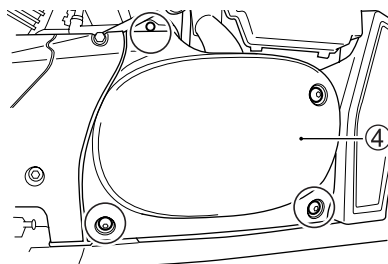

2. Remove the bolts. Remove the covers (4) and (5).

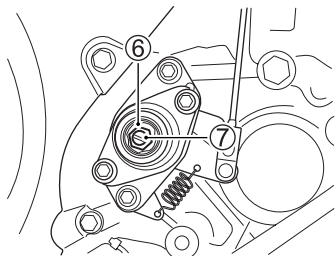

3. Loosen the lock nut ⑥.
4. Turn in the adjuster ⑦ until it stops. Turn back the adjuster ⑦ 1/4 turns.
5. Hold the adjuster ⑦ with a screwdriver and tighten the lock nut ⑥.
6. Turn the lock nuts ③ to obtain approximately 10 – 15 mm (0.4 – 0.6 in) of free play at the clutch lever end as indicated.
7. If proper free play is not available, loosen and turn the lock nuts ③ until clutch lever has proper free play.
8. Tighten the lock nuts ② and ③.

NOTE: Minor adjustment can be performed at the clutch lever side adjuster only.

ENGINE COOLANT

Coolant level

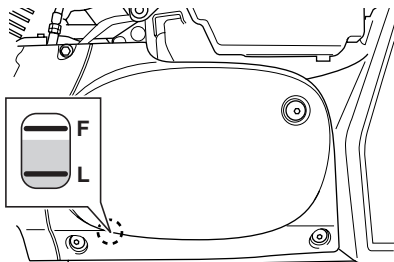

The engine coolant solution should be between “F” (full) and “L” (low) level lines on the engine coolant reservoir. If the level is lower than “L” (low) level line, bring it up to “F” (full) level by adding 50:50 mixture of distilled water and engine coolant.

To add mixed coolant:

1. Place the motorcycle on the side stand.

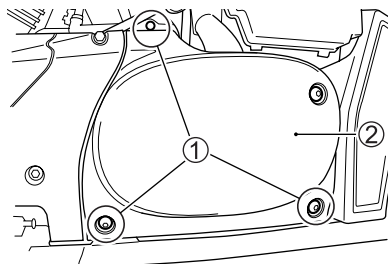

2. Remove the bolts ① and cover ②.

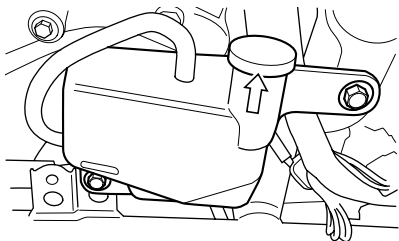

3. Remove the filler cap and add properly mixed coolant through the filler hole.

⚠ WARNING

Engine coolant is harmful or fatal if swallowed or inhaled.

Do not drink antifreeze or coolant solution. If swallowed, do not induce vomiting. Immediately contact a poison control center or a physician. Avoid inhaling mist or hot vapors; if inhaled, remove to fresh air. If coolant gets in eyes, flush eyes with water and seek medical attention. Wash thoroughly after handling. Solution can be poisonous to animals. Keep out of the reach of children and animals.

NOTE: Adding only water will dilute the engine coolant and reduce its effectiveness. Add a 50:50 mixture of engine coolant and water.

FINAL GEAR OIL

Change the gear oil as follows:

1. Place the motorcycle on the side stand.

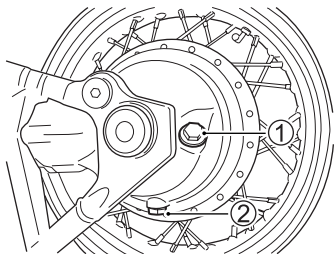

2. Remove the oil filler cap ①.
3. Drain the oil into a suitable container by removing the drain plug ② from the bottom of the final gear case.
4. Reinstall the drain plug and tighten it securely after all the oil has been drained out. Hold the motorcycle vertically and pour fresh oil through the filler hole until the oil level reaches the oil filler hole. Approximately 200 – 220 ml (6.8 – 7.4 US oz) of oil will be required.
5. Reinstall the oil filler cap.

WARNING

Operating the motorcycle with too little final gear oil can cause the final drive unit to lock up and cause an accident.

Check for leaks and the correct level of final gear oil before each use. Add oil if necessary. Tighten the drain plug securely after changing the gear oil.

WARNING

New and used oil can be hazardous. Children and pets may be harmed by swallowing new or used oil. Repeated, prolonged contact with used engine oil may cause skin cancer. Brief contact with used oil may irritate skin.

- Keep new and used oil away from children and pets.
- Wear a long-sleeve shirt and waterproof gloves.
- Wash with soap if oil contacts your skin.

NOTE: Recycle or properly dispose of used oil.

BRAKES

This motorcycle has front disk and rear drum brakes.

WARNING

Failure to inspect and properly maintain the brakes increases your chance of having an accident.

Inspect the brake system before each use according to the **INSPECTION BEFORE RIDING** section. Follow the **MAINTENANCE SCHEDULE** section to maintain your brake system.

*NOTE: Operating in mud, water, sand or other extreme conditions can cause accelerated brake wear. If you operate your motorcycle under these conditions, the brakes must be inspected more often than recommended in the **MAINTENANCE SCHEDULE**.*

FRONT BRAKE Brake Fluid

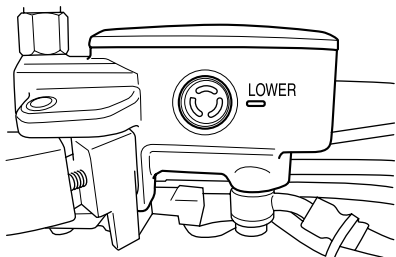

Check the brake fluid level in the front brake fluid reservoir and inspect for brake pad wear and leaks.

▲ WARNING

Failure to keep the brake fluid reservoir full with proper brake fluid can be hazardous. The brakes may not work correctly without the proper amount and type of brake fluid. This could lead to an accident.

Inspect the brake fluid level before each use. Use only DOT4 brake fluid from a sealed container. Never use or mix different types of brake fluid. If there is frequent loss of fluid, take your motorcycle to a SUZUKI dealer or a qualified mechanic for inspection.

▲ WARNING

Brake fluid is harmful or fatal if swallowed, and harmful if it comes in contact with skin or eyes.

If swallowed, do not induce vomiting. Immediately contact a poison control center or a physician. If brake fluid gets in eyes, flush eyes with water and seek medical attention. Wash thoroughly after handling. Solution can be poisonous to animals. Keep out of the reach of children and animals.

CAUTION

Spilled brake fluid can damage painted surfaces and plastic parts.

Avoid spilling any fluid when filling the reservoir. Wipe up spills immediately.

Brake Pads

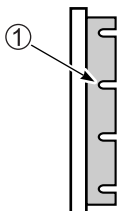
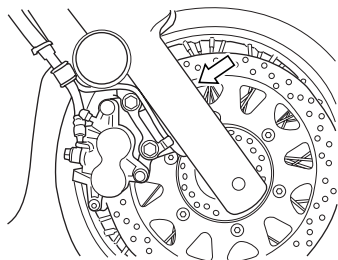

Inspect the front brake pads to see if they are worn down to the grooved wear limit lines ①. If a pad is worn to the grooved wear limit line, it must be replaced with a new one. After replacing the front brake pads, the brake lever must be pumped several times. This will extend the pads to their proper position.

⚠ WARNING

Riding with worn brake pads will reduce braking performance and will increase your chance of having an accident.

Inspect brake pad wear before each use. Ask your SUZUKI dealer or a qualified mechanic to replace brake pads if any pad is worn to the limit.

⚠ WARNING

Failure to extend brake pads after repair or replacement can cause poor braking performance and may result in an accident.

Before riding, “pump” the brake repeatedly until brake pads are pressed against the brake disk and proper lever stroke and firm feel are restored.

NOTE: Do not squeeze the brake lever when the pads are not in their positions. It is difficult to push the pistons back into position.

Rear Brake Pedal Adjustment

The rear brake pedal position and the free travel must be properly adjusted. Adjust the brake pedal in the following manner:

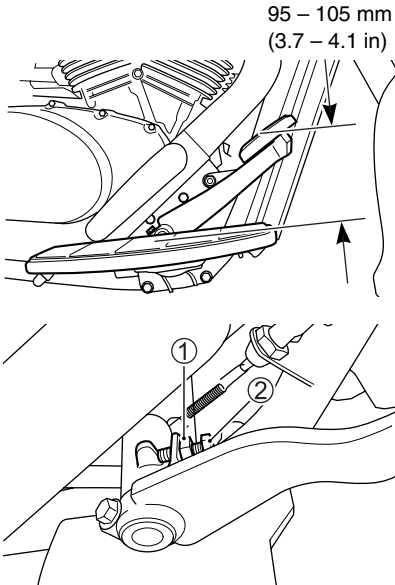

1. Loosen the lock nut ① for the pedal stopper bolt.
2. Adjust the brake pedal height by turning the pedal stopper bolt ② to locate the pedal 95 – 105 mm (3.7 – 4.1 in) above the top face of the footrest.
3. Tighten the lock nut.

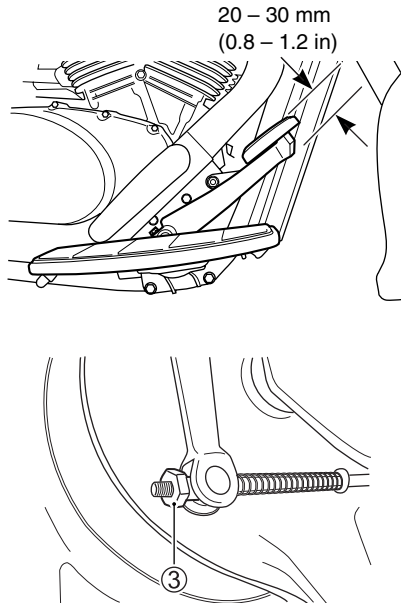

4. Adjust the free travel to 20 – 30 mm (0.8 – 1.2 in) by turning in or out the brake adjusting nut ③.

Brake Lining Wear Limit

The motorcycle is equipped with the brake lining wear limit indicator on rear brake. To check wear of the brake lining perform the following:

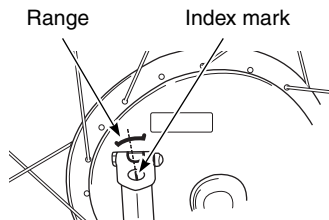

Fig.A The extension line of the index mark is within the range.

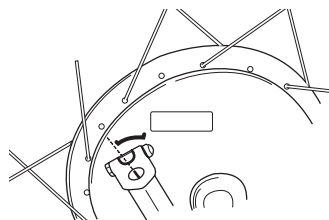

Fig.B The extension line of the index mark is out of the range.

1. Make sure the brake play is properly adjusted.
2. While fully applying the brake check to see that the extension line of the index mark is within the range on the brake panel as shown in Fig A.

3. If the extension line is out side this range as shown in the Fig. B, have the brake shoes replaced by your authorized Suzuki dealer or a qualified mechanic.

⚠ WARNING

Riding with worn brake shoes will reduce braking performance and will increase your chance of having an accident.

Inspect brake shoe wear before each use. Ask your SUZUKI dealer or a qualified mechanic to replace brake shoes if the shoes are worn to the limit.

REAR BRAKE LIGHT SWITCH

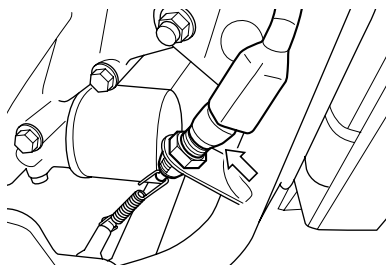

The rear brake light switch is located by the brake pedal pivot. To adjust the brake light switch, hold the switch body and turn the adjuster so that the brake light will come on just before a pressure rise is felt when the brake pedal is depressed.

WARNING

Failure to follow these warnings may result in an accident due to tire failure. The tires on your motorcycle form the crucial link between your motorcycle and the road.

Follow these instructions:

- Check tire condition and pressure, and adjust pressure before each ride.
- Avoid overloading your motorcycle.
- Replace a tire when worn to the specified limit, or if you find damage such as cuts or cracks.
- Always use the size and type of tires specified in this owner's manual.
- Balance the wheel after tire installation.
- Read this section of the owner's manual carefully.

WARNING

Failure to perform break-in of the tires could cause tire slip and loss of control.

Use extra care when riding on new tires. Perform proper break-in of the tires referring to the **BREAK-IN** section and avoid hard acceleration, hard cornering, and hard braking for the first 160 km (100 miles).

Tire Pressure and Loading

Proper tire pressure and proper tire loading are important factors. Overloading your tires can lead to tire failure and loss of motorcycle control.

Check tire pressure each day before you ride, and adjust tire pressure according to the table below. Tire pressure should only be checked and adjusted before riding since riding will heat up the tires and lead to higher inflation pressure readings.

VL800

LOAD TIRE	SOLO RIDING WITH LIGHT OR LITTLE CARGO LOAD	DUAL RIDING OR SOLO RIDING WITH HEAVY CARGO LOAD
FRONT	200 kPa 2.00 kgf/cm ² 29 psi	200 kPa 2.00 kgf/cm ² 29 psi
REAR	250 kPa 2.50 kgf/cm ² 36 psi	250 kPa 2.50 kgf/cm ² 36 psi

VL800T/C

LOAD TIRE	SOLO RIDING WITH LIGHT OR LITTLE CARGO LOAD	DUAL RIDING OR SOLO RIDING WITH HEAVY CARGO LOAD
FRONT	225 kPa 2.25 kgf/cm ² 33 psi	225 kPa 2.25 kgf/cm ² 33 psi
REAR	250 kPa 2.50 kgf/cm ² 36 psi	250 kPa 2.50 kgf/cm ² 36 psi

Under-inflated tires make smooth cornering difficult, and can result in rapid tire wear. Over-inflated tires cause a smaller amount of tire to be in contact with the road, which can contribute to skidding and loss of control.

NOTE: When you detect drops in tire pressure, check the tire for nails or other punctures, or a damaged wheel rim. Tubeless tires sometimes lose pressure gradually when punctured.

Tire Condition and Type

Tire condition and tire type affect motorcycle performance. Cuts or cracks in the tires can lead to tire failure and loss of motorcycle control. Worn tires are susceptible to puncture failures and subsequent loss of motorcycle control. Tire wear also affects the tire profile, changing motorcycle handling characteristics.

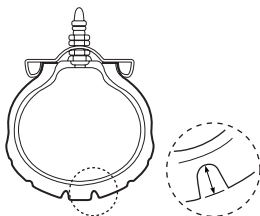

Check the condition of your tires each day before you ride. Replace tires if tires show visual evidence of damage, such as cracks or cuts, or if tread depth is less than 1.6 mm (0.06 in) front, 2.0 mm (0.08 in) rear.

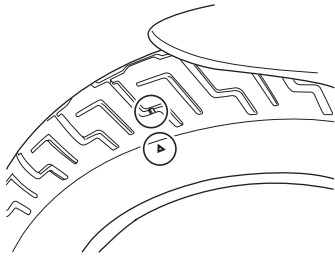

NOTE: The "Triangle mark" indicates the place where the wear bars are molded into the tire. When the wear bars contact the road, it indicates that the tire wear limit has been reached.

Whenever you replace a tire, use a tire of the size and type listed below. If you use a different size or type of tire, motorcycle handling may be adversely affected, possibly resulting in loss of motorcycle control.

VL800

	FRONT	REAR
SIZE	130/90-16M/C 67H	170/80-15M/C 77H
TYPE	IRC GS-23F	IRC GS-23R

VL800T

	FRONT	REAR
SIZE	130/90-16M/C 67H	170/80-15M/C 77H
TYPE	IRC GS-23F RW	IRC GS-23R RW

VL800C

	FRONT	REAR
SIZE	130/90-16M/C 67H	170/80-15M/C 77H
TYPE	IRC GS-23F D	IRC GS-23R D

Always balance the wheel after repairing a puncture or replacing the tire. Proper wheel balance is important to avoid variable wheel-to-road contact, and to avoid uneven tire wear.

▲ WARNING

An improperly repaired, installed, or balanced tire can cause loss of control or shorten tire life.

- Ask your SUZUKI dealer or a qualified mechanic to perform tire repair, replacement, and balancing because proper tools and experience are required.
- Install tires according to the rotation direction shown by arrows on the sidewall of each tire.

▲ WARNING

Failure to follow these instructions about tubeless tires may result in an accident due to tire failure. Tubeless tires require different service procedures than tube tires.

- Tubeless tires require an air-tight seal between the tire bead and wheel rim. Special tire irons and rim protectors or a specialized tire mounting machine must be used for removing and installing tires to prevent tire or rim damage which could result in an air leak.
- Repair a puncture in tubeless tires by removing the tire and applying an internal patch.
- Do not use an external repair plug to repair a puncture since the plug may work loose as a result of the cornering forces experienced in a motorcycle tire.
- After repairing a tire, do not exceed 80 km/h (50 mph) for the first 24 hours, 130 km/h (80 mph) thereafter. This is to avoid excessive heat build-up which could result in a tire repair failure and tire deflation.
- Replace the tire if it is punctured in the sidewall area, or if a puncture in the tread area is larger than 6 mm (3/16 in). These punctures cannot be repaired adequately.

SIDE STAND/IGNITION INTERLOCK SYSTEM

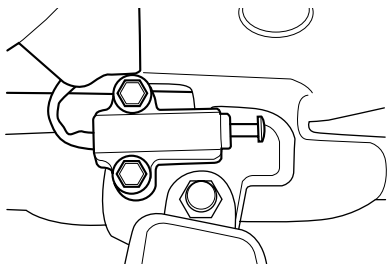

Check the side stand/ignition interlock system for proper operation as follows:

1. Sit on the motorcycle in the normal riding position, with the side stand up.
2. Shift into first gear, hold the clutch in, and start the engine.
3. While continuing to hold the clutch in, move the side stand to the down position.

If the engine stops running when the side stand is moved to the down position, then the side stand/ignition interlock system is working properly. If the engine continues to run with the side stand down and the transmission in gear, then the side stand/ignition interlock system is not working properly. Have your motorcycle inspected by an authorized Suzuki dealer or some other qualified service mechanic.

WARNING

If the side stand/ignition interlock system is not working properly, it is possible to ride the motorcycle with the side stand in the down position. This may interfere with rider control during a left turn.

Check the side stand/ignition interlock system for proper operation before riding. Check that the side stand is returned to its full up position before starting off.

FRONT WHEEL REMOVAL

1. Place the motorcycle on the side stand.

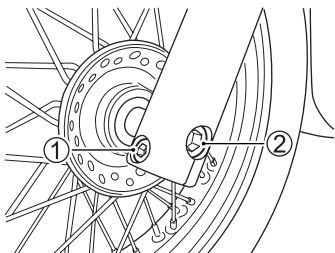
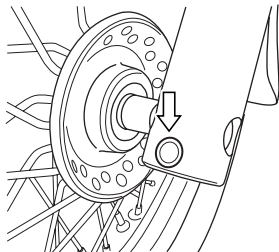

2. Remove the cap. Loosen the axle holder bolt ①. Loosen the axle ② temporarily.

NOTE: A special tool is necessary to loosen the axle. The special tool is available from a Suzuki dealer.

3. Place an accessory service stand or equivalent under the swing arm to help stabilize the rear end. Carefully position a jack under the engine or chassis tubes and raise the jack until the front wheel is slightly off the ground.

CAUTION

Improper jacking may cause damage to the oil filter.

Do not apply the jack head to the oil filter when jacking up the motorcycle.

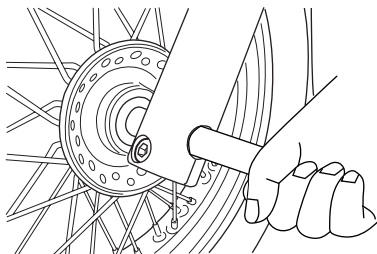

4. Turn the axle counterclockwise and draw it out.

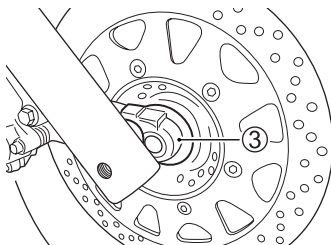

5. Remove the speedometer gear box ③.

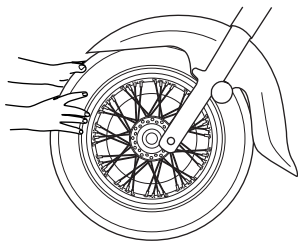

6. Slide the front wheel forward.

NOTE: Never squeeze the front brake lever with the wheel removed. It is very difficult to force the pads back into the caliper assembly.

7. To reinstall the wheel assembly, reverse the sequence described above.
8. After installing the wheel, apply the front brake several times to restore the proper lever stroke.

▲ WARNING

Failure to extend brake pads after installing the wheel can cause poor braking performance and may result in an accident.

Before riding, “pump” the brake repeatedly until the brake pads are pressed against the brake disks and proper lever stroke and firm feel are restored. Also check that the wheel rotates freely.

▲ WARNING

Failure to torque bolts and nuts properly could lead to an accident.

Torque bolts and nuts to the proper specifications. If you are not sure of the proper procedure, have your authorized **SUZUKI** dealer or a qualified mechanic do this.

Front axle tightening torque:
65 N·m (6.5 kgf·m, 47.0 lbf·ft)

Front axle holder bolt tightening torque:
33 N·m (3.3 kgf·m, 24.0 lbf·ft)

NOTE: Be careful not to damage the oil seal when installing the front wheel.

REAR WHEEL REMOVAL

▲ WARNING

Removing the rear wheel without use of an accessory stand can result in your motorcycle falling over and being damaged.

Do not attempt road side removal of the rear wheel. Only remove the rear wheel at a properly equipped servicing facility using an accessory service stand.

1. Place the motorcycle on the side stand. Remove the seat by referring to the BATTERY section.

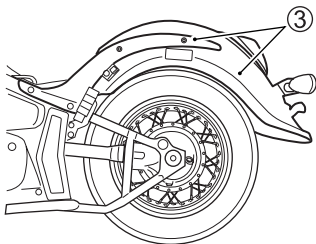
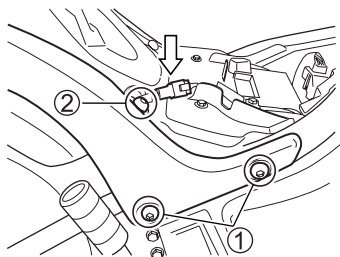

2. Disconnect the coupler. Remove the bolts ①, ②. Remove the right and left rear frame with a rear fender ③.

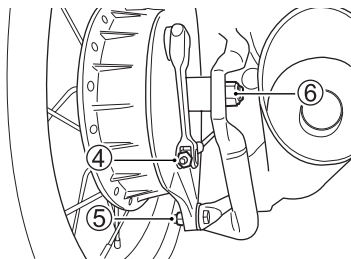

3. Remove the brake adjuster nut ④ and torque link nut ⑤. Remove the axle nut ⑥.

▲ WARNING

A hot muffler can burn you. The muffler will be hot enough to burn you for some time after stopping the engine.

Wait until the muffler cools to avoid burns.

4. Place an accessory service stand or equivalent under the swingarm or chassis tubes to stabilize the rear end.

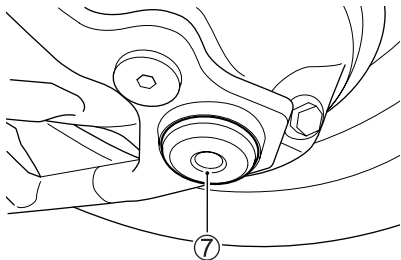

5. Remove the cap ⑦.

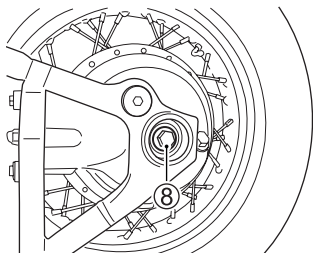

6. Draw out the axle ⑧.

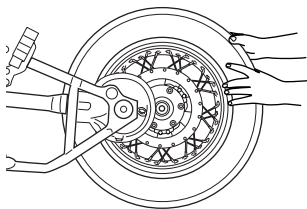

7. Remove the wheel from the splined drive gear and set the wheel assembly on the ground.

8. Pull the wheel assembly rearward.
9. To replace the wheel reverse the complete sequence described above.

⚠ WARNING

Failure to torque bolts and nuts properly and to properly apply thread lock to specified bolts and nuts could lead to an accident.

Torque bolts and nuts to the proper specifications. Properly apply thread lock to specified bolts. If you are not sure of the proper procedure, have your authorized SUZUKI dealer or a qualified mechanic do this.

Rear axle tightening torque:
65 N·m (6.5 kgf·m, 47.0 lbf·ft)

Rear torque link nut
tightening torque:
25 N·m (2.5 kgf·m, 18.0 lbf·ft)

NOTE: Apply a drop of SUZUKI THREAD LOCK "1322" to the rear frame mounting bolt ①, ②.

Rear frame mounting bolt
tightening torque:
50 N·m (5.0 kgf·m, 36.0 lbf·ft)

LIGHT BULB REPLACEMENT

The wattage rating of each bulb is shown in the following chart. When replacing a burned out bulb, always use the same wattage rating.

CAUTION

Using a light bulb with the wrong wattage rating can cause electrical system damage or shorten bulb life.

Always use the specified light bulb.

Headlight	12V 60/55W (H4)	
Turn signal light	Front	12V 21/5W
	Rear	12V 21W
License plate light	12V 5W	

Headlight

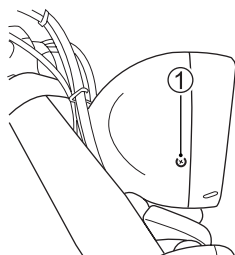
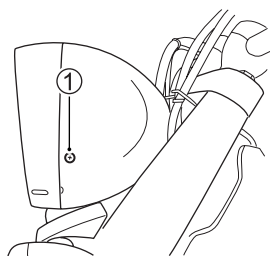

1. Remove right and left screws ①. Remove the headlight assembly.

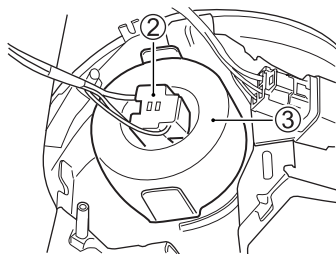

2. Disconnect socket ② from the headlight and rubber cap ③.

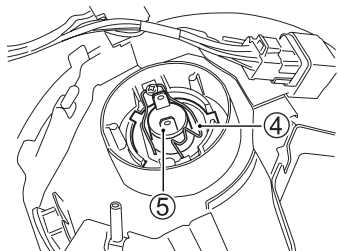

3. Unhook bulb holder spring ④, and pull out the bulb ⑤.

CAUTION

Oil from your skin may damage the headlight bulb or shorten its life.

Grasp the new bulb with a clean cloth.

4. To replace the headlight bulb, reverse the above sequence.

Headlight Beam Adjustment

The headlight beam can be adjusted both right and left or up and down if necessary.

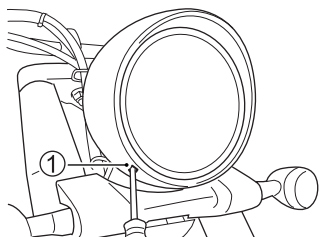

To adjust the beam right and left:
Turn the adjuster ① clockwise or counterclockwise.

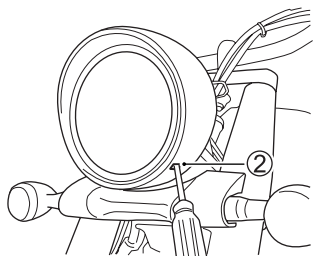

To adjust the beam up and down:
Turn the adjuster ② clockwise or counterclockwise.

Turn Signal Light

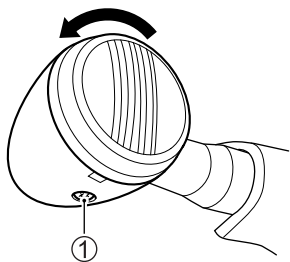

1. Remove the screw ①.
2. Turn the lens counterclockwise and remove it.

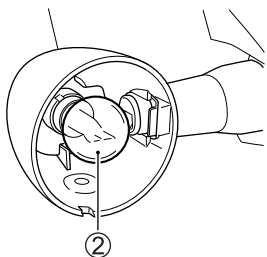

3. Push in on the bulb ②, turn it to the left, and pull it out.
4. To fit the replacement bulb, push it in and turn it to the right while pushing.

CAUTION

Overtightening the screws when reinstalling the lens may cause the lens to crack.

Tighten the screws only until they are snug.

License Plate Light

To replace the license plate light bulb, follow the procedure below:

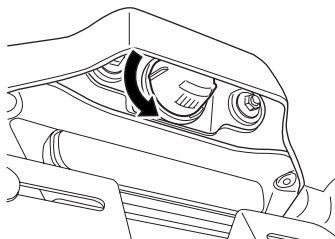

1. Turn the license plate lens counterclockwise and remove it.

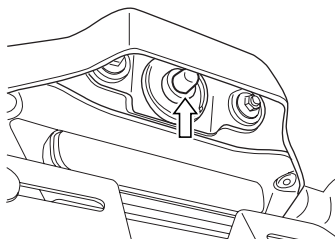

2. Pull off the bulb from the socket.

FUSES

MAIN FUSE

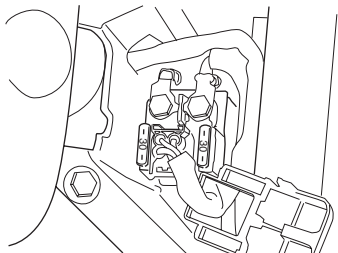

The main fuse is located under the front seat. To access the fuse, remove the seat by referring to the BATTERY section.

One 30A spare fuse is located in the fuse box.

FUSES

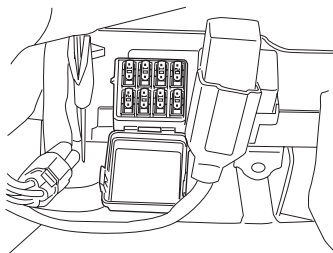

The fuses are located behind the left crank case cover. To access the fuses, remove the left crank case cover referring to the ENGINE COOLANT section.

Two spare fuses (one 10A and one 20A) are provided inside the fuse box.

The fuses are designed to open when an overload exists in individual electrical system circuits. If any electrical system fails to operate, then the fuses must be checked.

CAUTION

Installing a fuse of incorrect rating or using aluminum foil or wire instead of a fuse may seriously damage the electrical system.

Always replace a blown fuse with a fuse of the same type and rating. If the new fuse blows in a short time, consult your SUZUKI dealer or a qualified mechanic immediately.

FUSE LIST

- 30A MAIN fuse protects all electrical circuits.
- 10A HEAD-HI fuse protects the speedometer and headlight high beam.
- 10A HEAD-LO fuse protects the headlight low beam.
- 10A FUEL fuse protects the ECU, fuel pump, injectors and speedometer.
- 20A IGNITION fuse protects the *oxygen sensor, solenoids, ECU, fuel pump relay, fan motor relay, starter relay, ignition coils, *canister purge solenoid, headlight relay and side stand relay.
- 10A SIGNAL fuse protects the horn, speedometer, pilot lamp, stop lamp, running lamp and resister.
- 10A POWER SOURCE fuse protects the electrical accessories connected to output terminal.

* For California



TROUBLESHOOTING

FUEL SUPPLY CHECK	8-2
IGNITION SYSTEM CHECK	8-3

TROUBLESHOOTING

This troubleshooting guide is provided to help you find the cause of some common complaints.

CAUTION

Failure to troubleshoot a problem correctly can damage your motorcycle. Improper repairs or adjustments may damage the motorcycle instead of fixing it. Such damage may not be covered under warranty.

If you are not sure about the proper action, consult your authorized Suzuki dealer or a qualified mechanic about the problem.

COMPLAINT: Engine is hard to start or does not start at all.

FUEL SUPPLY CHECK

If the fuel injection indicator displays “FI”, showing signs of trouble in the fuel injection system, take your machine to an authorized Suzuki dealer. Refer to the “INSTRUMENT PANEL” section for an explanation of the fuel injection system indicator. If the indicator does not display “FI”, make sure there is enough fuel in the fuel tank. If the indicator does not display “FI” and there is enough fuel, the ignition system should be checked.

IGNITION SYSTEM CHECK

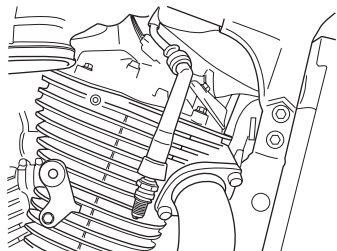

1. Remove the spark plugs and reattach them to the spark plug caps.
2. Put the engine stop switch in the “O” position and the ignition switch in the “ON” position. While holding the spark plug with its base firmly against the engine, push the electric starter button. If the ignition system is operating properly, a blue spark should jump across the spark plug gap. If there is no spark, take your machine to your authorized Suzuki dealer or a qualified mechanic.

WARNING

Performing the spark test improperly can cause a high voltage electrical shock or an explosion.

Avoid performing this check if you are not familiar with this procedure, or if you have a heart condition or wear a pacemaker. Keep the spark plug away from the spark plug hole during this test.

COMPLAINT: Engine stalls.

1. Make sure there is enough fuel in the fuel tank.
2. If the fuel injection indicator displays “FI”, showing signs of trouble in the fuel injection system, take your machine to an authorized Suzuki dealer. Refer to the “INSTRUMENT PANEL” section for an explanation of the fuel injection system indicator.
3. Check the ignition system for intermittent spark.
4. Check the idle speed. If necessary, adjust it using a tachometer. The correct idle speed is 1000 – 1200 r/min.



STORAGE PROCEDURE AND MOTORCYCLE CLEANING

STORAGE PROCEDURE	9-2
PROCEDURE FOR RETURNING TO SERVICE	9-3
CORROSION PREVENTION	9-4
MOTORCYCLE CLEANING	9-5
INSPECTION AFTER CLEANING	9-6

STORAGE PROCEDURE AND MOTORCYCLE CLEANING

STORAGE PROCEDURE

If your motorcycle is to be left unused for an extended period of time, it needs special servicing requiring appropriate materials, equipment and skill. For this reason, Suzuki recommends that you trust this maintenance work to your authorized Suzuki dealer. If you wish to service the machine for storage yourself, follow the general guidelines below:

MOTORCYCLE

Clean the entire motorcycle. Place the motorcycle on the side stand on a firm, flat surface where it will not fall over.

FUEL

1. Fill the fuel tank to the top with fuel mixed with the amount of gasoline stabilizer recommended by the stabilizer manufacturer.
2. Run the engine for a few minutes until the stabilized gasoline fills the fuel injection system.

ENGINE

1. Pour one tablespoon of motor oil into each spark plug hole. Reinstall the spark plugs and crank the engine a few times.
2. Drain the engine oil thoroughly and refill the crankcase with fresh engine oil all the way up to the filler hole.
3. Cover the air cleaner intake and the muffler outlet with oily rags to prevent humidity from entering.

BATTERY

1. Remove the battery from the motorcycle.
2. Clean the outside of the battery with a mild soap and remove corrosion from the terminals and wiring harness.
3. Store the battery in a room above freezing.

TIRES

Inflate the tires to the normal specifications.

EXTERNAL

- Spray all vinyl and rubber parts with rubber preservative.
- Spray the unpainted surfaces with rust preventative.
- Coat the painted surfaces with car wax.

MAINTENANCE DURING STORAGE

Once a month, recharge the battery. The standard charging rate is 1.2A x 5 to 10 hours.

PROCEDURE FOR RETURNING TO SERVICE

1. Clean the entire motorcycle.
2. Remove the oily rags from the air cleaner intake and muffler outlet.
3. Drain all the engine oil. Install a new oil filter and fill the engine with fresh oil as outlined in this manual.
4. Reinstall the battery.
5. Remove the spark plugs. Turn the engine a few times. Reinstall the spark plugs.
6. Make sure that the motorcycle is properly lubricated.
7. Perform the **INSPECTION BEFORE RIDING** as listed in this manual.
8. Start the motorcycle as outlined in this manual.

CORROSION PREVENTION

It is important to take good care of your motorcycle to protect it from corrosion and keep it looking new for years to come.

Important Information About Corrosion

Common causes of corrosion

- Accumulation of road salt, dirt, moisture, or chemicals in hard-to-reach areas.
- Chipping, scratches, and any damage to treated or painted metal surfaces resulting from minor accidents or impacts from stones and gravel.

Road salt, sea air, industrial pollution, and high humidity will all contribute to corrosion.

How to Help Prevent Corrosion

- Wash your motorcycle frequently, at least once a month. Keep your motorcycle as clean and dry as possible.
- Remove foreign material deposits. Foreign material such as road salt, chemicals, road oil or tar, tree sap, bird droppings and industrial fall-out may damage your motorcycle's finish. Remove these types of deposits as quickly as possible. If these deposits are difficult to wash off, an additional cleaner may be required. Follow the manufacturer's directions when using these special cleaners.
- Repair finish damage as soon as possible. Carefully examine your motorcycle for damage to the painted surfaces. Should you find any chips or scratches in the paint, touch them up immediately to prevent corrosion from starting. If the chips or scratches have gone through to the bare metal, have a Suzuki dealer make the repair.
- Store your motorcycle in a dry, well-ventilated area. If you often wash your motorcycle in the garage or if you frequently park it inside when wet, your garage may be damp. The high humidity may cause or accelerate corrosion. A wet motorcycle may corrode even in a heated garage if the ventilation is poor.

- Cover your motorcycle. Exposure to mid-day sun can cause the colors in paint, plastic parts, and instrument faces to fade. Covering your motorcycle with a high-quality, “breathable” motorcycle cover can help protect the finish from the harmful UV rays in sunlight, and can reduce the amount of dust and air pollution reaching the surface. Your Suzuki dealer can help you select the right cover for your motorcycle.

MOTORCYCLE CLEANING

Washing the Motorcycle

When washing the motorcycle, follow the instructions below:

1. Remove dirt and mud from the motorcycle with running water. You may use a soft sponge or brush. Do not use hard materials which can scratch the paint.
2. Wash the entire motorcycle with mild detergent or car wash soap using a sponge or soft cloth. The sponge or cloth should be frequently soaked in the soap solution.

CAUTION

Radiator fins can be damaged by spraying high pressure water on them.

Do not spray high pressure water on the radiator.

NOTE: Avoid spraying or allowing water to flow over the following places:

- *Ignition switch*
- *Spark plugs*
- *Fuel tank cap*
- *Throttle body*
- *Fuel injection system*
- *Brake master cylinder*

CAUTION

High pressure washers and parts cleaner can damage your motorcycle.

Do not use high pressure washers to clean your motorcycle. Do not use parts cleaner to throttle body and fuel injection sensors.

3. Once the dirt has been completely removed, rinse off the detergent with running water.
4. After rinsing, wipe off the motorcycle with a wet chamois or cloth and allow it to dry in the shade.
5. Check carefully for damage to painted surfaces. If there is any damage, obtain "touch-up" paint and "touch-up" the damage.

CAUTION

Cleaning with any alkaline or strong acid cleaner gasoline, brake fluid, or any other solvent will damage the motorcycle parts.

Clean only with soft cloth and warm water with mild detergent.

Waxing the Motorcycle

After washing the motorcycle, waxing is recommended to further protect and beautify the paint. Observe the precautions specified by the wax manufacturer.

INSPECTION AFTER CLEANING

For extended life of your motorcycle, lubricate according to GENERAL LUBRICATION section.

WARNING

Wet brakes can cause poor braking performance and may lead to an accident.

Avoid a possible accident by expecting longer stopping distances after washing your motorcycle. Apply brakes several times to let heat dry the brake pads or shoes.

Follow the procedures in the INSPECTION BEFORE RIDING section to check your motorcycle for any problems that may have arisen during your last ride.

CONSUMER INFORMATION

EMISSION CONTROL WARRANTY	10-2
TAMPERING WITH NOISE CONTROL SYSTEM PROHIBITED	10-2
SERIAL NUMBER LOCATION	10-3
REPORTING SAFETY DEFECTS	10-4
ON-BOARD MOTORCYCLE COMPUTER DATA INFORMATION	10-5
LOCATION OF LABELS	10-6

CONSUMER INFORMATION

EMISSION CONTROL WARRANTY

Suzuki Motor Corporation warrants to the ultimate purchaser and each subsequent purchaser that this vehicle is designed, built, and equipped so as to conform at the time of sale with all U.S. emission standards applicable at the time of manufacture, and that it is free from defects in materials and workmanship which would cause it not to meet these standards within its useful life. Useful life is defined for each class of motorcycle as 5 years or the corresponding number of kilometers (miles) shown in the chart below, whichever occurs first.

Vehicle Class	Engine Displacement	Useful Life Distance
Class I	50 to 169 cc	12000 km (7456 miles)
Class II	170 to 279 cc	18000 km (11185 miles)
Class III	280 cc and over	30000 km (18641 miles)

Failures, other than those resulting from defects in material or workmanship, which arise solely as a result of owner abuse and/or lack of proper maintenance are not covered by the warranty.

TAMPERING WITH NOISE CONTROL SYSTEM PROHIBITED

Federal law prohibits the following acts or the causing thereof; (1) the removal or rendering inoperative by any person other than for purposes of maintenance, repair, or replacement, of any device or element of design incorporated into any new vehicle for the purpose of noise control prior to its sale or delivery to the ultimate purchaser or while it is in use, or (2) the use of the vehicle after such device or element of design has been removed or rendered inoperative by any person.

Among those acts presumed to constitute tampering are the acts listed below:

- removing or puncturing the muffler, baffles, header pipes, screen type spark arrester (if equipped) or any other component which conducts exhaust gases
- replacing the exhaust system or muffler with a system or muffler not marked with the same model specific code as the code listed on the Motorcycle Noise Emission Control Information label, and certified to appropriate EPA noise standards
- removing or puncturing the air cleaner case, air cleaner cover, baffles, or any other component which conducts intake air.

Whenever replacing parts on your motorcycle, Suzuki recommends that you use genuine Suzuki replacement parts or their equivalent.

SERIAL NUMBER LOCATION

You need to know the frame and engine serial numbers to get title documents for your motorcycle. You also need these numbers to help your authorized Suzuki dealer when you order parts.

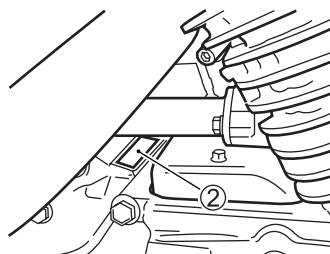
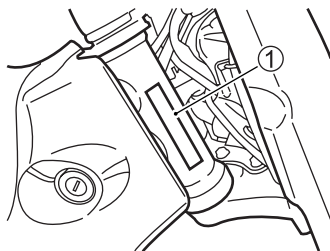

The frame number ① is stamped on the steering head as shown in the illustration. The engine serial number ② is stamped on the crankcase assembly.

Write down the serial numbers here for your future reference.

Frame No:

Engine No:

REPORTING SAFETY DEFECTS

If you believe that your vehicle has a defect which could cause a crash or could cause injury or death, you should immediately inform the National Highway Traffic Safety Administration (NHTSA) in addition to notifying American Suzuki Motor Corp.

If NHTSA receives similar complaints, it may open an investigation, and if it finds that a safety defect exists in a group of vehicles, it may order a recall and remedy campaign. However, NHTSA cannot become involved in individual problems between you, your authorized Suzuki dealer, or American Suzuki Motor Corp.

To contact NHTSA, you may either call the Vehicle Safety Hot Line toll-free 1-888-327-4236 (TTY: 1-800-424-9153); go to <http://www.safercar.gov>; or write to: Administrator, NHTSA, 400 Seventh Street, SW., Washington DC 20590. You can also obtain other information about motor vehicle safety from <http://www.NHTSA.gov>.

To contact American Suzuki, owners in the continental United States can call toll-free 1-800-444-5077, or write to: American Suzuki Motor Corporation Motorcycle Customer Service P.O. Box 1100, Brea, CA 92822-1100

For owners outside the continental United States, please refer to the distributor's address listed on your Warranty Information brochure.

ON-BOARD MOTORCYCLE COMPUTER DATA INFORMATION

Your motorcycle is equipped with on-board computer systems which monitor and control several aspects of motorcycle performance, including the following:

- Emission-related components and engine parameters such as engine speed and throttle position are monitored to provide emission control and to provide optimum fuel economy. Your motorcycle also has an on-board diagnostic system which monitors and records information about emission-related malfunctions.

Some information may be stored by the on-board computer when malfunctions occur. This stored information can assist technicians in repairing the motorcycle. To read the stored information, special equipment is needed and access to the motorcycle or storage device is required. In addition, once SUZUKI collects or receives data, SUZUKI may use the data for research conducted by SUZUKI, make the data available for outside research if need is shown and confidentiality is assured, or make summary data which does not identify specific motorcycles available for outside research.

Others, such as law enforcement personnel, may have access to the special equipment that can read the information if they have access to the motorcycle or storage device.

LOCATION OF LABELS

Read and follow all of the warnings labeled on your motorcycle. Make sure you understand all of the labels. Keep the labels on your motorcycle. Do not remove them for any reason.

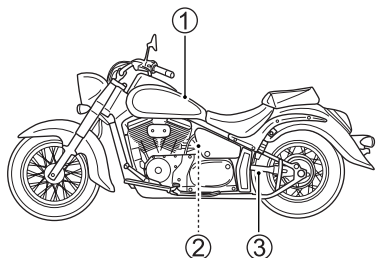

①

⚠ WARNING

Failure to follow these safety precautions may increase your risk of injury:

- Wear a helmet, eye protection, and bright protective clothing.
- Don't ride after consuming alcohol or other drugs.
- Slow down on slippery surfaces, unfamiliar terrain, or when visibility is reduced.
- Read owner's manual carefully.

②

The owner's manual contains important safety information and instructions which should be read carefully before operating the vehicle. If the vehicle has been resold, obtain the owner's manual from the previous owner or contact your local SUZUKI dealer for assistance.

③ (VL800)

▲ WARNING		COLD TIRE PRESSURE	SOLO RIDING			DUAL RIDING		
			kPa	kgf/cm ²	psi	kPa	kgf/cm ²	psi
<ul style="list-style-type: none"> ● Check tire condition, wear, and cold tire pressure before each ride. ● Replace only with tires of listed size and type. ● Read Owner's manual for more information. 		FRONT	200	2.00	29	200	2.00	29
		REAR	250	2.50	36	250	2.50	36
		TIRE SIZE		130/90-16M/C 67H			170/80-15M/C 77H	
TYPE	IRC	GS-23F			GS-23R			

③ (VL800T)

▲ WARNING		COLD TIRE PRESSURE	SOLO RIDING			DUAL RIDING		
			kPa	kgf/cm ²	psi	kPa	kgf/cm ²	psi
<ul style="list-style-type: none"> ● Check tire condition, wear, and cold tire pressure before each ride. ● Replace only with tires of listed size and type. ● Read Owner's manual for more information. 		FRONT	225	2.25	33	225	2.25	33
		REAR	250	2.50	36	250	2.50	36
		TIRE SIZE		130/90-16M/C 67H			170/80-15M/C 77H	
TYPE	IRC	GS-23F RW			GS-23R RW			

③ (VL800C)

▲ WARNING		COLD TIRE PRESSURE	SOLO RIDING			DUAL RIDING		
			kPa	kgf/cm ²	psi	kPa	kgf/cm ²	psi
<ul style="list-style-type: none"> ● Check tire condition, wear, and cold tire pressure before each ride. ● Replace only with TUBELESS tires of listed size and type. ● Read owner's manual for more information. 		FRONT	225	2.25	33	225	2.25	33
		REAR	250	2.50	36	250	2.50	36
		TIRE SIZE		130/90-16M/C 67H			170/80-15M/C 77H	
TYPE	IRC	GS-23F D			GS-23R D			

SPECIFICATIONS

DIMENSIONS AND CURB MASS

Overall length	2510 mm (98.8 in)
Overall width.....	970 mm (38.2 in)
Overall height	1105 mm (43.5 in)
Wheelbase	1655 mm (65.2 in)
Ground clearance.....	140 mm (5.5 in)
Seat height	700 mm (27.6 in)
Curb mass	267 kg (589 lbs)

ENGINE

Type.....	Four-stroke, liquid-cooled, OHC
Number of cylinders	2
Bore.....	83.0 mm (3.268 in)
Stroke	74.4 mm (2.929 in)
Displacement.....	805 cm ³ (49.1 cu. in)
Compression ratio	9.4 : 1
Fuel system	Fuel injection
Air cleaner	Non-woven fabric element
Starter system.....	Electric
Lubrication system	Wet sump

DRIVE TRAIN

Clutch	Wet multi-plate type
Transmission	5-speed constant mesh
Gearshift pattern	1-down, 4-up
Primary reduction ratio	1.690 (71/42)
Secondary reduction ratio	1.000 (30/30)
Gear ratios, Low	2.461 (32/13)
2nd.....	1.631 (31/19)
3rd	1.227 (27/22)
4rd	1.000 (25/25)
Top.....	0.814 (22/27)
Final reduction ratio.....	3.503 (17/15 x 34/11)
Drive system.....	Shaft drive

CHASSIS

Front suspension	Telescopic, coil spring, oil damped
Rear suspension	Link type, coil spring, oil damped
Front suspension stroke	140 mm (5.5 in)
Rear wheel travel.....	105 mm (4.1 in)
Caster.....	33° 20'
Trail.....	141 mm (5.55 in)
	138 mm (5.43 in) ... VL800C
Steering angle	38° (right & left)
Turning radius	3.0 m (9.8 ft)
Front brake	Disk brake
Rear brake.....	Drum brake
Front tire size.....	130/90-16 M/C 67H, tube
	130/90-16 M/C 67H, tubeless ... VL800C
Rear tire size	170/80-15 M/C 77H, tube
	170/80-15 M/C 77H, tubeless ... VL800C

ELECTRICAL

Ignition type	Electronic ignition (Transistorized)
Spark plug	NGK DPR7EA-9 or DENSO X22EPR-U9 NGK DR7EA or DENSO X22ESR-U ... For California
Battery	12V 36kC (10Ah)/10HR
Generator	Three-phase A.C. Generator
Main fuse	30A
Fuse	20/10/10/10/10/10A
Headlight	12V 60/55W (H4)
Brake light/Taillight	LED
Front turn signal light	12V 21/5W
Rear turn signal light	12V 21W
Speedometer light	LED
Neutral indicator light	LED
High beam indicator light	LED
Turn signal indicator light	LED
Oil pressure indicator light	LED
Coolant temperature indicator light	LED
Fuel injection indicator light	LED

CAPACITIES

Fuel tank	15.5 L (4.1 US gal)
Engine oil, without filter change	3000 ml (3.2 US qt)
With filter change	3400 ml (3.6 US qt)
Final gear oil	200 – 220 ml (6.8 – 7.4 US oz)
Engine coolant	1.5 L (1.6 US qt)

INDEX

- A**
ACCESSORIES AND
LOADING 1-5
ACCESSORY INSTALLATION
GUIDELINE 6-2
ACCESSORY USE 6-2
AIR CLEANER 7-7
- B**
BATTERY 7-6
BE EXTRA SAFETY-
CONSCIOUS ON BAD
WEATHER DAYS 1-5
BE STREET SMART 1-6
BRAKES 7-25
BREAK-IN 4-2
- C**
CARRYING A
PASSENGER 1-6,5-7
CLUTCH
ADJUSTMENT 7-22
CONCLUSION 1-6
CORROSION
PREVENTION 9-4
- E**
EMISSION CONTROL
WARRANTY 10-2
ENGINE COOLANT 7-23
ENGINE COOLANT
SOLUTION 2-5
ENGINE IDLE SPEED
INSPECTION 7-19
ENGINE OIL 2-3,7-15
- F**
FINAL GEAR OIL 7-24
FRONT WHEEL
REMOVAL 7-35
FUEL 2-2
FUEL HOSE 7-20
FUEL SUPPLY CHECK 8-2
FUEL SYSTEM CHECK 8-3
FUEL TANK CAP 3-17
FUSES 7-42
- G**
GEAR OIL 2-4
GEARSHIFT LEVER 3-18
GENERAL
LUBRICATION 7-5
- H**
HELMET HOLDER 3-19

I	
IF A COLLISION IS IMMINENT, DO SOMETHING!	1-3
IF YOU DON'T HAVE A HELMET - BUY A HELMET, AND WEAR IT EVERY TIME YOU RIDE	1-3
IGNITION SWITCH	3-5
IGNITION SYSTEM CHECK.....	8-3
INSPECTION AFTER CLEANING	9-6
INSPECTION BEFORE RIDING.....	4-3
INSPECTION BEFORE RIDING.....	1-5
INSTRUMENT PANEL.....	3-7
K	
KEY	3-5
KNOW YOUR LIMITS.	1-4
L	
LEFT HANDLEBAR.....	3-13
LIGHT BULB REPLACEMENT	7-39
LOADING GUIDELINES	6-4
LOADING LIMIT	6-3
LOCATION	3-2
LOCATION OF LABELS.....	10-6
LOCATION OF PARTS	3-2
M	
MAINTENANCE SCHEDULE	7-2
MODIFICATION	6-4
MOST ACCIDENTS CAN BE AVOIDED.	1-2
MOTORCYCLE CLEANING	9-5
MOTORCYCLE SAFETY FOUNDATION'S "RIDING TIPS AND PRACTICE GUIDE" HANDBOOK (FOR OWNERS IN USA)	1-6
N	
NOTICE	7-2
O	
ON-BOARD MOTORCYCLE COMPUTER DATA INFORMATION	10-5
P	
PRACTICE AWAY FROM TRAFFIC.	1-5
PROCEDURE FOR RETURNING TO SERVICE.....	9-3

R		
REAR BRAKE PEDAL	3-18	
REAR WHEEL		
REMOVAL.....	7-37	
REPORTING SAFETY DEFECTS.....	10-4	
RIDING ON HILLS	5-5	
RIGHT HANDLEBAR	3-15	
S		
SERIAL NUMBER LOCATION.....	10-3	
SIDE STAND.....	3-19	
SIDE STAND/IGNITION INTERLOCK SYSTEM.....	7-34	
SPARK PLUG	7-11	
SPECIAL SITUATIONS REQUIRE SPECIAL CARE.	1-4	
STARTING OFF AND SHIFTING.....	5-3	
STARTING THE ENGINE.....	5-2	
STORAGE PROCEDURE	9-2	
SUSPENSION ADJUSTMENT	3-20	
T		
TAMPERING WITH NOISE CONTROL SYSTEM PROHIBITED.....	10-2	
THROTTLE CABLE ADJUSTMENT	7-20	
TIRES	7-30	
TOOLS	7-5	
U		
USING THE TRANSMISSION	5-4	

WARNING

Failure to follow these safety precautions may increase your risk of injury:

- Wear a helmet, eye protection, and bright protective clothing.
- Don't ride after consuming alcohol or other drugs.
- Slow down on slippery surfaces, unfamiliar terrain, or when visibility is reduced.
- Read owner's manual carefully.



* 9 9 0 1 1 - 4 3 H 5 0 - 0 3 A *

SUZUKI MOTOR CORPORATION

Part No. 99011-43H50-03A August, 2008 EN 

K9

Printed in Japan