



FORWARD

CONTENTS

HOW TO USE THIS MANUAL

SERIAL NUMBER

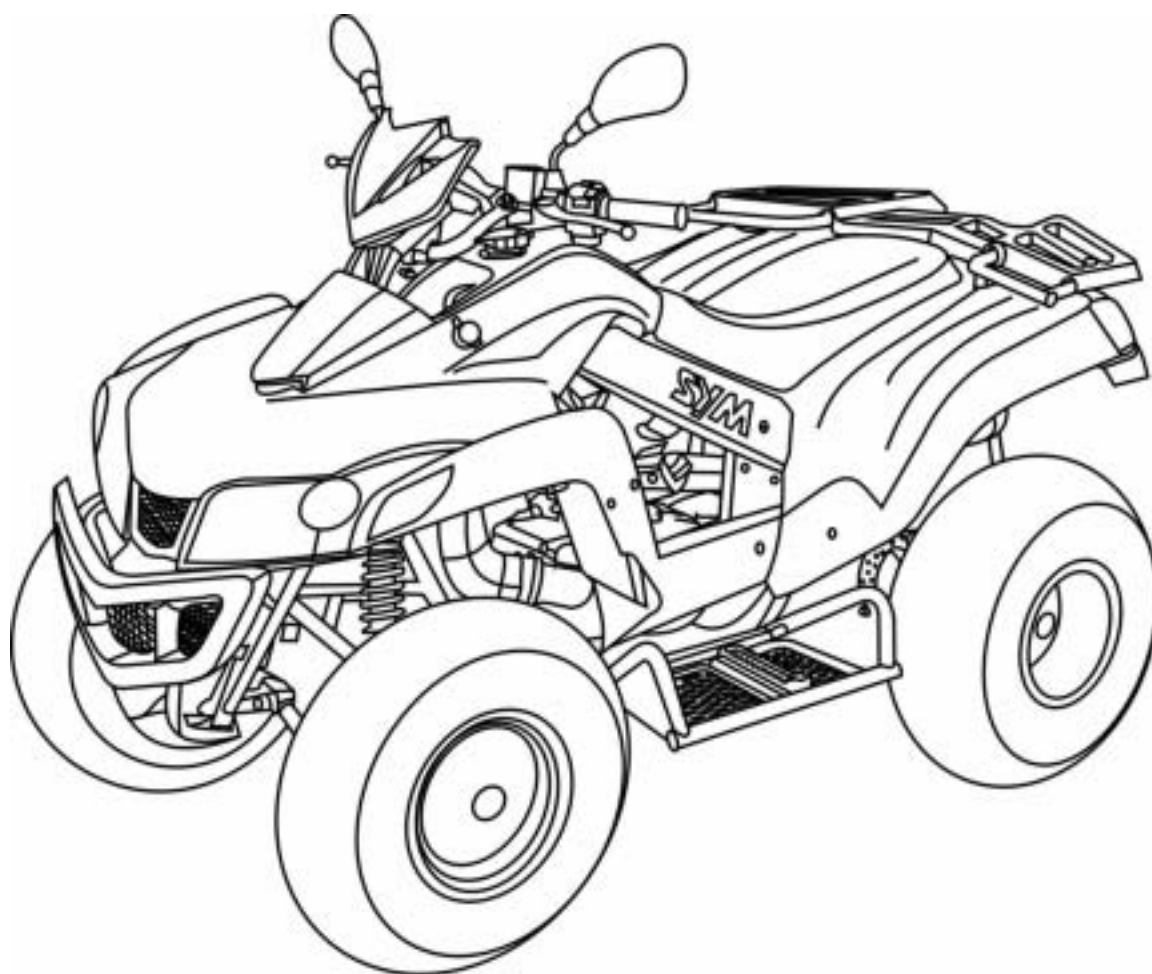

*Quad Lander 250*

**SERVICE MANUAL**

This service manual contains the technical data of each component inspection and repair for the SANYANG Quad Lander 250 ATV. The manual is shown with illustrations and focused on “Service Procedures”, “Operation Key Points”, and “Inspection Adjustment” so that provides technician with service guidelines.

If the style and construction of the ATV, Quad Lander 250, are different from that of the photos, pictures shown in this manual, the actual vehicle shall prevail. Specifications are subject to change without notice.

**Service Department  
SANYANG INDUSTRY CO., LTD.**

---

## HOW TO USE THIS MANUAL

---



This service manual describes basic information of different system parts and system inspection & service for SANYANG Quad Lander 250 ATV. In addition, please refer to the manual contents in detailed for the model you serviced in inspection and adjustment.

The first chapter covers general information and trouble diagnosis.

The second chapter covers service maintenance information and special tools manual.

The third to the 11th chapters cover engine and driving systems.

The 12th chapter is cooling system.

The 13th to the 16th chapter is contained the parts set of assembly frame body.

The 17th chapter is electrical equipment.

The 18th chapter is wiring diagram.

Please see index of content for quick having the special parts and system information.

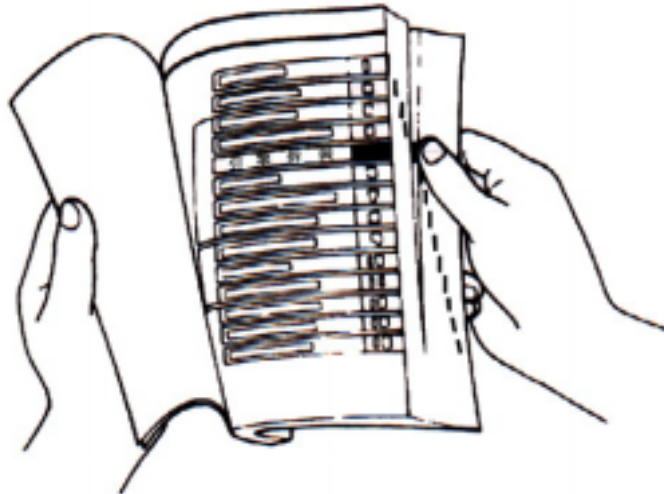

There are 4 buttons, “[Forward](#)”, “[Contents](#)”, “[How to use this manual](#)” and “[Mechanism Illustrations](#)” on the CD-R version, and can be access to these items by click the mouse.

If user wants to look for the content of each chapter, selecting the words of each chapter on the contents can reach to each chapter. There are two buttons, “Homepage and contents, onto the top line of first page of the each chapter. Thus, if the user needs to check other chapters, he can click the top buttons to back the homepage or contents. The content of each chapter can be selected too. Therefore, when needs to checking the content inside of the chapter, click the content words of the chapter so that can back to the initial section of the content. In addition, there is a “[To this chapter contents](#)” button at the second page of each contents so that clicking the button can back to the contents of this chapter.

---

Page	Content	Index
1-1 ~ 1-18	<b>GENERAL INFORMATION</b>	<b>1</b>
2-1 ~ 2-14	<b>SERVICE MAINTENANCE INFORMATION</b>	<b>2</b>
3-1 ~ 3-8	<b>LUBRICATION SYSTEM</b>	<b>3</b>
4-1 ~ 4-12	<b>FUEL SYSTEM</b>	<b>4</b>
5-1 ~ 5-6	<b>ENGINE REMOVAL</b>	<b>5</b>
6-1 ~ 6-16	<b>CYLINDER HEAD/VALVE</b>	<b>6</b>
7-1 ~ 7-8	<b>CYLINDER/PISTON</b>	<b>7</b>
8-1 ~ 8-14	<b>“V” TYPE BELT DRIVING SYSTEM/KICK-STARTER</b>	<b>8</b>
9-1 ~ 9-12	<b>FINAL DRIVING MECHANISM</b>	<b>9</b>
10-1 ~ 10-10	<b>ALTERNATOR</b>	<b>10</b>
11-1 ~ 11-8	<b>CRANKSHAFT/ CRANKCASE</b>	<b>11</b>
12-1 ~ 12-12	<b>COOLING SYSTEM</b>	<b>12</b>
13-1 ~ 13-14	<b>BODY COVER</b>	<b>13</b>
14-1 ~ 14-14	<b>FRONT BRAKE AND FRONT WHEEL</b>	<b>14</b>
15-1 ~ 15-10	<b>STEERING/FRONT SUSPENSION</b>	<b>15</b>
16-1 ~ 16-18	<b>REAR BRAKE/REAR WHEEL/REAR CUSHION</b>	<b>16</b>
17-1 ~ 17-22	<b>ELECTRICAL EQUIPMENT</b>	<b>17</b>
18-1 ~ 18-2	<b>ELECTRICAL DIAGRAM</b>	<b>18</b>

# SERIAL NUMBER



## Frame number

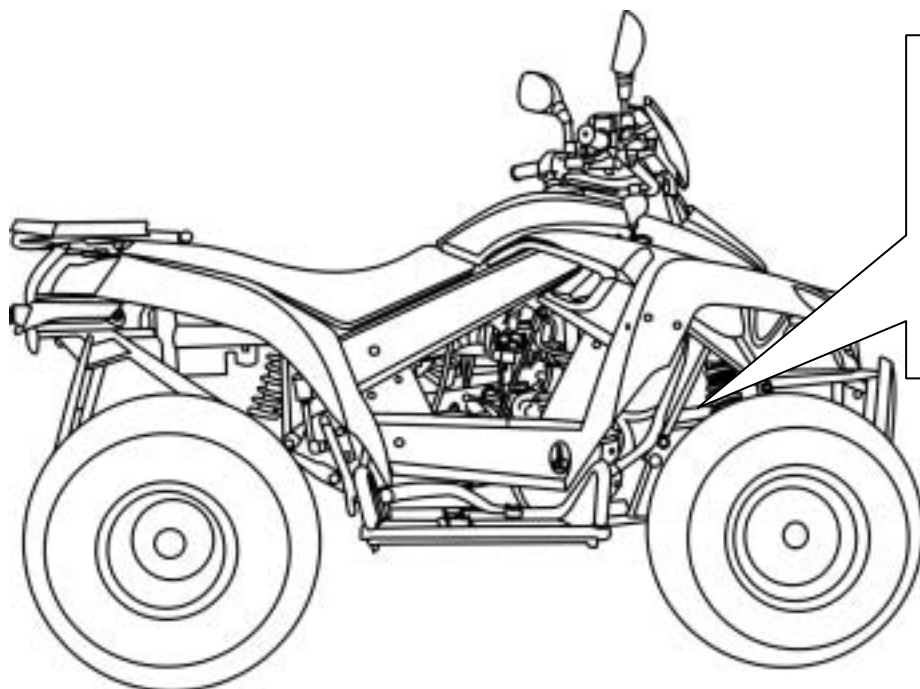

## Engine number

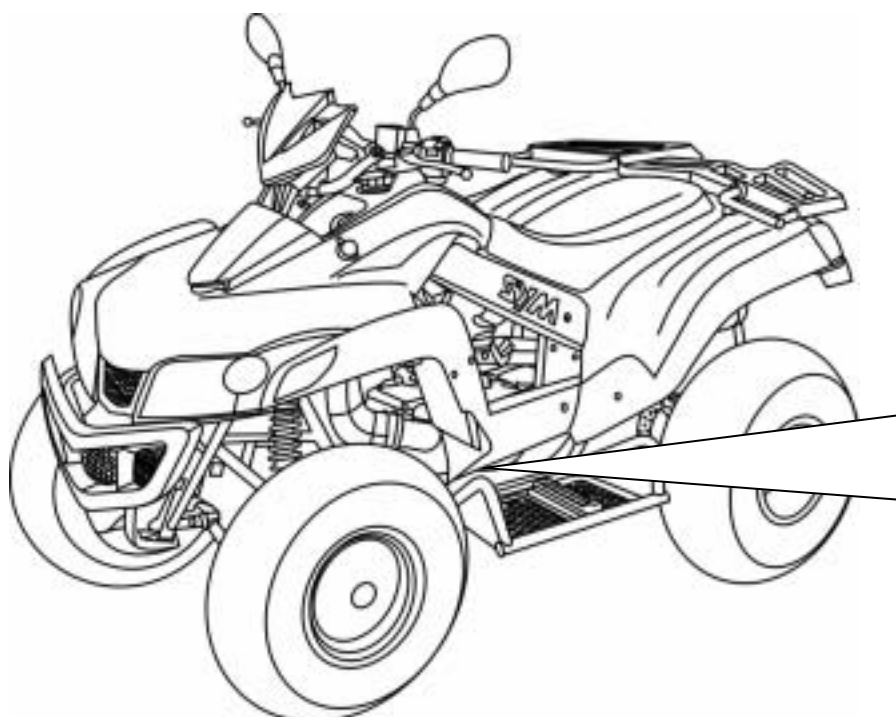

<a href="#">Symbols and Marks.....</a>	<a href="#">1-1</a>	<a href="#">Specifications.....</a>	<a href="#">1-10</a>
<a href="#">General Safety .....</a>	<a href="#">1-2</a>	<a href="#">Torque Values .....</a>	<a href="#">1-11</a>
<a href="#">Service Precautions .....</a>	<a href="#">1-3</a>	<a href="#">Troubles Diagnosis.....</a>	<a href="#">1-13</a>
<a href="#">Specifications.....</a>	<a href="#">1-9</a>	<a href="#">Lubrication Points .....</a>	<a href="#">1-18</a>

## Symbols and Marks

Symbols and marks are used in this manual to indicate what and where the special service are needed, in case supplemental information is procedures needed for these symbols and marks, explanations will be added to the text instead of using the symbols or marks.

	Warning	Means that serious injury or even death may result if procedures are not followed.
	Caution	Means that equipment damages may result if procedures are not followed.
	Engine oil	Limits to use SAE 10W-30 API SG class oil. Warranty will not cover the damage that caused by not apply with the limited engine oil. (Recommended oil: KING MATE G-3 oil)
	Grease	King Mate G-3 is recommended.
	Gear oil	King Mate gear oil serials are recommended. (Bramax HYPOID GEAR OIL # 140)
	Locking sealant	Apply sealant; medium strength sealant should be used unless otherwise specified.
	Oil seal	Apply with lubricant. .
	Renew	Replace with a new part before installation.
	Brake fluid	Use recommended brake fluid DOT3 or WELLRUN brake fluid.
	Special tools	Special tools
	Correct	Meaning correct installation.
	Wrong	Meaning wrong installation.
	Indication	Indication of components.
	Directions	Indicates position and operation directions
		Components assembly directions each other.
		Indicates where the bolt installation direction, --- means that bolt cross through the component (invisibility).

# 1. GENERAL INFORMATION

## General Safety

### Carbon monoxide

If you must run your engine, ensure the place is well ventilated. Never run your engine in a closed area. Run your engine in an open area, if you have to run your engine in a closed area, be sure to use an extractor.

#### Caution

Exhaust contains toxic gas which may cause one to lose consciousness and even result in death.

### Gasoline

Gasoline is a low ignition point and explosive material. Work in a well-ventilated place, no flame or spark should be allowed in the work place or where gasoline is being stored.

#### Caution

Gasoline is highly flammable, and may explode under some conditions, keep it away from children.

### Used engine oil

#### Caution

Prolonged contact with used engine oil (or transmission oil) may cause skin cancer although it might not be verified.

We recommend that you wash your hands with soap and water right after contacting. Keep the used oil beyond reach of children.

### Hot components

#### Caution

Components of the engine and exhaust system can become extremely hot after engine running. They remain very hot even after the engine has been stopped for some time. When performing service work on these parts, wear insulated gloves and wait until cooling off.

### Battery

#### Caution

Battery emits explosive gases; flame is strictly prohibited. Keep the place well ventilated when charging the battery.

Battery contains sulfuric acid (electrolyte) which can cause serious burns so be careful do not be spray on your eyes or skin. If you get battery acid on your skin, flush it off immediately with water. If you get battery acid in your eyes, flush it off immediately with water and then go to hospital to see an ophthalmologist.

If you swallow it by mistake, drink a lot of water or milk, and take some laxative such as castor oil or vegetable oil and then go to see a doctor.

Keep electrolyte beyond reach of children.

### Brake shoe

Do not use an air hose or a dry brush to clean components of the brake system; use a vacuum cleaner or the equivalent to avoid dust flying.

#### Caution

Inhaling brake shoe or pad ash may cause disorders and cancer of the breathing system

### Brake fluid

#### Caution

Spilling brake fluid on painted, plastic, or rubber parts may cause damage to the parts. Place a clean towel on the above-mentioned parts for protection when servicing the brake system. Keep the brake fluid beyond reach of children.

## Service Precautions

- Always use with SANYANG genuine parts and recommended oils. Using non-designed parts for SANYANG ATV may damage the ATV.

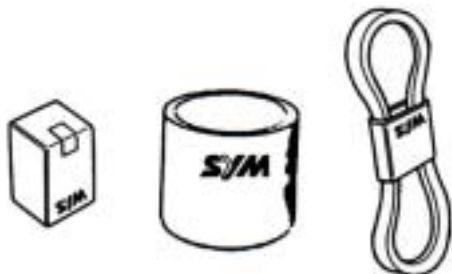

- Special tools are designed for remove and install of components without damaging the parts being worked on. Using wrong tools may result in parts damaged.

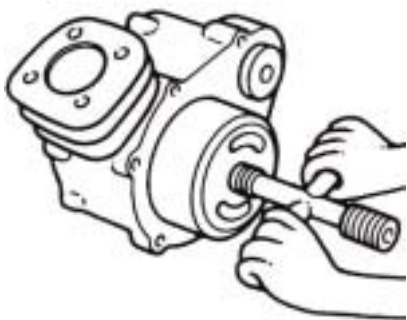

- When servicing this ATV, use only metric tools. Metric bolts, nuts, and screws are not interchangeable with the English system, using wrong tools and fasteners may damage this vehicle.
- Clean the outside of the parts or the cover before removing it from the ATV. Otherwise, dirt and deposit accumulated on the part's surface may fall into the engine, chassis, or brake system to cause damage.
- Wash and clean parts with high ignition point solvent, and blow dry with compressed air. Pay special attention to O-rings or oil seals because most cleaning agents have an adverse effect on them.

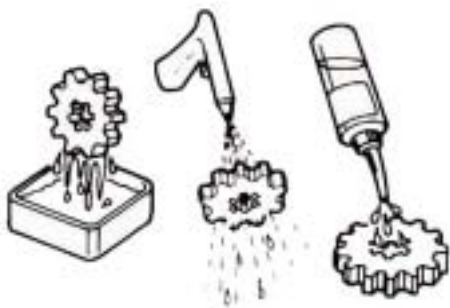

- Never bend or twist a control cable to prevent unsmooth control and premature worn out.



- Rubber parts may become deteriorated when old, and prone to be damaged by solvent and oil. Check these parts before installation to make sure that they are in good condition, replace if necessary.
- When loosening a component which has different sized fasteners, operate with a diagonal pattern and work from inside out. Loosen the small fasteners first. If the bigger ones are loosen first, small fasteners may receive too much stress.
- Store complex components such as transmission parts in the proper assemble order and tie them together with a wire for ease of installation later.

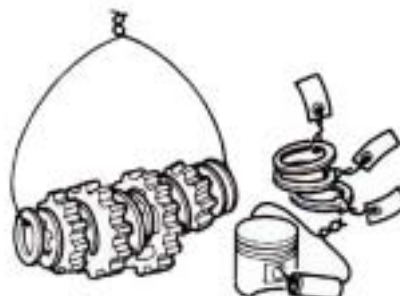

- Note the reassemble position of the important components before disassembling them to ensure they will be reassembled in correct dimensions (depth, distance or position).
- Components not to be reused should be replaced when disassembled including gaskets metal seal rings, O-rings, oil seals, snap rings, and split pins.





# 1. GENERAL INFORMATION

- The length of bolts and screws for assemblies, cover plates or boxes is different from one another, be sure they are correctly installed. In case of confusion, Insert the bolt into the hole to compare its length with other bolts, if its length out side the hole is the same with other bolts, it is a correct bolt. Bolts for the same assembly should have the same length.

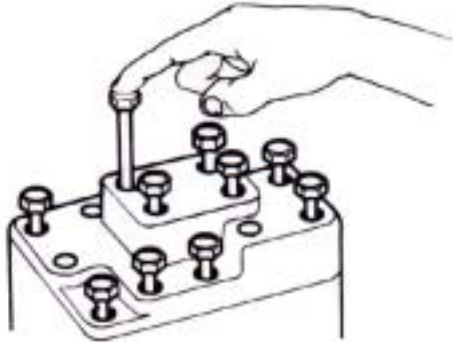

- Tighten assemblies with different dimension fasteners as follows: Tighten all the fasteners with fingers, then tighten the big ones with special tool first diagonally from inside toward outside, important components should be tightened 2 to 3 times with appropriate increments to avoid warp unless otherwise indicated. Bolts and fasteners should be kept clean and dry. Do not apply oil to the threads.

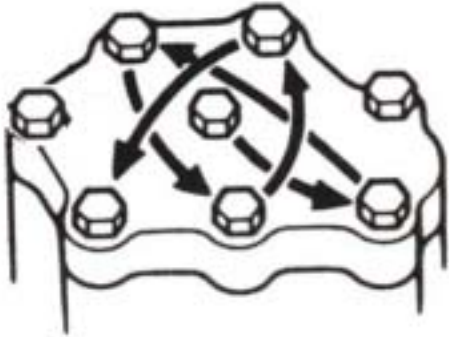

- When oil seal is installed, fill the groove with grease, install the oil seal with the name of the manufacturer facing outside, and check the shaft on which the oil seal is to be installed for smoothness and for burrs that may damage the oil seal.

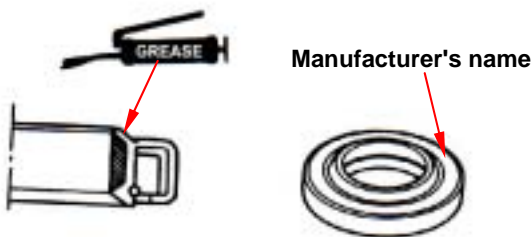

- Remove residues of the old gasket or sealant before reinstallation, grind with a grindstone if the contact surface has any damage.



- The ends of rubber hoses (for fuel, vacuum, or coolant) should be pushed as far as they can go to their connections so that there is enough room below the enlarged ends for tightening the clamps.

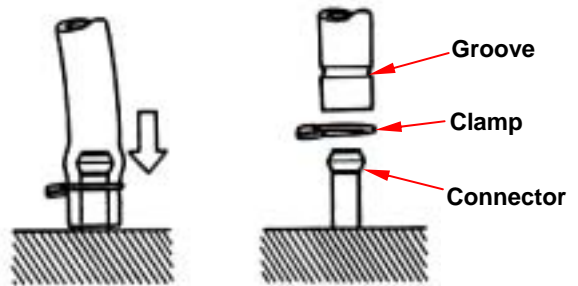

- Rubber and plastic boots should be properly reinstalled to the original correct positions as designed.

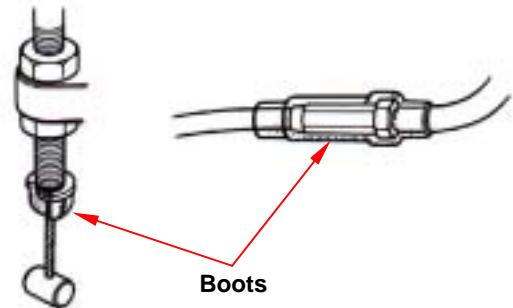

- The tool should be pressed against two (inner and outer) bearing races when removing a ball bearing. Damage may result if the tool is pressed against only one race (either inner race or outer race). In this case, the bearing should be replaced. To avoid damaging the bearing, use equal force on both races.

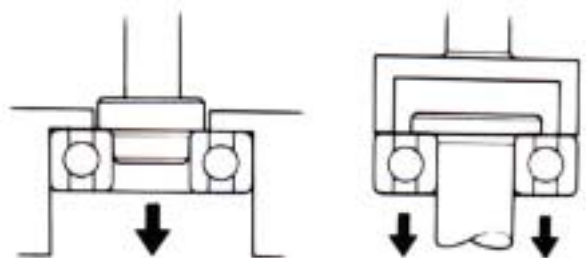

Both of these examples can result in bearing damage.

# 1. GENERAL INFORMATION

- Lubricate the rotation face with specified lubricant on the lubrication points before assembling.

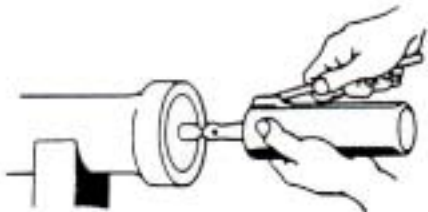

- Check if positions and operation for installed parts is in correct and properly.



- Make sure service safety each other when conducting by two persons.



- Note that do not let parts fall down.



- Before battery removal operation, it has to remove the battery negative (-) cable firstly. Notre tools like open-end wrench do not contact with body to prevent from circuit short and create spark.

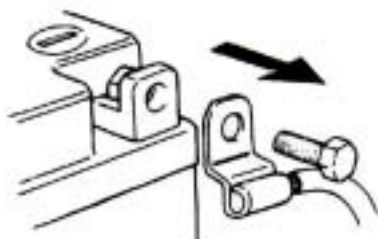

- After service completed, make sure all connection points is secured. Battery positive (+) cable should be connected firstly.
- And the two posts of battery have to be greased after connected the cables.



- Make sure that the battery post caps are located in properly after the battery posts had been serviced.

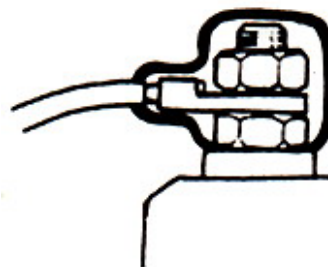

- If fuse burned, it has to find out the cause and solved it. And then replace with specified capacity fuse.

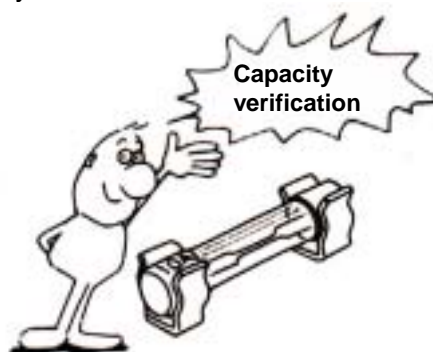

# 1. GENERAL INFORMATION

- When separating a connector, it locker has to be unlocked firstly. Then, conduct the service operation.

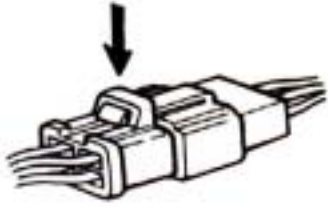

- Do not pull the wires as removing a connector or wires. Hold the connector body.



- Make sure if the connector pins are bent, extruded or loosen.

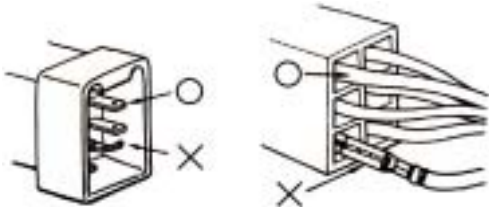

- Insert the connector completely. If there are two lockers on two connector sides, make sure the lockers are locked in properly. Check if any wire loose.

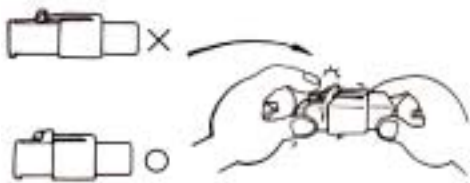

- Check if the connector is covered by the twin connector boot completely and secured properly.

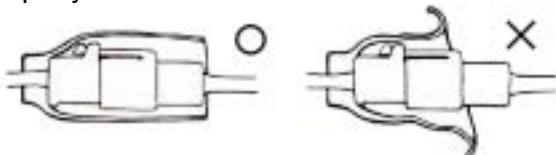

- Before terminal connection, check if the boot is crack or the terminal is loose.

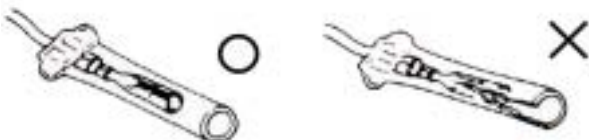

- Insert the terminal completely. Check if the terminal is covered by the boot. Do not let boot open facing up.



- Secure wires and wire harnesses to the frame with respective wire bands at the designated locations. Tighten the bands so that only the insulated surfaces contact the wires or wire harnesses.

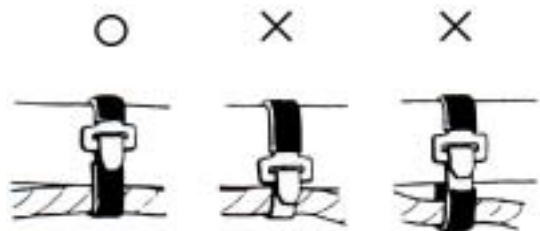

- Wire band and wire harness have to be clamped secured properly.

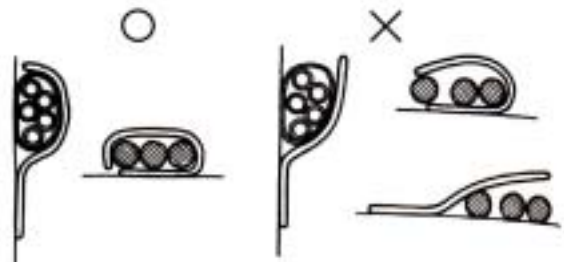

- Do not squeeze wires against the weld or its clamp.



# 1. GENERAL INFORMATION

- Do not let the wire harness contact with rotating, moving or vibrating components as routing the harness.

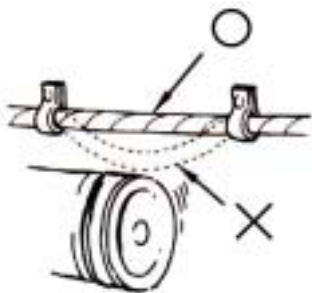

- Keep wire harnesses far away from the hot parts.

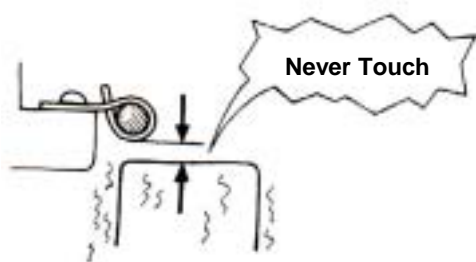

- Route wire harnesses to avoid sharp edges or corners and also avoid the projected ends of bolts and screws.



- Route harnesses so that they neither pull too tight nor have excessive slack.

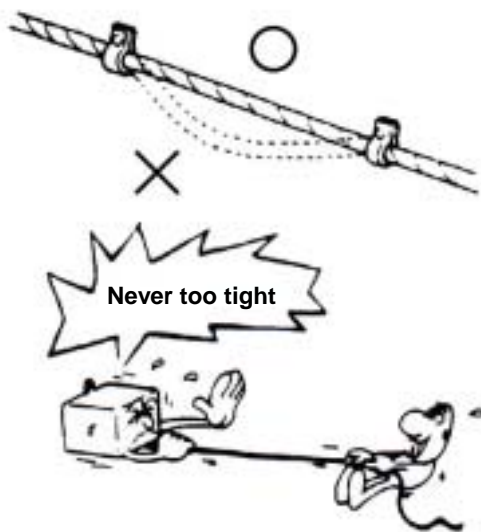

- Protect wires or wire harnesses with electrical tape or tube if they contact a sharp edge or corner. Thoroughly clean the surface where tape is to be applied.

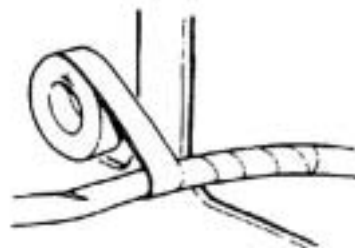

- Secure the rubber boot firmly as applying it on wire harness.

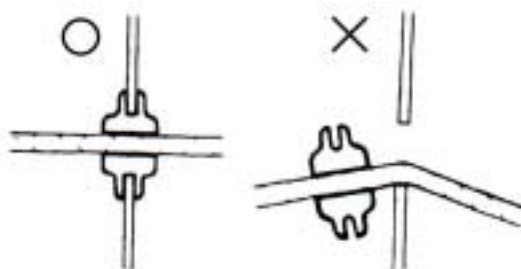

- Never use wires or harnesses which insulation has been broken. Wrap electrical tape around the damaged parts or replace them.

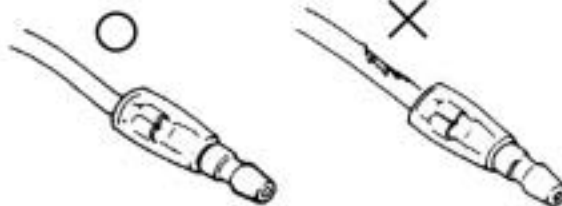

- Never clamp or squeeze the wire harness as installing other components.

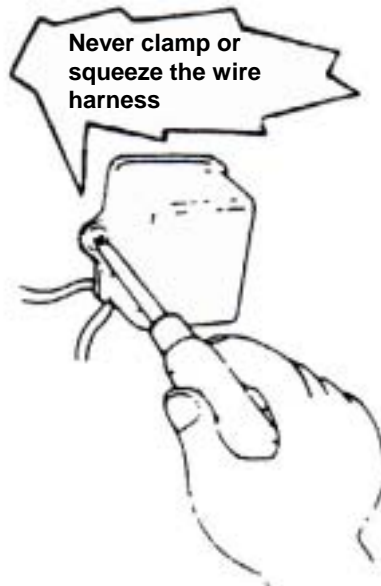

# 1. GENERAL INFORMATION

- Do not let the wire harness been twisted as installation.

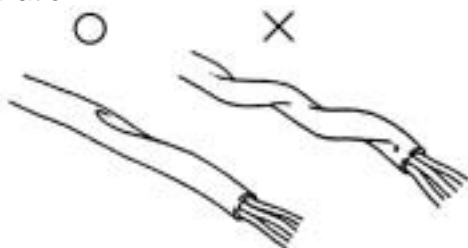

- Wire harnesses routed along the handlebar should not be pulled too tight or have excessive slack, be rubbed against or interfere with adjacent or surrounding parts in all steering positions.



- Before operating a test instrument, operator should read the operation manual of the instrument. And then, conduct test in accordance with the instruction.

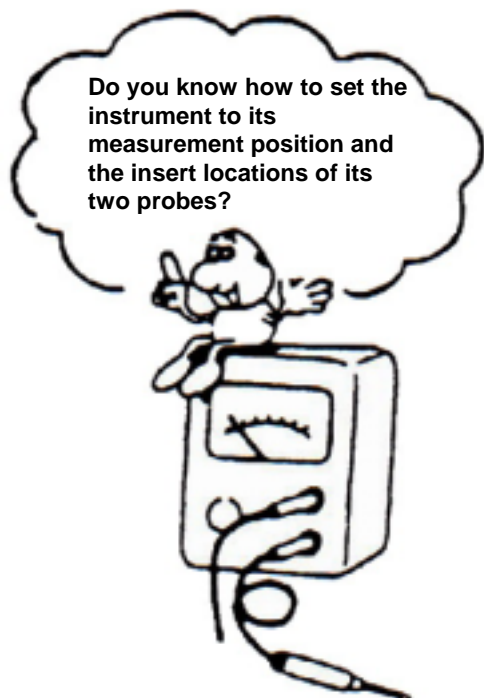

- With sand paper to clean rust on connector pins/terminals if found. And then conduct connection operation later.

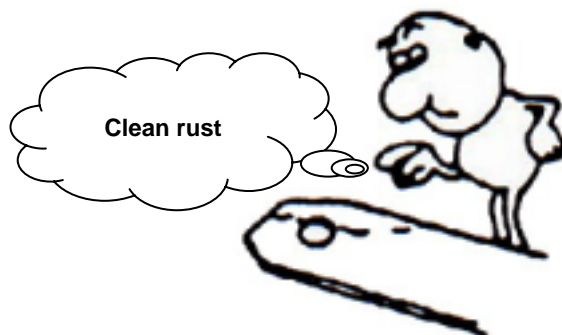

Specifications

MAKER		SANYANG		MODEL		UA25A		
Dimension	Overall Length		1890 mm		Suspension System	Front	Double arm	
	Overall Width		1055 mm			Rear	Unit Swing	
	Overall Height		1115 mm		Tire Specifications	Front	AT22x7-10 (off road)	
	Wheel Base		1200 mm			Rear	AT22x10-9 (off road)	
Weight	Wheel tread	Front	810 mm		Rim		Aluminum	
		Rear	805 mm		Brake System	Front	Disk ( 175mm)	
	Curb Weight	Front	109 kg			Rear	Disk ( 220mm)	
		Rear	114 kg		Performance	Max. Speed	Above 80 km/hr	
	Total	223 kg		Climb Ability		Below 25°		
	Passengers/Weight	Two /150 kg		Reduction	Primary Reduction	Belt		
		Front	142 kg		Secondary Reduction	Gear / Sprocket		
	Total Weight	Rear	231 kg		Clutch	Centrifugal, dry type		
		Total	373 kg		Transmission	C.V.T., auto speed change		
	Type		4-Stroke Engine		Speedometer		0 ~ 100 km/hr	
Installation and arrangement		Vertical, below center, incline			Horn		93~112 dB/A	
Fuel Used		Above 92 unleaded		Muffler		Expansion & Pulse Type		
Cylinder	Bore		Ø71 mm		Exhaust Pipe Position and Direction		Left side, and Backward	
	Stroke		63 mm		Lubrication System		Forced circulation & splashing	
	Number/Arrangement		Single Cylinder		Exhaust Concentration	Solid Particulate		
Displacement		249.4 cc		CO		Below 7.0 g/ km		
Compression Ratio		10.5 : 1		HC		Below 1.5g/ km		
Max. HP		13.2kw / 7000rpm		Nox		Below 0.4g/ km		
Max. Torque		20.6Nm / 5500rpm		E.E.C.				
Ignition		C.D.I.		P.C.V.				
Starting System		Electrical starter		Catalytic reaction control system				
Air filtration		Sponge						

# 1. GENERAL INFORMATION

## Specifications

MAKER		SANYANG		MODEL		UA25A1		
Dimension	Overall Length	1890 mm		Suspension System	Front	Double arm		
	Overall Width	1055 mm			Rear	Unit Swing		
	Overall Height	1115 mm		Tire Specifications	Front	AT22x7-10 (on road)		
	Wheel Base	1200 mm			Rear	AT22x10-9 (on road)		
Weight	Wheel tread	Front	810 mm	Rim		Aluminum		
		Rear	805 mm	Brake System	Front	Disk ( 175mm)		
	Curb Weight	Front	109 kg		Rear	Disk ( 220mm)		
		Rear	114 kg	Performance	Max. Speed	Above 80 km/hr		
	Total	223 kg	Climb Ability		Below 25°			
	Passengers/Weight	Two /150 kg		Reduction	Primary Reduction	Belt		
		Front	142 kg		Secondary Reduction	Gear / Sprocket		
	Total Weight	Rear	231 kg		Clutch	Centrifugal, dry type		
		Total	373 kg		Transmission	C.V.T., auto speed change		
	Type	4-Stroke Engine			Speedometer		0 ~ 100 km/hr	
Installation and arrangement	Vertical, below center, incline		Horn		93~112 dB/A			
Fuel Used	Above 92 unleaded		Muffler		Expansion & Pulse Type			
Cycle/Cooling	4-stroke/water cooled		Exhaust Pipe Position and Direction		Left side, and Backward			
Cylinder	Bore	Ø71 mm		Lubrication System		Forced circulation & splashing		
	Stroke	63 mm		Exhaust Concentration	Solid Particulate			
	Number/Arrangement	Single Cylinder			CO		Below 7.0 g/ km	
Displacement	249.4 cc		HC		Below 1.5g/ km			
Compression Ratio	10.5 : 1		Nox		Below 0.4g/ km			
Max. HP	13.2kw / 7000rpm		E.E.C.					
Max. Torque	20.6Nm / 5500rpm		P.C.V.					
Ignition	C.D.I.		Catalytic reaction control system					
Starting System	Electrical starter							
Air filtration	Sponge							

## Torque Values

The torque values listed in above table are for more important tighten torque values. Please see standard values for not listed in the table.

### Standard Torque Values for Reference

Type	Tighten Torque	Type	Tighten Torque
5 mm bolt、 nut	0.45~0.6kgf-m	5 mm screw	0.35~0.5kgf-m
6 mm bolt、 nut	0.8~1.2kgf-m	6 mm screw、 SH nut	0.7~ 1.1kgf-m
8 mm bolt、 nut	1.8~2.5kgf-m	6 mm bolt、 nut	1.0 ~1.4kgf-m
10 mm bolt、 nut	3.0~4.0kgf-m	8 mm bolt、 nut	2.4 ~3.0kgf-m
12 mm bolt、 nut	5.0~6.0kgf-m	10 mm bolt、 nut	3.5~4.5kgf-m

### Engine Torque Values

Item	Q'ty	Thread Dia. (mm)	Torque Value(kgf-m)	Remarks
Cylinder stud bolt	4	10	1.0~1.4	Apply oil to thread
Cylinder head nut	4	8	3.6~4.0	
Cylinder head right bolt	2	8	2.0~2.4	
Cylinder head side cover bolt	2	6	1.0~1.4	
Cylinder head cover bolt	4	6	1.0~1.4	
Cylinder head stud bolt (inlet pipe)	2	6	1.0~1.4	
Cylinder head stud bolt (EX. pipe)	2	8	2.4~3.0	
Air inject pipe bolt	4	6	1.0~1.4	
Air inject reed valve bolt	2	3	0.07~0.09	
Tappet adjustment screw nut	4	5	0.7~1.1	
Spark plug	1	10	1.0~1.2	
Tensioner lifter bolt	2	6	1.0~1.4	
Carburetor insulator bolt	2	6	0.7~1.1	
Oil pump screw	2	3	0.1~0.3	
Water pump impeller	1	7	1.0~1.4	
Engine left cover bolt	9	6	1.1~1.5	
Engine oil draining bolt	1	12	3.5~4.5	
Engine oil strainer cap	1	30	1.3~1.7	
Mission draining bolt	1	8	1.1~1.5	
Mission filling bolt	1	12	3.5~4.5	
Shift drum fixing bolt	1	14	3.5~4.5	
Clutch driving plate nut	1	28	5.0~6.0	
Clutch outer nut	1	14	5.0~6.0	
Drive face nut	1	14	8.5~10.5	
ACG. Flywheel nut	1	14	5.0~6.0	
Crankcase bolts	7	6	0.8~1.2	
Mission case bolt	7	8	2.6~3.0	



# 1. GENERAL INFORMATION

## Frame Torque Values

Item	Q'ty	Thread Dia. (mm)	Torque Value(kgf-m)	Remarks
Handlebar upper holder bolt	4	6	2.40	
Steering shaft nut	1	10	5.00	
Steering tie-rod nut	4	10	5.00	
Knuckle nut	2	10	5.00	
Steering shaft holder bolt	2	8	3.40	
Tie rod lock nut	4	10	3.60	
Handlebar under holder nut	2	8	4.00	
Front wheel nut	8	10	2.40	
Front axle castle nut	2	14	5.00	
Rear axle castle nut	2	14	5.00	
Rear wheel nut	8	10	2.40	
Engine hanger nut	4	12	8.50	
Rear axle holder bolt	4	12	9.20	
Drive gear bolt	2	10	4.6	
Driven gear nut	4	10	4.6	
Swing arm pivot bolt	1	14	9.20	
Front suspension arm nut	4	10	5.00	
Front / Rear cushion mounting bolt	6	10	4.60	
Brake lever nut	2	6	1.00	
Brake hose bolt	13	10	3.50	
Brake caliper bolt	6	6	3.25	
Brake disk mounting bolt	11	8	4.25	
Air-bleed valve	3	5	0.50	
Exhaust muffler mounting bolt	2	8	3.00	
Exhaust muffler connection nut	2	7	1.20	

Troubles Diagnosis

A. Engine hard to start or can not be started

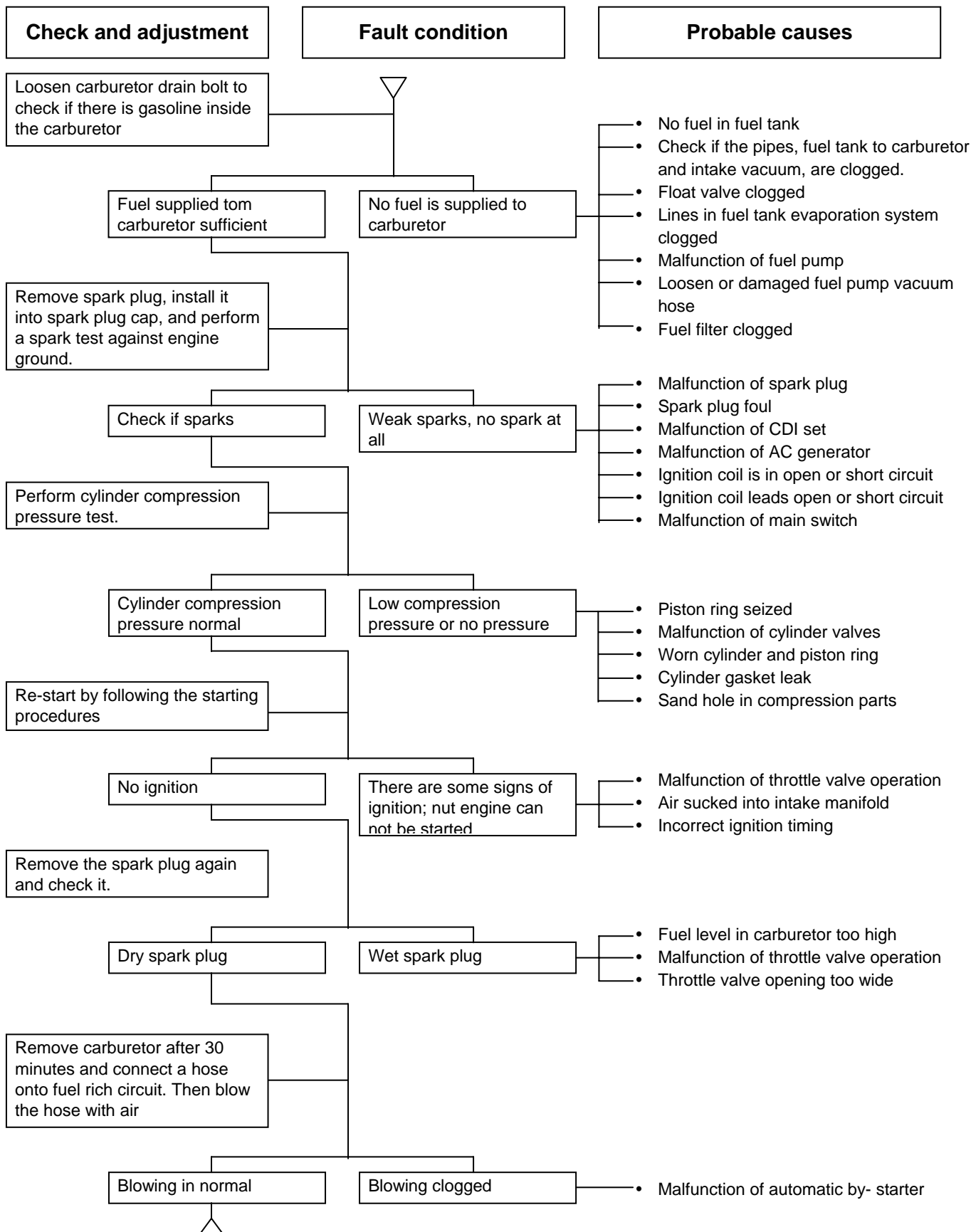

# 1. GENERAL INFORMATION

## B. Engine run sluggish (Speed does not pick up, lack of power)

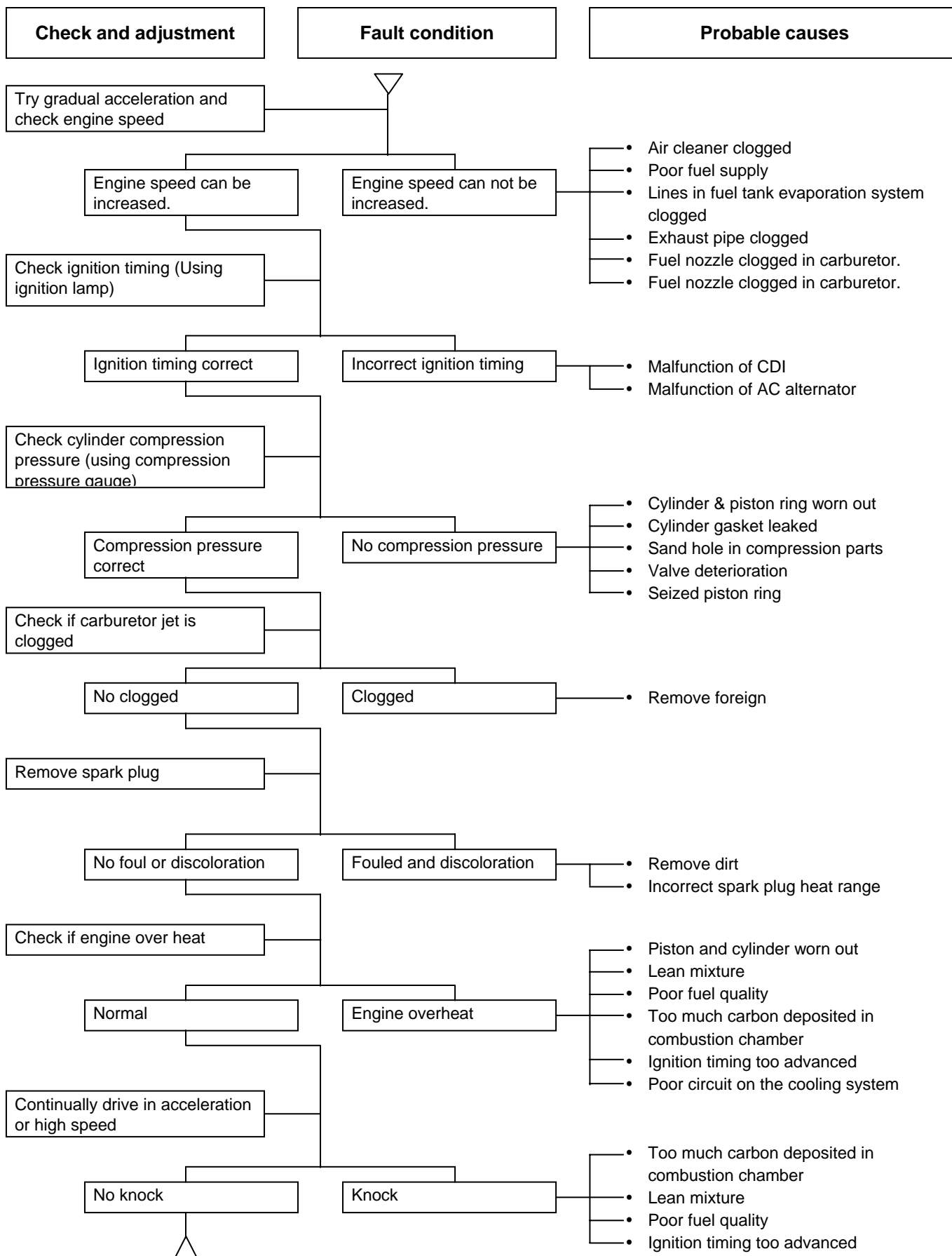

**C. Engine runs sluggish (especially in low speed and idling)**

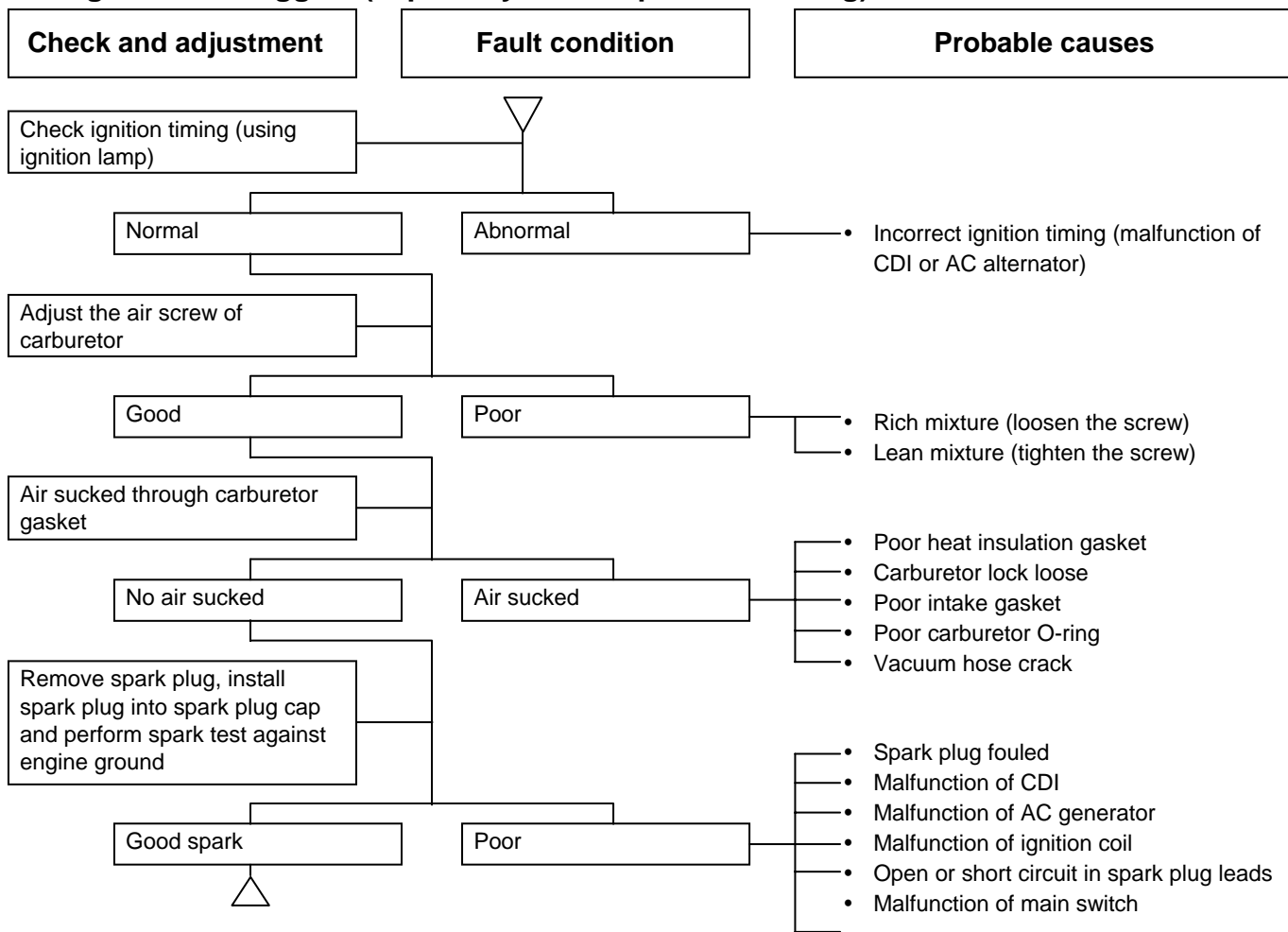

**D. Engine runs sluggish (High speed)**

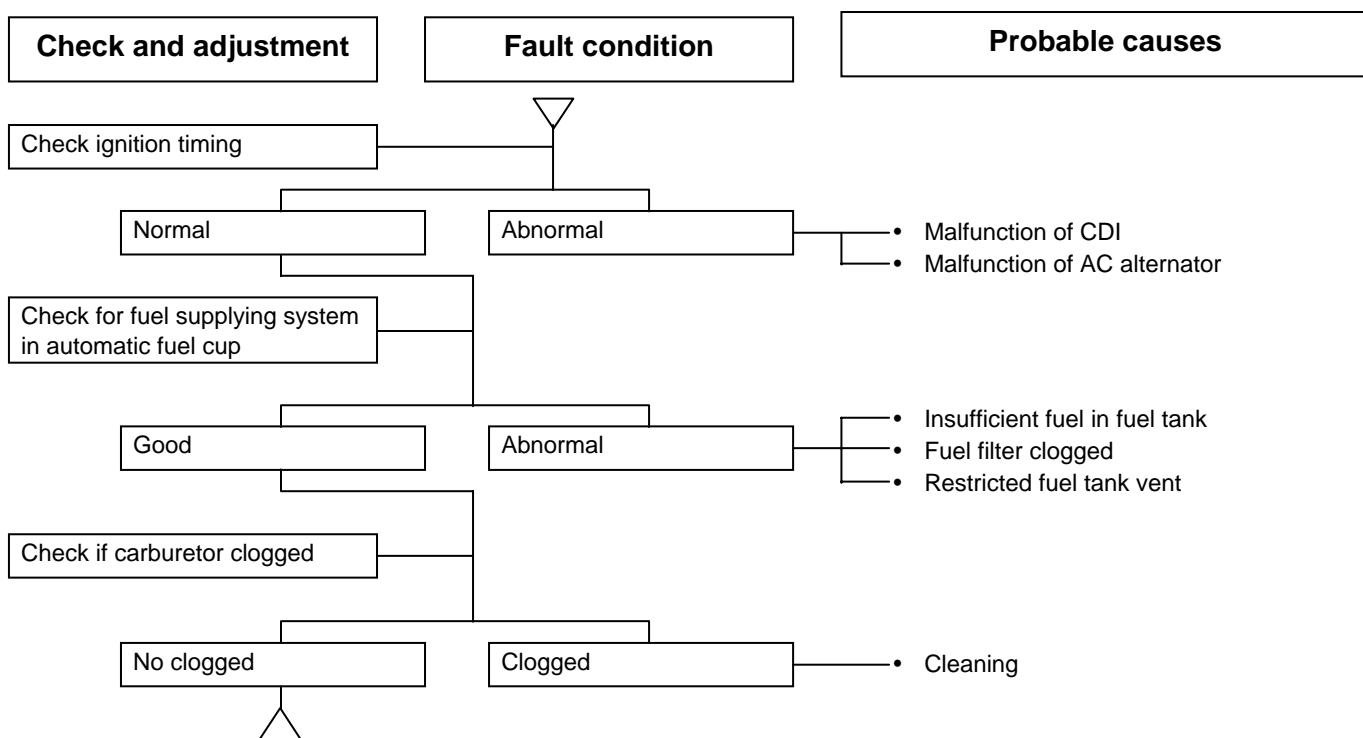

# 1. GENERAL INFORMATION

## E. Clutch, driving and driving pulley

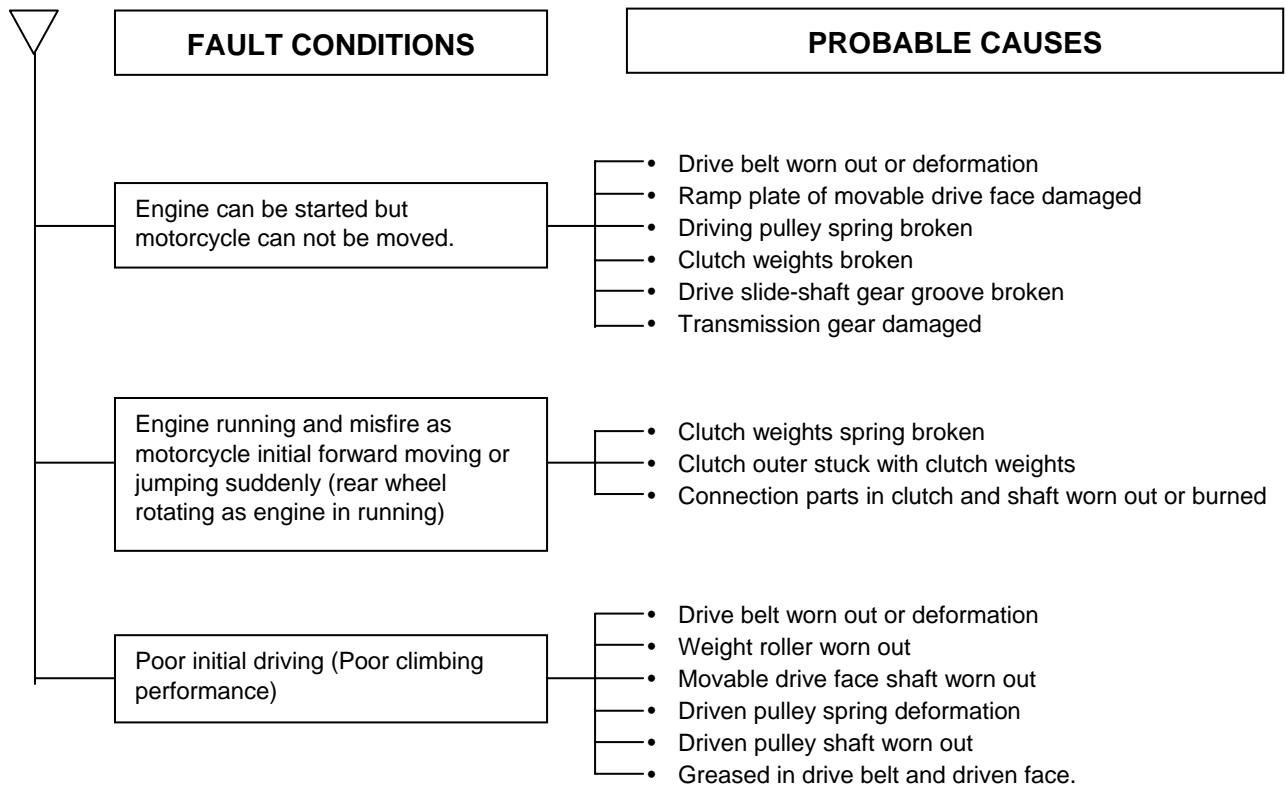

## F. Poor handling

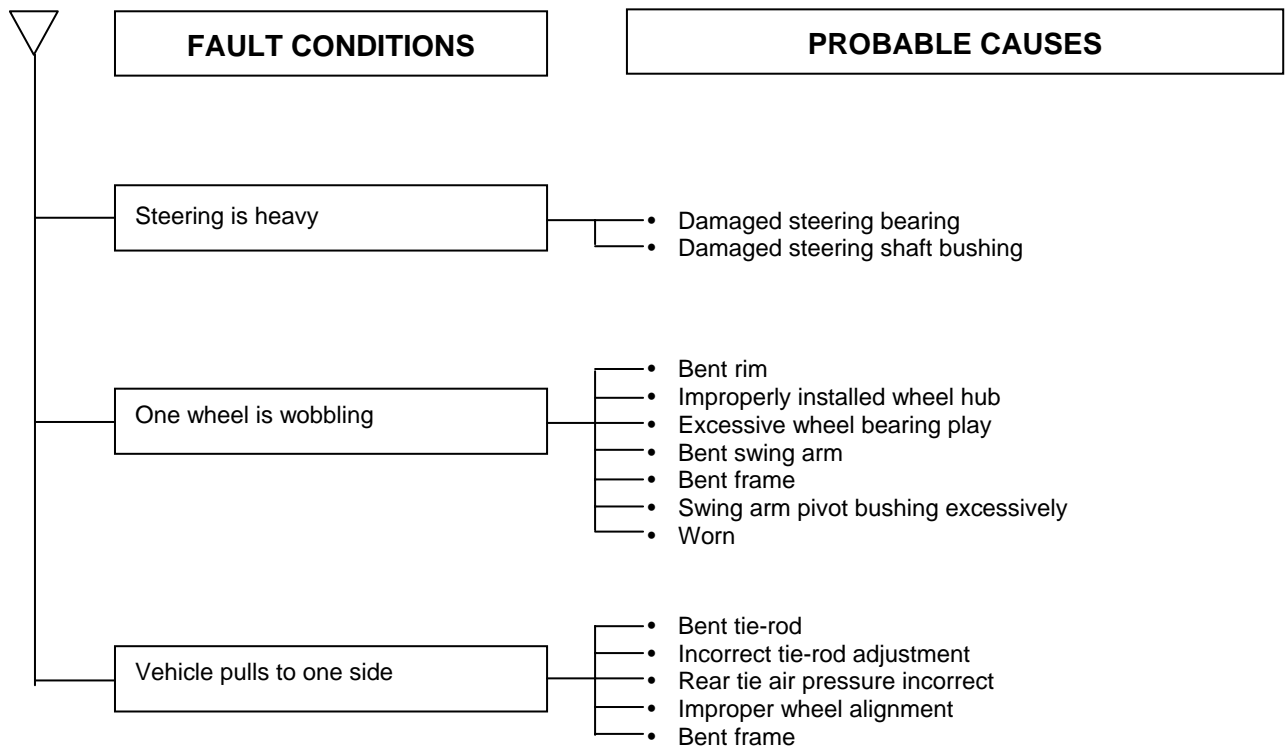

G. Loss power

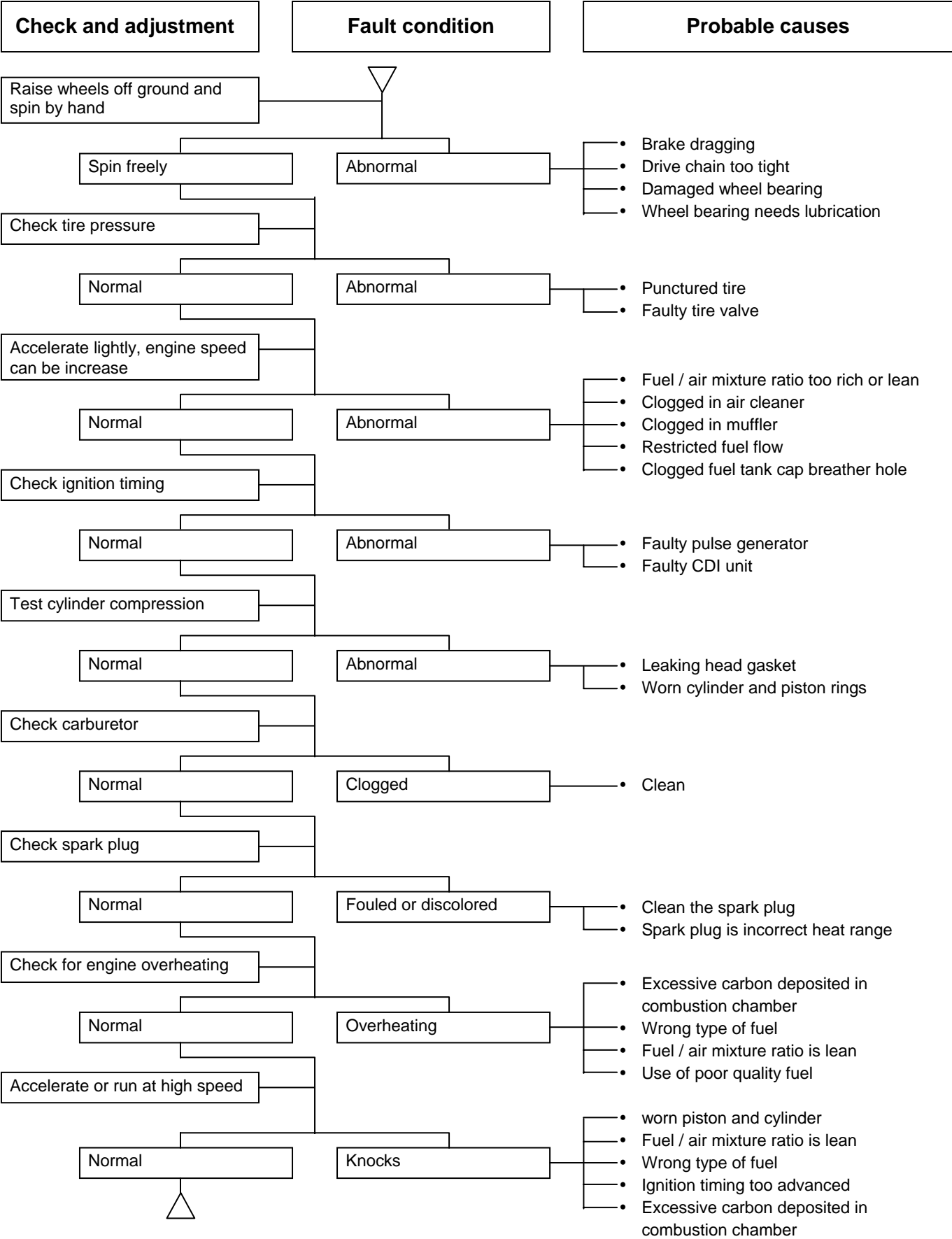

# 1. GENERAL INFORMATION

## Lubrication Points



 Drive chain



 Acceleration cable/ Front & rear brake lever pivot

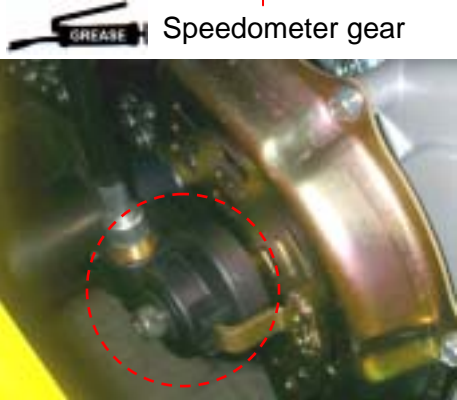
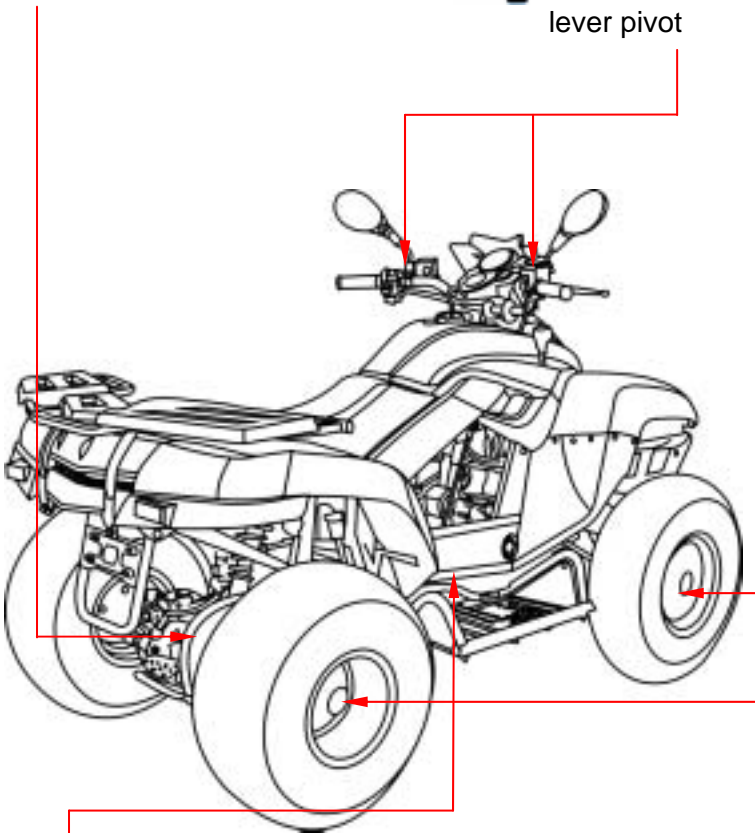

 Speedometer gear



 Wheel bearing

<b>Precautions in Operation</b> .....	<b>2-1</b>	<b>Drive Chain</b> .....	<b>2-7</b>
<b>Periodical Maintenance Schedule</b> .....	<b>2-2</b>	<b>Brake System (Disk Brake)</b> .....	<b>2-8</b>
<b>Fuel Lines</b> .....	<b>2-3</b>	<b>Brake Light Switch/Starting Inhibitor Switch</b> .....	<b>2-9</b>
<b>Acceleration Operation</b> .....	<b>2-3</b>	<b>Headlight Beam Distance</b> .....	<b>2-10</b>
<b>Air Cleaner</b> .....	<b>2-3</b>	<b>Clutch Disc Wear</b> .....	<b>2-10</b>
<b>Spark Plug</b> .....	<b>2-3</b>	<b>Cushion</b> .....	<b>2-10</b>
<b>Valve Clearance</b> .....	<b>2-4</b>	<b>Steering Handle</b> .....	<b>2-11</b>
<b>Carburetor Idle Speed Adjustment</b> .....	<b>2-5</b>	<b>Wheel/Tire</b> .....	<b>2-11</b>
<b>Ignition System</b> .....	<b>2-6</b>	<b>Nuts, Bolts Tightness</b> .....	<b>2-11</b>
<b>Cylinder Compression Pressure</b> .....	<b>2-6</b>	<b>Special Tools List</b> .....	<b>2-12</b>
<b>Drive Belt</b> .....	<b>2-7</b>		

## Precautions in Operation

### Specification

Fuel Tank Capacity		12000 c.c.
Engine Oil	Capacity	1400 c.c.
	Change	1200 c.c.
Transmission Gear oil	Capacity	750 c.c.
	Change	650 c.c.
Capacity of coolant	Engine + radiator	850 c.c.
	Reservoir upper	420 c.c.
Clearance of throttle valve		1~3 mm
Spark plug	Type	NGK CR8E
	Gap	0.8 mm
"F" Mark in idling speed		BTDC 10° / 1700 rpm
Full timing advanced		BTDC 27° / 4000 rpm
Idling speed		1700±100 rpm
Cylinder compression pressure		12.0 ±2 kgf/cm <sup>2</sup>
Valve clearance		IN:0.10 ± 0.02 mm    EX:0.15 ± 0.02 mm
Tire dimension	Front	AT22x7-10
	Rear	AT22x10-9
Tire pressure (cold)		3.8±2 psi
Battery		12V10Ah (MF battery) type: YTX12-BS



## 2. MAINTENANCE INFORMATION



### Periodical Maintenance Schedule

Maintenance Code	Item	Every 300KM	1 Month every 1,000KM	3 month every 3,000KM	6 month every 6000KM	1 year every 12,000KM	15 month every 14,500KM
1	Air cleaner	I	C			R	
2	Fuel filter	I			I	R	
3	Oil filter	C			C		
4	Engine oil change	R	Replacement for every 1000 km				
5	Tire pressure	I	I				
6	Battery inspection	I	I				
7	Brake & free ply check	I	I				
8	Steering handle check	I			I		
9	Cushion operation check	I			I		
10	Every screw tightening check	I	I				
11	Gear oil check for leaking	I	I				
12	Spark plug check or change	I		I	R		
13	Gear oil change	R	Replacement for every 5000 km				
14	Frame lubrication				L		
15	Exhaust pipe	I	I				
16	Ignition timing	I	I				
17	emission check in Idling	A	I				
18	Throttle operation	I	I				
19	Engine bolt tightening	I		I			
20	CVT driving device(belt)				I	R	
21	CVT driving device(roller)				C		
22	Drive chain	I / L	I / L		C		
23	Lights/electrical equipment/multi-meters	I	I				
24	Fuel lines	I		I			
25	Cam chain	I		I			
26	Valve clearance	I		A			
27	Lines & connections in cooling	I	I				
28	Coolant reservoir	I	I				
29	Coolant	I	I			R	

**Code: I ~ Inspection, cleaning, and adjustment**      **R ~ Replacement**  
**C ~ Cleaning (replaced if necessary)**      **L ~ Lubrication**

Have your ATV checked, adjusted, and recorded maintenance data periodically by your SYM Authorized Dealer to maintain the ATV at the optimum condition

The above maintenance schedule is established by taking the monthly 1000 kilometers as a reference which ever comes first.

- Remarks:
1. Clean or replace the air cleaner element more often when the ATV is operated on dusty roads or in the Heavily- polluted environment.
  2. Maintenance should be performed more often if the ATV is frequently operated in high speed and after the ATV has accumulated a higher mileage.
  3. Preventive maintenance
    - a. Ignition system - Perform maintenance and check when continuous abnormal ignition, misfire, after-burn, overheating occur.
    - b. Carbon deposit removal - Remove carbon deposits in cylinder head, piston heads, exhaust system when power is obvious lower. Than ever

## Fuel Lines

Remove the seat.  
Loosen 2 screws and 2 bolts  
Remove the tank cover  
Check all lines, and replace it when they are deterioration, damage or leaking

### Warning

Gasoline is a low ignition material so any kind of fire is strictly prohibited as dealing it.

## Acceleration Operation

Have a wide open of throttle valve as handle in any position and release it to let back original (full closed) position.

Check handle if its operation is smooth.  
Check acceleration cable and replace it if deteriorated, twisted or damaged.  
Lubricate the cable if operation is not smooth.  
Measure the throttle lever free play in its flange part.

Remove rubber boot, loosen fixing nut, and then adjust it by turning the adjustment screw.  
Tighten the fixing nut, and check acceleration operation condition.

**Free play: 1~3 mm.**

## Air Cleaner

Remove seat.  
loosen 4 hooks from the air cleaner cover and then remove the cover.  
Loosen the clamp strip and 1 screw of air cleaner element, and then remove the air cleaner element.  
Clean the element with non-flammable or high-flash point solvent and then squeeze it for dry.

### Caution

Never use gasoline or acid organized solvent to clean the element.

Soap the element into cleaning engine oil and then squeeze it out. Install the element onto the element seat and then install the air cleaner cover.

## Spark Plug

Recommended spark plug: CR8E  
Remove spark plug cap.  
Clean dirt around the spark plug hole.  
Remove spark plug.  
Measure spark plug gap.

**Spark plug gap : 0.8 mm**

Carefully bend ground electrode of the plug to adjust the gap if necessary.  
Hold spark plug washer and install the spark plug by screwing it.  
Tighten the plug by turning 1/2 turn more with plug socket after installed.

**Tighten torque: 1.0~1.2kgf-m**

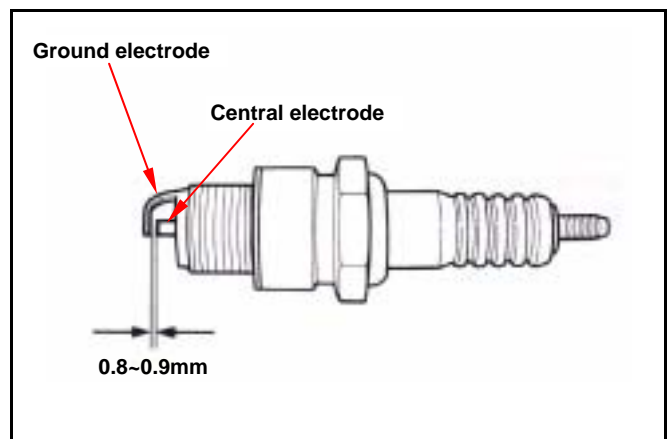
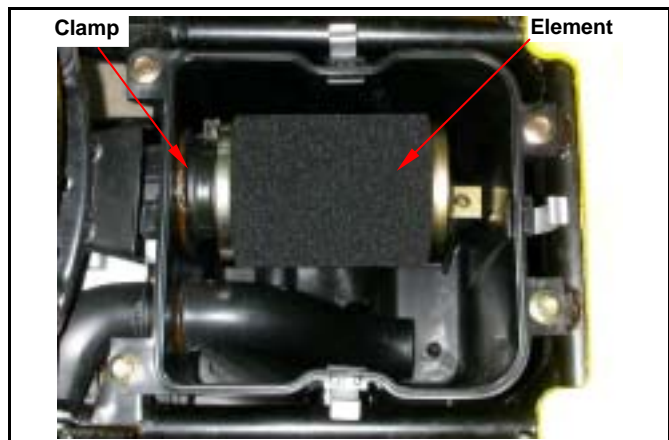
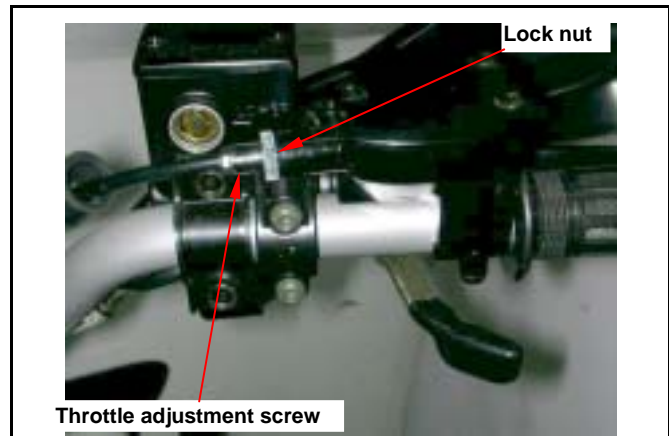
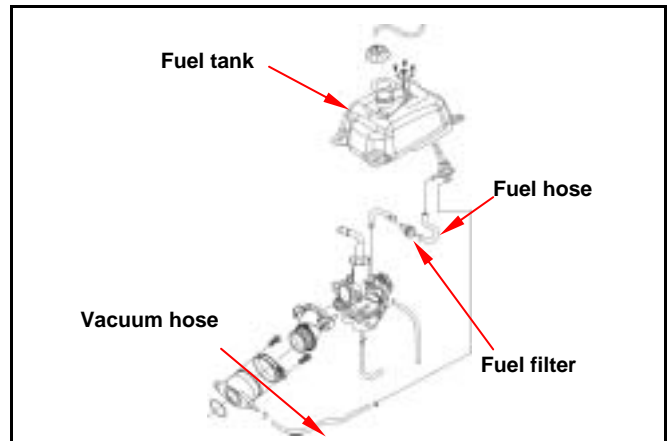

## 2. MAINTENANCE INFORMATION

### Valve Clearance

#### Caution

Checks and adjustment must be performed when the engine temperature is below 35 .

Remove front fender, fuel tank cover and fuel tank.  
Remove cylinder head cover.  
Remove cylinder head side cover.  
Turn camshaft bolt in C.W. direction and let the "T" mark on the camshaft sprocket align with cylinder head mark so that piston is placed at TDC position in compression stroke.

#### Caution

Do not turn the bolt in C.C.W. direction to prevent from camshaft bolt looseness.

Valve clearance inspection and adjustment.  
Check & adjust valve clearance with feeler gauge.

**Standard Value: IN  $0.10 \pm 0.02$  mm**

**EX  $0.15 \pm 0.02$  mm**

Loosen fixing nut and turn the adjustment nut for adjustment.

#### Caution

Re-check the valve clearance after tightened the fixing nut.

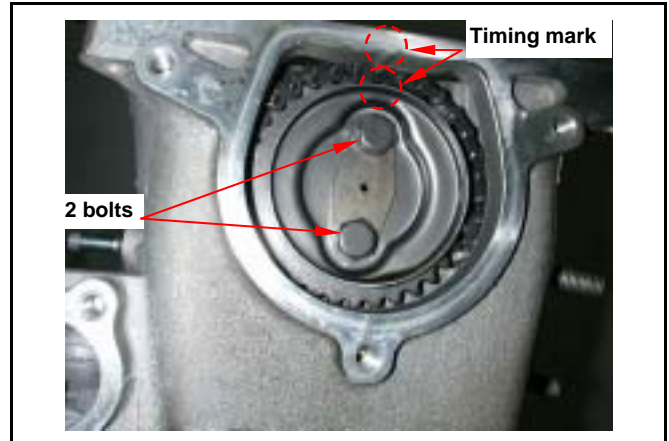

## Carburetor Idle Speed Adjustment

### Caution

- Inspection & adjustment for idle speed have to be performed after all parts in engine that needed adjustment have been adjusted.
- Idle speed check and adjustment have to be done after engine is being warm up. (It is enough that operates engine from stop to running for 10 minutes.)

Park the ATV with main stand and warm up engine.

Connect tachometer (the wire clamp of tachometer is connected to the high tension cable).

Turn the throttle valve stopper screw to specified idle speed.

Specified idle speed:  $1700 \pm 100$  rpm

### Emission adjustment in idle speed

Warm up the engine for around 10 minutes and then conduct this adjustment.

1. Connect the tachometer onto engine.
2. Adjust the throttle valve stopper screw and let engine runs in  $1600 \pm 100$  rpm.
3. Insert the exhaust sampling pipe of exhaust analyzer into the front section of exhaust pipe. Adjust the air adjustment screw so that emission value in idle speed is within standard.
4. Slightly accelerate the throttle valve and release it immediately. Repeat this for 2~3 times.
5. Read engine RPM and value on the exhaust analyzer. Repeat step 2 to step 4 procedures until measured value within standard.

**Emission standard**    **CO: below 2.5~3.5%**  
                                   **HC: below 2000ppm**

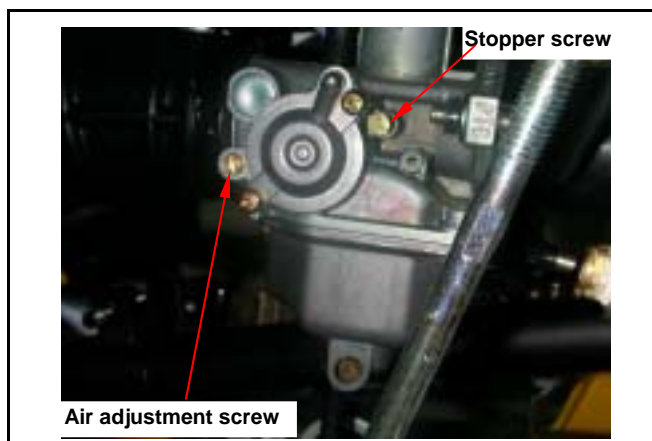
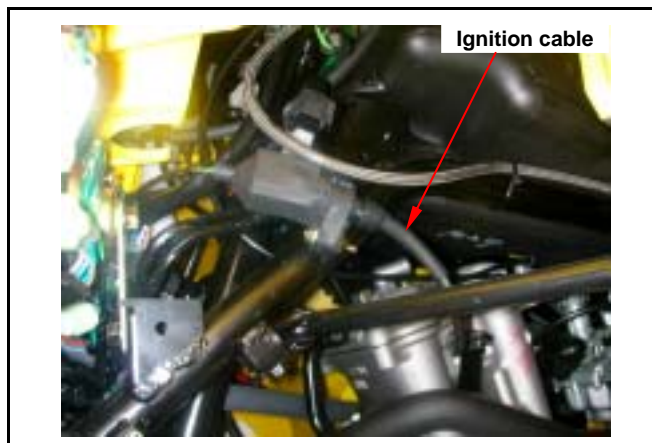

## 2. MAINTENANCE INFORMATION

### Ignition System

#### Caution

- C.D.I ignition system is set by manufacturer so it can not be adjusted.
- Ignition timing check procedure is for checking whether CDI function is in normal or not.

Connect tachometer and ignition light.

Start engine.

As engine in idle speed: 1600 rpm, aim at the mark "F" with the ignition light. Then, it is means that ignition timing is correct.

Increase engine speed to 6000 rpm to check ignition advance degree. If indent is located within the ignition advance degrees, it is means that the ignition advance degree is in normal.

If ignition timing is incorrect, check CDI set, pulse rotor and pulse generator. Replace it if malfunction of these parts is found.

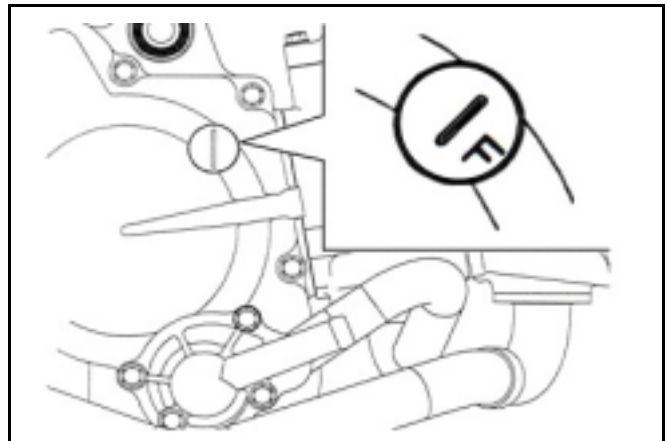
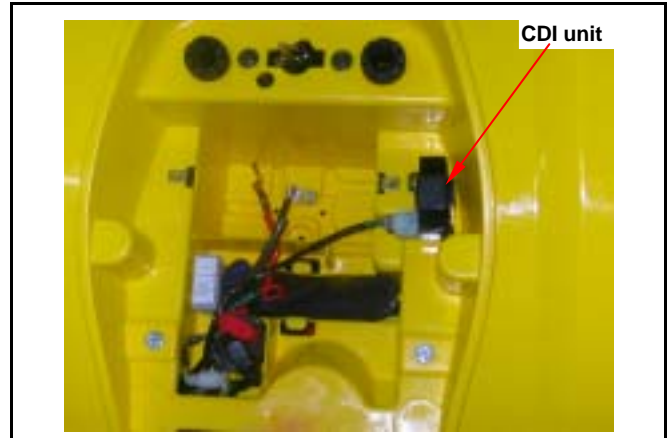

### Cylinder Compression Pressure

Warm up engine.

Turn off the engine.

Remove the trunk.

Remove the central cover.

Remove spark plug cap and spark plug.

Install compression gauge.

Full open the throttle valve, and rotate the engine by means of starter motor.

#### Caution

Rotate the engine until the reading in the gauge no more increasing.  
Usually, the highest pressure reading will be obtained in 4~7 seconds.

**Compression pressure:  $12 \pm 2 \text{ Kg/cm}^2$**

Check following items if the pressure is too low:

- Incorrect valve clearance.
- Valve leaking.
- Cylinder head leaking, piston, piston ring and cylinder worn out.

If the pressure is too high, it means carbon deposits in combustion chamber or piston head.

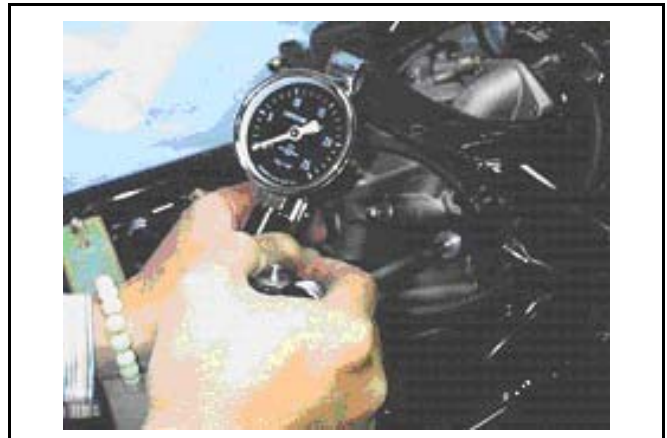

## Drive Belt

Loosen the 2 clamp strips of left crankcase cover, and then remove the left crankcase cover vapor hose.

Remove 9 bolts of the engine left side cover and the cover.

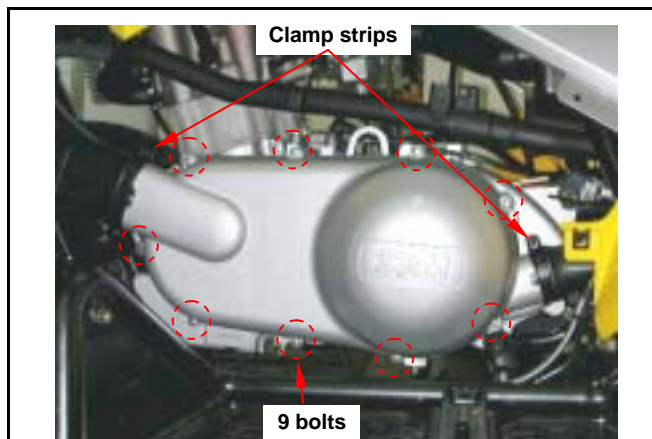

Check if the belt is crack or worn out. Replace the belt if necessary or in accord with the periodical maintenance schedule to replace it.

**Width limit: 22.5 mm or above**

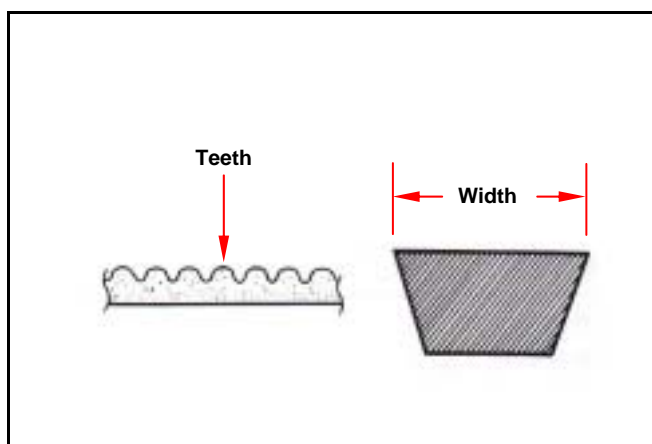

## Drive Chain

### Check the drive chain

Park the ATV on a level ground, and shift the transmission onto neutral. Measure the drive chain slack midway between the sprockets.

**Chain slack: 15~25mm (5/8~1 inch)**



### Adjust the chain slack

Loosen the axle holder lock nuts and bolts. Loosen drive chain adjusting bolt lock nut and turn drive chain adjusting bolt until get the correct slack.

Tighten the axle holder nuts and bolts.

**Torque: 3.25kgf-m**

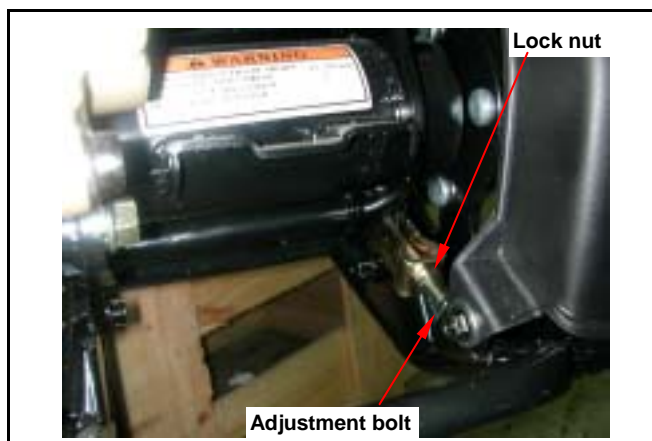

## 2. MAINTENANCE INFORMATION

### Brake System (Disk Brake)

#### Brake System Hose

Make sure the brake hoses for corrosion or leaking oil.

#### Brake Fluid

Check brake fluid level in the brake fluid reservoir. If the level is lower than the LOWER limit, add brake fluid to UPPER limit. Also check brake system for leaking if low brake level found

#### Caution

- In order to maintain brake fluid in the reservoir in horizontal position, do not remove the cap until handle stop.
- Do not operate the brake lever after the cap had been removed. Otherwise, the brake fluid will spread out if operated the lever.
- Do not mix non-compatible brake fluid together.

#### Filling Out Brake Fluid

Tighten the drain valve, and add brake fluid. Operate the brake lever so that brake fluid contents inside the brake system hoses.

#### Air Bleed Operation

Connect a transparent hose to draining valve. Hold the brake lever and open air bleeding valve. Perform this operation alternative until there is no air inside the brake system hoses.

#### Caution

Before closing the air bleed valve, do not release the brake lever.

#### Added Brake Fluid

Add brake fluid to UPPER limit lever. Recommended brake fluid: DOT3 or DOT4 WELL RUN brake fluid.

#### Caution

Never mix or use dirty brake fluid to prevent from damage brake system or reducing brake performance.

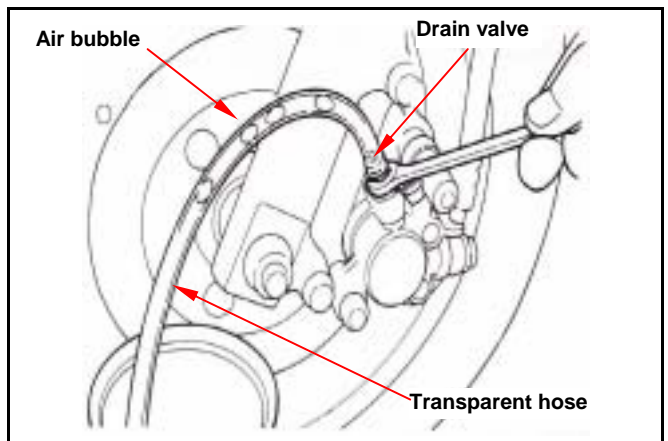
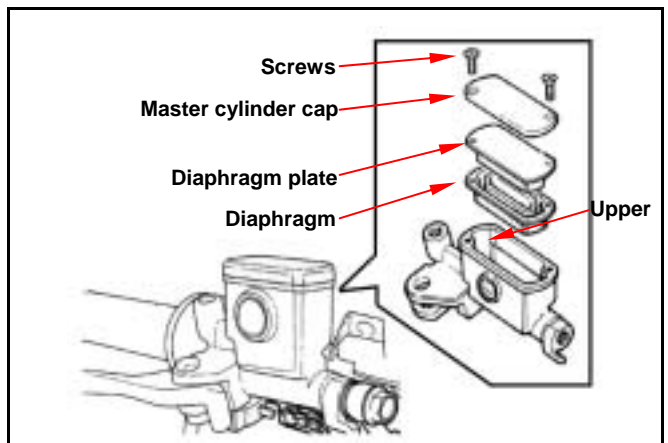
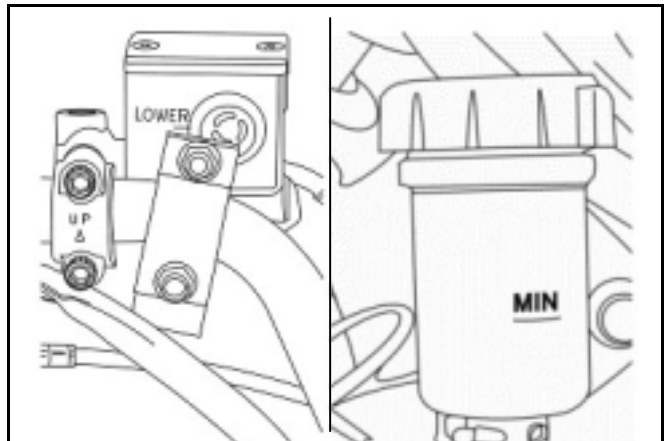

### Brake Lining Wear

The indent mark on brake lining is the wear limitation.

Replace the brake lining if the wear limit mark closed to the edge of brake disc.

#### Caution

- To check front brake lining must be remove front wheel first.
- It is not necessary to remove brake hose when replacing the brake lining.

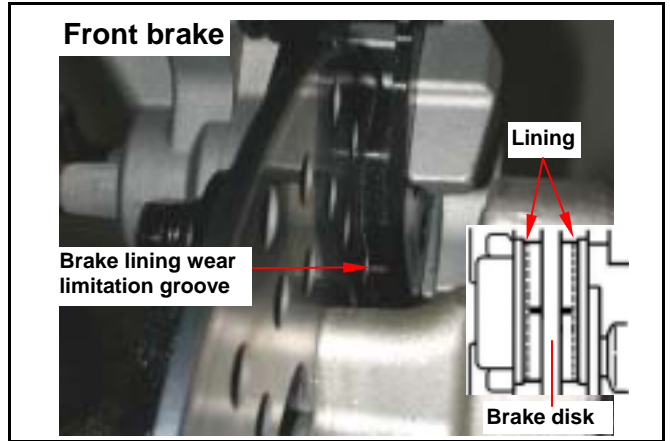

### Brake Lining Replacement (refer chapter 14)

Make sure the brake lining condition. Replace the lining if the brake lining wear limitation groove close to the brake disc.

#### Caution

- Do not operate the brake lever after the clipper removed to avoid clipping the brake lining.
- In order to maintain brake power balance, the brake lining must be replaced with one set.

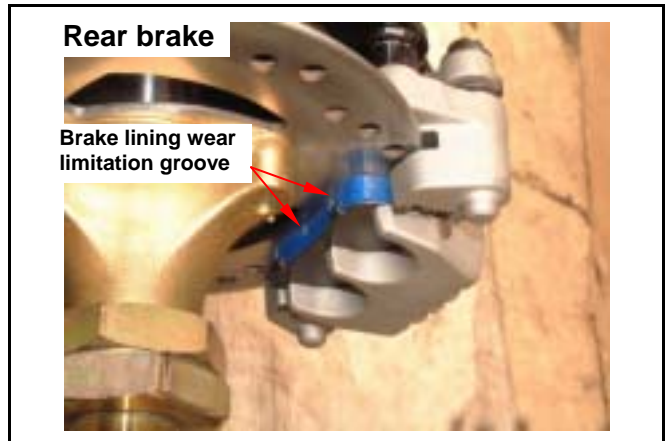

### Brake Light Switch/Starting Inhibitor Switch

The brake light switch is to light up brake light as brake applied.

Make sure that electrical starter can be operated only under brake applying.

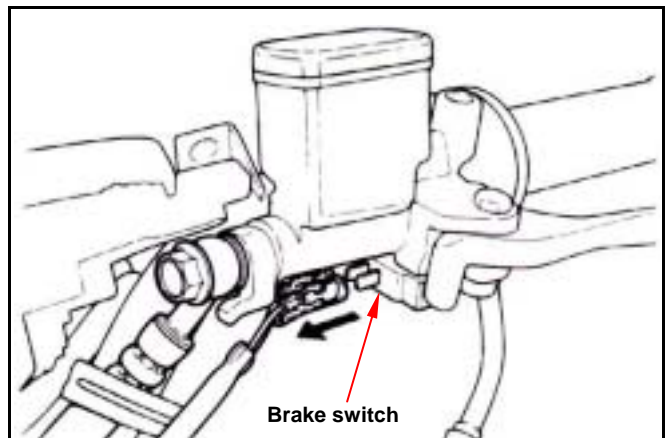
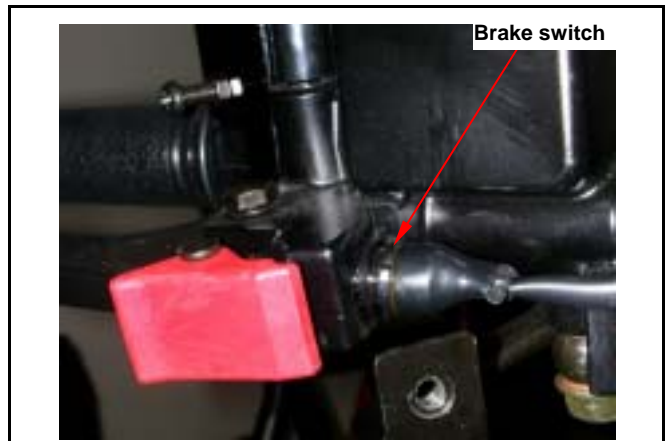



## 2. MAINTENANCE INFORMATION

### Headlight Beam Distance

Turn on main switch

Headlight beam adjustment. Turn the headlight adjustment screw to adjust headlight beam high.

#### Caution

- To adjust the headlight beam follows related regulations.
- Improper headlight beam adjustment will make in coming driver dazzled or insufficient lighting.

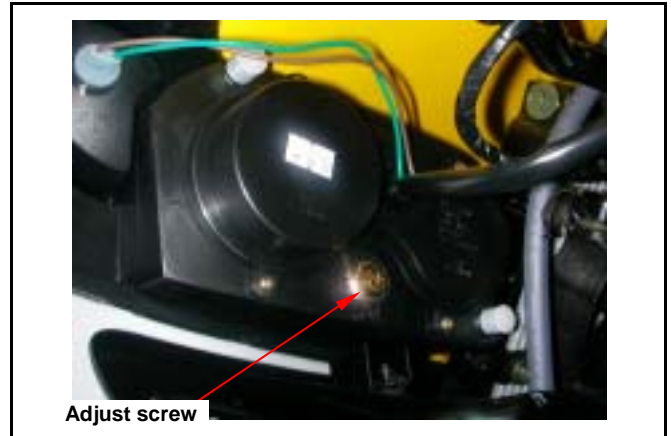

### Clutch Disc Wear

Run the ATV and increase throttle valve opening gradually to check clutch operation. If the ATV is in forward moving and shaking, check clutch disc condition. Replace it

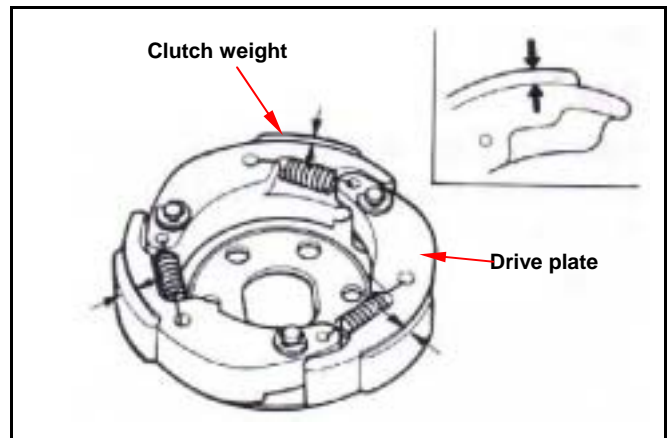

### Cushion

#### Warning

- Do not ride the ATV with poor cushion.
- Looseness, wear or damage cushion will make poor stability and drive-ability.

#### Front cushion

Press down the front cushion for several times to check it operation.

Check if it is damage

Replace relative parts if damage found.

Tighten all nuts and bolts.

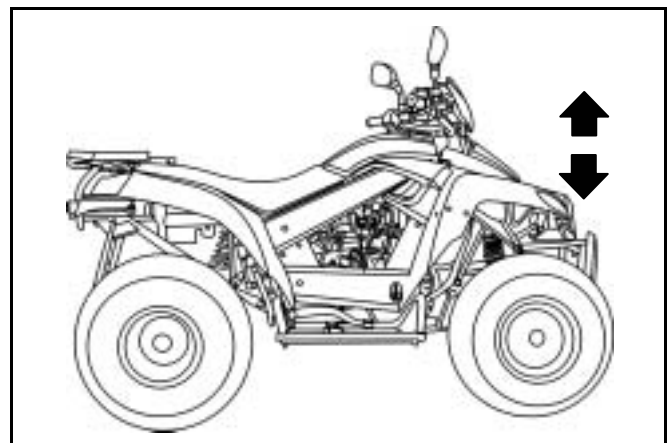

#### Rear Cushion

Press down the rear cushion for several times to check it operation.

Check if it is damage

Replace relative parts if damage found.

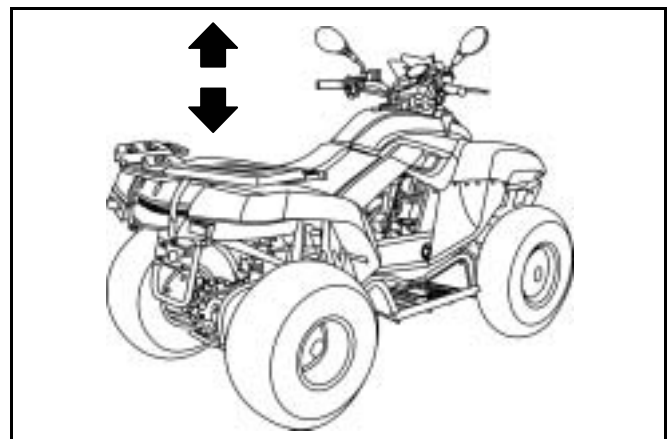

### Steering Handle

**⚠ Caution**

Check all wires and cables if they are interfered with the rotation of steering handle bar.

Lift the front wheel out of ground.  
 Turn handle from right to left alternative and check if turning is smoothly.  
 If handle turning is uneven and bending, or the handle can be operated in vertical direction, then check the handle top bearing.

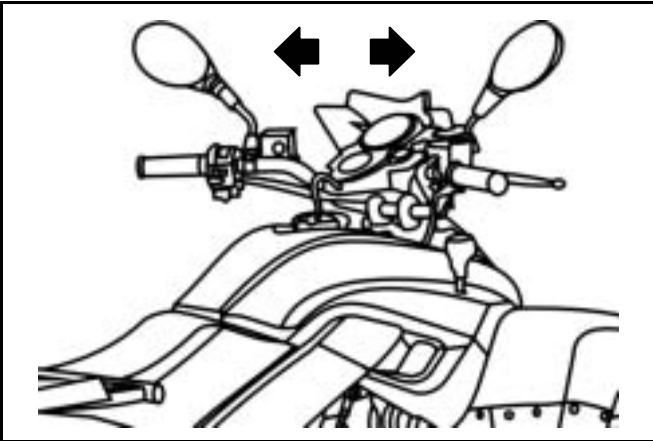

### Wheel/Tire

**⚠ Caution**

Tire pressure check should be done as cold engine.

Check if tire surface is ticked with nails, stones or other materials.

**Appointed tire pressure**

Tire size	Front tire	Rear tire
Tire pressure as cold	3.8±2psi	

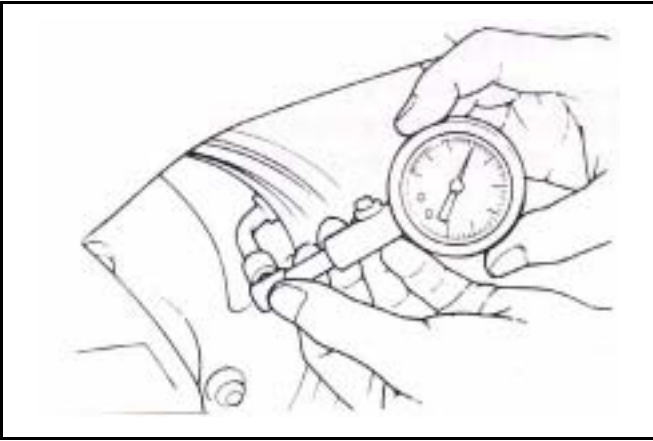

Check if front and rear tires' pressure is in normal.  
 Measure tire thread depth from tire central surface.  
 Replace the tire if the depth is not come with following specification:  
 Front tire: 1.5 mm  
 Rear tire: 2.0 mm

### Nuts, Bolts Tightness

Perform periodical maintenance in accord with the Periodical Maintenance Schedule

Check if all bolts and nuts on the frame are tightened securely.

Check all fixing pins, snap rings, hose clamp, and wire holders for security.

2. MAINTENANCE INFORMATION









Special Tools List

					
NAME	Rocker arm pin puller	NAME	Tappet adjusting wrench	NAME	Tappet adjusting wrench
NO	SYM-1445100	NO	SYM-9001200	NO	SYM-1472100
					
NAME	Tappet adjuster	NAME	Valve cotter remove & assembly tool	NAME	AC.G. Flywheel puller
NO	SYM-9001209	NO	SYM-1471110/20	NO	SYM-3110000-HMA
					
NAME	Left crank seal driver	NAME	Drive shaft puller	NAME	Driver shaft install bush & seal driver
NO	SYM-1332100-HMA	NO	SYM-2341110-HMA	NO	SYM-9120200-HMA
					
NAME	Bearing driver 6205LLU	NAME	Rear axle bearing driver	NAME	Counter shaft needle bearing drive HK1516
NO	SYM-9100410/440	NO	SYM-9100100 RA1 A3017	NO	SYM-9100200-HMA

					
NAME	Counter shaft needle bearing driver HK2016	NAME	Bearing driver 6305	NAME	Left crank case cover bearing driver 6000
NO	SYM-9100300-RB1	NO	SYM-2341110	NO	SYM-9615000-RA1 6000
					
NAME	Bearing driver 6205	NAME	Seal driver 14x28x7 & 14x26x6	NAME	Seal driver 30x40x5
NO	SYM-9615000	NO	SYM-9120600 RB1 RA1	NO	SYM-9120100-RA1
					
<b>(12*20*5)</b>		<b>(6901)</b>			
NAME	Water pump oil seal driver	NAME	Water pump bearing driver	NAME	Water pump mechanical seal driver
NO	SYM-9120500-H9A	NO	SYM-9100100	NO	SYM-1721700-H9A
					
<b>(6301)</b>		<b>(6204)</b>			
NAME	BEARING DRIVER	NAME	BEARING DRIVER	NAME	Lock nut driver
NO	SYM-9610000	NO	SYM-9110400	NO	SYM-9020100

2. MAINTENANCE INFORMATION



					
NAME	Inner bearing puller	NAME	Inner bearing puller	NAME	Outer bearing puller
NO	SYM-6204002	NO	SYM-6204022	NO	SYM-6204001
					
NAME	Universal holder	NAME	Clutch nut wrench	NAME	Clutch spring compressor
NO	SYM-2210100	NO	SYM-9020200	NO	SYM-2301000
 (55mm)				 (55mm)	
NAME	Rear axle nut wrench	NAME	Torque wrench	NAME	Rear axle nut torque wrench
NO	SYM-HT06007	NO	SYM-HT07004-RA1	NO	SYM-4230200
NAME		NAME		NAME	
NO		NO		NO	

Mechanism Diagram ..... 3-1	Engine Oil Strainer Clean ..... 3-3
Precautions in Operation ..... 3-2	Oil Pump ..... 3-4
Troubleshooting ..... 3-2	Gear Oil ..... 3-7
Engine Oil ..... 3-3	

#### Mechanism Diagram

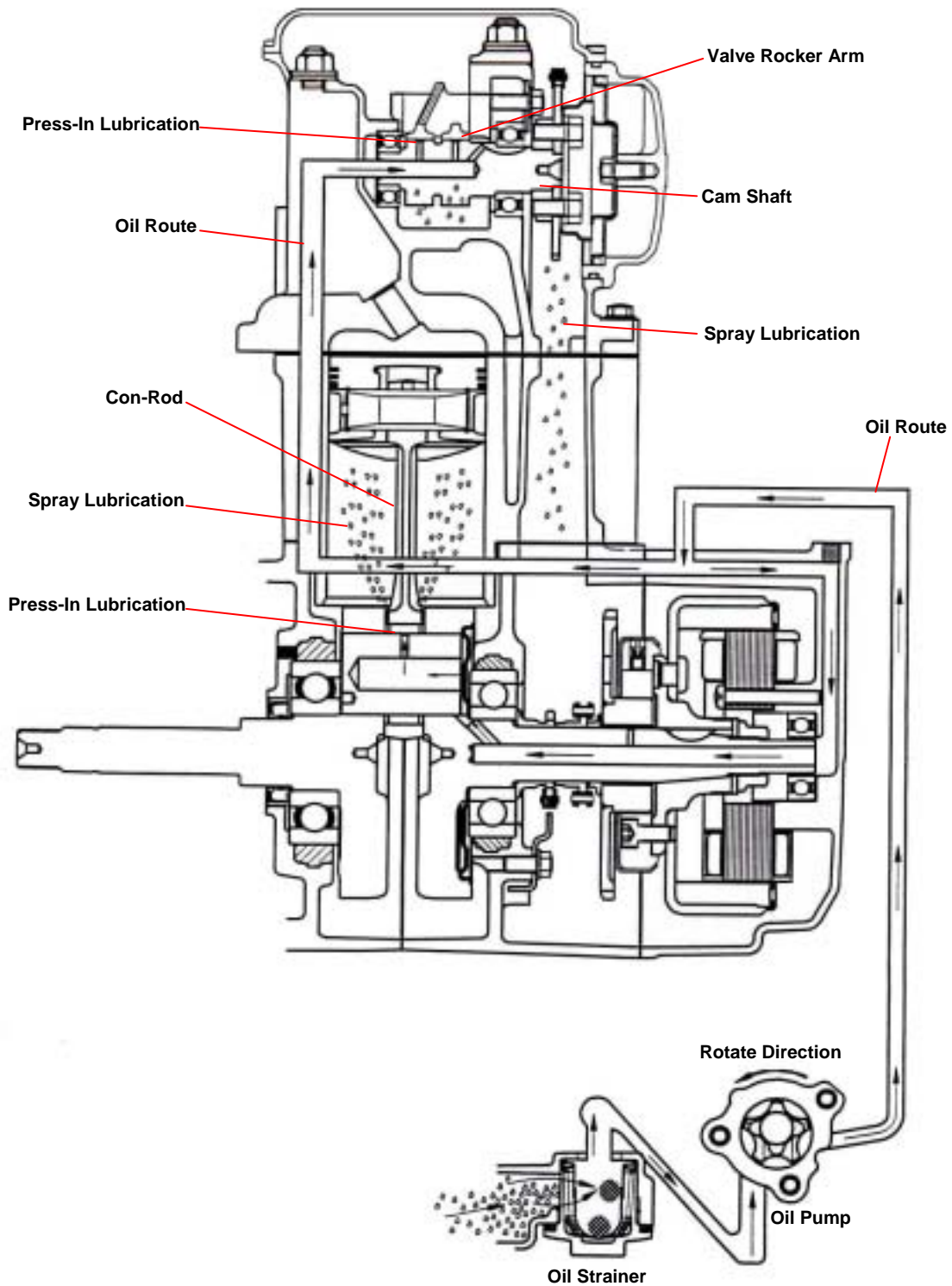

### 3. LUBRICATION SYSTEM

#### Precautions in Operation

##### General Information:

- This chapter contains maintenance operation for the engine oil pump and gear oil replacement.

##### Specifications

Engine oil quantity    Disassembly: 1400 c.c.

Change: 1200c.c.

Oil viscosity    SAE 10W-30 (Recommended King serial oils)

Gear oil    Disassembly: 750c.c.

Change: 650c.c.

Gear oil viscosity    SAE 140

(Recommended SYM Hypoid gear oils)

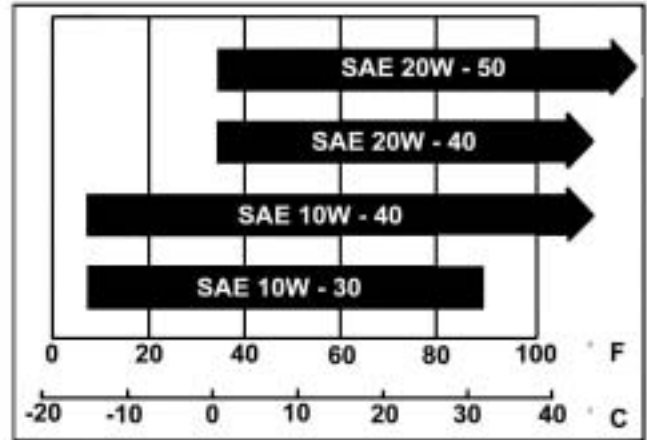

單位:mm

Items		Standard (mm)	Limit (mm)
Oil pump	Inner rotor clearance	0.15	0.20
	Clearance between outer rotor and body	0.15~0.20	0.25
	Clearance between rotor side and body	0.04~0.09	0.12

##### Torque value

Torque value oil strainer cap	1.3~1.7kgf-m
Engine oil drain bolt	3.5~4.5kgf-m
Gear oil drain bolt	1.1~1.5kgf-m
Gear oil join bolt	3.5~4.5kgf-m
Oil pump connection screw	0.1~0.3kgf-m

#### Troubleshooting

##### Low engine oil level

- Oil leaking
- Valve guide or seat worn out
- Piston ring worn out

##### Low oil pressure

- Low engine oil level
- Clogged in oil strainer, circuits or pipes
- Oil pump damage

##### Dirty oil

- No oil change in periodical
- Cylinder head gasket damage
- Piston ring worn out

## Engine Oil

Turn off engine, and park the ATV in flat surface with main stand.

Check oil level with oil dipstick.

So not screw the dipstick into engine as checking.

If oil level is nearly low level, fill out recommended oil to upper level.

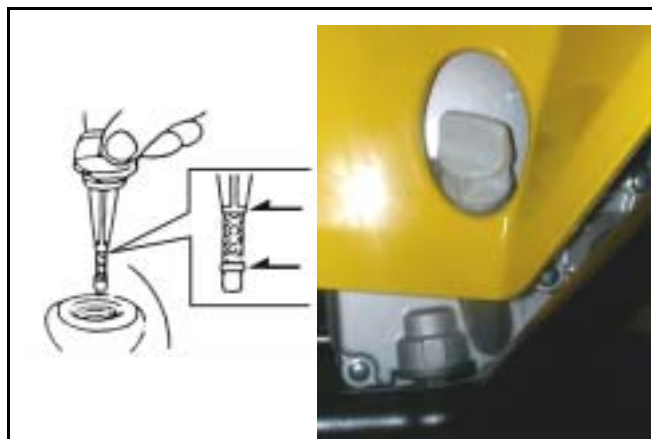

## Oil Change

### Caution

Drain oil as engine warmed up so that makes sure oil can be drained smoothly and completely.

Place an oil pan under the ATV, and remove oil drain bolt.

After drained, make sure washer can be re-used.

Install oil drain bolt.

**Torque value : 3.5~4.5kgf-m**

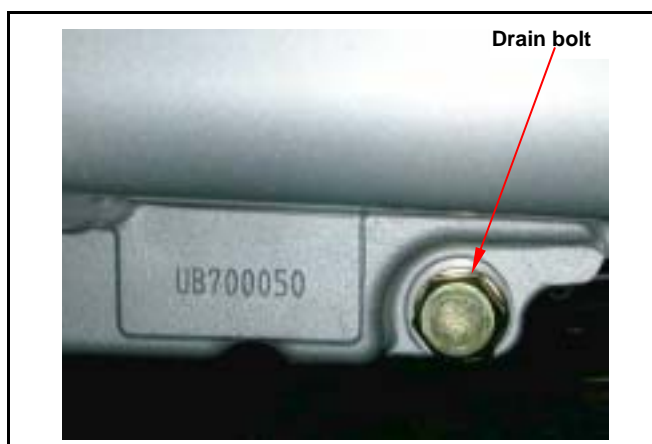

## Engine Oil Strainer Clean

Drain engine oil out.

Remove oil strainer and spring.

Clean oil strainer.

Check if O-ring can be re-used.

Install oil strainer and spring.

Install oil strainer cap.

**Torque value : 1.3~1.7kgf-m**

Add oil to crankcase (oil viscosity SAE 10W-30)

Recommended using King serial oil.

**Engine oil capacity: 1200c.c. when replacing**

Install dipstick, start the engine for running several minutes.

Turn off engine, and check oil level again.

Check if engine oil leaks.

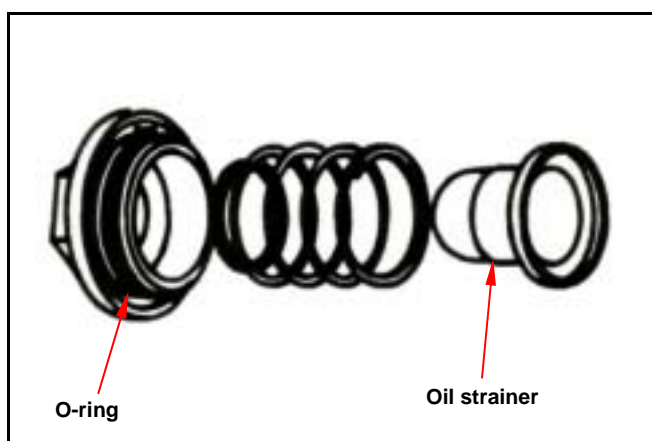



### 3. LUBRICATION SYSTEM

#### Oil Pump

##### Oil Pump Removal

Remove generator and starting gear. (Refer to chapter 10) .



Remove cir clip and take out oil pump driving chain and sprocket.

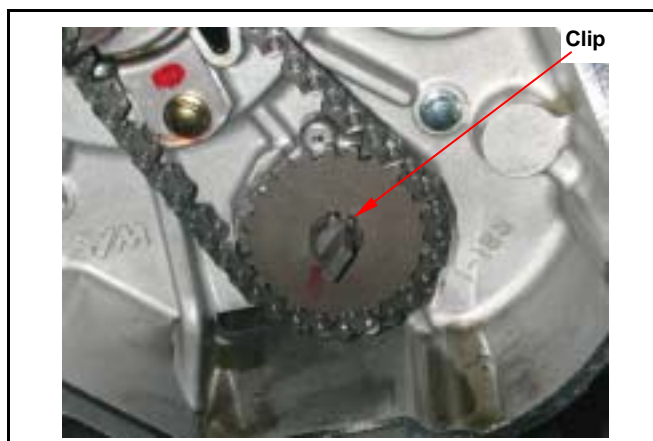

Make sure that pump shaft can be rotated freely. Remove 2 screws on the oil pump, and then remove oil pump.

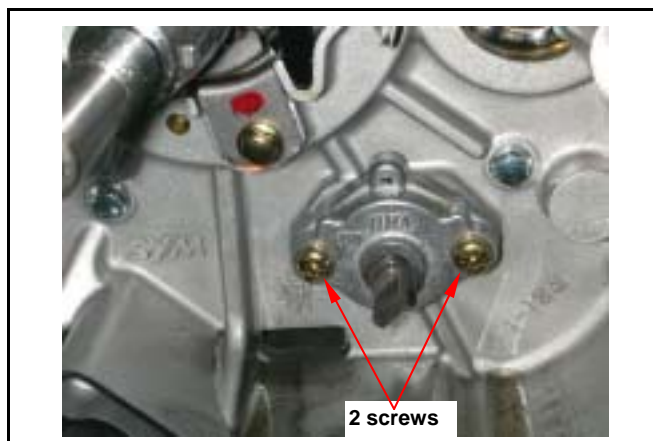

##### Oil Pump Disassembly

Remove the screws on oil pump cover and remove the cover.

Remove oil pump shaft roller and shaft.

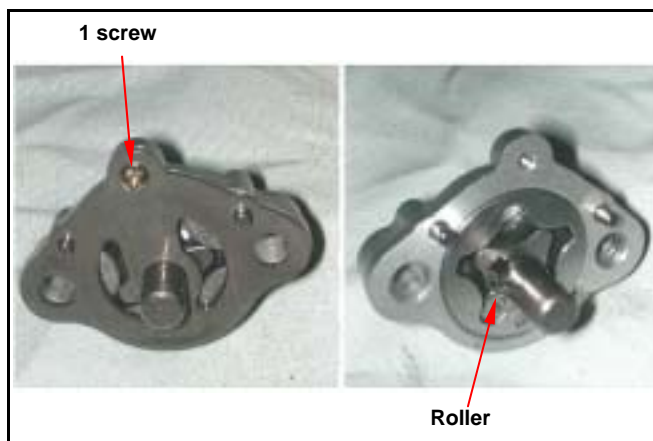

#### Oil Pump Inspection

Check the clearance between oil pump body and outer rotor.

**Limit: 0.25 mm**



Check clearance between inner and outer rotors.

**Limit: 0.20 mm**



Check clearance between rotor side face and pump body

**Limit: 0.12 mm**



#### Oil Pump Re-assembly

Install inner and outer rotors into the pump body.  
Align the indent on driving shaft with that of inner rotor.

Install the oil pump shaft and roller.

Install the oil pump cover and fixing pins properly.

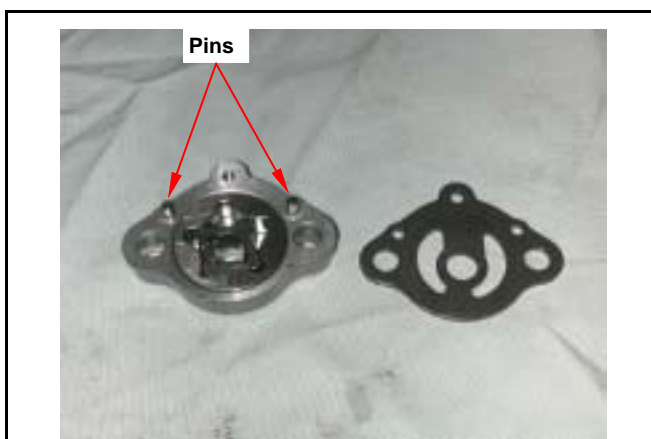

### 3. LUBRICATION SYSTEM

Tighten the oil pump screw.

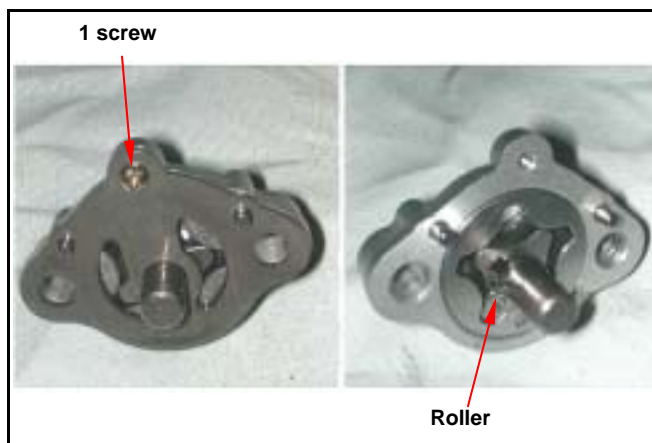

#### Oil Pump Installation

Install the oil pump, and then tighten screws.

**Torque value : 0.1~0.3kgf-m**

Make sure that oil pump shaft can be rotated freely.

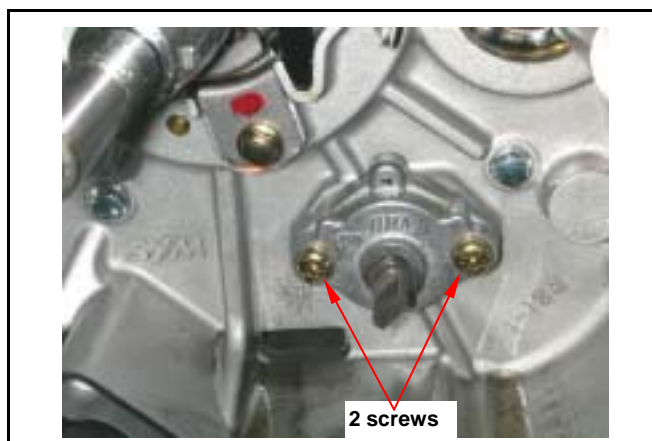

Install oil pump drive chain and sprocket, and then install cir clip onto oil pump shaft.

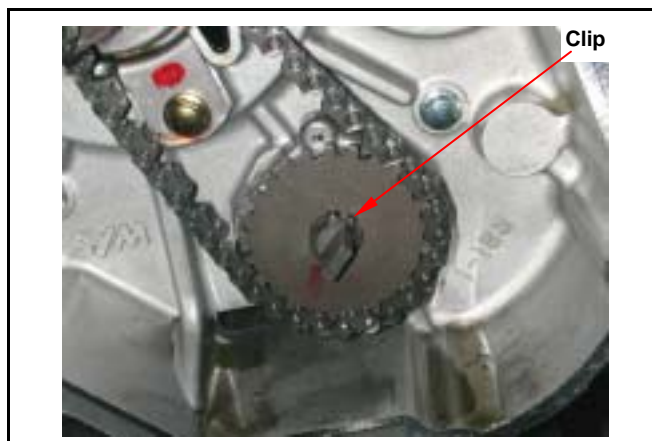

Install starting gear and generator.  
(Refer to chapter 10)



## Gear Oil

### Gear Oil Change

Remove oil join bolt.

Remove drain bolt and drain gear oil out.

Install the drain bolt after drained.

**Torque value: 1.1~1.5kgf-m**

Make sure that the drain bolt washer can be re-used.

Add oil to specified quantity from the join hole.

**Gear Oil Quantity: 650c.c. when replacing**

Make sure that the join bolt washer can be re-used, and install the bolt.

**Torque value: 3.5~4.5kgf-m**

Start engine and run engine for 2-3 minutes.

Turn off engine and make sure that oil level is in correct level.

Make sure that no oil leaking.

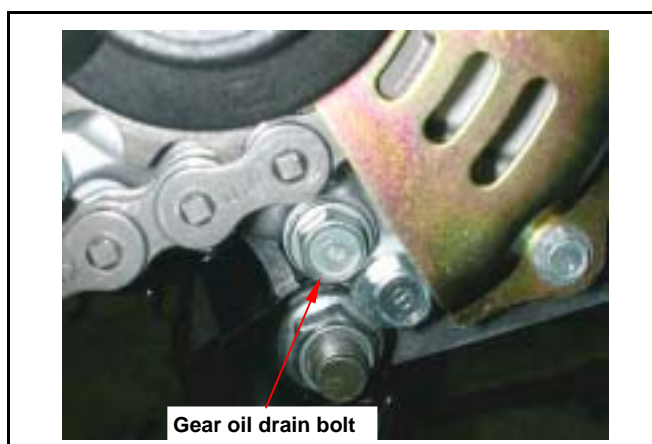
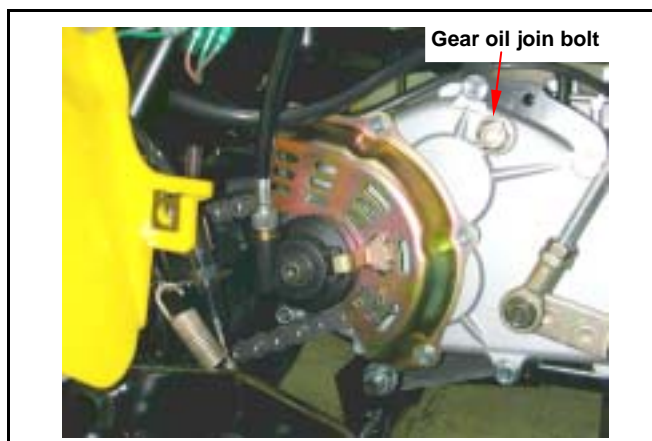

### 3. LUBRICATION SYSTEM

---



Notes:

Mechanism Diagram ..... 4-1	Throttle Valve ..... 4-6
Precautions in Operation..... 4-2	Float Chamber ..... 4-7
Trouble Diagnosis..... 4-3	Adjustment of Idle Speed ..... 4-9
Carburetor Remove / Install ..... 4-4	Fuel Tank ..... 4-10
Air Cut-Off Valve ..... 4-5	Air Cleaner ..... 4-11

## Mechanism Diagram

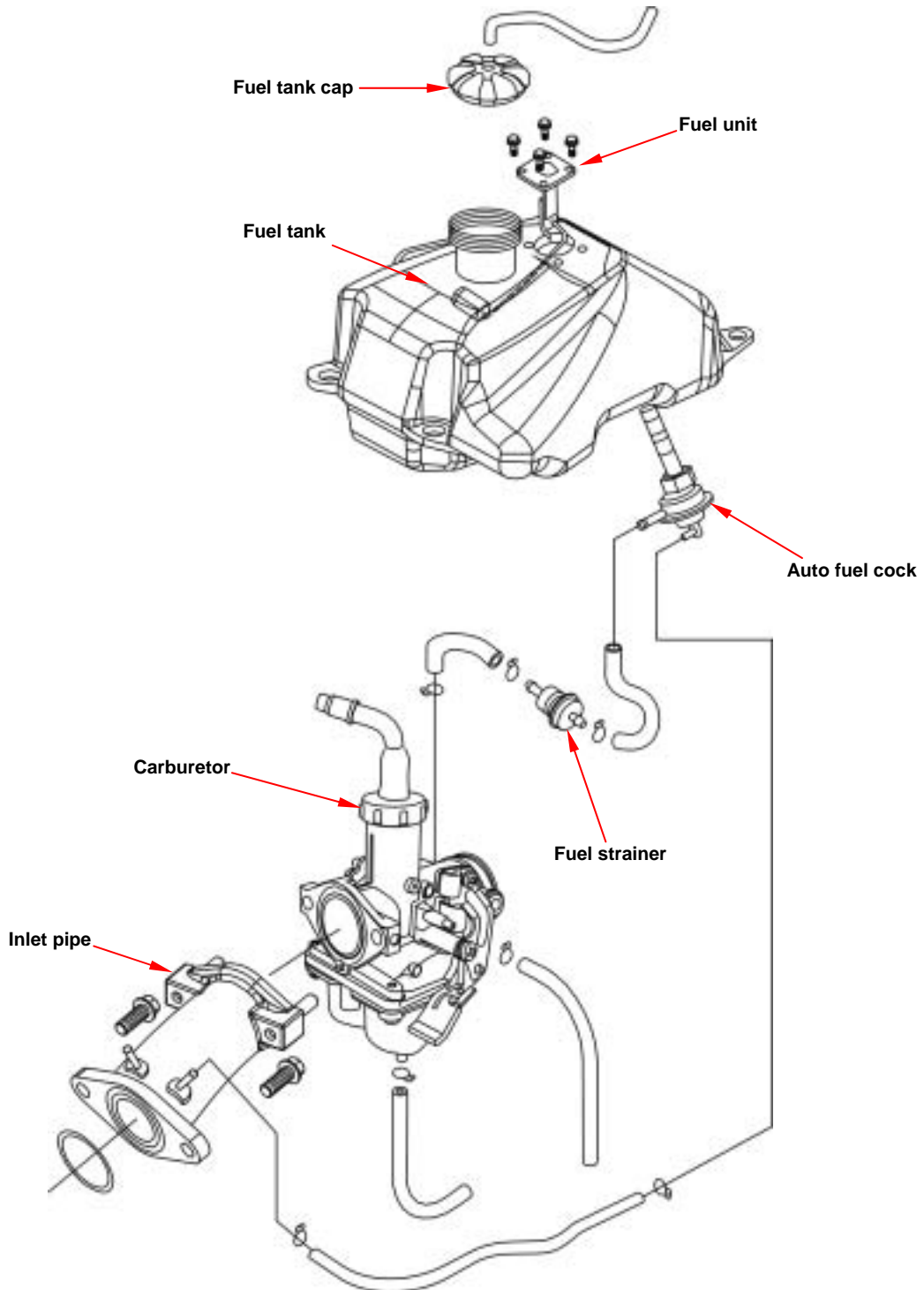

## 4. FUEL SYSTEM

### Precautions in Operation

#### General Information

#### Warning

Gasoline is a low ignition point and explosive materials, so always work in a well-ventilated place and strictly prohibit flame when working with gasoline.

#### Cautions

- Do not bend off throttle cable. Damaged throttle cable will make unstable drive-ability.
- When disassembling fuel system parts, pay attention to O-ring position, replace with new one as re-assembly
- There is a drain screw in the float chamber for draining residual gasoline.
- Do not disassemble air cut valve arbitrarily.

#### Specification

ITEM	UA25A
Carburetor diameter	Ø22mm
I.D. number	PTG 050
Fuel level	14.8mm
Main injector	# 110
Idle injector	# 35
Idle speed	1700 ± 100rpm
Throttle handle clearance	1~3 mm
Pilot screw	2 turns

#### Tool

##### Special service tools

Vacuum/air pressure pump

Fuel level gauge

## Trouble Diagnosis

### Poor engine start

- No fuel in fuel tank
- Clogged fuel tube
- Too much fuel in cylinder
- No spark from spark plug(malfunction of ignition system )
- Clogged air cleaner
- Malfunction of carburetor chock
- Malfunction of throttle operation

### Stall after started

- Malfunction of carburetor chock
- Incorrect ignition timing
- Malfunction of carburetor
- Dirty engine oil
- Air existing in intake system
- Incorrect idle speed

### Rough idle

- Malfunction of ignition system
- Incorrect idle speed
- Malfunction of carburetor
- Dirty fuel

### Intermittently misfire as acceleration

- Malfunction of ignition system

### Late ignition timing

- Malfunction of ignition system
- Malfunction of carburetor

### Power insufficiency and fuel consuming

- Fuel system clogged
- Malfunction of ignition system

### Mixture too lean

- Clogged fuel injector
- Vacuum piston stick and closed
- Malfunction of float valve
- Fuel level too low in float chamber
- Clogged fuel tank cap vent
- Clogged fuel filter
- Obstructed fuel pipe
- Clogged air vent hose
- Air existing in intake system

### Mixture too rich

- Clogged air injector
- Malfunction of float valve
- Fuel level too high in float chamber
- Malfunction of carburetor chock
- Dirty air cleaner



## 4. FUEL SYSTEM

### Carburetor Remove / Install

#### Removal

Drain out fuel in the float chamber.

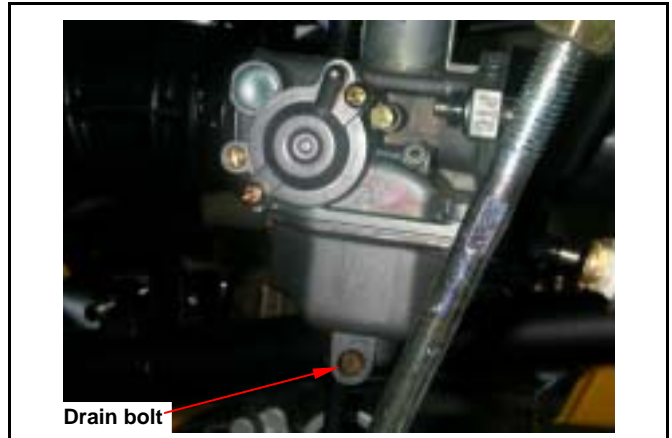

Loosen the choke cable fixed iron sheet screw from plate.  
Remove the choke cable.

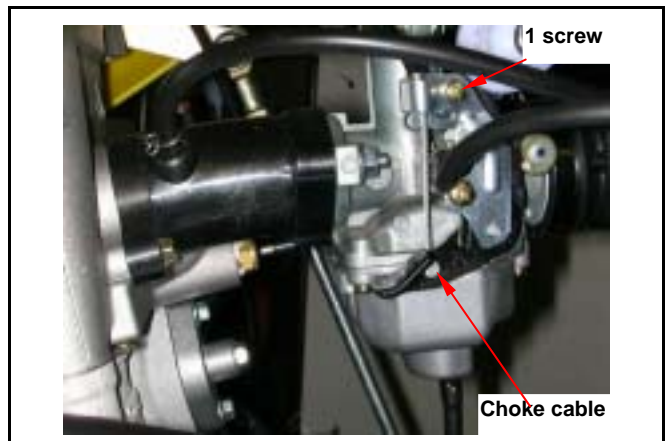

Disconnect the fuel hose.  
Release the clamp strip of air cleaner.

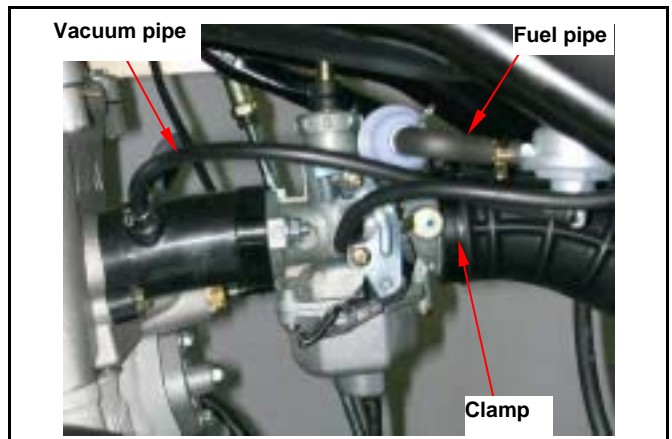

Remove the carburetor upper parts from the carburetor.  
Release the 2 nuts of carburetor insulator, and then remove the carburetor.

#### Installation

Install in reverse order of removal procedures.

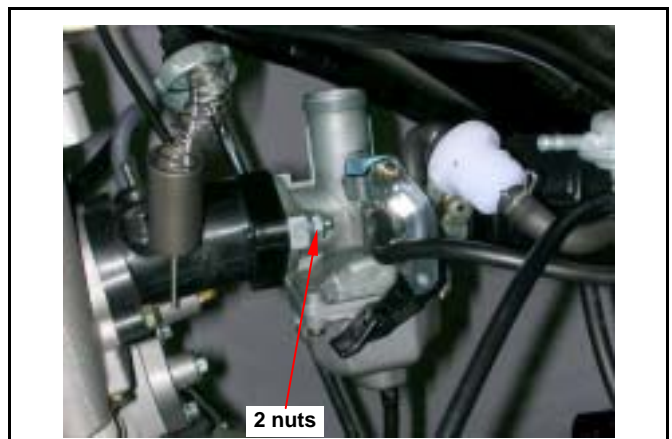

## Air Cut-Off Valve

### Disassembly

Remove 2 screws.

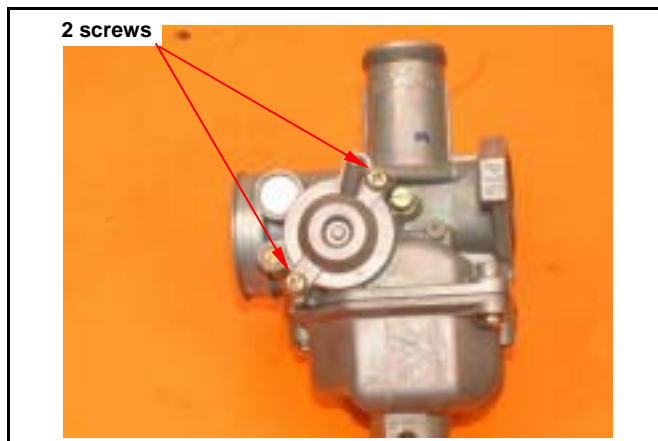

Remove air cut-off valve cover, spring and valve.

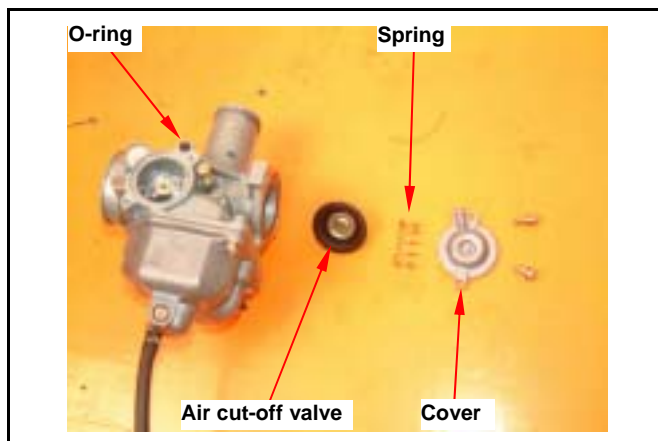

### Inspection

Check the valve is in normal.

If the valve is in normal, it will restrict air-flow.

If air-flow is no restricting, replace carburetor assembly.

Check the vacuum pipe o-ring is in normal.

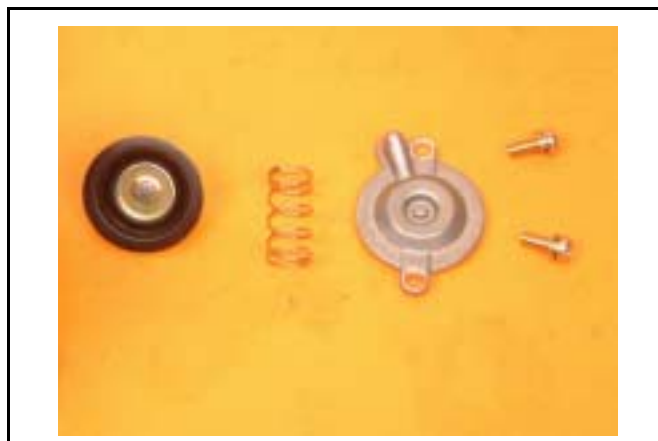

### Assembly

Install in reverse order of removal procedures.

## 4. FUEL SYSTEM

### Throttle Valve

#### Disassembly

Remove carburetor upper parts, and then remove throttle valve and throttle cable.



Disconnect the throttle cable from the throttle valve and remove the valve spring. Remove the fuel needle clamp and fuel needle.

#### Assembly

Place the fuel needle onto the throttle valve and clip it with needle clamp. Install the sealed cap, carburetor upper part, and throttle valve spring. Connect the throttle valve cable to the throttle valve. Install the throttle valve into the carburetor body.

#### Caution

Align the groove inside the throttle valve with the throttle stopper screw of the carburetor body.

Tighten the carburetor upper part.  
Adjust the free play of throttle valve cable.

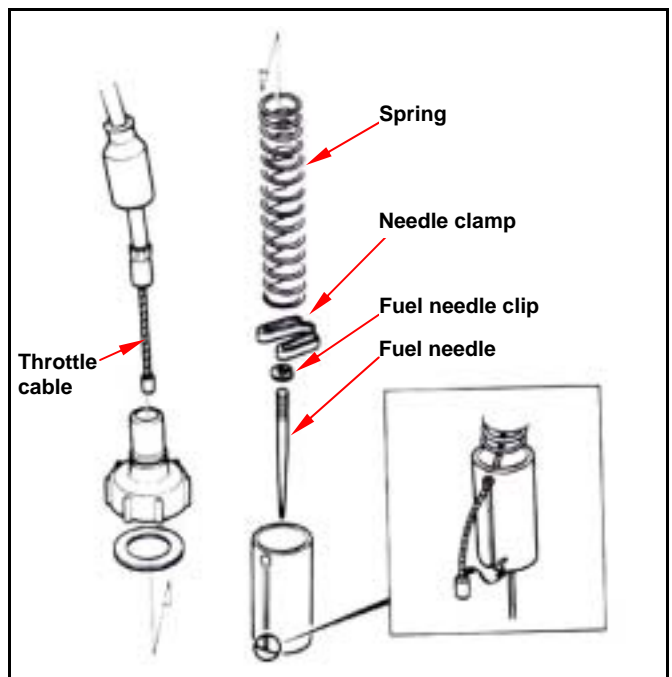

## Float Chamber

### Disassembly

Remove 3 mounting screws and remove float chamber cover.

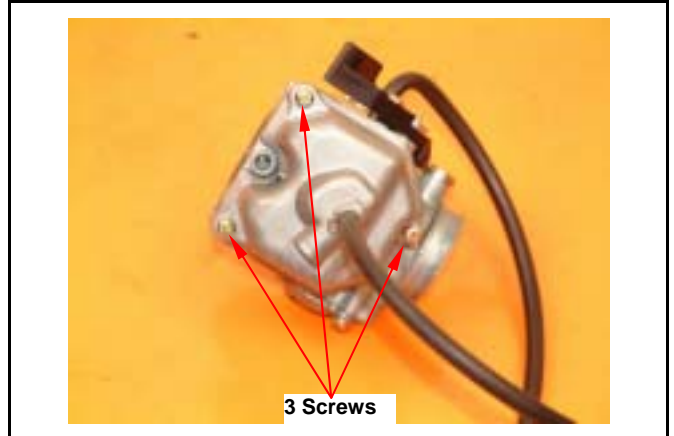

Remove the fuel level plate, float pin, float and float valve.

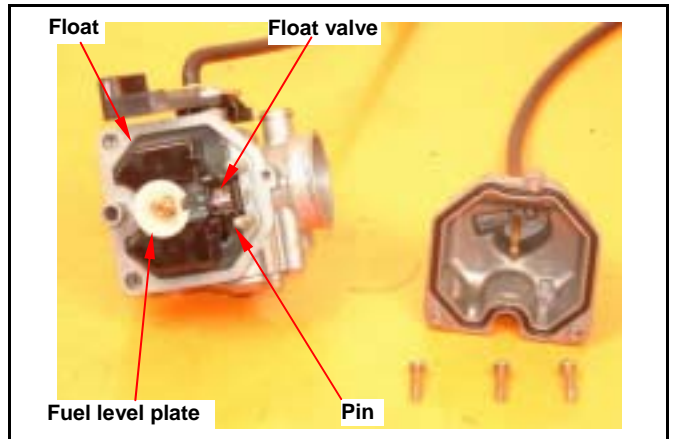

### Inspection

Check float valve and valve seat for damage, blocking.  
Check float valve for wearing, and check valve seat face for wear, dirt.

### Caution

In case of worn out or dirt, the float valve and valve seat will not tightly close causing fuel level to increase and as a result, fuel flooding. A worn out or dirty float valve must be replaced with a new a new one.

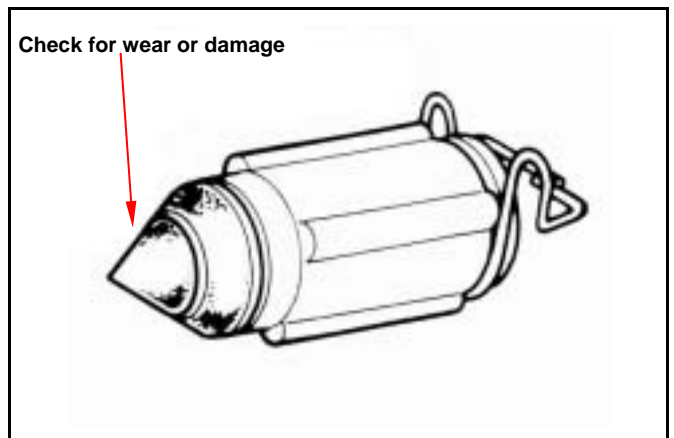
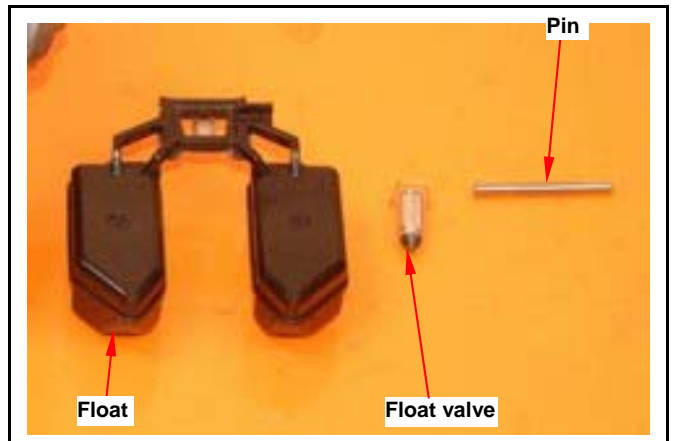

## 4. FUEL SYSTEM

Remove main jet, needle jet holder, needle jet, slow jet and air adjustment screw.

### Caution

- Take care not to damage jets and adjust screw.
- Before removing adjustment screw, turn it all the way down and note the number of turns.
  - Does not turn adjust screw forcefully to avoid damaging valve seat face.

Clean jets with cleaning fluid. Then use compressed air to blow the dirt off. Blow carburetor body passages with compressed air.

### Assembly

Install main jet, needle jet holder, needle jet, slow jet and air adjustment screw.

### Caution

Set the air adjustment screw in according to number of turns noted before it was removed.

Install the float valve, float, and float pin.

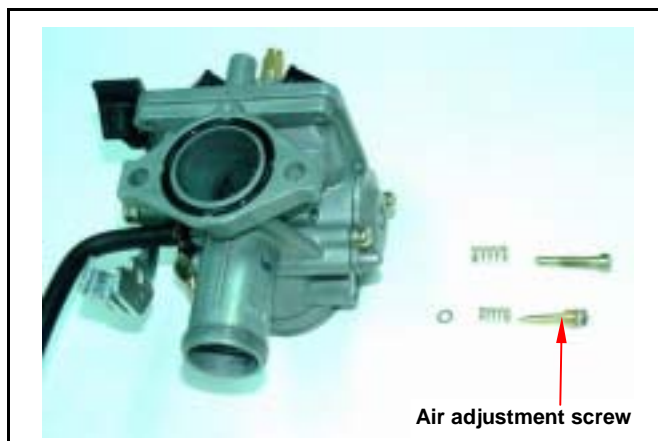
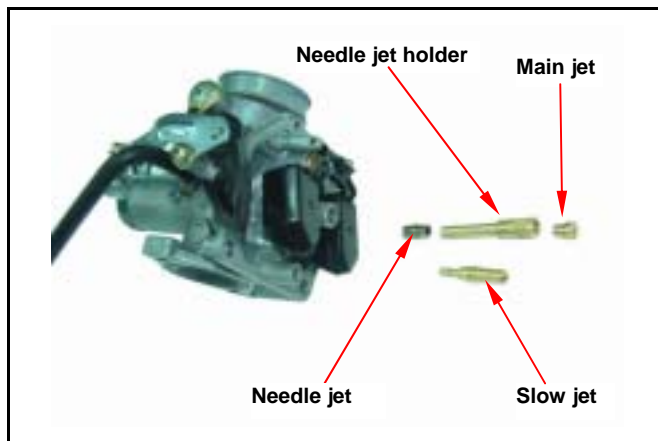

### Checking fuel level

### Caution

- Check again to ensure float valve, float for proper installation.
- To ensure correct measurement, position the float meter in such a way so that float chamber face is vertical to the main jet.

**Fuel level: 14.8mm**

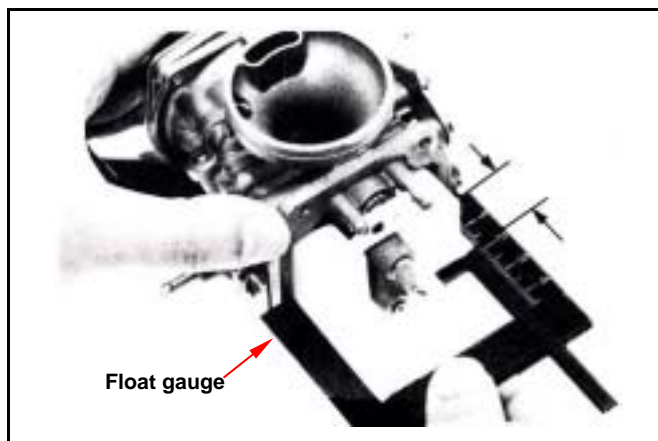

### Installation of carburetor

Install carburetor in the reverse order of removal. Following adjustments must be made after installation.

- Throttle cable adjustment.
- Idle adjustment

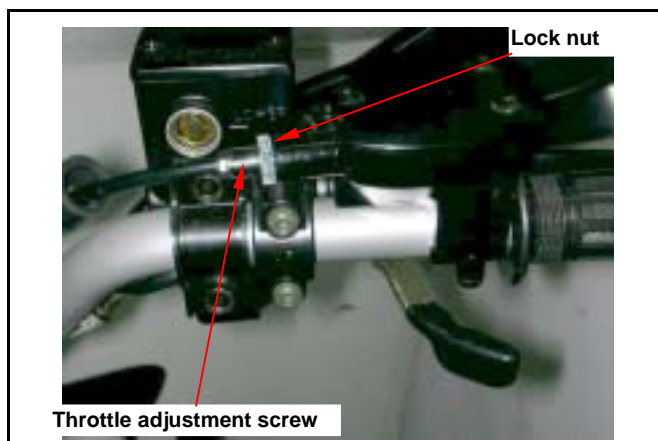

## Adjustment of Idle Speed

### Caution

- Air screw was set at factory, so no adjustment is needed. Note the number of turns it takes to screw it all the way in for ease of installation.
- The parking brake must be used to stop the ATV to perform the adjustments.

Use a tachometer when adjusting engine RPM. Screw in air adjustment screw gently, then back up to standard turns.

#### **Standard turns: 2 turns**

Warm up engine; adjust the throttle stopper screw of throttle valve to standard RPM.

#### **Idle speed rpm: 1700 ± 100 rpm**

Connect the hose of exhaust analyzer to exhaust front end. Press test key on the analyzer.

Adjust the pilot screw and read CO reading on the analyzer

#### **CO standard value: 1.0~1.5 %**

Accelerate in gradual increments; make sure rpm and CO value are in standard value after engine running in stable. If rpm and CO value fluctuated, repeat the procedures described above for adjusting to standard value.

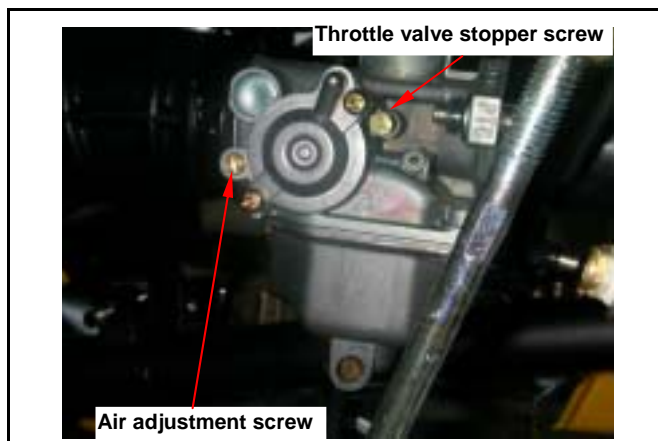

## 4. FUEL SYSTEM

### Fuel Tank

#### Fuel unit removal

- Open the seat.
- Remove the front cover and fuel tank.
- Remove the side covers and lower side covers.
- Remove the front fender.
- (Covers remove please refer chapter 13)
- Disconnect fuel unit coupler.
- Remove fuel unit (4 bolts).

#### Caution

- Do not bend the float arm of fuel unit
- Do not fill out too much fuel to fuel tank.

Fuel unit inspection (Refer to electrical equipment chapter 17).

#### Fuel unit installation

Install the gauge in the reverse order of removal.

#### Caution

- Do not forget to install the gasket of fuel unit or damage it.

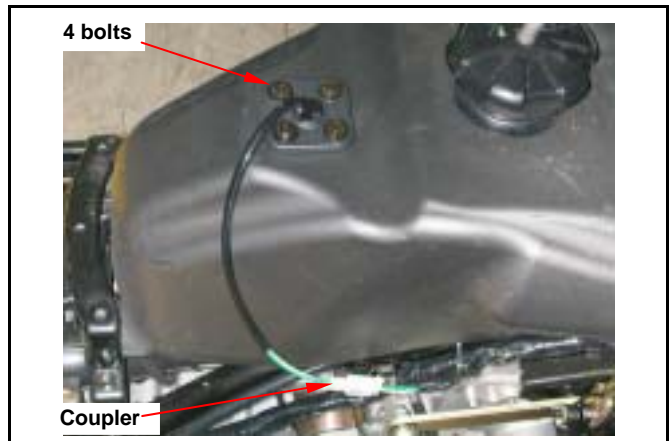

#### Fuel tank removal

- Open the seat.
- Remove the front cover and fuel tank.
- Remove the side covers and lower side covers.
- Remove the front fender.
- (Covers remove please refer chapter 13)
- Disconnect fuel unit coupler.
- Remove fuel unit (4 bolts).
- Remove the fuel tube.
- Remove the vacuum tube.

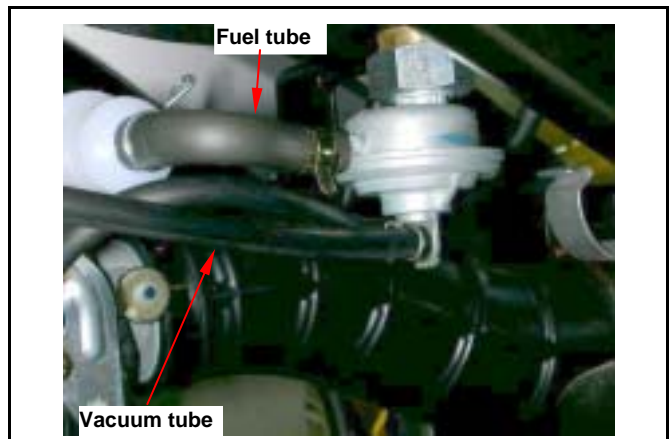

Remove fuel tank front and rear side 4 bolts, and then remove fuel tank.

#### Installation

Install the tank in the reverse order of removal.

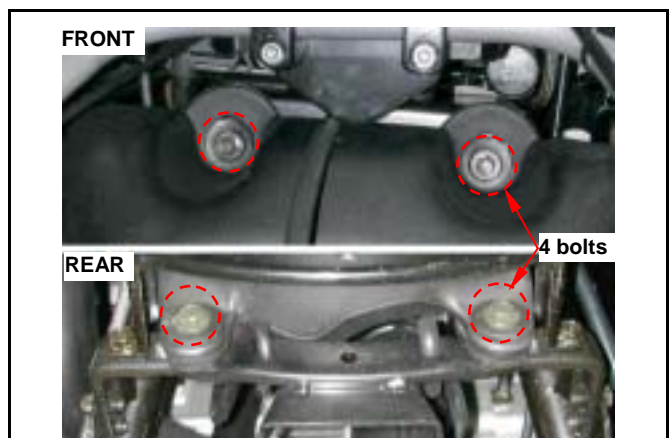

## Air Cleaner

### Removal

Loosen the clamp strip of air cleaner and carburetor, and then remove the vapor hose.



Loosen the clamp strip of air cleaner, and then remove the air cleaner vapor hose. Remove the air cleaner (4 bolts).

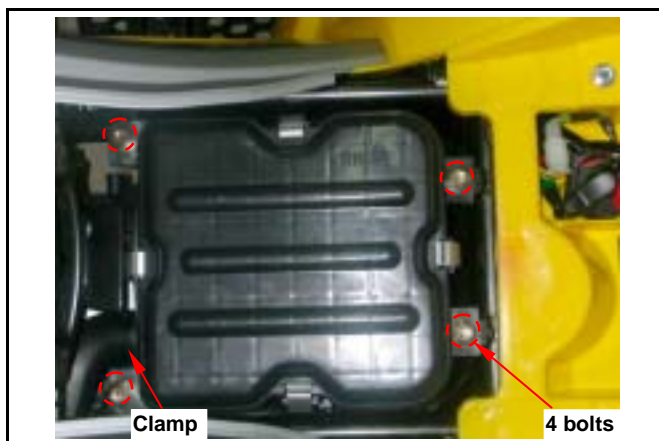

### Installation

Install the tank in the reverse order of removal.

### Cleaning air cleaner element

Remove the air cleaner cover (4 catch hooks).

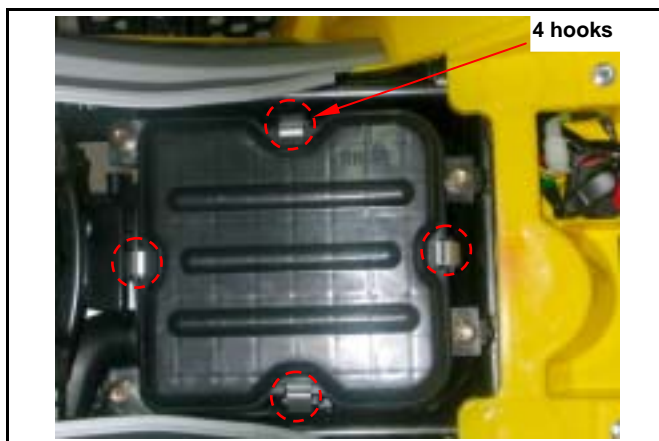

Remove element mounting screw. Loosen the clamp strip of air cleaner element, and then remove the air cleaner element. Clean the element with non-flammable or high-flash point solvent and then squeeze it for dry.

### Caution

Never use gasoline or acid organized solvent to clean the element.

Soap the element into cleaning engine oil and then squeeze it out. Install the element onto the element seat and then install the air cleaner cover.

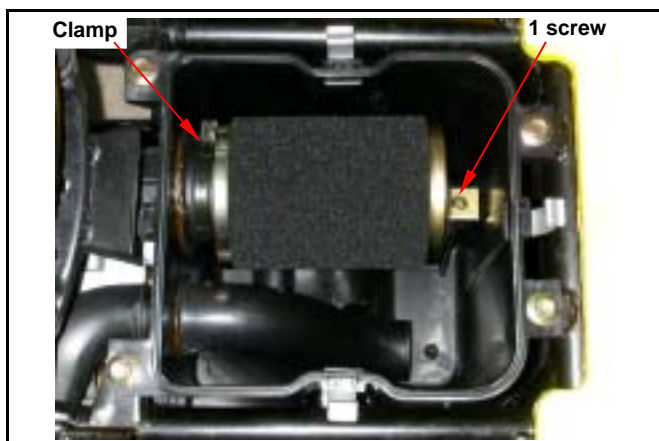



## 4. FUEL SYSTEM

---



Notes:

<a href="#">Precautions in Operation .....</a>	<a href="#">5-1</a>
<a href="#">Removal of Engine .....</a>	<a href="#">5-2</a>

<a href="#">Engine Installation .....</a>	<a href="#">5-6</a>
---	---------------------

## Precautions in Operation

### General Information

- The engine has to be supported with special service tools that can be lifted or adjustable.
- Engine shall be removal in the conditions of necessary repair or adjustment to the only.
- The following parts can be serviced as engine mounted on frame:
  - Carburetor.
  - Drive pulley, drive belt, clutch, and movable drive face assembly.
  - Start motor.
  - AC. Generator, oil pump and start one way clutch.
  - Transmission.

### Specification

Item		Capacity
Engine oil capacity	Replacement	1200 c.c.
	Disassembly	1400 c.c.
Gear oil capacity	Replacement	650 c.c.
	Disassembly	750 c.c.
Coolant capacity	Engine & radiator	780 c.c.
	Reservoir	420 c.c. AS indicator shown
	Total	1200 c.c.

### Torque Value

Engine hanger bolt	7.5~9.5kgf-m
Exhaust muffler mounting bolt	2.8~3.2kgf-m
Exhaust muffler connection nut	1.0~1.4kgf-m

## 5. ENGINE REMOVAL

### Removal of Engine

- Remove the seat.
- Remove battery negative (-).
- Remove battery positive (+) post.
- Remove front fender and the footrest (refer chapter 13).

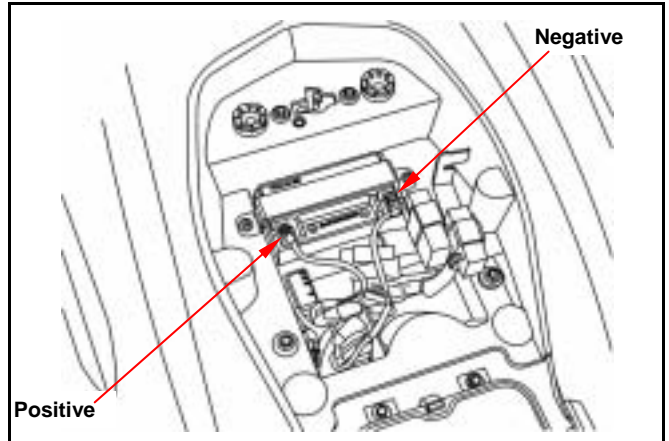

- Remove starter motor wire.

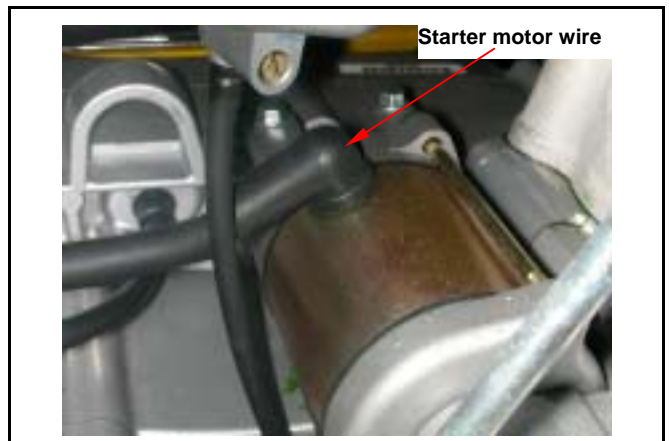

- Remove the spark plug cap.



- Disconnect A.C. Generator wire couplers.

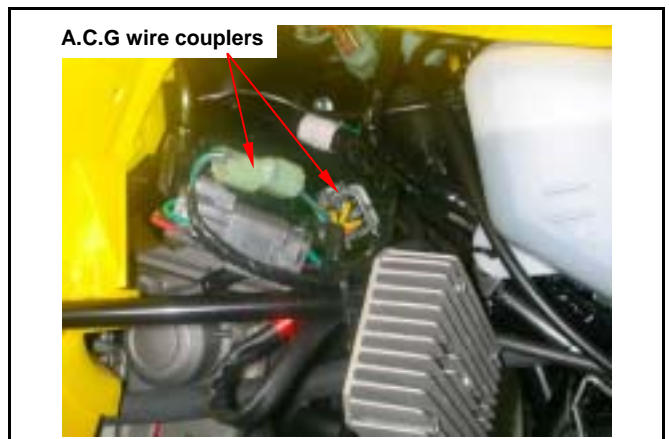

Remove muffler protect (2 bolts).

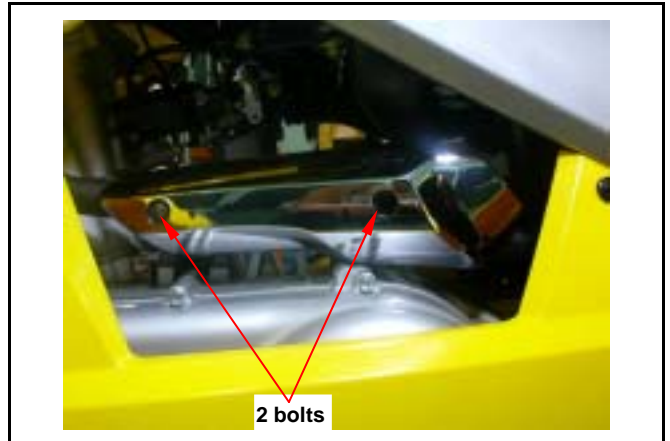

Loosen muffler front side bolt.

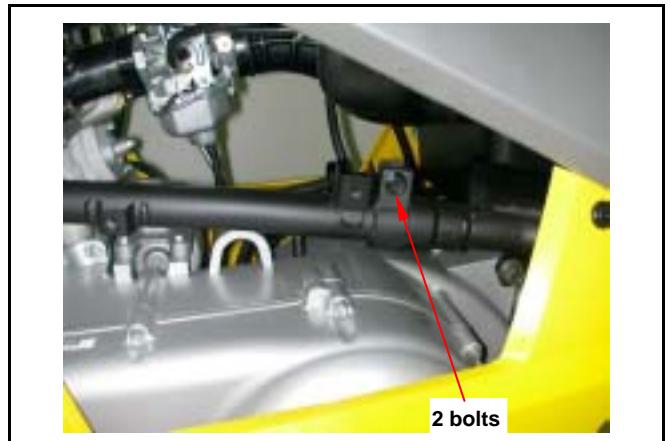

Remove 2 bolts, and then remove the exhaust muffler.

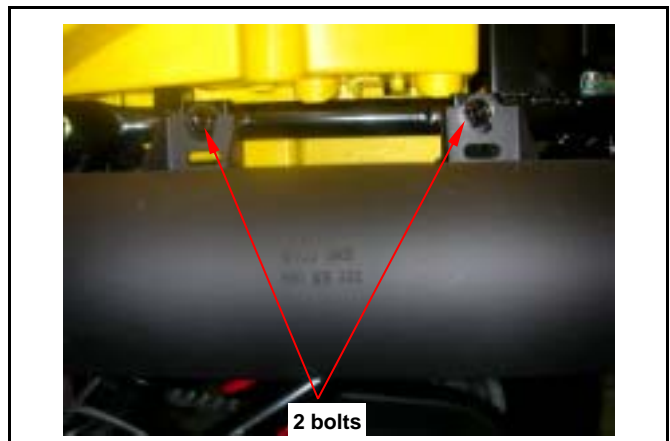

Remove 2 nuts, and then remove exhaust pipe.



## 5. ENGINE REMOVAL

Loosen 1 screw and disconnect the choke cable.

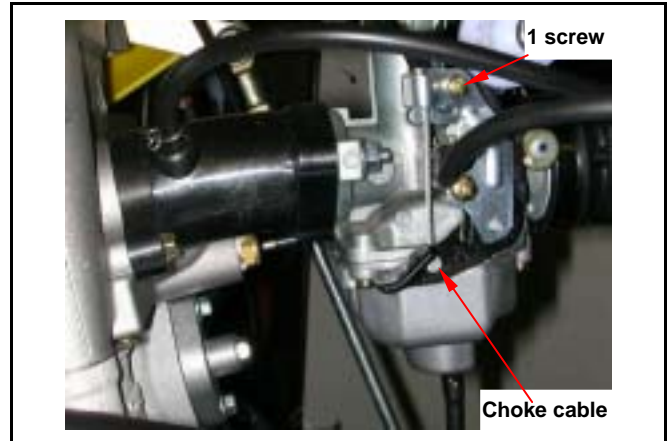

Remove fuel pipe and vacuum pipe.  
Release the clamp strip of air cleaner duct.

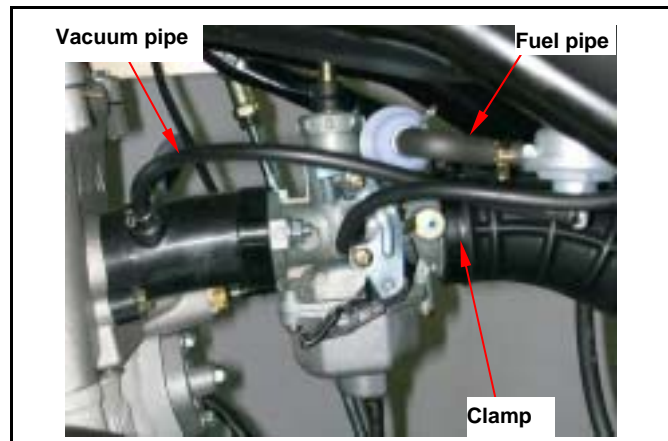

Disconnect the carburetor upper parts and cable.  
Release the 2 nuts of carburetor insulator, and  
then remove the carburetor.

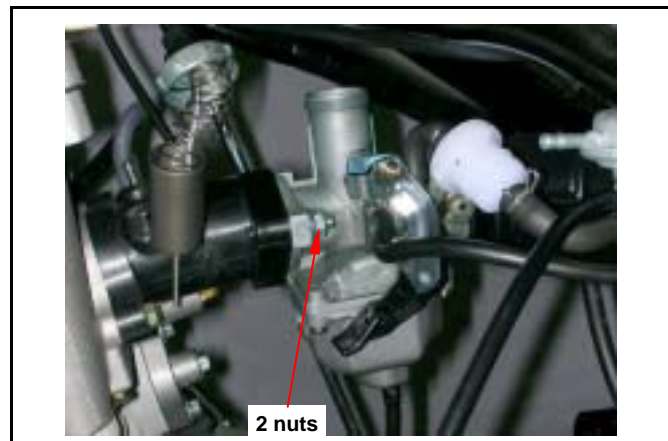

Release the clamp strips of left crankcase cover  
ducts, and then remove the ducts.

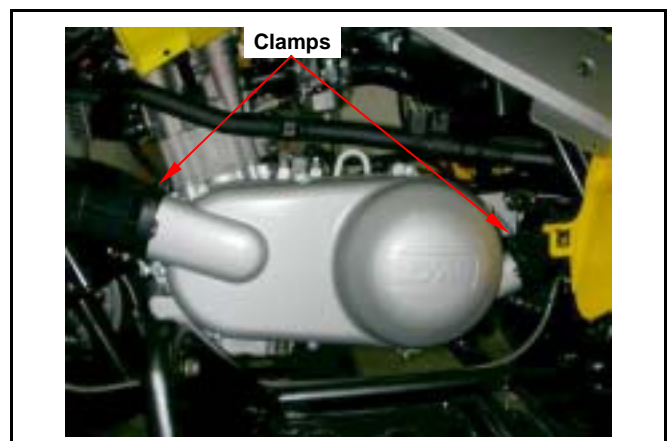

Remove coolant drain bolt, and drain out coolant.  
Remove coolant inlet hoses from water pump.

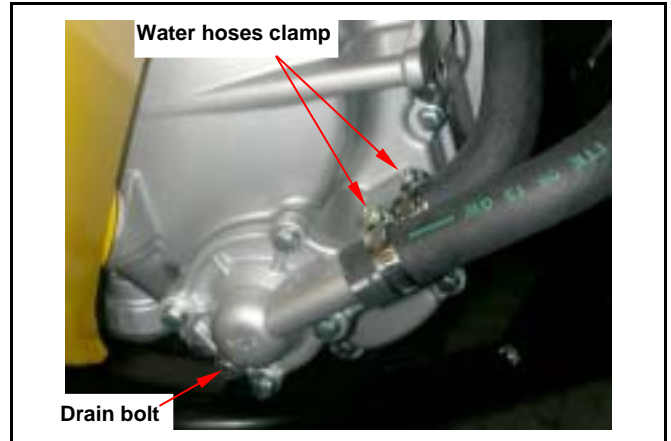

Remove the thermo-sensor wire, by-pass pipe and coolant outlet hose.

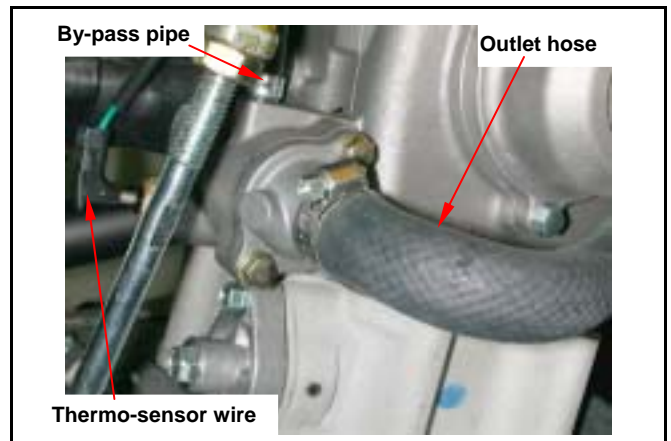

Remove gear change lever (1 bolt).



Remove change switch couplers.

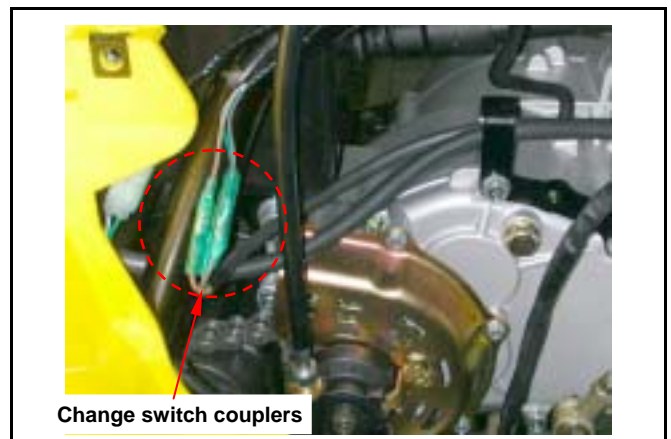

## 5. ENGINE REMOVAL

Loosen speedometer cable mounting nut, and then remove the cable.

Remove 3 bolts and remove drive chain protector. Turn the socket bolt clockwise, and then remove speedometer gear box.

### Caution

The socket bolt is provided with left turn thread.

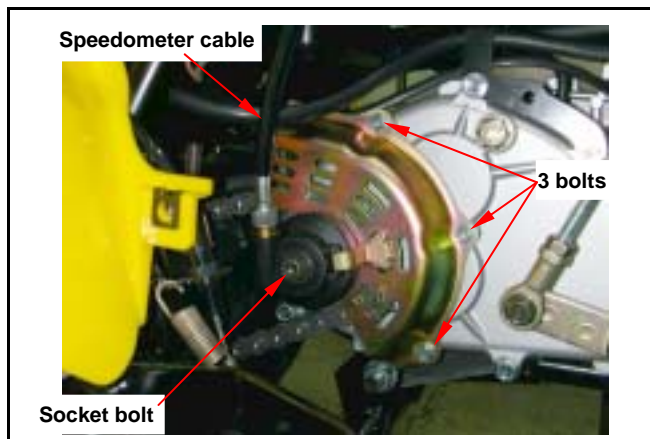

Remove 2 bolts, and then remove the drive sprocket fixing plate, drive chain and drive sprocket.

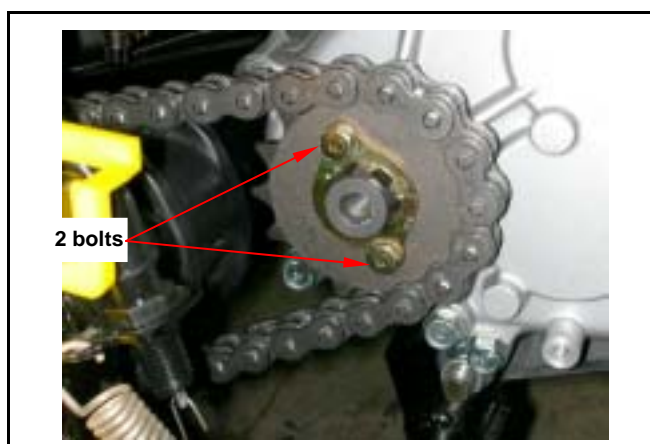

Remove the rear side engine hanger mounting nuts and bolts.

Remove the front side engine hanger mounting nut and bolt

Remove left side engine hanger, and then remove engine by left side.

### Engine Installation

Check if the bush of engine hanger parts for damage.

Install engine in the reverse procedures of removal.

### Caution

- Pay attention of foot & hand safety as engine installation to avoid hurting.
- Do not bend or twist wires.
- Cables wires have to be routed in accordance with normal layout.

**Engine hanger Bolt:**

**Torque value: 7.5~9.5kgf-m**

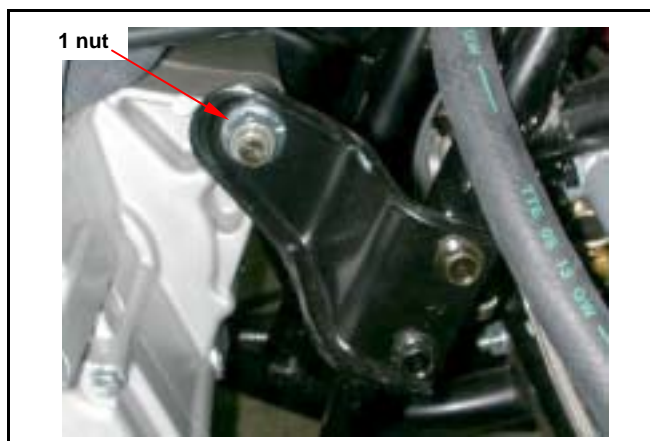
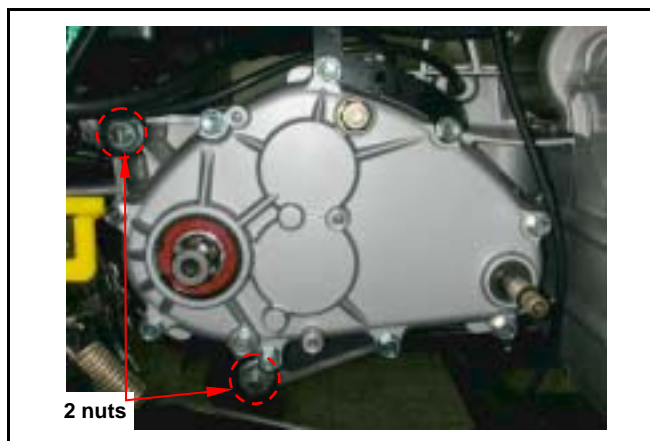

Mechanism Diagram .....	6-1	Valve Stem Replacement.....	6-10
Precautions in Operation .....	6-2	Valve Seat Inspection and Service...	6-11
Troubleshooting.....	6-3	Cylinder Head Reassembly .....	6-13
Cylinder Head Removal.....	6-4	Cylinder Head Installation .....	6-14
Cylinder Head Inspection .....	6-7	Valve Clearance Adjustment.....	6-16

## Mechanism Diagram

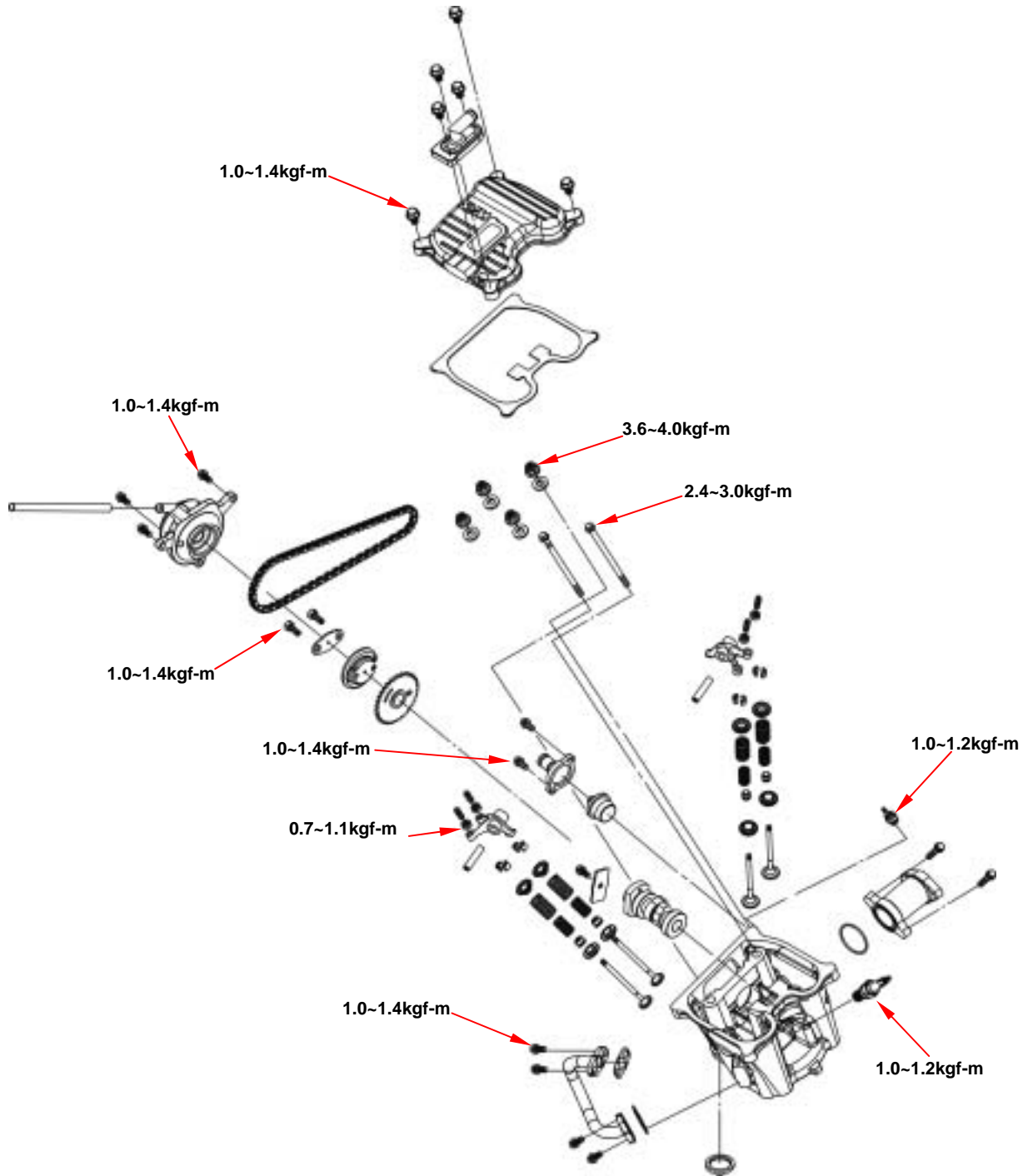



## 6. CYLINDER HEAD/VALVE

### Precautions in Operation

#### General Information

- This chapter is contained maintenance and service for cylinder head, valve, and camshaft as well as rocker arm.
- Cylinder head service can be carried out when engine is in frame.

#### Specification

Item		Standard	Limit
Compression pressure		12±2 kg/cm <sup>2</sup>	---
Camshaft	Height of cam lobe	Intake	34.880
		Exhaust	34.740
Rocker arm	ID of valve rocker arm		11.982~12.000
	OD of valve rocker arm shaft		11.966~11.984
Valve	OD of valve stem	Intake	4.975~4.990
		Exhaust	4.950~4.975
	ID of valve guide		5.000~5.012
	Clearance between valve stem and guide	Intake	0.010~0.037
		Exhaust	0.025~0.062
	Free length of valve spring	Inner	38.700
		outer	40.400
	Valve seat width		1.600
	Valve clearance	Intake	0.10±0.02mm
		Exhaust	0.15±0.02mm
Tilt angle of cylinder head		---	0.050

#### Torque Value

Cylinder head cover bolt	1.0~1.4kgf-m
Exhaust pipe stud bolt	2.4~3.0kgf-m
Cylinder head bolt	1.0~1.4kgf-m
Cylinder head Nut	3.6~4.0kgf-m
Sealing bolt of cam chain auto-tensioner	0.8~1.2kgf-m
Bolt of cam chain auto-tensioner	1.2~1.6kgf-m
Cylinder side cover bolt	1.0~1.4kgf-m
Cam sprocket bolt	1.0~1.4kgf-m
Tappet adjustment screw nut	0.7~1.1kgf-m
Spark plug	1.0~1.2kgf-m

#### Tools

##### Special service tools

- Valve reamer: 5.0mm
- Valve guide driver: 5.0mm
- Valve spring compressor

## Troubleshooting

Engine performance will be affected by troubles on engine top parts. The trouble usually can be determined or by performing cylinder compression test and judging the abnormal noise generated.

### Low compression pressure

#### 1. Valve

- Improper valve adjustment
- Burnt or bent valve
- Improper valve timing
- Valve spring damage
- Valve carbon deposit.

#### 2. Cylinder head

- Cylinder head gasket leaking or damage
- Tilt or crack cylinder

#### 3. Piston

- Piston ring worn out.

### High compression pressure

- Too much carbon deposit on combustion chamber or piston head

### Noise

- Improper valve clearance adjustment
- Burnt valve or damaged valve spring
- Camshaft wear out or damage
- Chain wear out or looseness
- Auto-tensioner wear out or damage
- Camshaft sprocket
- Rocker arm or rocker arm shaft wear out

## 6. CYLINDER HEAD/VALVE

### Cylinder Head Removal

Remove engine. (Refer to chapter 5)  
Remove the inlet pipe (2 nuts).

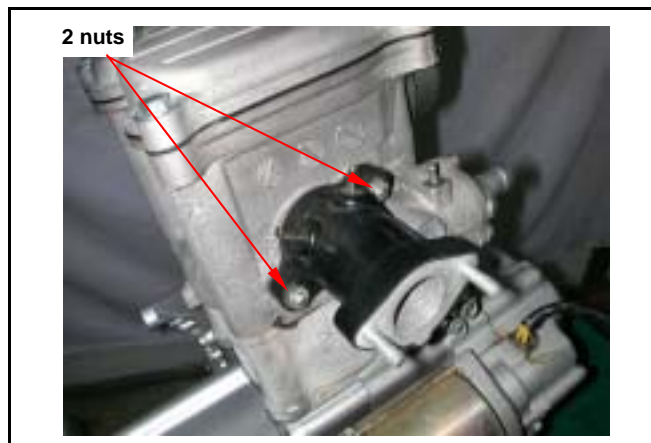

Remove 1 bolt of thermostat and then remove the thermostat.  
Remove hole bolt and spring for the cam chain tensioner.  
Loosen 2 bolts, and then remove tensioner.  
Remove thermostat (2 bolts).

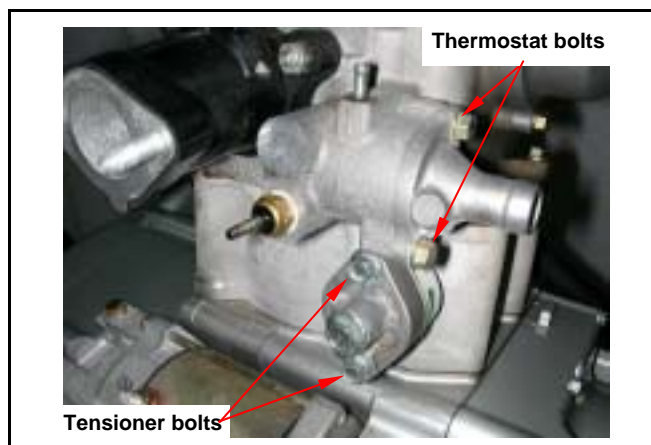

Remove Air Injection system (AI) pipe mounting bolts.  
Remove spark plug.

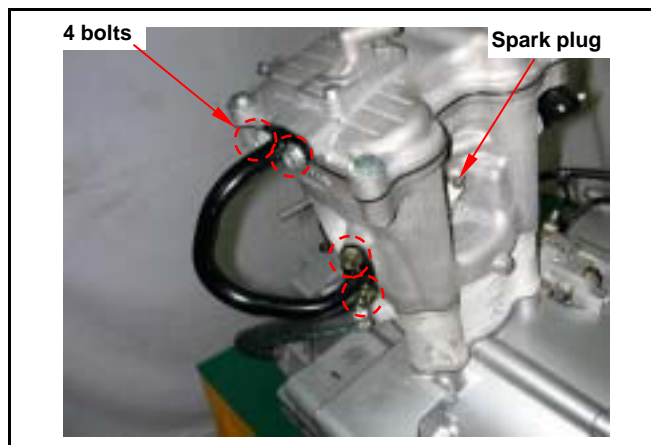

Remove the side cover mounting bolts of cylinder head, and then take out the side cover.

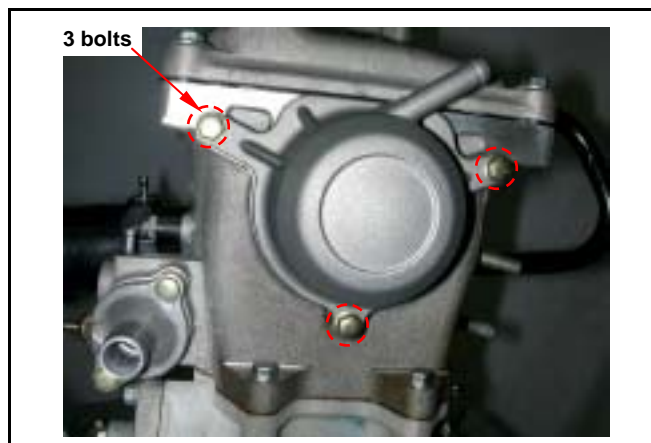

Remove left crankcase cover, and turn the  
Turn the drive face, and align the timing mark on  
the sprocket with that of cylinder head, piston is at  
TDC position.

Remove cam sprocket bolts and then remove the  
sprocket by prying chain out.

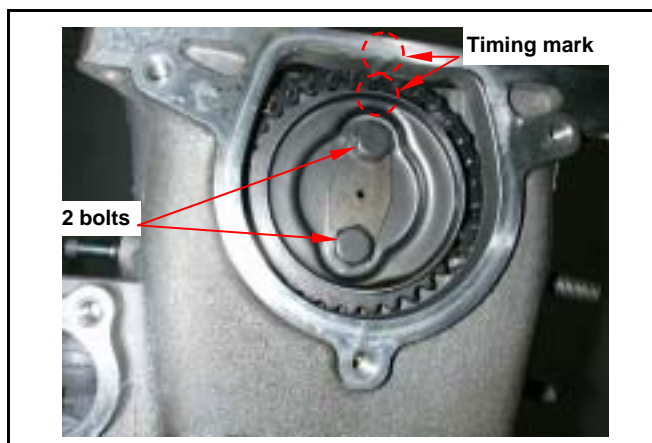

Remove cam shaft setting plate (1 bolt).

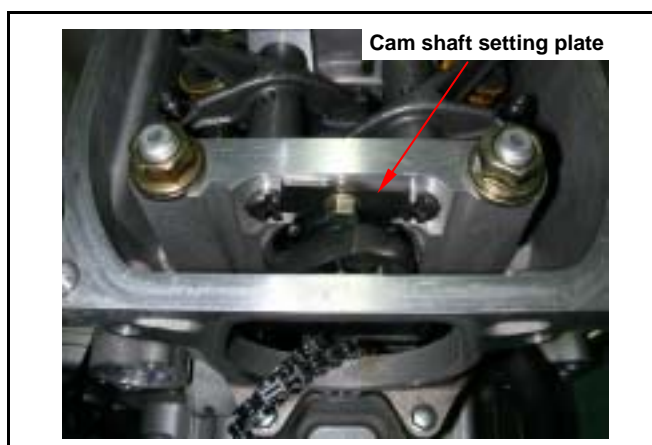

Remove rocker arm shafts and rocker arms.

**Special Service Tool:**

**Rocker arm and cam shaft puller**

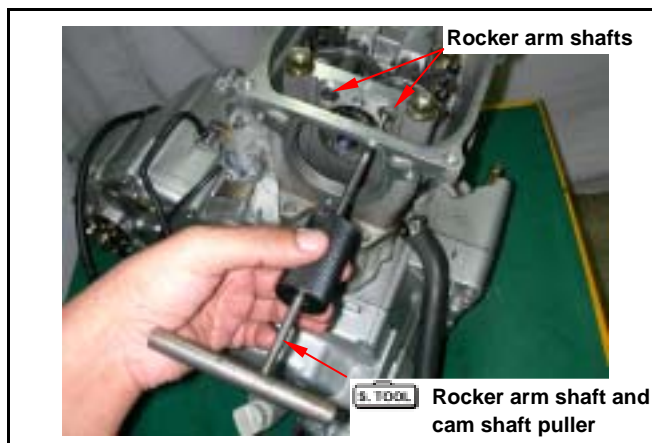

Remove cam shafts.

**Special Service Tool:**

**Rocker arm and cam shaft puller**

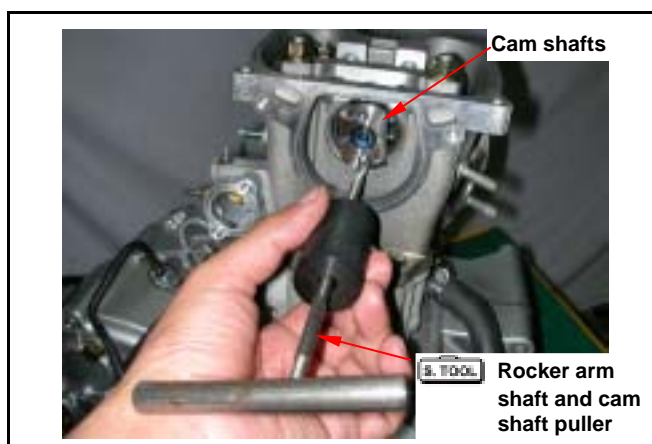

## 6. CYLINDER HEAD/VALVE

Remove the 2 cylinder head mounting bolts from cylinder head right side, and then remove 4 nuts and washers from cylinder head upper side. Remove the cylinder head.

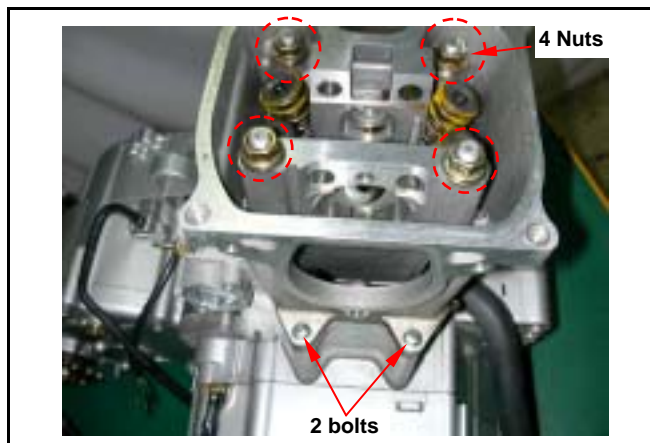

Remove cylinder head gasket and 2 dowel pins. Remove chain guide. Clean up residues from the matching surfaces of cylinder and cylinder head.

**⚠ Caution**

- Do not damage the matching surfaces of cylinder and cylinder head.
- Avoid residues of gasket or foreign materials falling into crankcase as cleaning.

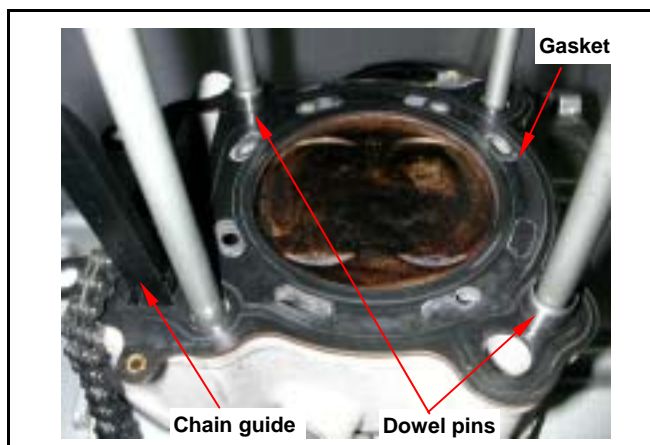

Use a valve cotter remove & assembly tool to press the valve spring, and then remove valves.

**⚠ Caution**

- In order to avoid losing spring elasticity, do not press the spring too much. Thus, press length is based on the valve cotter in which can be removed.

**Special Service Tool:**  
Valve cotter remove & assembly tool

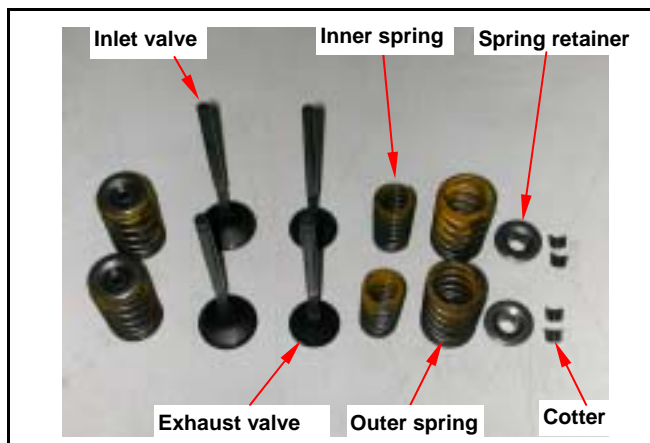
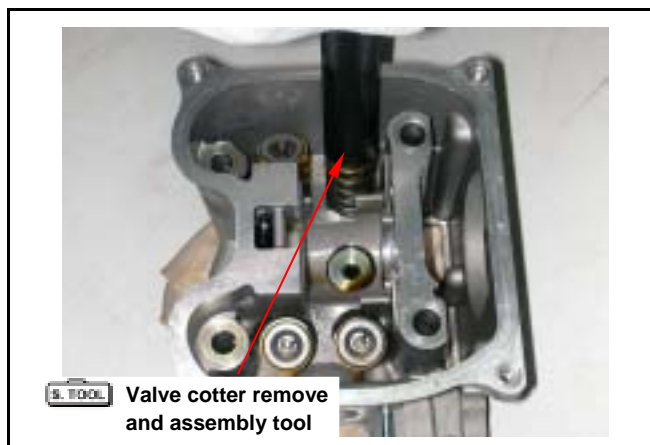

Remove valve stem seals.

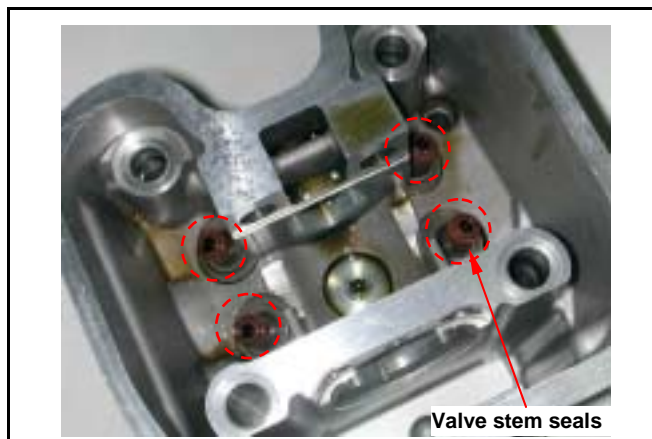

Clean carbon deposits in combustion chamber.  
Clean residues and foreign materials on cylinder head matching surface.

**⚠ Caution**

Do not damage the matching surface of cylinder head.



### Cylinder Head Inspection

Check if spark plug and valve holes are cracked.  
Measure cylinder head warp with a straightedge and thickness gauge.

**Service limit: 0.05 mm**

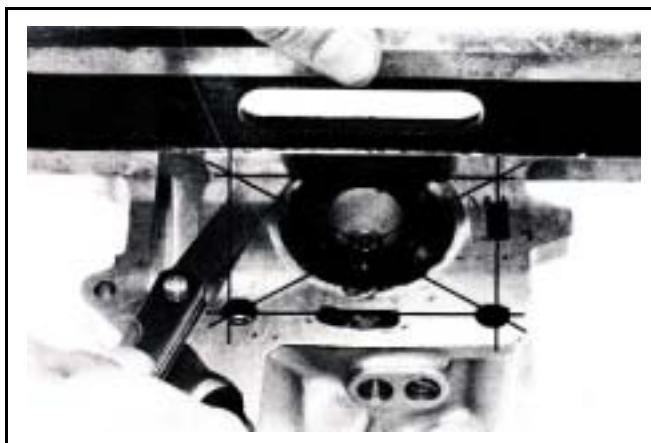

### Camshaft

Inspect cam lobe height for damaged.

**Service Limit:**

**IN: Replacement when less than 34.860mm**

**EX: Replacement when less than 34.725mm**

Inspect the camshaft bearing for looseness or wear out. If any damage, replace whole set of camshaft and bearing.

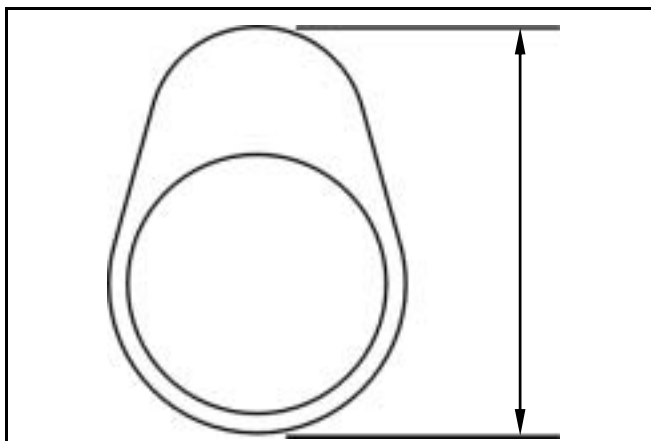

## 6. CYLINDER HEAD/VALVE

### Rocker Arm

Measure the cam rocker arm I.D., and wear or damage, oil hole clogged?

**Service Limit: Replace when it is less than 12.080 mm.**

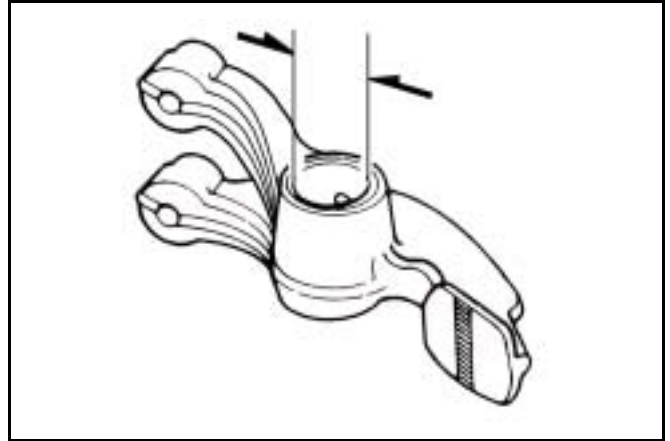

### Rocker Arm Shaft

Measure the active O.D. of the cam rocker arm shaft and cam rocker arm.

**Service Limit: Replace when it is less than 11.936 mm.**

Calculate the clearance between the rocker arm shaft and the rocker arm.

**Service Limit: Replace when it is less than 0.10 mm.**

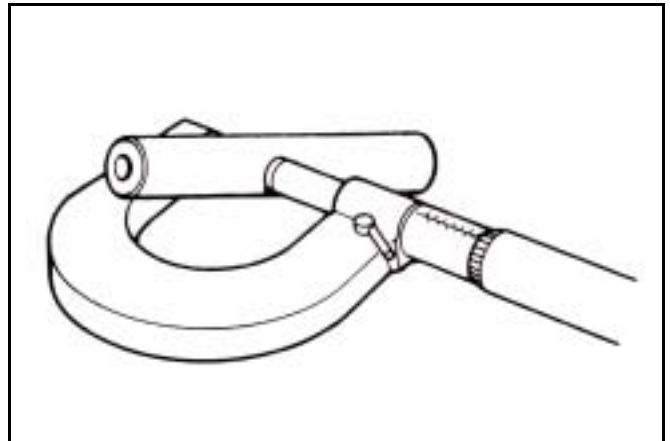

### Valve spring free length

Measure the free length of intake and exhaust valve springs.

**Service limit:**

**Inner spring 35.20 mm**

**Outer spring 36.90 mm**

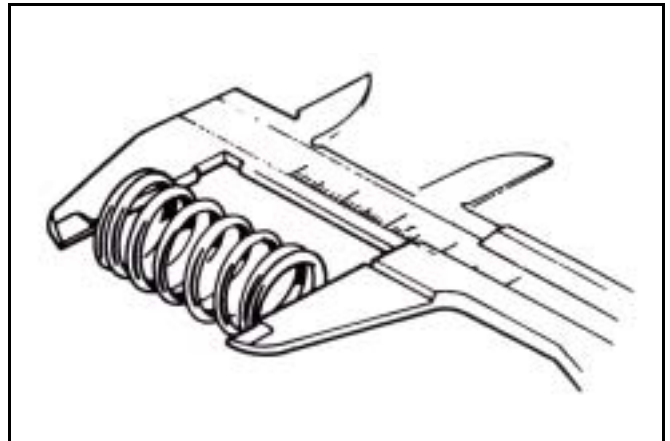

### Valve stem

Check if valve stems are bend, crack or burn. Check the operation condition of valve stem in valve guide, and measure & record the valve stem outer diameter.

**Service Limit: IN: 4.90 mm**

**EX: 4.90 mm**

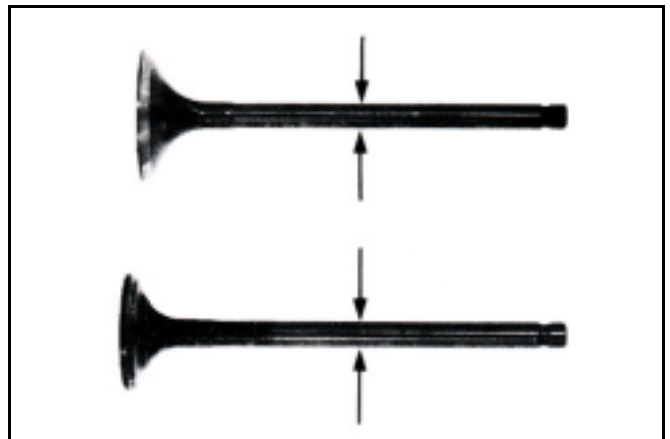

### Valve guide

#### Caution

Before measuring the valve guide, clean carbon deposits with reamer.

**Tool: 5.0 mm valve guide reamer**

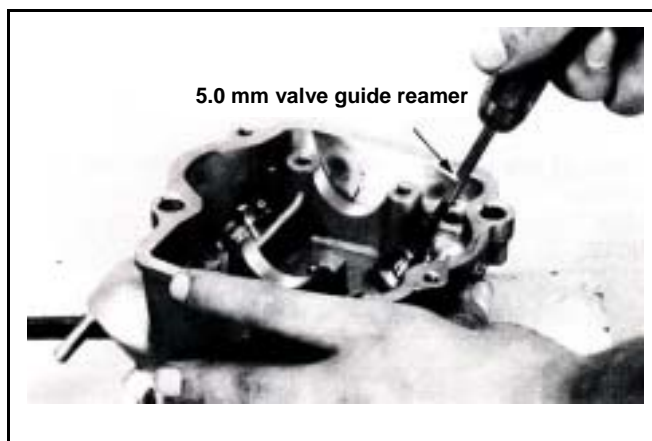

Measure and record each valve guide inner diameters.

**Service limit: 5.03 mm**

The difference that the inner diameter of valve guide deducts the outer diameter of valve stem is the clearance between the valve stem and valve guide.

**Service Limit: IN 0.08 mm  
EX 0.10 mm**

#### Caution

If clearance between valve stem and valve guide exceeded service limit, check whether the new clearance that only replaces new valve guide is within service limit or not. If so, replace valve guide.

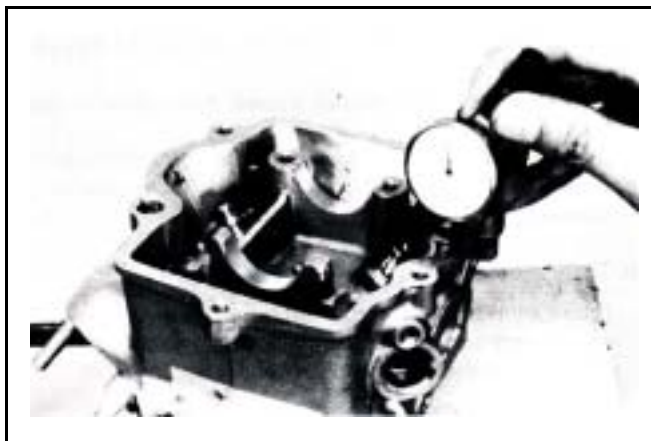

Correct it with reamer after replacement.  
If clearance still exceeds service limit after replaced valve guide, replace valve stem too.

#### Caution

It has to correct valve seat when replacing valve guide.



## 6. CYLINDER HEAD/VALVE

### Valve Stem Replacement

Heat up cylinder head to 100~150 with heated plate or toaster.

#### Caution

- Do not let torch heat cylinder head directly. Otherwise, the cylinder head may be deformed as heating it.
- Wear on a pair of glove to protect your hands when operating.

Hold the cylinder head, and then press out old valve guide from combustion chamber side.

**Tool: Valve guide driver: 5.0 mm**

#### Caution

- Check if new valve guide is deformation after pressed it in.
- When pressing in the new valve guide, cylinder head still have to be kept in 100~150 .

Adjust the valve guide driver and let valve guide height is in 13 mm.

Press in new valve guide from rocker arm side.

**Tool: Valve guide driver: 5.0 mm**

Wait for the cylinder head cooling down to room temperature, and then correct the new valve guide with reamer.

#### Caution

- Using cutting oil when correcting valve guide with a reamer.
- Turn the reamer in same direction when it be inserted or rotated.

Correct valve seat, and clean up all metal residues from cylinder head.

**Tool: Valve guide reamer: 5.0 mm**

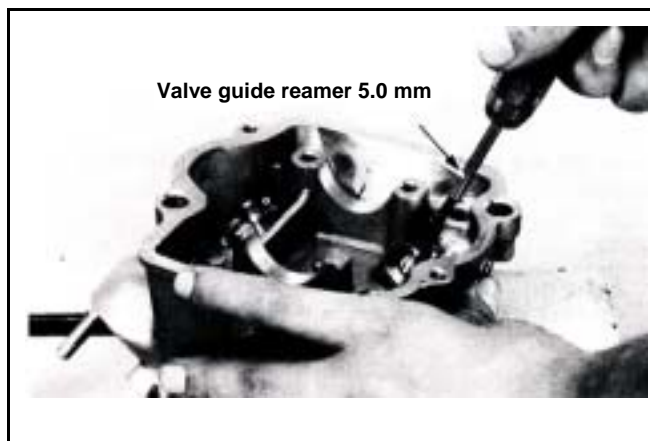
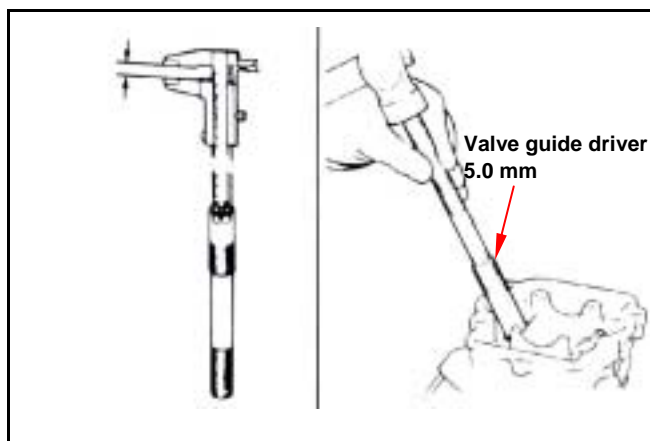
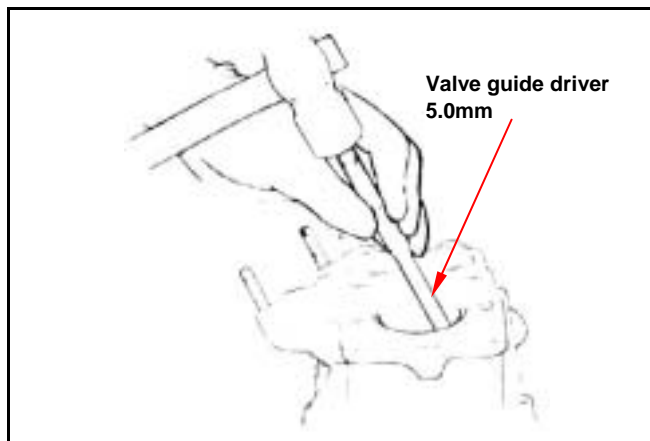

## Valve Seat Inspection and Service

Clean up all carbon deposits onto intake and exhaust valves.

Apply with emery slightly onto valve contact face.  
Grind valve seat with a rubber hose or other manual grinding tool.

### ⚠ Caution

- Do not let emery enter into between valve stem and valve guide.
- Clean up the emery after corrected, and apply with engine oil onto contact faces of valve and valve seat.

Remove the valve and check its contact face.

### ⚠ Caution

Replace the valve with new one if valve seal is roughness, wear out, or incomplete contacted with valve seat.

### Valve seat inspection

If the valve seat is too width, narrow or rough, corrects it.

### Valve seat width

**Service limit: 1.6mm**

Check the contact condition of valve seat.

### Valve seat grinding

The worn valve seat has to be ground with valve seat chamfer cutter.

Refer to operation manual of the valve seat chamfer cutter.

Use 45° valve seat chamfer cutter to cut any rough or uneven surface from valve seat.

### ⚠ Caution

After valve guide had been replaced, it has to be ground with 45° valve seat chamfer cutter to correct its seat face.

Use 32° cutter to cut a quarter upper parts out.

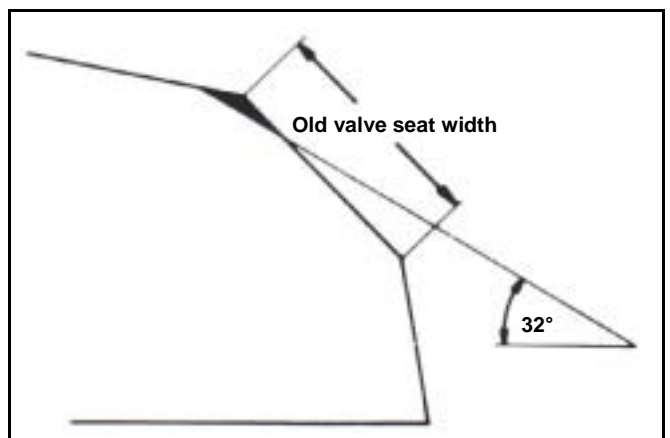
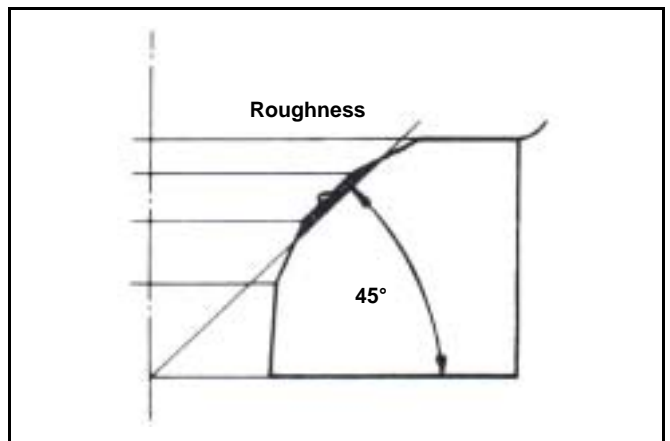
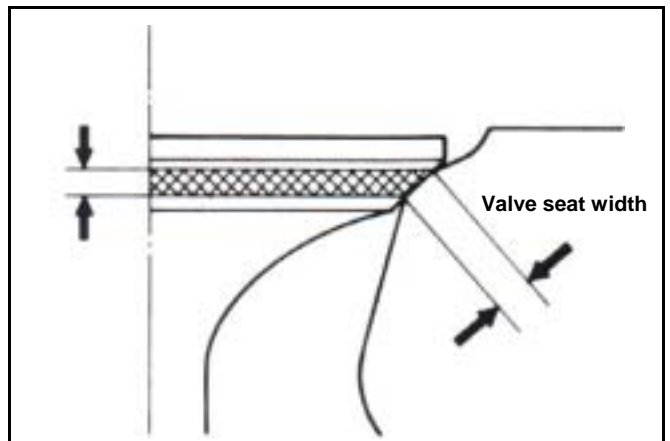
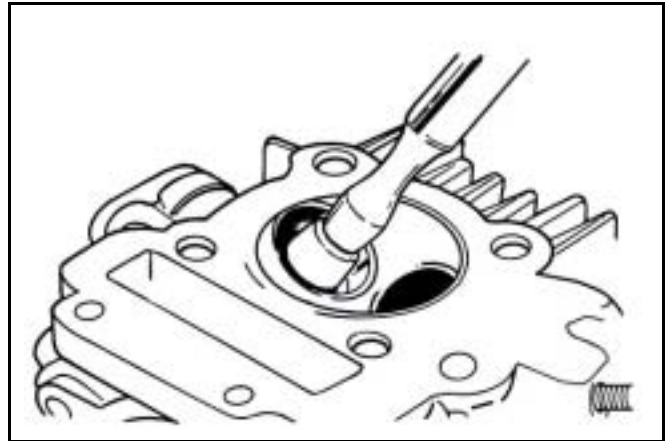

## 6. CYLINDER HEAD/VALVE

Use 60° cutter to cut a quarter lower parts out.  
Remove the cutter and check new valve seat.

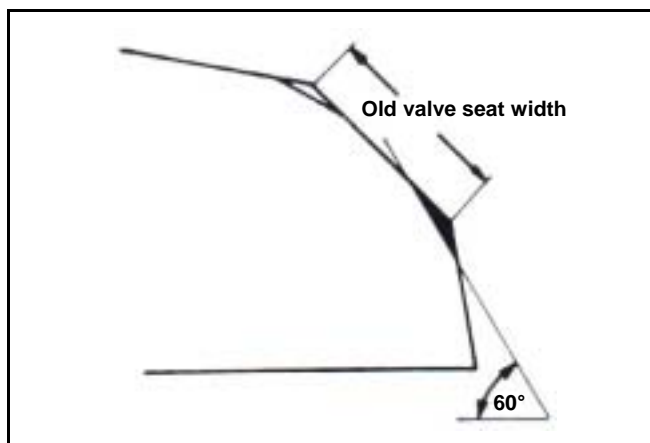

Use 45° cutter to grind the valve seat to specified width.

### Caution

Make sure that all roughness and uneven faces had been ground.

Grind valve seat again if necessary.

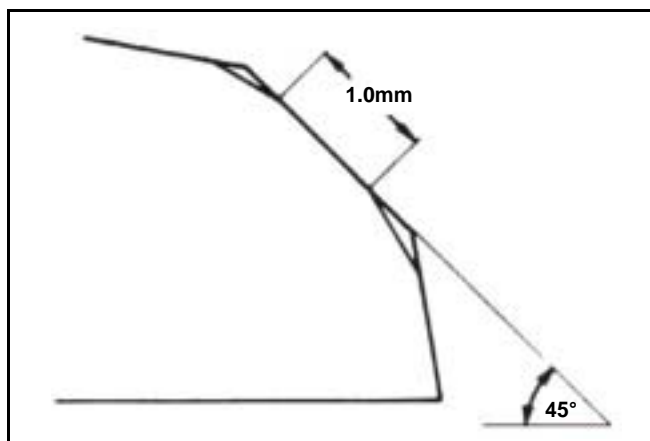

Coat the valve seat surface with red paint.  
Install the valve through valve guide until the valve contacting with valve seat, slightly press down the valve but do not rotate it so that a seal track will be created on contact surface.

### Caution

The contact surfaces of valve and valve seat are very important to the valve sealing capacity.

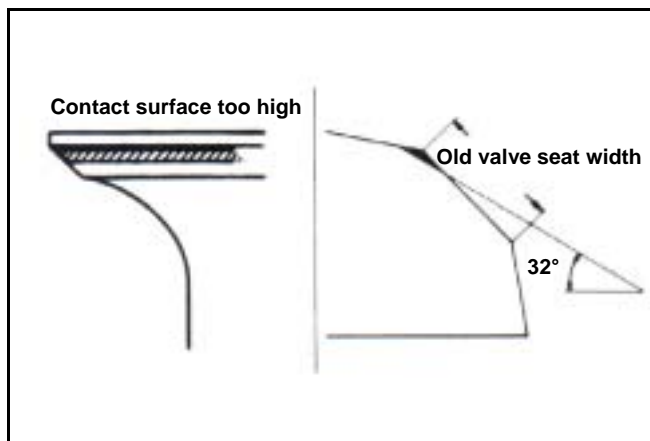

If the contact surface too high, grind the valve seat with 32° cutter.  
Then, grind the valve seat to specified width.

If the contact surface too low, grind the valve seat with 60° cutter.  
Then, grind the valve seat to specified width.

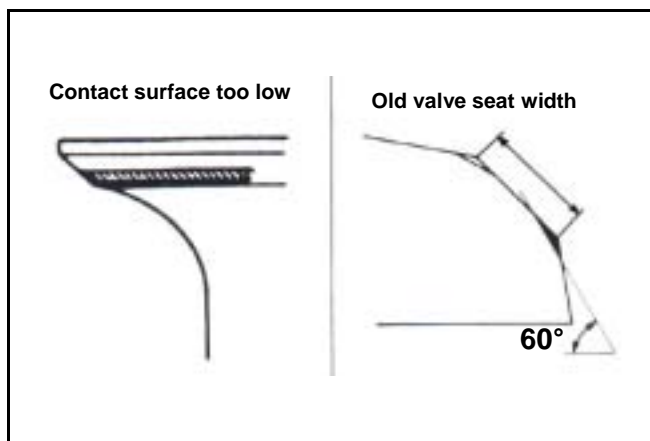

After the valve seat ground, coat valve seat surface with emery and then slightly press the ground surface.  
Clean up all emery coated onto cylinder and valve after ground.

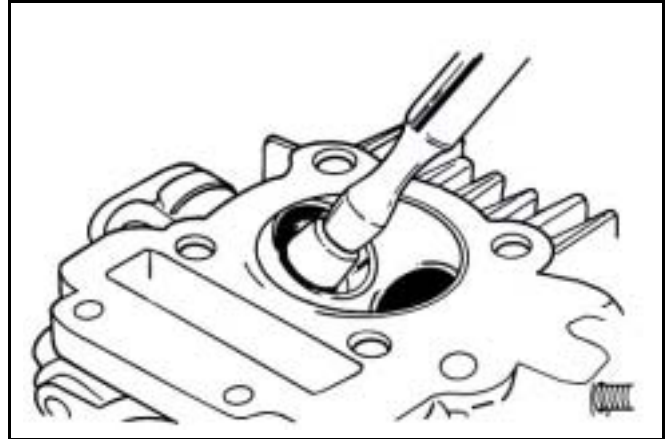

### Cylinder Head Reassembly

Lubricate valve stem with engine oil, and then insert the valve into valve guide.  
Install new valve stem oil seal.  
Install valve springs and retainers.

#### Caution

The closed coils of valve spring should face down to combustion chamber.

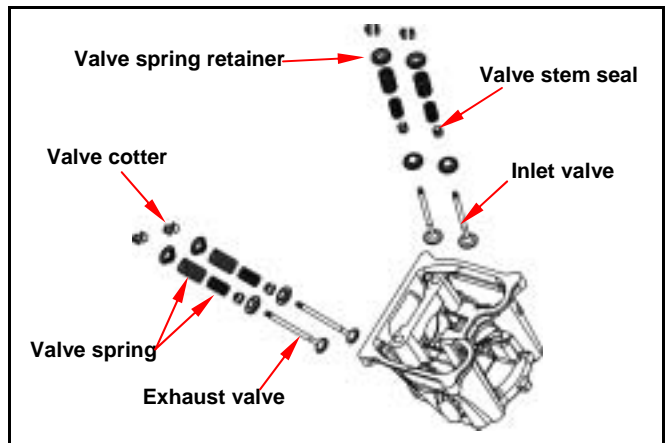

Use a valve cotter remove & assembly tool to press the valve spring, and then remove valves.

#### Caution

In order to avoid damaging the valve stem and the cylinder head, in the combustion chamber place a rag between the valve spring remover/installer as compressing the valve spring directly.

#### Special Service Tool: Valve cotter remove & assembly tool

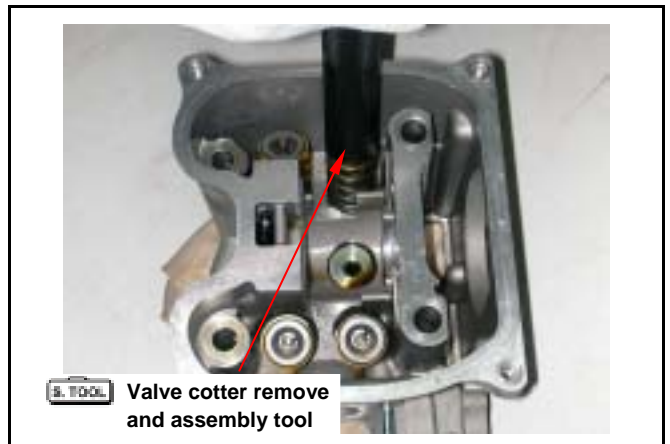

Tap the valve stems gently with a plastic hammer to make sure valve retainer and valve cotter is settled.

#### Caution

Place and hold cylinder head on to working table so that can prevent from valve damaged.

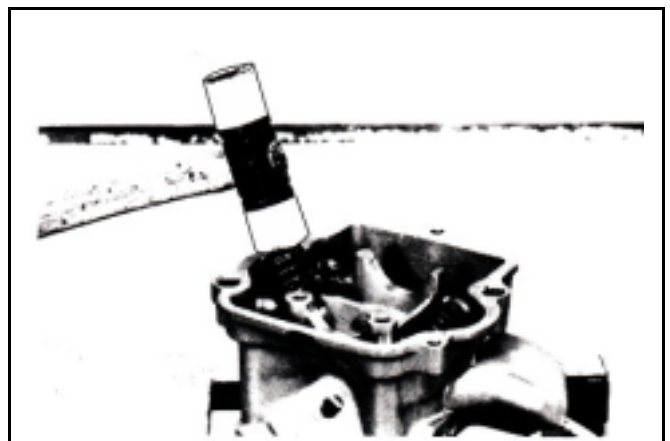

## 6. CYLINDER HEAD/VALVE

### Cylinder Head Installation

Clean up all residues and foreign materials onto the matching surfaces of both cylinder and cylinder head.

Install chain guide, dowel pins and a new cylinder head gasket onto the cylinder.

#### Caution

Do not damage the matching surfaces of cylinder and cylinder head.

Avoid residues of gasket or foreign materials falling into crankcase as cleaning.

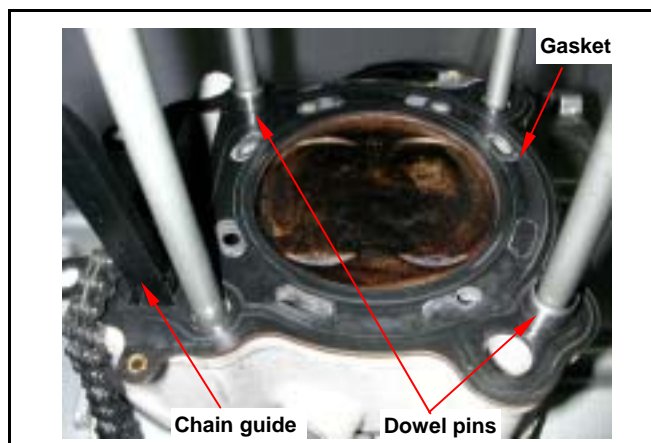

Install 4 washers and tighten 4 nuts on the cylinder head upper side, and then tighten 2 cylinder head mounting bolts of cylinder head right side.

#### Torque value:

**Nut** 3.6~4.0kgf-m

**Bolt** 1.0~1.4kgf-m

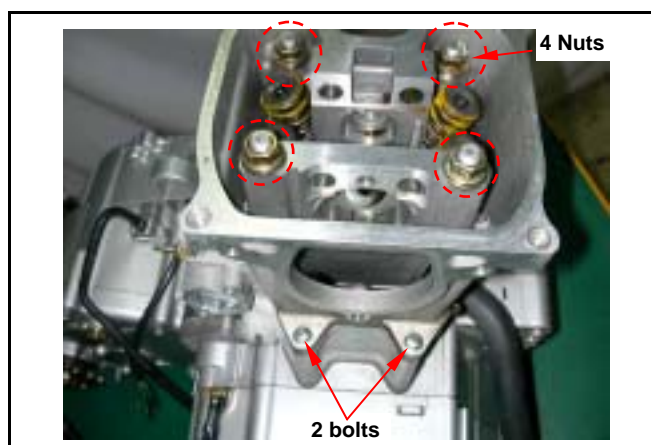

Install camshaft into cylinder head, and install rocker arm, rocker arm shaft.



Install rocker arm pin mounting plate.

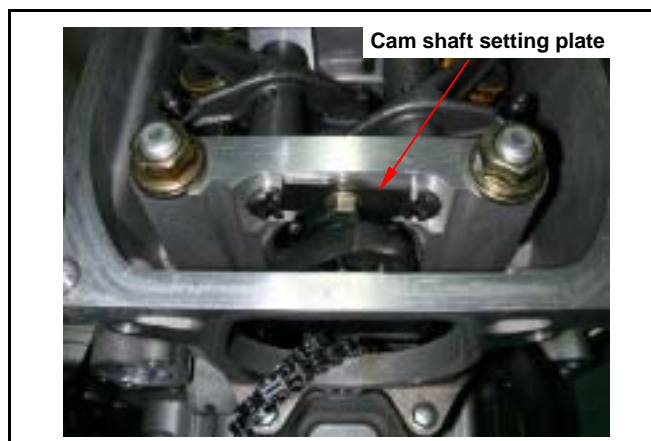

Install cam chain on to sprocket and align the timing mark on the sprocket with that of cylinder head.

Align sprocket bolt hole with camshaft bolt hole.  
Tighten the sprocket mounting bolts.

**⚠ Caution**

Make sure timing marks are matched.

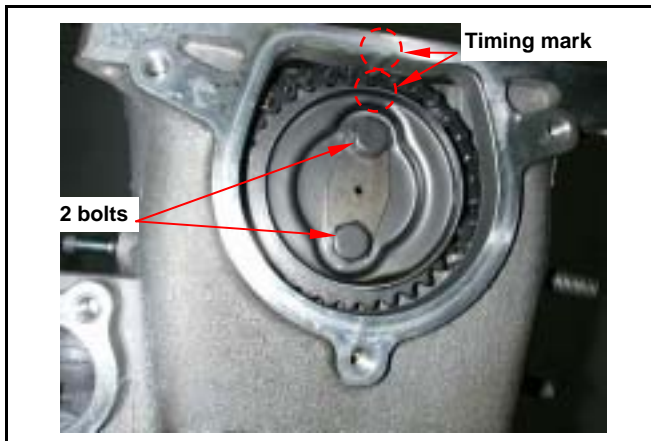

Install cylinder head side cover (3 bolts).  
Install thermostat (2 bolts).

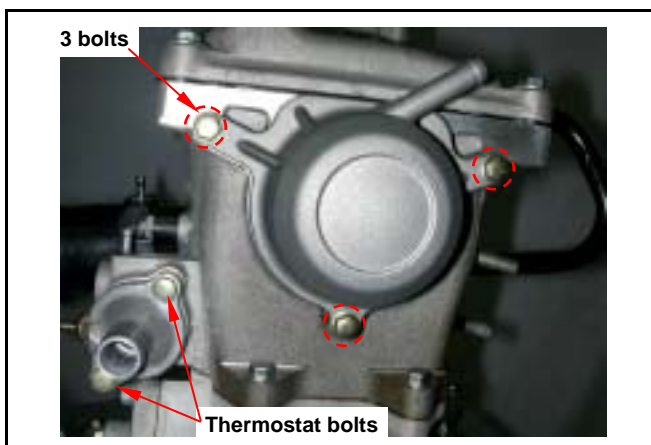

Loosen auto tensioner adjustment bolt and remove bolt and spring.  
Install tensioner and install spring and adjustment bolt.

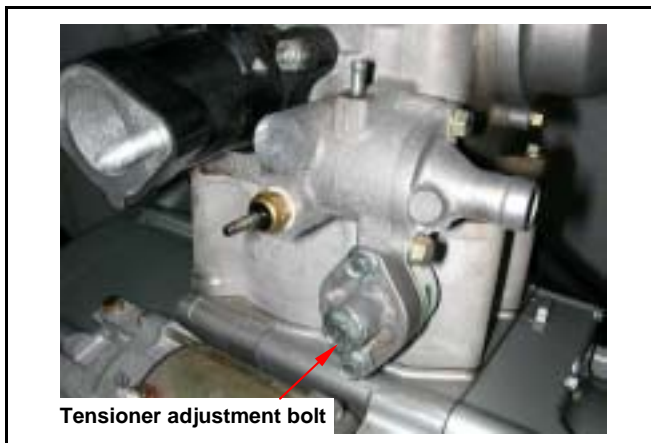

Install cylinder cover (4 bolts).

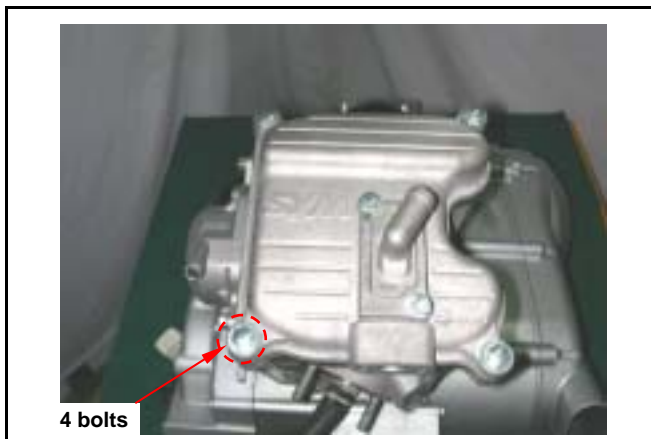

## 6. CYLINDER HEAD/VALVE

Install Air Injection system (AI) pipe. (4 bolts)

Install inlet pipe onto cylinder

Install and tighten spark plug

**Torque value: 1.0~2.0kgf-m**

### Caution

This model is equipped with more precision 4-valve mechanism so its tighten torque can not be exceeded standard value in order to avoid causing cylinder head deformation, engine noise and leaking so that motorcycle's performance be effected.

Install the engine onto frame (refer chapter 5).

### Valve Clearance Adjustment

Loosen Air Injection system (AI) pipe upper side bolt (2 bolts).

Remove cylinder head cover.

Remove the cylinder head side cover.

Remove left crankcase cover, and turn the drive face, and align the timing mark on the cam sprocket with that of cylinder head, piston is at TDC position.

Loosen valve clearance adjustment nuts and bolts located on valve rocker arm.

Measure and adjust valve clearance with feeler gauge.

After valve clearance had been adjusted to standard value, hold adjustment bolt and then tighten the Adjustment nut.

**Standard Value: IN  $0.10 \pm 0.02$  mm**  
**EX  $0.15 \pm 0.02$  mm**

Install the cylinder head side cover.

Start the engine and make sure that engine oil flows onto the cylinder head.

Stop the engine after confirmed, and then install the cylinder head cover and AI pipe.

### Caution

- If lubricant does not flow to cylinder head, engine components will be worn out seriously. Thus, it must be confirmed.
- When checking lubricant flowing condition, run the engine in idle speed. Do not accelerate engine speed.

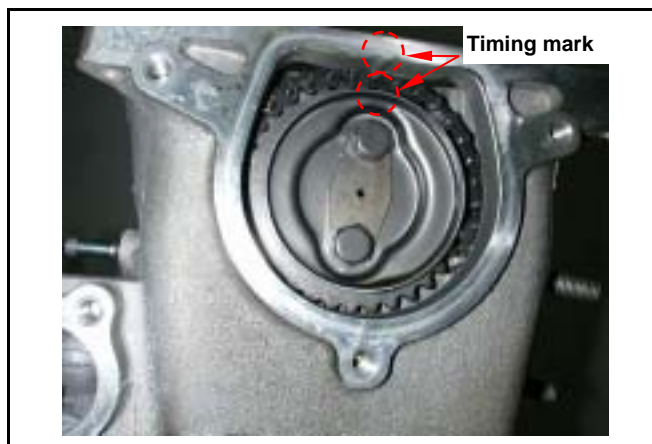
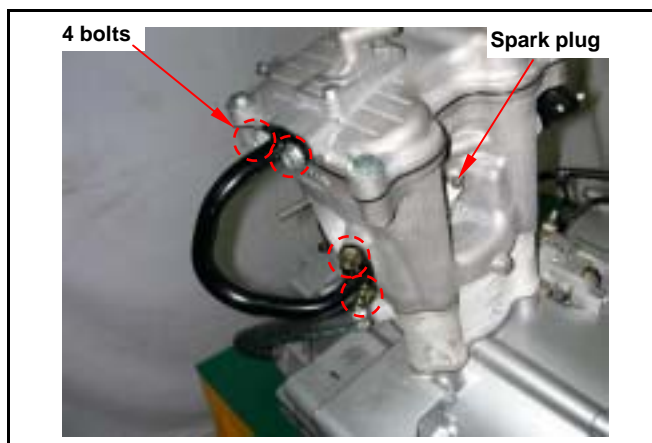

Mechanism Diagram .....	7-1	Piston Ring Installation .....	7-6
Precautions in Operation .....	7-2	Piston Installation .....	7-7
Trouble Diagnosis.....	7-2	Cylinder Installation .....	7-7
Cylinder and Piston Removal .....	7-3		

## Mechanism Diagram

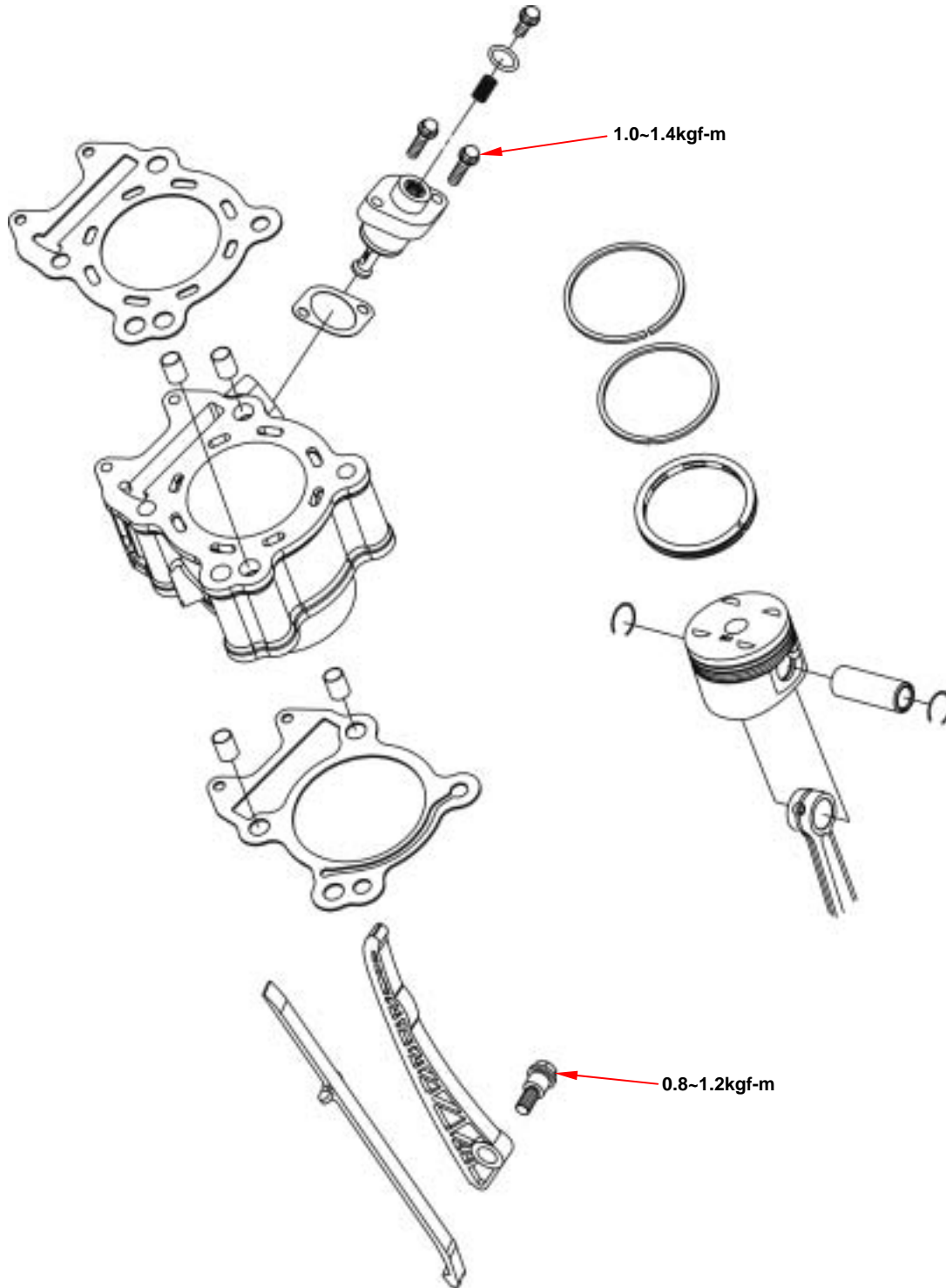



## 7. CYLINDER/PISTON

### Precautions in Operation

#### General Information

- Both cylinder and piston service cannot be carried out when engine mounted on frame.

#### UA25A

#### Specification

Unit : mm

Item		Standard	Limit	
Cylinder	ID	70.995~71.015	71.100	
	Bend	-	0.050	
Piston/ Piston ring	Clearance between piston rings	Top ring	0.015~0.050	
		2 <sup>nd</sup> ring	0.015~0.050	
	Ring-end gap	Top ring	0.150~0.300	
		2 <sup>nd</sup> ring	0.300~0.450	
		Oil ring side rail	0.200~0.700	
	OD of piston (2 <sup>nd</sup> )		70.430~70.480	70.380
	Clearance between piston and cylinder		0.010~0.040	0.100
ID of piston pin boss		17.002~17.008	17.020	
OD of piston pin		16.994~17.000	16.960	
Clearance between piston and piston pin		0.002~0.014	0.020	
ID of connecting rod small-end		17.016~17.034	17.064	

### Trouble Diagnosis

#### Low or Unstable Compression Pressure

- Cylinder or piston ring worn out

#### Smoking in Exhaust Pipe

- Piston or piston ring worn out
- Piston ring installation improperly
- Cylinder or piston damage

#### Knock or Noise

- Cylinder or piston ring worn out
- Carbon deposits on cylinder head top-side
- Piston pin hole and piston pin wear out

#### Engine Overheat

- Carbon deposits on cylinder head top side
- Cooling pipe clogged or not enough in coolant flow

## Cylinder and Piston Removal

Remove cylinder head (refer to chapter 6).  
Remove coolant hose from cylinder.  
Remove cylinder.

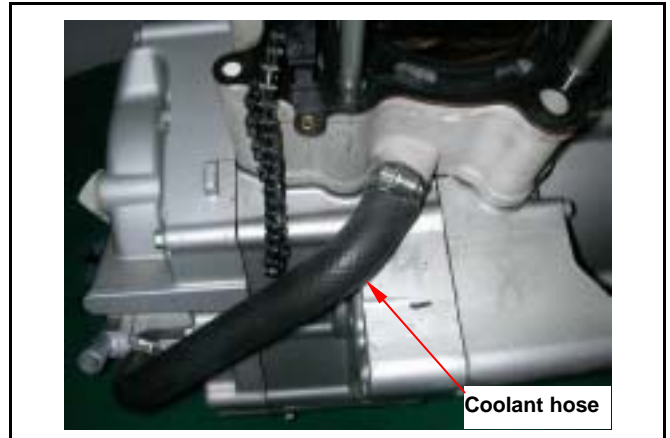

Cover the holes of crankcase and cam chain with a piece of cloth.  
Remove piston pin clip, and then remove piston pin and piston.



Remove cylinder gasket and dowel pin.  
Clean up all residues or foreign materials from the two matching surfaces of cylinder and crankcase.

### Caution

- Soap the residues into solvent so that the residues can be removed more easily.

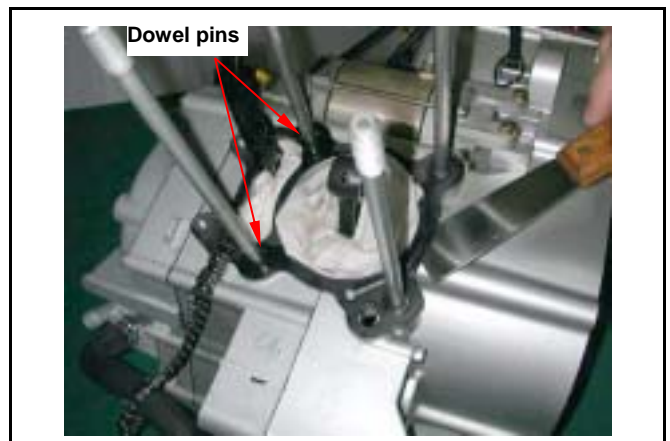

### Inspection

Check if the inner diameter of cylinder is wear out or damaged.

In the 3 positions, top, center and bottom, of cylinder, measure the X and Y values respective in the cylinder.

**Service limit: 71.100 mm**

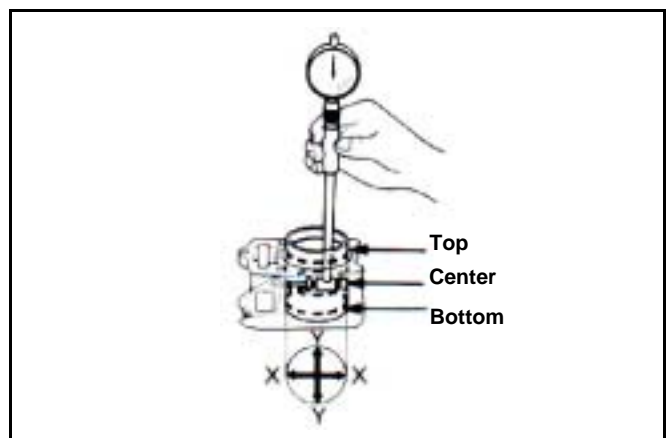

## 7. CYLINDER/PISTON

Check cylinder if warp.

**Service limit: 0.05 mm**

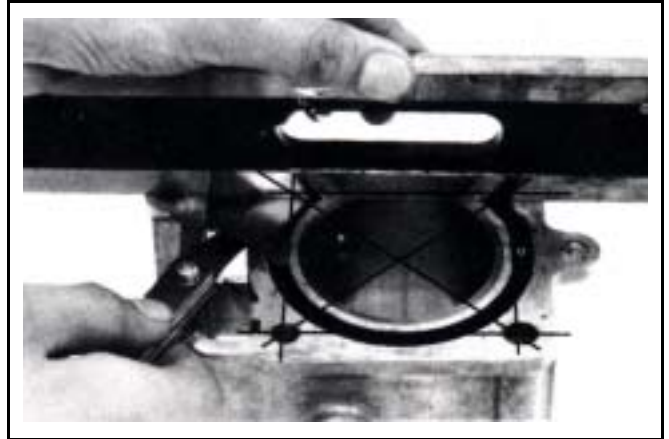

Measure clearance between piston rings and grooves.

**Service Limit: Top ring: 0.09 mm**

**2<sup>nd</sup> ring: 0.09 mm**



### Remove piston rings

Check if the piston rings are damaged or its grooves are worn.

#### **Caution**

Pay attention to remove piston rings because they are fragile.



Place piston rings respective into cylinder below 20 mm of cylinder top. In order to keep the piston rings in horizontal level in cylinder, push the rings with piston.

**Service Limit: Top ring: 0.50 mm**

**2<sup>nd</sup> ring: 0.65 mm**

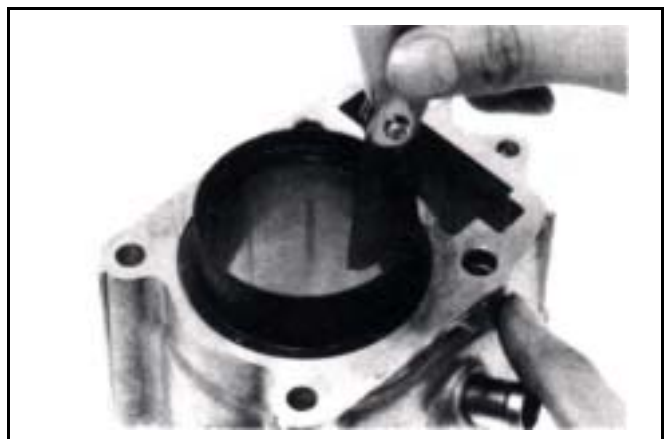

Measure the outer diameter of piston pin.

**Service Limit: 16.96 mm**



Measure the inner diameter of connecting rod small end.

**Service Limit: 17.064 mm**



Measure the inner diameter of piston pin hole.

**Service Limit: 17.02 mm**

Calculate clearance between piston pin and its hole.

**Service Limit: 0.02 mm**



Measure piston outer diameter.

**⚠ Caution**

The measurement position is 10 mm distance from piston bottom side, and 90° to piston pin.

**Service limit : 70.380 mm**

Compare measured value with service limit to calculate the clearance between piston and cylinder.



## 7. CYLINDER/PISTON

### Piston Ring Installation

Clean up piston top, ring groove, and piston surface.

Install the piston ring onto piston carefully.

Place the openings of piston ring as diagram shown.

#### Caution

- Do not damage piston and piston rings as installation.
- All marks on the piston rings must be forwarded to up side.
- Make sure that all piston rings can be rotated freely after installed.

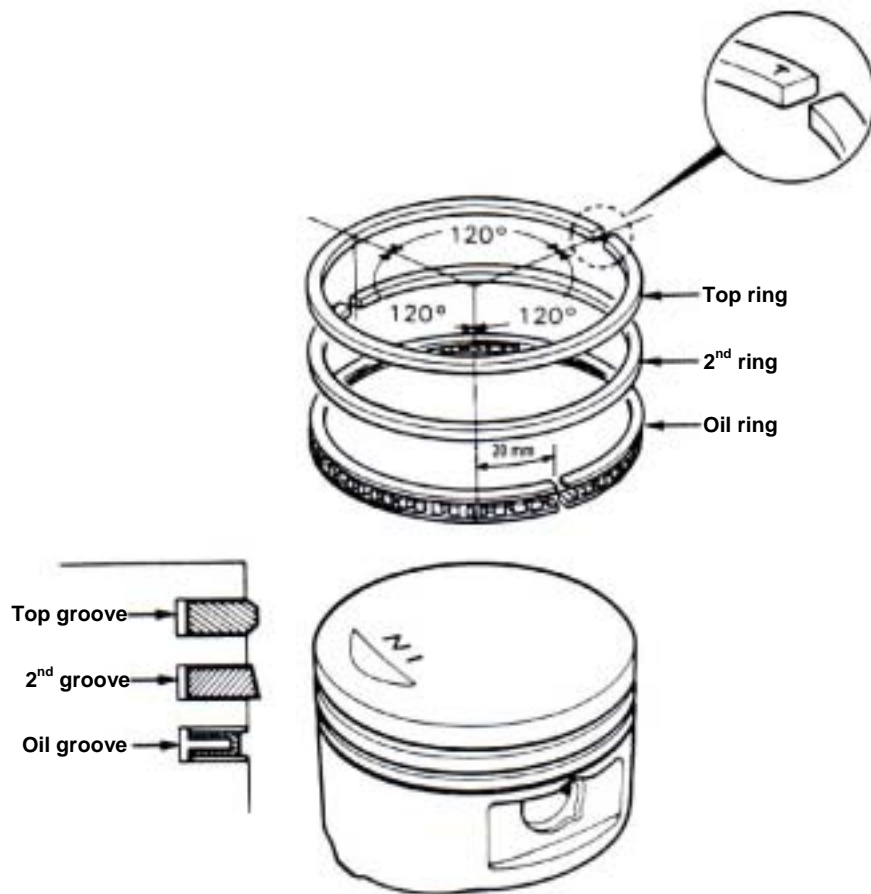

Clean up all residues and foreign materials on the matching surface of crankcase. Pay attention to not let these residues and foreign materials fall into crankcase.

### ⚠ Caution

Soap the residues into solvent so that the residues can be removed more easily.

## Piston Installation

Install piston and piston pin, and place the IN marks on the piston top side forward to inlet valve.

Install new piston pin clip.

### ⚠ Caution

- Do not let the opening of piston pin clip align with the piston cutout.
- Place a piece of cloth between piston and crankcase in order to prevent snap ring from falling into crankcase as operation.

## Cylinder Installation

Install dowel pins and new gasket.

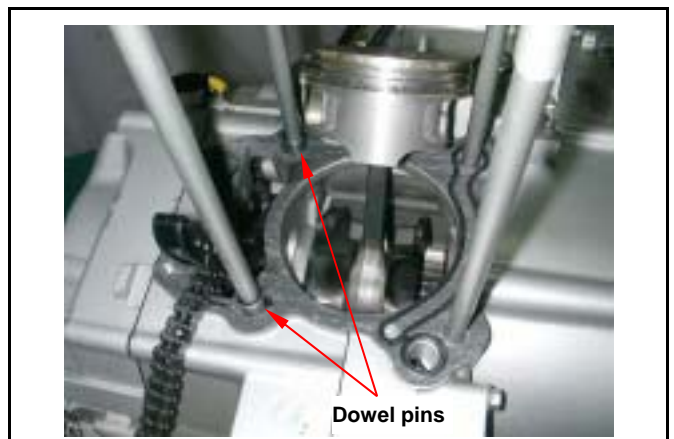
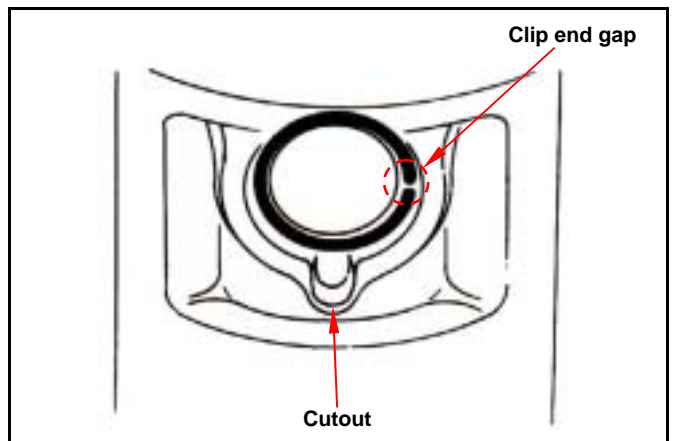

## 7. CYLINDER/PISTON

Coat some engine oil to inside of cylinder, piston and piston rings.

Care to be taken when installing piston into cylinder. Press piston rings in one by one as installation.

### **Caution**

Do not push piston into cylinder forcefully because piston and piston rings will be damaged.



Install coolant hose onto cylinder.

Install cylinder head (refer to Chapter 6).

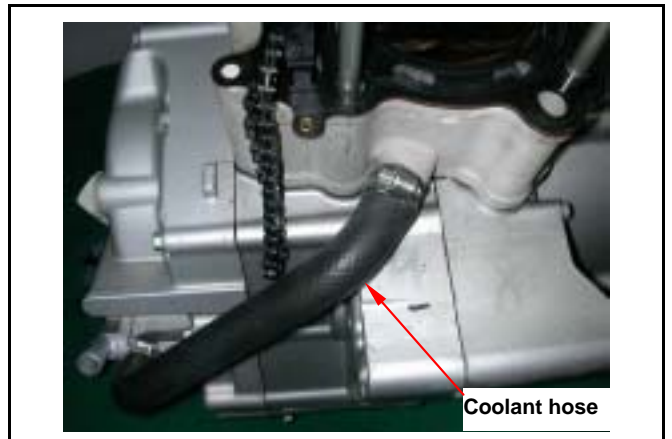

## 8. V-BELT DRIVING SYSTEM

Mechanism Diagram ..... 8-1	Drive Belt ..... 8-5
Maintenance Description ..... 8-2	Drive Face ..... 8-7
Trouble Diagnosis ..... 8-2	Clutch Outer/Driven Pulley ..... 8-10
Left Crankcase Cover ..... 8-3	

### Mechanism Diagram

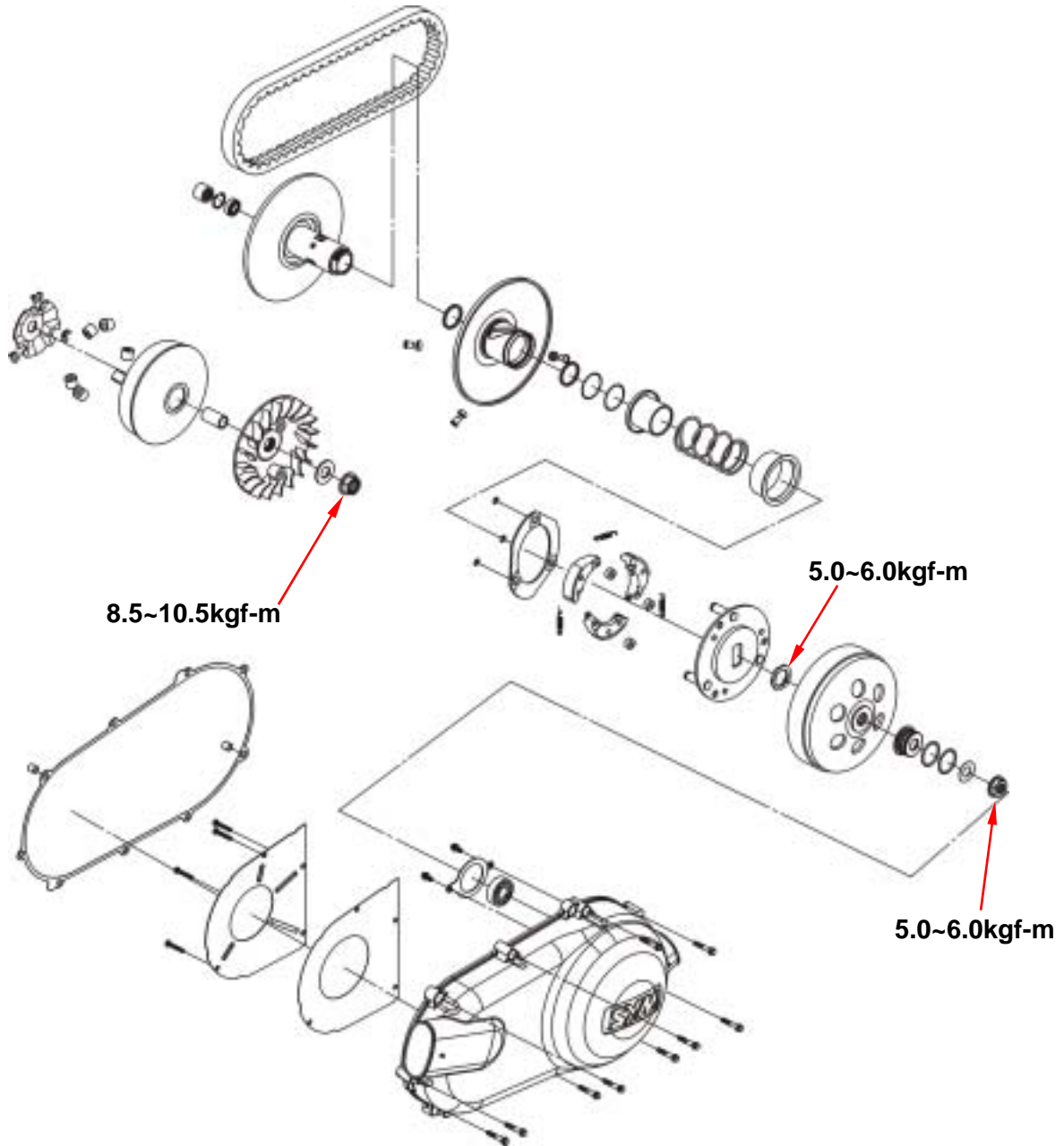



## 8. V-BELT DRIVING SYSTEM

### Maintenance Description

#### Precautions in Operation

##### General Information

- Drive face, clutch outer, and driven pulley can be serviced on the motorcycle.
- Drive belt and drive pulley must be free of grease.

#### Specification

Item	Standard value	Limit
Driving belt width	24.000 mm	22.500 mm
OD of movable drive face boss	29.946~29.980 mm	29.926 mm
ID of movable drive face	30.000~30.040 mm	30.060 mm
OD of weight roller	19.500~20.000 mm	19.000 mm
ID of clutch outer	144.850~145.150 mm	145.450 mm
Thickness of clutch weight	6.000 mm	3.000 mm
Free length of driven pulley spring	102.400 mm	97.400 mm
OD of driven pulley boss	40.950~40.990 mm	40.930 mm
ID of driven face	41.000~41.050 mm	41.070 mm
Weight of weight roller	17.700~18.300 g	17.200 g

#### Torque value

- Drive face nut: 8.5~10.5kgf-m
- Clutch outer nut: 5.0~6.0kgf-m
- Drive plate nut: 5.0~6.0kgf-m

#### Special Service Tools

Clutch spring compressor: SYM-2301000

Inner bearing puller: SYM-6204002

Clutch nut wrench 39 x 41 mm: SYM-9020200

Universal holder: SYM-2210100

Bearing driver: SYM-9100100

### Trouble Diagnosis

#### Engine can be started but motorcycle can not be moved

1. Worn drive Belt
2. Worn drive face
3. Worn or damaged clutch weight
4. Broken driven pulley

#### Insufficient horsepower or poor high speed performance

1. Worn drive belt
2. Insufficient spring force of driven pulley
3. Worn roller
4. Driven pulley operation un-smoothly

#### Shudder or misfire when driving

1. Broken clutch weight
2. Worn clutch weight



## 8. V-BELT DRIVING SYSTEM

### Left Crankcase Cover

#### Left crankcase cover removal

Release the 2 clamp strips of left crankcase cover ducts, and then remove the ducts.

Remove left crankcase cover. (9 bolts)

Remove 2 dowel pin and gasket.

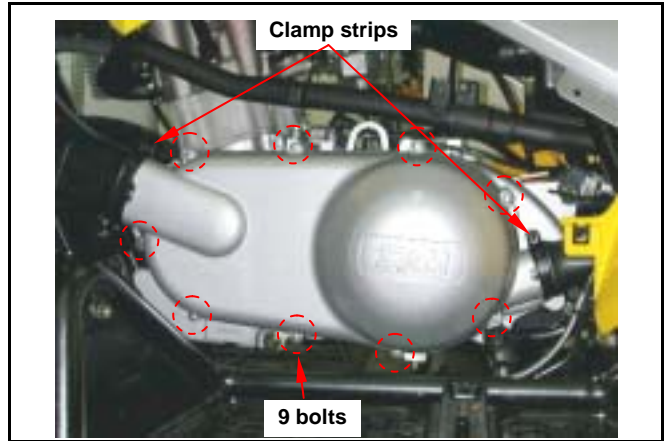

#### Left crankcase cover install

Install left crankcase cover in the reverse procedures of removal.

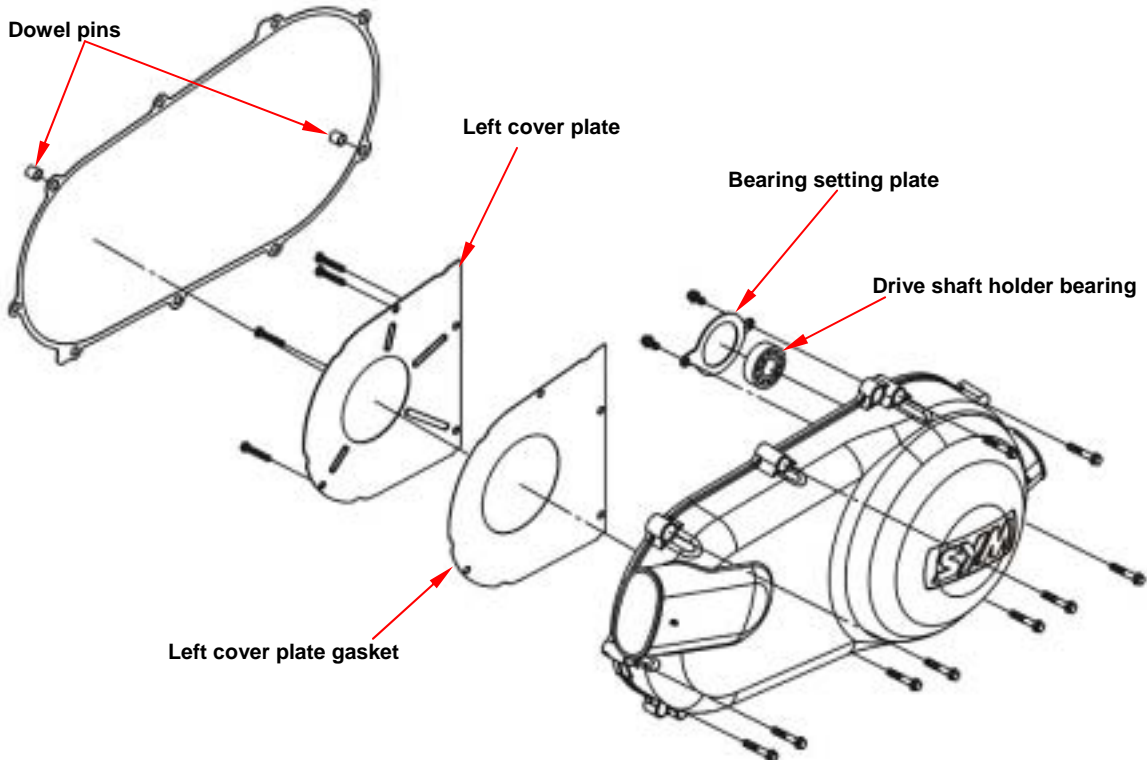
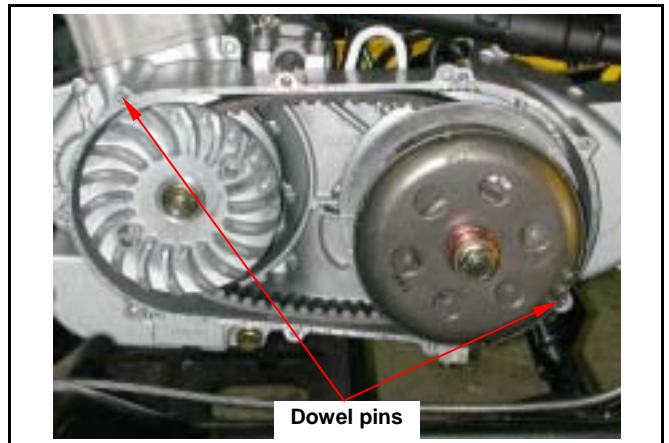

## 8. V-BELT DRIVING SYSTEM

### Left crankcase cover inspection

Remove 2 bolts to remove left crankcase cover bearing setting plate.

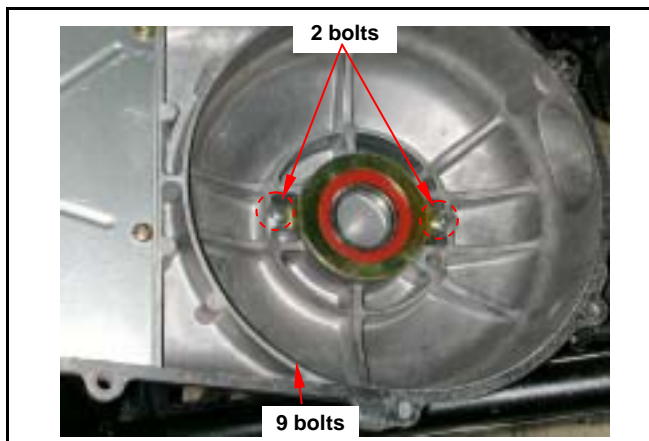

Check bearing on left crankcase cover.  
Rotate bearing's inner ring with fingers.  
Check if bearings can be turned in smooth and silent, and also check if bearing outer ring is mounted on cover tightly.  
If bearing rotation is uneven, noising, or loose bearing mounted, then replace it.



## Drive Belt

### Removal

Remove left crankcase cover.

Hold drive face with universal holder, and remove nut and drive face.

**Special Tool : universal holder**



Hold clutch outer with universal holder, and remove nut, bearing stay collar and clutch outer.

### ⚠ Caution

- Using special service tools for tightening or loosening the nut.
- Fixed rear wheel or rear brake will damage reduction gear system.

Push the drive belt into belt groove as diagram shown so that the belt can be loosened, and then remove the driven pulley.

Remove driven pulley. Do not remove drive belt. Remove the drive belt from the groove of driven pulley.

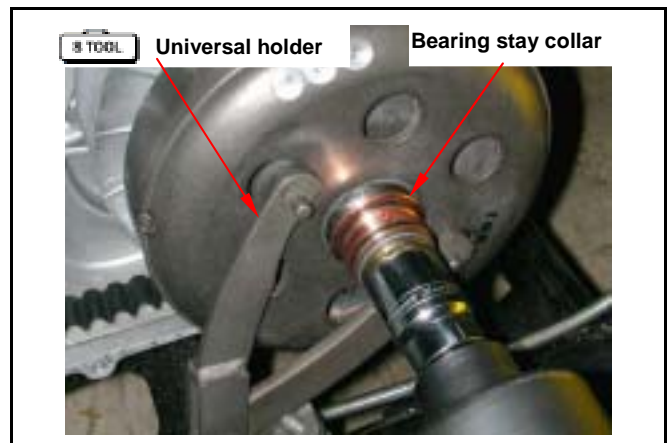

### Inspection

Check the drive belt for crack or wear. Replace it if necessary.

Measure the width of drive belt as diagram shown.

**Service Limit: 22.5 mm**

Replace the belt if exceeds the service limit.

### ⚠ Caution

- Using the genuine parts for replacement.
- The surfaces of drive belt or pulley must be free of grease.
- Clean up all grease or dirt before installation.

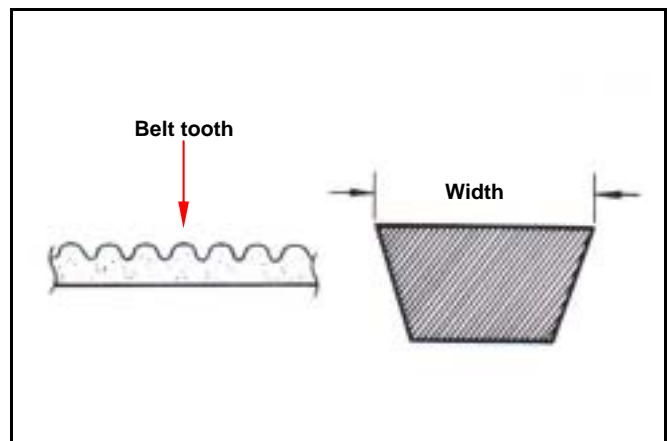
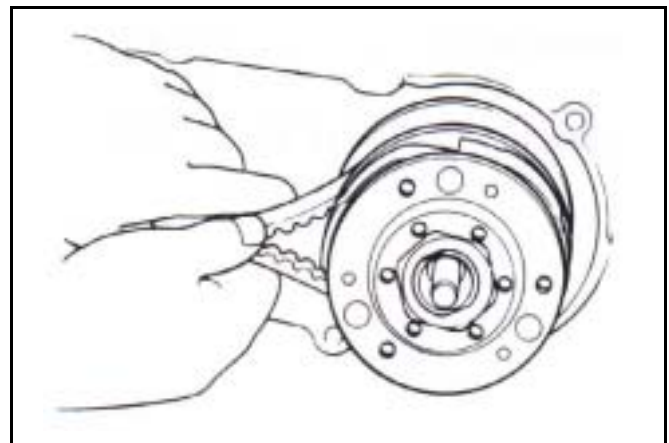

## 8. V-BELT DRIVING SYSTEM

### Installation

#### Caution

- Pull out driven face to avoid it closing.
- Cannot oppress friction plate comp in order to avoid creates the distortion or the damage.

Install drive belt onto driven pulley.

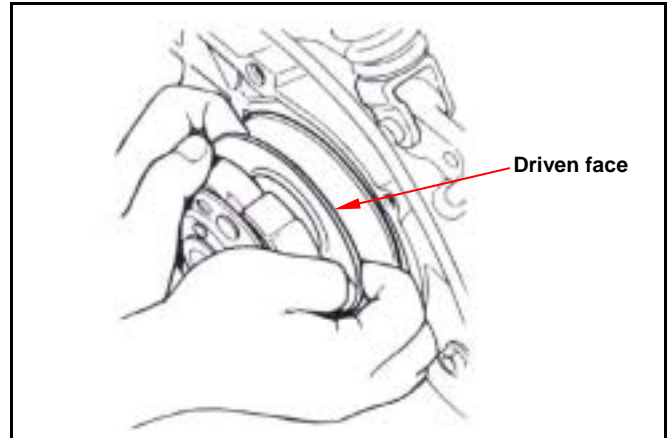

Install the driven pulley that has installed the belt onto drive shaft.

On the drive belt another end to the movable drive face.



Install the clutch outer and bearing stay collar. Hold the clutch outer with universal holder, and then tighten nut to specified torque value.

**Torque value: 5.0~6.0kgf-m**

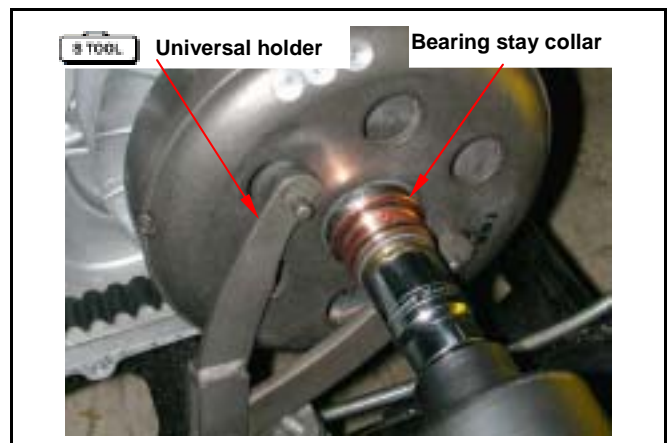

Install the drive face, washer and drive face nut. Hold drive face with universal holder, and then tighten nut to specified torque value.

**Torque value: 8.5~10.5kgf-m**



### Drive Face

#### Removal

Remove left crankcase cover.  
 Hold drive face with universal holder, and then  
 remove drive face nut.  
 Remove drive face and drive belt.



Remove movable drive face comp and drive face  
 boss from crankshaft.

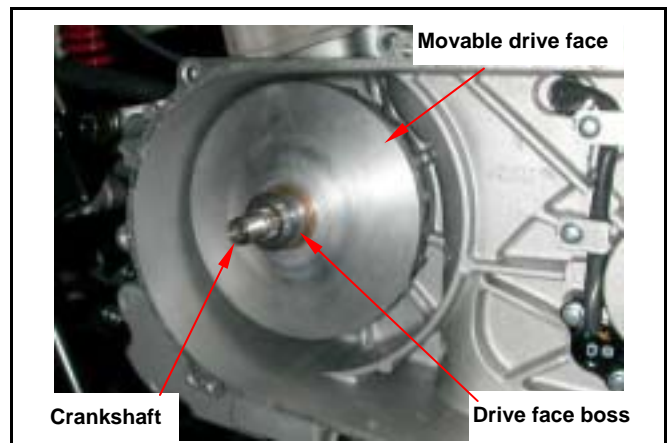

Remove ramp plate.



Remove weight rollers from movable drive face.

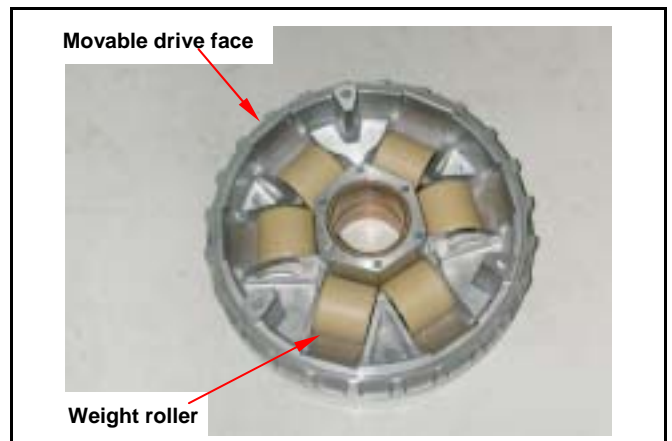

## 8. V-BELT DRIVING SYSTEM

### Inspection

The weight rollers are to press movable drive face by means of centrifuge force.

Thus, if weight rollers are worn out or damaged, the centrifuge force will be affected.

Check if rollers are worn or damaged. Replace it if necessary.

Measure each roller's outer diameter. Replace it if it exceed the service limit.

**Service limit: 19.0 mm**

**Weight: 17.2g**

Check if drive face boss is worn or damaged and replace it if necessary.

Measure the outer diameter of movable drive face boss, and replace it if it exceed service limit.

**Service limit: 29.962 mm**

Measure the inner diameter of movable drive face, and replace it if it exceed service limit.

**Service limit: 30.060 mm**

Reassembly/installation

Install weight rollers.

### Caution

The weight roller two end surfaces are not certainly same. In order to lengthen the roller life and prevented exceptionally wears the occurrence, Please end surface of the closure surface counter clockwise assembles onto movable drive face.

Install ramp plate.

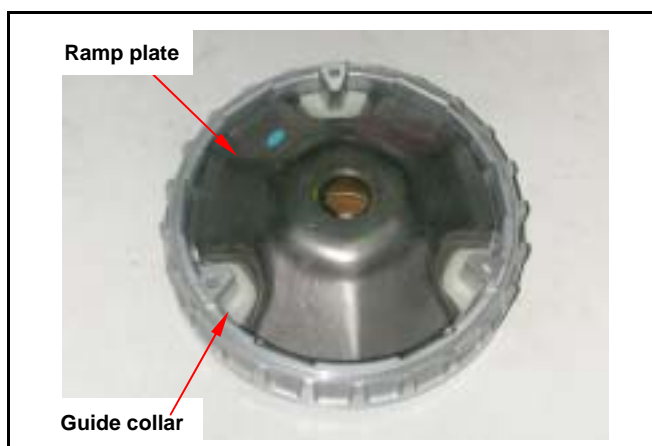
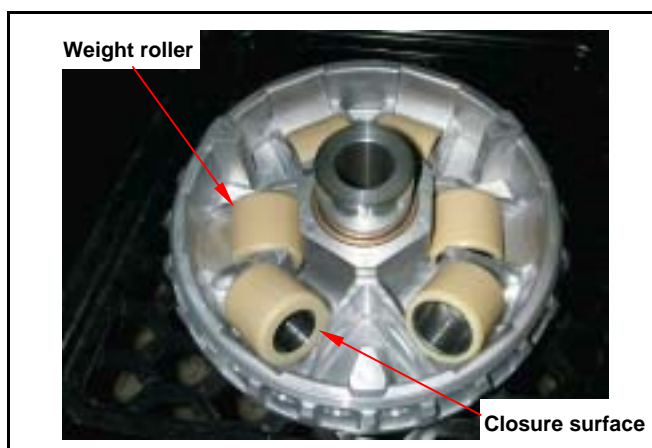
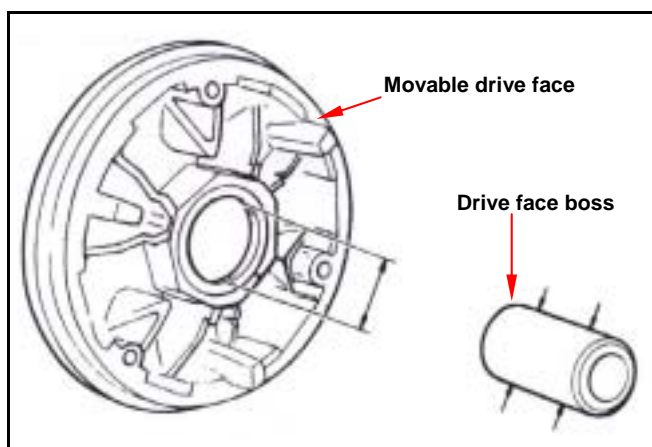
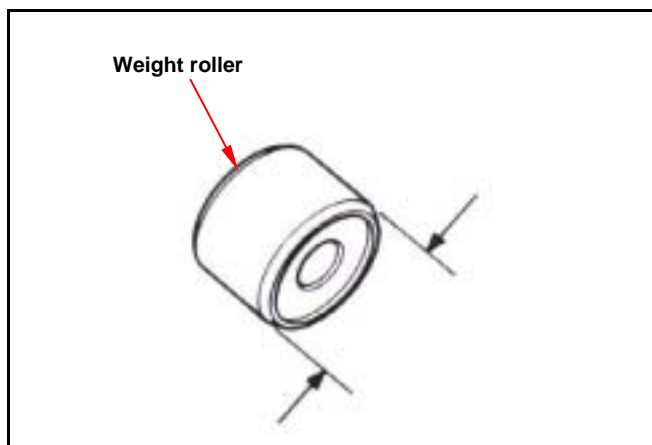

With 4~5g grease spreads wipes drives in the movable drive face axis hole.

Install drive face boss.

**⚠ Caution**

The movable drive face surface has to be free of grease. Clean it with cleaning solvent.

Install movable drive face comp. onto crankshaft.

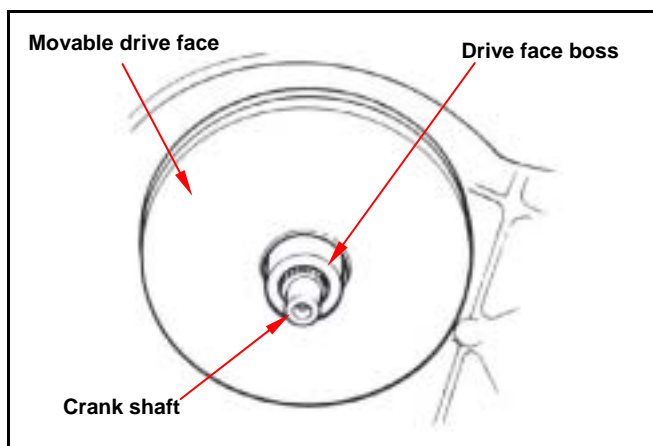
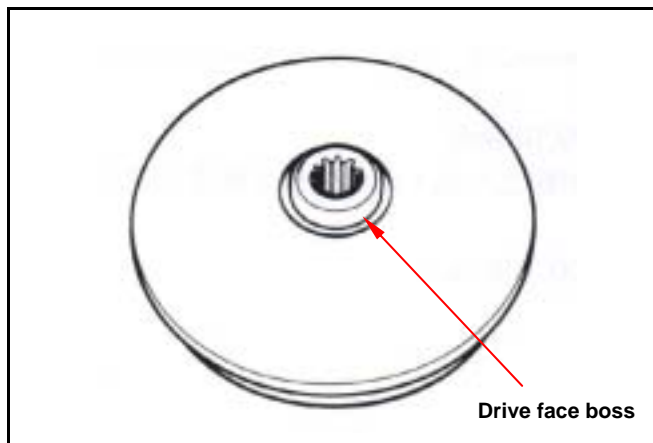

### Driven pulley installation

Press drive belt into pulley groove, and then pull the belt onto drive shaft.

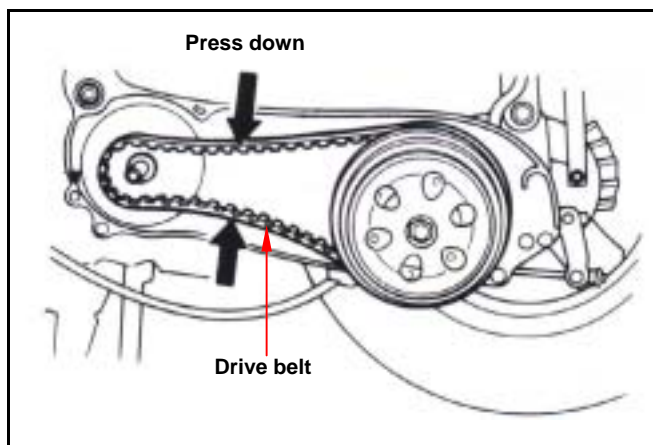

Install drive face, washer and nut.

**⚠ Caution**

Make sure that two sides of pulley surfaces have to be free of grease. Clean it with cleaning solvent.

Hold drives face with universal holder.

Tighten nut to specified torque.

**Torque value: 8.5~10.5kgf-m**

Install left crankcase cover.





## 8. V-BELT DRIVING SYSTEM

### Clutch Outer/Driven Pulley

#### Disassembly

Remove drive belt, clutch outer and driven pulley. Install clutch spring compressor onto the pulley assembly, and operate the compressor to let the wrench be installed more easily.

#### Caution

Do not press the compressor too much.

Hold the clutch spring compressor onto bench vise, and then remove mounting nut with special service tool.

Release the clutch spring compressor and remove friction plate, clutch weight and spring from driven pulley.

Remove seal collar from driven pulley.

Remove guide pin, guide pin roller, and movable driven face, and then remove O-ring & oil seal seat from movable driven face.

#### Inspection

##### Clutch outer

Measure the inner diameter of clutch outer. Replace the clutch outer if exceed service limit.

**Service limit: 145.450 mm**

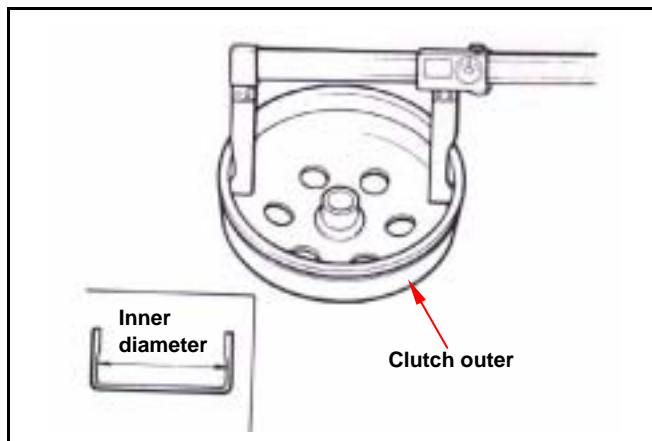
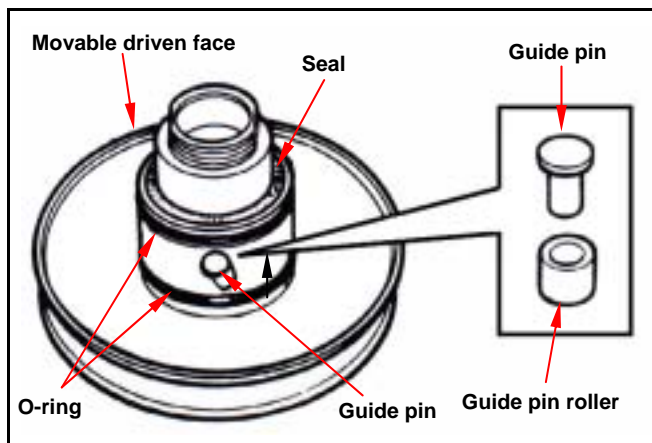
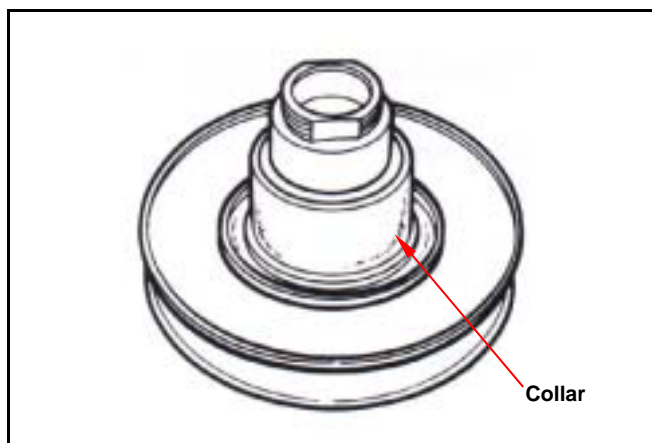
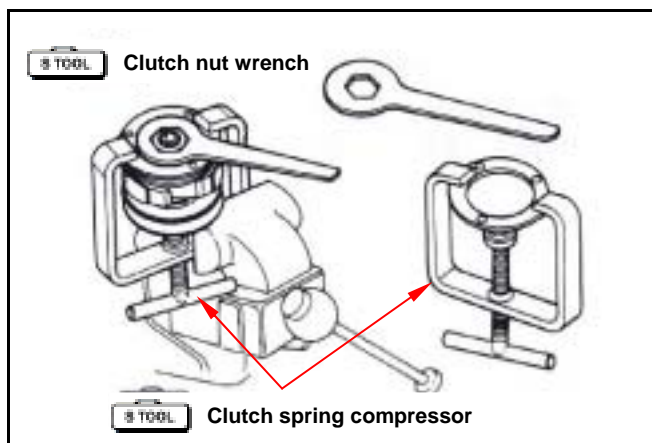

### Clutch lining

Measure each clutch weight thickness. Replace it if exceeds service limit.

**Service limit: 3.0 mm**

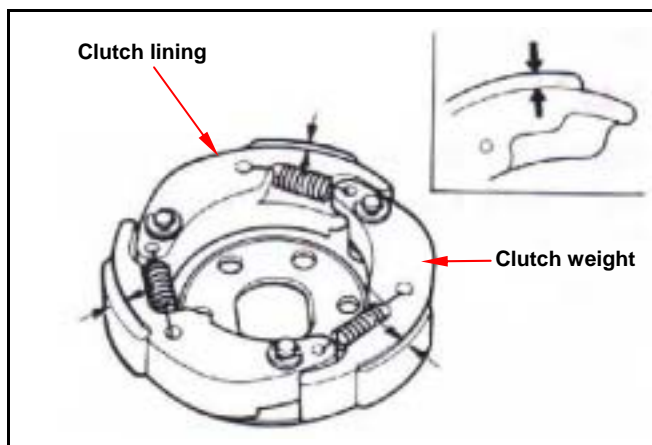

### Driven pulley spring

Measure the length of driven pulley spring. Replace it if exceeds service limit.

**Service limit: 97.4 mm**

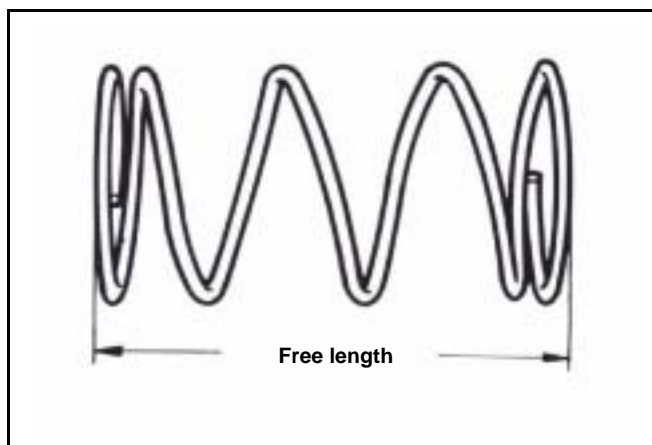

### Driven pulley

Check following items:

- If both surfaces are damaged or worn.
- If guide pin groove is damaged or worn.

Replace damaged or worn components.

Measure the outer diameter of driven face and the inner diameter of movable driven face. Replace it if exceeds service limit.

**Service limit: Outer diameter 40.93 mm**

**Inner diameter 41.07 mm**

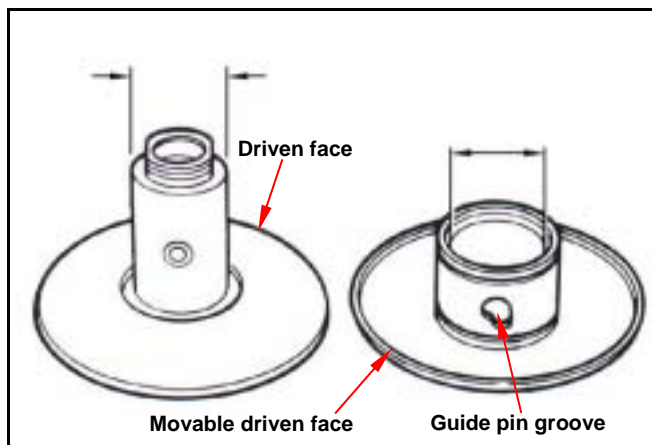

### Driven Pulley Bearing Inspection

Check if the inner bearing oil seal is damage.

Replace it if necessary.

Check if needle bearing is damage or too big clearance. Replace it if necessary.

Rotate the inside of inner bearing with fingers to check if the bearing rotation is in smooth and silent.

Check if the bearing outer parts are closed and fixed.

Replace it if necessary.

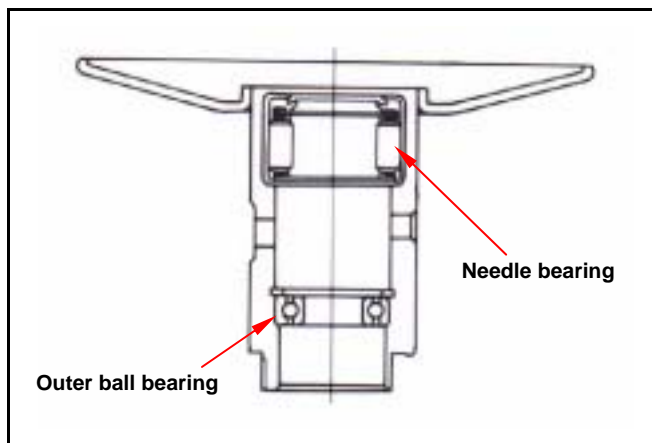

## 8. V-BELT DRIVING SYSTEM

### Clutch weight Replacement

Remove snap ring and washer, and then remove clutch weight and spring from driving plate.

#### Caution

Some of models are equipped with one mounting plate instead of 3 snap rings.

Check if spring is damage or insufficient elasticity.

Check if shock absorption rubber is damage or deformation. Replace it if necessary. Apply with grease onto setting pins.

Install new clutch weight onto setting pin and then push to the specified location. Apply with grease onto setting pins. But, the clutch block should not be greased. If so, replace it.

#### Caution

Grease or lubricant will damage the clutch weight and affect the block's connection capacity.

Install the spring into groove with pliers.

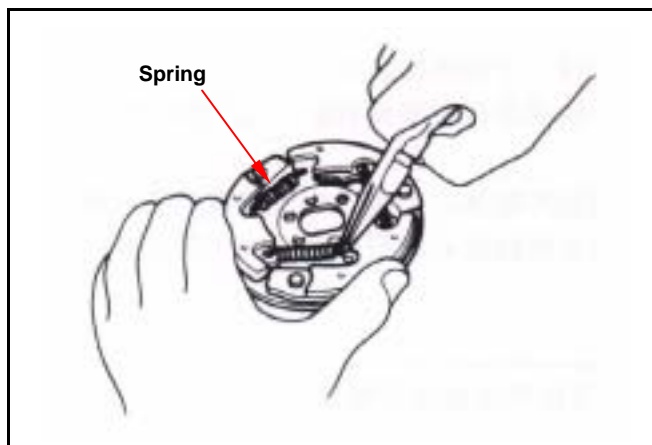
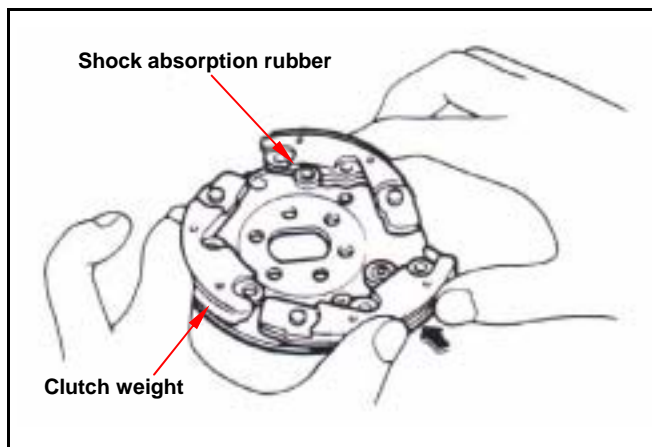
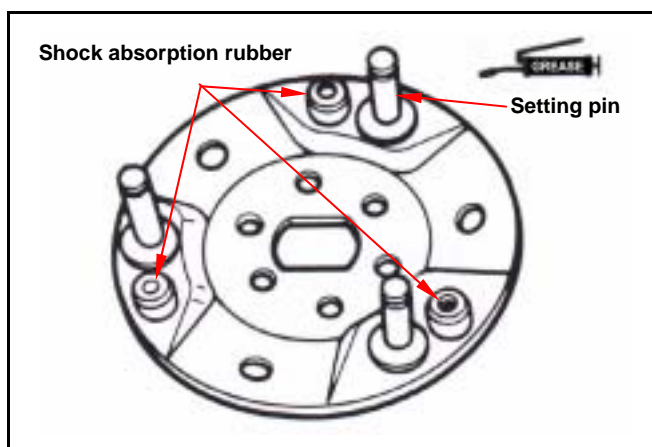
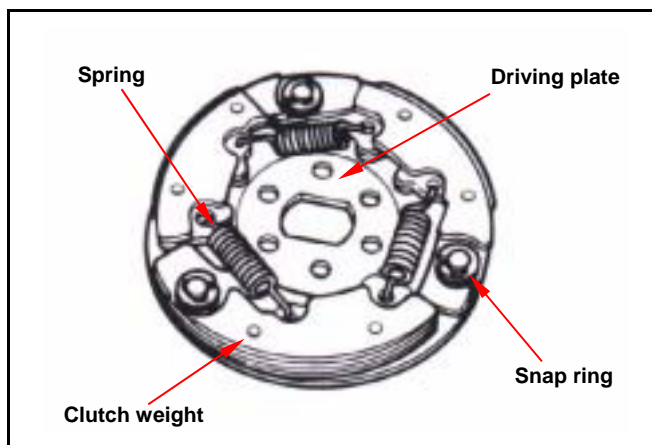

Install snap ring and mounting plate onto setting pin.

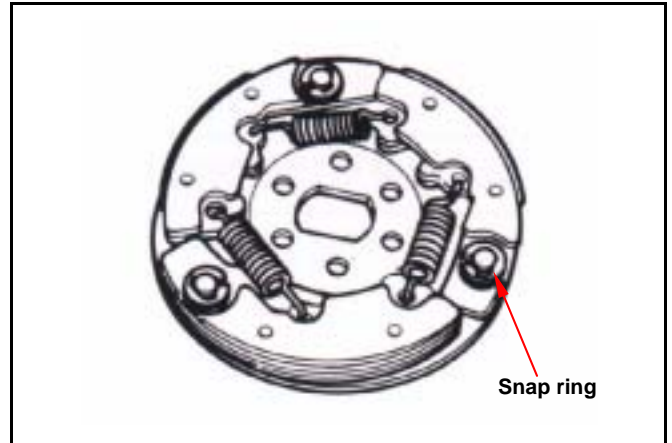

### Replacement of Driven Pulley Bearing

Remove inner bearing.

#### Caution

- If the inner bearing equipped with oil seal on side in the driven pulley, then remove the oil seal firstly.
- If the pulley equipped with ball bearing, it has to remove snap ring and then the bearing.

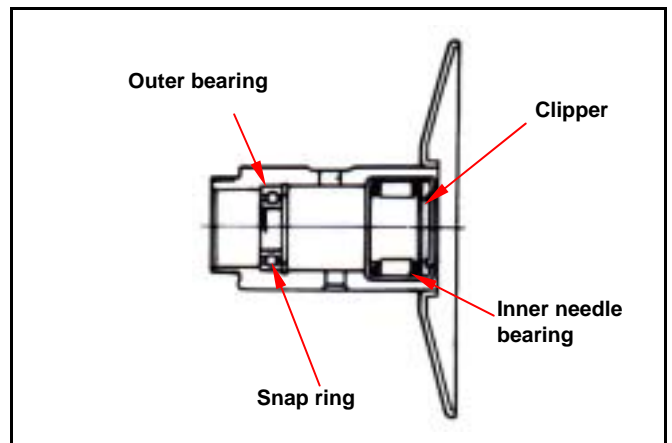

Remove snap ring and then push bearing forward to other side of inner bearing.

Place new bearing onto proper position and its sealing end should be forwarded to outside.

Apply with specified oil.

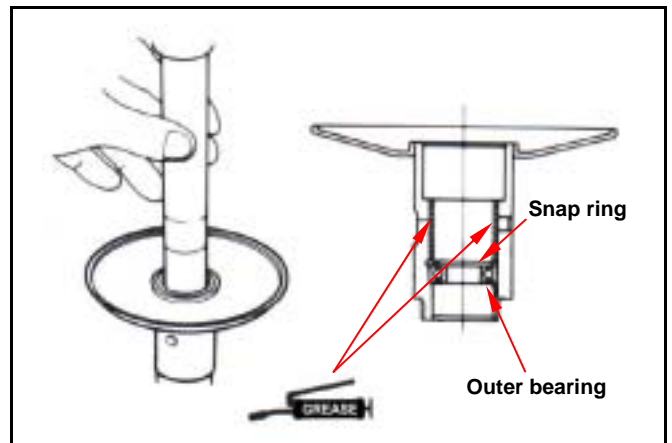

Install new inner bearing.

#### Caution

- Its sealing end should be forwarded to outside as bearing installation.
- Install needle bearing with hydraulic presser. Install ball bearing by means of hydraulic presser.

Install snap ring into the groove of drive face.

Align oil seal lip with bearing, and then install the new oil seal (if necessary).

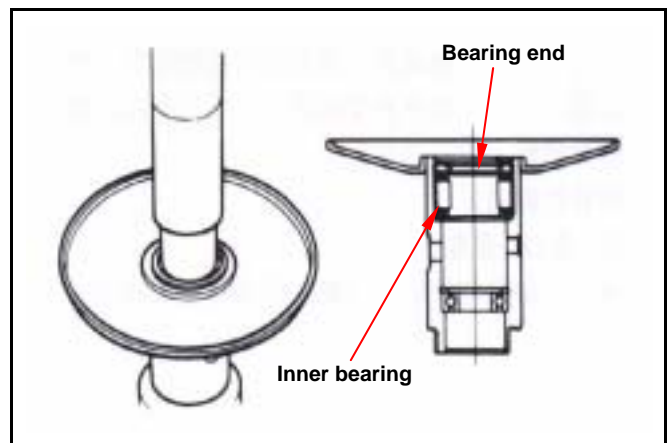

## 8. V-BELT DRIVING SYSTEM

### Installation of Clutch OUTER/Driven Pulley Assembly

Install new oil seal and O-ring onto movable driven face.

Apply with specified grease to lubricate the inside of movable driven face.

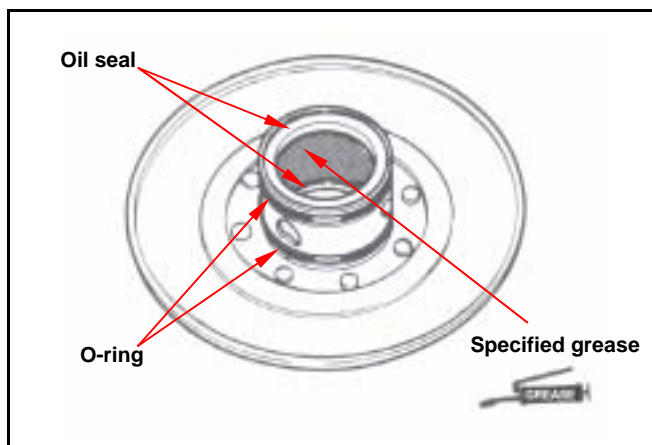

Install the movable driven face onto driven face.  
Install the guide pin and guide pin roller.

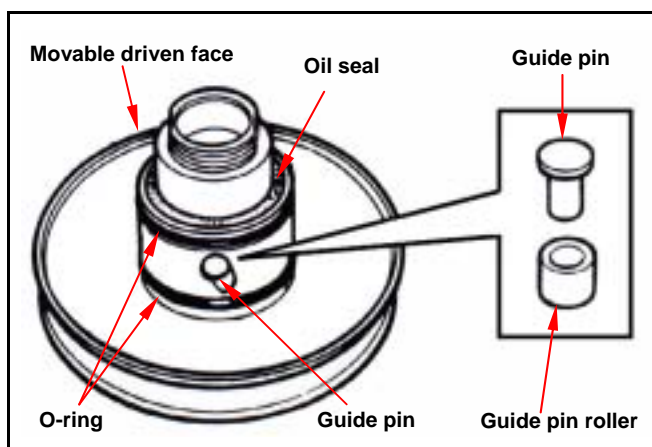

Install the collar.

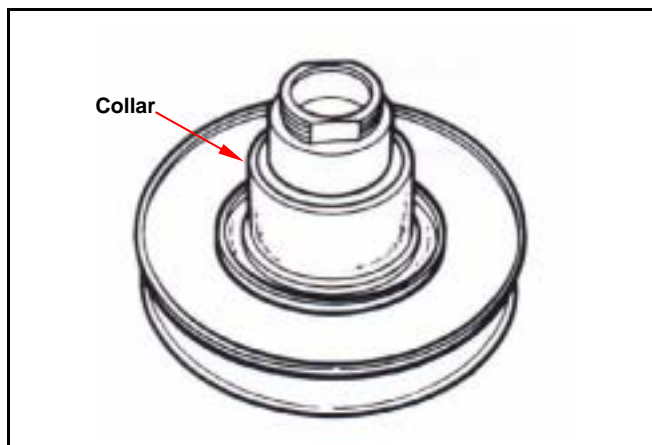

Install friction plate, spring and clutch weight into clutch spring compressor, and press down the assembly by turning manual lever until mounting nut that can be installed.

Hold the compressor by bench vise and tighten the mounting nut to specified torque with clutch nut wrench.

Remove the clutch spring compressor.

**Torque value: 5.0~6.0kgf-m**

Install clutch outer/driven pulley and drive belt onto drive shaft.

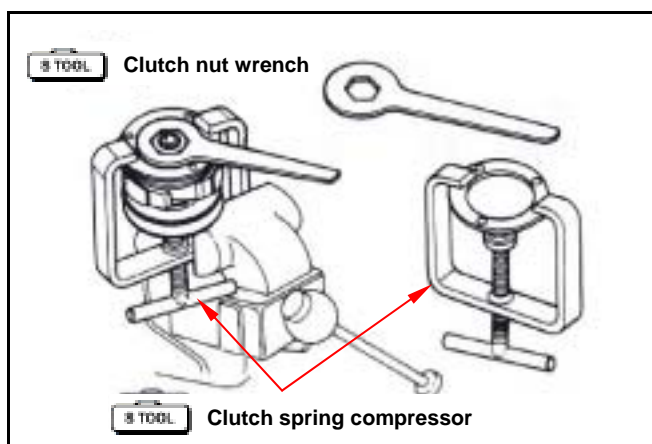

# 9. FINAL DRIVING MECHANISM

<p><b>Mechanism Diagram - transmission cover</b> ..... 9-1</p> <p><b>Precautions in operation</b> ..... 9-2</p> <p><b>Trouble Diagnosis</b> ..... 9-2</p> <p><b>Disassembly of Transmission</b> ..... 9-3</p>	<p><b>Inspection of Mission Mechanism</b> .... 9-6</p> <p><b>Bearing Replacement</b> ..... 9-8</p> <p><b>Re-assembly of Final Driving Mechanism</b> ..... 9-11</p>
---	--

## Mechanism Diagram - transmission cover

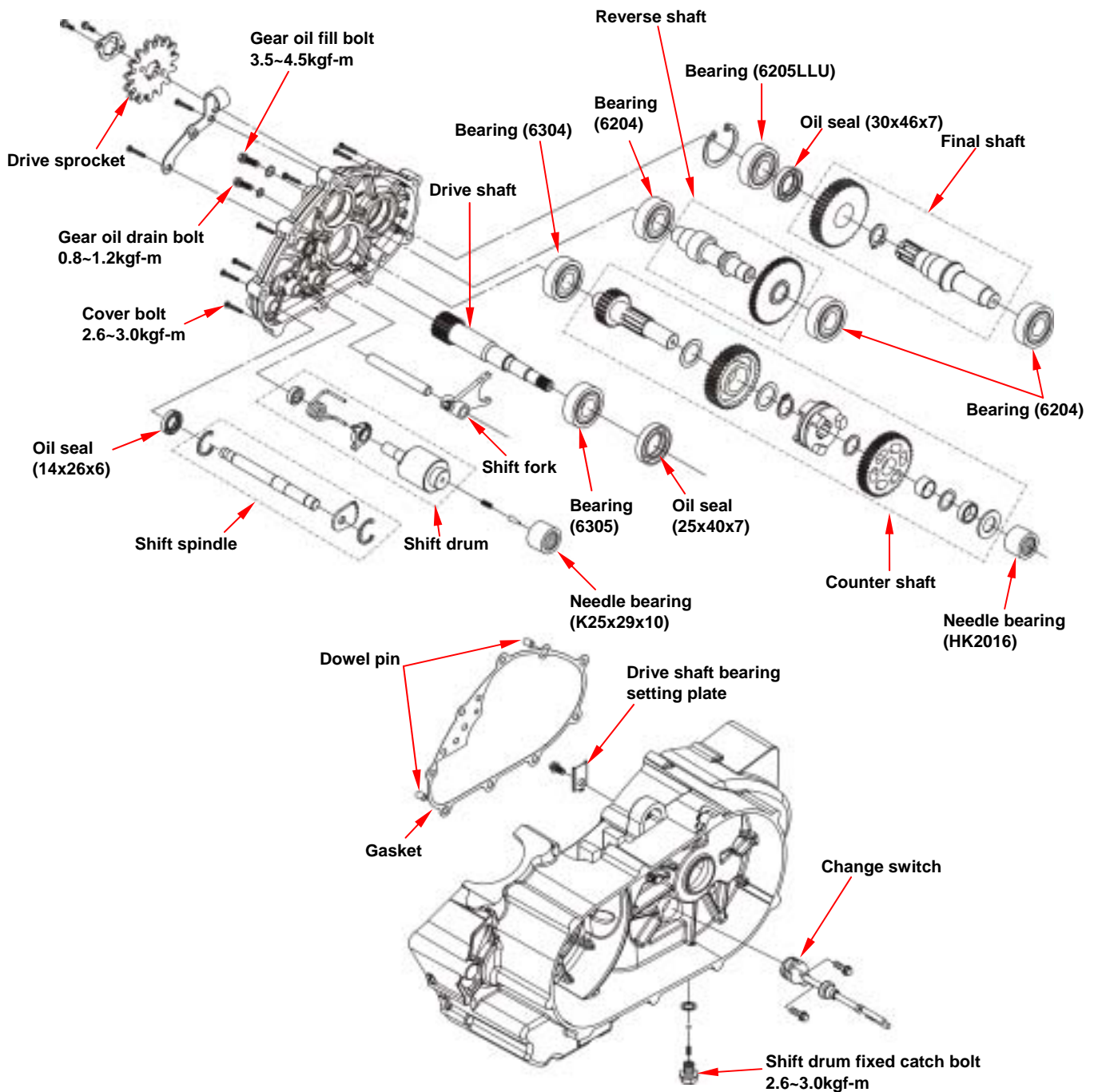

## 9. TRANSMISSION

### Precautions in operation

#### Specification

Application oil: scooter gear oil

Recommended oil: KING MATE serial gear oils

Oil quantity: 750c.c. (650c.c. when replacing)

Item	Standard value	Limit (mm)
OD of shift fork shaft	11.982~12.000 mm	11.970 mm
ID of shift fork	12.016~12.043 mm	12.010 mm
Shift fork claw thickness	5.930~6.000 mm	5.730 mm

#### Torque value

Gear box cover 2.6~3.0kgf-m

Gear oil drain bolt 1.1~1.5kgf-m

Gear oil fill bolt 3.5~4.5kgf-m

#### Tools

##### Special tools

Bearing driver (6204): SYM-9110400

Bearing driver (6205LLU): SYM-9100400-HMA

Bearing driver (6305): SYM-9100400-RB1

Needle bearing driver (HK2016): SYM-9100300-RB1

Drive shaft and oil seal driver: SYM-9120200-HMA

Drive shaft puller: SYM-2341100

Inner bearing puller: SYM-6204002

### Trouble Diagnosis

#### Engine can be started but motorcycle can not be moved.

- Damaged drive gear
- Burnt out drive gear
- Damaged gear shift system

#### Noise

- Worn or burnt gear
- Worn gear

#### Gear oil leaks

- Excessive gear oil.
- Worn or damage oil seal

### Disassembly of Transmission

Remove gear change lever (1 bolt).



Loosen speedometer cable mounting nut, and then remove the cable.  
Remove 3 bolts and remove drive chain protector. Turn the socket bolt clockwise, and then remove speedometer gear box.

#### Caution

The socket bolt is provided with left turn thread.

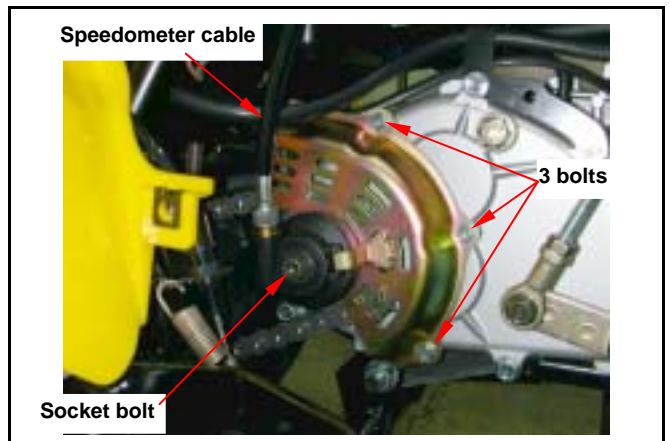

Remove 2 bolts, and then remove the drive sprocket fixing plate, drive chain and drive sprocket.

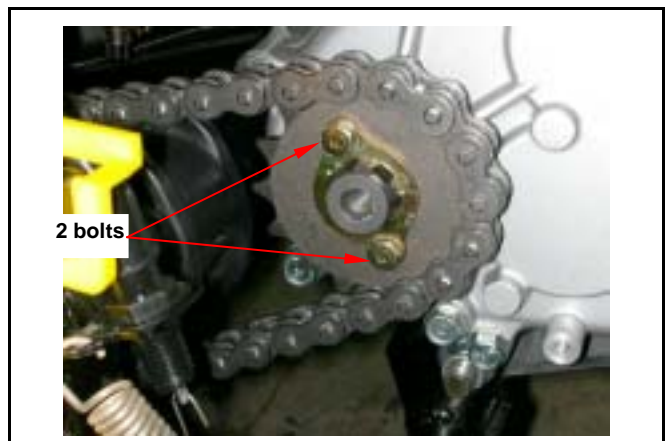

Remove gear fill bolt.  
Place an oil pan under the ATV, and remove gear oil drain bolt.  
After drained, make sure washer can be re-used.  
Install oil drain bolt.

#### Torque value:

**Gear oil fill bolt**            3.5~4.5kgf-m  
**Gear oil drain bolt**        1.1~1.5kgf-m

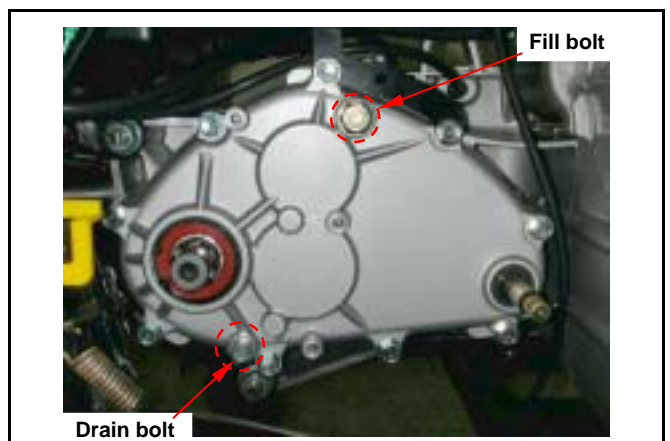



## 9. TRANSMISSION

Remove gear box cover bolts (9 bolts) and then remove the cover.

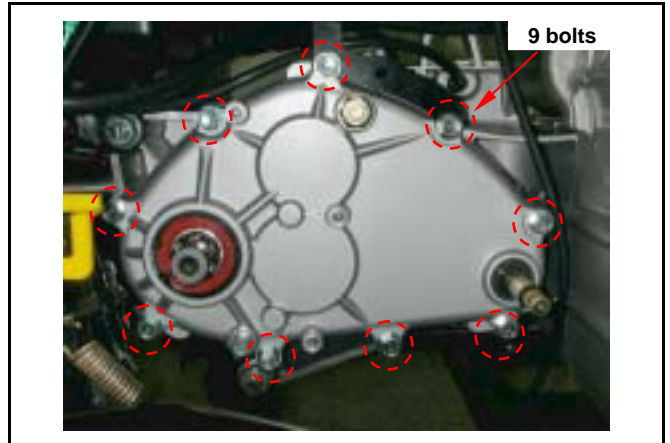

Remove shift drum catch ball, spring and bolt.

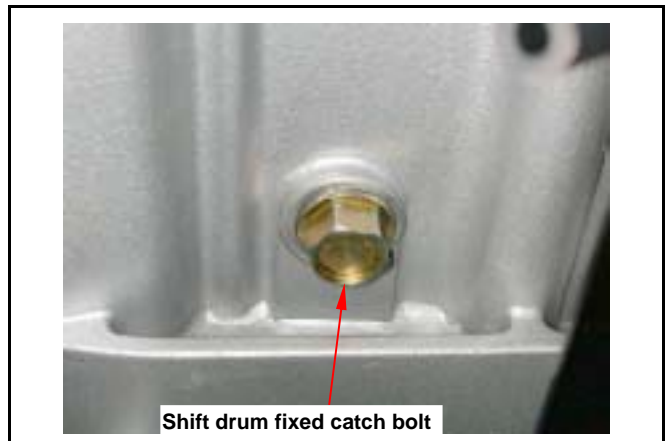

Remove shift spindle, shift fork shaft, shift fork and shift drum.

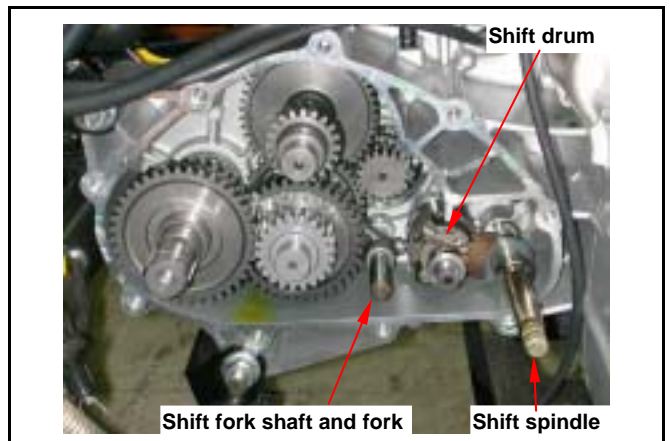

Remove final shaft, counter shaft and reverse shaft.

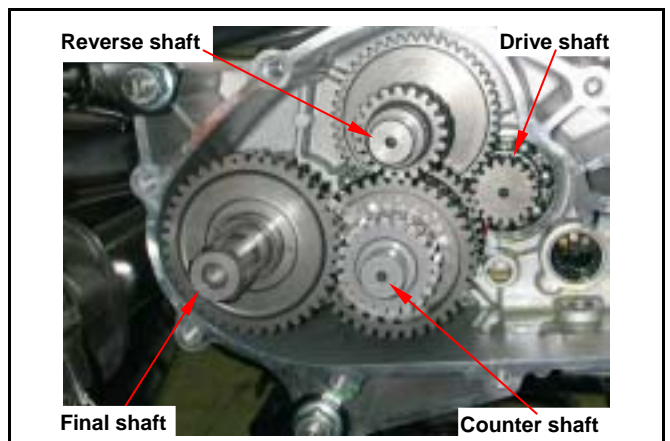

Remove drive shaft bearing setting plate (1 bolt).

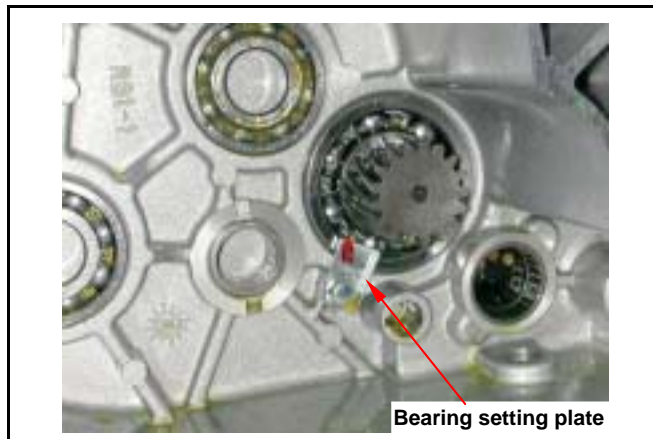

Remove the drive shaft.

**Special tool:**

**Shaft protector**

Remove gasket and dowel pin.

**⚠ Caution**

- If non- essential do not remove the drive shaft from the case upper side.
- If remove the drive shaft from the gear box, then its bearing and oil seal has to be replaced.

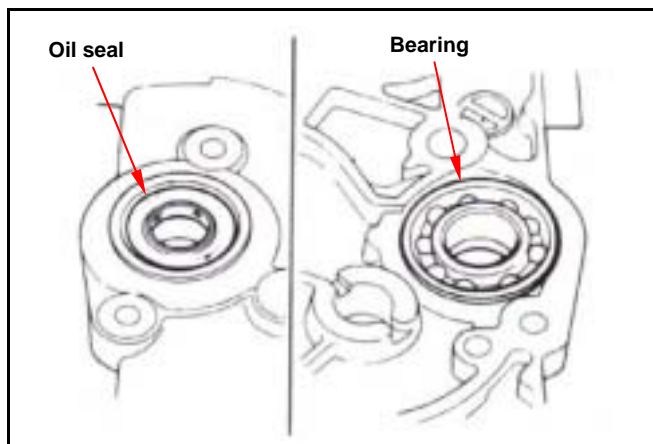

## 9. TRANSMISSION

### Inspection of Mission Mechanism

Check if the shift spindle is wear or damage.



Check if the shift drum is wear or damage.



Check if the shift fork and shaft is wear or damage. Measure the outer diameter of shift fork shaft, and replace it if it exceed service limit.

**Service limit: 11.970 mm**

Measure the inner diameter of shift fork, and replace it if it exceed service limit.

**Service limit: 12.010 mm**

Measure the claw thickness of shift fork, and replace it if it exceed service limit.

**Service limit: 5.730 mm**



Check if the counter shaft is wear or damage.



Check if the reverse shaft is wear or damage.



Check if the final shaft and gear are burn, wear or damage.



Check bearings on gear box and gear box cover. Rotate each bearing's inner ring with fingers. Check if bearings can be turned in smooth and silent, and also check if bearing outer ring is mounted on gear tightly. If bearing rotation is uneven, noising, or loose bearing mounted, then replace it. Check oil seal for wear or damage, and replace it if necessary.

**⚠ Caution**

- If remove the drive shaft from the crankcase upper side, then its bearing has to be replaced.

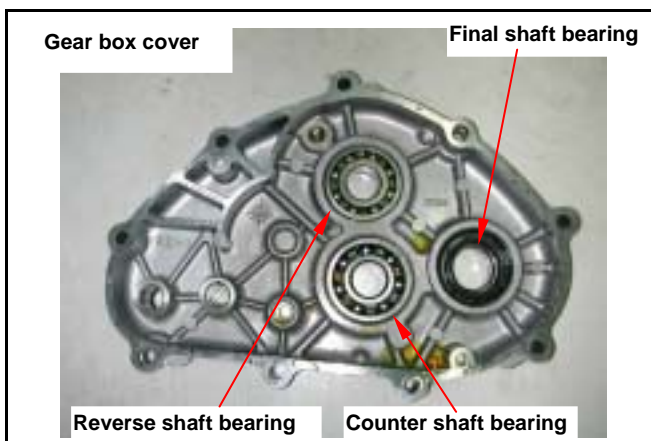
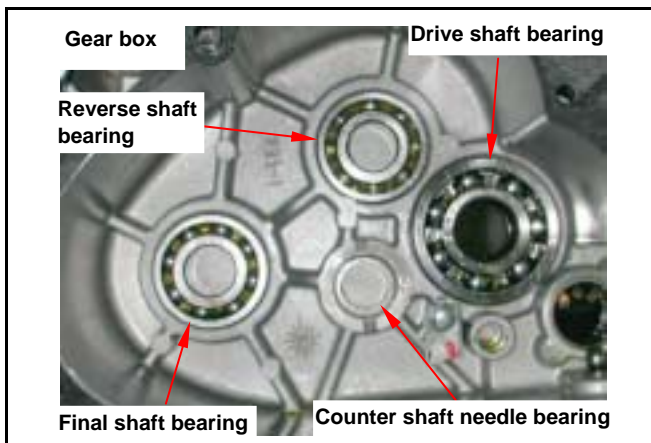

## 9. TRANSMISSION

### Bearing Replacement

#### Caution

- Never install used bearings. Once bearing removed, it has to be replaced with new one.

#### Crankcase side

Remove drive shaft bearing setting plate, and then remove drive shaft bearing from left crankcase using following tools.

Remove reverse shaft bearing and counter shaft bearing from left crankcase using following tools.  
Remove drive shaft oil seal.

#### Special tool:

#### Inner bearing puller

Install new final shaft, counter shaft and reverse shaft bearings into left crankcase.

#### Special tool:

#### Bearing driver (6204)

#### Needle bearing driver (HK2016)

Install new drive shaft bearings and bearing driver into left crankcase.

Install the universal bearing puller and bearing driver.  
Turn the universal bearing puller to install drive shaft bearing.

#### Special tool:

#### Bearing driver (6305)

#### Universal bearing puller

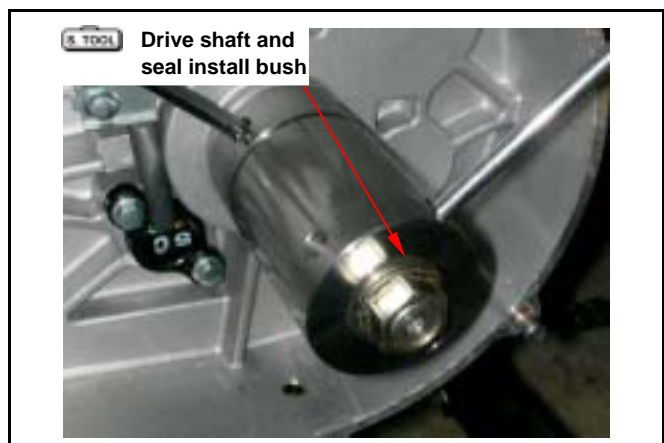
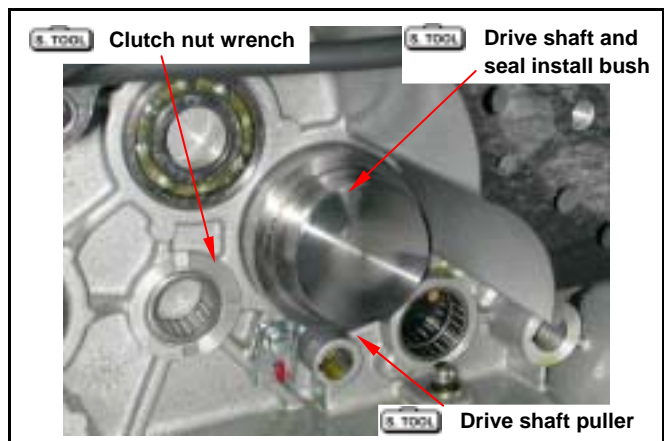
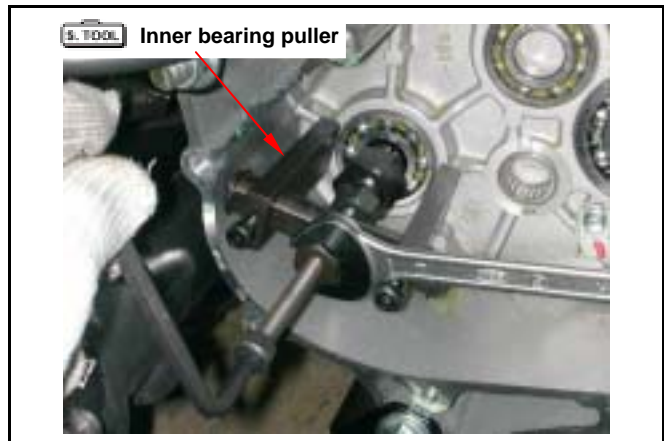

## 9. FINAL DRIVING MECHANISM

Install drive shaft.

**Special tool:**

Drive shaft puller

Drive shaft and oil seal install bush

Clutch nut wrench

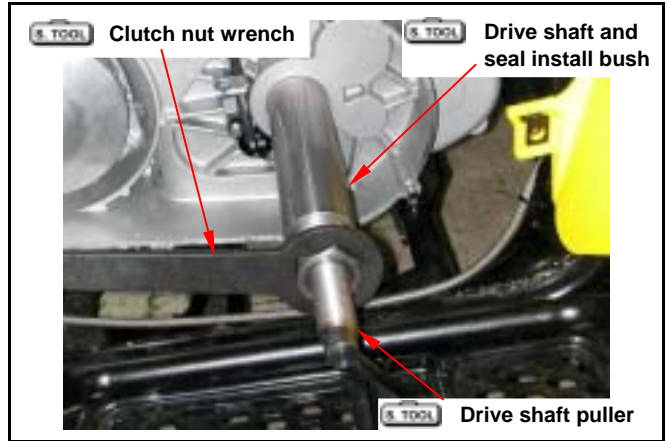

Apply with grease onto new drive shaft oil seal lip, and then install the oil seal.

**Special tool:**

Drive shaft and oil seal install bush

Install drive shaft bearing setting plate (1 bolt).



### Gear box side

Use inner bearing puller to remove the final shaft needle bearing, gear shift shaft bearing and counter shaft bearing from the cover inner side.

**Special tool:**

Inner bearing puller

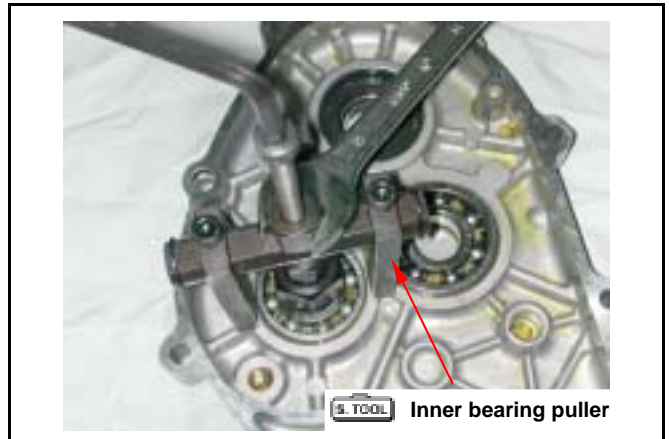

Remove cir clip of final shaft out side bearing.

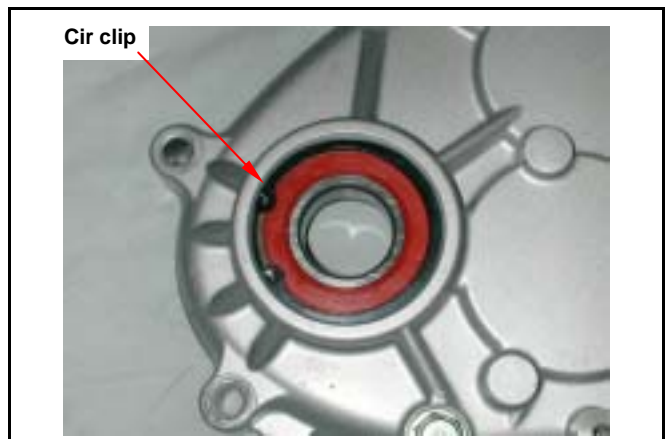

## 9. TRANSMISSION

Remove final shaft out side bearing.

**Special tool:**

**Inner bearing puller**

Remove oil seal from gear box cover and discard the seal

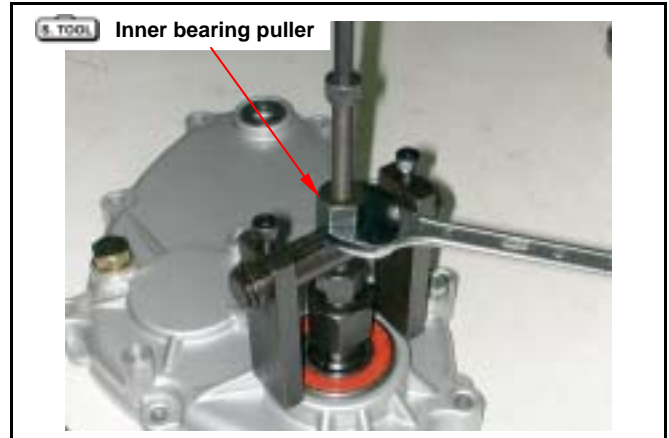

Install new bearing and bearing driver into gear box cover outer side.

Install the universal bearing puller and bearing driver.

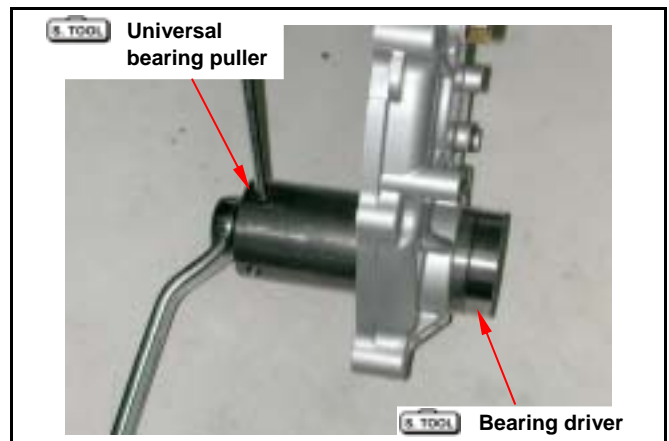

Turn the universal bearing puller to install drive shaft bearing.

**Special tool:**

**Bearing driver (6205)**

**Universal bearing puller**

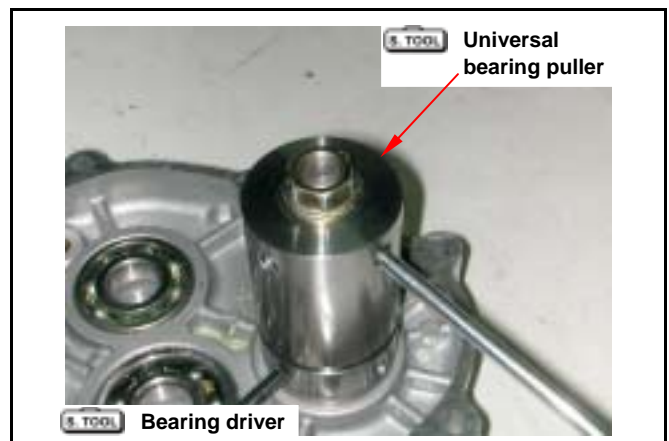

Install new oil seal and bearing driver into gear box cover inner side.

Install the universal bearing puller and bearing driver.

Turn the universal bearing puller to install drive shaft oil seal.

**Special tool:**

**Bearing driver (6205)**

**Universal bearing puller**



### Re-assembly of Final Driving Mechanism

Apply with grease onto the oil seal lip of final driving shaft.



Install counter shaft, reverse shaft and final shaft onto gear box.

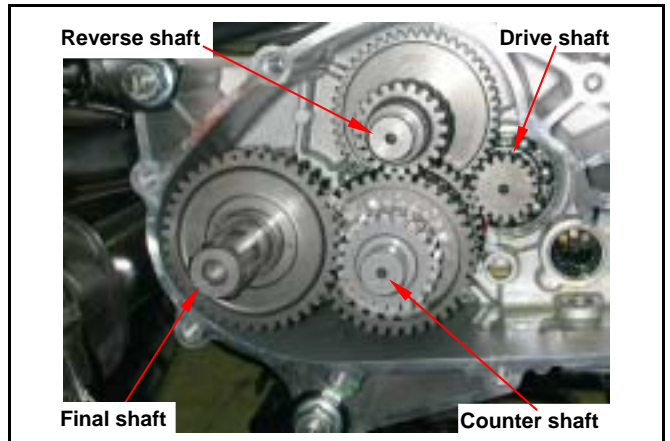

Install shift drum, shift fork and fork shaft onto gear box.

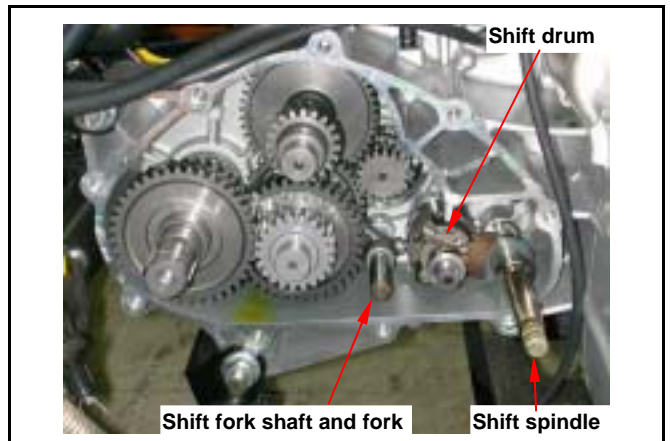

Install shift drum fixed catch ball, spring and bolt onto gear box.

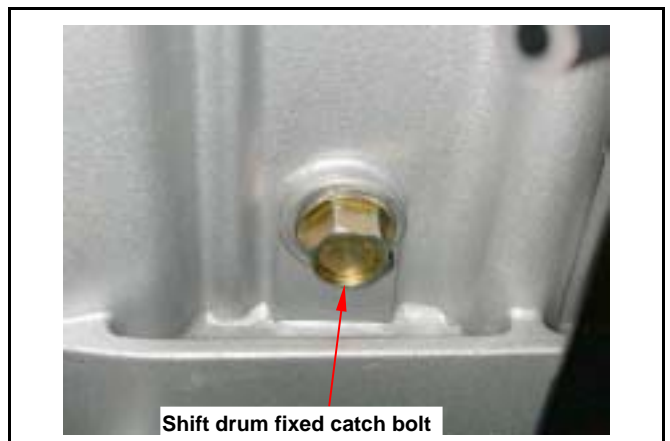



## 9. TRANSMISSION

Align the position mark on the shift spindle sprocket with that of shift drum, and then install shift spindle.

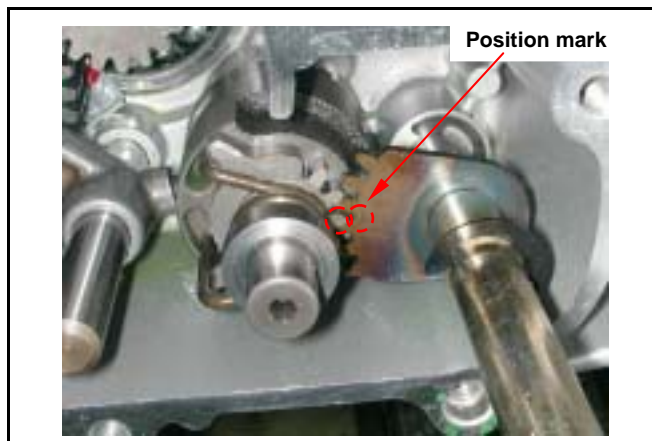

Install dowel pins and new gasket.

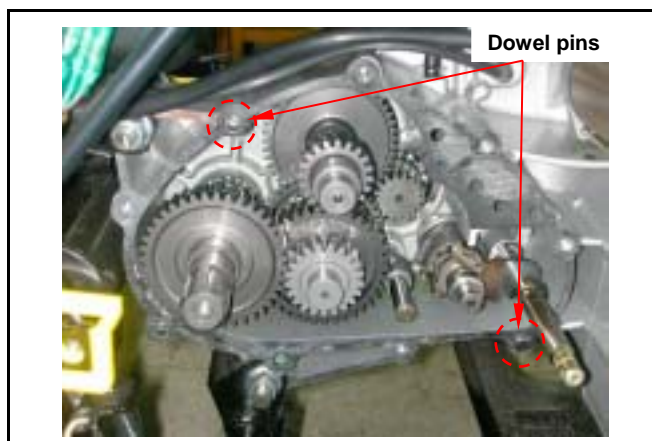

Install gear box cover and bolts, and tighten.  
**Torque value: 1.0~1.4kgf-m**

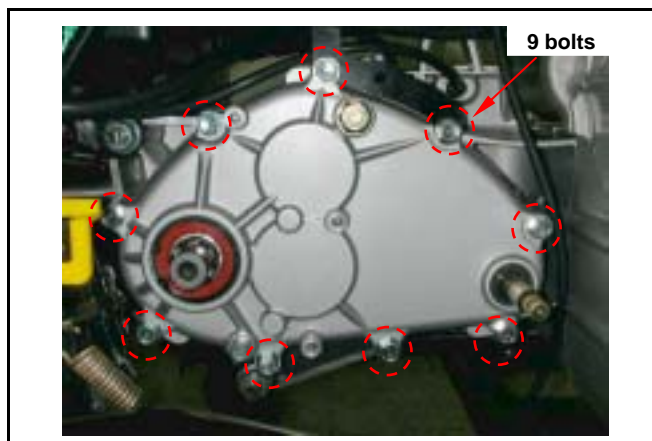

Install the shift spindle bracket, drive chain protector, speedometer gear box and gear change lever.

Add gear oil.

**Gear oil quantity: 750c.c.**



# 10. ALTERNATOR/STARTING CLUTCH

Mechanism Diagram .....	10-1	Flywheel Removal .....	10-4
Precautions in Operation .....	10-2	Starting Clutch .....	10-5
Right Crankcase Cover Removal .....	10-3	Flywheel Installation .....	10-7
A.C.G. Set Removal .....	10-3	A.C.G. Set Installation .....	10-8
Right Cover Bearing .....	10-3	Right Crankcase Cover Installation .....	10-8

## Mechanism Diagram

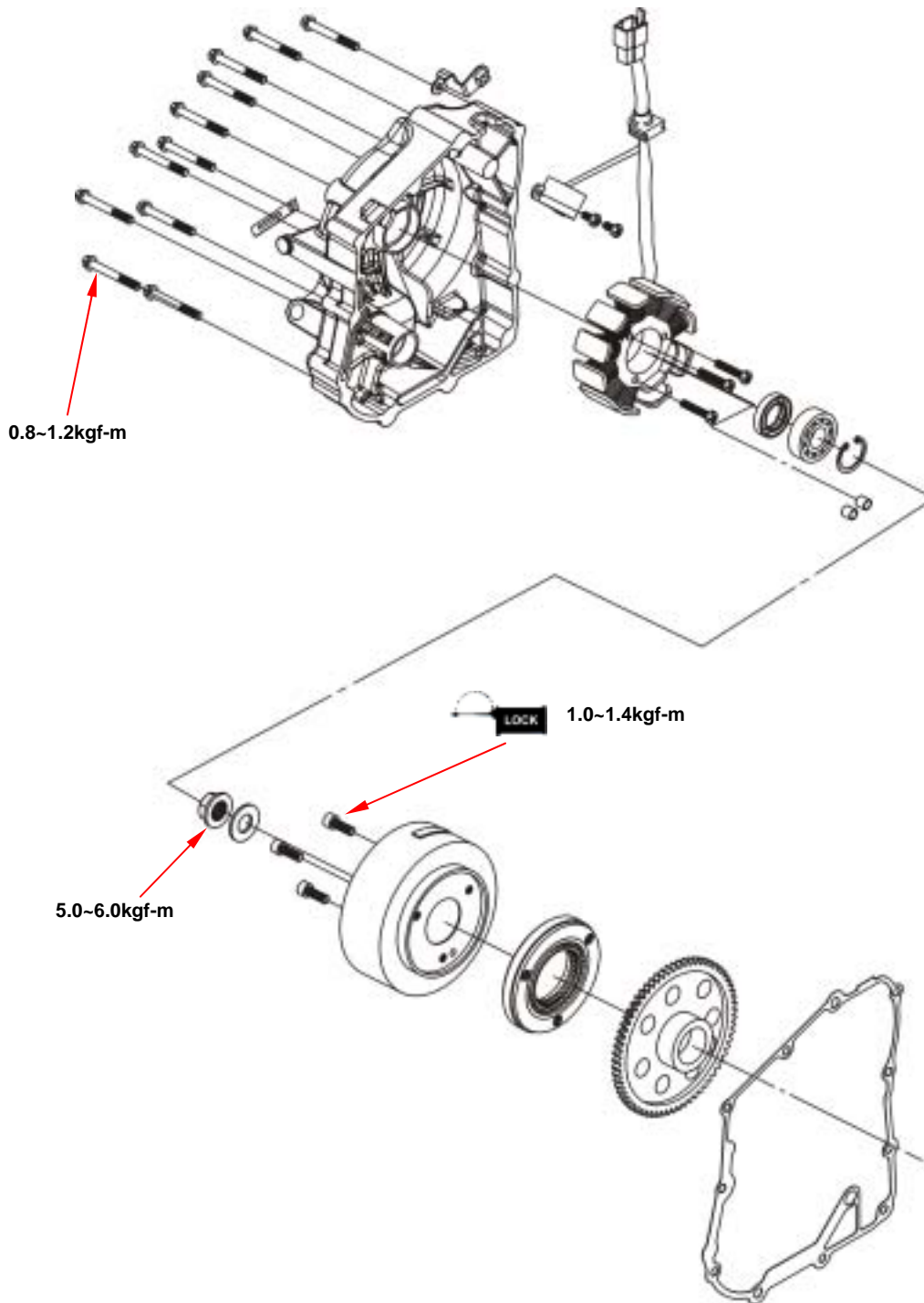

## 10. ALTERNATOR/STARTING CLUTCH

### Precautions in Operation

#### General information

- Refer to chapter 17: The troubleshooting and inspection of alternator
- Refer to chapter 17: The service procedures and precaution items of starter motor

#### Specification

Item	Standard value (mm)	Limit (mm)
ID of starting clutch gear	25.026~25.045	25.050
OD of starting clutch gear	42.192~42.208	42.100

#### Torque value

Flywheel nut	5.0~6.0kgf-m
Starting clutch hexagon bolt	1.0~1.4kgf-m with adhesive
8 mm bolts	0.8~1.2kgf-m
12 mm bolts	1.0~1.4kgf-m

#### Tools

##### Special tools

A.C.G. flywheel puller: SYM-3110A00

Universal holder: SYM-2210100

### Right Crankcase Cover Removal

Remove left footrest.  
 Drain out the engine oil and coolant, and then remove coolant hoses.  
 Remove water pump cover (4 bolts).  
 Remove 11 bolts from the right crankcase cover.  
 Remove the right crankcase cover.  
 Remove dowel pin and gasket.

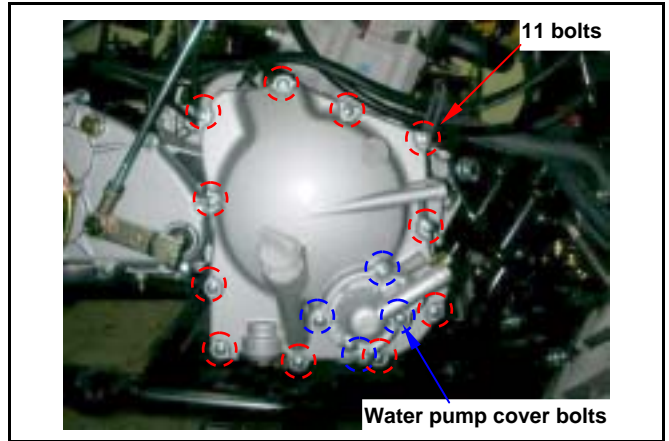

### A.C.G. Set Removal

Remove 2 mounted screws from pulse generator and then remove it.  
 Remove 3 screws from right crankcase cover and then remove generator coil set.

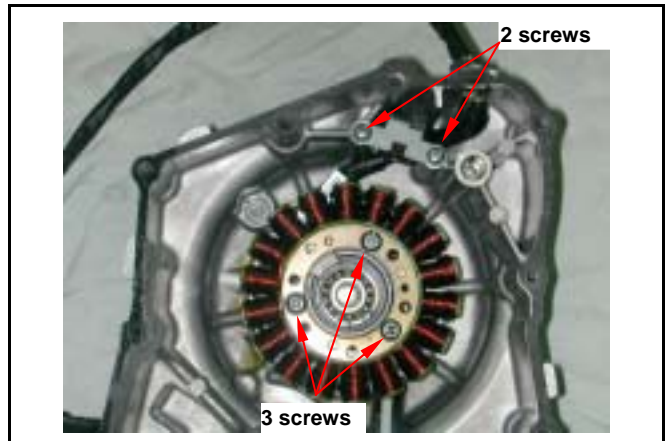

### Right Cover Bearing

#### Inspection

Rotate the bearing with finger to check if the bearing rotation is in smooth and silent.  
 Check if the bearing outer parts are closed and fixed. Replace it if necessary.

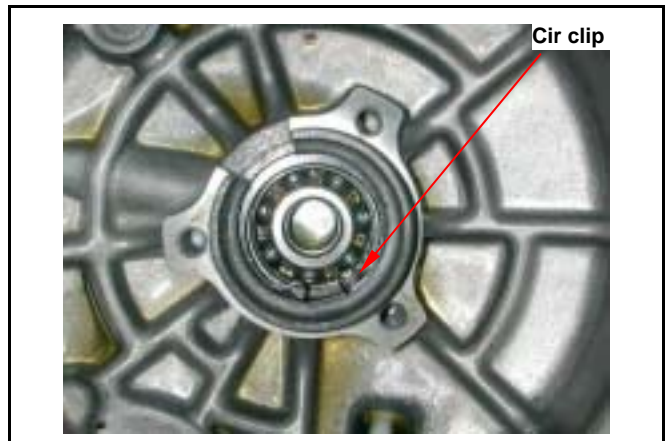

Remove the cir clip, and then remove bearing.

#### Special tool:

Inner bearing puller



## 10. ALTERNATOR/STARTING CLUTCH

Check the oil seal for wear or damage. Replace it if necessary.

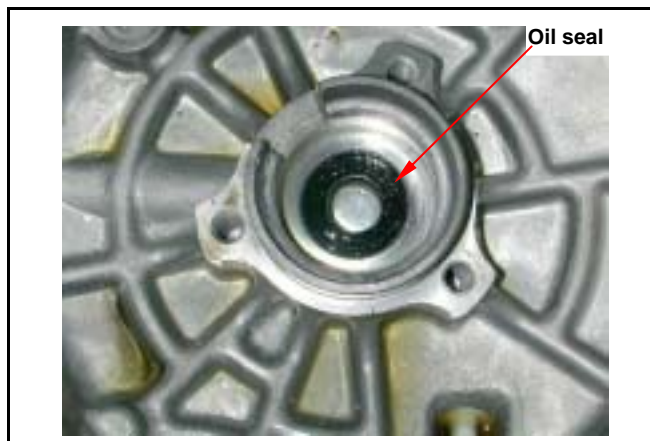

Install a new one bearing (6201LU) by bearing driver.

**Special tool:**  
**Bearing driver**

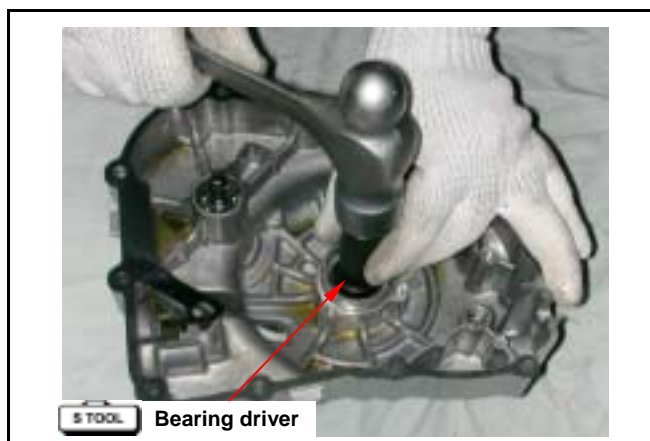

### Flywheel Removal

Remove right crankcase cover.

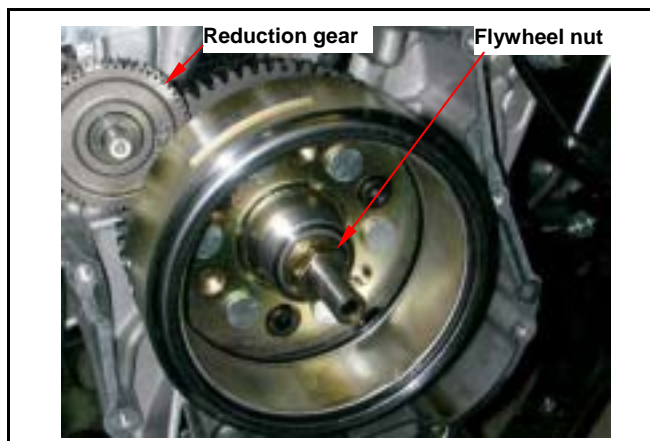

Remove left crankcase cover.  
Hold the flywheel by drive face with universal holder.

Remove flywheel nut.

**Special tool:**  
**Universal Holder**



Remove starter reduction gear and shaft.  
 Pull out flywheel with A.C.G. flywheel puller.

**Special tool:**

**A.C.G. Flywheel puller**

Remove flywheel and starting driven gear.



**Starting Clutch**

**Starting Clutch Inspection**

Remove starting clutch driven gear.  
 Check the gear for wear or damage.  
 Measure the ID and OD of the starting clutch driven gear.

**Service Limit: ID: 25.050 mm**  
**OD: 42.100 mm**

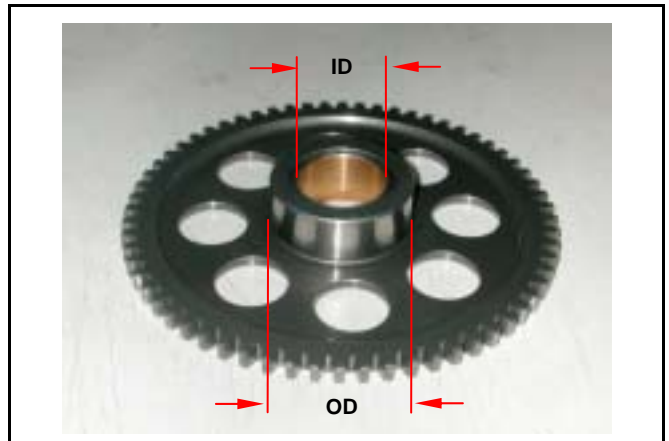

Check the starting reduction gear and shaft for wear or damage.



Check each roller for wear or damage.



## 10. ALTERNATOR/STARTING CLUTCH

Install starting clutch driven gear onto one way clutch.

Hold flywheel and rotate starting clutch gear.  
The starting clutch gear should be rotated in C.C.W direction freely, but not C.W direction.  
(View as shown in this figure.)



### One way clutch removal

Remove starting driven gear.

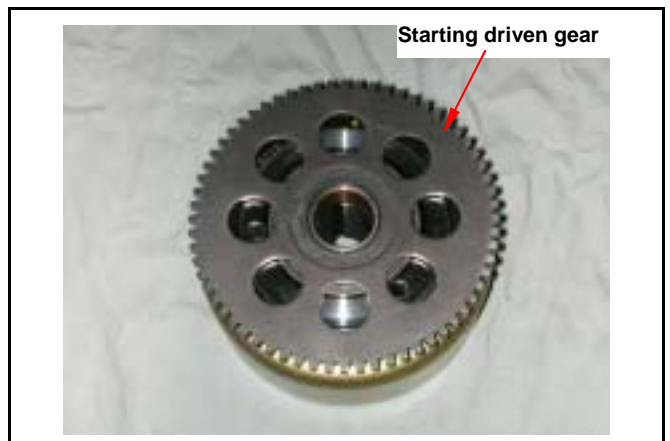

Remove 3 socket bolts, and then remove one way clutch.

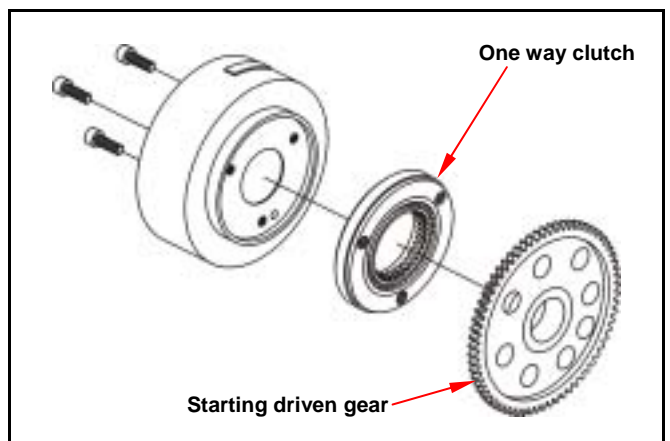
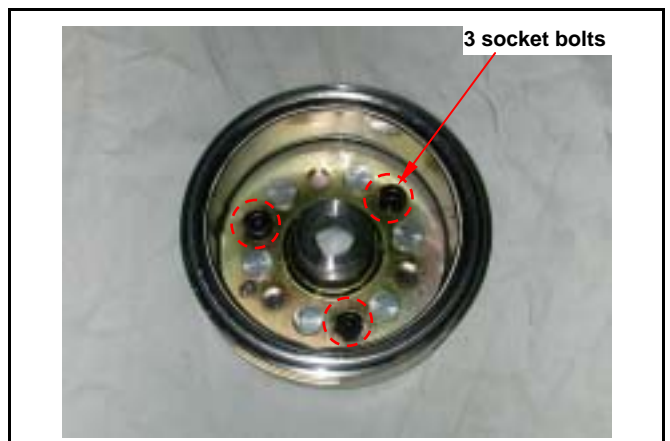

### One way clutch Installation

Install the components in the reverse procedures of removal.

#### Caution

Tape a tightening tape onto the thread of hexagon bolt.

**Torque value: 1.0~1.4kgf-m**

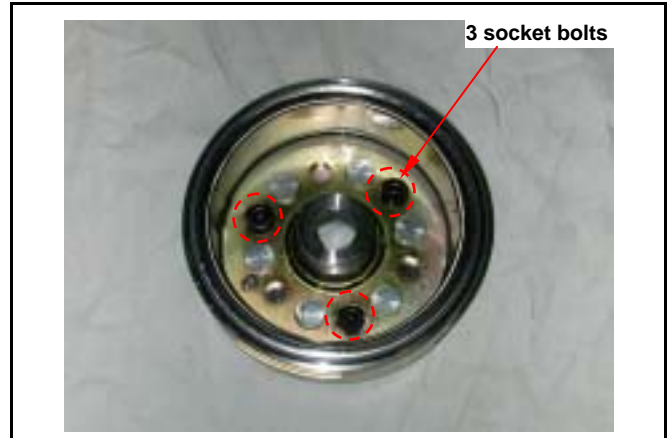

Install starting driven gear.

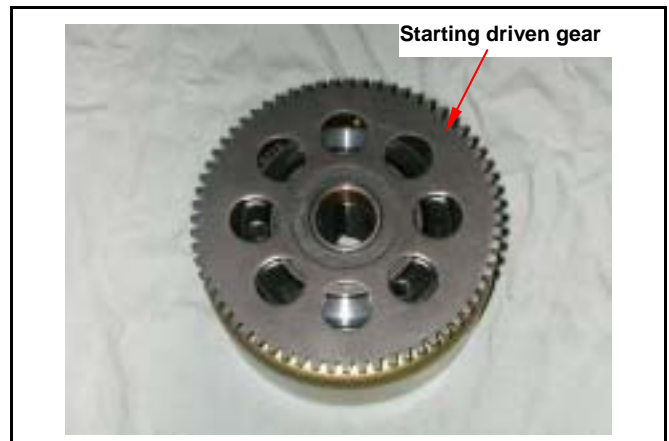

### Flywheel Installation

Align the key on crankshaft with the flywheel groove, and then install the flywheel.

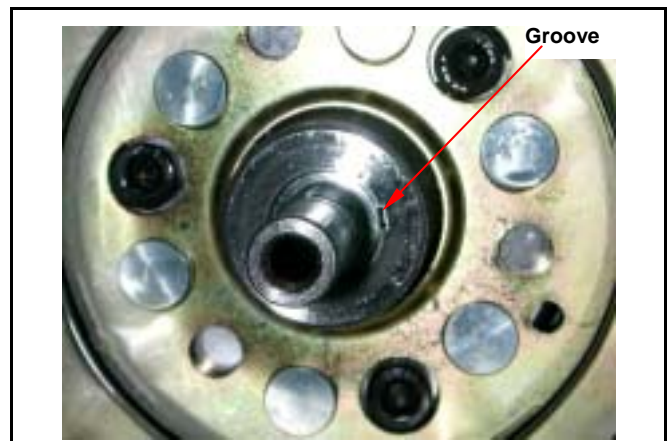

Hold the flywheel by drive face with universal holder, and tighten flywheel nut.

**Torque value: 5.0~6.0kgf-m**

**Special tool:**

**Universal Holder**





## 10. ALTERNATOR/STARTING CLUTCH

Install reduction gear shaft and reduction gear.

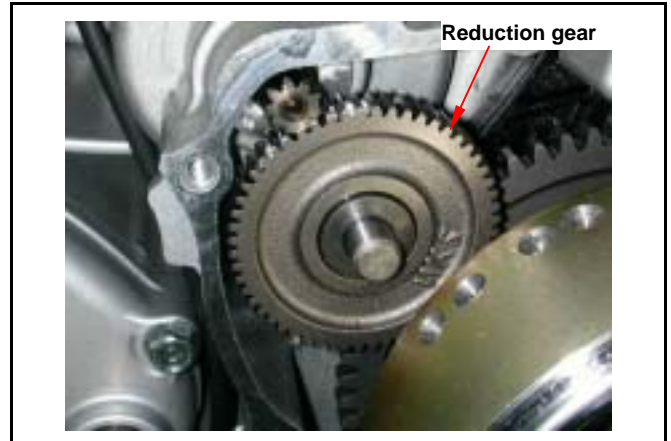

### A.C.G. Set Installation

Install the A.C.G. coil set onto right crankcase cover (3 screws).  
Install pulse generator (2 screws).  
Tie the wire harness securely onto the indent of crankcase.

#### Caution

Make sure that the wire harness is placed under pulse generator.

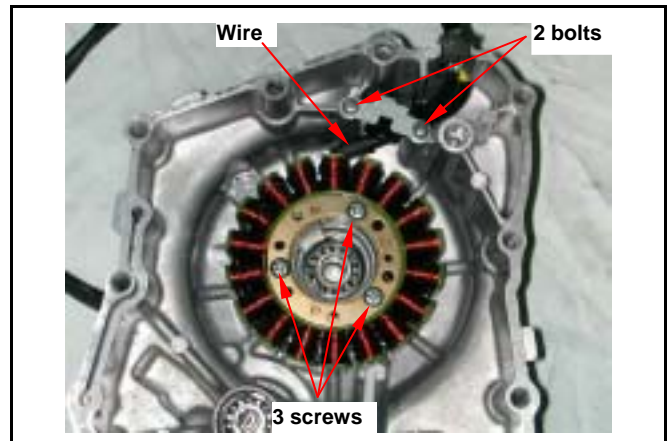

### Right Crankcase Cover Installation

Install dowel pin and new gasket.

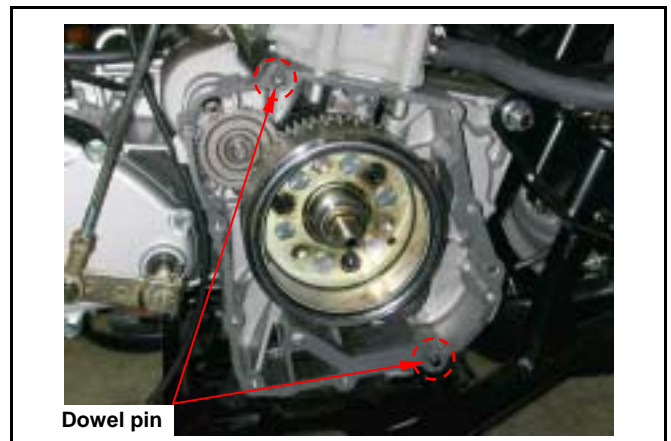

Remove water pump cover.  
Install right crankcase cover onto the crankcase.  
Note: Align the water pump shaft indent with the oil pump shaft.



## 10. ALTERNATOR/STARTING CLUTCH

Install right crankcase cover (11 screws).  
Install the dowel pin, new gasket and water pump cover onto crankcase cover.

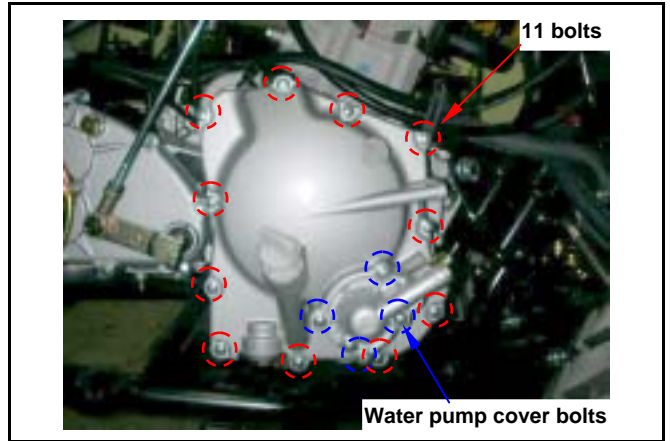

Connect water hoses to the right crankcase cover and water pump cover.



## 10. ALTERNATOR/STARTING CLUTCH

---



Note:

<a href="#">Mechanism Diagram .....11-1</a>	<a href="#">Disassembly of crankcase ..... 11-3</a>
<a href="#">General information .....11-2</a>	<a href="#">Crankshaft Inspection ..... 11-5</a>
<a href="#">Trouble diagnosis .....11-2</a>	<a href="#">Assembly of crankcase ..... 11-6</a>

## Mechanism Diagram

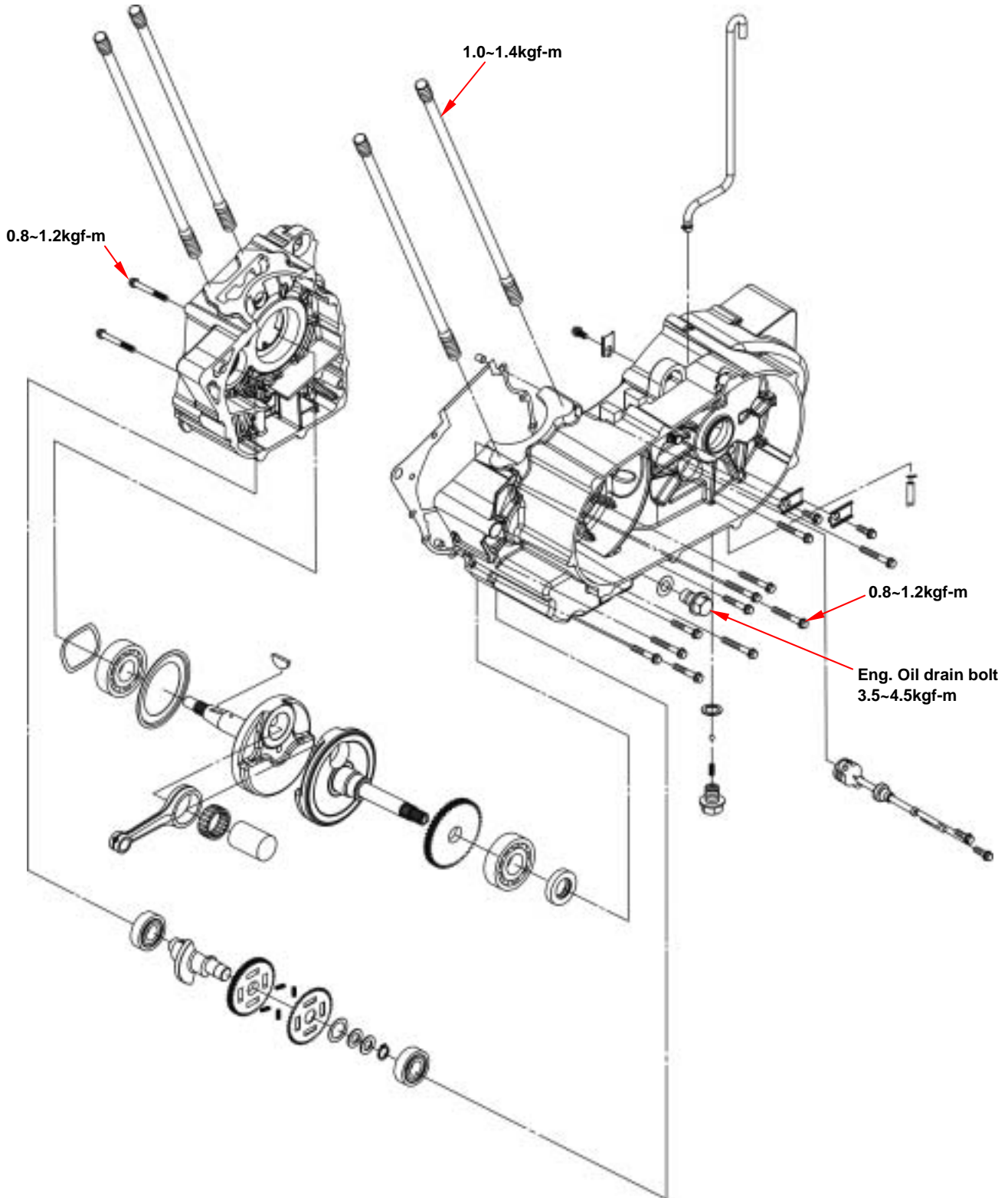

## 11. CRANKCASE / CRANK

### General information

#### Operational precautions

- This Section concerns disassembly of the crankcase for repair purpose.
- Remove following components before disassembling crankcase.
  - Engine remove Section 5
  - Cylinder head Section 6
  - Cylinder and piston Section 7
  - Drive face and driven pulley Section 8
  - AC generator/Start one way clutch Section 10
- In case it requires replacing the crankshaft bearing, the driving chain of engine oil pump or the timing chain, it is preferably to replace crankshaft as a unit.

#### Specification

Unit: mm

	Item	Standard	Limit
Crankshaft	Connecting rod side clearance of the big end	0.100~0.400	0.600
	Vertical clearance of the big end of the connecting rod	0~0.008	0.050
	Run-out	-	0.100

#### Torque value

Bolts for crankcase	0.8~1.2kgf-m
Engine oil drain bolt	3.5~4.5kgf-m
Cylinder stud bolt	1.0~1.4kgf-m

#### Tools

##### Special tools

L. crank shaft oil seal driver (27\*42\*7): SYM-1332100-HMA

### Trouble diagnosis

#### Engine noise

- Loose crankshaft bearing
- Loose crankshaft pin bearing
- Worn out piston pin and pin hole

## Disassembly of crankcase

Remove the cam chain setting plate, and then remove cam chain.  
Loosen the pivot bolt and remove the tensioner.

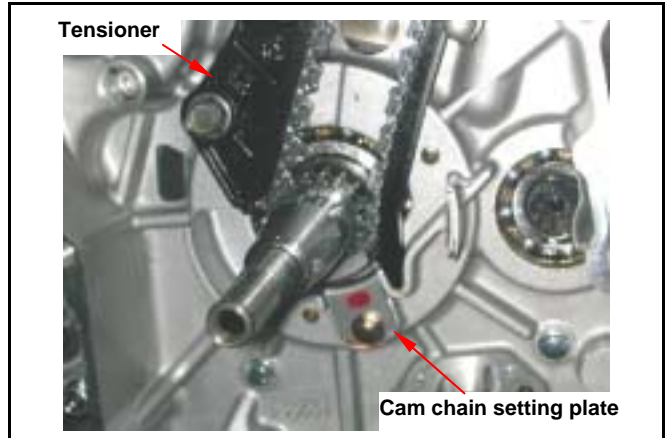

Loosen 2 bolts on the right crankcase.

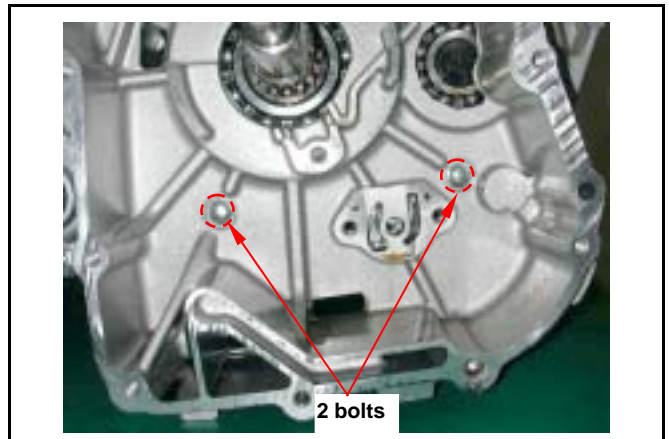

Loosen 11 bolts on the left crankcase.

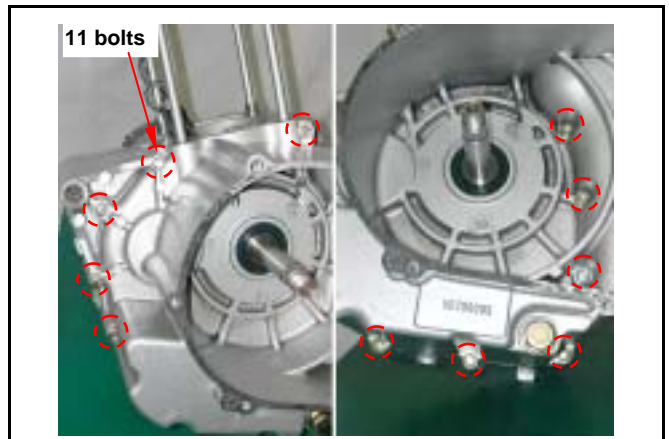

Place right crankcase downward and left crankcase up.  
Tap the left crankcase with a plastic hammer to remove it.

**⚠ Caution**

Care should be taken not to damage the contact surfaces.



## 11. CRANKCASE / CRANK

Remove balance shaft from right crankcase.

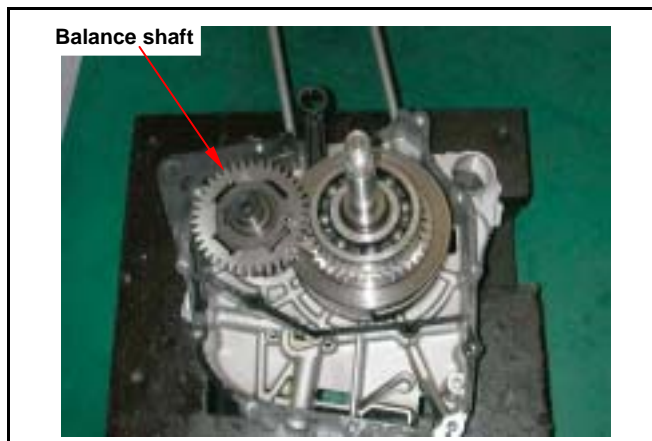

Remove crankshaft from right crankcase.



Remove gasket and dowel pins.  
Scrape gasket residues off the crankcase contact surface.

**Caution**

Do not damage contact surface of the gasket.  
It is better to moisten the gasket residue for  
easy scrapping.



Drive out left crankcase oil seal.



### Crankshaft Inspection

Use a thickness gauge to measure left and right clearance of connecting rod big end.

**Service limit: 0.6 mm**

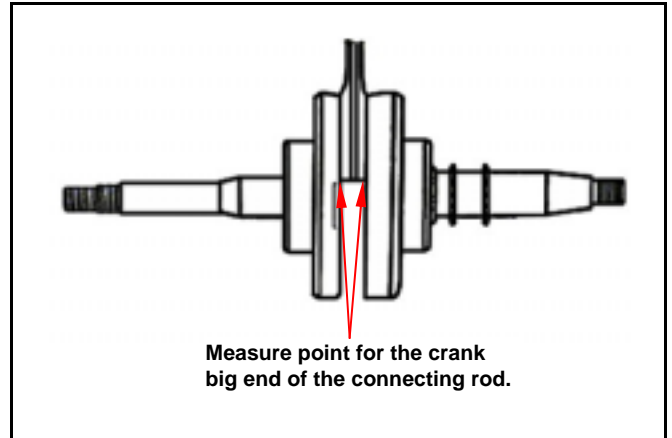

Measure the clearance of the big end at the vertical directions.

**Service limit: 0.05 mm**

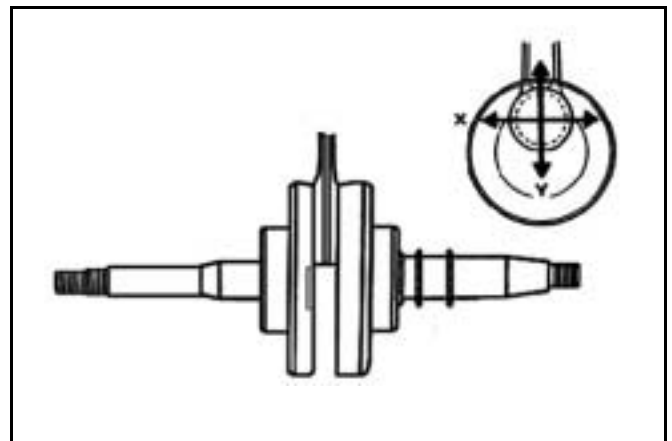

Place the crankshaft on a V-block, measure run-out of the crankshaft.

**Service limit: 0.10 mm**

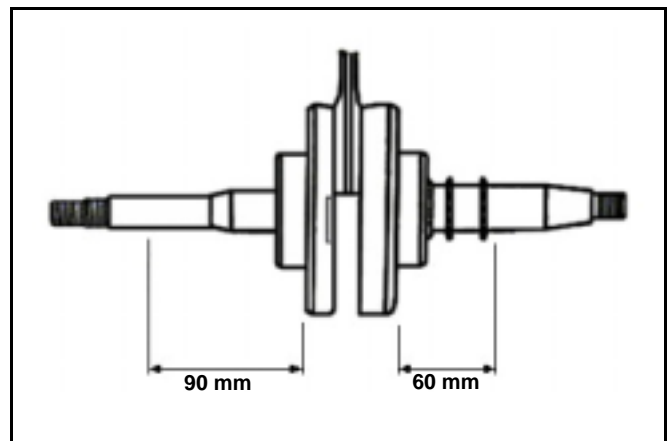

### Check crankshaft bearing

Use hand to crank the bearing to see it moves freely, smoothly and noiseless.

Check the inner ring to see it links firmly on the bearing.

If any roughness, noise and loose linkage are detected, replace the bearing with new one.

#### Caution

The bearing shall be replaced in pair.

**Special tool: outer bearing puller**

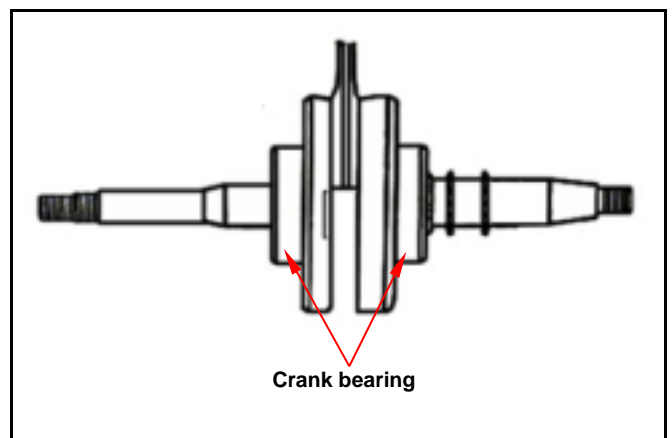



## 11. CRANKCASE / CRANK

### Check balance shaft bearing

Check bearings on right and left crankcase. Rotate each bearings inner ring with fingers. Check if bearings can be turned in smooth and silent, and also check if bearing outer ring is mounted on gear tightly.

If bearing rotation is uneven, noising, or loose bearing mounted, then replace it.

**Special tool:** Inner bearing puller  
Bearing driver

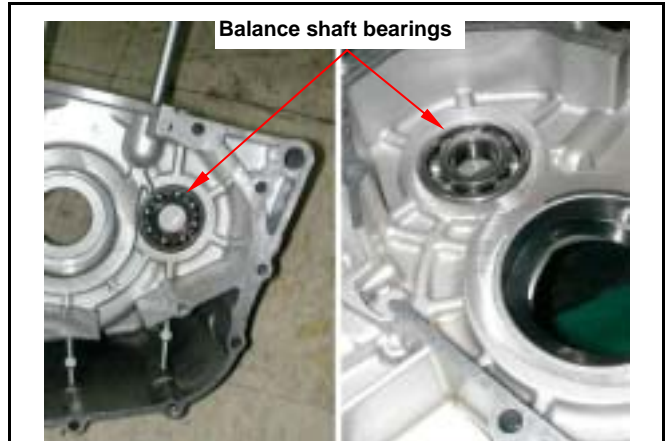

### Assembly of crankcase

Install wave washer into right crank bearing seat.



Install crank shaft on the right crankcase.



Align the position mark on the balance shaft drive gear with that of balance shaft driven gear, and then install balance shaft onto right crankcase.

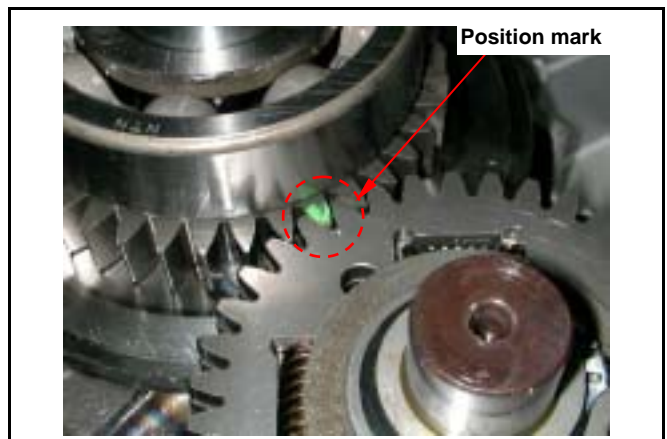

Install 2 dowel pins and new gasket.

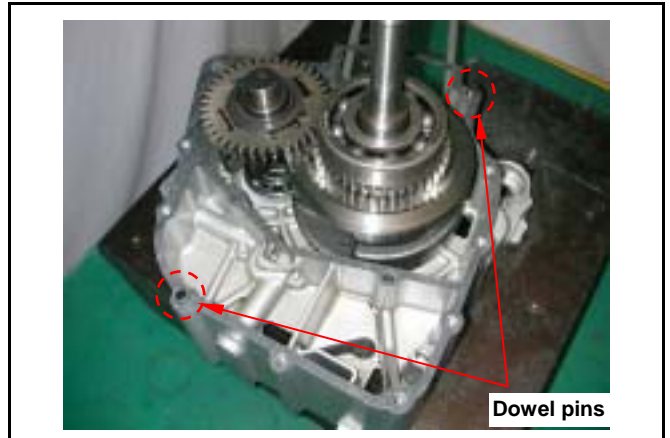

Install the left crankcase onto the right crankcase.



Tighten 11 bolts on the left crankcase.  
**Torque value: 0.8~1.2kgf-m**

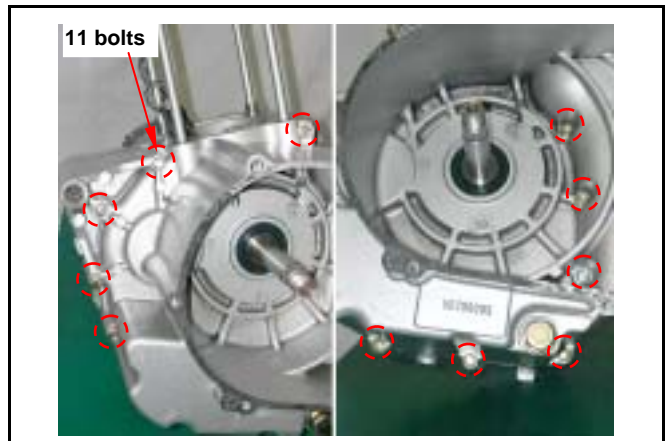

Tighten 2 bolts on the right crankcase.  
**Torque value: 0.8~1.2kgf-m**

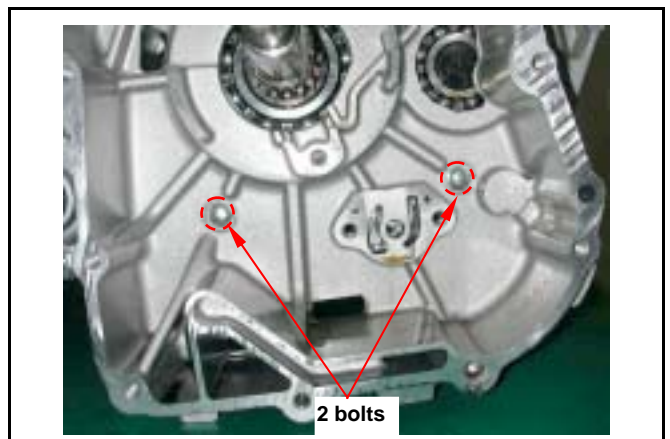

## 11. CRANKCASE / CRANK

Clean the crankshaft.

Apply a layer of grease on the lip of oil seal, Puts on the left crank shaft.

Install the oil seal in the left crankcase with care not to damage the lip of the oil seal.



By oil seal driver (27x42x7), oil seal will knock into located.

**Special tool:**

**Oil seal driver (27x42x7)**



Install the tensioner and tighten the pivot bolt.

**Torque value: 0.8 ~1.2kgf-m**

Install the cam chain.

Install the cam chain setting plate.

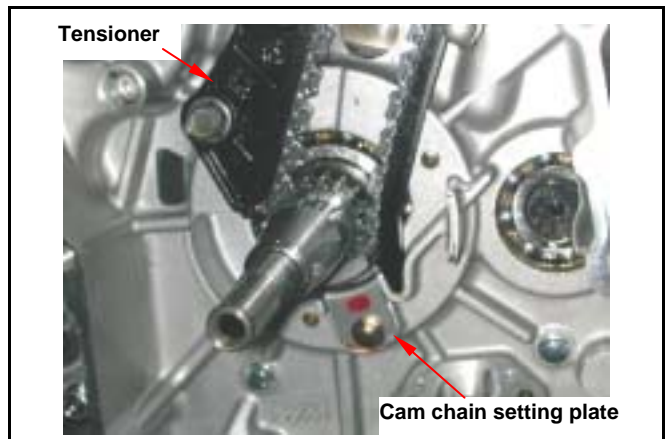

<a href="#">Mechanism Diagram .....</a>	<a href="#">12-1</a>	<a href="#">System Test.....</a>	<a href="#">12-5</a>
<a href="#">General Information .....</a>	<a href="#">12-2</a>	<a href="#">Radiator .....</a>	<a href="#">12-6</a>
<a href="#">Trouble Diagnosis .....</a>	<a href="#">12-2</a>	<a href="#">Water Pump.....</a>	<a href="#">12-8</a>
<a href="#">Trouble Diagnosis for Cooling System .....</a>	<a href="#">12-3</a>	<a href="#">Thermostat .....</a>	<a href="#">12-12</a>

### Mechanism Diagram

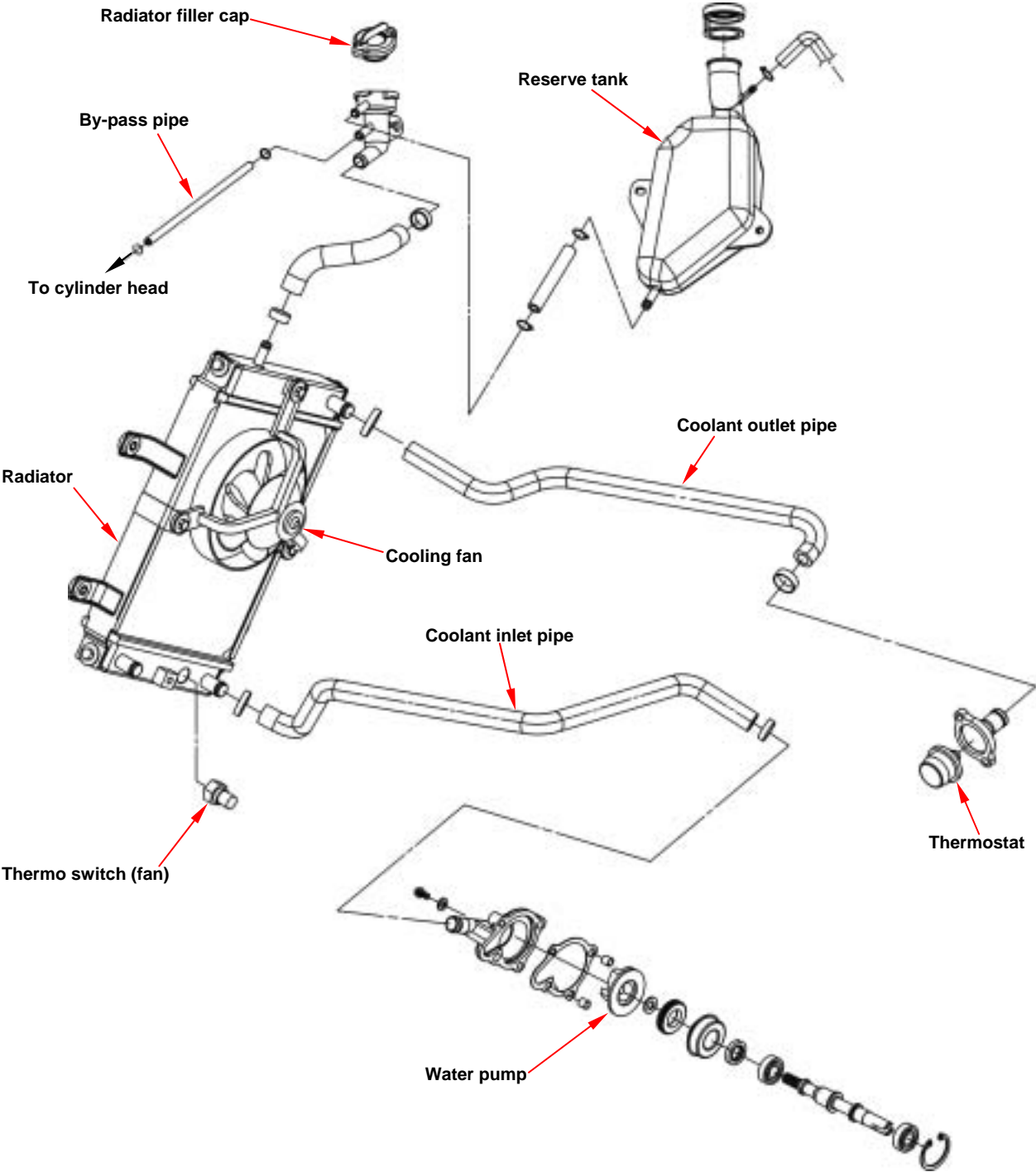

## 12. COOLING SYSTEM

### General Information

#### General

#### Warning:

While the engine is running, never attempt to open the radiator filler cap, the pressurized hot coolant may shoot out and cause serious scalding injury. No maintenance work is allowed to perform unless the engine is completely cooled down.

- Refill the radiator with distilled water or specified additives.
- Add coolant to the reservoir.
- The cooling system can be serviced on the ATV.
- Never spill the coolant to the painted surface.
- Test the cooling system for any leakage after the repair.
- Please refer to Section 17 for inspection of the temperature sensor switch for the fan motor and the water thermometer.

#### Technical Specification

Item	Specification
Pressure to open filler cap	0.9±0.15 kgf/cm <sup>2</sup>
Capacity of coolant: Engine + radiator Reservoir upper	850c.c. 420c.c.
Thermostat	Begins to activate at 82~95 Stroke: 0.05~3mm
Thermos switch (fan)	Begins to activate at 98±3
Boiling point	Not-pressure: 107.7 Pressurized: 125.6

#### Torque Value

For water pump impeller 1.0~1.4kgf-m

#### Tools Requirement

##### Special tools

Water pump bearing driver (6901): SYM-9100100  
 Water pump oil seal driver (Inner): SYM-9120500-H9A  
 Water pump mechanical seal driver: SYM-1721700-H9A  
 Inner bearing puller: SYM-6204020

### Trouble Diagnosis

#### The engine temperature is too high

- The water thermometer and the temperature sensor do not work properly.
- The thermostat is stuck to close.
- Insufficient coolant.
- The water hose and jacket are clogged.
- Fan motor malfunction.
- The filler cap of the radiator malfunction.

#### The engine temperature is too low

- The water thermometer and the temperature sensor malfunction.
- The thermostat is stuck to open.

#### Coolant is leaking

- The water pump mechanical seal does not function properly.
- The O ring is deteriorated.
- The water hose is broken or aged.

Trouble Diagnosis for Cooling System

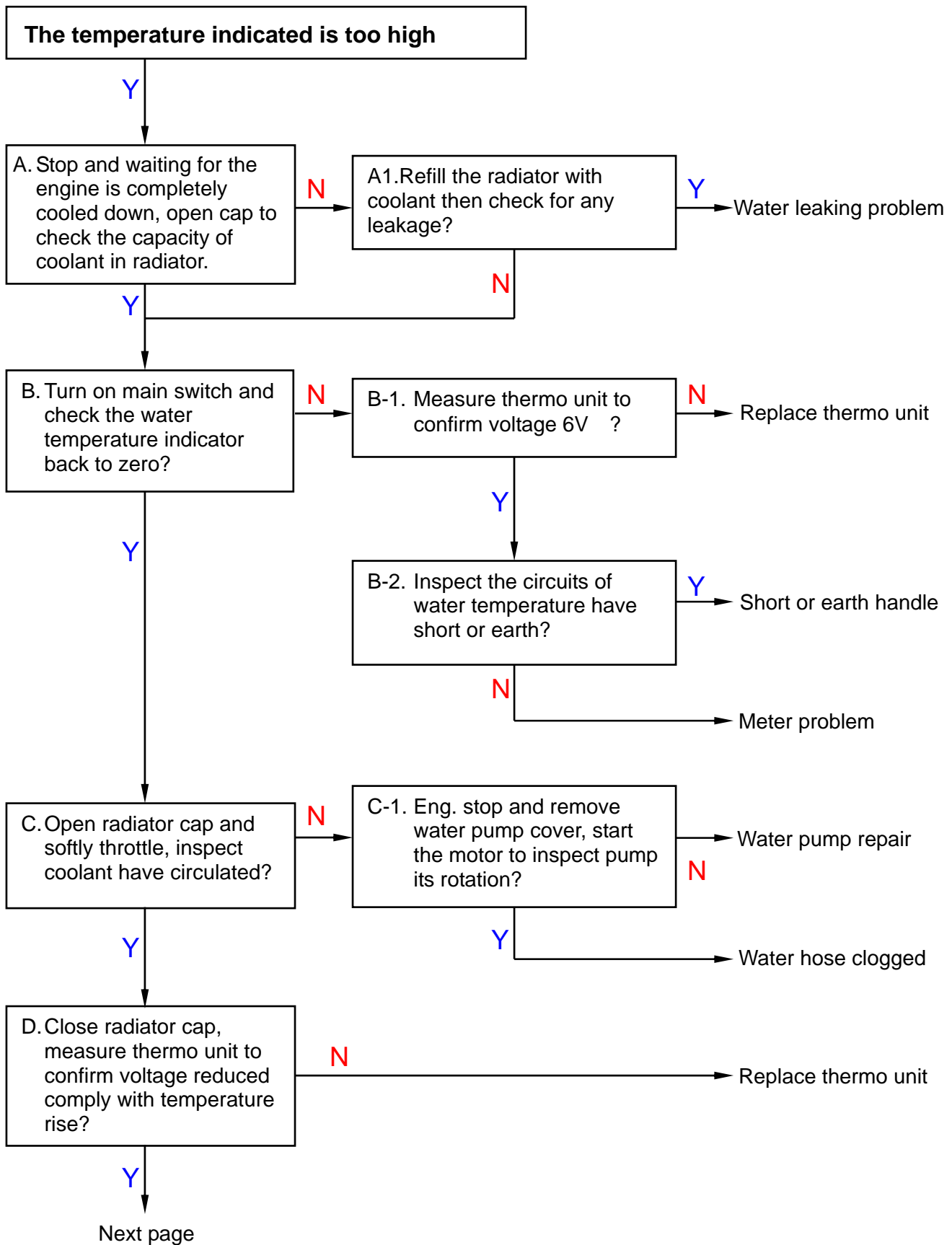

# 12. COOLING SYSTEM

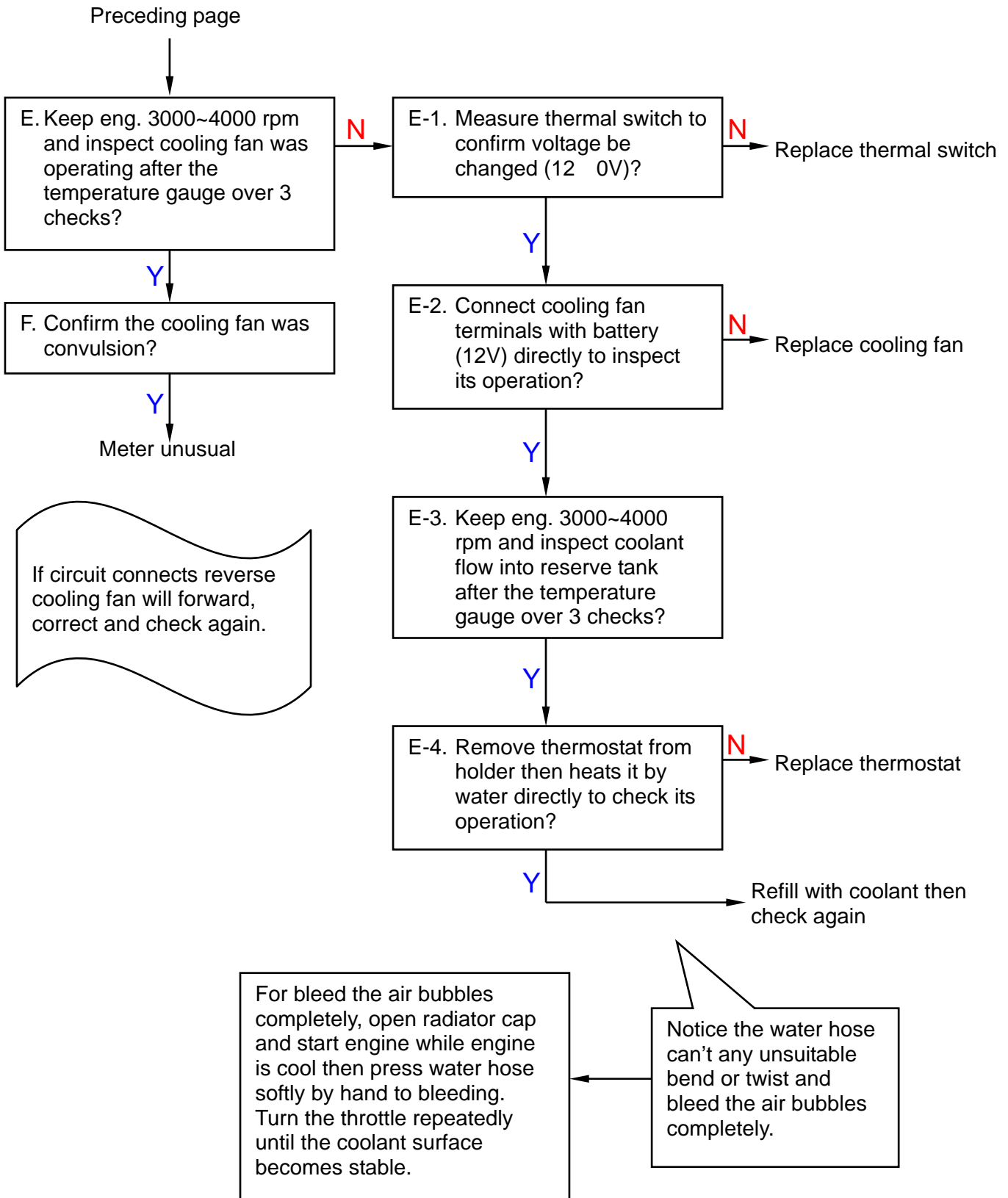



## System Test

### Test on the filler cap

Hermetically seal the filler cap, apply water and pressure to the filler cap. Replace it with new one if found failing to maintain the specified pressure within a given time limit, or the opening pressure is too high or too low. The specified pressure shall be maintained at least for 6 seconds in the test

**Relief pressure for the filler cap: 0.9-0.15 kgf/cm<sup>2</sup>**

Apply pressure to the radiator, engine and water hose to check for any leakage

### ⚠ Caution

Pressure which is too high may damage the radiator. Never use pressure which exceeds 1.05 kgf/cm<sup>2</sup>.

If the system fails to maintain the specified pressure for at least 6 seconds, repair or replace parts.

### Change of coolant

### ⚠ Warning

Never attempt to carry out service work on the cooling system unless the engine is completely cooled down, otherwise, you may get scalded.

Remove the front center cover, and then remove filler cap.

Place a water pan under the water pump; loosen the drain bolt to drain out the coolant. Reinstall the drain bolt.

Refilling system with coolant and bleeding the air bubbles.

- Run the engine, and remove by-pass pipe.
- Check by-pass hole whether has the air bubble to emit.
- If emits without the air bubble, only has the coolant to flow out, then backflow pipe joint on, engine flameout.
- Remove radiator filler cap.
- Starts the engine, inspects does not have the air bubble in the radiator coolant, also the coolant liquid level is stable.
- Stop the engine. Add coolant to proper level if necessary.
- Screw and tighten up the radiator filler cap.

### ⚠ Caution

In order to avoid the water tank rusting, please do not use the unclear trade mark refrigerant.

Coolant recommended: SYM Bramax radiator agent.

Concentration: 50%

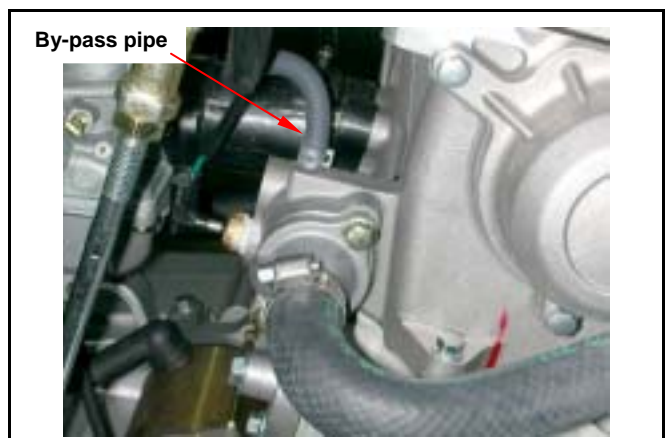
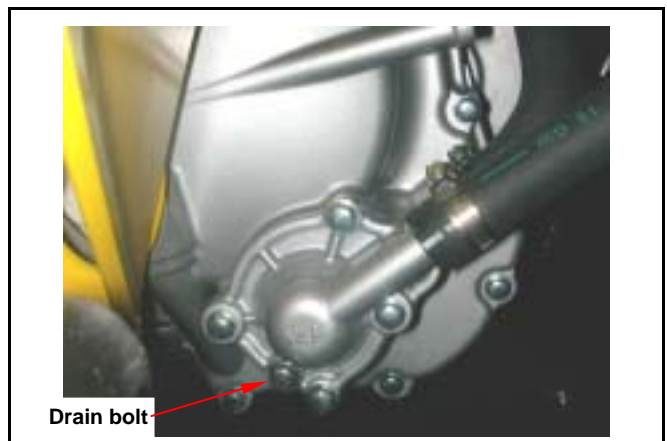
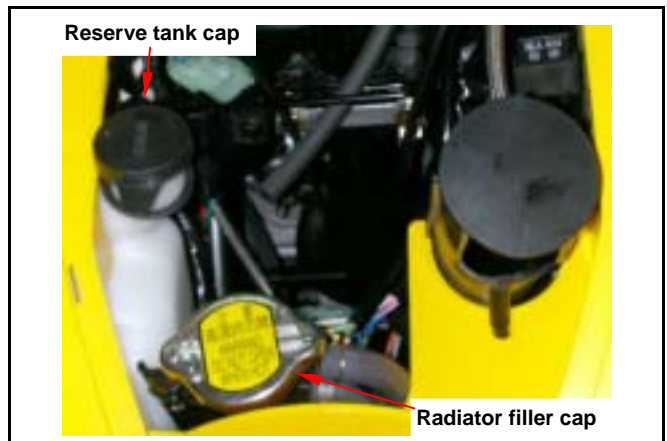
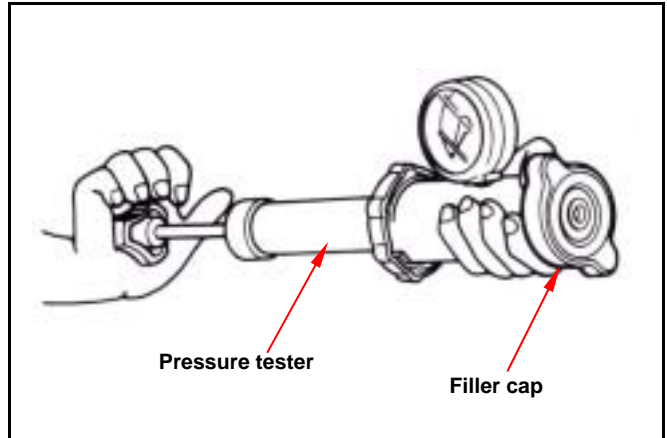



## 12. COOLING SYSTEM

### Check reserve tank

- Remove the front center cover, and then remove reserve tank filler cap.
- Check the liquid level in the front fender right side. Add coolant to proper level if too low.
- Reinstall the reserve tank filler cap.

### Caution

The reserve tank liquid level can be too low, after avoiding the water temperature elevating, in the cooling system the refrigerant backflow floods.

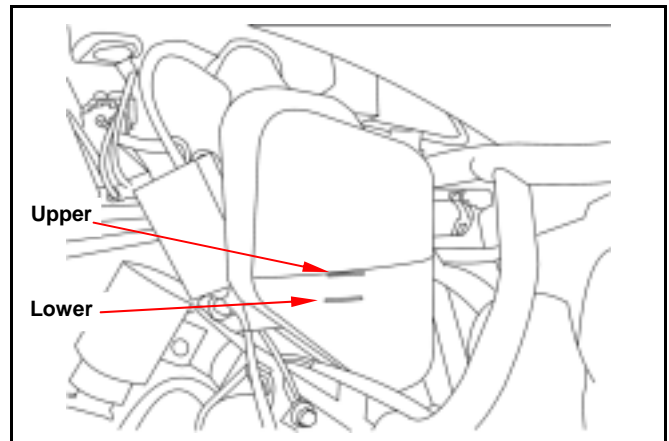

### Radiator

#### Check

Remove the front center cover, side covers and front fender. (refer chapter 13), check for any leakage from weld seam. Blow radiator clean using compressed air. If the radiator is blocked by dirt, use low pressure water jet to clean it. Care shall be taken when straightening the sink fan.



#### Removal

Place a water pan under the water pump; loosen the drain bolt to drain out the coolant.

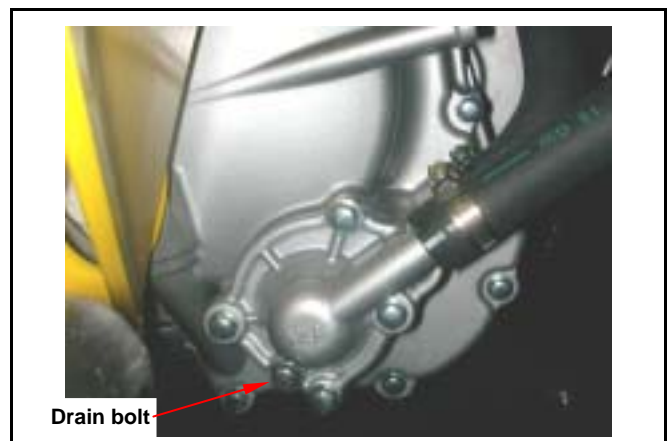

Remove coolant filler pipe.

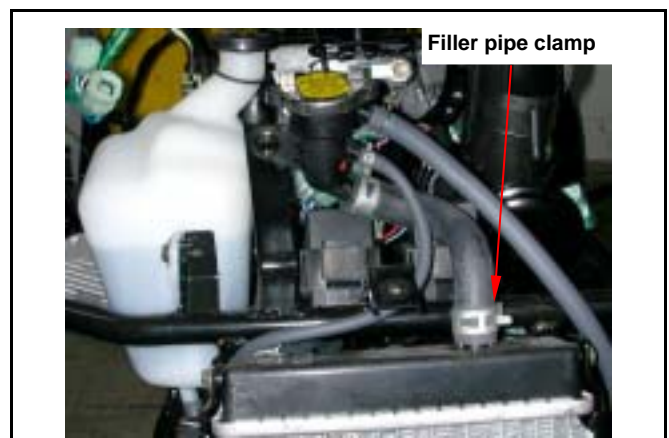

Loosen the radiator 4 bolts.  
Remove coolant upper side pipes.

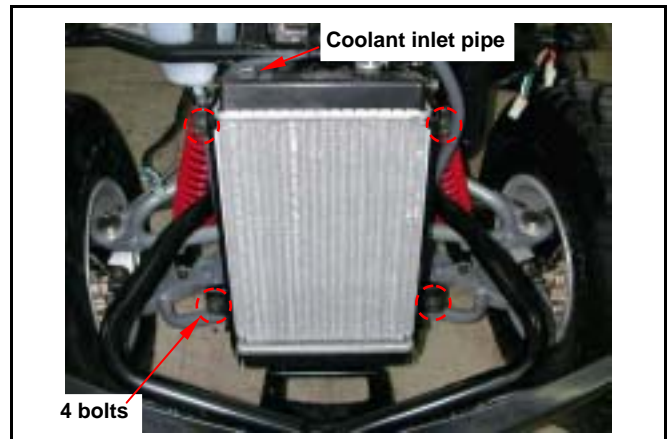

Remove coolant outlet pipe.  
Disconnect the couplers for the thermo switch and fan motor, and then remove radiator and cooling fan.

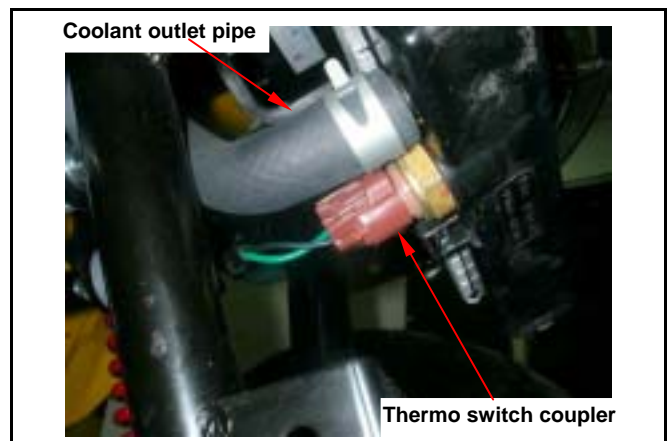

### Disassembly

Loosen the 3 bolts from the fan duct, and then remove the fan duct.  
Loosen 3 screws from the fan motor, and take off the fan motor.  
Remove nut to remove the fan from fan motor.

### Assembly

Install fan motor onto fan duct and insert the fan into the motor shaft.  
Apply a coat of the adhesive to the shaft thread of the motor, and then install the washer and the lock nut.  
Tighten the fan duct onto the radiator with 3 bolts.  
Please refer to chapter 17 for the inspection of the thermo switch.

### ⚠ Caution

Liquid packing must be applied to the thermo switch before installing to avoid damaging the radiator.

### Installation

Install the removed parts in the reverse order of removal.  
Install radiator in the reverse order of removal.  
Upon completion, check for any leakage.

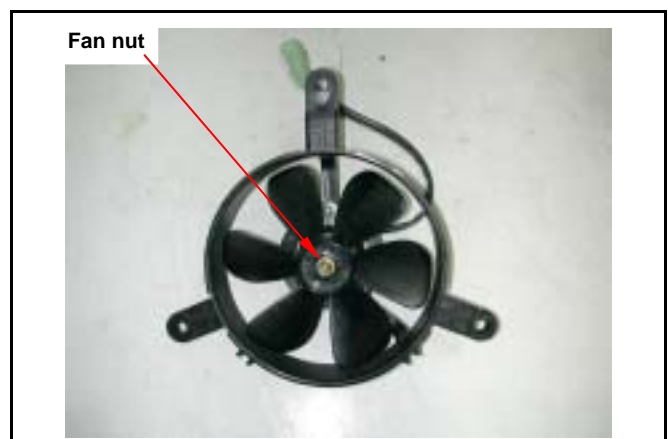
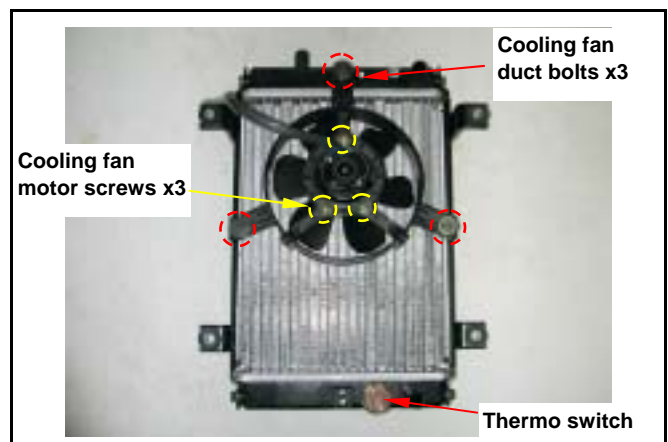

## 12. COOLING SYSTEM

### Water Pump

#### Check water pump seal / cooling system divulges inspection

- Disassembles the refrigerant drain bolt, overflows little buckles the N actually fluid, confirmed overflows the refrigerant whether has the greasy dirt.
- Turns on lathe the engine oil gauge rule, the inspection engine oil whether does have bleaches situation of the emulsified.

If has the above two kind of interior to divulge the phenomenon, possibly for the water pump inner two seal damages, the engine cooling system damages or the cylinder and the cylinder head gasket damages, please first dismantles the right crank case to say A confirms the replacement water pump seal, if does not have the question to take apart for overhaul cooling system of system again the cylinder head, the cylinder.

#### Removal of water pump

Loosen the drain bolt to drain out the coolant.

Remove the water hose.

Loosen 4 bolts and remove the pump cover.

Loosen 9 bolts and remove the right cover.

Take off the gasket and dowel pins.

Turn pump impeller clockwise and remove.

#### Caution

The impeller is provided with left turn thread.

Remove the cir clip from the right crankcase cover.  
Remove the water pump shaft and the inner bearing.

Remove the outside bearing by inner bearing puller.

Rotate the inner ring of bearing, the bearing shall move smoothly and quietly.

If the bearing does not rotate smoothly or produces a noise, replace it with new one.

#### Special tool:

**Inner bearing puller**

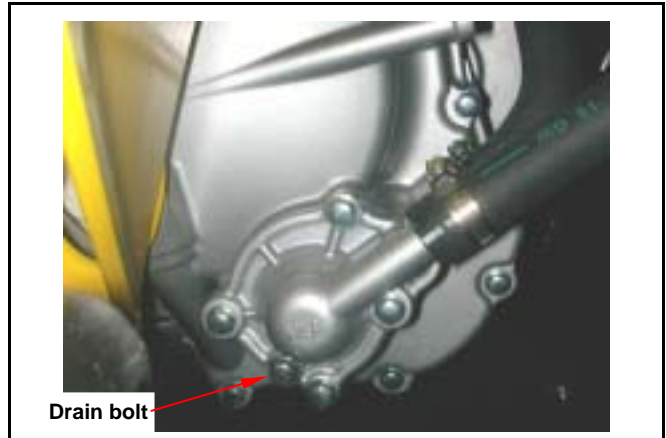

Check any wear and damage of the mechanical seal and inside seal.

**⚠ Caution**

The mechanical seal and inside seal must be replaced as a unit.

**Replacement of Mechanical Seal**

Remove the inside bearing by inner bearing puller. Drive the mechanical seal and inner seal out of the right crankcase.

**Special tools:**

**Inner bearing puller**

**Water pump bearing driver**

**⚠ Caution**

Replace a new mechanical seal after removing it.

Apply a coat of sealant to the mating surfaces of the right crankcase before installing the new mechanical seal.

Install the mechanical seal onto the right crankcase.

**Special tools:**

**Water pump mechanical seal driver**



## 12. COOLING SYSTEM

Install the new inner seal onto the right crankcase.

**Special tools:**

**Water pump oil seal driver (inner)**

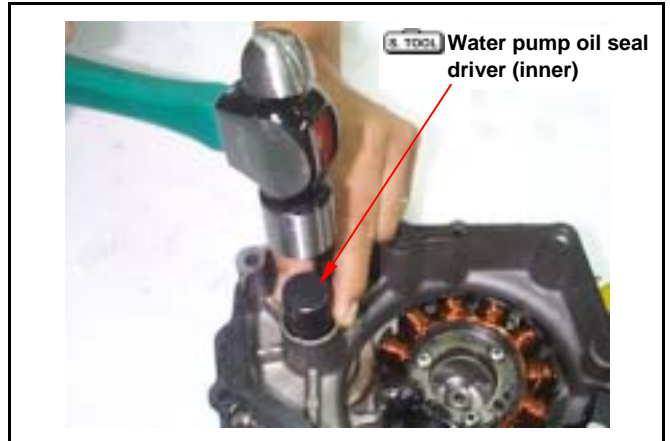

Install a new outside bearing to the right crankcase cover.

**Special tools:**

**Water pump bearing driver (6901)**

**⚠ Caution**

Do not reuse old bearing. It must be replaced with a new one once it has been removed.

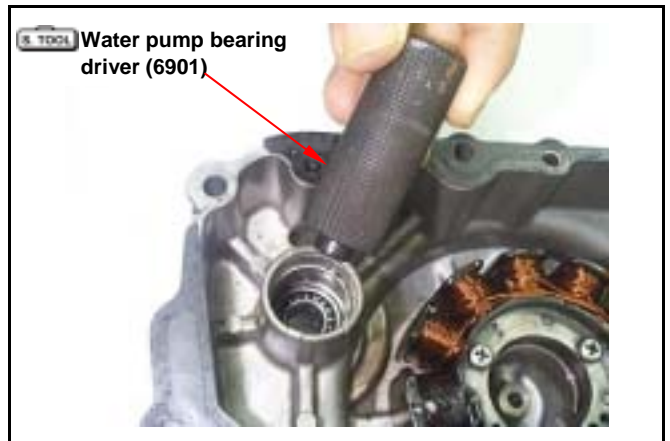

Mount the water pump shaft and the inner bearing to the right crankcase cover.

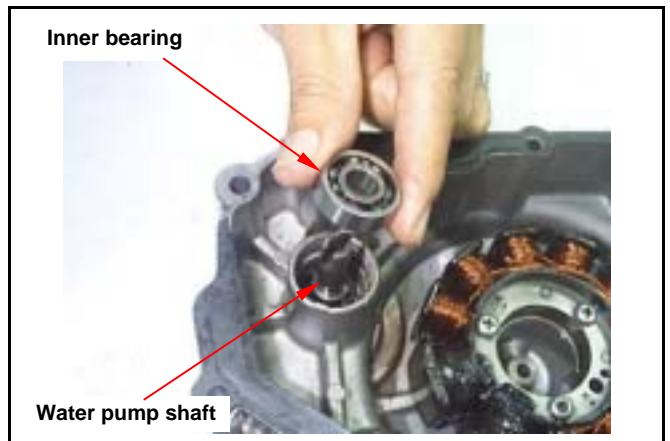

Install the cir clip to hold the inner bearing.



Install the seal washer into the impeller.

**⚠ Caution**

Washer must be replaced together with the mechanical seal.



Install the impeller onto the water pump shaft and tighten.

**Torque Value: 1.0~1.4kgf-m**

**⚠ Caution**

The impeller is left thread.

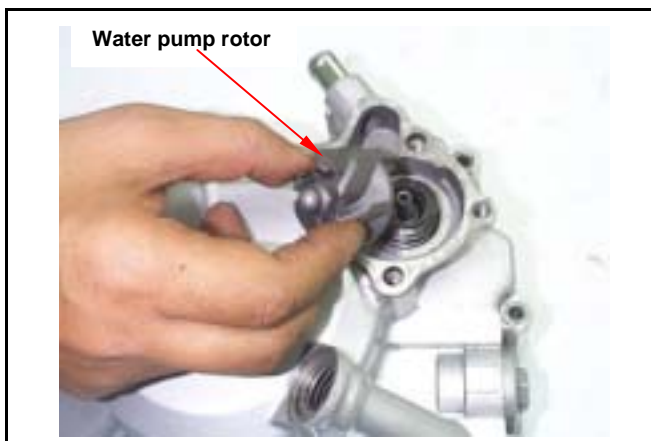

Install the dowel pin and right cover gasket.

The rotation water pump impeller, causes the water pump drive shaft scoop channel, aligns the oil pump drive shaft flange, install the right crank case. (9 bolts)



Install the dowel pin and new gasket.

Install the water pump cover with 4 bolts.



## 12. COOLING SYSTEM

### Thermostat

Please refer to chapter 17 for inspection of temperature sensor.

#### Removal

Drain out the coolant.

Remove the thermostat set. (2 bolts)

#### Inspection

Visually inspect thermostat for any damage.

Place the thermostat into heated water to check its operation.

#### Caution

Whenever the thermostat and the thermometer are in contact to the wall of heated water container, the reading displayed is incorrect. If the valve of the thermostat remains open at room temperature or the valve operation is not corresponding to the temperature change, then it must be replaced.

#### Technical Data

Valve begins to open	82~95
Valve stroke	0.05 ~ 3mm

#### Installation

Install the thermostat.

Install the thermostat cover. (2 bolts)

Refill the coolant and bleed out the air bubble (Page 12-5).

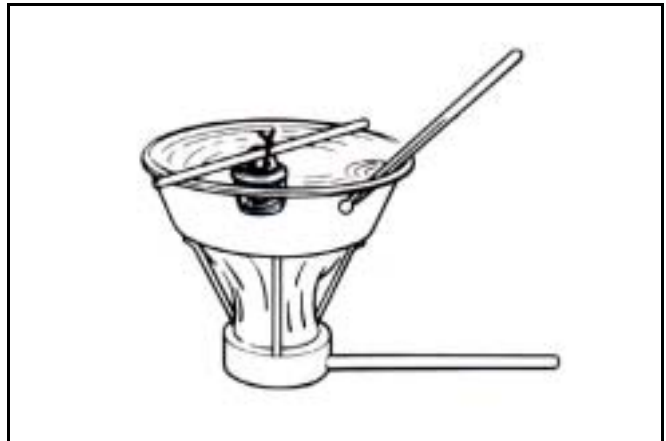
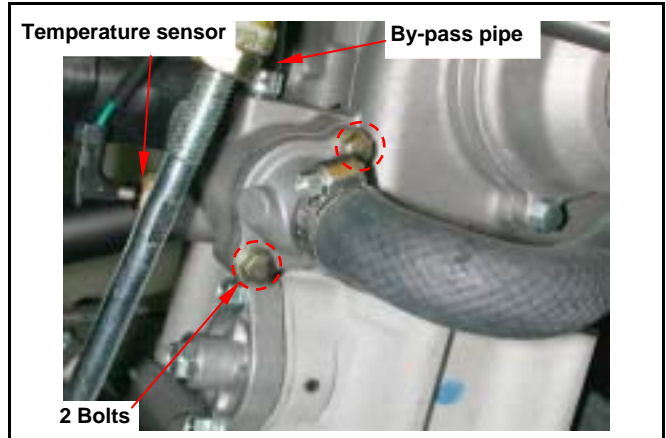



Mechanism Diagram .....	13-1	Fuel tank cover .....	13-5
Maintenance.....	13-2	Front fender.....	13-6
Handle front cover / Meter cover.....	13-3	Rear carrier.....	13-10
Handle protect cover.....	13-4	Rear fender .....	13-11
Front center cover.....	13-4	Footrest .....	13-14

### Mechanism Diagram

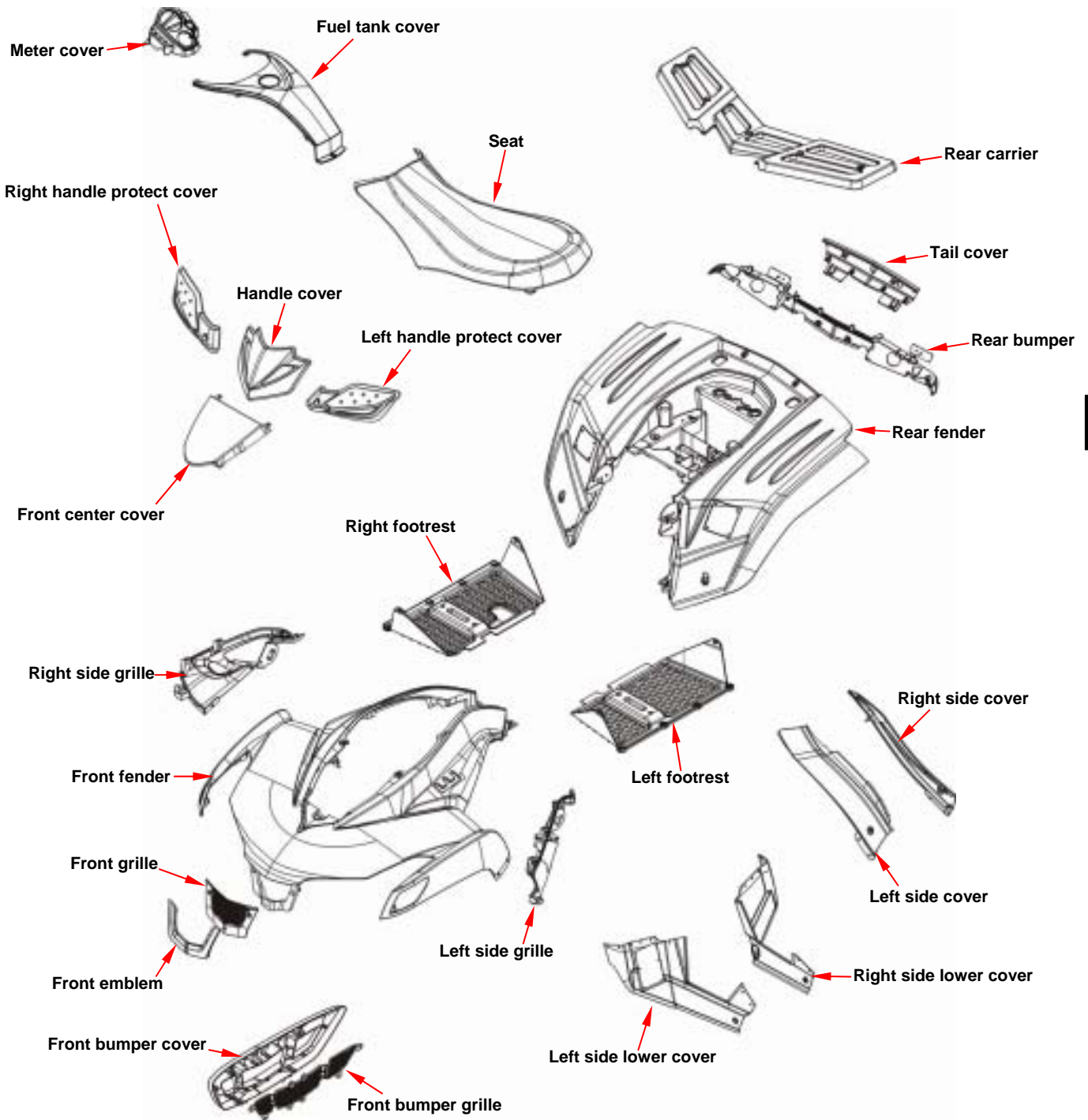



## 13. BODY COVER

### Maintenance

Body covers disassemble sequence:

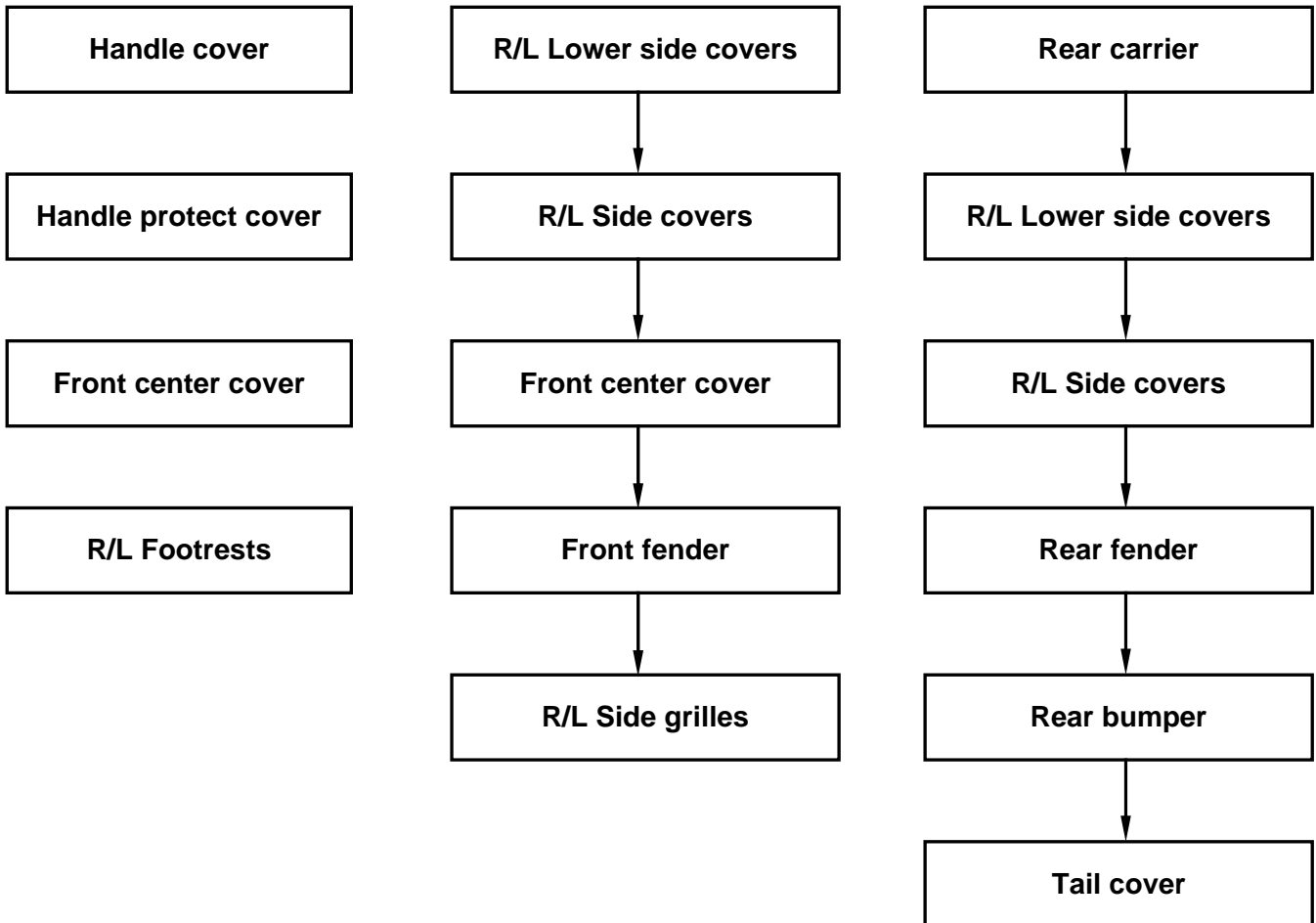

- Be careful not to damage various covers in assembly or disassembly operation.
- Never injure hooks molded on the body covers.
- Align the buckles on the guards with slot on the covers.
- Make sure that each hook is properly installed during the assembly.
- Never compact forcefully or hammer the guard and the covers during assembly.

**Handle front cover / Meter cover**

**Remove**

Loosen 4 bolts from handle cover right and left side.

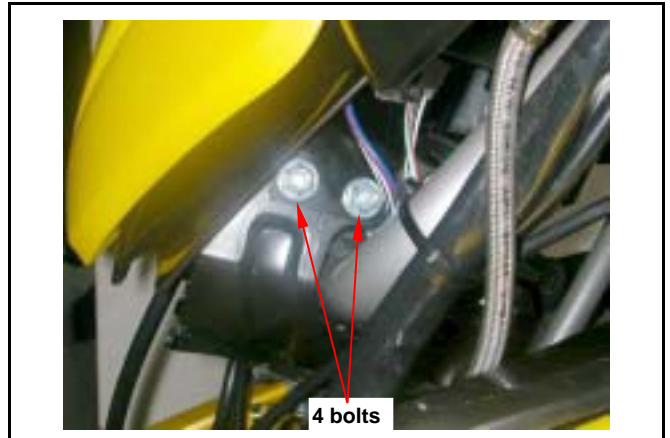

Remove couplers of meter.

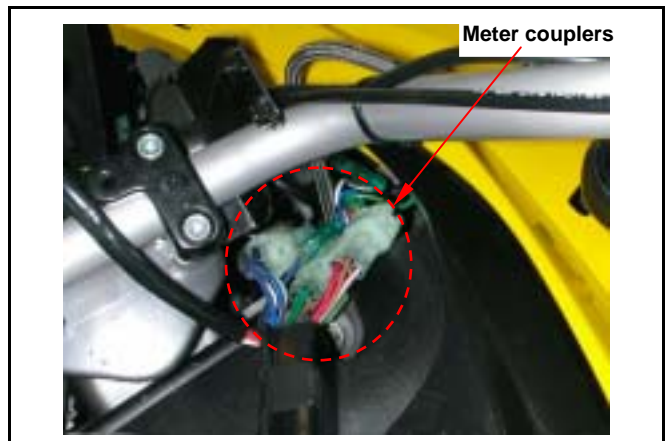

Remove speedometer cable, and then remove handle cover, meter cover and meter.

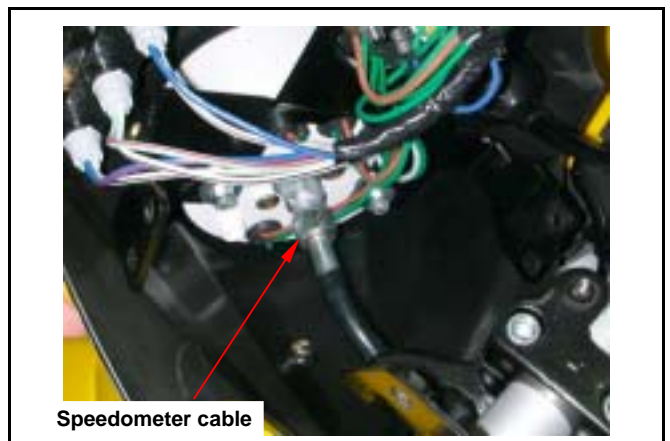

**Disassembly**

Remove 4 screws of meter stay and meters.

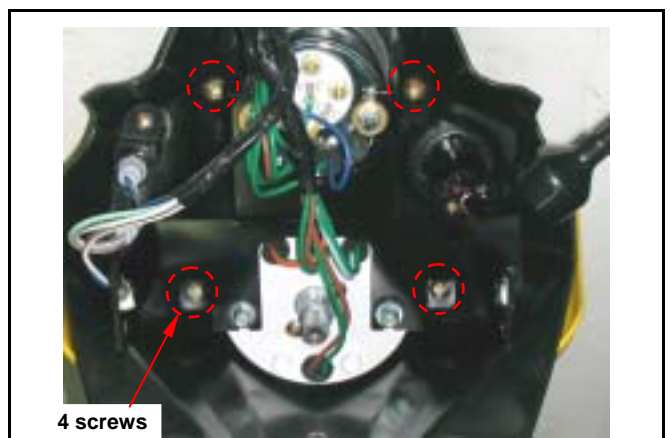

## 13. BODY COVER

Remove meter stay and meters.

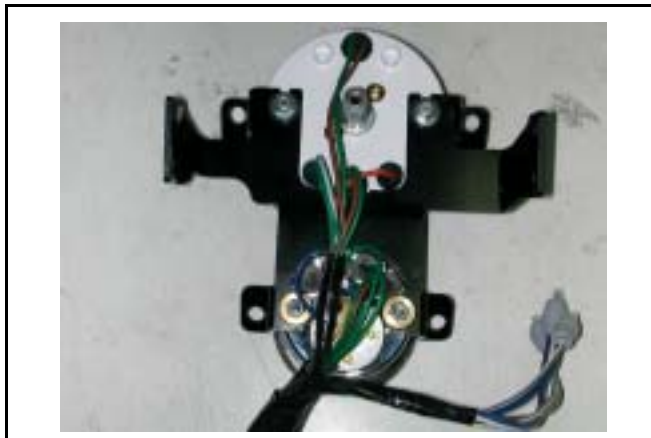

Remove 3 screws and disassembly handle cover and meter.

### Installation

Install in reverse order of removal procedures.

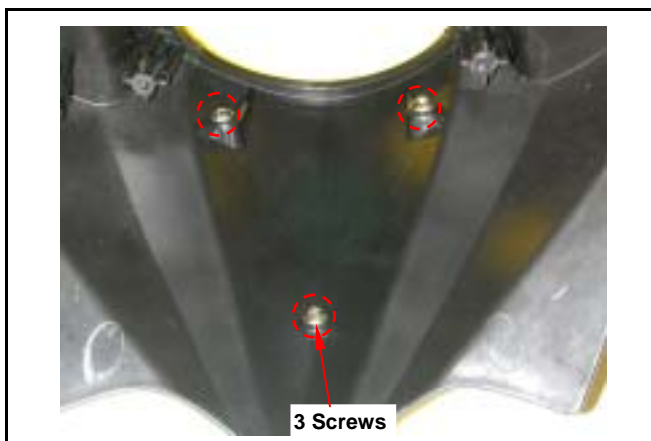

### Handle protect cover

Loosen 2 bolts from handle protect cover, and then remove handle protect cover.

### Installation

Install in reverse order of removal procedures.

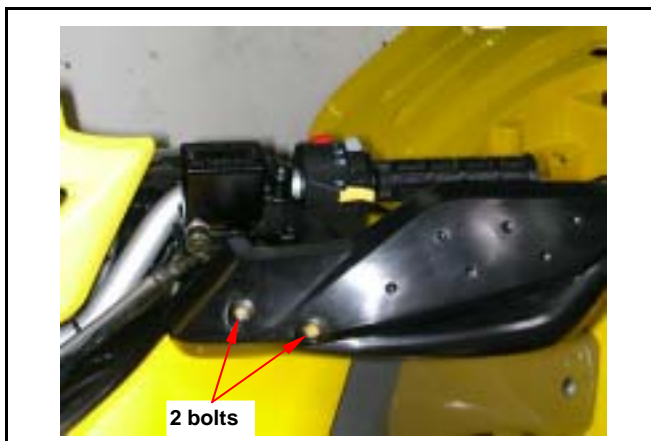

### Front center cover

#### Remove

Loosen 2 screws from the front center cover. Please disassemble first then push the cap upward, and then remove front center cover.

### Installation

Install in reverse order of removal procedures.



### Fuel tank cover

#### Remove

Remove front center cover.



Remove seat.

Remove fuel tank cap.



Remove 1 bolt, and then remove fuel tank cover.

#### Installation

Install in reverse order of removal procedures.

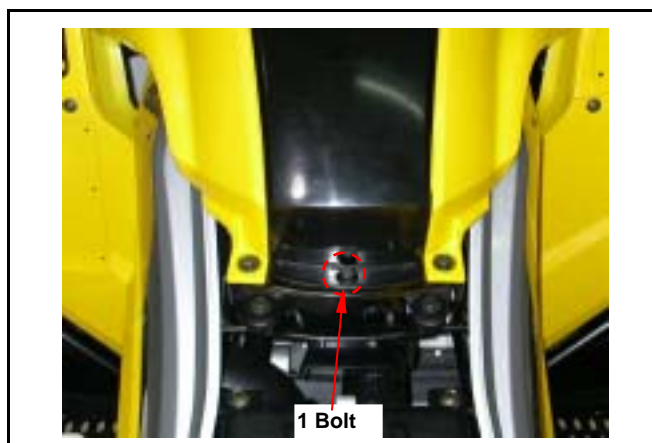

## 13. BODY COVER

### Front fender

#### Remove

Remove seat.  
Remove fuel tank cap and fuel tank cover.  
Loosen the two bolts of front fender rear side.

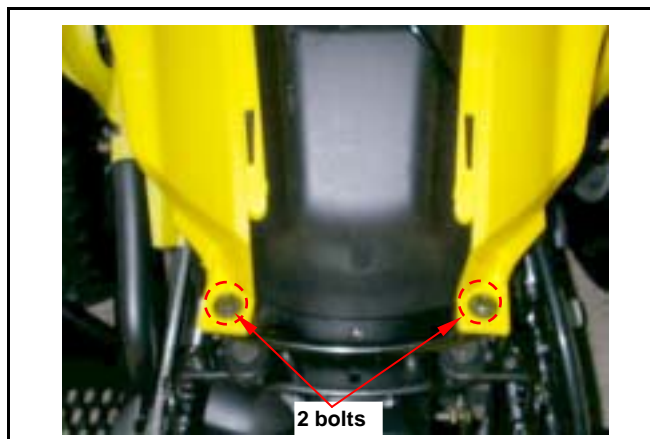

Remove 1 screw, and then remove fixed support catch.



Loosen the 6 screws, which connect the front fender and side lower covers, these 6 screws just be twin the front fender two side.

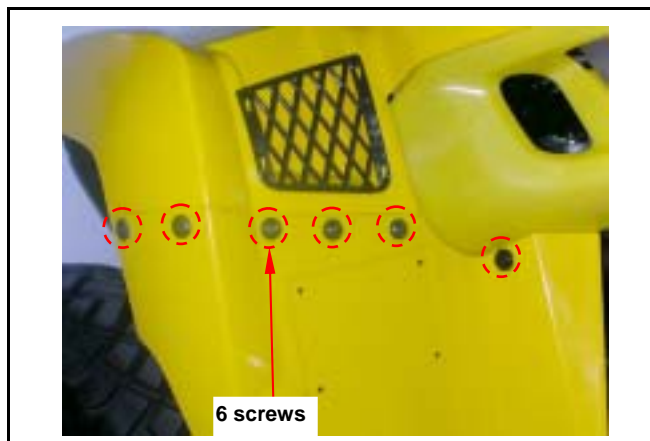

Remove right and left side lower covers rear side screws (each side 3 screws), and then remove side lower covers.

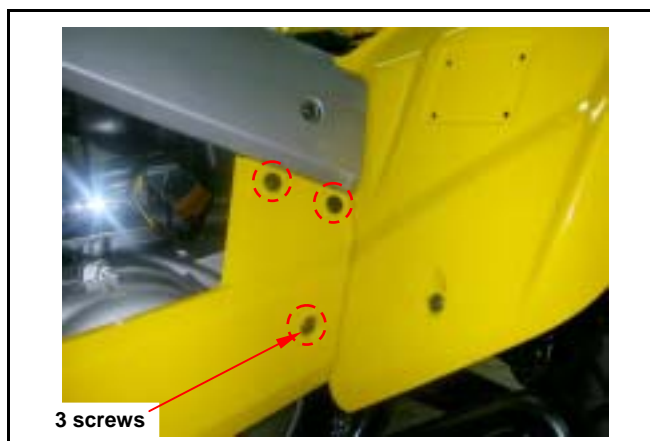

Remove right and left side covers (each side 1 screw).

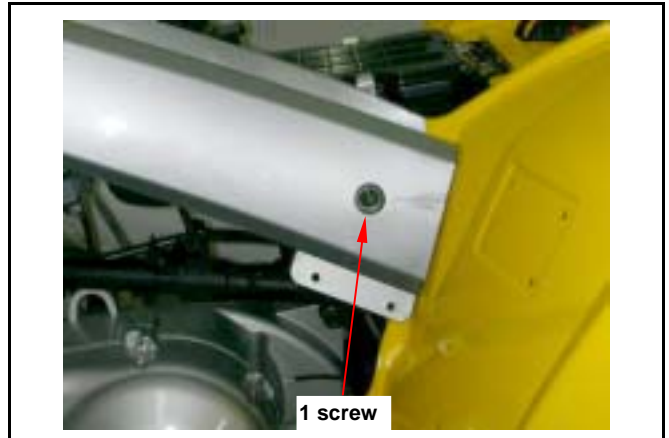

Loosen the front fender two side bolts (each side 1 bolt).

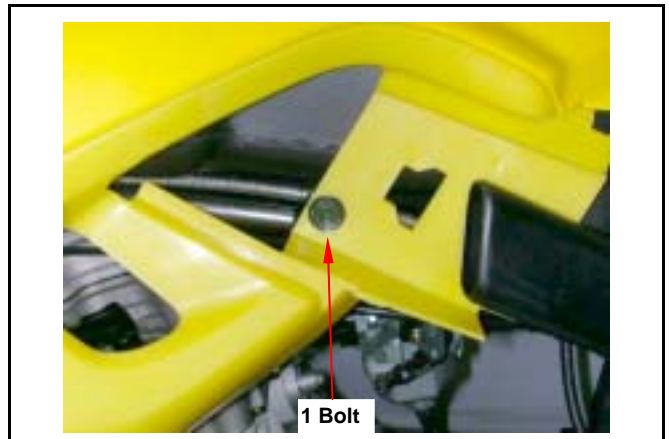

Remove headlight, front winker light and power outlet couplers.

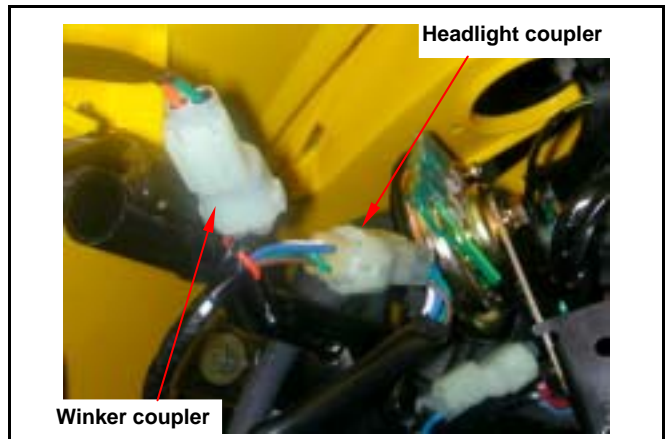

Remove front fender under side bolts (each side 1 bolt).

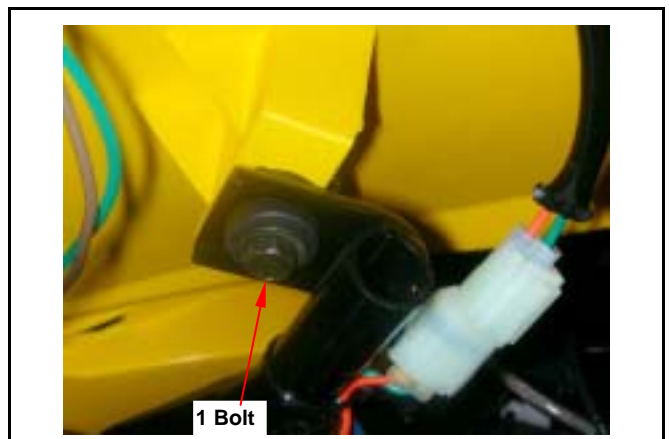

## 13. BODY COVER

Remove front fender front side bolts (2 bolts).

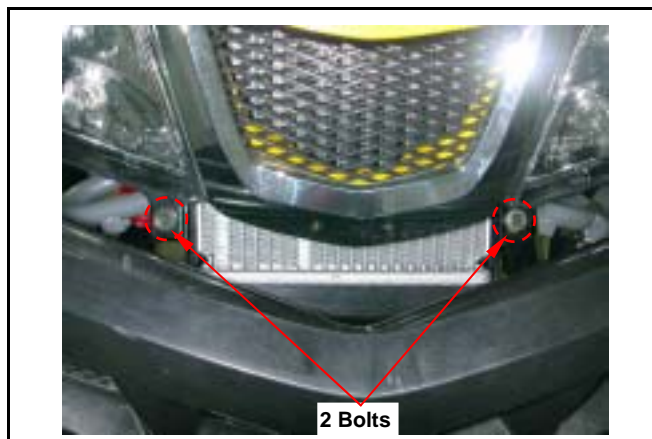

Remove the left crankcase cover duct.

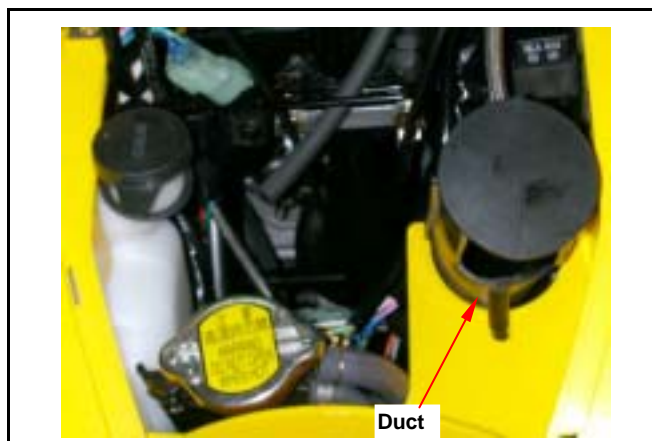

Remove front fender upper bolt, and then remove front fender and headlight.

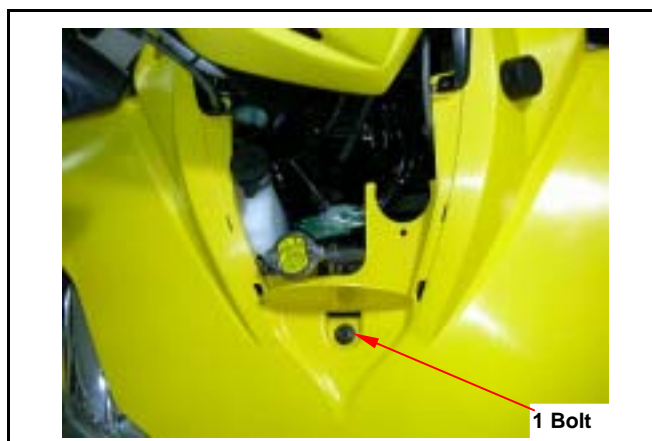

### Disassembly

Remove 3 screws to remove front emblem.

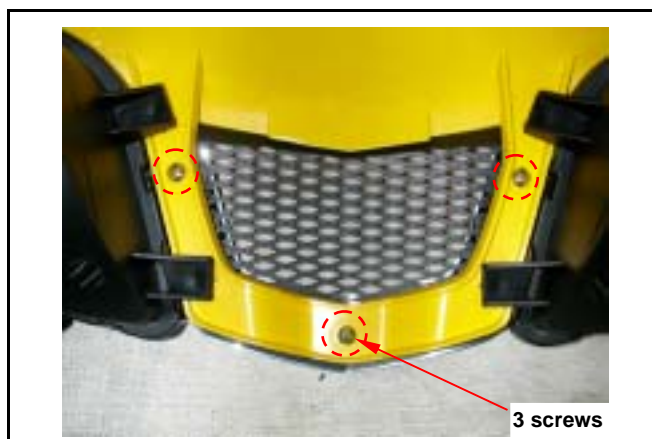

Remove headlights inner side 4 screws.

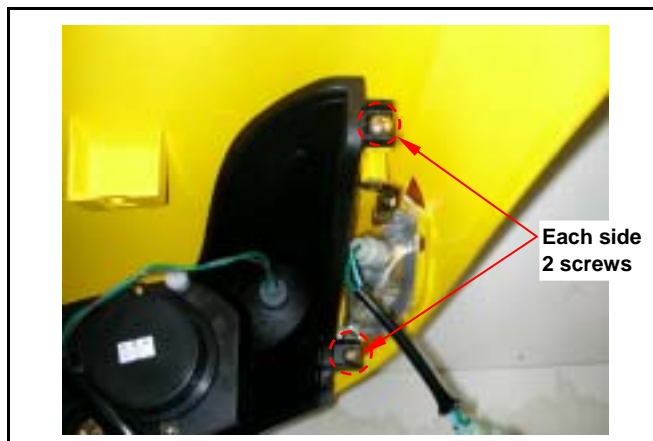

Remove headlights front side 4 screws, and then remove headlight.

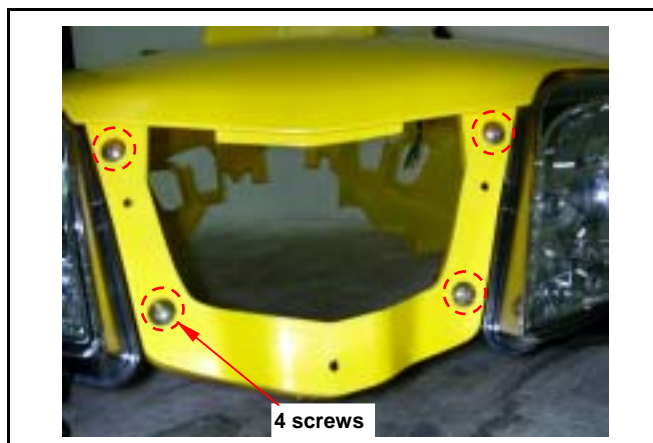

Remove winker lights 4 screws, and then remove winker lights.

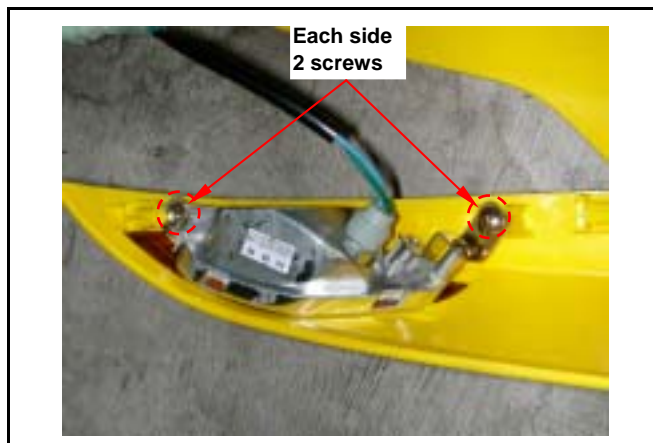

Remove 8 screws, and then remove right and left grille.

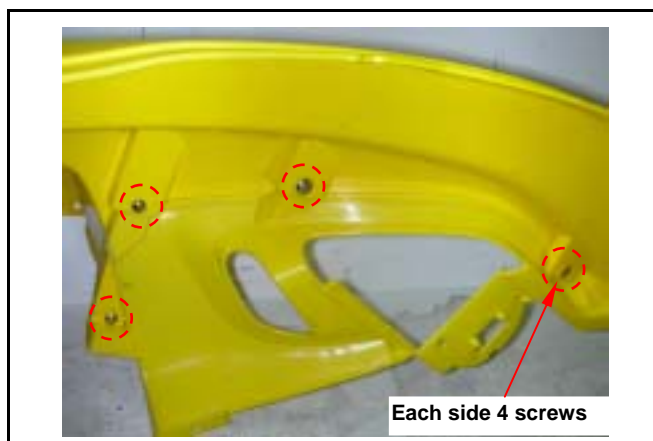



## 13. BODY COVER

Remove power outlet setting nut, and then remove power outlet.

### Installation

Install in reverse order of removal procedures.

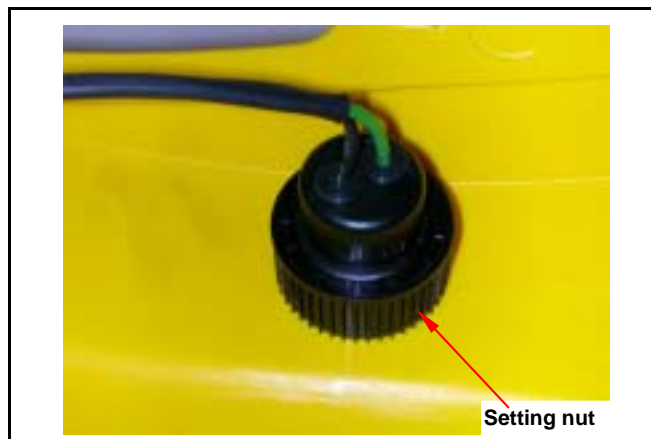

### Rear carrier

#### Remove

Loosen 4 bolts from the rear carrier.  
Remove the rear carrier.

#### Installation

Install in reverse order of removal procedures.

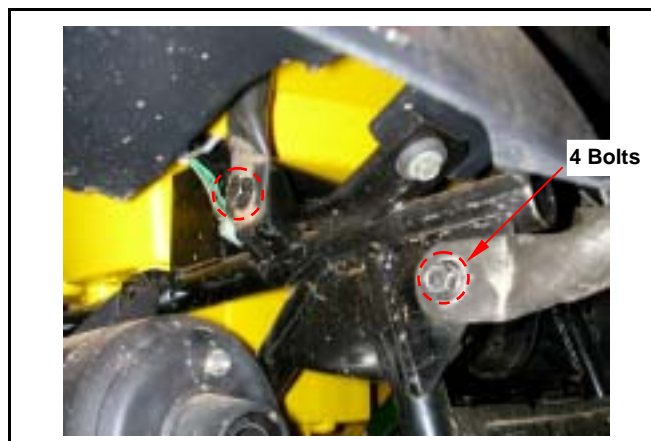

### Rear fender

Remove rear carrier.

Pull the "Seat Release Bar" up in order to remove the seat.

This seat release bar is under the rear side of the rear fender.

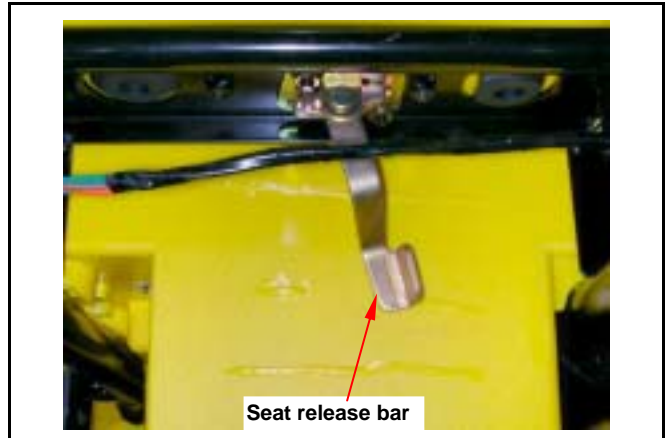

Loosen the 6 screws, which connect the front fender and side lower covers, these 6 screws just be twin the front fender two side.

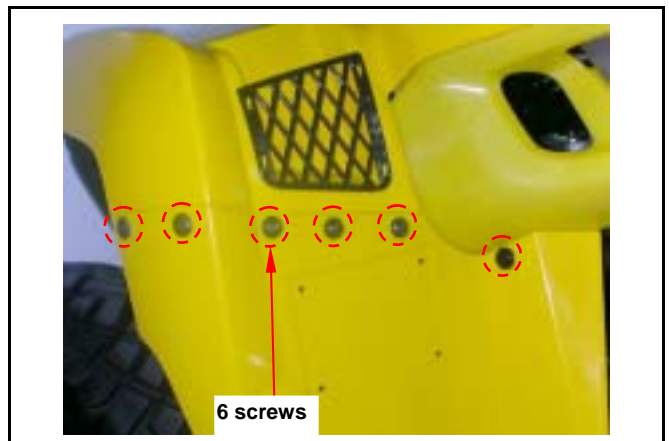

Remove right and left side lower covers rear side screws (each side 3 screws), and then remove side lower covers.

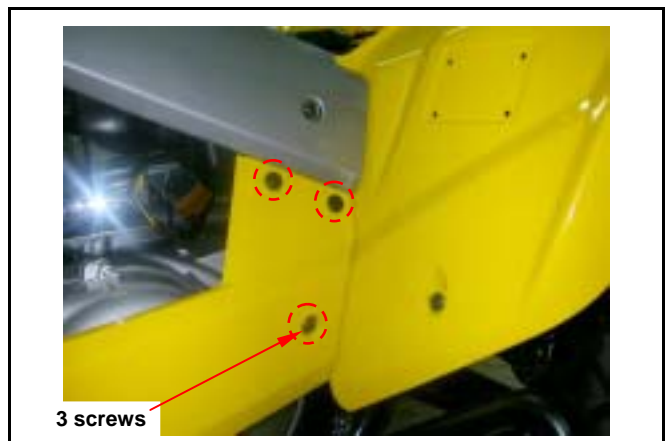

Remove right and left side covers (each side 1 screw).

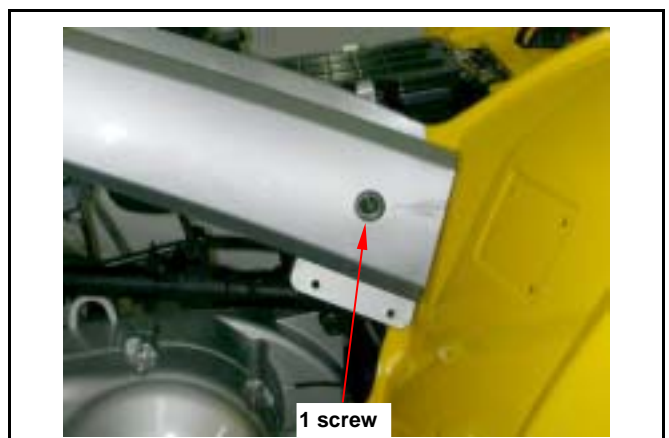

## 13. BODY COVER

Remove rear fender front side bolts and screws (each side 1 screw and 1 bolt).

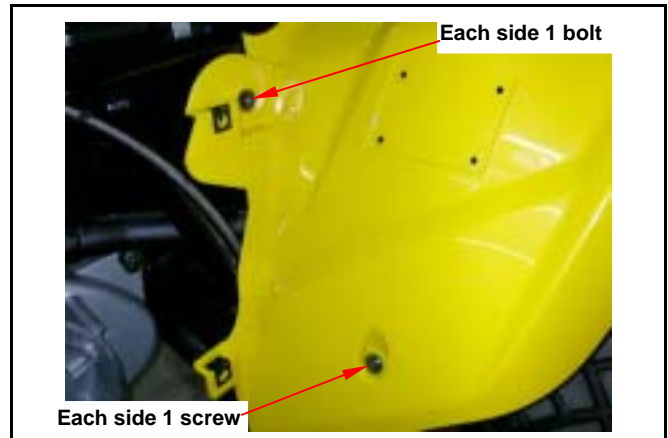

Remove battery, CDI unit, start relay and fuse box. Remove rear fender upper side 5 bolts.

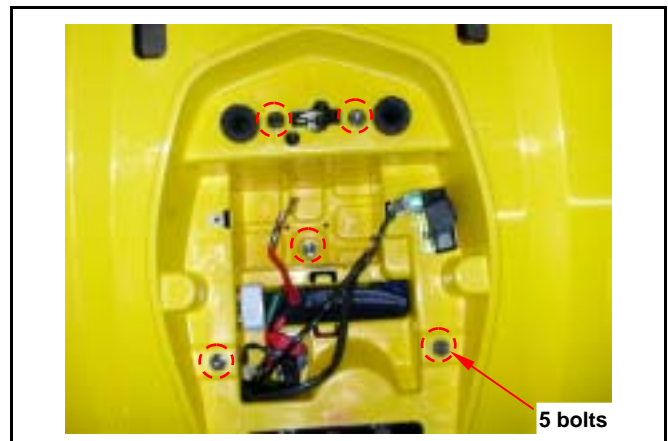

Loosen the 2 bolts, which connect the rear tender and frame, these 2 bolts just below the rear fender light coupler side.

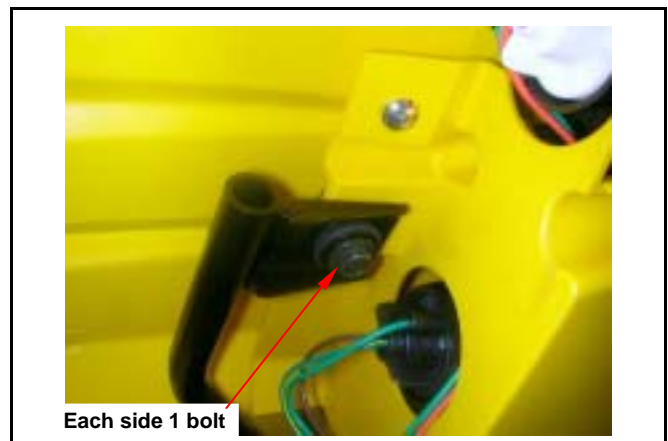

Loosen the 2 bolts, which connect the rear tender and frame, these 2 bolts just below the rear fender rear side.

Remove taillight couplers, and then remove rear fender.

### Installation

Install in reverse order of removal procedures.

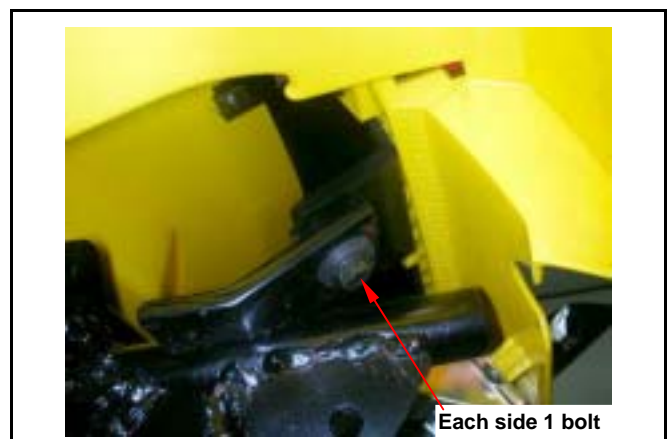

**Disassembly**

Remove rear fender and rear bumper upper side 2 screws.

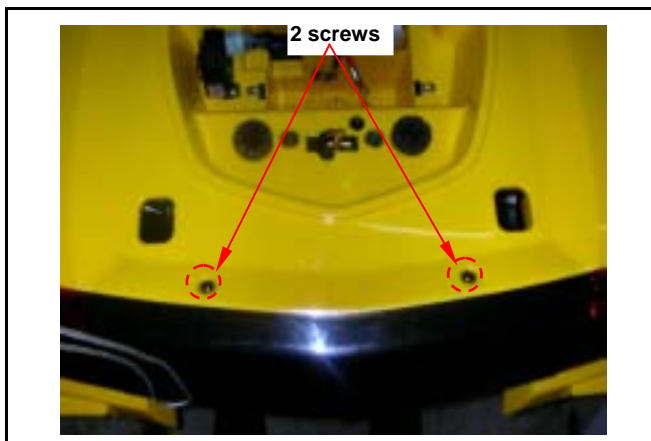

Remove rear fender and rear bumper inner screws (each side 2 screws).  
Remove rear bumper and taillights.

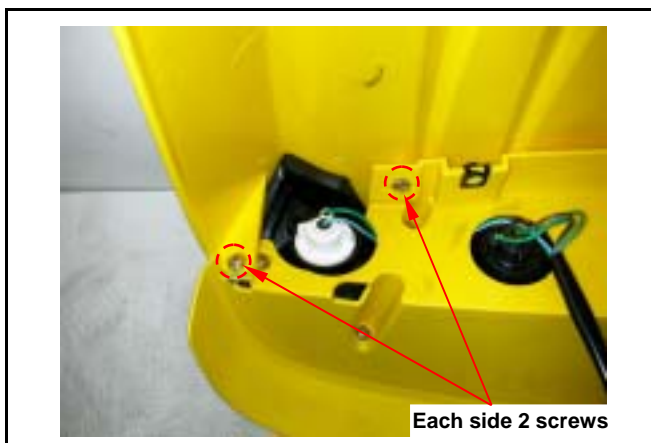

Remove tail cover and rear bumper 6 screws, and then remove tail cover.  
Remove license light 2 screws, and then remove license light.

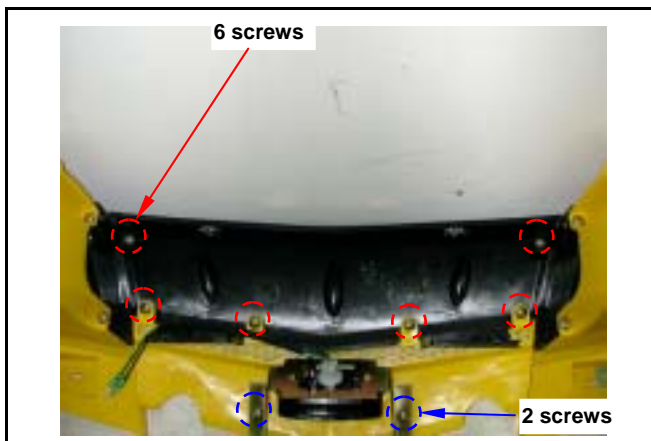

Loosen the 10 screws, and then remove taillights (each side 5 screws).

**Installation**

Install in reverse order of removal procedures.

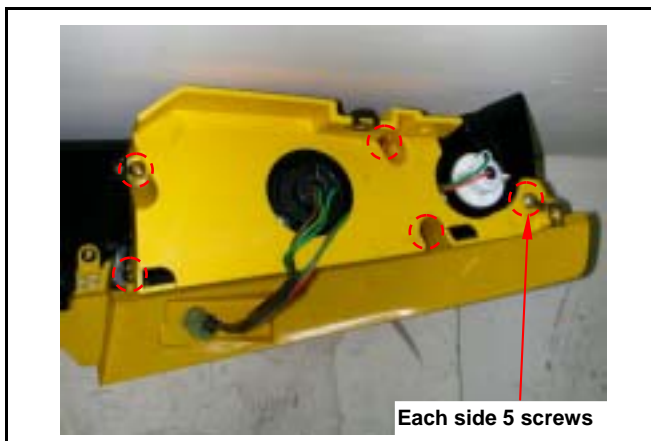

## 13. BODY COVER

### Footrest

#### Remove

Loosen the 6 bolts, which connect the footrest and frame, these 6 bolts just be twin under the footrests.

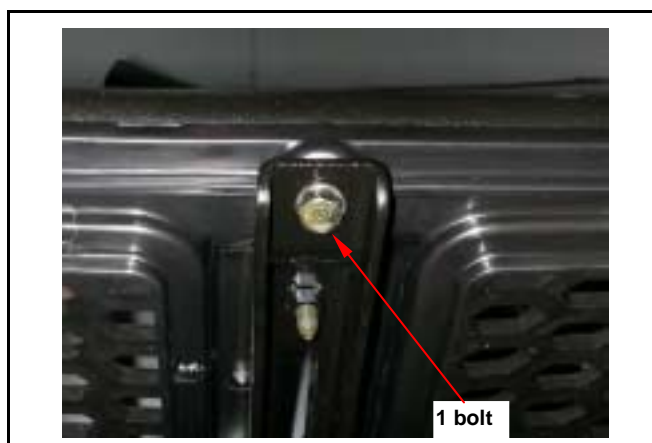
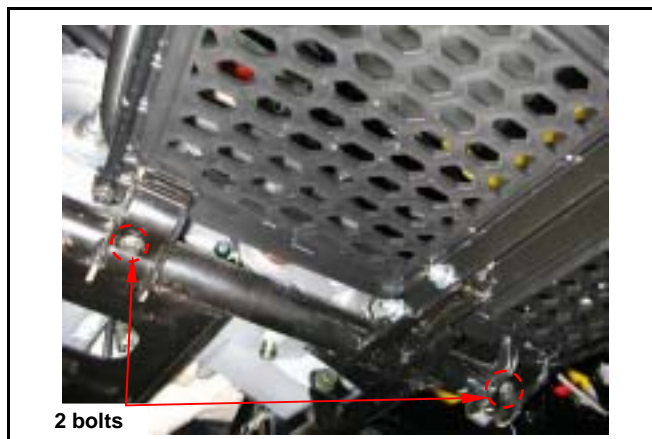

Loosen the 4 bolts, and then remove footrest bars and footrests. These 4 bolts just are the right and left footrests.

#### Installation

Install in reverse order of removal procedures.



# 14. FRONT BRAKE & FRONT WHEEL

Mechanism Diagram.....	14-1	Adding Brake Fluid .....	14-8
Maintenance Description .....	14-2	Brake fluid replacement / Air-bleed..	14-9
Trouble Diagnosis .....	14-3	Front Brake Caliper.....	14-10
Front Wheel.....	14-4	Brake Disk .....	14-11
Front Wheel Hub.....	14-4	Front Brake Master Cylinder .....	14-11
Disk Brake System Inspection .....	14-7		

## Mechanism Diagram

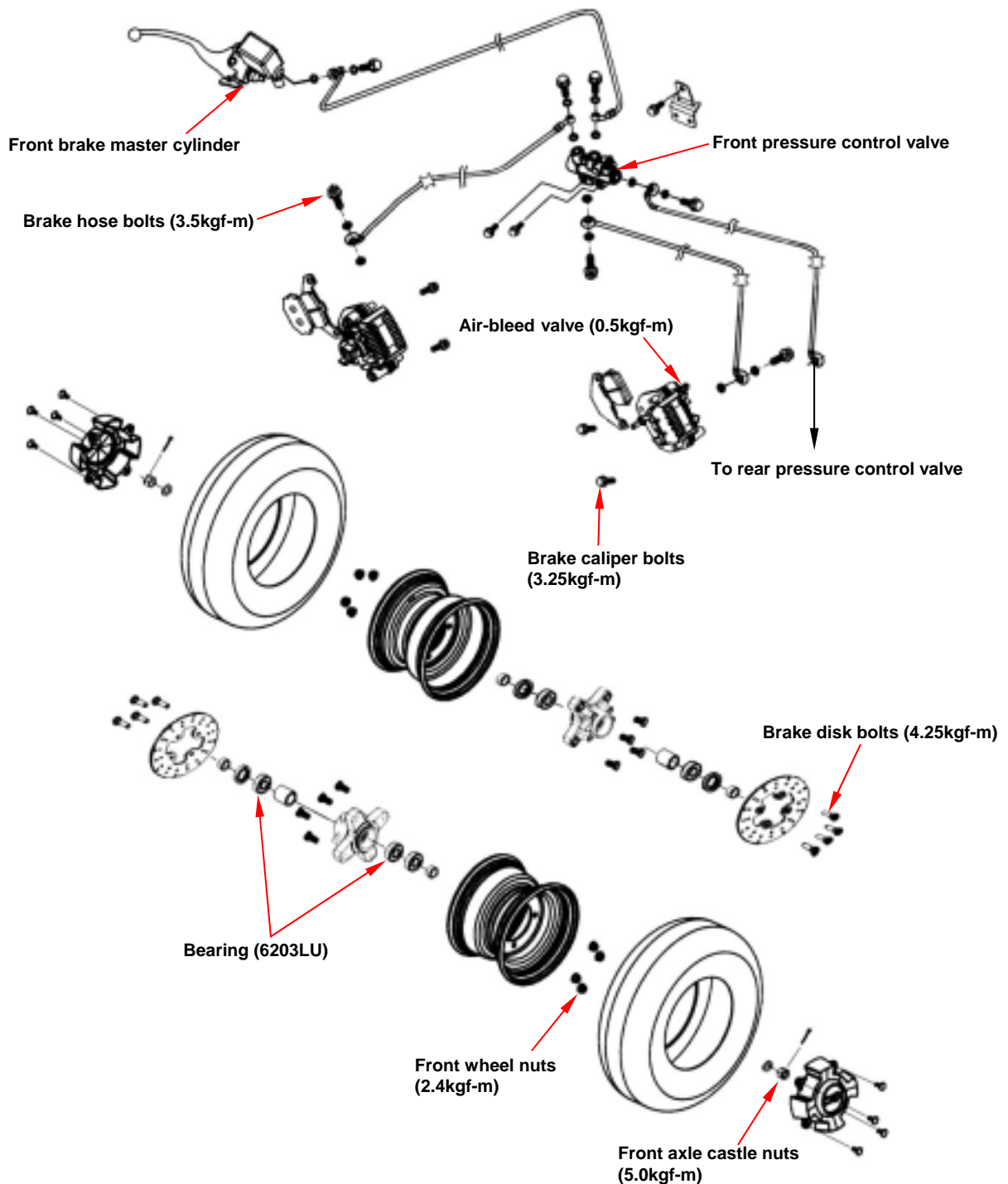

## 14. FRONT BRAKE & FRONT WHEEL

### Maintenance Description

#### Operational precautions

#### Caution

Inhaling asbestos may cause disorders of respiration system or cancer, therefore, never use air hose or dry brush to clean brake parts. Use vacuum cleaner or other authorized tool instead.

- The brake caliper can be removed without removing the hydraulic system.
- After the hydraulic system is removed, or the brake system is felt to be too soft, bleed the hydraulic system.
- While refilling brake fluid, care should be taken not to let the foreign material entering into the brake system.
- Do not spill brake fluid on the painted surfaces, plastic or rubber parts to avoid damage.
- Check the operation of the brake system before riding.
- Please refer to the Maintenance Manual of tubeless tire in respect to the removal, repair and installation of the tire.

#### Specifications

Item	Standard (mm)	Limit (mm)
The thickness of front and rear brake disk	3.500	2.000
Front and rear brake disk eccentricity	< 0.100	0.300
Master cylinder inner diameter	14.000~14.043	14.055
Master cylinder piston outer diameter	13.957~13.984	13.945
Diameter of front disk	175.000	-
Thickness of front brake lining	5.500	2.000

Tire pressure as cold: 0.8 kg/cm<sup>2</sup> (12psi)

#### Torque values

Brake hose bolts	3.50kgf-m
Bolt for brake caliper	3.25kgf-m
Bolts for the brake disk	4.25kgf-m
Brake lever nut	1.00kgf-m
Air-bleed valve	0.50kgf-m
Front wheel nut	2.40kgf-m
Front axle castle nut	5.00kgf-m

**Trouble Diagnosis****Soft brake lever**

1. Air inside the hydraulic system
2. Hydraulic system leaking
3. Worn master piston
4. Worn brake pad
5. Poor brake caliper
6. Worn brake lining/disk
7. Low brake fluid
8. Blocked brake hose
9. Warp/bent brake disk
10. Bent brake lever

**Hard operation of brake lever**

1. Blocked brake system
2. Poor brake caliper
3. Blocked brake pipe
4. Seized/worn master cylinder piston
5. Bent brake lever

**Uneven brake**

1. Dirty brake lining/disk
2. Poor wheel alignment
3. Clogged brake hose
4. Deformed or warped brake disk
5. Restricted brake hose and fittings

**Tight brake**

1. Dirty brake lining/disk
2. Poor wheel alignment
3. Deformed or warped brake disk

**Brake noise**

1. Dirty lining
2. Deformed brake disk
3. Poor brake caliper installation
4. Imbalance brake disk or wheel

**Hard steering**

1. Faulty tire
2. Insufficient tire pressure

**Front wheel wobbling**

1. Faulty tire
2. Worn front brake drum bearing
3. Bent rim
4. Axle nut not tightened properly

**Steers to one side**

1. Bent tie rods
2. Wheel installed incorrectly
3. Unequal tire pressure
4. Incorrect wheel alignment



## 14. FRONT BRAKE & FRONT WHEEL

### Front Wheel

#### Removal

Raise the front wheels off the ground by placing a jack or other support under the frame.  
Remove the front wheel axle cover (4 screws).

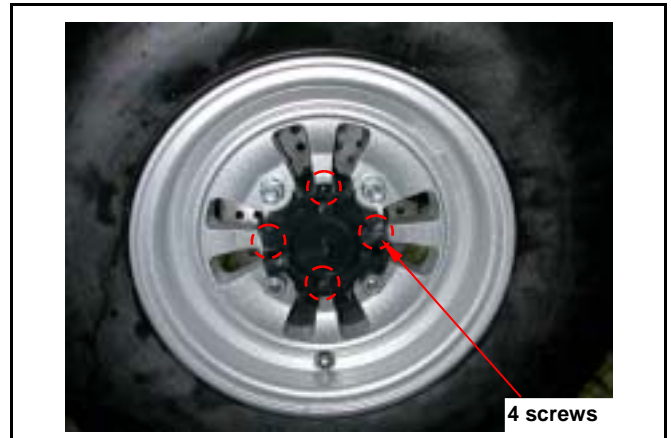

Remove the front wheel nuts, and then remove front wheels.

#### Installation

Install the front wheel and tighten the nuts.  
**Torque: 2.4kgf-m**

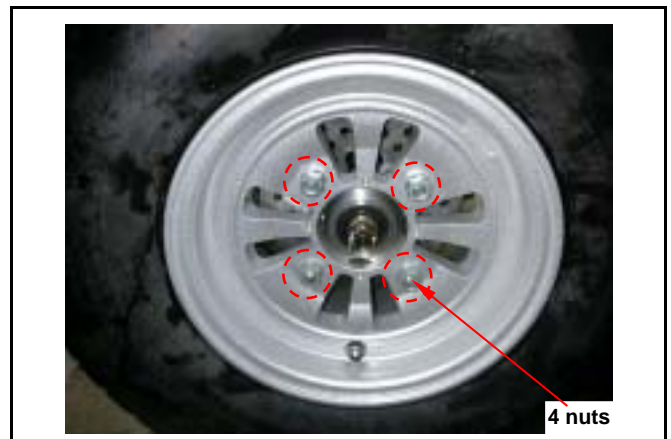

### Front Wheel Hub

#### Removal

Remove front brake caliper (2 bolts).

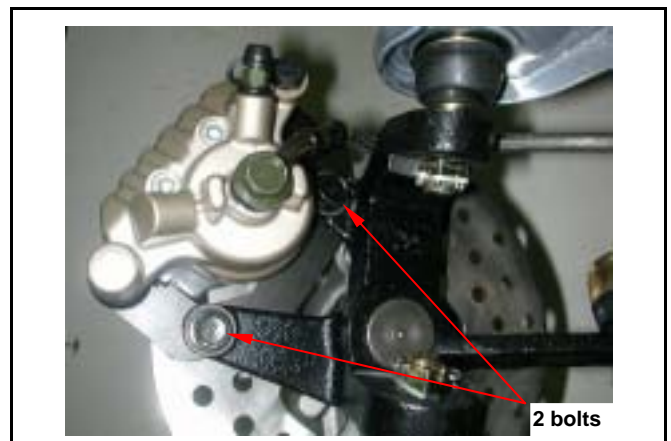

Remove cotter pin, wheel hub nut and washer.  
Remove wheel hub and brake disk.

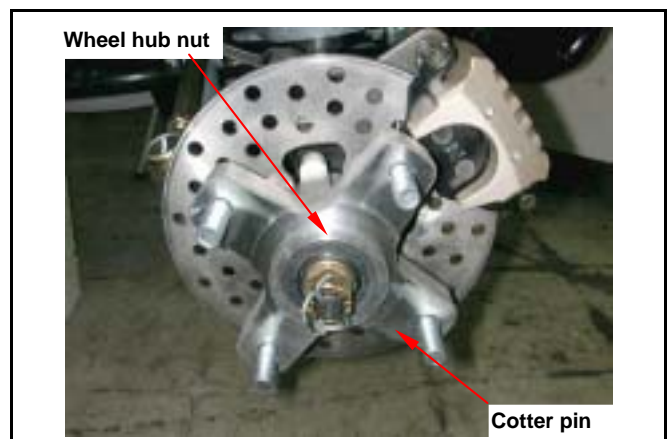

## Inspection

Check bearings on wheel hub.  
 Rotate each bearing's inner ring with fingers.  
 Check if bearings can be turned in smooth and silent, and also check if bearing outer ring is mounted on wheel hub.  
 If bearing rotation is uneven, noising, or loose bearing mounted, then replace it.  
 Check oil seal for wear or damage, and replace it if necessary.

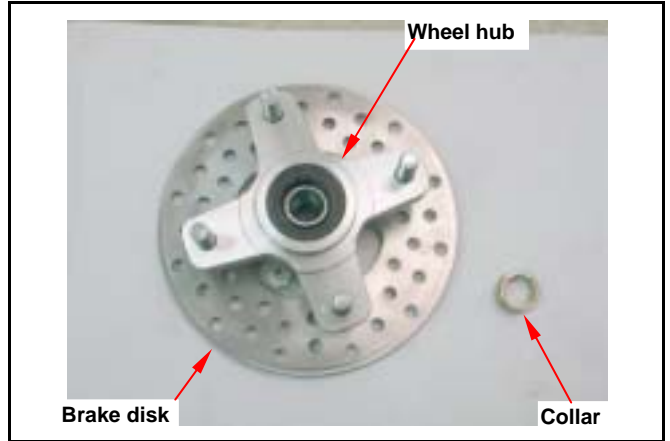

## Disassembly

### Caution

- Never install used bearings. Once bearing removed, it has to be replaced with new one.

Remove out side bearing and seal from wheel hub using following tools.

**Special tool:**  
**Inner bearing puller**

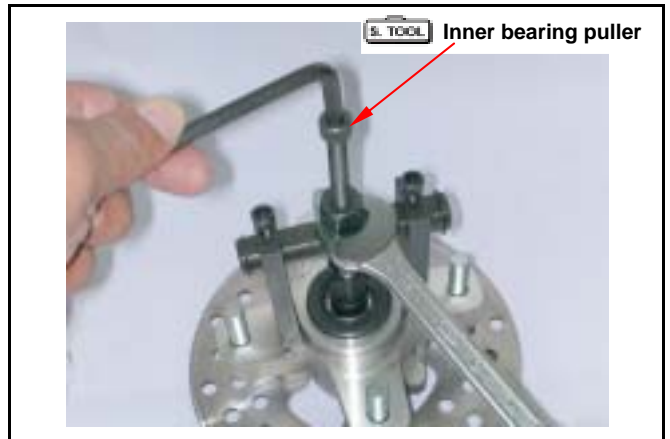

Remove front wheel hub bearing inner spacer.

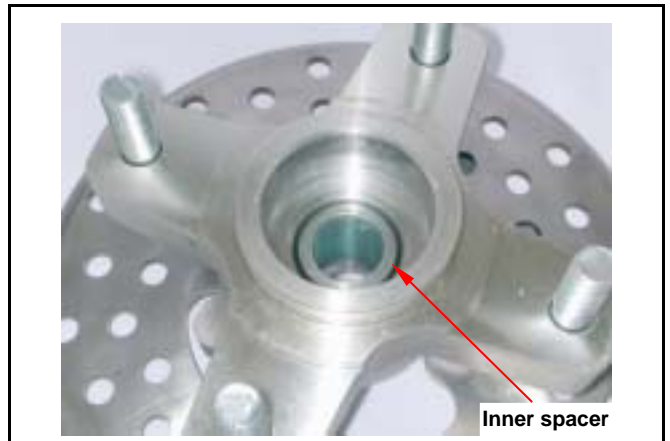

Remove inner side bearing and oil seal from wheel hub using following tools.

**Special tool:**  
**Inner bearing puller**

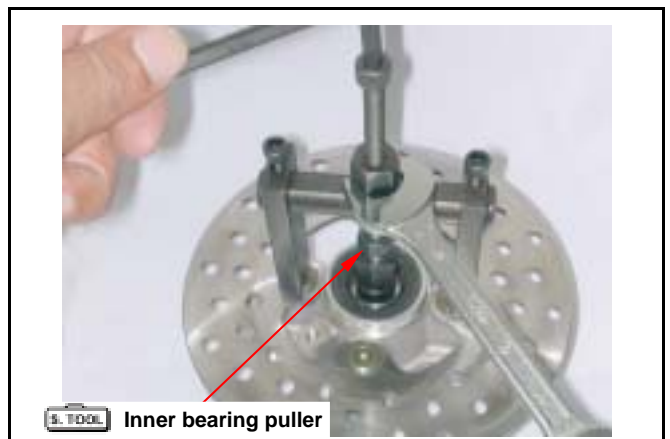

## 14. FRONT BRAKE & FRONT WHEEL

Remove 4 socket bolts, and then remove the brake disk from wheel hub.

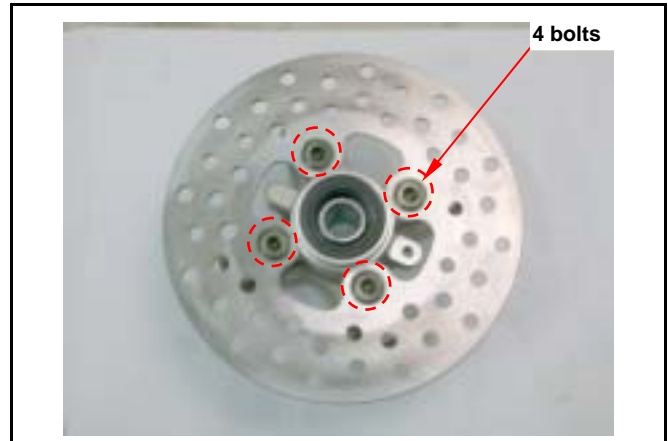

### Assembly

Install brake disk.  
Install new inner side bearing and seal into front wheel hub.  
Install front wheel hub bearing inner spacer.  
Install new out side bearing and seal into front wheel hub.

#### Special tool:

**Bearing driver (6203)**

**Oil seal drive (24x35x7)**

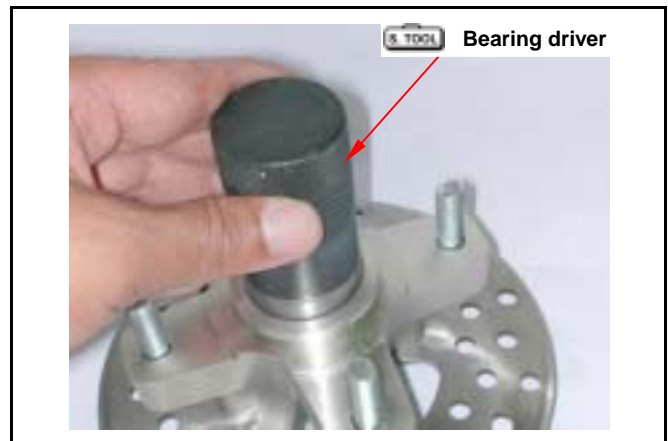

### Installation

Install the front brake disk to the wheel hub.  
Install wheel hub and brake disk on to knuckle.  
Install wheel hub washer and tighten the wheel hub nut.

**Torque: 5.0kgf-m**

Install cotter pin.

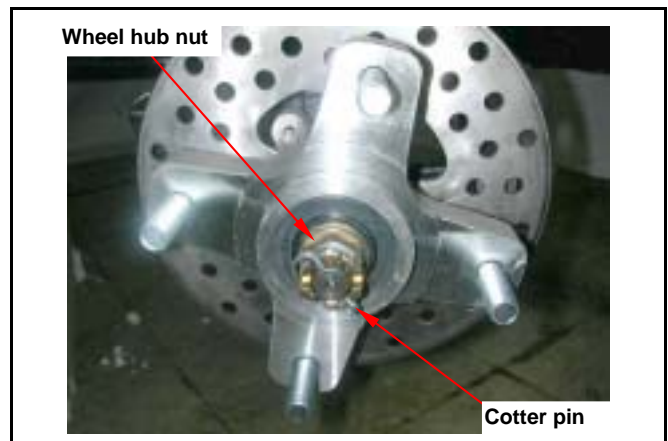

Install front brake caliper.

**Torque: 3.25kgf-m**

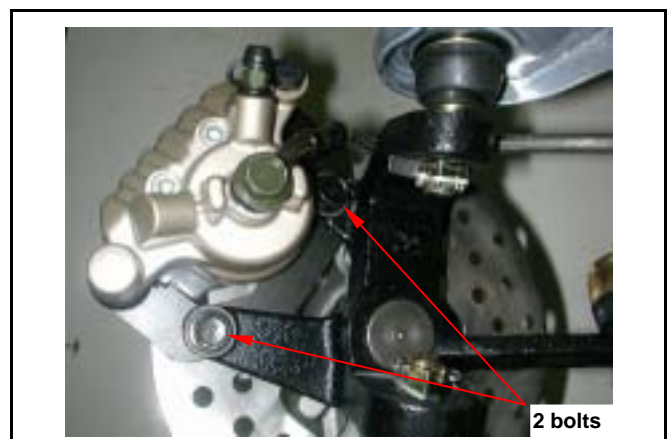

### Disk Brake System Inspection

#### Inspection

By visual examination whether divulges or the damage, with spanner inspection brake tube seam whether becomes less crowded, and the inspection handle bar turn right or turn left, or pressure the cushion, whether besides the pipeline protection department, whether there is interferes, contacts other parts of.

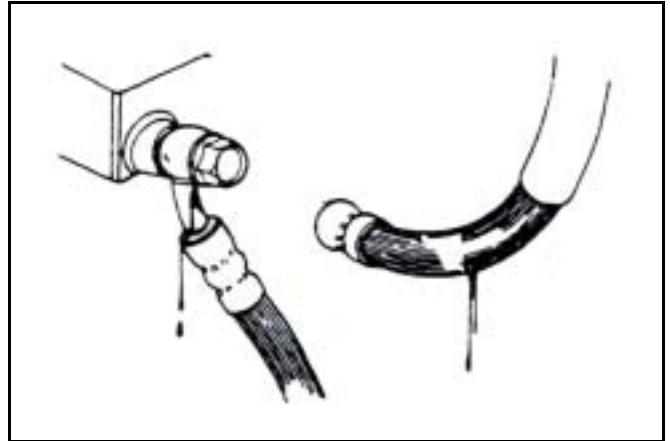

Check the brake from behind the brake caliper. The brake pad must be replaced with new lining when the brake pad wear limit reaches the brake disk.

**⚠ Caution**

- Check the front brake lining must be removed front wheel first.

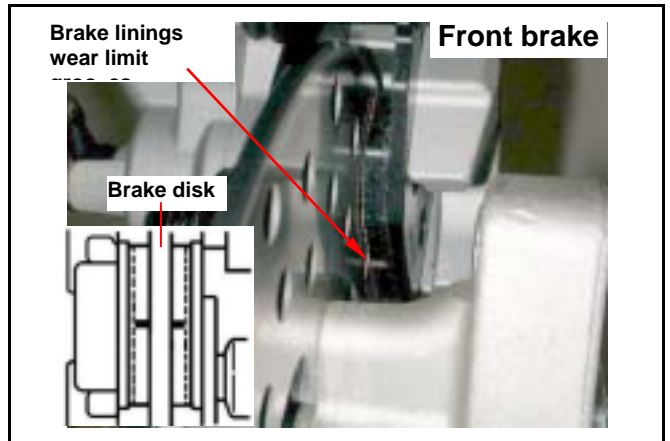

Park the ATV on a level ground, and check if fluid level is under the “LOWER” mark. Recommended Brake Fluid: WELL RUN BRAKE OIL (DOT 3).

**⚠ Caution**

- The vehicles inclined or just stop, the survey oil level could not be accurate, had to settle the 3~5 minute.
- In order to prevent has the chemical change, please do not use counterfeiting or other unclear trade marks brake fluid.
- Uses by all means must with the trade mark brake fluid, guarantees the ghost vehicle efficiency.

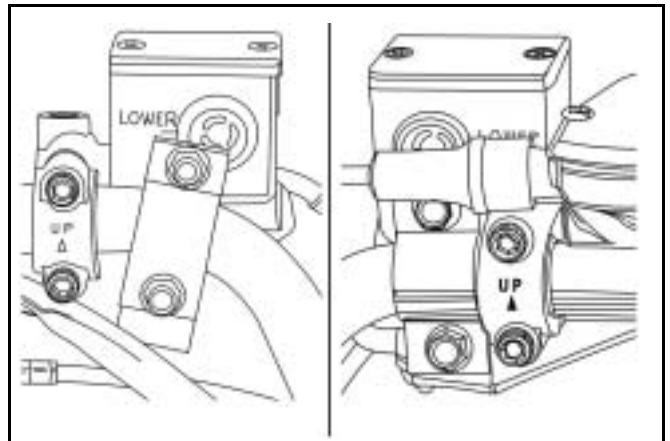

## 14. FRONT BRAKE & FRONT WHEEL

### Adding Brake Fluid

Before the brake fluid reservoir is removed, turn the handle so that the brake fluid reservoir becomes horizontal, and then remove the brake fluid reservoir.

When maintenance brake system, will be supposed to paint the surface or the rubber parts catches up by the rags.

#### Caution

Supplement brake fluid please do not surpass the upper limit, spilled brake fluid on painted surfaces, plastic or rubber components may result in their damages.

Remove the master cylinder cap and diaphragm. Increases the high quality brake fluid, uses by all means must with the trade mark brake fluid joins in the master cylinder. Clean the dirty brake disk.

#### Caution

- The dirty brake lining or disk will reduce the brake performance.
- To mixed non-compatible brake fluid will reduce brake performance.
- Foreign materials will block the system causing brake performance to be reduced or totally lost.

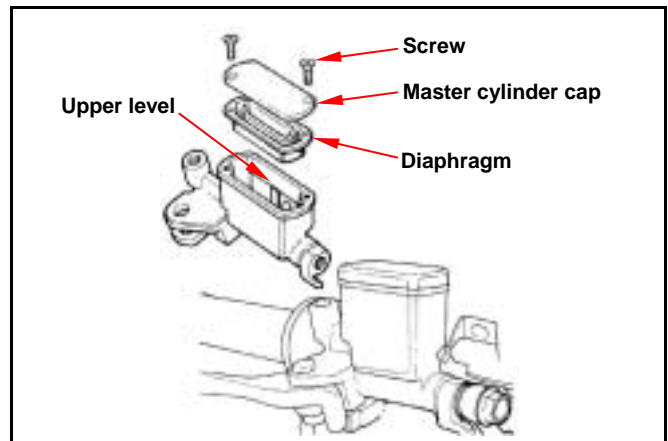
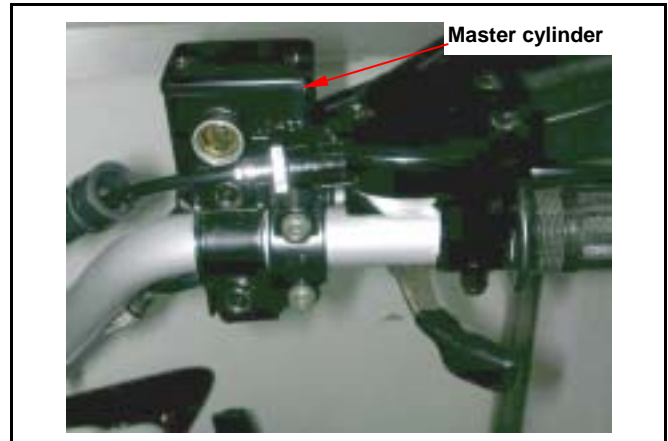

### Brake fluid replacement / Air-bleed

Connect drain hose to air-bleed valve.  
 Open the drain valve on the caliper and operate the brake lever until the old brake fluid is entirely drained out.  
 Close the drain valve and add specified brake fluid into the brake master cylinder.  
**Recommended brake fluid: WELLRUN DOT 3 brake fluid**

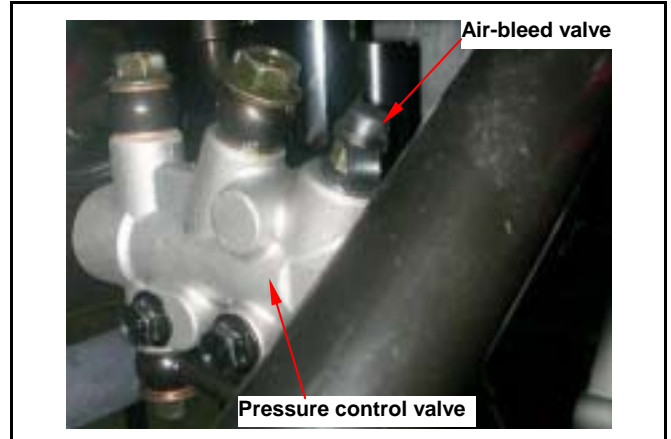

Air-bleed must from pressure control valve fist. Connect one end of transparent hose to the air-bleed valve, and put the other end into a container.

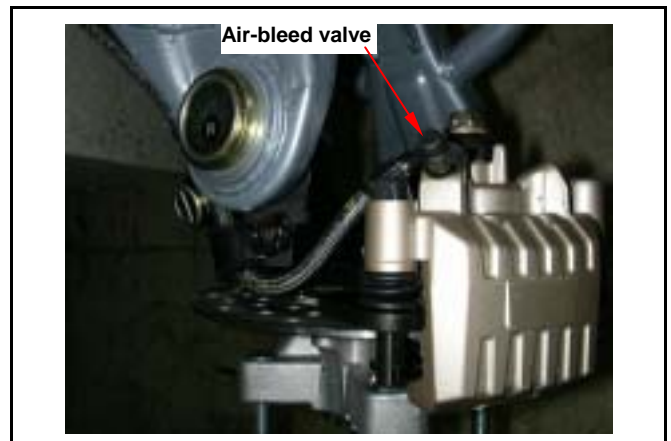

Open the drain valve around 1/4 turns, and at the same time hold the brake lever until the there is no air bubble in the drain hose and also feeling resistance on the brake lever.

Close the drain valve when finishing the brake system refilling fluid procedure, and operate the brake lever to check whether air bubble is in brake system or not.

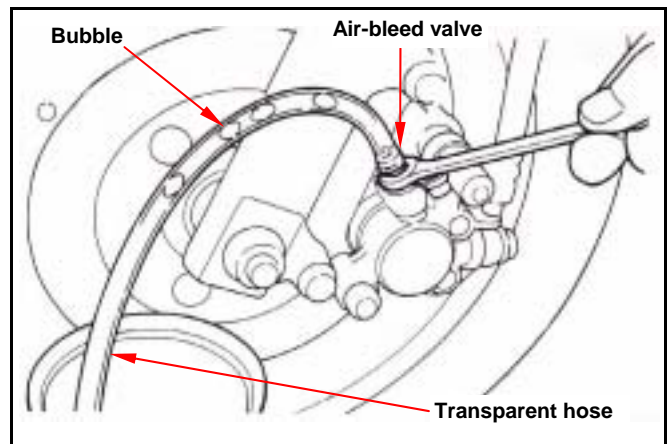

If brake is still soft, please bleed the system as described below:

1. Tightly hold the brake lever and open the drain valve around 1/4 turns, and then close the valve.

**Caution**

- Do not release the brake lever before the drain valve is closed.
- Always check the brake fluid level when carrying out the air bleeding procedure to avoid air enters into the system.

2. Slowly release the brake lever, and wait for a few seconds until it reaches its top position.
3. Repeat the steps 1 and 2 until there is no air bubble at the end of the hose.
4. Tightly close the drain valve.
5. Make sure the brake fluid is in the UPPER level of the master cylinder, and refill the fluid if necessary.
6. Cover the cap.

## 14. FRONT BRAKE & FRONT WHEEL

### Front Brake Caliper

#### Removal

Place a container under the brake caliper, and loosen the brake hose bolt and finally remove the brake hose.

#### Caution

Do not spill brake fluid on painted surfaces.

Remove two caliper bolts and the caliper.

#### Inspection

Make sure the brake linings condition. Replace the linings if the brake linings wear limitation groove close to the brake disk.

#### Brake lining replacement

Remove two guide pins.  
Compress caliper mounting plate, and then remove brake linings.  
Install new linings, and tighten the guide pins.

#### Installation

Install the brake caliper and tighten the attaching bolts securely.

**Torque: 3.25kgf-m**

#### Caution

- Use M8 x 20 mm flange bolt only.
- Long bolt will impair the operation of brake disk.

Use two seal washers and hose bolts to lock the hose and brake caliper in place.

**Torque: 3.5kgf-m**

Refill up the brake fluid to the reservoir and make necessary air bleeding.

Brake hose bolt



2 bolts



Guide pins



## Brake Disk

### Inspection

Visually check the brake disk for wear or break. Measure the thickness of the disk at several places. Replace the disk if it has exceeded the service limit.

**Allowable limit: 2.5 mm**

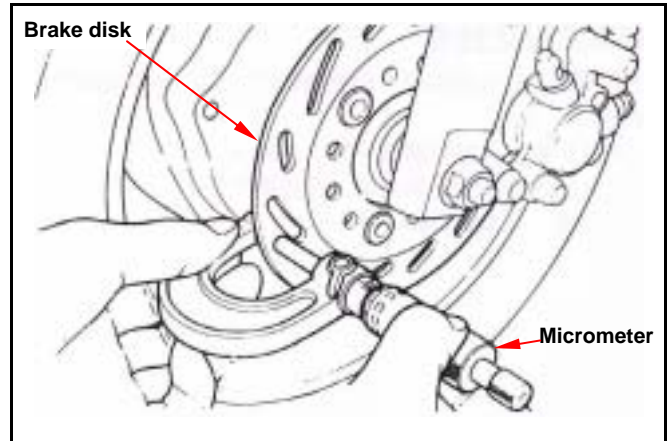

Remove the brake disk from wheel hub. Check the disk for deformation and bend.

**Allowable limit: 0.30 mm**

### ⚠ Caution

- The dirty brake lining or disk will reduce the brake performance.
- Brake lining includes the asbestos ingredient, cannot use the air-gun to be clean, the operator should dress the mouthpiece and the glove, use vacuum cleaner clean it.

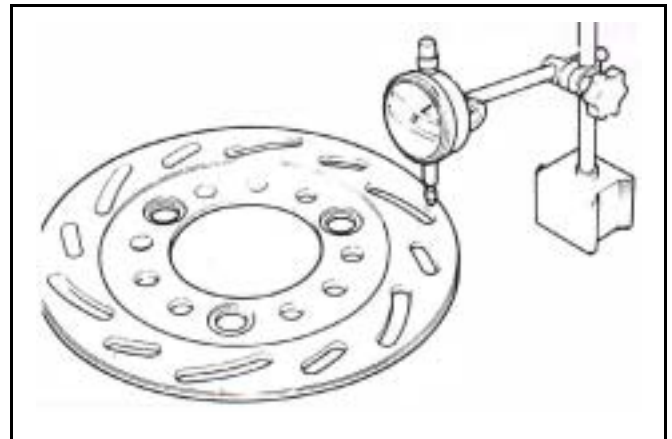

## Front Brake Master Cylinder

### Master Cylinder Removal

### ⚠ Caution

Do not let foreign materials enter into the cylinder.

### ⚠ Caution

The whole set of master cylinder, piston, spring, diaphragm and cir clip should be replaced as a set.

Push the lead of brake light switch, and then remove brake light switch.  
 Drain out the brake fluid.  
 Remove the brake lever from the brake master cylinder.  
 Remove the brake hose.  
 Remove the master cylinder socket bolts and the master cylinder.

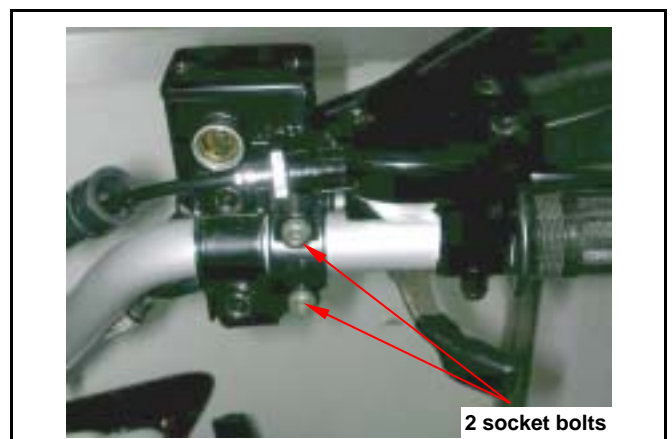



# 14. FRONT BRAKE & FRONT WHEEL



Remove the rubber boot.  
 Remove the cir clip.  
 Remove the piston and the spring.  
 Clean the master cylinder with recommended brake fluid.

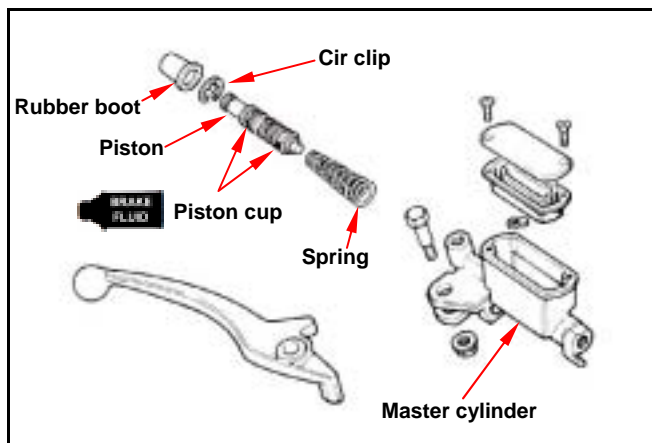

## Master Cylinder Inspection

Check the master cylinder for damage or scratch.  
 Replace it if necessary.  
 Measure the cylinder inner diameter at several points along both X and Y directions.  
 Replace the cylinder if the measured values exceed allowable limit.

**Allowable limit: 14.055 mm**

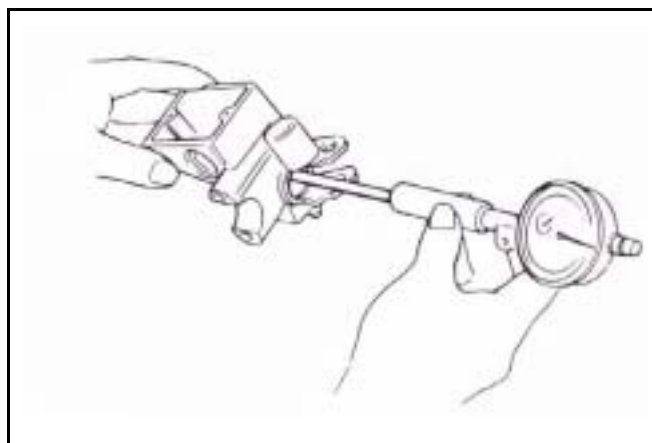

Measure the outer diameter of the piston.  
 Replace the piston if its measured value exceeds allowable limit.

**Allowable limit: 13.945 mm**

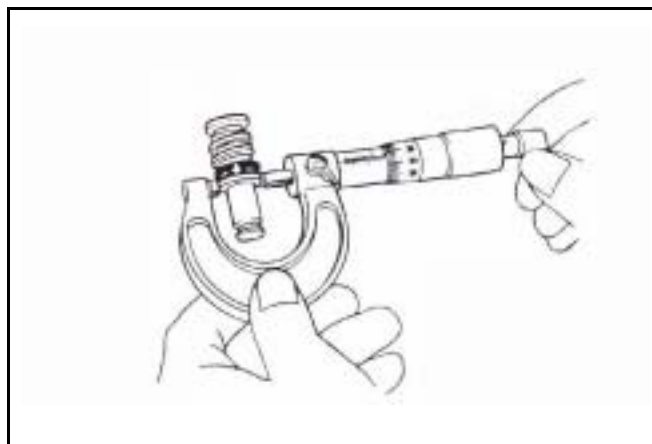

## Master Cylinder Assembly

### ⚠ Caution

- It is necessary to replace the whole set comprising piston, spring, piston cup, and cir clip.
- Make sure there is no dust on all components before assembling.

Apply clean brake fluid to the piston cup, and then install the cup onto the piston.

Install the larger end of the spring onto the master cylinder.

The master cup's cavity should be face inside of master cylinder when installing the master cup.

Install the cir clip.

### ⚠ Caution

- Never install cup lip in the opposite direction.
- Make sure the cir clip is seated securely in the groove.

Install the rubber boot into groove properly.

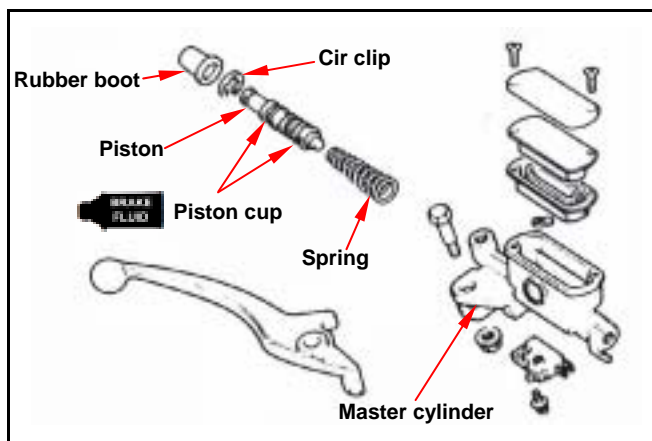

**Master Cylinder Install**

Install the rubber pad into the groove correctly. Place the master cylinder onto handlebar, and install the bolts.

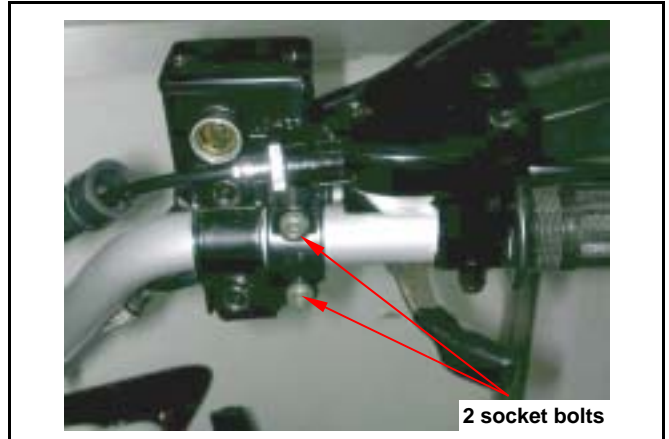

Install the brake lever, and connect leads to brake light switch.

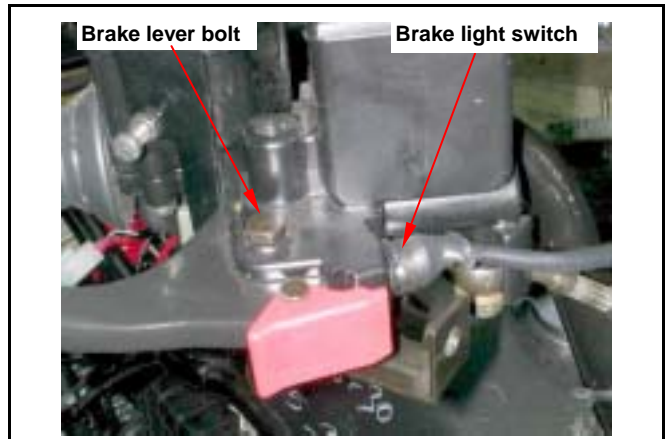

Connect brake hoses with 2 new washers. Tighten the brake hose bolt to the specified torque value.

**Torque: 3.5kgf-m**

Make sure the hose is installed correctly. Install all wires, hoses, and components carefully so avoid to twisting them together.

**⚠ Caution**

Improper routing may damage leads, hoses or pipes.

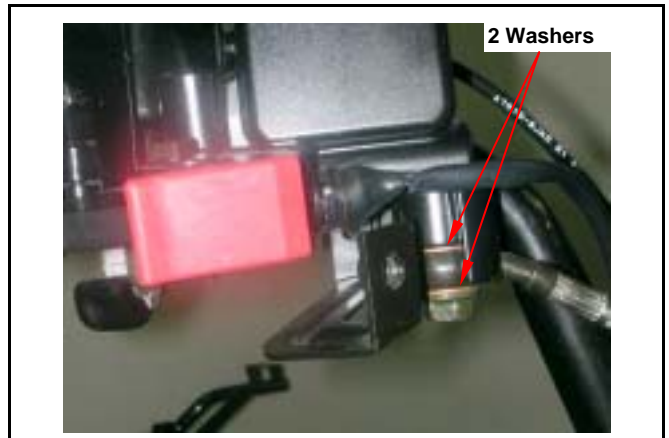

**⚠ Caution**

Kink of brake leads, hose or pipe may reduce brake performance.

Add specified brake fluid and bleed the system.

Notes:



# 15. STEERING / FRONT SUSPENSION

Mechanism Diagram .....15-1	Steering Tie-Rod ..... 15-6
Operational Precautions .....15-2	Knuckle..... 15-7
Trouble Diagnosis .....15-2	Front Cushion ..... 15-8
Steering Handle .....15-3	Suspension Arm ..... 15-9
Steering Shaft .....15-5	Toe-In ..... 15-10

## Mechanism Diagram

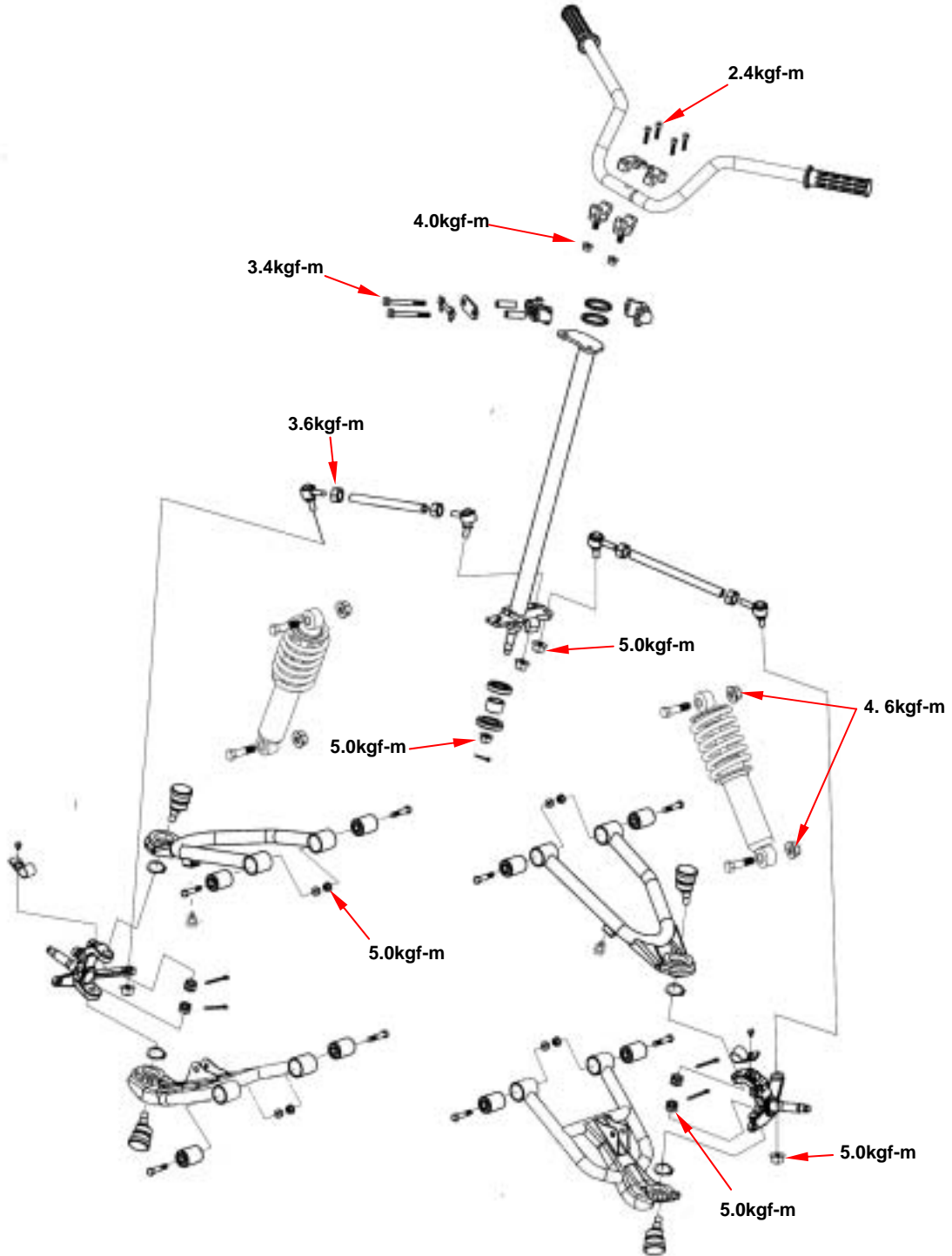

## 15. STEERING / FRONT SUSPENSION

---

### Operational Precautions

#### Torque Values

Handlebar upper holder bolt	2.4kgf-m
Handlebar under holder nut	4.0kgf-m
Steering shaft holder bolt	3.4kgf-m
Steering shaft nut	5.0kgf-m
Steering tie-rod nut	5.0kgf-m
Knuckle nut	5.0kgf-m
Tie rod lock nut	3.6kgf-m
Suspension arm nut	5.0kgf-m
Front cushion mounting nut	4.6kgf-m

### Trouble Diagnosis

#### Hard to steer

- Faulty tire.
- Steering shaft holder too tight.
- Insufficient tire pressure.
- Faulty steering shaft bushing.
- Damaged steering shaft bushing.

#### Front wheel wobbling

- Faulty tire.
- Worn front brake drum bearing.
- Bent rim.
- Axle nut not tightened properly.

#### Steers to one side

- Bent tie rods.
- Wheel installed incorrectly.
- Unequal tire pressure.
- Bent frame.
- Worn swing arm pivot bushings.
- Incorrect wheel alignment.

#### Front suspension noise

- Loose front suspension fasteners.
- Binding suspension link.

#### Hard suspension

- Faulty front swing arm bushings.
- Improperly installed front swing arms.
- Bent front shock absorber swing rod.

#### Soft suspension

- Weak front shock absorber springs.
- Worn or damage front swing arm bushings.

**Steering Handle**

**Removal**

Remove the handle cover, meter set, handle protect cover and front fender. (Refer to chapter 13)



Loosen the socket bolts for the front brake master cylinder, and remove front brake master cylinder.

**⚠ Caution**

Do not let foreign materials enter into the cylinder.

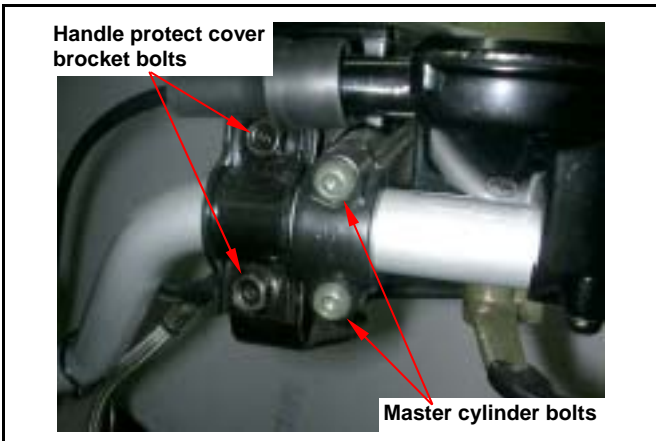

Remove 2 screws, and then remove throttle hosing holder and throttle hosing.

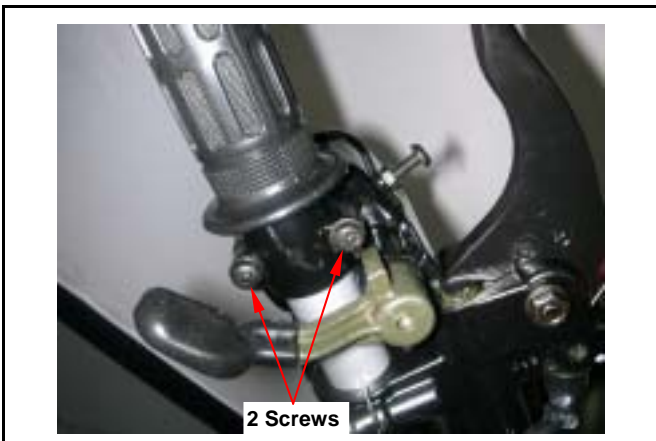

Loosen the socket bolts for the front brake master cylinder, and remove front brake master cylinder.

**⚠ Caution**

Do not let foreign materials enter into the cylinder.

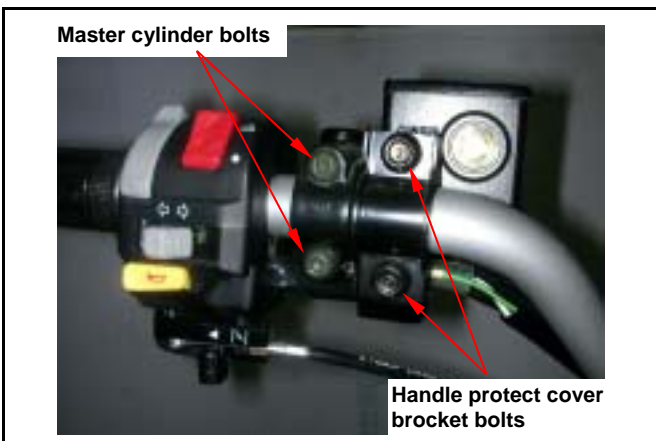

## 15. STEERING / FRONT SUSPENSION

Loosen 2 screws, and then remove handle left switch and choke hosing.

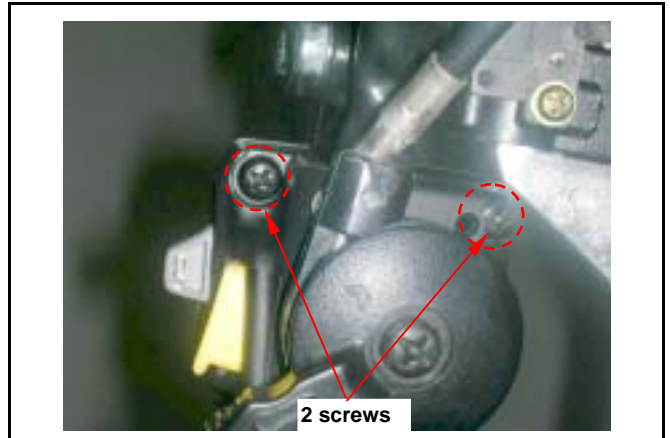

Remove switch wire band.  
Remove handle mounting bolt, and then remove the handle upper holder, handle.

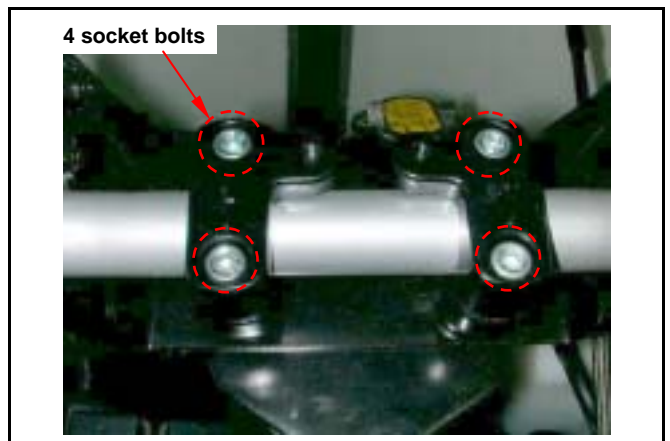

Remove 2 nuts to remove handle under holder and meter bracket.

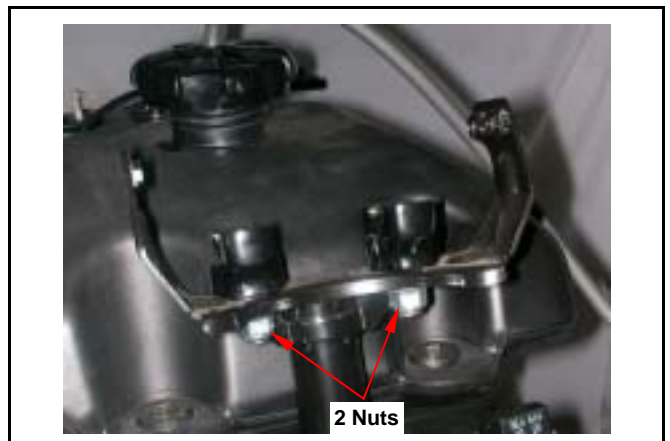

### Installation

Install in reverse order of removal procedures.

#### Torque value:

Handlebar under holder nut	4.0kgf-m
Handlebar upper holder bolt	2.4kgf-m

## Steering Shaft

### Remove

Remove cotter pins, and loosen right and left steering tie-rod nuts.  
Remove tie-rod.

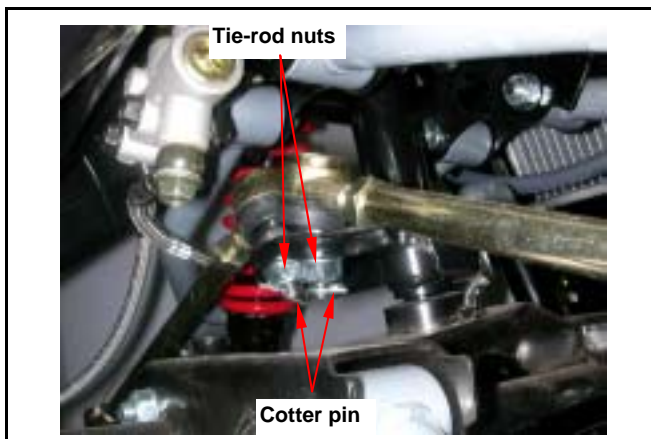

Remove the cotter pin below steering shaft, and remove steering shaft nut and washer.

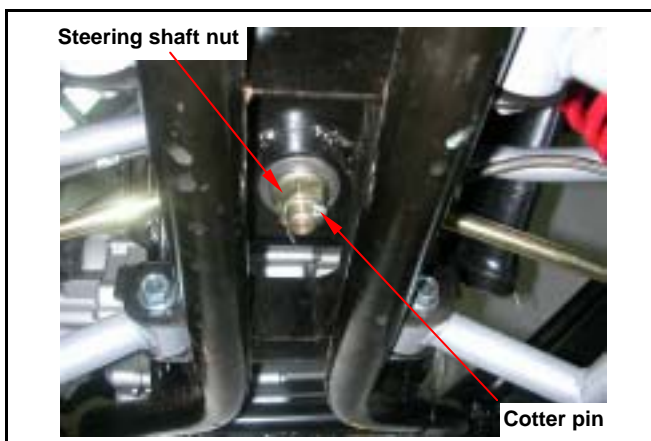

Bend out the steering shaft holder nut fixed plate. Loosen 2 bolts, and then remove steering shaft holder, nut fixed plate, pressed plate and steering shaft.



### Inspection

Check oil rings for wear or damage, and replace it if necessary.

Measure the holder inner diameter.

**Maximum limit: Ø39.5 mm**

### Installation

Install in reverse order of removal procedures.  
Apply with grease onto oil liner and holder.

### Torque value:

<b>Steering shaft holder bolt</b>	<b>3.4kgf-m</b>
<b>Steering shaft nut</b>	<b>5.0kgf-m</b>
<b>Steering tie-rod nut</b>	<b>5.0kgf-m</b>

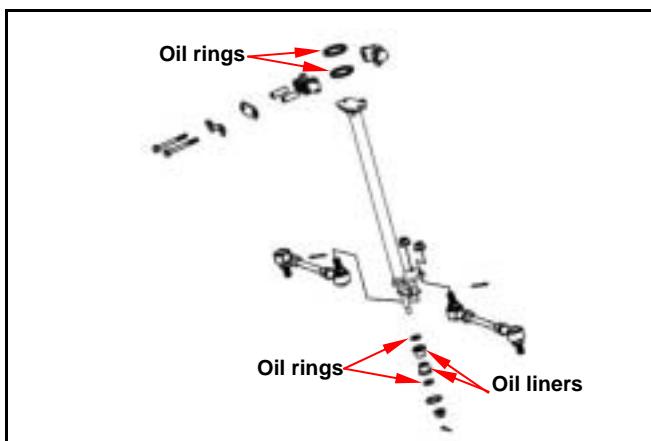



## 15. STEERING / FRONT SUSPENSION

### Steering Tie-Rod

#### Remove

Remove cotter pin and tie-rod nut from steering shaft side.

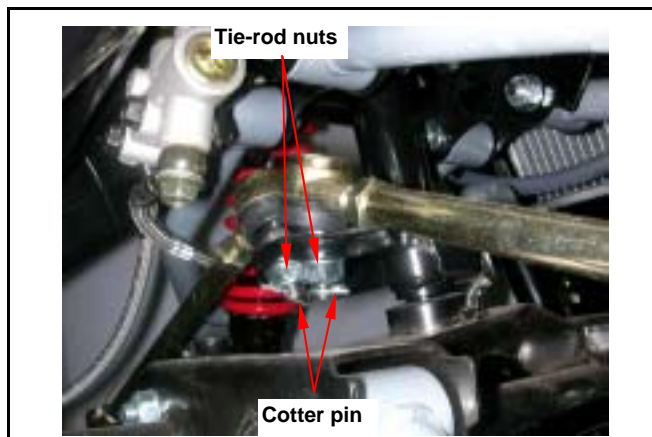

Remove cotter pin and tie-rod nut from wheel side.

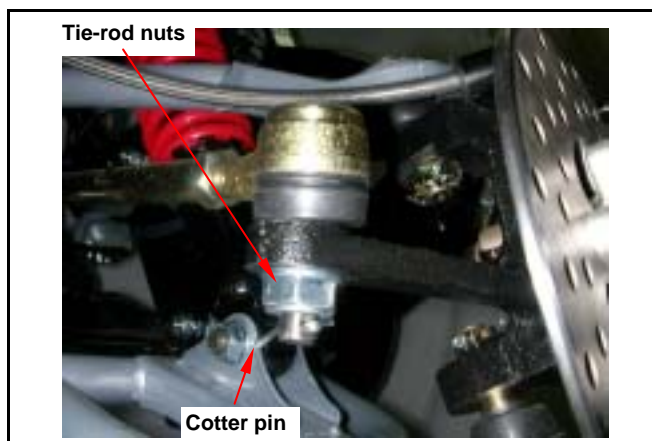

#### Inspection

Inspect the tie-rod for damage or bending.  
 Inspect the ball joint rubbers for damage, wear or deterioration.  
 Turn the ball joints with fingers. The ball joints should turn smoothly and quietly.

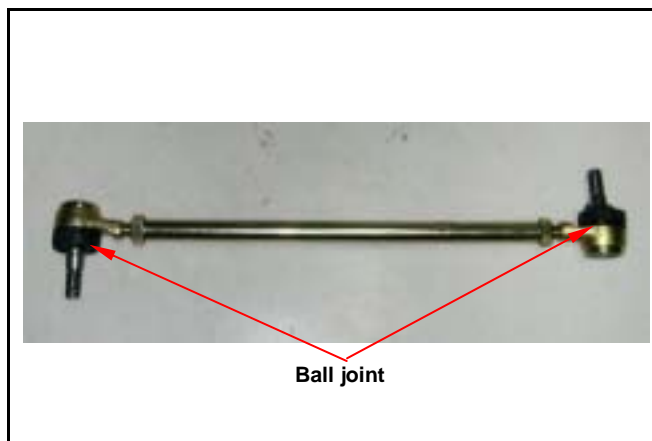

#### Installation

Install the ball joint with "adjustment groove" on the wheel side.

Install tie-rod nuts, and tighten the nuts.

**Torque value: 5.0kgf-m**

After tightened the tie-rod nut, install the cotter pin.



## Knuckle

### Remove

Remove front wheel, front brake caliper, front wheel hub and brake disk.



Remove cotter pin and tie-rod nut, remove tie rod.

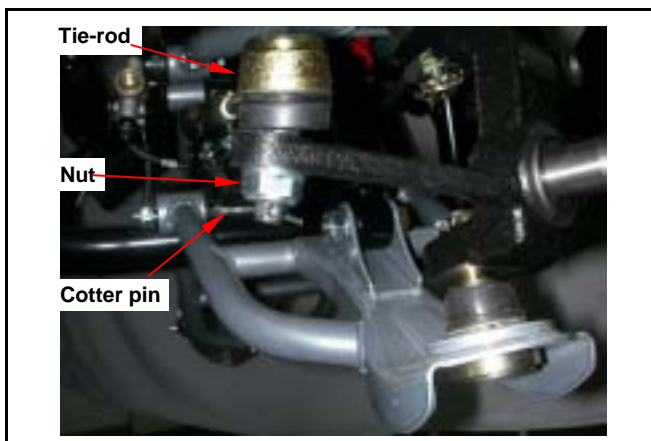

Remove cotter pin and ball joint nut.  
Remove upper and under ball joints by ball joint driver.  
Remove the knuckle.

**Special Tool : ball joint driver**

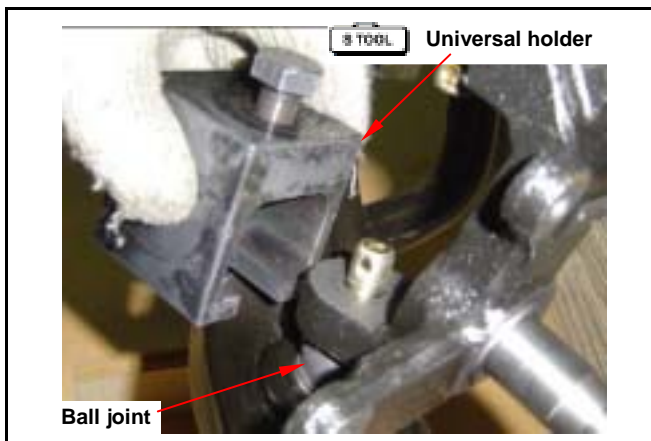

### Inspection

Inspect the upper and under ball joints and knuckle for damaging or cracking.

### Installation

Install in reverse order of removal procedures.

#### Torque value:

**Steering tie-rod nut            5.0kgf-m**

**Ball joint nut                    5.0kgf-m**

After tightened the nuts, install the cotter pins.

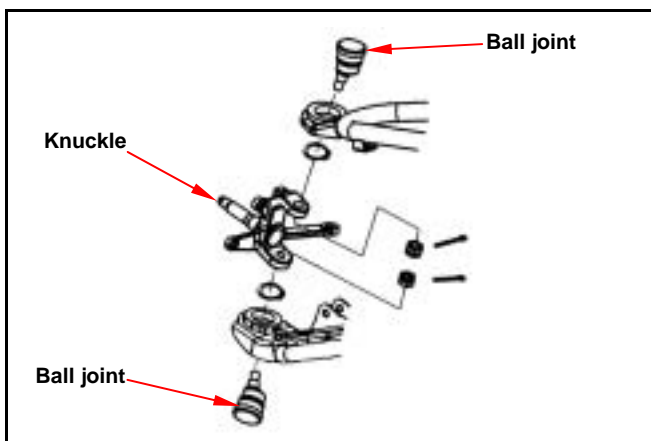

## 15. STEERING / FRONT SUSPENSION



### Front Cushion

#### Remove

Remove front cushion under bolt nut, and remove the bolt.



Remove front cushion upper bolt nut, and remove the bolt and cushion.



#### Installation

Install in reverse order of removal procedures.

#### Torque value:

Front cushion nut      4.6kgf-m

**Suspension Arm**

**Remove**

Remove front wheel, wheel hub, and brake caliper, brake disk, tie-rod, knuckle and front cushion.



Loosen upper suspension arm nuts, remove swing arm bolts.  
Remove upper suspension arm.

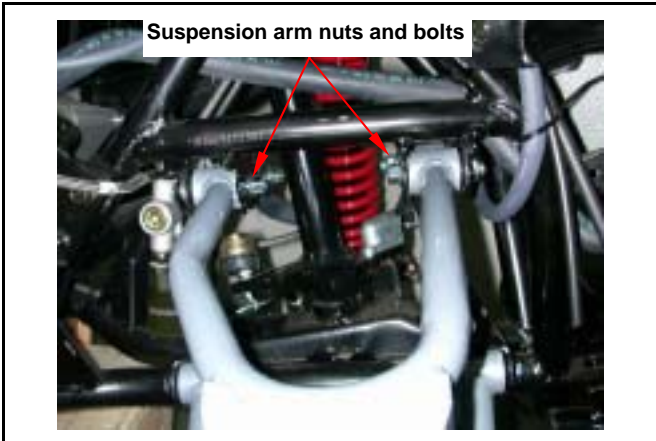

Loosen under suspension arm nuts, remove swing arm bolts.  
Remove under suspension arm.

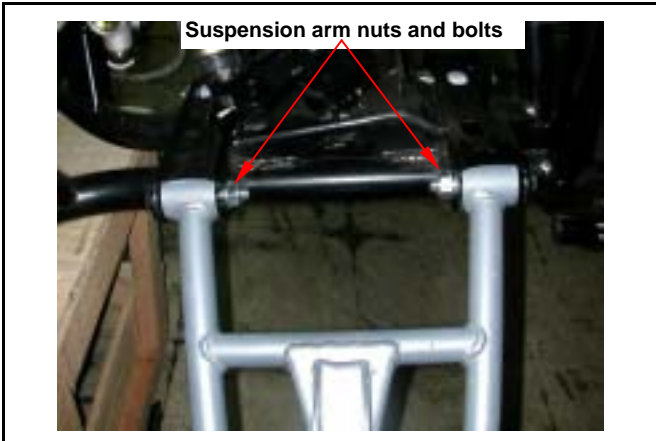

**Inspection**

Inspect the suspension arm, ball joint and bush for damage or bending.

**Installation**

Install in reverse order of removal procedures.

**Torque value:**

**Suspension arm nut 5.0kgf-m**

Lubricate with grease into suspension arm.

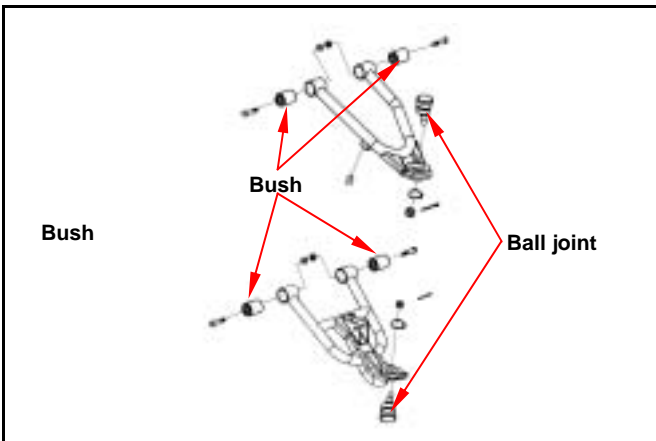

## 15. STEERING / FRONT SUSPENSION

### Toe-In

When repair or disassemble steering system parts, must to adjustment the toe-in.

Keep the vehicle on level ground and the front wheels facing straight ahead.

Mark the centers of the tires to indicate the axle center height.

Measure the distance between the marks.

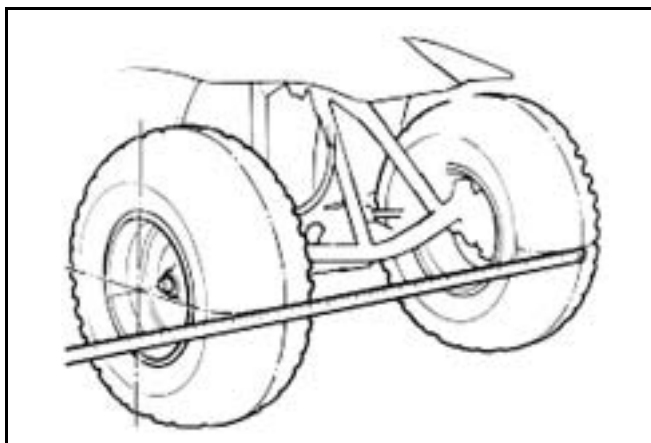

Carefully to move the vehicle back, let the wheels turn 180 degree, so the marks on the tires are aligned with the axle center height.

Measure the distance between the marks.

Calculate the difference in the front and rear measurements.

Toe-in:  $5 \pm 10$ mm

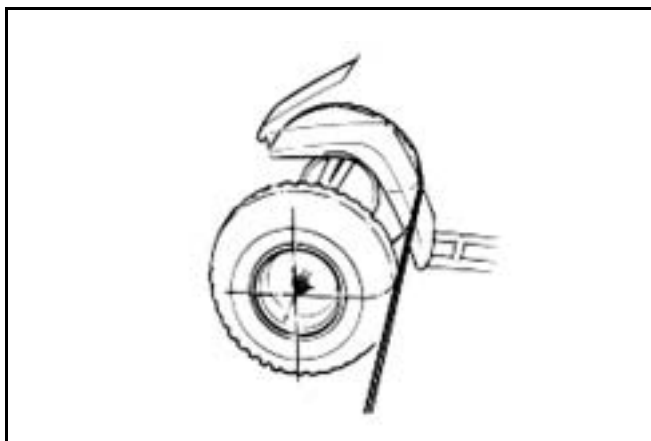

If the toe-in is out of standard, adjust it by hanging the length of the tie-rods equally by turning the tie-rod while holding the ball joint.

Loosen two side tie-rod lock nuts; turn the tie-rods to adjustment toe-in.

Tighten the lock nuts.

**Torque value: 3.6kgf-m**

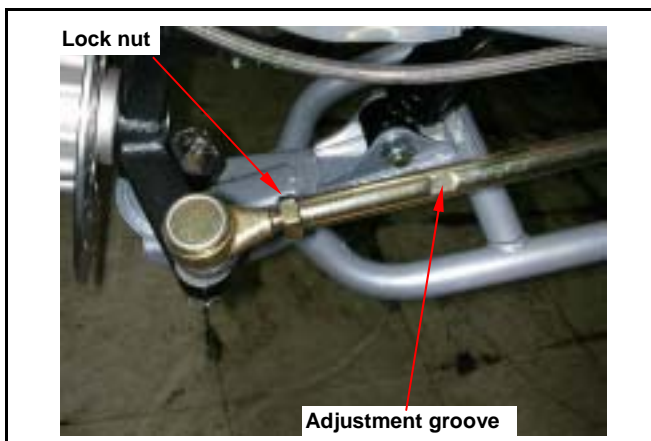

# 16. REAR BRAKE & REAR WHEEL & REAR CUSHION

<a href="#">Mechanism Diagram.....</a>	<a href="#">16-1</a>	<a href="#">Disk Brake System Inspection.....</a>	<a href="#">16-10</a>
<a href="#">Maintenance Description .....</a>	<a href="#">16-2</a>	<a href="#">Adding Brake Fluid .....</a>	<a href="#">16-11</a>
<a href="#">Trouble Diagnosis .....</a>	<a href="#">16-3</a>	<a href="#">Brake fluid replacement / Air-bleed..</a>	<a href="#">16-12</a>
<a href="#">Rear Wheel.....</a>	<a href="#">16-4</a>	<a href="#">Rear Brake Caliper .....</a>	<a href="#">16-13</a>
<a href="#">Rear Wheel Shaft Connector .....</a>	<a href="#">16-4</a>	<a href="#">Brake Disk .....</a>	<a href="#">16-14</a>
<a href="#">Rear Wheel Axle .....</a>	<a href="#">16-5</a>	<a href="#">Rear Brake Master Cylinder .....</a>	<a href="#">16-14</a>
<a href="#">Disk Brake System Inspection .....</a>	<a href="#">16-10</a>	<a href="#">Rear Cushion.....</a>	<a href="#">16-18</a>

## Mechanism Diagram

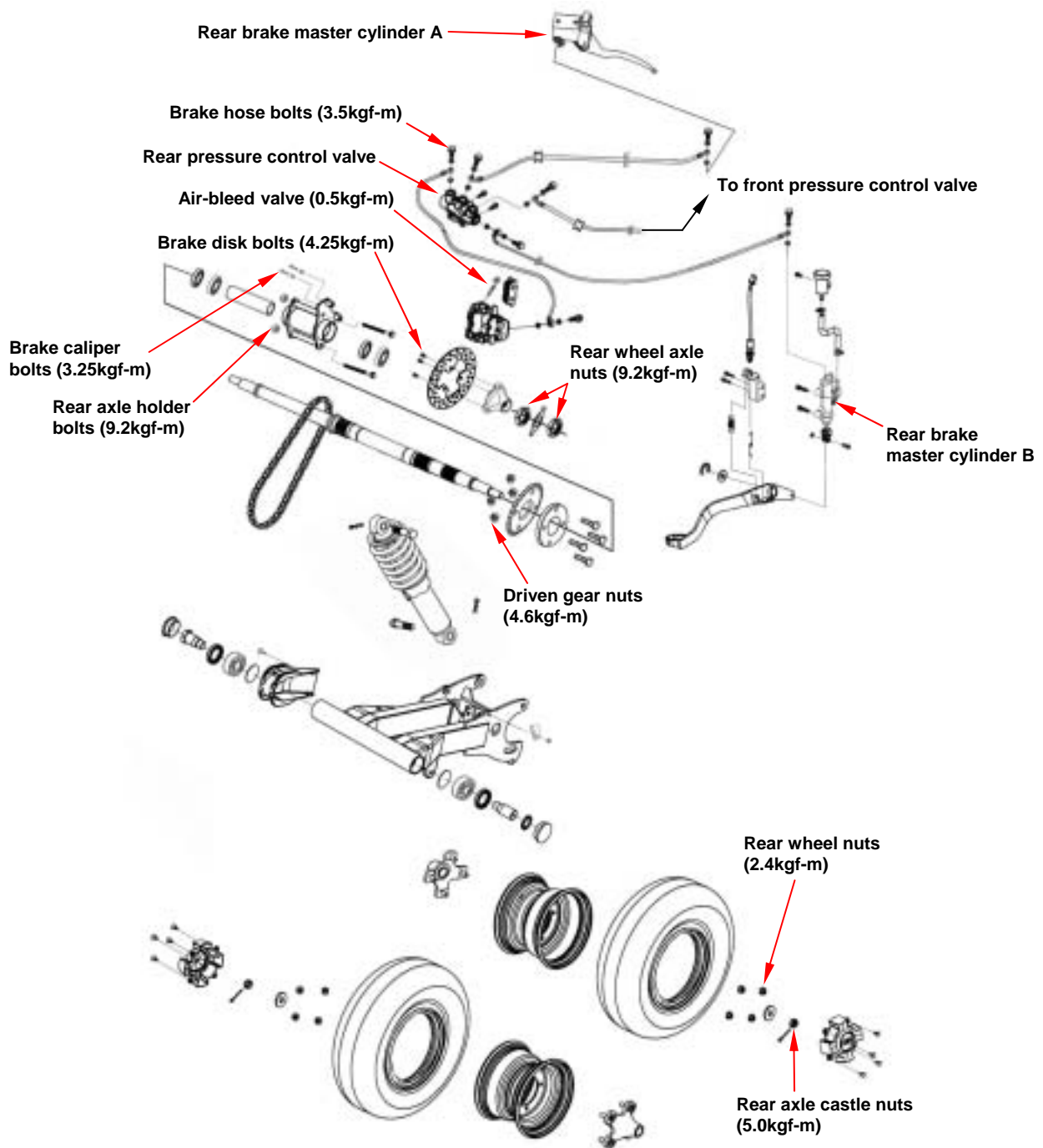

## Maintenance Description

### Operational precautions

#### Caution

Inhaling asbestos may cause disorders of respiration system or cancer, therefore, never use air hose or dry brush to clean brake parts. Use vacuum cleaner or other authorized tool instead.

- The brake caliper can be removed without removing the hydraulic system.
- After the hydraulic system is removed, or the brake system is felt to be too soft, bleed the hydraulic system.
- While refilling brake fluid, care should be taken not to let the foreign material entering into the brake system.
- Do not spill brake fluid on the painted surfaces, plastic or rubber parts to avoid damage.
- Check the operation of the brake system before riding.
- Please refer to the Maintenance Manual of tubeless tire in respect to the removal, repair and installation of the tire.

### Specifications

Item	Standard (mm)	Limit (mm)
The thickness of front and rear brake disk	4.000	2.500
Front and rear brake disk eccentricity	< 0.100	0.300
Master cylinder inner diameter (hand brake)	14.000 ~ 14.043	14.055
Master cylinder piston outer diameter (hand brake)	13.957 ~ 13.984	13.945
Master cylinder inner diameter (foot brake)	15.900 ~ 15.943	15.955
Master cylinder piston outer diameter (foot brake)	15.857 ~ 15.884	15.845
Diameter of rear disk	220.000	-
Thickness of rear brake lining	7.000	2.000

Tire pressure as cold: 0.8 kg/cm<sup>2</sup> (12psi)

### Torque values

Brake hose bolt	3.50kgf-m	Rear axle castle nut	5.00kgf-m
Bolt for brake caliper	3.25kgf-m	Rear axle holder bolt	9.20kgf-m
Bolts for the brake disk	4.25kgf-m	Rear wheel axle nut	9.20kgf-m
Brake lever nut	1.00kgf-m	Rear cushion mounting bolt	4.6kgf-m
Air-bleed valve	0.50kgf-m	Swing arm pivot bolt	9.2kgf-m
Rear wheel nut	2.40kgf-m		

### Special tools

Inner bearing puller: SYM-6204022

Rear axle bearing driver (6007LLU): SYM-9100100 RA1 A3017

**Trouble Diagnosis****Soft brake lever**

1. Air inside the hydraulic system
2. Hydraulic system leaking
3. Worn master piston
4. Worn brake pad
5. Poor brake caliper
6. Worn brake lining/disk
7. Low brake fluid
8. Blocked brake hose
9. Warp/bent brake disk
10. Bent brake lever

**Hard operation of brake lever**

1. Blocked brake system
2. Poor brake caliper
3. Blocked brake pipe
4. Seized/worn master cylinder piston
5. Bent brake lever

**Uneven brake**

1. Dirty brake lining/disk
2. Poor wheel alignment
3. Clogged brake hose
4. Deformed or warped brake disk
5. Restricted brake hose and fittings

**Tight brake**

1. Dirty brake lining/disk
2. Poor wheel alignment
3. Deformed or warped brake disk

**Brake noise**

1. Dirty lining
2. Deformed brake disk
3. Poor brake caliper installation
4. Imbalance brake disk or wheel

**Vibration or Wobble**

1. Axle is not tightened well
2. Bent rim
3. Axle bearings are worn
4. Faulty tires
5. Rear axle bearing holder is faulty

**Hard Suspension**

1. Bent damper rod
2. Faulty swing arm pivot bushings

**Soft Suspension**

1. Weak shock absorber damper
2. Weak shock absorber spring



## 16. REAR BRAKE & REAR WHEEL & REAR CUSHION



### Rear Wheel

#### Removal

Raise the rear wheels off the ground by placing a jack or other support under the frame.  
Remove rear axle cover (4 screws).

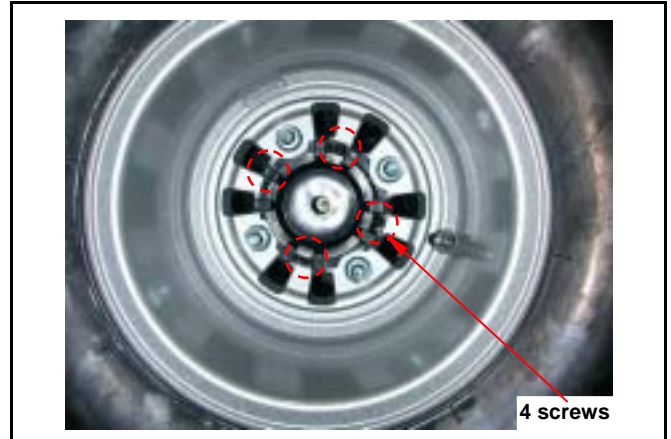

Remove the rear wheel nuts, and then remove rear wheels.

#### Installation

Install the rear wheel and tighten the nuts.  
**Torque: 2.4kgf-m**



### Rear Wheel Axle Connector

#### Removal

Remove cotter pin, rear wheel axle connector nut and washer.

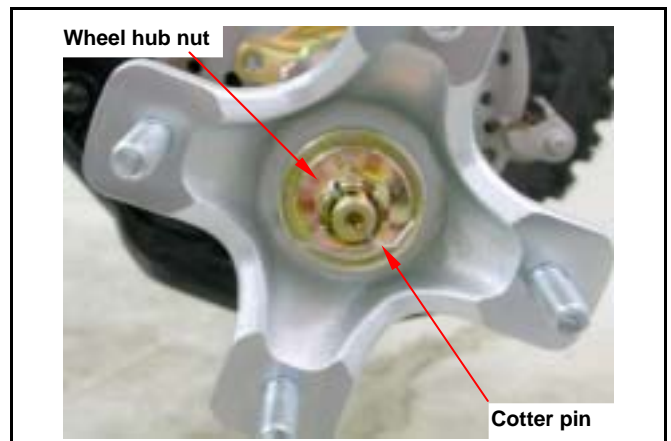

Remove right and left rear wheel axle connector.

#### Installation

Install the rear wheel shaft connector.  
Install wheel shaft connector washer and tighten the wheel shaft connector nut.

**Torque: 2.4kgf-m**  
Install cotter pin.



# 16. REAR BRAKE & REAR WHEEL & REAR CUSHION

## Rear Wheel Axle

Remove right and left rear wheel, wheel connector.  
Remove 2 bolts, and then remove rear brake caliper.



Remove 2 bolts and 1 nut, and remove drive chain cover.

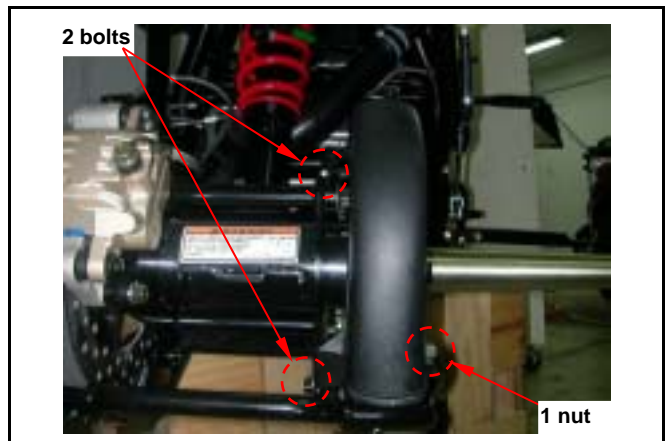

Remove 4 bolts to remove rear under protect.

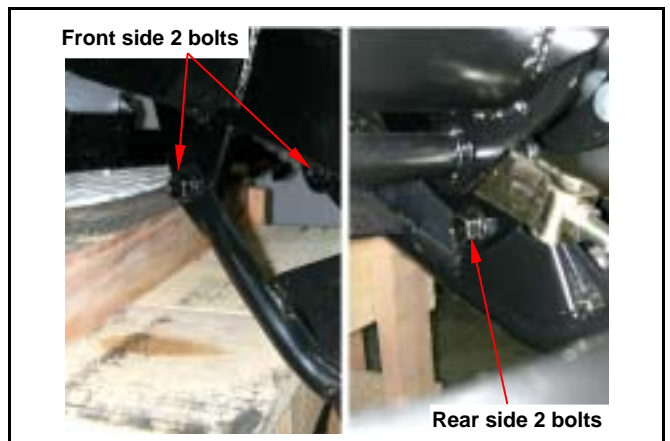

Remove drive chain lock clip, master link, and then remove drive chain.

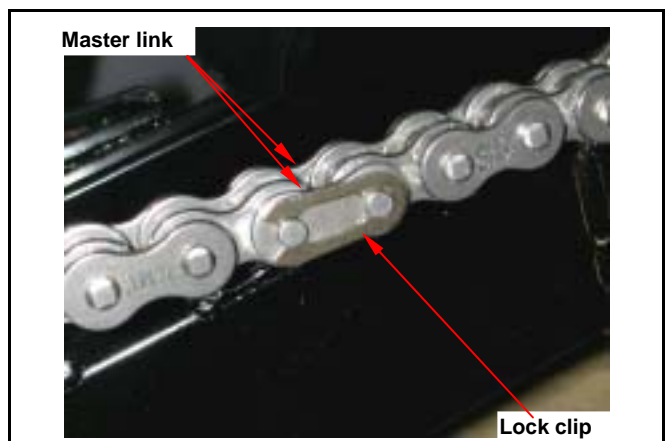

## 16. REAR BRAKE & REAR WHEEL & REAR CUSHION



Remove 4 nuts, and remove driven sprocket.  
Bend out the rear axle nut fixed plate.

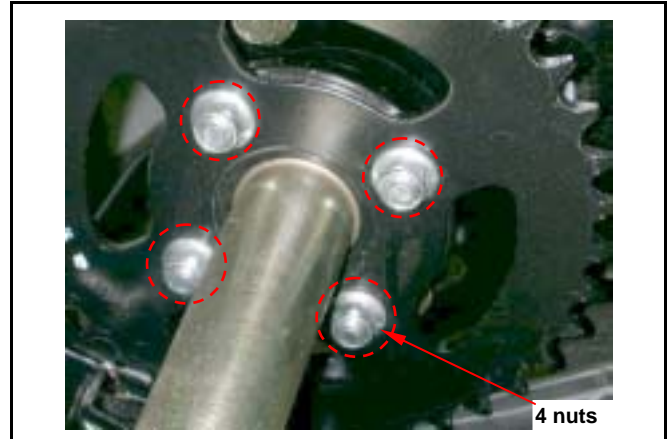

Bend out the rear wheel axle holder nut fixed plate.

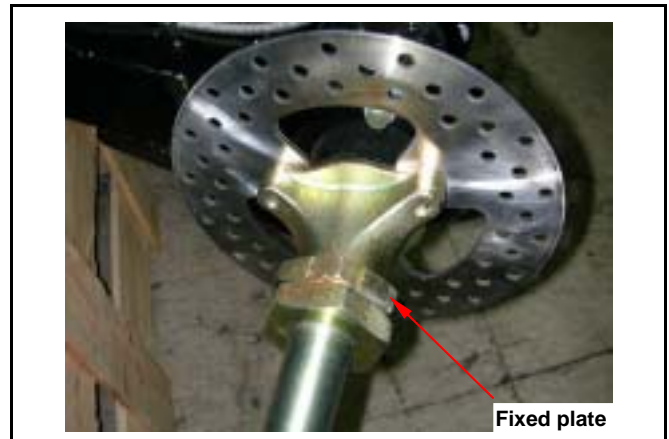

Remove rear wheel axle nuts.  
**Special tool:**  
Rear axle nut wrench (55mm)



Remove rear brake disk bracket and disk.

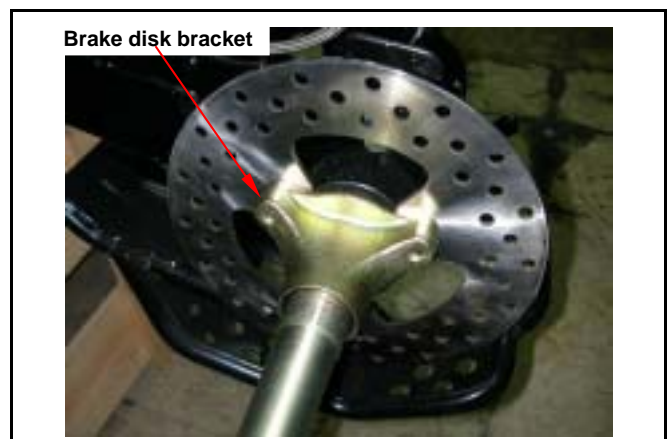

Remove rear wheel axle and driven sprocket holder.



### Inspection

Check bearings on rear wheel axle bearing seat. Rotate each bearing's inner ring with fingers. Check if bearings can be turned in smooth and silent, and also check if bearing outer ring is mounted on bearing seat. If bearing rotation is uneven, noising, or loose bearing mounted, then replace it. Check oil seal for wear or damage, and replace it if necessary.



### Disassembly

#### Caution

- Never install used bearings. Once bearing removed, it has to be replaced with new one.

Remove bearing and seal from rear wheel axle bearing seat using following tools.

#### Special tool:

**Inner bearing puller (SYM-6204022)**

Remove bearing spacer.

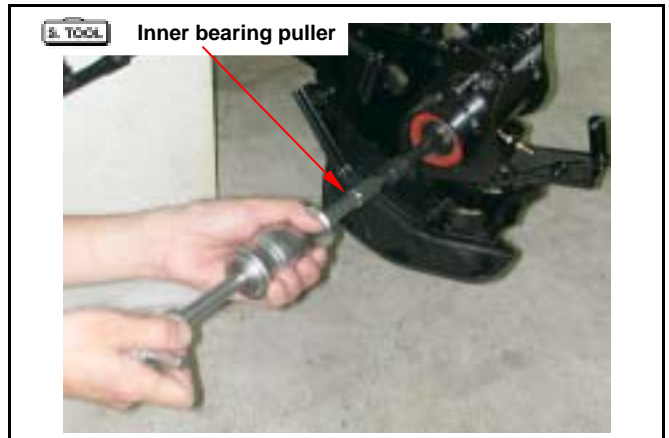

### Assembly

Install new left side bearing and seal into rear wheel axle bearing seat.  
 Install rear wheel axle bearing inner spacer.  
 Install new out right bearing and seal into front wheel hub.  
 Apply with grease onto the oil seal lip of rear wheel axle.

#### Special tool:

**Bearing driver (6007LLU)**

**Oil seal drive (48x62x7)**

**Oil seal drive (43x62x12)**



## 16. REAR BRAKE & REAR WHEEL & REAR CUSHION



### Installation

Install rear wheel axle and driven sprocket holder.



Install rear brake disk bracket and disk.

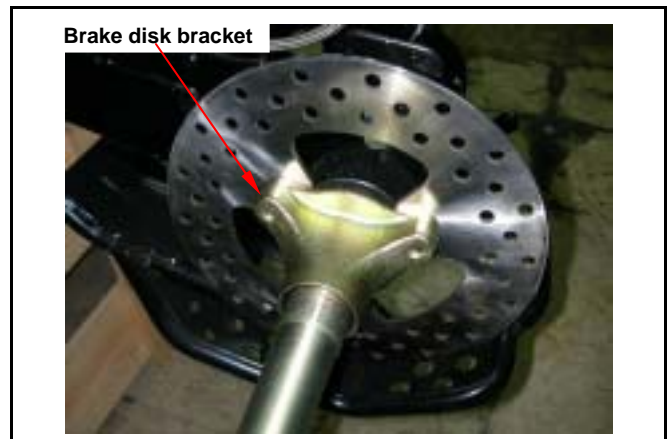

Install rear wheel axle nuts, rear axle nut fixed plate and tighten the nuts.

**Torque: 9.2kgf-m**

**Special tool:**

Rear axle nut wrench (55mm)

Rear axle nut torque wrench

Torque wrench



After tightened the axle nut, bend the rear axle nut fixed plate.

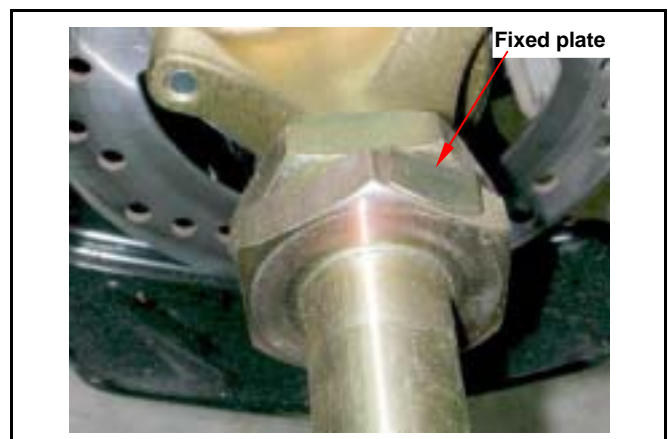

Install driven sprocket, drive chain, drive chain cover and brake caliper.

**⚠ Caution**

- Note the chain lock clip direction.

Install rear wheel shaft connector, rear wheel.

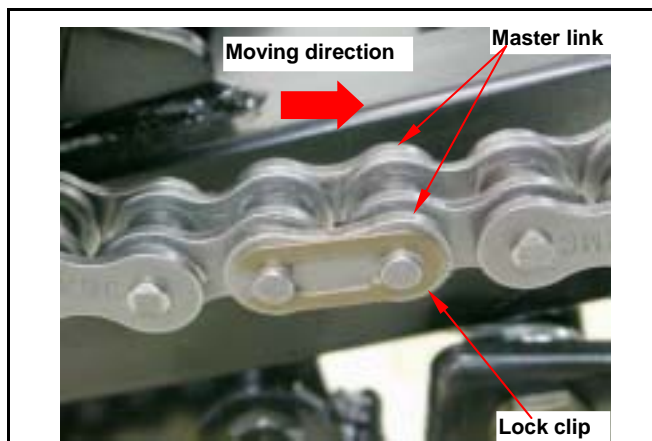

### Driven sprocket inspection

Check the condition of the driven sprocket teeth. Replace the sprocket if it worn.

**⚠ Caution**

- The drive chain, drive sprocket and driven sprocket must be also inspected for wear.

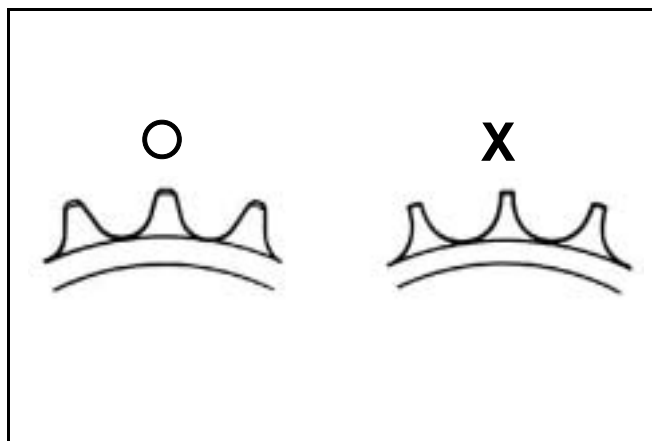

### Rear swing arm

#### Removal

Remove rear under protect, drive chain, driven sprocket, rear brake caliper, brake disk and rear axle.

Remove 2 nuts and bolt, and remove rear axle holder.



Remove rear swing arm lock nut.  
Remove rear swing arm bolt, and then remove rear swing arm.

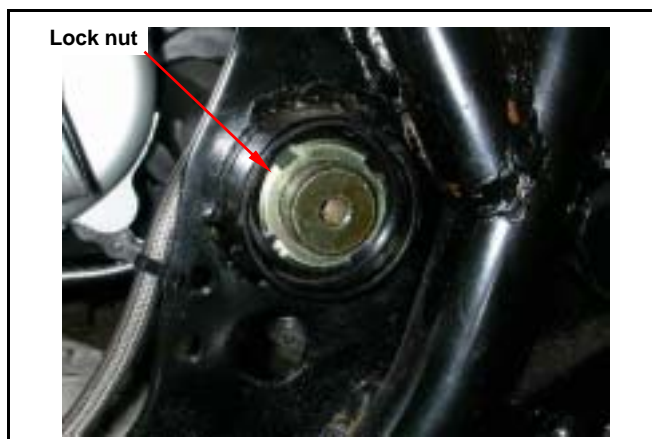

## Disk Brake System Inspection

### Inspection

By visual examination whether divulges or the damage, with spanner inspection brake tube seam whether becomes less crowded, and the inspection handle bar turn right or turn left, or pressure the cushion, whether besides the pipeline protection department, whether there is interferes, contacts other parts of.

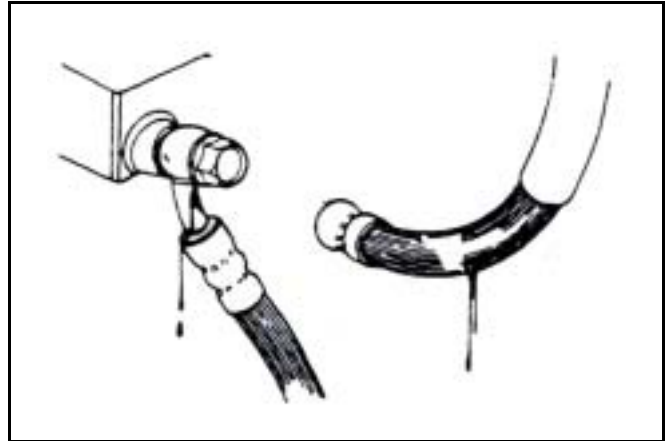

Check the brake from behind the brake caliper. The brake pad must be replaced with new lining when the brake pad wear limit reaches the brake disk.

### Caution

- Check the rear brake lining must be removed rear wheel first.

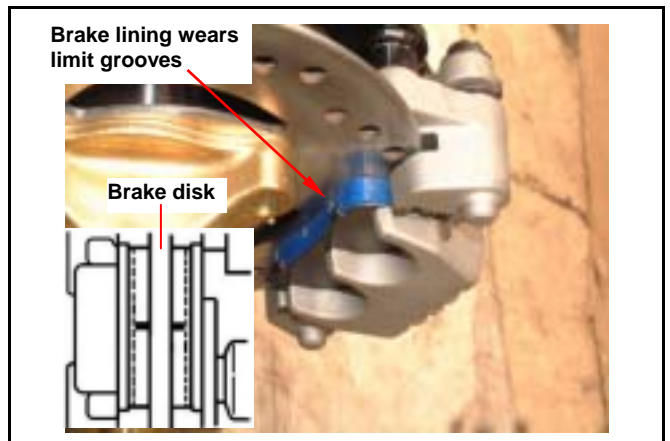

Park the ATV on a level ground, and check if fluid level is under the “LOWER” mark. Recommended Brake Fluid: WELL RUN BRAKE OIL (DOT 3).

### Caution

- The vehicles inclined or just stop, the survey oil level could not be accurate, had to settle the 3~5 minute.
- In order to prevent has the chemical change, please do not use counterfeiting or other unclear trade marks brake fluid.
- Uses by all means must with the trade mark brake fluid, guarantees the ghost vehicle efficiency.

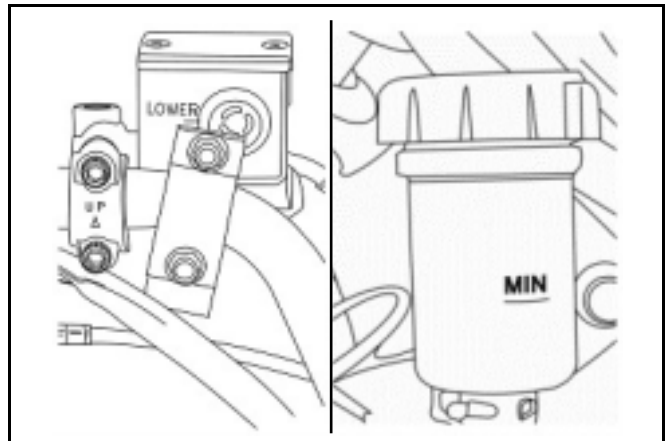

## Adding Brake Fluid

Before the brake fluid reservoir is removed, turn the handle so that the brake fluid reservoir becomes horizontal, and then remove the brake fluid reservoir.

When maintenance brake system, will be supposed to paint the surface or the rubber parts catches up by the rags.

**⚠ Caution**

Supplement brake fluid please do not surpass the upper limit, spilled brake fluid on painted surfaces, plastic or rubber components may result in their damages.

Remove the brake fluid cap and diaphragm. Increases the high quality brake fluid, uses by all means must with the trade mark brake fluid joins in the master cylinder. Clean the dirty brake disk.

**⚠ Caution**

- The dirty brake lining or disk will reduce the brake performance.
- To mixed non-compatible brake fluid will reduce brake performance.
- Foreign materials will block the system causing brake performance to be reduced or totally lost.

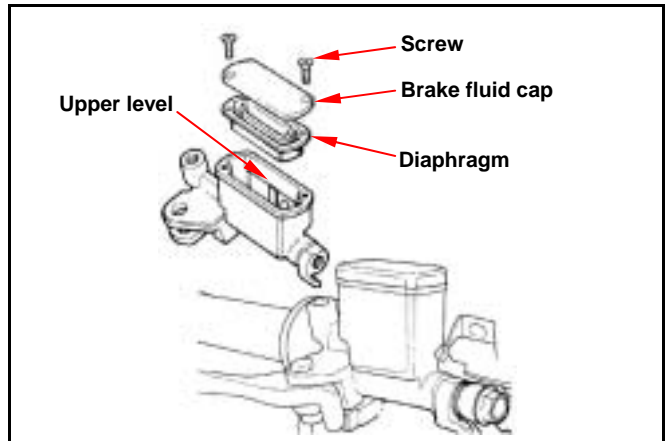
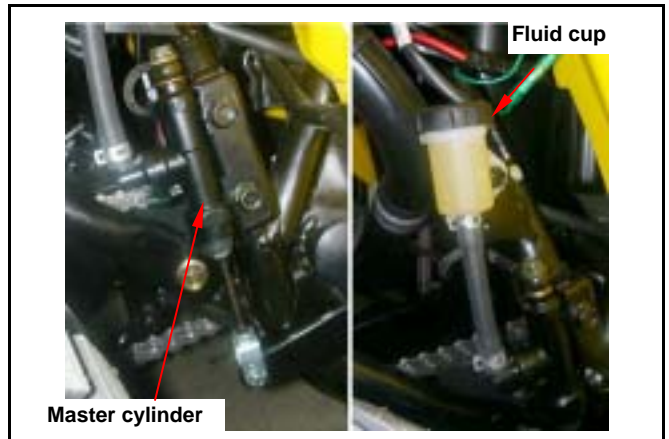



### Brake fluid replacement / Air-bleed

Connect drain hose to air-bleed valve.

Open the drain valve on the caliper and operate the brake lever until the old brake fluid is entirely drained out.

Close the drain valve and add specified brake fluid into the brake master cylinder.

**Recommended brake fluid: WELLRUN DOT 3 brake fluid**

Connect one end of transparent hose to the drain valve, and put the other end into a container. Open the drain valve around 1/4 turns, and at the same time hold the brake lever until there is no air bubble in the drain hose and also feeling resistance on the brake lever. Close the drain valve when finishing the brake system refilling fluid procedure, and operate the brake lever to check whether air bubble is in brake system or not.

If brake is still soft, please bleed the system as described below:

1. Tightly hold the brake lever and open the drain valve around 1/4 turns, and then close the valve.

#### Caution

- Do not release the brake lever before the drain valve is closed.
- Always check the brake fluid level when carrying out the air bleeding procedure to avoid air enters into the system.

2. Slowly release the brake lever, and wait for a few seconds until it reaches its top position.
3. Repeat the steps 1 and 2 until there is no air bubble at the end of the hose.
4. Tightly close the drain valve.
5. Make sure the brake fluid is in the UPPER level of the master cylinder, and refill the fluid if necessary.
6. Cover the cap.

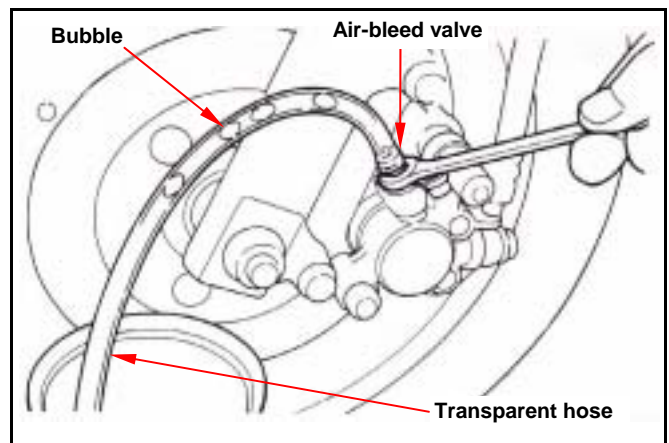
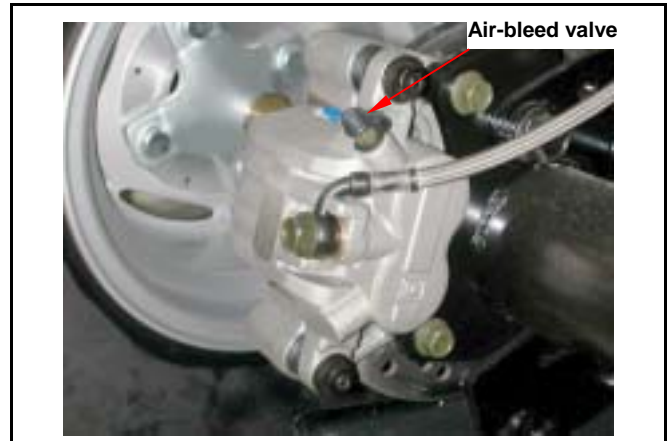

## Rear Brake Caliper

### Removal

Place a container under the brake caliper, and loosen the brake hose bolt and finally remove the brake hose.

### ⚠ Caution

Do not spill brake fluid on painted surfaces.

Remove two caliper bolts and the caliper.

### Inspection

Make sure the brake linings condition. Replace the linings if the brake linings wear limitation groove close to the brake disk.

### Installation

Install the brake caliper and tighten the attaching bolts securely.

**Torque: 3.25kgf-m**

### ⚠ Caution

- Use M8 x 20 mm flange bolt only.
- Long bolt will impair the operation of brake disk.

Use two seal washers and hose bolts to lock the hose and brake caliper in place.

**Torque: 3.5kgf-m**

Refill up the brake fluid to the reservoir and make necessary air bleeding.

### Brake lining replacement

Remove two guide pins.

Remove brake caliper cylinder, and then remove brake linings.

Install new linings and brake caliper cylinder. Tighten the guide pins.

**Torque: 1.8kgf-m**

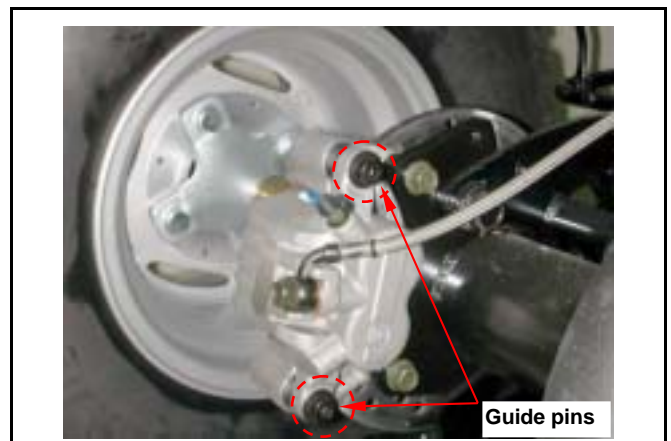
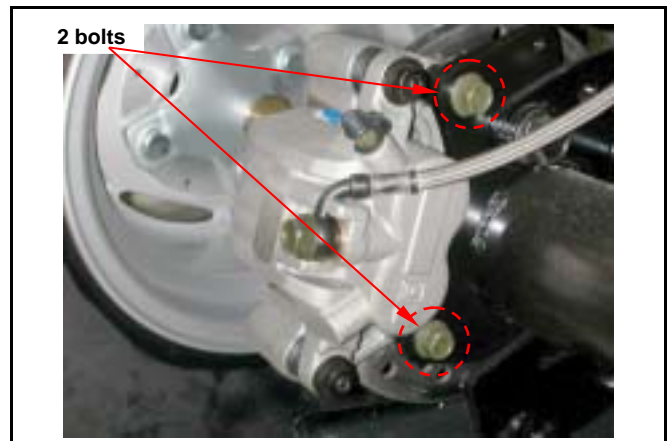
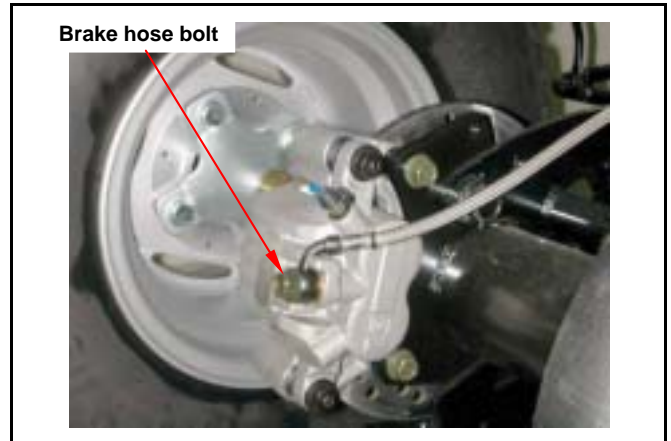

## Brake Disk

### Inspection

Visually check the brake disk for wear or break. Measure the thickness of the disk at several places. Replace the disk if it has exceeded the service limit.

**Allowable limit: 2.5 mm**

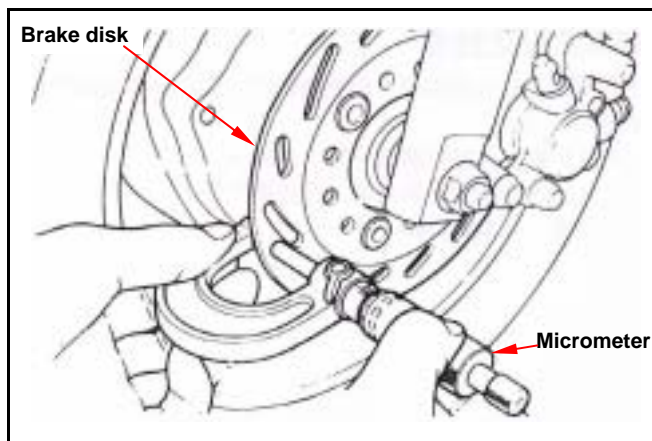

Remove the brake disk from rear wheel axle. Check the disk for deformation and bend.

**Allowable limit: 0.30 mm**

### ⚠ Caution

- The dirty brake lining or disk will reduce the brake performance.
- Brake lining includes the asbestos ingredient, cannot use the air-gun to be clean, the operator should dress the mouthpiece and the glove, use vacuum cleaner clean it.

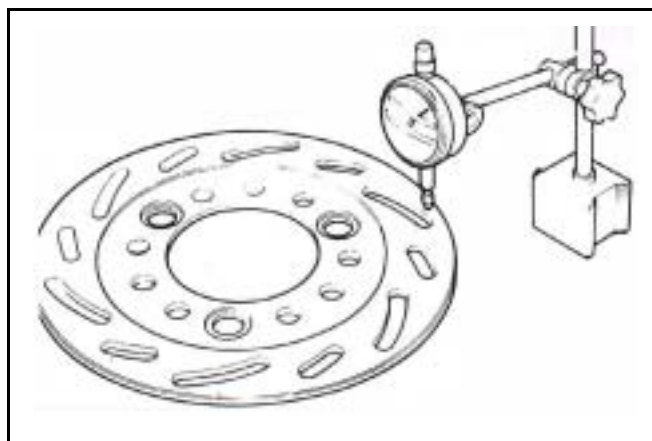

## Rear Brake Master Cylinder

### Master Cylinder Removal

### ⚠ Caution

Do not let foreign materials enter into the cylinder.

### ⚠ Caution

The whole set of master cylinder, piston, spring, diaphragm and cir clip should be replaced as a set.

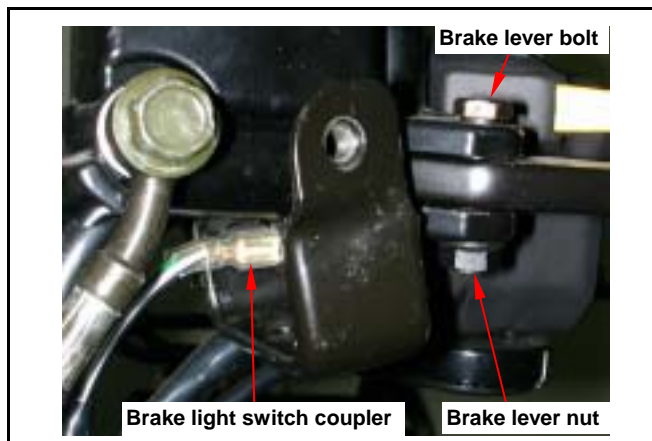

### Handle left side – rear brake master cylinder A

Remove brake light switch coupler.

Drain out the brake fluid.

Remove the brake hose.

Remove the brake lever from the brake master cylinder.

Remove the master cylinder socket bolts and the master cylinder.



## 16. REAR BRAKE & REAR WHEEL & REAR CUSHION

### Right footrest side – rear brake master cylinder

#### B

Place a container under the brake master cylinder, remove fluid hose clamp, and drain out the brake fluid.

Loosen the brake hose bolt and finally remove the brake hose.

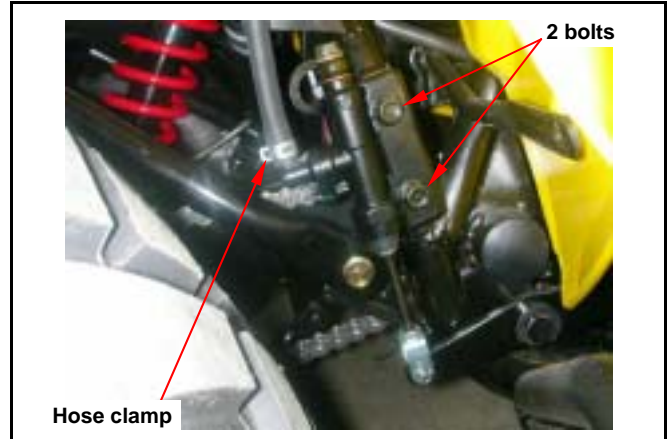

Remove the E type clip, and remove brake push rod pin.

Remove the master cylinder socket bolts and the master cylinder.

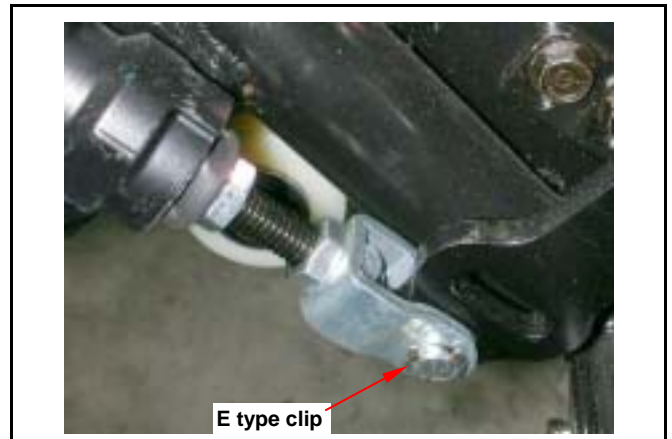

### Disassembly

Remove the rubber boot.

Remove the cir clip.

Remove the piston and the spring.

Clean the master cylinder with recommended brake fluid.

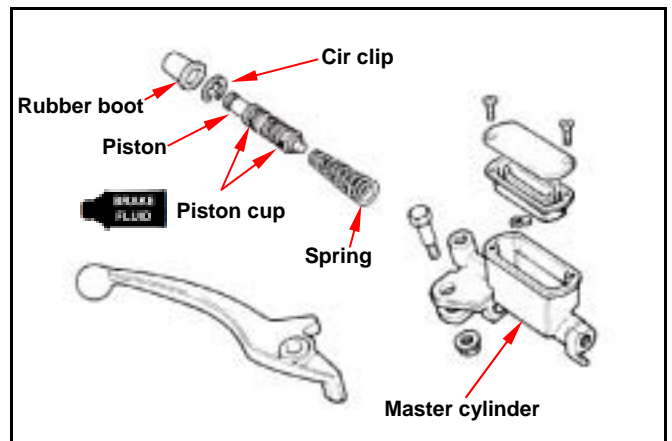

### Master Cylinder Inspection

Check the master cylinder for damage or scratch. Replace it if necessary.

Measure the cylinder inner diameter at several points along both X and Y directions.

Replace the cylinder if the measured values exceed allowable limit.

#### Allowable limit:

**Hand brake 14.050 mm**

**Foot brake 15.950 mm**

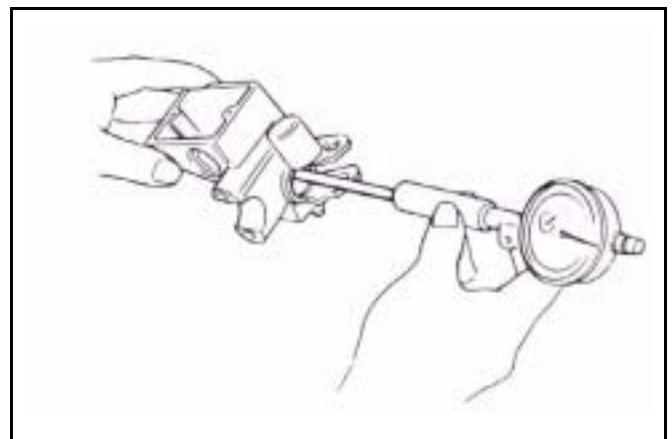

# 16. REAR BRAKE & REAR WHEEL & REAR CUSHION



Measure the outer diameter of the piston.  
 Replace the piston if its measured value exceeds allowable limit.

**Allowable limit:**

**Hand brake 13.954 mm**

**Foot brake 15.850 mm**

## Master Cylinder Assembly

**⚠ Caution**

- It is necessary to replace the whole set comprising piston, spring, piston cup, and cir clip.
- Make sure there is no dust on all components before assembling.

Apply clean brake fluid to the piston cup, and then install the cup onto the piston.

Install the larger end of the spring onto the master cylinder.

The master cup's cavity should be face inside of master cylinder when installing the master cup.

Install the cir clip.

**⚠ Caution**

- Never install cup lip in the opposite direction.
- Make sure the cir clip is seated securely in the groove.

Install the rubber boot into groove properly.

## Master Cylinder Install

**⚠ Caution**

Improper routing may damage leads, hoses or pipes.

**⚠ Caution**

Kink of brake leads, hose or pipe may reduce brake performance.

### Handle left side – rear brake master cylinder A

Install the rubber pad into the groove correctly. Place the master cylinder onto handlebar, and install the bolts.

Install the brake lever, and connect coupler to brake light switch.

Connect brake hoses with 2 new washers.

Tighten the brake hose bolt to the specified torque value.

**Torque: 3.5kgf-m**

Make sure the hose is installed correctly.

Install all wires, hoses, and components carefully so avoid to twisting them together.

Add specified brake fluid and bleed the system.

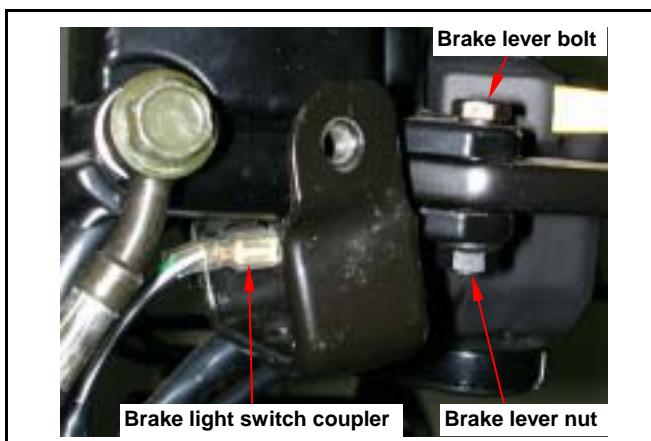
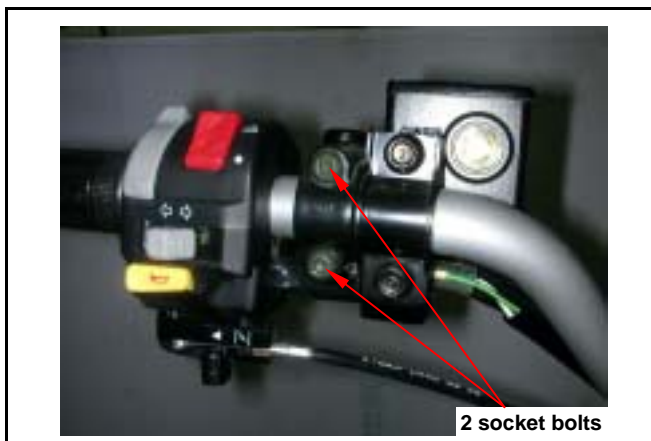
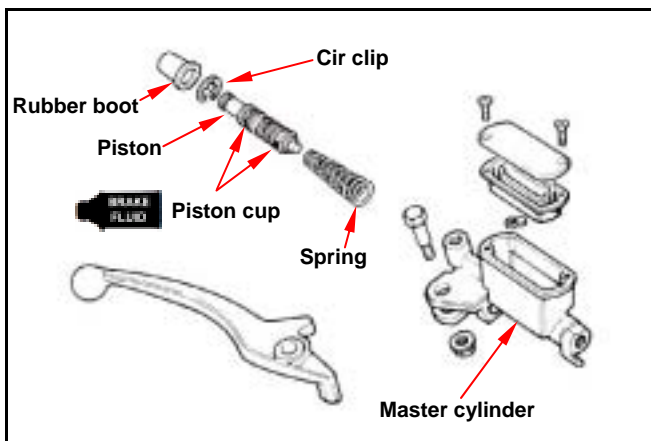
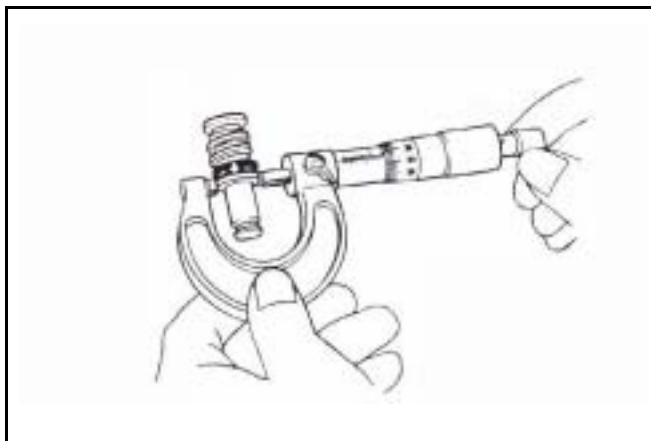

## 16. REAR BRAKE & REAR WHEEL & REAR CUSHION

### Right footrest side – rear brake master cylinder

#### B

Install the master cylinder bolts and the master cylinder.

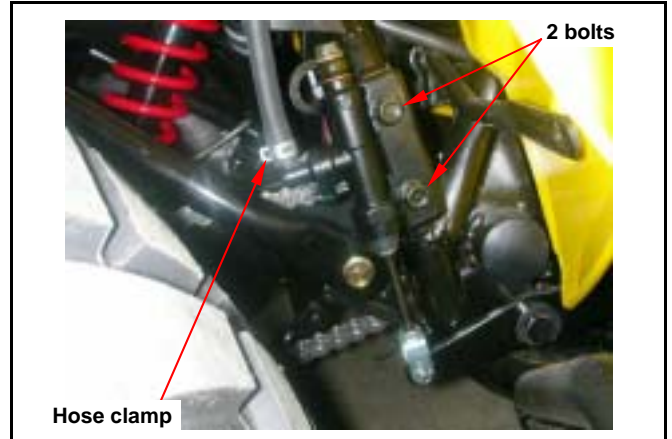

Install brake push rod to the brake pedal, and install pin and E type clip.

#### Caution

To adjustment brake pedal, you must be removed push rod pin fist.  
Loosen lock nut, and turn adjustment nut and push rod bracket to adjustment brake free play.

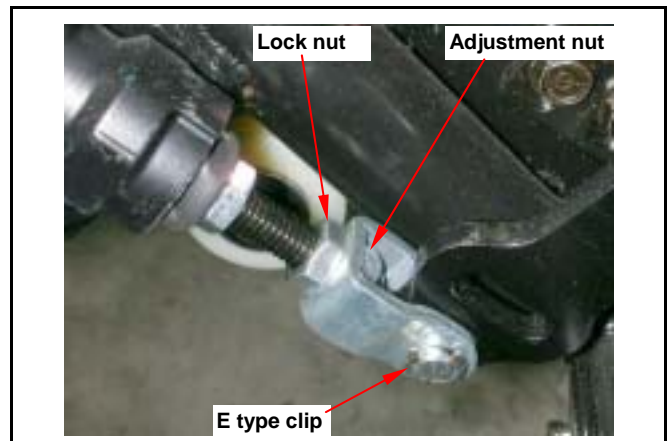

Install fluid hose and clamp.  
Connect brake hoses with 2 new washers.  
Tighten the brake hose bolt to the specified torque value.

#### **Torque: 3.5kgf-m**

Make sure the hose is installed correctly.  
Install all wires, hoses, and components carefully so avoid to twisting them together.  
Add specified brake fluid and bleed the system.

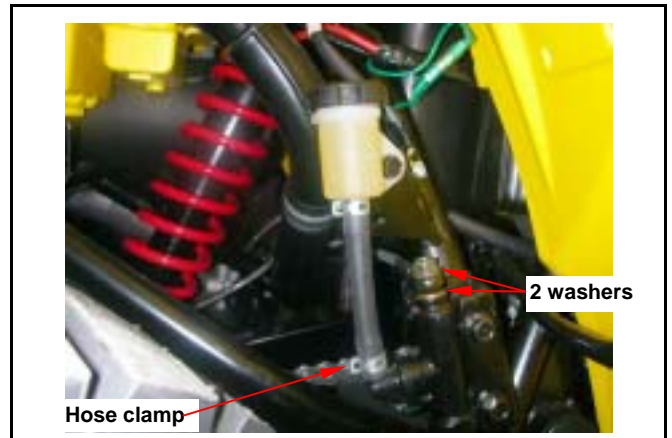

## Rear Cushion

### Removal

Support the frame.  
Loosen rear cushion under bolt, and remove rear cushion under bolt.

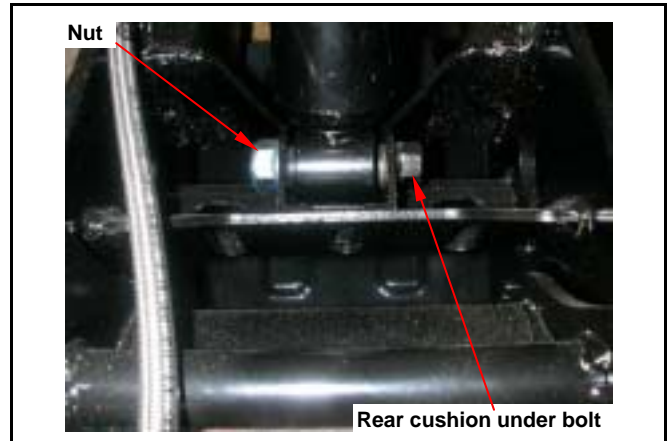

Remove rear cushion upper bolt, and then remove rear cushion.

### Installation

Install rear cushion, and install rear cushion upper bolt.  
Install rear cushion under bolt, and install nut.  
Tighten the rear cushion upper bolt and under nut to the specified torque value.

**Torque: 4.6kgf-m**



Mechanism Diagram .....	17-1	Meters .....	17-12
Maintenance Data .....	17-2	Light / Bulb .....	17-13
Technical Specification .....	17-2	Switch / Horn .....	17-16
Trouble Diagnosis .....	17-3	Fuel Unit .....	17-19
Battery .....	17-4	Cooling Fan Thermo Switch .....	17-20
Charging System .....	17-5	Thermo unit .....	17-21
Ignition System .....	17-8	Water Temperature Indicator Light ..	17-21
Starting System .....	17-10		

## Mechanism Diagram

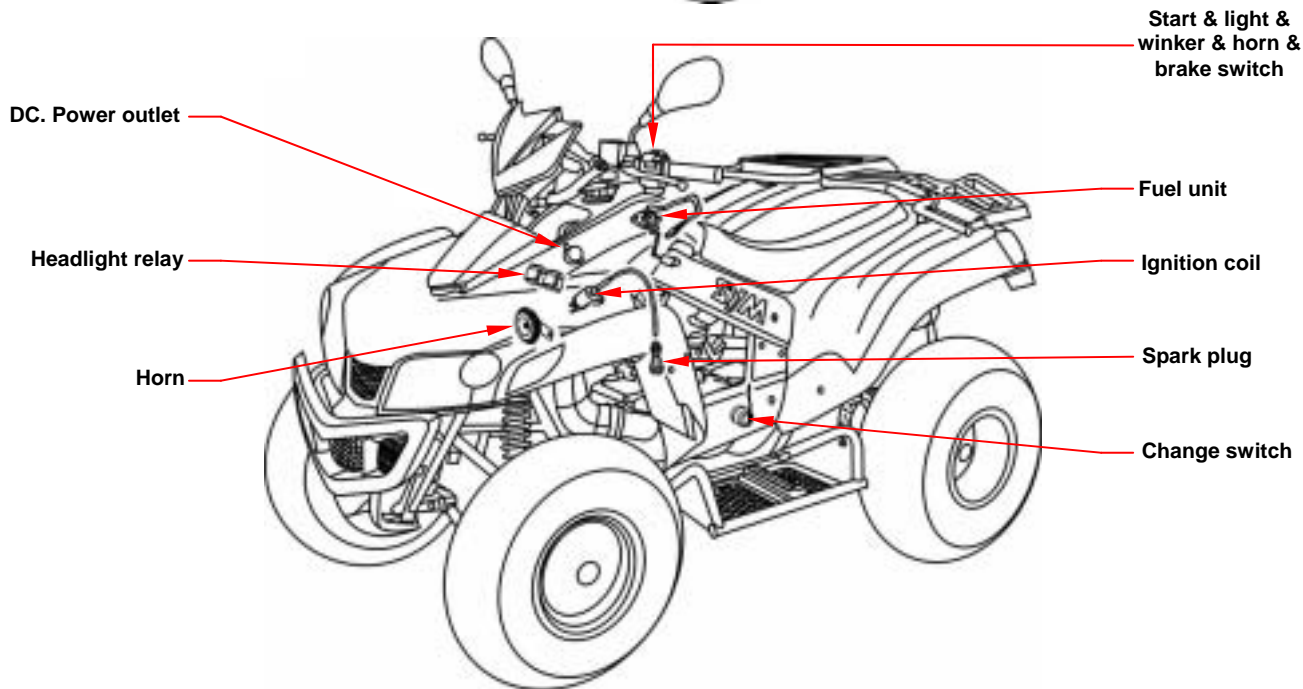
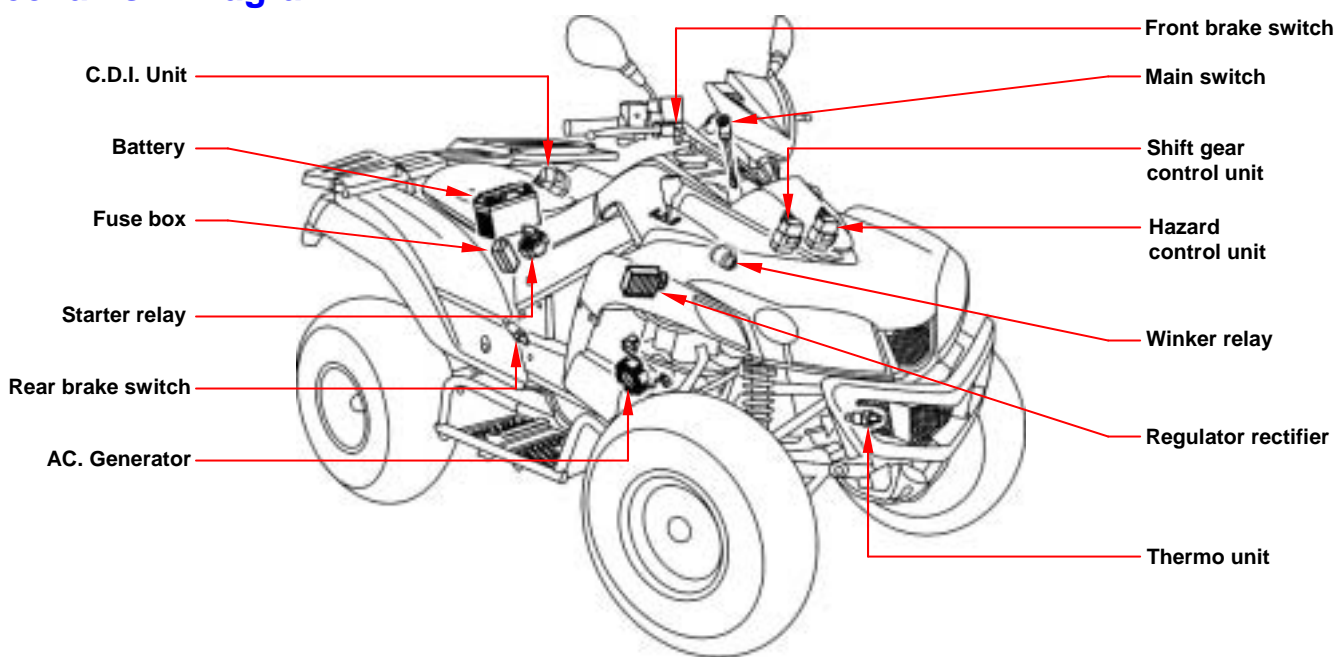



## 17. ELECTRICAL SYSTEM

### Maintenance Data

#### Operational precaution

- When remove the battery, the disconnection sequence of cable terminals shall be strictly observed. (First disconnect the negative cable terminal, next, the positive cable terminal.)
- The model of the spark plug and the tightening torque.
- The ignition timing.
- Adjustment of headlight.
- Removal and installation of AC generator.
- The maintenance free battery requires no inspection of electrolyte level and refilling of distilled water.
- To recharge the battery, remove the battery from rack without removing ventilation caps.
- Unless in emergency, never rapid charge the battery.
- The voltage must be checked with the voltmeter while charging the battery.
- As C.D.I assembly does not require an ignition timing check. In case ignition timing is incorrect, check C.D.I and AC generator. Verify with an ignition timing light after replacement if necessary.

### Technical Specification

#### Charging system

Description		Specification
Battery	Capacity	12V10Ah
	Charging rate	1A / 5 hours (standard) 4A / 1 hour (fast charging)
Leak current		< 1mA
Charging current		1.2 A / 1500rpm
Control voltage in charging		14.5 + 0.5 V / 1500rpm

#### Ignition system

Description		Specification
Spark plug	Model	NGK CR8E (Recommended)
	Gap	0.8mm
Ignition coil and resistance	Primary winding	$0.17 \pm 10\% \Omega$
	Secondary winding	Without cap: $3.1 \pm 10K\Omega$
With cap: $8.1 \pm 10K\Omega$		
Ignition timing "F" mark		$10^\circ$ TDC / 1700rpm
		$27^\circ$ TDC / 4000rpm

## Trouble Diagnosis

### No voltage

- Battery discharged
- The cable disconnected
- The fuse is blown
- Improper operation of the main switch

### Low voltage

- The battery is not fully charged
- Poor contact
- Poor charging system
- Poor voltage regulator

### No spark produced by spark plug

- The spark plug is out of work
- The cable is poorly connected, open or short-circuited
  - Between AC.G. and C.D.I.
- Poor connection between C.D.I. and ignition coil
  - Poor connection between C.D.I. and the main switch
- Poor main switch
- Poor C.D.I.
- AC.G. is out of work

### Starter motor does not work

- The fuse is blown
- The battery is not fully charge
- Poor main switch
- Poor starter switch
- The front and rear brake switches do not operate correctly
- Starter relay is out of work
- The ignition coil is poorly connected, open or short-circuited
- The starter motor is out of work

### Intermittent power supply

- The connector of the charging system becomes loose
- Poor connection of the battery cable
- Poor connection or short-circuit of the discharging system
- Poor connection or short-circuit of the power generation system

### Charging system does not operate properly

- Burnt fuse
- Poor contact, open or short circuit
- Poor regulator
- Poor ACG

### Engine does not crank smoothly

- Primary winding circuit
  - Poor ignition coil
  - Poor connection of cable and connectors
  - Poor main switch
- Secondary winding circuit
  - Poor ignition coil
  - Poor spark plug
  - Poor ignition coil cable
  - Current leakage in the spark plug
- Incorrect ignition timing
  - Poor AC.G.
  - Improper installation of the pulse sensor
  - Poor C.D.I.

### Weak starter motor

- Poor charging system
- The battery is not fully charged
- Poor connection in the windings
- The motor gear is jammed by foreign material

### Starter motor is working, but engine does not crank

- Poor starter motor pinion
- The starter motor run in reverse direction
- Poor battery

## 17. ELECTRICAL SYSTEM

### Battery

#### Removal

Remove the seat, and then you can see the battery.

Disconnect the negative cable terminal first, then the positive cable terminal.

Remove the battery clamp, and then remove battery...

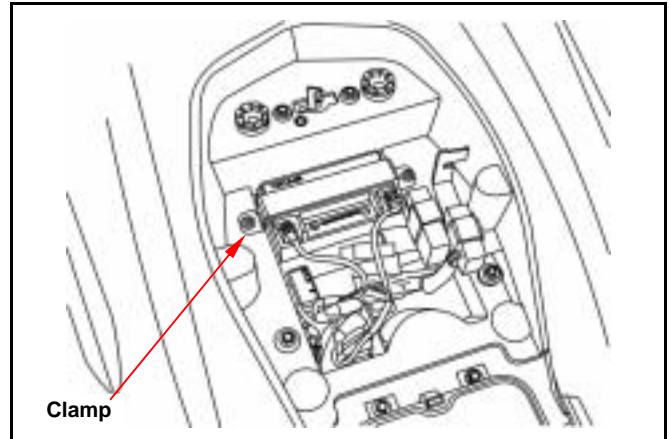

#### Voltage Check

Use the digital voltmeter to check the voltage of the battery.

#### Voltage:

**Fully charged: 13.0~13.2 V at 20**

**Undercharged: Below 12.3 V at 20**

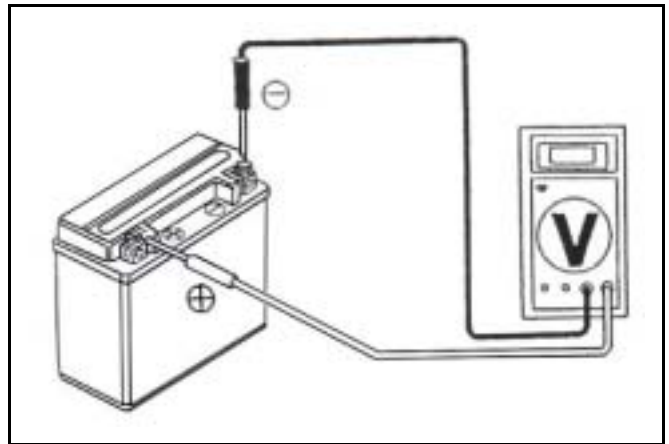

#### Charging

Connect the positive terminal (+) of the charger to the battery positive terminal (+).

Connect the negative terminal (-) of the charger to the battery negative terminal (-).

	Standard	Maximum
Charging current	1A	4.0A
Charging time	5H	1H

#### ⚠ Warning

- Keep flames away while recharging.
- Charging is completely controlled by the ON/OFF switch on the charger, not by battery cables.

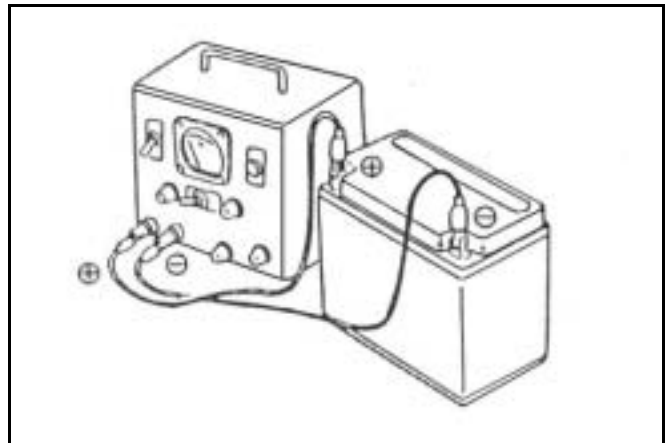

#### ⚠ Caution

- Never rapid charge the battery unless in emergency.
- Verify the battery is recharged with current and duration prescribed above.
- Large current and fast time to charge will render damage to the battery.

When installing the battery, coat the cable terminal with grease.

## Charging System

### Charging circuit

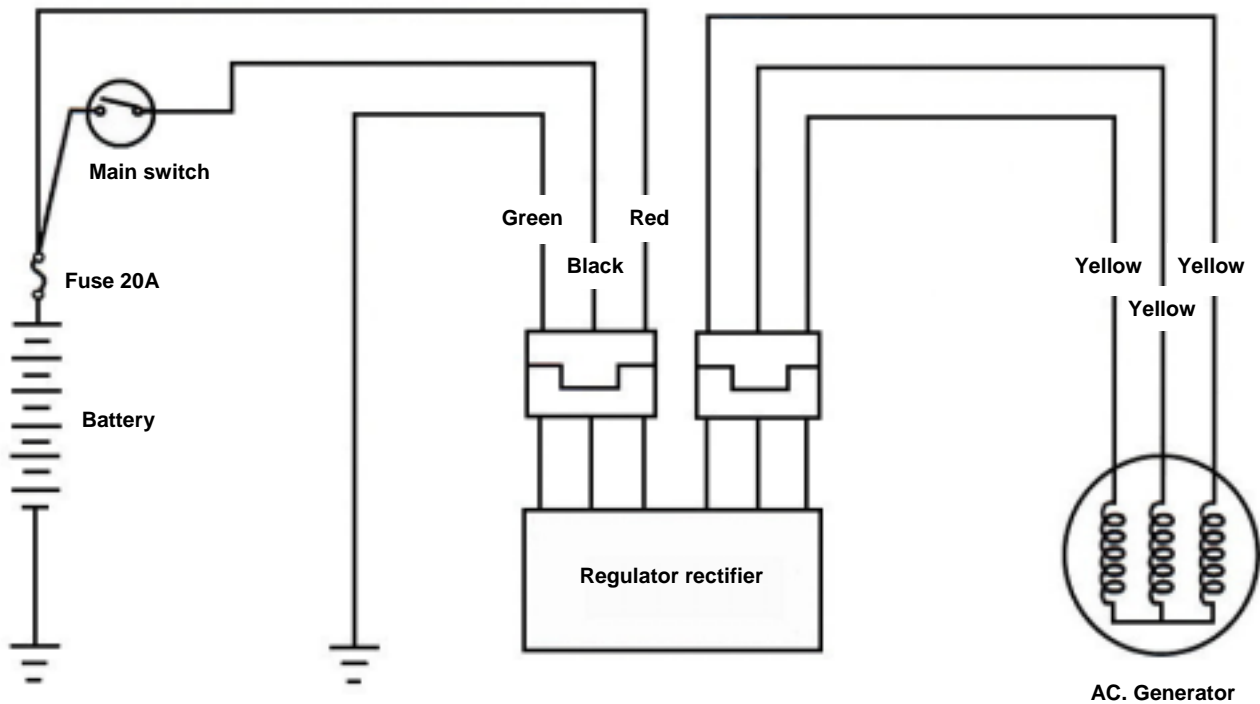

### Current Leakage Inspection

Turn the main switch to OFF position, and remove the negative cable terminal (-) from the battery. Connect an ammeter between the negative cable terminal and the battery negative terminal.

#### ⚠ Caution

- In the current leakage test, set the current range at the largest scale, then gradually decrease to the lower scale as the test process goes to avoid possible damage to the ammeter and the fuse.
- Do not turn the main switch to ON position during test.

If the leaked current exceeds the specified value, it may indicate a short circuit.

#### **Allowable current leakage: Less than 1mA**

Disconnect each cable one by one and take measurement of the current of each cable to locate the short circuit.

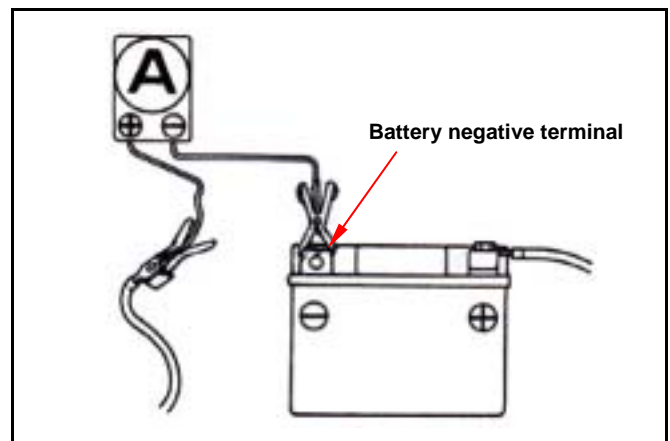

## 17. ELECTRICAL SYSTEM

### Inspection on Charging Voltage

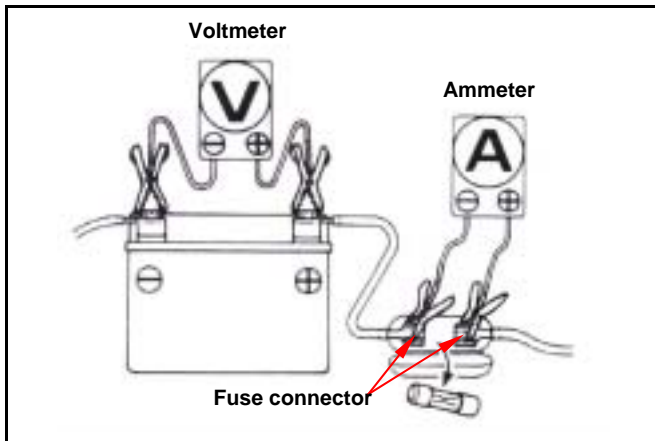

#### ⚠ Caution

- Before conducting the inspection, be sure that the battery is fully charged. If undercharged, the current changes dramatically.
- Use a fully charged battery having a voltage larger than 13.0 V
- While starting the engine, the starter motor draws large amount of current from the battery.

After the engine is warmed up, replace original battery with a fully charged battery.

Connect a digital voltmeter to the battery terminals.

Connect an ammeter between both ends of the main fuse.

#### ⚠ Caution

When the probe is reversibly connected, use a voltmeter having an indication that the current flows from the positive or the negative direction and the measurement should be at zero, ammeter at one direction only.

#### ⚠ Caution

- Does not use short-circuit cable.
- It is possible to measure the current by connecting an ammeter between the battery positive terminal and the cable position terminal, however, while the starter motor is activated, the surge current the motor draws from the battery may damage the ammeter. Use the kick starter to start the engine.
- The main switch shall be turned to OFF position during the process of inspection. Never tamper with the ammeter and the cable while there is current flowing through. It may damage the ammeter.

Connect a tachometer.

Turn on the headlight to high beam and start the engine.

Accelerate the engine to the specified revolution per minute and measure the charging voltage.

**Specified Charging Current:**

**1.2 A / 6000 rpm**

**Control Charging Voltage:**

**14.5 + 0.5 V / 2000 rpm**

#### ⚠ Caution

To replace the old battery, use a new battery with the same current and voltage.

The following problems are related to the charging system; follow the instructions provided in the checking list to correct it if any one of the problems takes place.

- (1) The charging voltage can not exceed the voltage between two battery terminals and the charging current is in the discharging direction.
- (2) The charging voltage and current are too much higher than the standard values.

The following problems are not related to the charging system; correct it if any by following steps indicate in the checking list.

- (1) The standard charging voltage and current can only reach when the revolution of the engine exceeds the specified rpm.
  - Bulbs used exceed their rate and consume too much power.
  - The replacement battery is aged and does not have enough capacity.
- (2) The charging voltage is normal, but the current is not.
  - The replacement battery is aged and does not have enough capacity.
  - Battery used does not have enough electricity or is over charged.
  - The fuse of the ammeter is blown.
  - The ammeter is improperly connected.
- (3) The charging current is normal, but the voltage is not.
  - The fuse of the voltmeter is blown.

**Inspection on regulator rectifier**

Remove the seat, rear carrier and rear fender.  
Disconnect two 3 pin couplers of the regulator rectifier.

Inspection the rectifier coupler to the wire harness passes the condition.

Item	Check Points	Standard Value
Main switch connection	R – B	Battery voltage (ON)
Battery connection	R – G	Battery voltage
Charging coil	Y – Y	0.17 ~ 0.8Ω

If the readings measured are not normal, check parts in the circuit.  
If the parts are normal, then trouble is in the wiring.  
If there is nothing wrong with parts and wiring, replace the regulator rectifier.

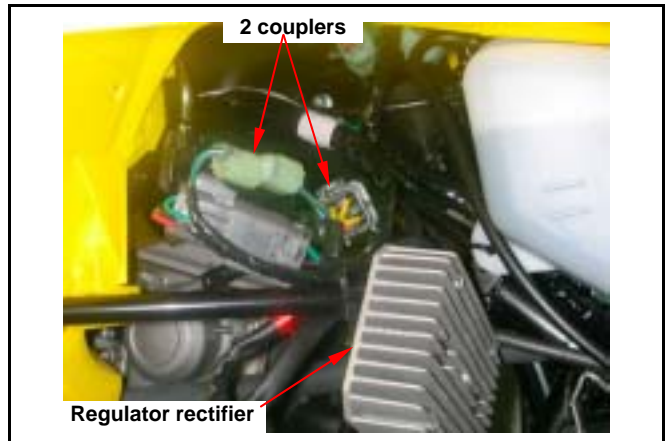
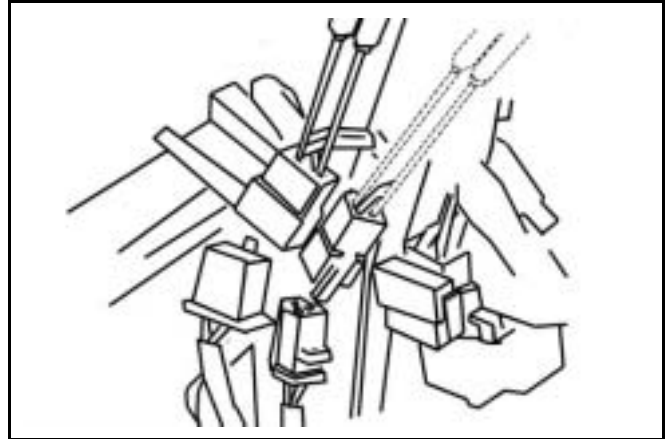

# 17. ELECTRICAL SYSTEM



## Ignition System

### Ignition circuit diagram

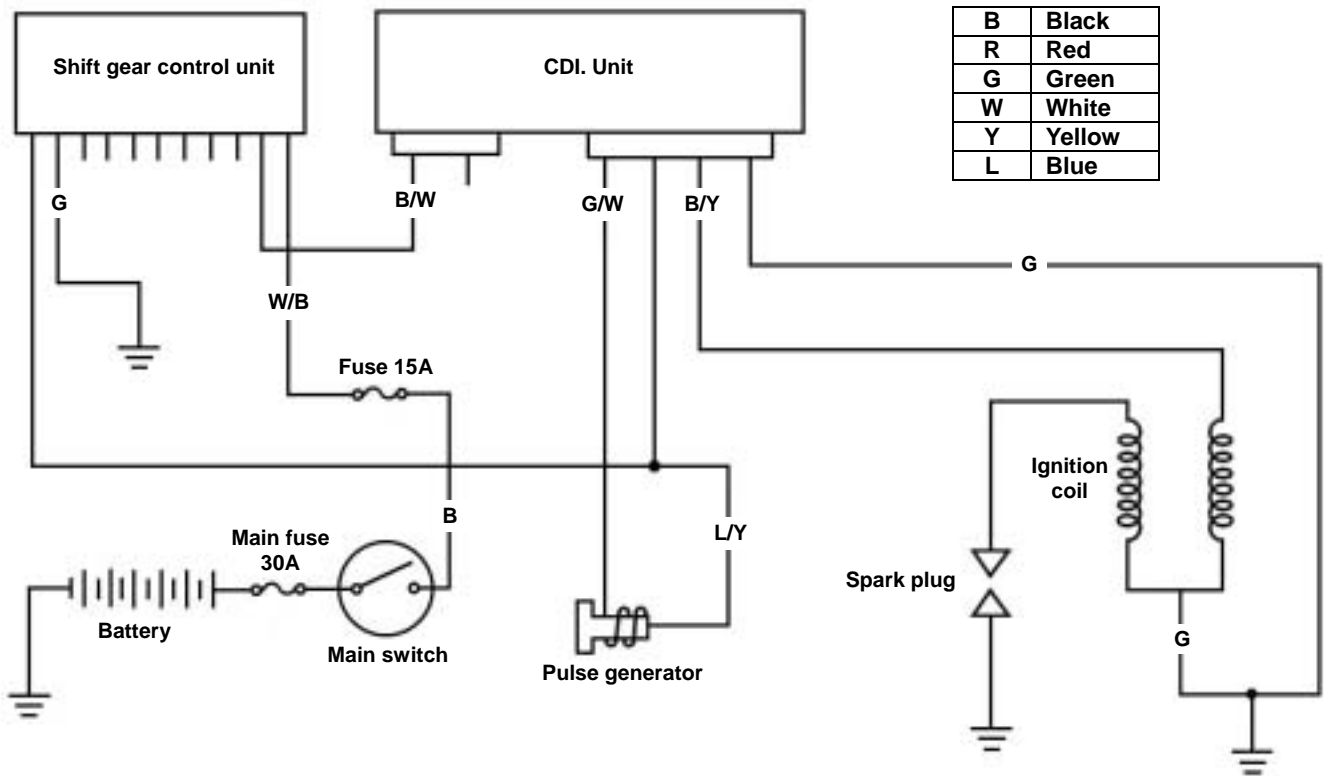

### C.D.I unit

Disconnect connectors of the C.D.I unit.

Check the following connectors as indicated in the table at the harness side.

Item		Points to check	Result
Main switch turn to "ON" position		Black/white ~ green	Battery voltage
Pulse generator		Green/White ~ Blue/yellow	50~170Ω
Ignition coil	Primary circuit	Black/yellow ~ green	0.17±10%Ω
	Secondary circuit	Black/yellow ~ with no cap	3.6±10%Ω
		Black/yellow ~ with cap	7.3~11KΩ

### Inspection on Ignition Coil

Disengage the connector of the ignition coil and the spark plug cap.  
Measure the resistance between the terminals of the primary winding.

**Standard resistance:  $0.17\Omega \pm 10\%$**

Remove the cap from the spark plug and measure the resistance between the spark plug and the primary winding.

**Standard resistance:**

**With no cap:  $3.6\Omega \pm 10\%$**

**With cap: 7.3~11 K $\Omega$**

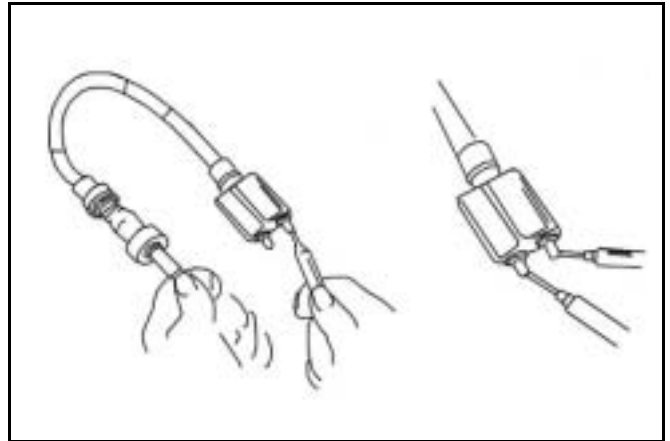

### Ignition Coil Replacement

Loosen the lock bolt and replace the ignition coil if necessary.

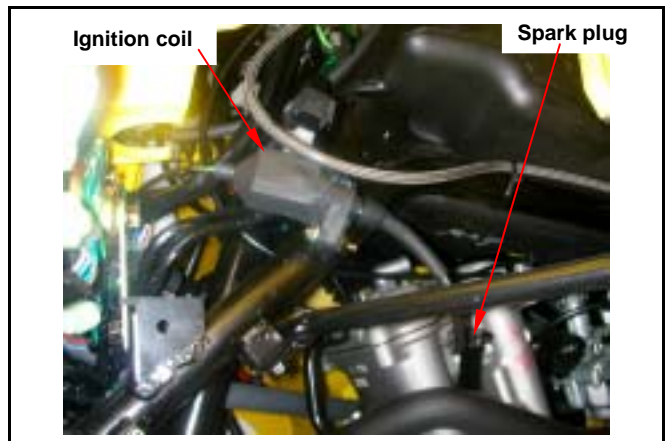

### Inspection of Pulse Generator

Disconnect the coupler of the pulse generator and measure the resistance between the terminals of green/white and blue/yellow.

**Standard resistance: 50~170 $\Omega$**

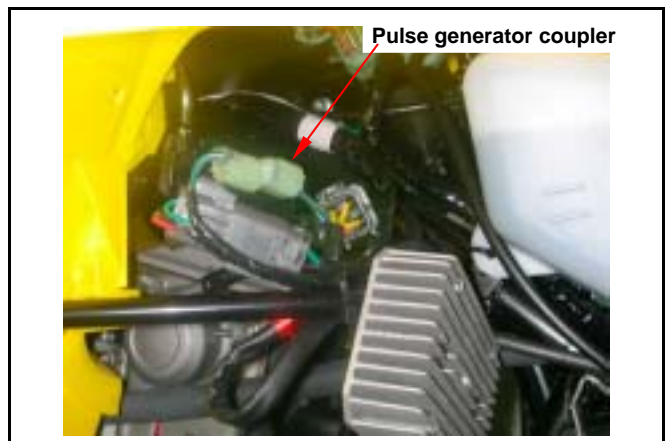



# 17. ELECTRICAL SYSTEM



## Starting System

### Starting circuit diagram

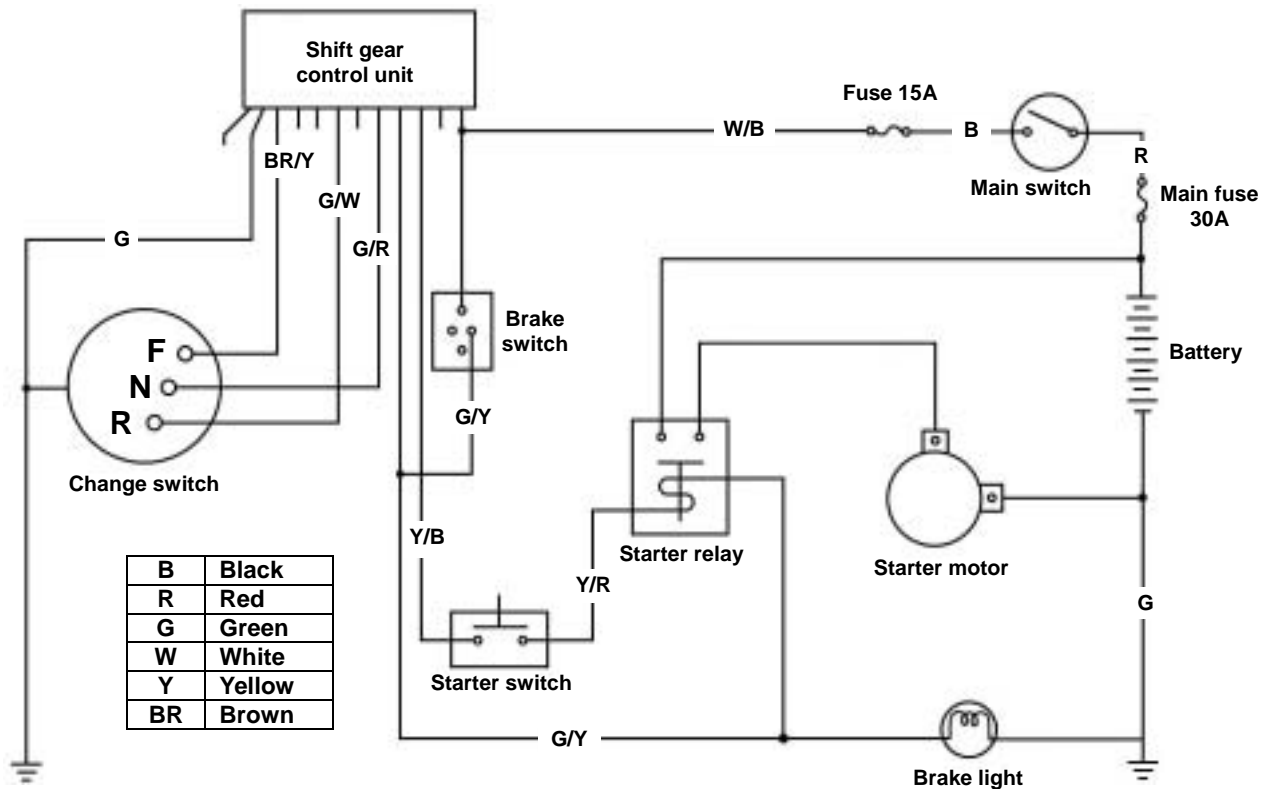

### Inspection on starter relay

Open the main switch.  
 Press the brake.  
 Push down the starter switch.  
 If a sound of “Looh Looh” is heard, it indicates the relay function normally.



Remove the seat.  
 Disconnect the negative cable terminal of the battery.  
 Disconnect the cable positive terminal from the relay.  
 Disconnect the positive cable of the starter motor.  
 Disconnect the coupler of the relay.  
 Connect an ohmmeter to the large terminal end.  
 Connect the yellow/red cable to the battery positive terminal and the yellow/black cable to the battery negative terminal.  
 Check the continuity of the large terminal end.  
 If there is no continuity, replace the relay.

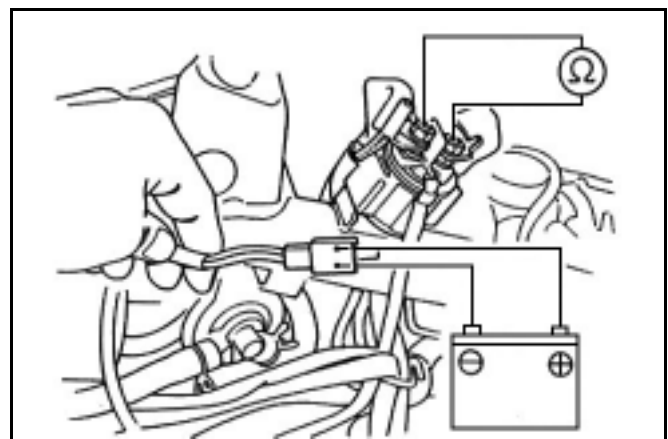

## Removal of Starter motor

Remove the seat.  
Disconnect the cable negative terminal (-), then  
the cable positive terminal (+).

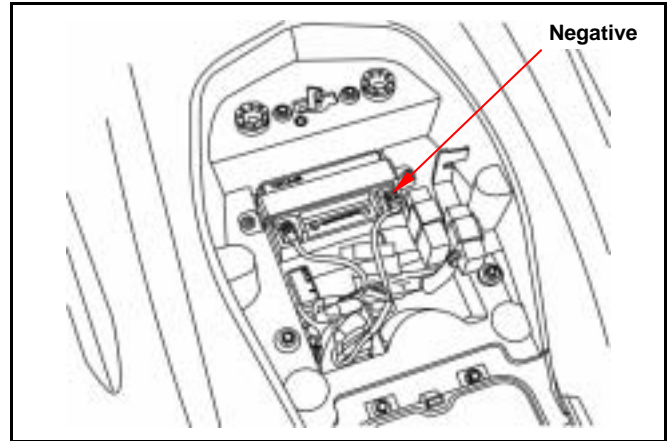

Remove starter motor cable.  
Loosen the lock bolts and remove the starter  
motor.

## Installation of Starter motor

Install in reverse order of removal procedures.

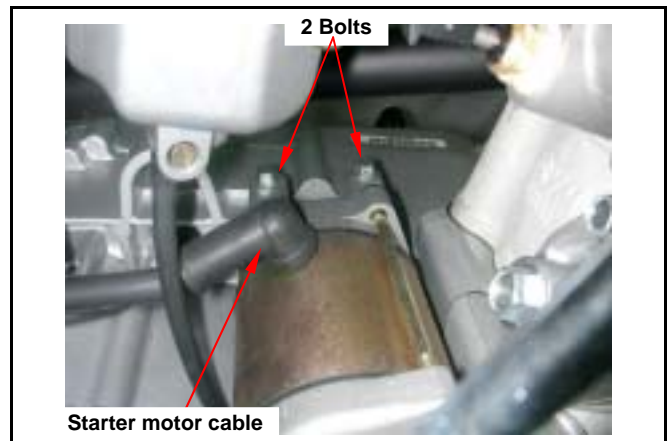

## 17. ELECTRICAL SYSTEM

### Meters

#### Removal

Loosen 4 bolts of the meter stay.

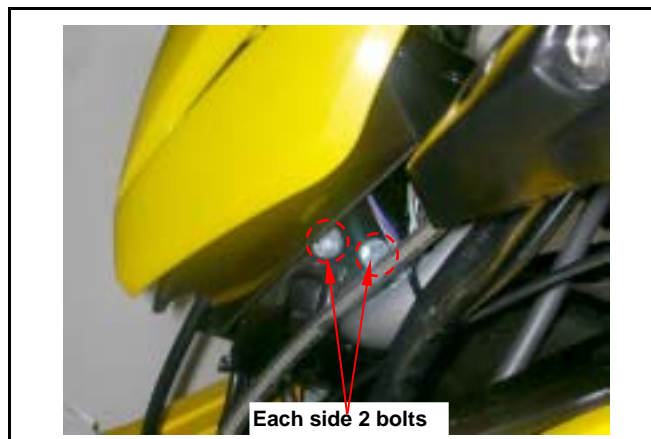

Remove the front center cover, and then remove meter couplers and main switch coupler. Remove speedometer cable.

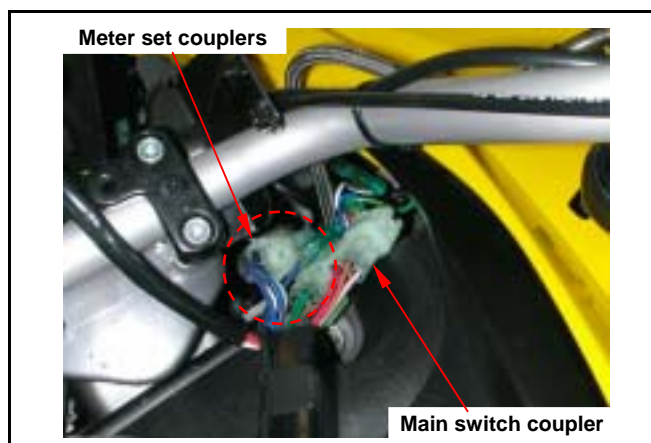

Remove speedometer cable, and then remove meter set, main switch and handle cover

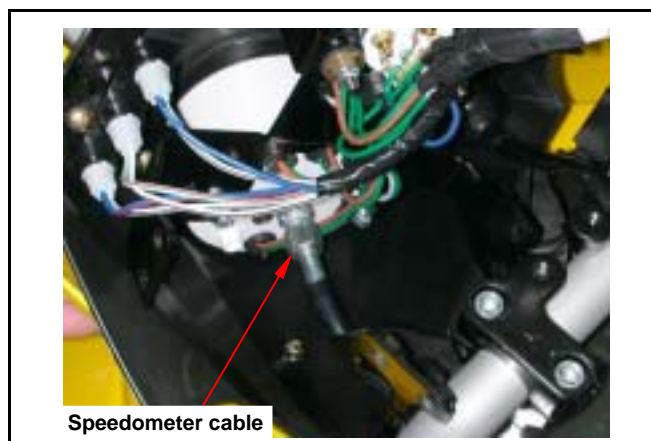

Remove 4 nuts and meter wire, and then remove speedometer and fuel meter.

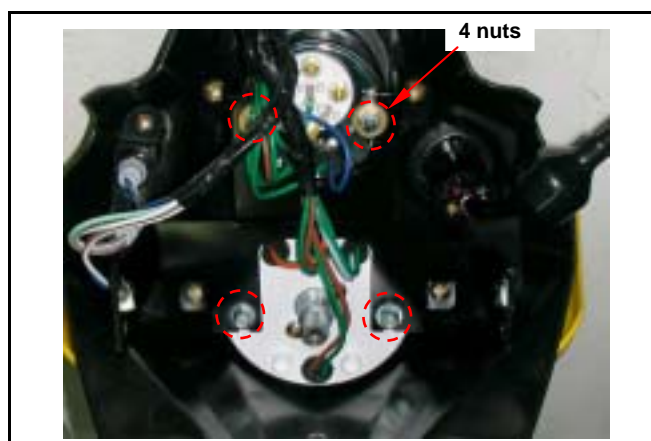

## Light / Bulb

### Replacing Bulb for Headlight

Remove 4 screws for the headlight cover, and remove the cover.

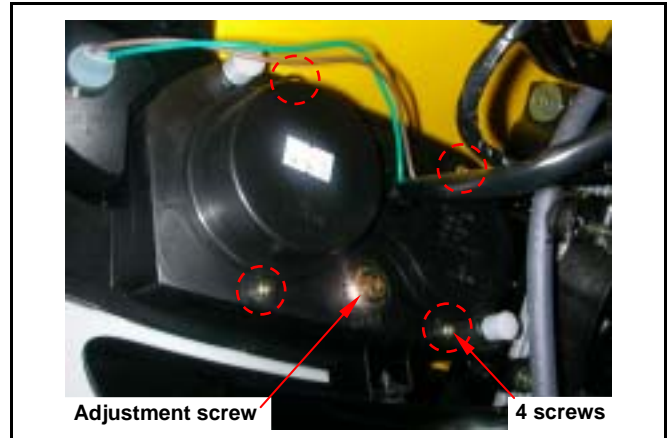

Loosen headlight bulb setting plate screw.

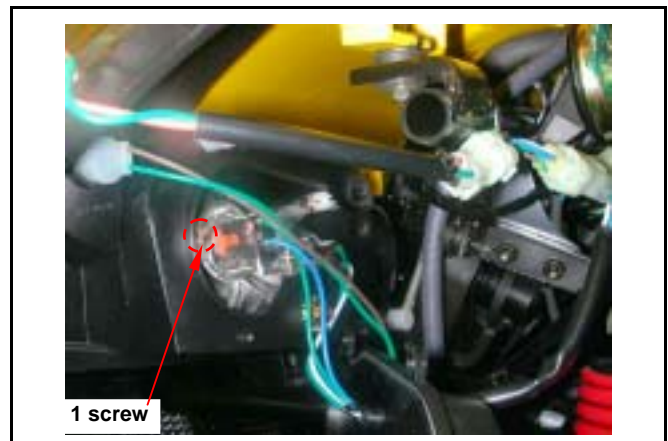

Remove bulb setting hook.

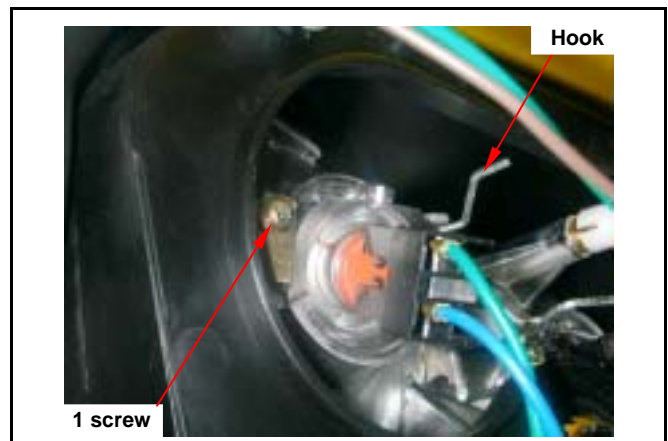

Take out the bulb connector and the bulb.  
Replace with new bulb if necessary.

**(H7 12V 55W)**

#### Caution

- Never touch the bulb with finger, which will create a heat point.
- Clean the fingerprint left on the bulb with alcohol.

Install the bulb of the headlight in reverse order of removal.

Upon completion of replacement, turn on the main switch to ensure the headlight works well.

Adjust the beam and distance of the headlight if necessary.



## 17. ELECTRICAL SYSTEM

### Replacing the Front winker light Bulb

Pull out the front winker light bulb seat.

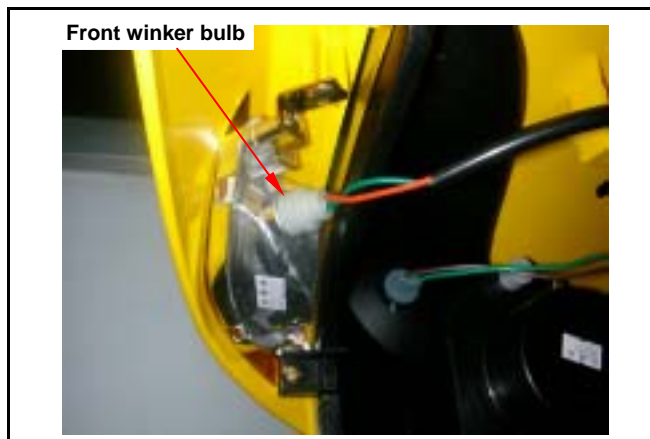

Replace with new front winker light bulb.  
(12V 21W)



### Replacing Bulb of Position Light

Pull out the position light bulb seat.

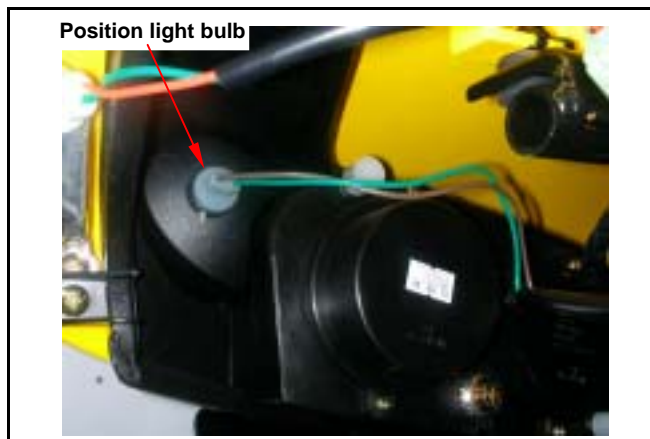

Replace with new position light bulb.  
(12V 5W)

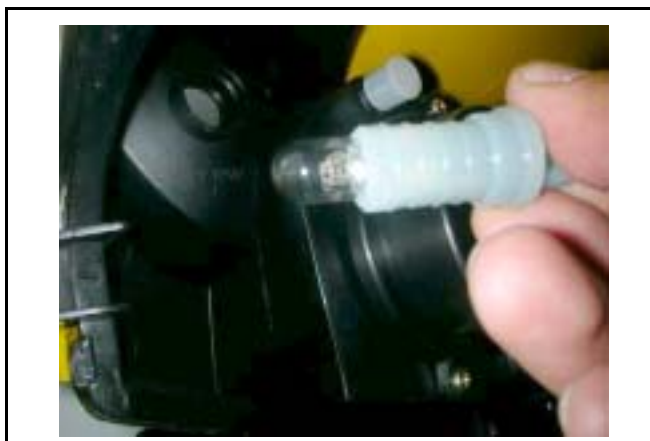

### Replacing Bulb of Taillight and Rear Winker Light

Turn the taillight and rear winker light bulb connectors by CCW.

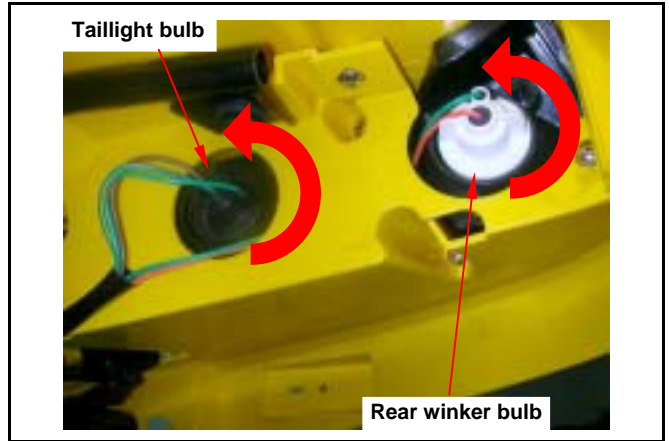

Replace with new taillight bulb.  
(12V 5W/21W)

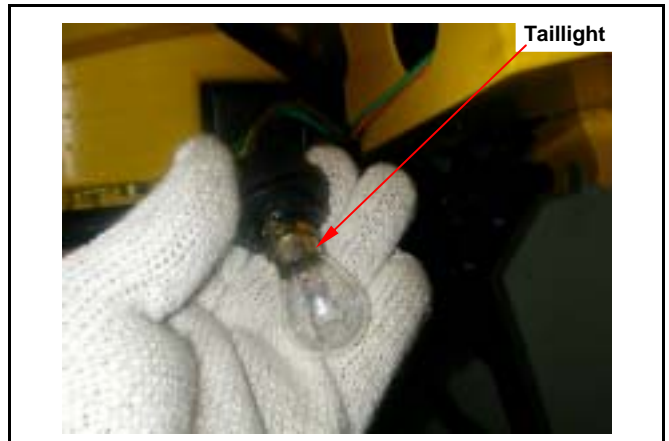

Replace with new rear winker light bulb.  
(12V 21W)



**Replacing Bulb of License Light**  
Turn the license light bulb connectors by CCW.  
Replace with new license light bulb.

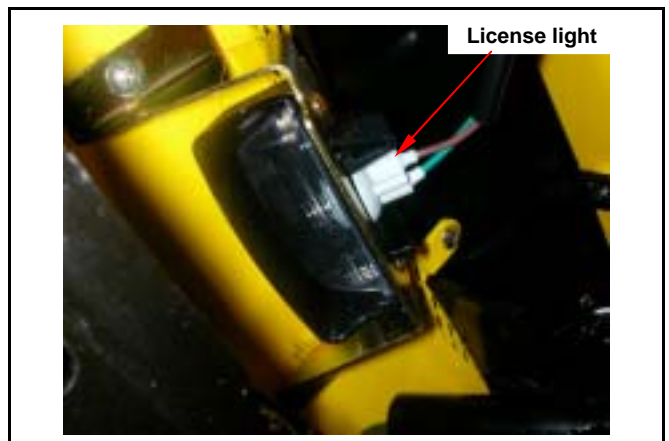

# 17. ELECTRICAL SYSTEM

## Switch / Horn

### Main Switch

#### Inspection

Remove the front center cover.  
 Disconnect the main switch coupler.  
 Check the continuity between two points as indicated below:

Position \ Pin	BAT1	BAT2
OFF		
ON	○ ——— ○	○ ——— ○
Wire Color	Red	Black

#### Replacement of main switch

Disconnect the coupler of the main switch.  
 Push out the main switch.  
 Align the main switch stopper with the meter cover groove, and install main switch.  
 Install the main switch coupler.

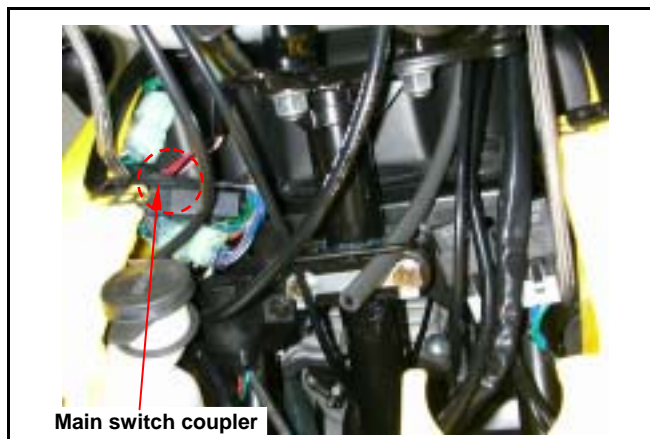

### Handle switches

Disconnect the coupler of handle from front fender left side.  
 Check the continuity between two points as indicated in the table below.

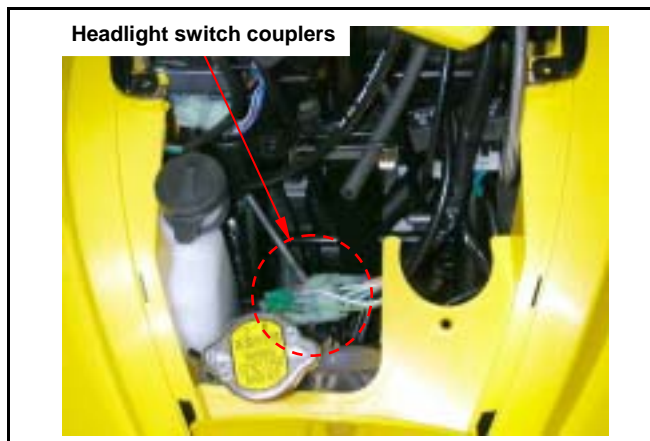

### Start Switch

Position \ Pin	ST	SG
FREE		
⚡	○ ——— ○	○ ——— ○
Wire Color	Yellow / Red	Yellow / Black

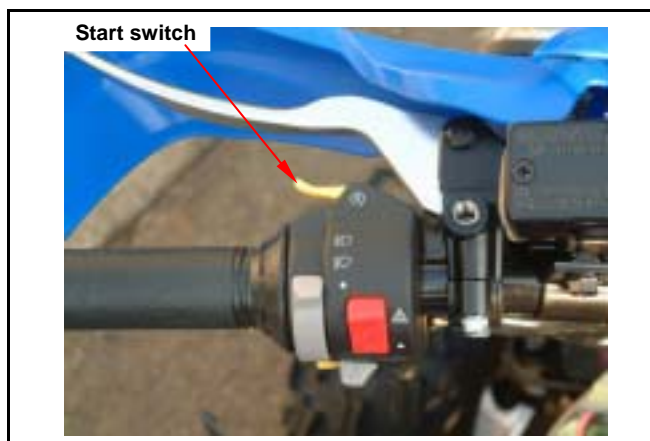

**Headlight Switch**

Position \ Pin	BAT3	LO	HI	PL
	○	○	○	○
	○	○	○	○
Wire color	White / Black	White	Blue	Brown

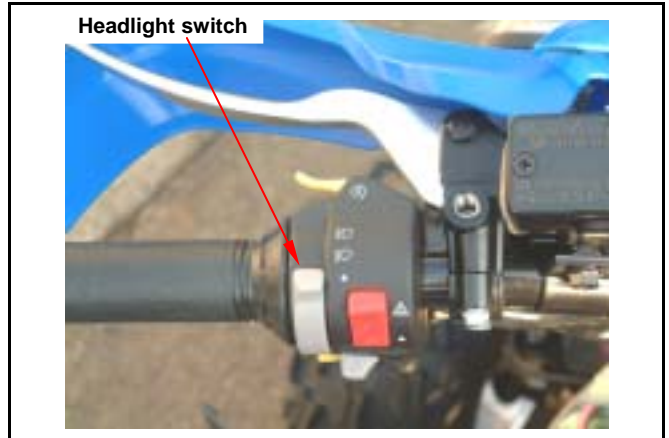

**Winker switch**

Position \ Pin	L	WR	R
	○	○	
N PUSH OFF			
		○	○
Wire color	Pink	Black	Brown / White

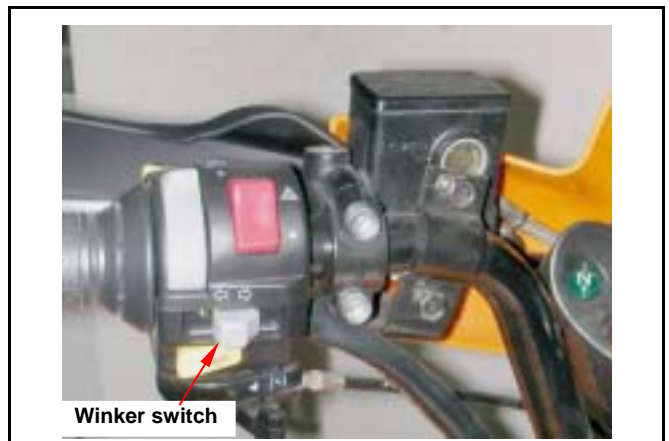

**Horn switch**

Position \ Pin	BAT3	HO
FREE		
	○	○
Wire Color	White/ Black	Light green

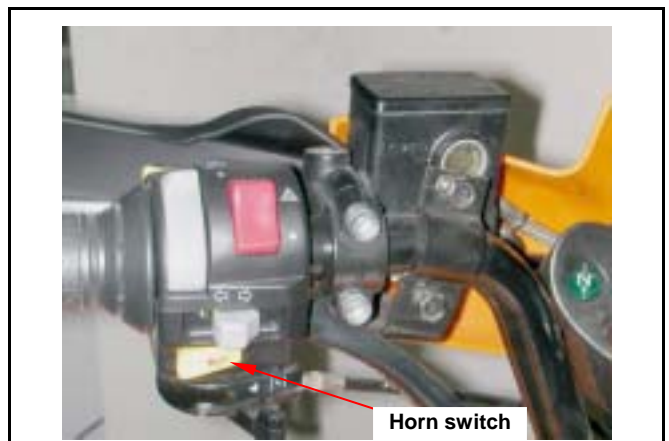

**Hazard switch**

Position \ Pin	HD	E
	○	○
Wire Color	Green / Red	Green

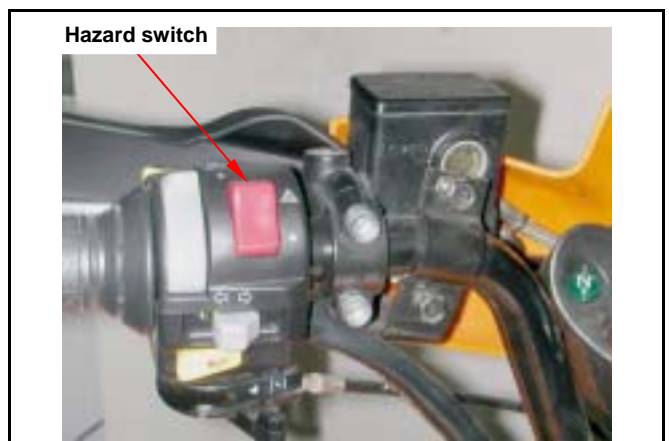



## 17. ELECTRICAL SYSTEM

### Front Brake Switch

While grasp the brake lever firmly, the terminals of brown/blue and green/yellow of the brake should have continuity.  
Replace the switch if damaged.

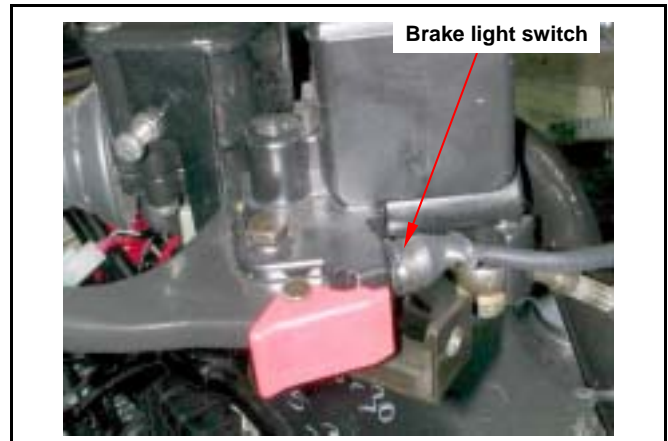

### Rear Brake Switch

While grasp the brake lever firmly, the terminals of white/black and green/yellow of the brake should have continuity.  
Replace the switch if damaged.

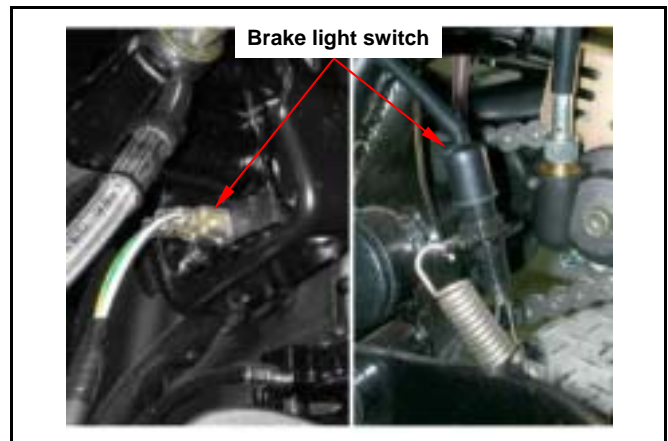

### Horn

Remove the horn from front fender left side.

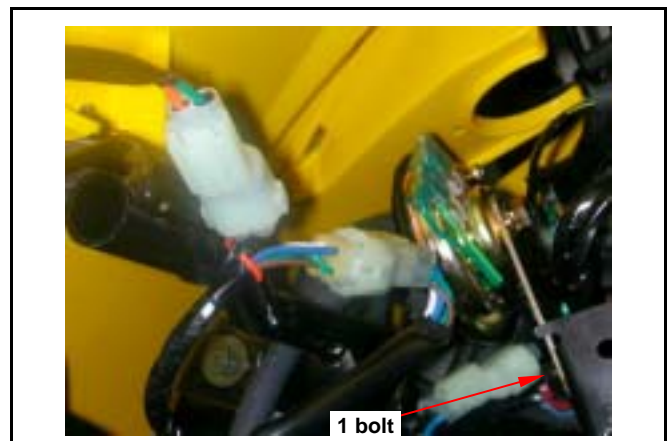

Apply 12 V power source to two terminals of the horn, the horn should sound.  
Replace the horn if necessary.

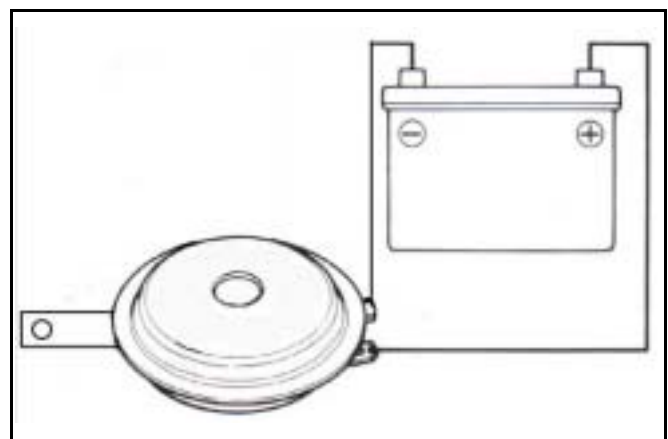

### Fuel Unit

- Remove the seat.
- Remove the fuel tank cap.
- Remove the fuel tank cover and front fender (refer chapter 13).
- Disconnect the coupler of the fuel unit.
- Remove the fuel unit (4 bolts).

**⚠ Caution**

- Great care shall be taken not to damage or bend the float arm of the gauge.

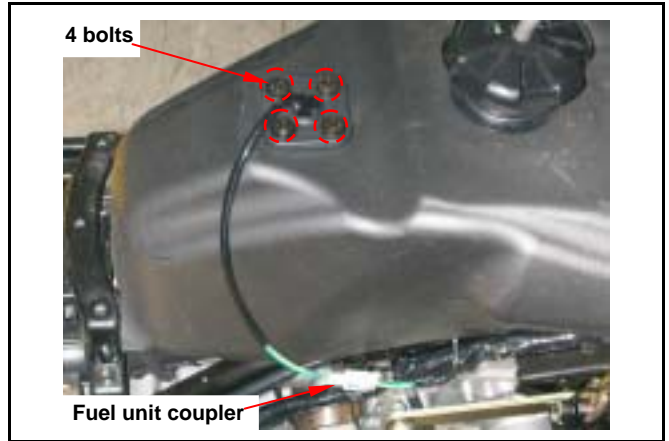

When the float arm shifts to the F position or the E position, the resistance measured shall be as follows:

Position	Resistance
E (Empty)	97.5~107.5 Ω
F (Full)	4~10 Ω

Connect the wiring to the fuel unit and the ohmmeter as shown.

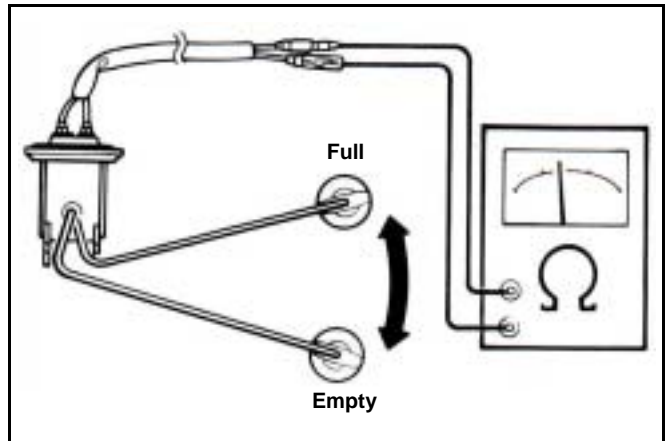

- Connect the fuel unit coupler to the wire harness.
- Turn on the main switch.
- Move the float arm to verify the proper position the fuel gauge needle indicates.

Arm Position	Needle Position
Up (Full)	F (Full)
Down (Empty)	E (Empty)

**⚠ Caution**

While conducting the test, turn on the direction indication lamp to make sure that the battery is in serviceable condition.

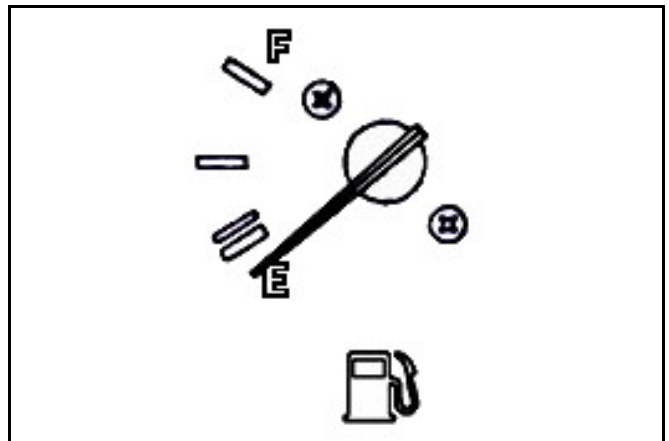

## 17. ELECTRICAL SYSTEM

### Cooling Fan Thermo Switch

The thermo switch mounted on the radiator controls the operation of the cooling fan motor. In case that the fan motor fails to work, disconnect the green and black/blue leads and connect jump wires to the terminals, then, turn on the main switch, the fan motor should operate.

If the fan motor still fails to run, measure battery voltage between the green and black/blue leads. If there is no voltage, check for blown fuse, loose connection or short-circuit.

If the fan motor runs, check the thermo switch in the manner as described below:

Hang the thermo switch on the bowl filled with coolant to check the switch's opening and closing temperatures, confirm the switch is open circuited at room temperature, increase the coolant temperature gradually. The switch should have continuity at  $98\pm 3$  .

#### Caution

- Keep the coolant at a constant temperature at least for three minutes. Sudden increase the coolant temperature will cause the thermometer and the tester to indicate wrong readings.
- Never let the thermometer and the thermo switch contact the wall of the bowl, which may result in wrong readings.
- The thermo switch shall be placed in the coolant until the teeth are completely submerged.

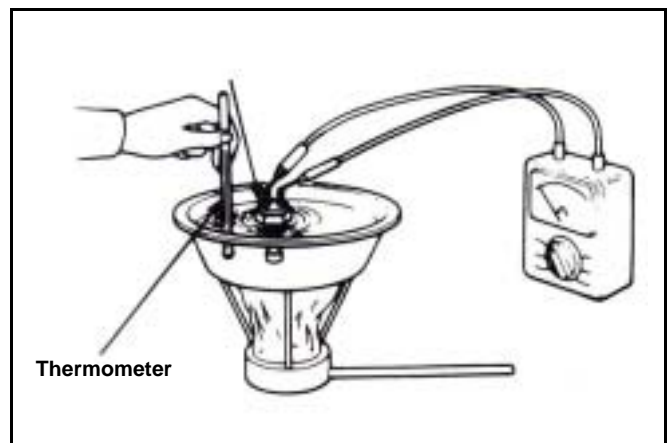
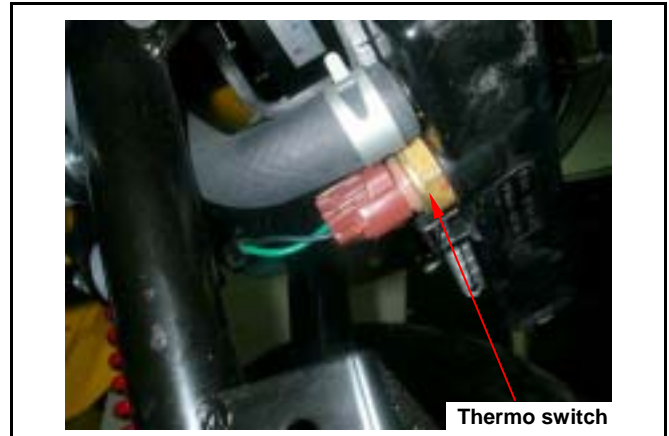

### Thermo unit

Remove the thermo unit.  
 Hang the thermo unit in an oil heater, heat the oil and measure the resistance at each temperature.

Temperature	50°C	80°C	100°C	120°C
Standard ( )	134~149	47.5~57.0	26~29	14.8~17.2

**⚠ Caution**

- Wear gloves and goggles when performing this test.

**⚠ Caution**

- Engine oil should be used as a heating medium as the test temperature must be higher than 100 .
- Contacting the container wall by the thermometer and the thermo unit may result in wrong readings.

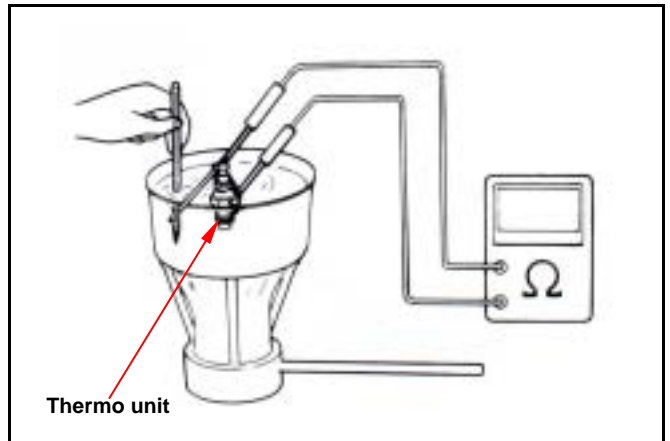

### Water Temperature Indicator Light

Disconnect the water temperature meter and connect it to engine ground.  
 Turn on the main switch.  
 The indicator light of the fuel meter should be lighting.

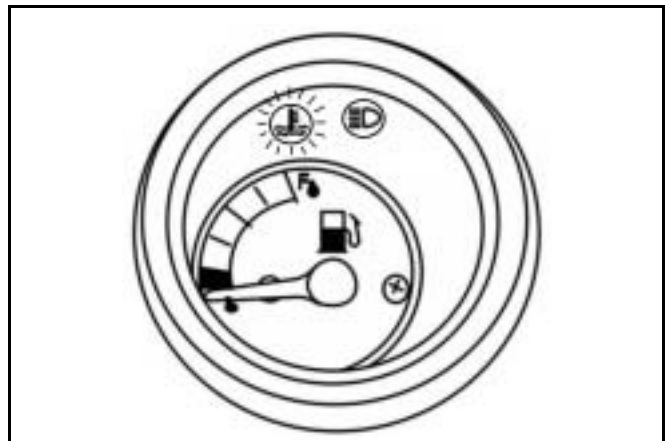

## 17. ELECTRICAL SYSTEM

---



Notes:

# 18. ELECTRICAL DIAGRAM

## QUAD LANDER 250 ELECTRICAL DIAGRAM

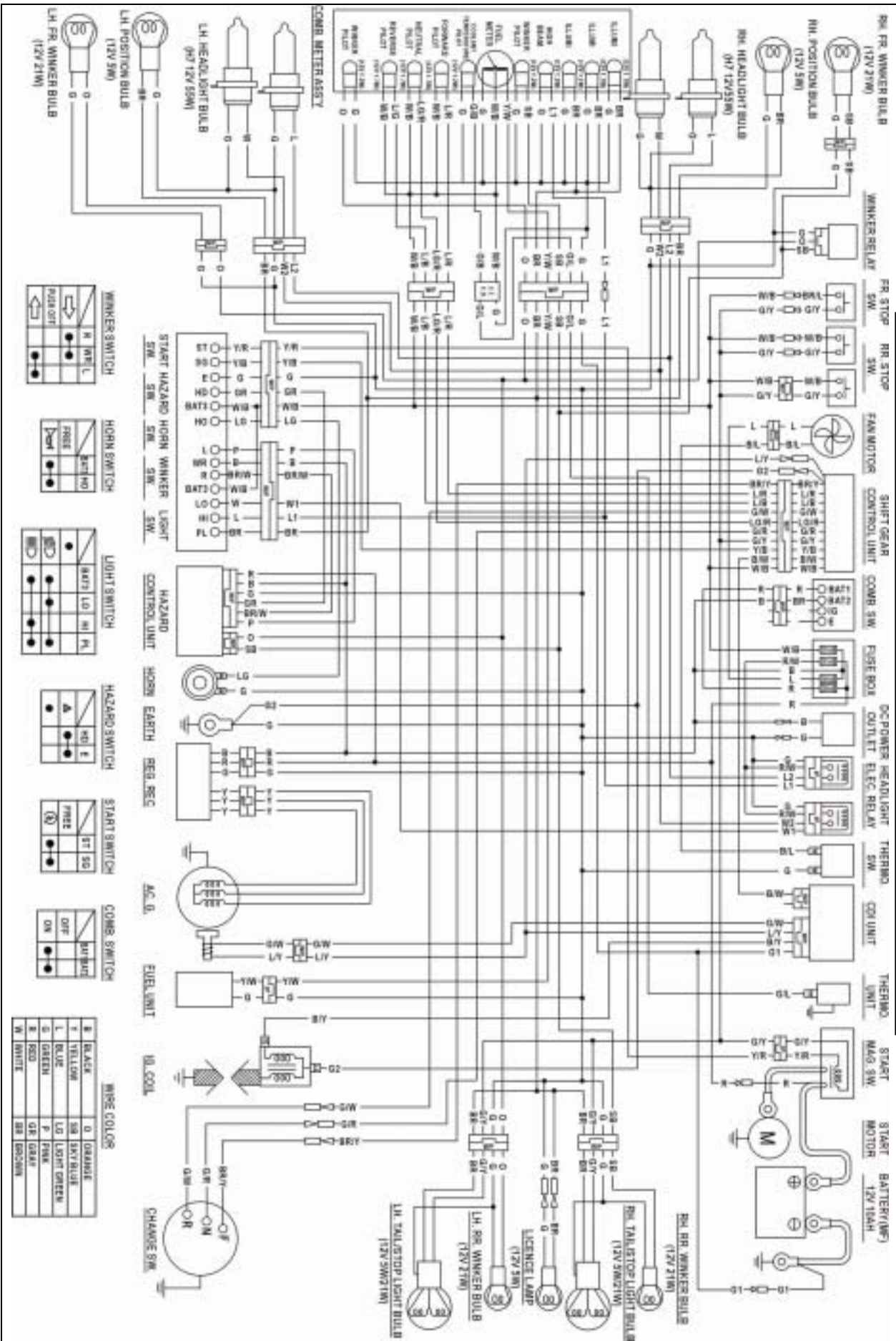

## 18. ELECTRICAL DIAGRAM

---

Notes: