



GTS 250

JOYMAX 250

SERVICE MANUAL

[FORWARD](#)

[CONTENTS](#)

[HOW TO USE THIS MANUAL](#)

[SERIAL NUMBER](#)

This service manual contains the technical data of each component inspection and repair for the SANYANG LM25W series scooter. The manual is shown with illustrations and focused on “Service Procedures”, “Operation Key Points”, and “Inspection Adjustment” so that provides technician with service guidelines.

If the style and construction of the scooter, LM25W series scooter, are different from that of the photos, pictures shown in this manual, the actual vehicle shall prevail. Specifications are subject to change without notice.

Service Department
SANYANG INDUSTRY CO., LTD.

How To Use This Manual



This service manual describes basic information of different system parts and system inspection & service for SANYANG LM25W series scooter. In addition, please refer to the manual contents in detailed for the model you serviced in inspection and adjustment.

The first chapter covers general information and trouble diagnosis.

The second chapter covers service maintenance information and special tools manual.

The third to the 11th chapters cover engine and driving systems.

The 12th chapter is cooling system.

The 13th to the 16th chapter is contained the parts set of assembly frame body.

The 17th chapter is electrical equipment.

The 18th chapter is wiring diagram.

Please see index of content for quick having the special parts and system information.

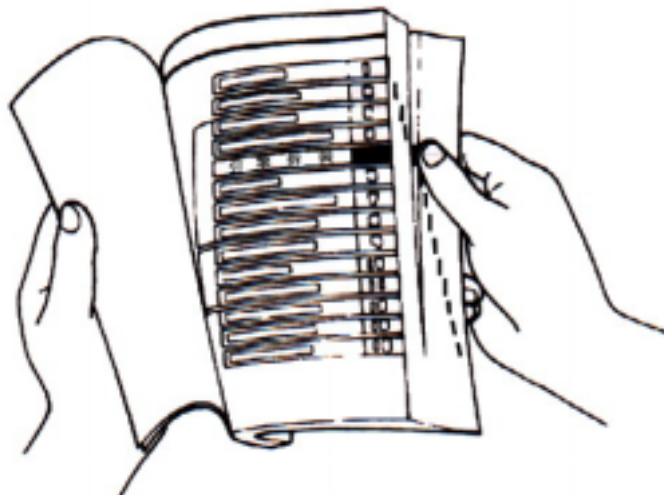

There are 4 buttons, “[Forward](#)”, “[Contents](#)”, “[How to use this manual](#)” and “[Mechanism Illustrations](#)” on the CD-R version, and can be access to these items by click the mouse.

If user wants to look for the content of each chapter, selecting the words of each chapter on the contents can reach to each chapter. There are two buttons, “Homepage and contents, onto the top line of first page of the each chapter. Thus, if the user needs to check other chapters, he can click the top buttons to back the homepage or contents. The content of each chapter can be selected too. Therefore, when needs to checking the content inside of the chapter, click the content words of the chapter so that can back to the initial section of the content. In addition, there is a “[To this chapter contents](#)” button at the second page of each contents so that clicking the button can back to the contents of this chapter.

Page	Content	Index
1-1 ~ 1-16	General Information	1
2-1 ~ 2-18	Service Maintenance Information	2
3-1 ~ 3-8	Lubrication System	3
4-1 ~ 4-14	Fuel System	4
5-1 ~ 5-10	Engine Removal	5
6-1 ~ 6-16	Cylinder Head / Valve	6
7-1 ~ 7-8	Cylinder / Piston	7
8-1 ~ 8-14	“V” Type Belt Driving System / Kick-Starter	8
9-1 ~ 9-8	Final Driving Mechanism	9
10-1 ~ 10-10	Alternator	10
11-1 ~ 11-8	Crankshaft / Crankcase	11
12-1 ~ 12-14	Cooling System	12
13-1 ~ 13-14	Body Cover	13
14-1 ~ 14-12	Front Brake / Front Wheel	14
15-1 ~ 15-10	Steering / Front Cushion	15
16-1 ~ 16-6	Rear Brake / Rear Wheel / Rear Cushion	16
17-1 ~ 17-24	Electrical Equipment	17
18-1 ~ 18-2	Electrical Diagram	18

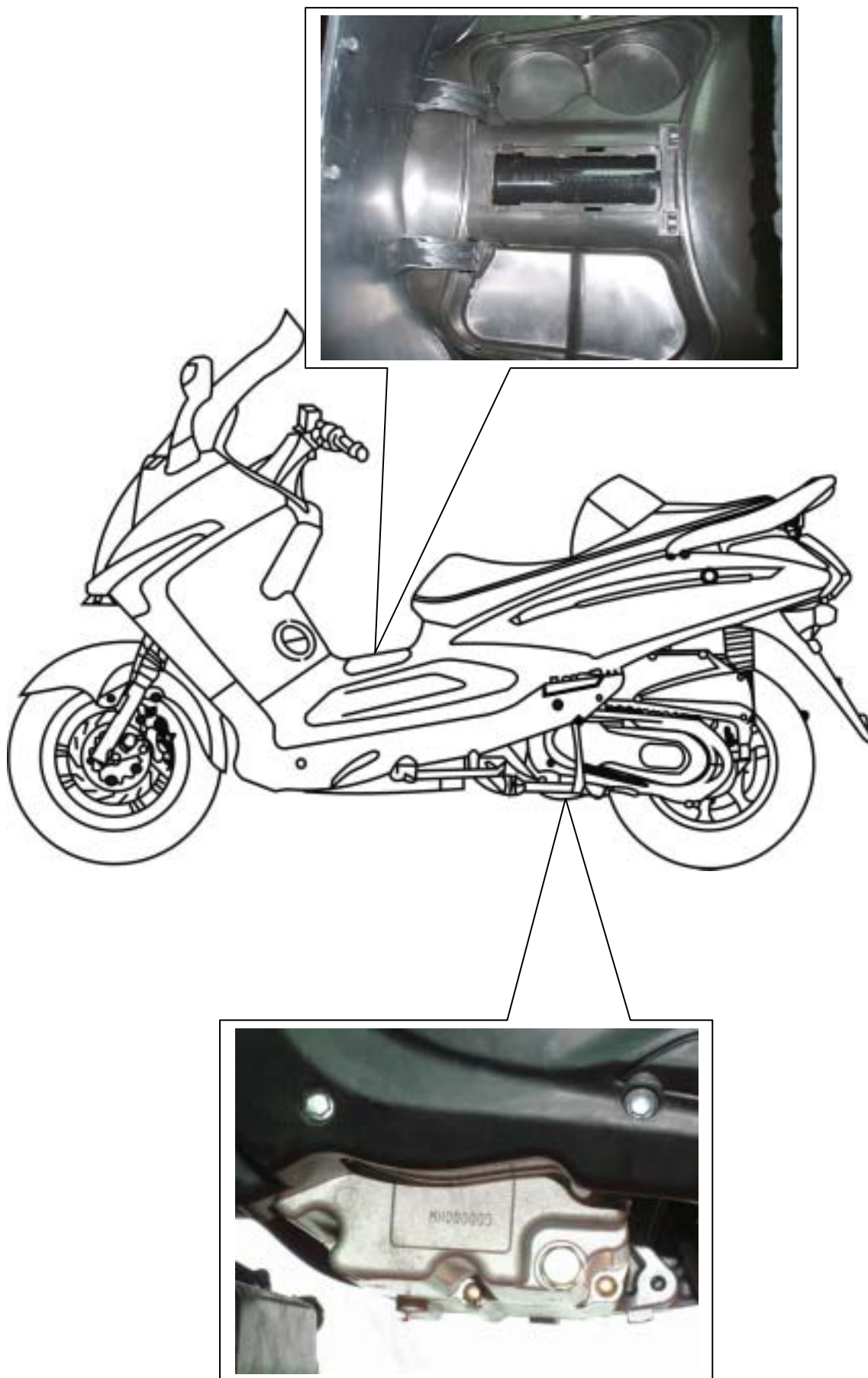

Symbols and Marks1-1	Torque Values 1-10
General Safety1-2	Troubles Diagnosis 1-12
Service Precautions1-3	Lubrication Points 1-16
Specifications1-9	

Symbols and Marks

Symbols and marks are used in this manual to indicate what and where the special service are needed, in case supplemental information is procedures needed for these symbols and marks, explanations will be added to the text instead of using the symbols or marks.

	Warning	Means that serious injury or even death may result if procedures are not followed.
	Caution	Means that equipment damages may result if procedures are not followed.
	Engine oil	Limits to use SAE 10W-30 API SG class oil. Warranty will not cover the damage that caused by not apply with the limited engine oil. (Recommended oil: KING MATE G-3 oil)
	Grease	King Mate G-3 is recommended.
	Gear oil	King Mate gear oil serials are recommended. (Bramax HYPOID GEAR OIL # 140)
	Locking sealant	Apply sealant; medium strength sealant should be used unless otherwise specified.
	Oil seal	Apply with lubricant. .
	Renew	Replace with a new part before installation.
	Brake fluid	Use recommended brake fluid DOT3 or WELLRUN brake fluid.
	Special tools	Special tools
	Correct	Meaning correct installation.
	Wrong	Meaning wrong installation.
	Indication	Indication of components.
	Directions	Indicates position and operation directions
		Components assembly directions each other.
		Indicates where the bolt installation direction, --- means that bolt cross through the component (invisibility).

1. General Information

General Safety

Carbon monoxide

If you must run your engine, ensure the place is well ventilated. Never run your engine in a closed area. Run your engine in an open area, if you have to run your engine in a closed area, be sure to use an extractor.

Caution

Exhaust contains toxic gas which may cause one to lose consciousness and even result in death.

Gasoline

Gasoline is a low ignition point and explosive material. Work in a well-ventilated place, no flame or spark should be allowed in the work place or where gasoline is being stored.

Caution

Gasoline is highly flammable, and may explode under some conditions, keep it away from children.

Used engine oil

Caution

Prolonged contact with used engine oil (or transmission oil) may cause skin cancer although it might not be verified. We recommend that you wash your hands with soap and water right after contacting. Keep the used oil beyond reach of children.

Hot components

Caution

Components of the engine and exhaust system can become extremely hot after engine running. They remain very hot even after the engine has been stopped for some time. When performing service work on these parts, wear insulated gloves and wait until cooling off.

Battery

Caution

Battery emits explosive gases; flame is strictly prohibited. Keep the place well ventilated when charging the battery.

Battery contains sulfuric acid (electrolyte) which can cause serious burns so be careful do not be spray on your eyes or skin. If you get battery acid on your skin, flush it off immediately with water. If you get battery acid in your eyes, flush it off immediately with water and then go to hospital to see an ophthalmologist.

If you swallow it by mistake, drink a lot of water or milk, and take some laxative such as castor oil or vegetable oil and then go to see a doctor.

Keep electrolyte beyond reach of children.

Brake shoe

Do not use an air hose or a dry brush to clean components of the brake system; use a vacuum cleaner or the equivalent to avoid dust flying.

Caution

Inhaling brake shoe or pad ash may cause disorders and cancer of the breathing system

Brake fluid

Caution

Spilling brake fluid on painted, plastic, or rubber parts may cause damage to the parts. Place a clean towel on the above-mentioned parts for protection when servicing the brake system. Keep the brake fluid beyond reach of children.

Service Precautions

- Always use with SANYANG genuine parts and recommended oils. Using non-designed parts for SANYANG ATV may damage the ATV.

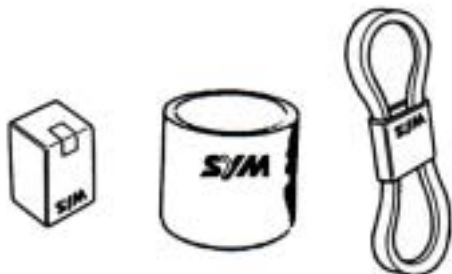

- Special tools are designed for remove and install of components without damaging the parts being worked on. Using wrong tools may result in parts damaged.

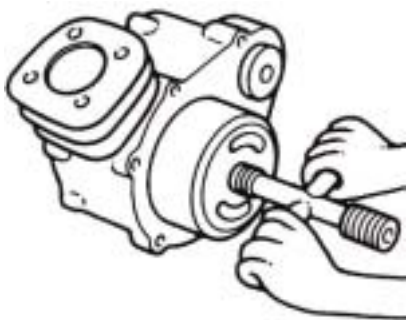

- When servicing this ATV, use only metric tools. Metric bolts, nuts, and screws are not interchangeable with the English system, using wrong tools and fasteners may damage this vehicle.
- Clean the outside of the parts or the cover before removing it from the ATV. Otherwise, dirt and deposit accumulated on the part's surface may fall into the engine, chassis, or brake system to cause damage.
- Wash and clean parts with high ignition point solvent, and blow dry with compressed air. Pay special attention to O-rings or oil seals because most cleaning agents have an adverse effect on them.

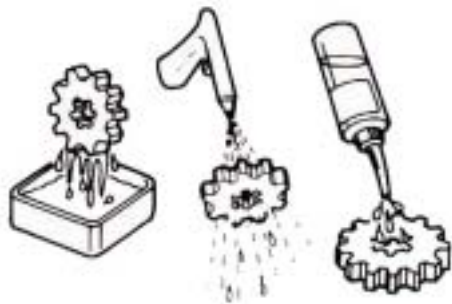

- Never bend or twist a control cable to prevent unsmooth control and premature worn out.



- Rubber parts may become deteriorated when old, and prone to be damaged by solvent and oil. Check these parts before installation to make sure that they are in good condition, replace if necessary.
- When loosening a component which has different sized fasteners, operate with a diagonal pattern and work from inside out. Loosen the small fasteners first. If the bigger ones are loosen first, small fasteners may receive too much stress.
- Store complex components such as transmission parts in the proper assemble order and tie them together with a wire for ease of installation later.

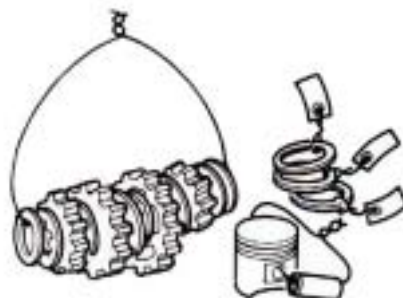

- Note the reassemble position of the important components before disassembling them to ensure they will be reassembled in correct dimensions (depth, distance or position).
- Components not to be reused should be replaced when disassembled including gaskets metal seal rings, O-rings, oil seals, snap rings, and split pins.



1. General Information

- The length of bolts and screws for assemblies, cover plates or boxes is different from one another, be sure they are correctly installed. In case of confusion, Insert the bolt into the hole to compare its length with other bolts, if its length out side the hole is the same with other bolts, it is a correct bolt. Bolts for the same assembly should have the same length.

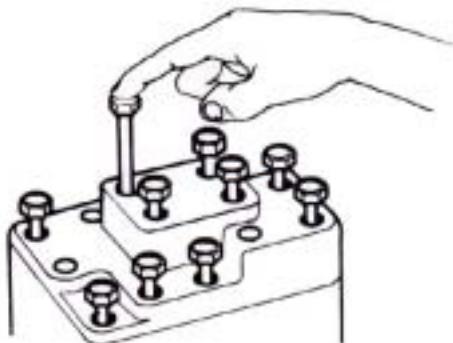

- Tighten assemblies with different dimension fasteners as follows: Tighten all the fasteners with fingers, then tighten the big ones with special tool first diagonally from inside toward outside, important components should be tightened 2 to 3 times with appropriate increments to avoid warp unless otherwise indicated. Bolts and fasteners should be kept clean and dry. Do not apply oil to the threads.

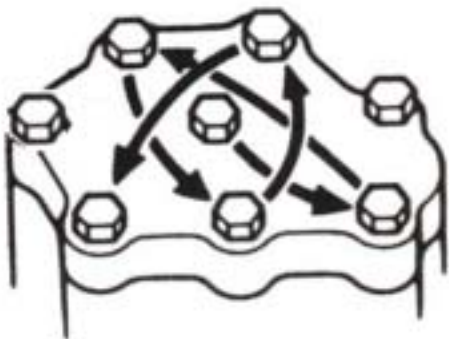

- When oil seal is installed, fill the groove with grease, install the oil seal with the name of the manufacturer facing outside, and check the shaft on which the oil seal is to be installed for smoothness and for burrs that may damage the oil seal.

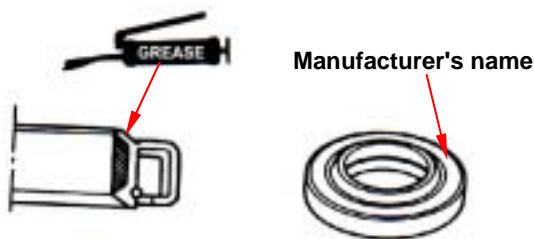

- Remove residues of the old gasket or sealant before reinstallation, grind with a grindstone if the contact surface has any damage.



- The ends of rubber hoses (for fuel, vacuum, or coolant) should be pushed as far as they can go to their connections so that there is enough room below the enlarged ends for tightening the clamps.

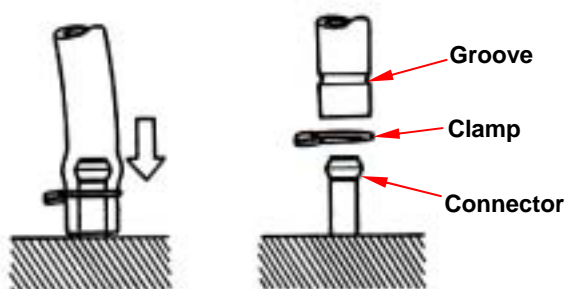

- Rubber and plastic boots should be properly reinstalled to the original correct positions as designed.

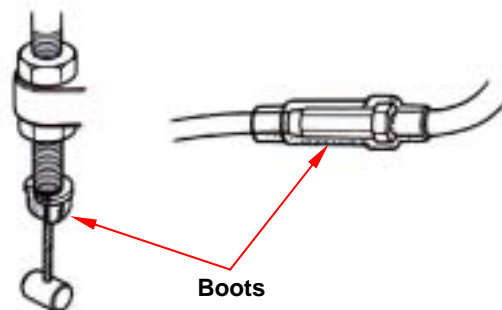

- The tool should be pressed against two (inner and outer) bearing races when removing a ball bearing. Damage may result if the tool is pressed against only one race (either inner race or outer race). In this case, the bearing should be replaced. To avoid damaging the bearing, use equal force on both races.

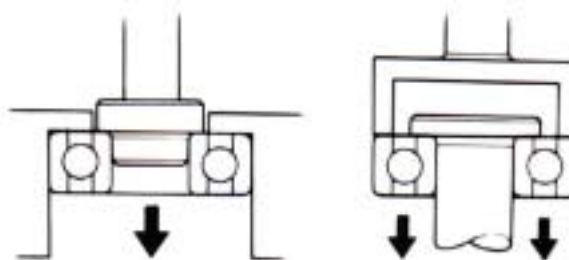

Both of these examples can result in bearing damage.

- Lubricate the rotation face with specified lubricant on the lubrication points before assembling.

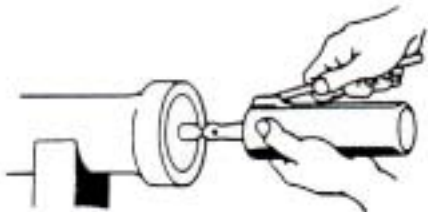

- Check if positions and operation for installed parts is in correct and properly.



- Make sure service safety each other when conducting by two persons.



- Note that do not let parts fall down.



- Before battery removal operation, it has to remove the battery negative (-) cable firstly. Notre tools like open-end wrench do not contact with body to prevent from circuit short and create spark.

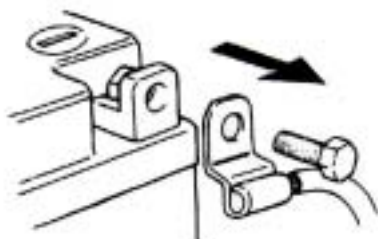

- After service completed, make sure all connection points is secured. Battery positive (+) cable should be connected firstly.
- And the two posts of battery have to be greased after connected the cables.



- Make sure that the battery post caps are located in properly after the battery posts had been serviced.

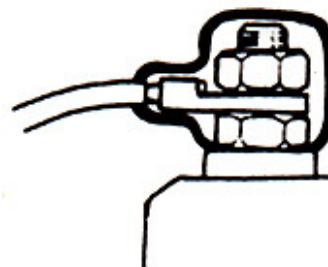

- If fuse burned, it has to find out the cause and solved it. And then replace with specified capacity fuse.

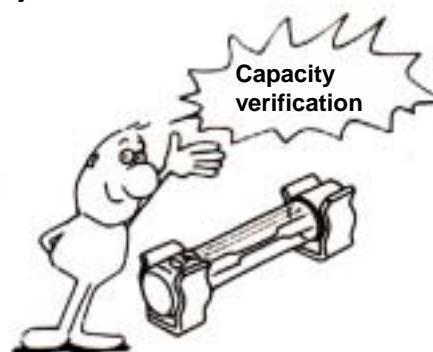

1. General Information

- When separating a connector, it locker has to be unlocked firstly. Then, conduct the service operation.

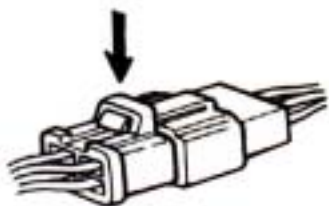

- Do not pull the wires as removing a connector or wires. Hold the connector body.



- Make sure if the connector pins are bent, extruded or loosen.

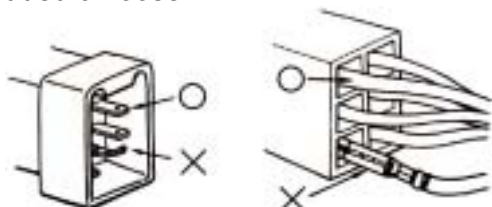

- Insert the connector completely. If there are two lockers on two connector sides, make sure the lockers are locked in properly. Check if any wire loose.

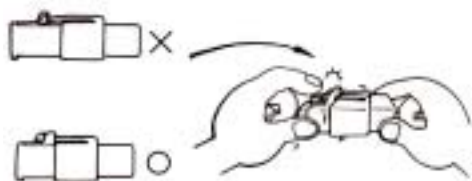

- Check if the connector is covered by the twin connector boot completely and secured properly.

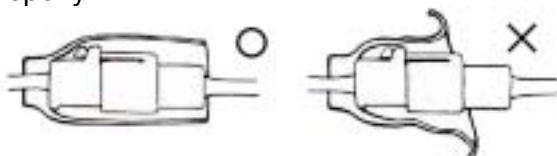

- Before terminal connection, check if the boot is crack or the terminal is loose.

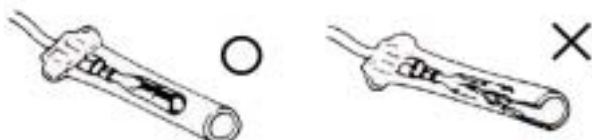

- Insert the terminal completely. Check if the terminal is covered by the boot. Do not let boot open facing up.



- Secure wires and wire harnesses to the frame with respective wire bands at the designated locations. Tighten the bands so that only the insulated surfaces contact the wires or wire harnesses.

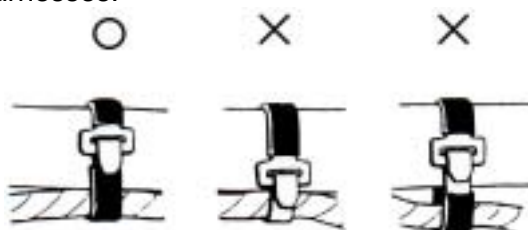

- Wire band and wire harness have to be clamped secured properly.

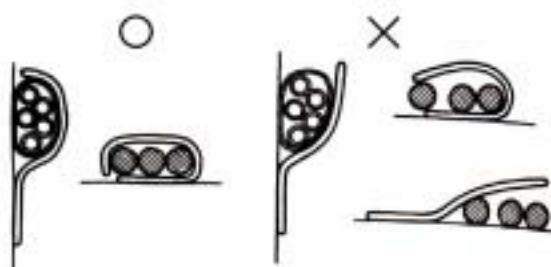

- Do not squeeze wires against the weld or its clamp.



- Do not let the wire harness contact with rotating, moving or vibrating components as routing the harness.

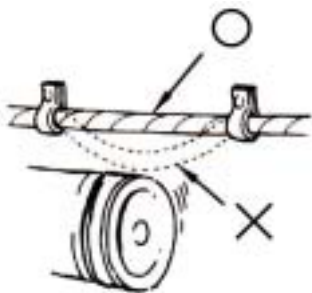

- Keep wire harnesses far away from the hot parts.

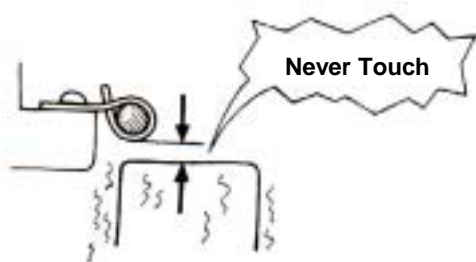

- Route wire harnesses to avoid sharp edges or corners and also avoid the projected ends of bolts and screws.

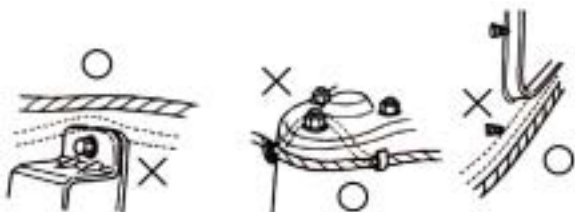

- Route harnesses so that they neither pull too tight nor have excessive slack.

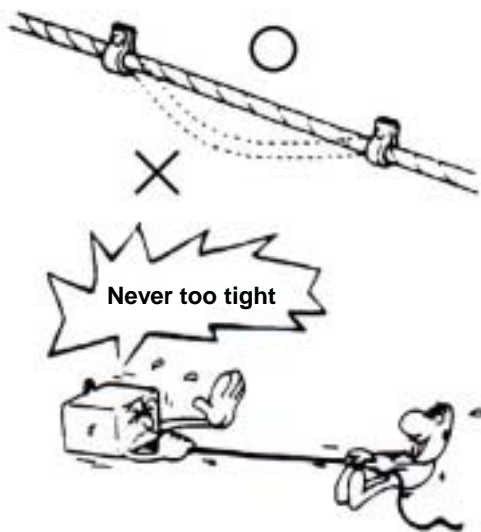

- Protect wires or wire harnesses with electrical tape or tube if they contact a sharp edge or corner. Thoroughly clean the surface where tape is to be applied.

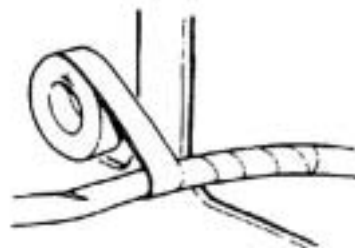

- Secure the rubber boot firmly as applying it on wire harness.

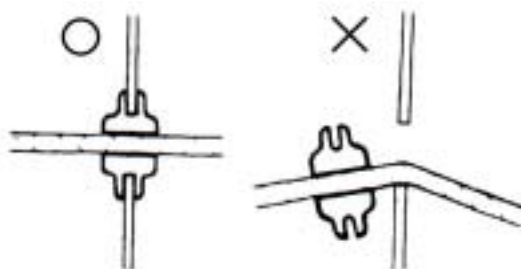

- Never use wires or harnesses which insulation has been broken. Wrap electrical tape around the damaged parts or replace them.

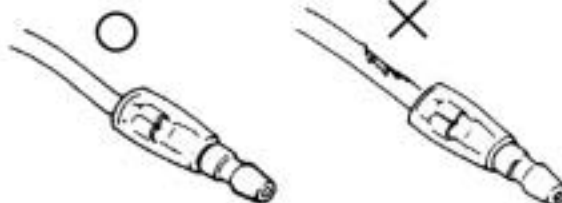

- Never clamp or squeeze the wire harness as installing other components.

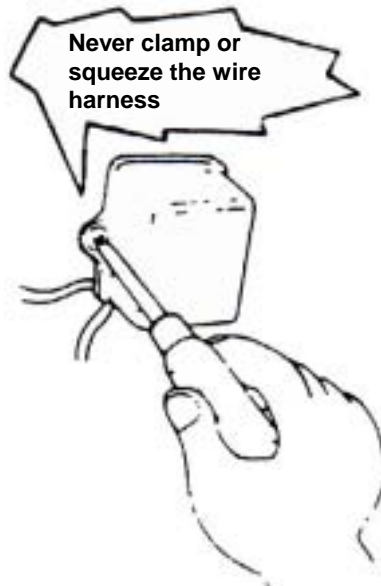

1. General Information

- Do not let the wire harness been twisted as installation.

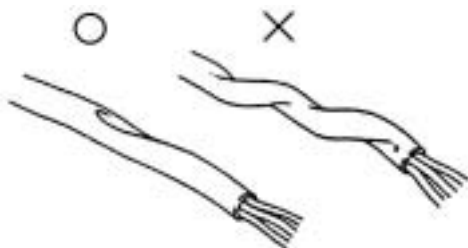

- Wire harnesses routed along the handlebar should not be pulled too tight or have excessive slack, be rubbed against or interfere with adjacent or surrounding parts in all steering positions.

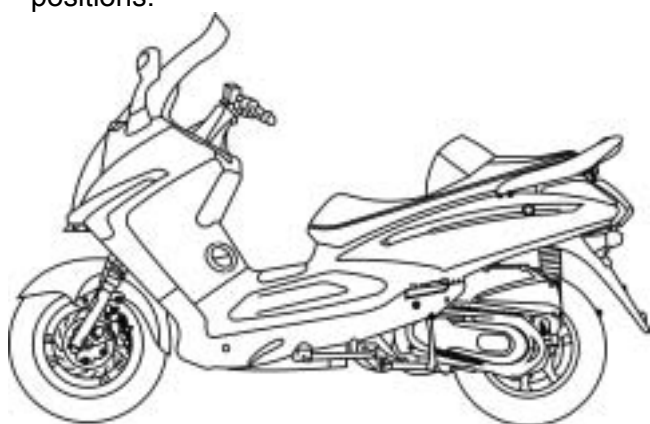

- With sand paper to clean rust on connector pins/terminals if found. And then conduct connection operation later.

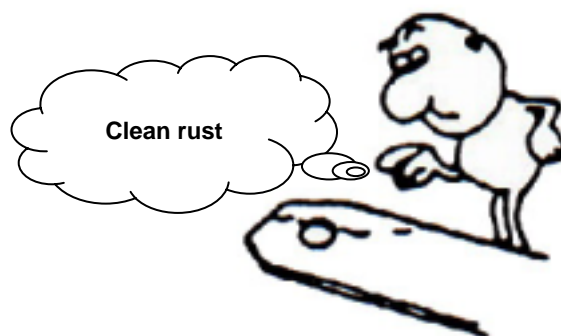

- Before operating a test instrument, operator should read the operation manual of the instrument. And then, conduct test in accordance with the instruction.

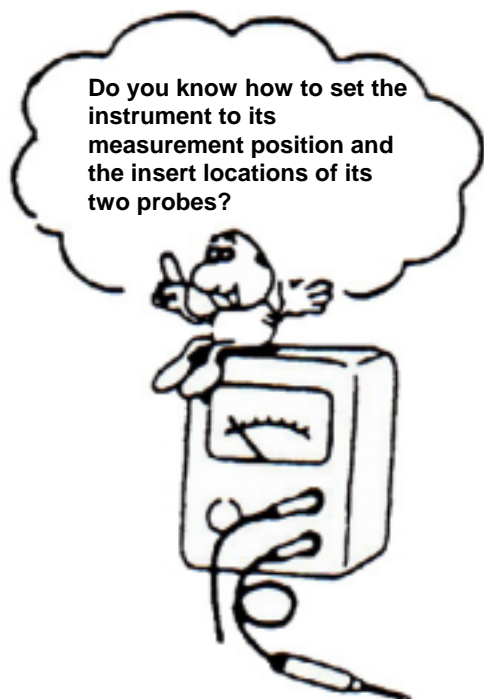

Specifications

MAKER		SANYANG		MODEL		LM25W		
Dimension	Overall Length	2165 mm		Suspension System	Front	TELESCOPE		
	Overall Width	870 mm			Rear	UNIT SWING		
	Overall Height	1380 mm		Tire Specifications	Front	110 / 90-13 56P		
	Wheel Base	1495 mm			Rear	130 / 70-13 57P		
Weight	Curb Weight	Front	69 kg		Brake System	Front	DISK (ø 240 mm)	
		Rear	104 kg			Rear	DISK (ø 220 mm)	
		Total	173 kg					
	Passengers/Weight		Two / 110 kg		Performance	Max. Speed	Above 115 km/hr	
	Total Weight	Front	91 kg			Climb Ability	Below 24°	
		Rear	192 kg		Reduction	Primary Reduction	Belt	
Total		283 kg		Secondary Reduction		Gear		
Type		4-STROKE ENGINE		Clutch	Centrifugal, dry type			
Installation and arrangement		Vertical, below center, incline 80°		Transmission	C.V.T., auto speed change			
Fuel Used		Above 92 unleaded		Speedometer		0 ~ 160 km/hr		
Cycle/Cooling		4-stroke/ forced air cooled		Horn		80~112 dB/A		
Engine	Cylinder	Bore	71 mm		Muffler		Expansion & Pulse Type	
		Stroke	63 mm		Exhaust Pipe Position and Direction		Right side, and Backward	
		Number/Arrangement	SINGLE CYLINDER		Lubrication System		Forced circulation & splashing	
Displacement		249.4 cc		Exhaust Concentration =	Solid Particulate		-	
Compression Ratio		10.5 : 1			CO		Below 7.0 g/km	
Max. HP		15.4kw / 7500 rpm			HC+Nox		Below 2.0 g/km	
Max. Torque		21.6 Nm / 6500 rpm		E.E.C.		√		
Ignition		Full transistor ignition		P.C.V.		√		
Starting System		Electrical starter		Catalytic reaction control system		√		

1. General Information

Torque Values

The torque values listed in above table are for more important tighten torque values. Please see standard values for not listed in the table.

Standard Torque Values for Reference

Type	Tighten Torque	Type	Tighten Torque
5 mm bolt、 nut	0.45~0.6kgf-m	5 mm screw	0.35~0.5kgf-m
6 mm bolt、 nut	0.8~1.2kgf-m	6 mm screw、 SH nut	0.7~ 1.1kgf-m
8 mm bolt、 nut	1.8~2.5kgf-m	6 mm bolt、 nut	1.0 ~1.4kgf-m
10 mm bolt、 nut	3.0~4.0kgf-m	8 mm bolt、 nut	2.4 ~3.0kgf-m
12 mm bolt、 nut	5.0~6.0kgf-m	10 mm bolt、 nut	3.5~4.5kgf-m

Engine Torque Values

Item	Q'ty	Thread Dia. (mm)	Torque Value(kgf-m)	Remarks
Cylinder stud bolt	4	10	1.0~1.4	Apply oil to thread
Cylinder head nut	4	8	3.6~4.0	
Cylinder head right bolt	2	8	2.0~2.4	
Cylinder head side cover bolt	2	6	1.0~1.4	
Cylinder head cover bolt	4	6	1.0~1.4	
Cylinder head stud bolt (inlet pipe)	2	6	1.0~1.4	
Cylinder head stud bolt (EX. pipe)	2	8	2.4~3.0	
Air inject pipe bolt	4	6	1.0~1.4	
Air inject reed valve bolt	2	3	0.07~0.09	
Tappet adjustment screw nut	4	5	0.7~1.1	
Spark plug	1	10	1.0~1.2	
Tensioner lifter bolt	2	6	1.0~1.4	
Carburetor insulator bolt	2	6	0.7~1.1	
Oil pump screw	2	3	0.1~0.3	
Water pump impeller	1	7	1.0~1.4	
Engine left cover bolt	9	6	1.1~1.5	
Engine oil draining bolt	1	12	3.5~4.5	
Engine oil strainer cap	1	30	1.3~1.7	
Mission draining bolt	1	8	0.8~1.2	
Mission filling bolt	1	10	1.0~1.4	
Clutch driving plate nut	1	28	5.0~6.0	
Clutch outer nut	1	14	5.0~6.0	
Drive face nut	1	14	8.5~10.5	
ACG. Flywheel nut	1	14	5.0~6.0	
Crankcase bolt	7	6	0.8~1.2	
Mission case bolt	7	8	2.6~3.0	
Muffler mounting bolt	3	10	3.2 ~3.8	
Muffler mounting nut	2	8	1.0 ~1.2	

Frame Torque Values

Item	Q'ty	Thread Dia. (mm)	Torque Value (Kg-m)	Remarks
Mounting bolt for steering handle post	1	10	4.0~5.0	
Lock nut for steering stem	1	BC1	1.0~2.0	
Steering top cone race	1	BC1	2.0~3.0	
Front wheel axle nut	1	12	5.0~7.0	
Rear wheel axle nut	1	16	11.0~13.0	
Front cushion mounting bolt	4	10	3.5~4.5	
Rear cushion upper connection bolt	1	10	3.5~4.5	
Rear cushion under connection bolt	1	8	2.4~3.0	
Rear fork mounting bolt	2	10	4.0~5.0	
Brake hose bolt	2	10	3.0~4.0	
Brake air-bleeding valve	1	6	0.8~1.0	
Front brake disc mounting bolt	5	8	4.0~4.5	
Rear brake disc mounting bolt	5	8	4.0~4.5	
Brake clipper mounting bolt	2	8	2.9~3.5	
Engine hanger link bolt	2	12	7.5~9.5	On frame side
Engine hanger link nut	1	12	7.5~9.5	On engine side
Main standard nut	1	10	4.0~5.0	
Air cleaner bolts	2	6	1.0~1.4	

1. General Information

Troubles Diagnosis

A. Engine hard to start or can not be started

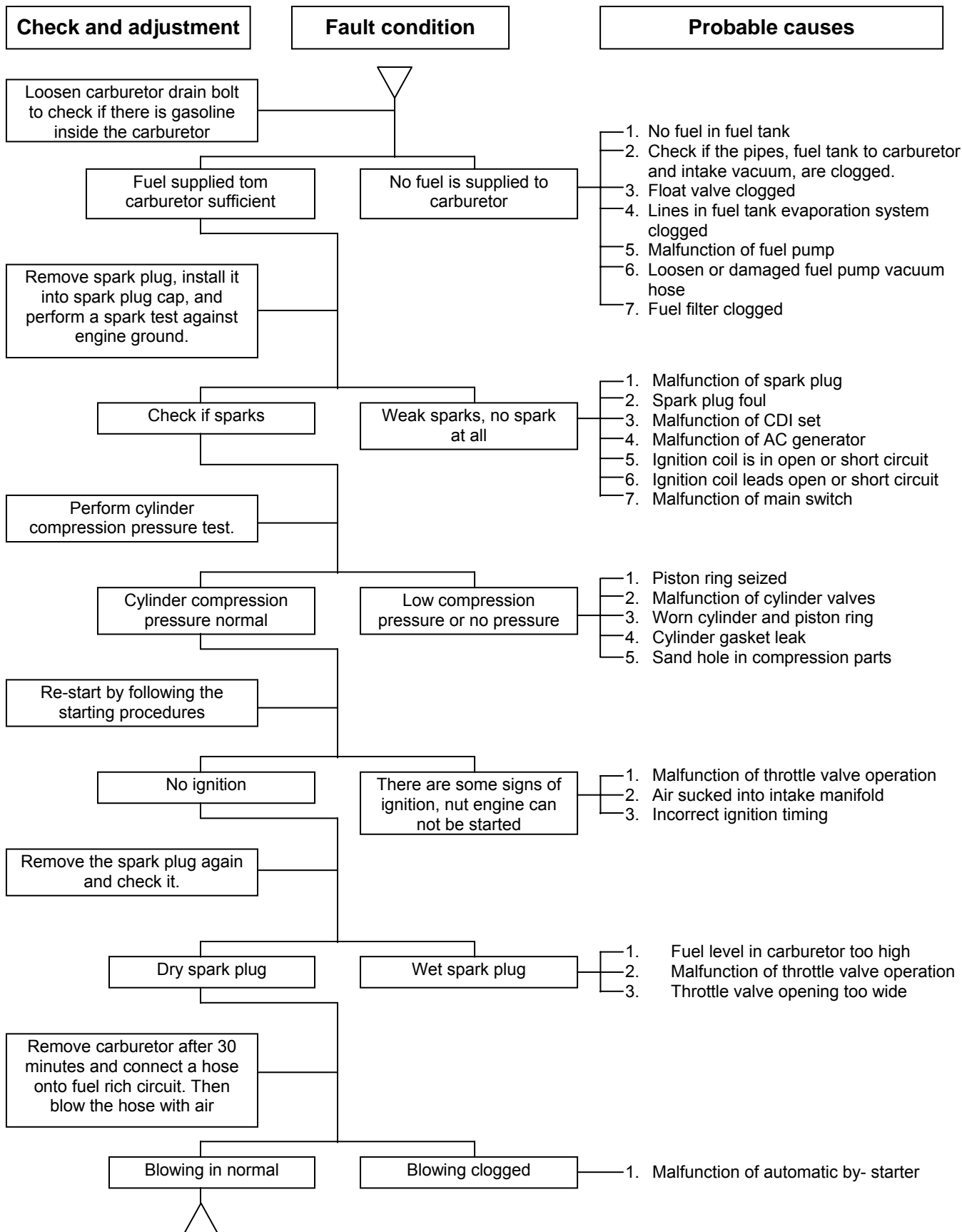

B. Engine run sluggish (Speed does not pick up, lack of power)

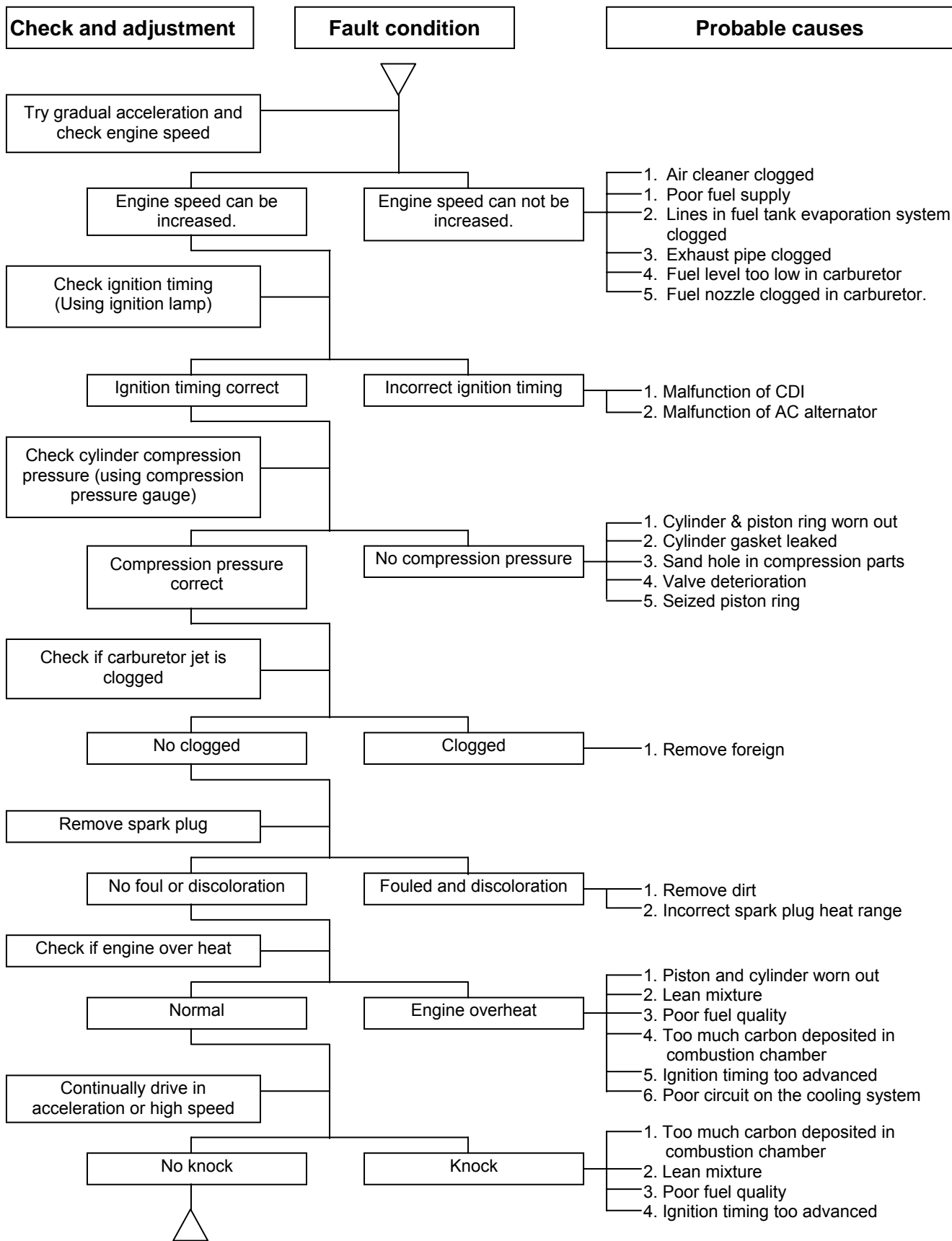

1. General Information

C. Engine runs sluggish (especially in low speed and idling)

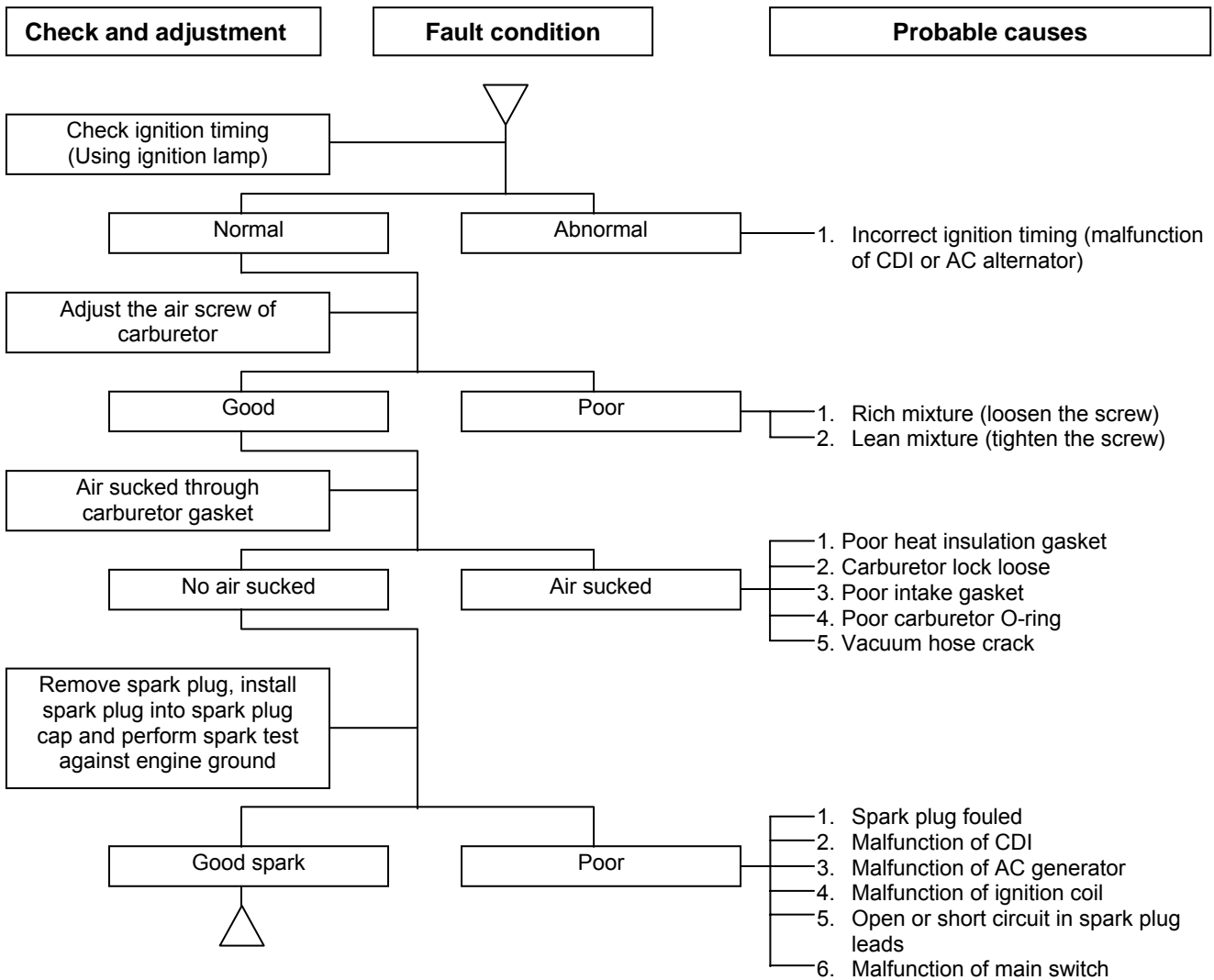

D. Engine runs sluggish (High speed)

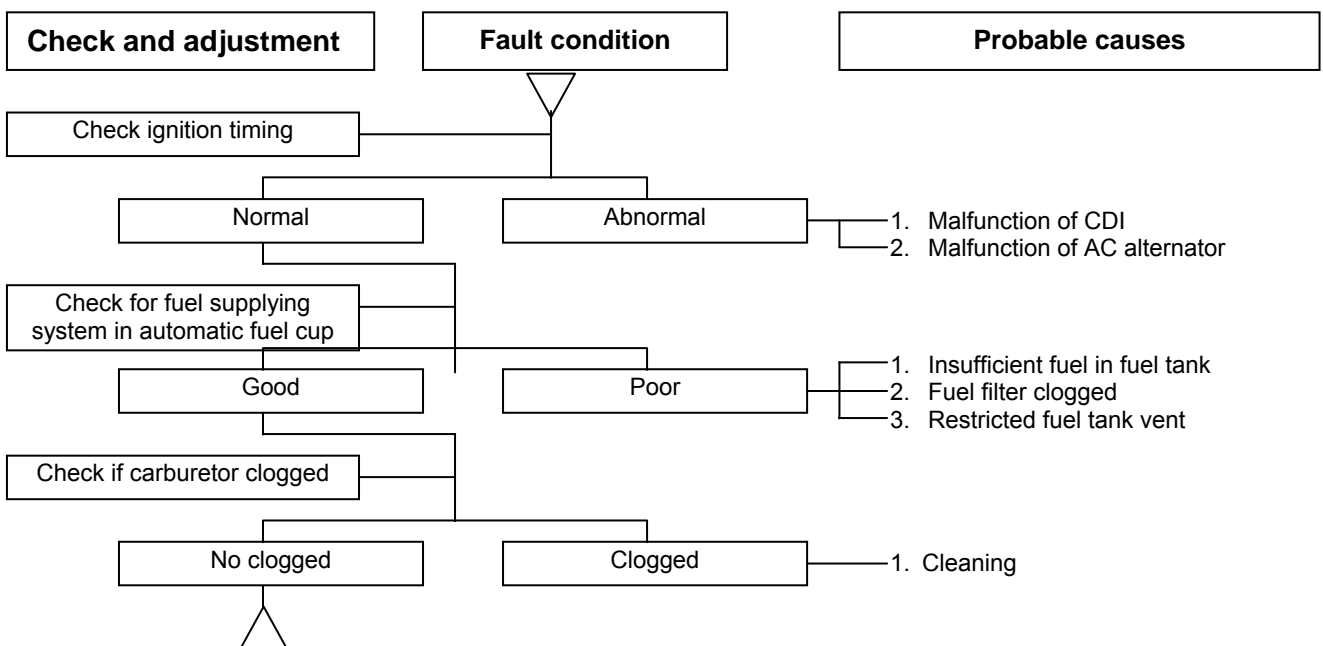

E. Clutch, Driving And Driving Pulley

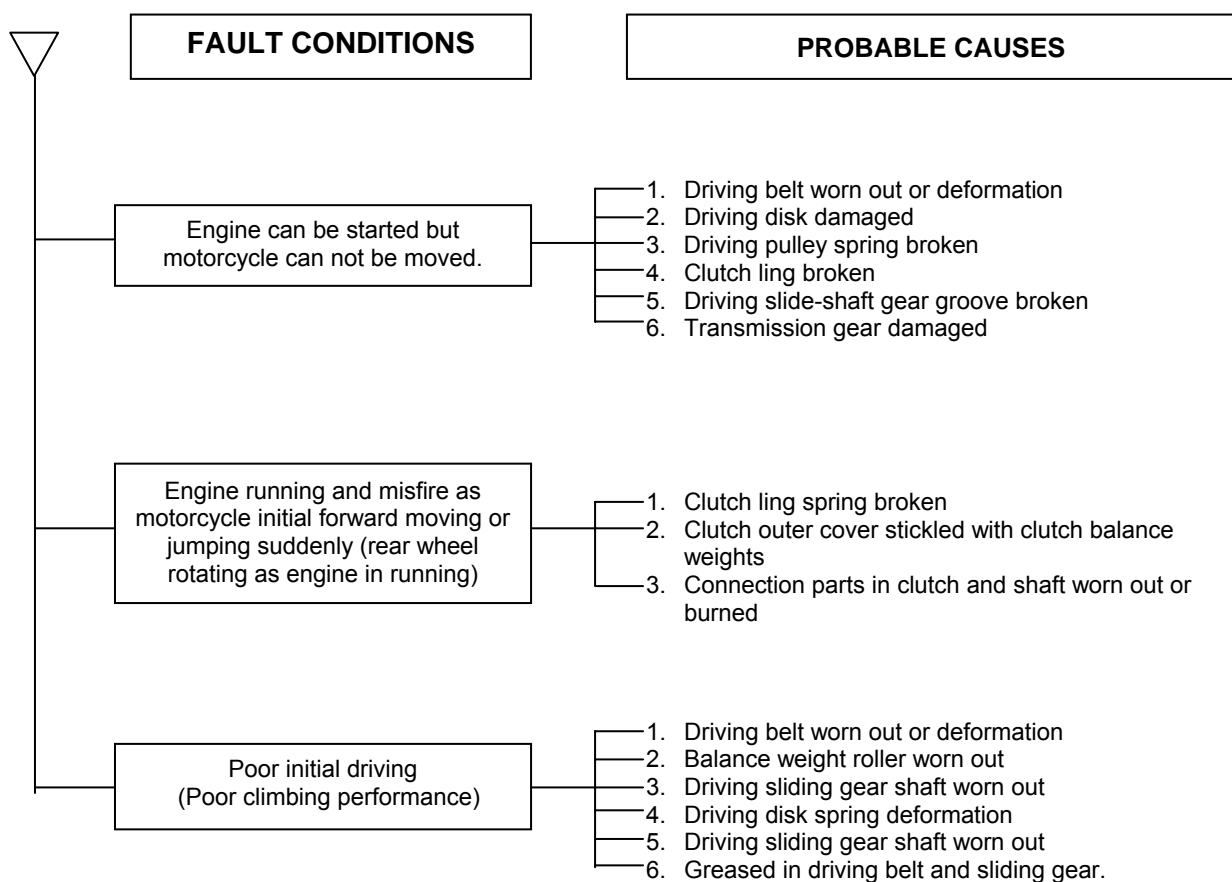

1. General Information

Lubrication Points

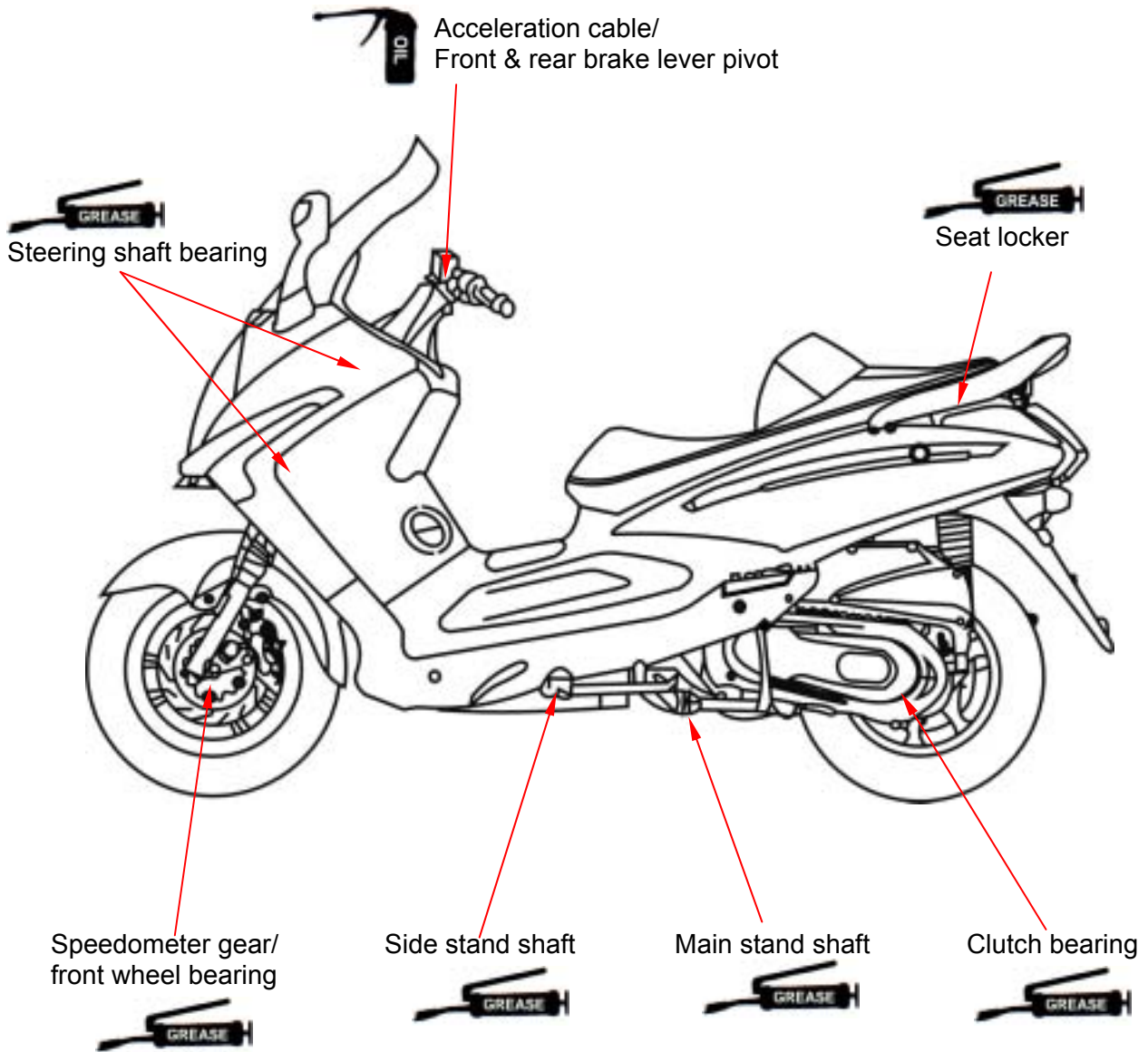

Precautions in Operation	2-1	Cylinder Compression Pressure	2-9
Periodical Maintenance Schedule	2-2	Drive Belt	2-9
Engine Oil	2-3	Steering Handle Top Bearing	2-10
Engine Oil Strainer Clean	2-3	Cushion	2-10
Gear Oil	2-4	Disk Brake System	2-11
Fuel Lines / Cable	2-4	Brake Light Switch/Starting Inhibitor Switch	2-13
Air Cleaner	2-5	Headlight Beam Distance	2-13
P.C.V. system	2-6	Wheel / Tire	2-13
Valve Clearance	2-6	Battery	2-14
Carburetor Idle Speed Adjustment	2-7	Nuts, Bolts Tightness	2-14
Ignition System	2-8	Special Tools List	2-15
Spark Plug	2-8		

Precautions in Operation

Model		LM25W
Fuel Tank Capacity		12,000 c.c.
Engine Oil	capacity	1,400 c.c.
	change	1,200 c.c.
Transmission Gear oil	capacity	180 c.c.
	change	170 c.c.
Capacity of coolant	Engine + radiator	850 c.c.
	Reservoir upper	420 c.c.
Clearance of throttle valve		2~6 mm
Spark plug		CR7HSA (gap:0.6~0.7 mm)
"F" Mark in idling speed		BTDC 10° / 2,500 rpm
Full timing advanced		BTDC 30° at 6,000 rpm
Idling speed		1,500±100 rpm
Cylinder compression pressure		12 ± 2 Kg/cm ²
Valve clearance	IN	0.1±0.02 mm
	EX	0.15±0.02 mm
Tire dimension	Front	110/90-13 56P
Tire dimension	Rear	130/70-13 57P
Tire pressure (cold)	single	Front: 1.5 Kg/cm ² Rear: 2.25 Kg/cm ²
	Load 90 Kg (full load)	Front: 1.5 Kg/cm ² Rear: 2.5 Kg/cm ²
Battery		12V10Ah (MF battery)

2. Maintenance Information

Periodical Maintenance Schedule

No	item	Every 300KM	1 Month every 1,000KM	3 month every 3,000KM	6 month every 6,000KM	1 year every 12,000KM
1	Air cleaner	I		C	C	R
2	2nd air jet leaner	I		C	C	R
3	Fuel filter	I			I	R
4	Oil filter	C			C	C
5	Engine oil change	R	Replacement for every 1,000 km			
6	Tire pressure	I	I	I	I	I
7	Battery inspection	I	I	I	I	I
8	Brake & free ply check	I	I	I	I	I
9	Steering handle check	I			I	I
10	Cushion operation check	I			I	I
11	Every screw tightening check	I	I	I	I	I
12	Gear oil check for leaking	I	I	I	I	I
13	Spark plug check or change	I		I	R	R
14	Gear oil change	R	Replacement for every 5,000 km			
15	Frame lubrication				L	L
16	Exhaust pipe	I	I	I	I	I
17	Ignition timing	I	I	I	I	I
18	emission check in Idling	A	I	I	I	I
19	Throttle operation	I		I	I	I
20	Engine bolt tightening	I		I	I	I
21	CVT driving device(belt)				I	R
22	CVT driving device(roller)				C	C
23	Lights/electrical equipment/multi-meters	I	I	I	I	I
24	Main/side stands & springs	I			I	I
25	Fuel lines	I		I	I	I
26	Shock absorbers			I	I	I
27	Cam chain	I		I	I	I
28	Valve clearance	I		A	A	A
29	Crankcase evaporative control system	I		C	C	C
30	Crankcase blow-by over-flow pipe		Replacement for every 2,000 km			
31	2nd air jet system	I		I	C	C
32	Evaporative control system			I	I	I
33	Lines & connections in cooling system	I	I	I	I	I
34	Coolant reservoir	I	I	I	I	I
35	Coolant	I	Replacement for every 1 year			

Code: I ~ Inspection, cleaning, and adjustment R ~ Replacement C ~ Cleaning (replaced if necessary) L ~ Lubrication
 Have your motorcycle checked, adjusted, and recorded maintenance data periodically by your SYM Authorized Dealer to maintain the motorcycle at the optimum condition

The above maintenance schedule is established by taking the monthly 1,000 kilometers as a reference which ever comes first.

Remarks: 1. **These marks “ A ” in the schedule are emission control items. According to EPA regulations, these items must be performed normally periodical maintenance following the use r manual instructions. They are prohibited to be adjusted or repaired by unauthorized people. Otherwise, SYM is no responsible for the charge.**

2. Clean or replace the air cleaner element more often when the motorcycle is operated on dusty roads or in the Heavily- polluted environment.
3. Maintenance should be performed more often if the motorcycle is frequently operated in high speed and after the motorcycle has accumulated a higher mileage.
4. Preventive maintenance
 - a. Ignition system - Perform maintenance and check when continuous abnormal ignition, misfire, after-burn, overheating occur.
 - b. Carbon deposit removal - Remove carbon deposits in cylinder head, piston heads, exhaust system when power is obvious lower. Than ever
 - c. Replace worn out pistons, cylinder head.

Engine Oil

Turn off engine, and park the motorcycle in flat surface with main stand.

Check oil level with oil dipstick

So not screw the dipstick into engine as checking.
If oil level is nearly low level, fill out recommended oil to upper level.

Oil Change

Caution

- Drain oil as engine warmed up so that make sure oil can be drained smoothly and completely.

Place an oil pan under the motorcycle, and remove oil drain bolt.
After drained, make sure washer can be re-used.
Install oil drain bolt.

Torque value: 3.5~4.5kgf-m

Add oil to crankcase (oil viscosity SAE 10W-30)
Recommended using King serial oil.

Engine oil capacity:

Disassembly 1400c.c.

Replacement 1200c.c.

Install dipstick, start the engine for running several minutes.

Turn off engine, and check oil level again.

Check if engine oil leaks.



Engine Oil Strainer Clean

Drain engine oil out.

Remove oil strainer and spring.

Clean oil strainer.

Check if O-ring can be re-used.

Install oil strainer and spring.

Install oil strainer cap.

Torque value : 1.3~1.7kgf-m

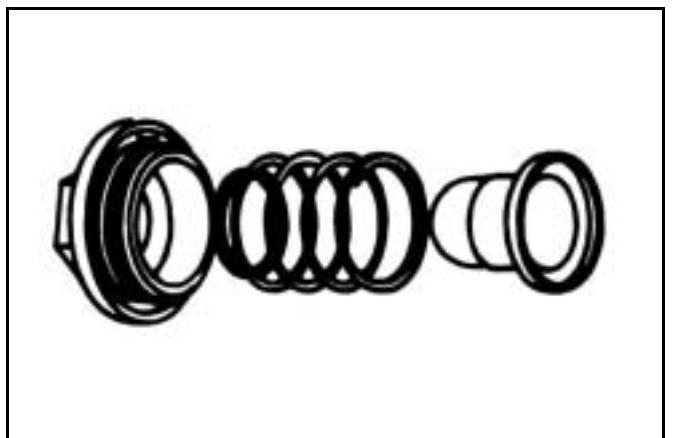

2. Maintenance Information

Gear Oil

Oil level inspection

Park the motorcycle on flat surface with main stand.

Turn off the engine.

Gear Oil Change

Remove oil inspection bolt.

Remove drain plug and drain oil out.

Install the drain plug after drained.

Torque value: 0.8~1.2kgf-m

Add gear oil to specified quantity from the inspection hole.

Install the inspection bolt.

Torque value: 1.0~1.4kgf-m

Gear Oil Quantity: 170 c.c. when replacing

Make sure that the bolt washer can be re-used, and install the bolt.

Start engine and run engine for 2-3 minutes.

Turn off engine and make sure that oil level is in correct level.

Make sure that no oil leaking.

Fuel Lines / Cable

Remove luggage box.

Remove rear carrier.

Remove body covers.

Check all lines, and replace it when they are deterioration, damage or leaking.

⚠ Warning

- Gasoline is a low ignition material so any kind of fire is strictly prohibited as dealing it.

Acceleration Operation

Have a wide open of throttle valve as handle bar in any position and release it to let back original (full closed) position.

Check handle bar if its operation is smooth.

Check acceleration cable and replace it if deteriorated, twisted or damaged.

Lubricate the cable if operation is not smooth

Measure handle bar free play in its flange part.

Free play: 2~6 mm.

Adjustment can be done in either end.

Secondary adjustment is conducted from top side.

Remove rubber boot, loosen fixing nut, and then adjust it by turning the adjustment nut.

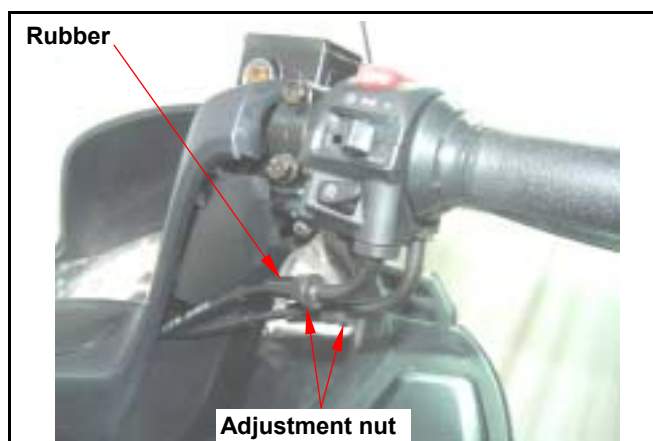
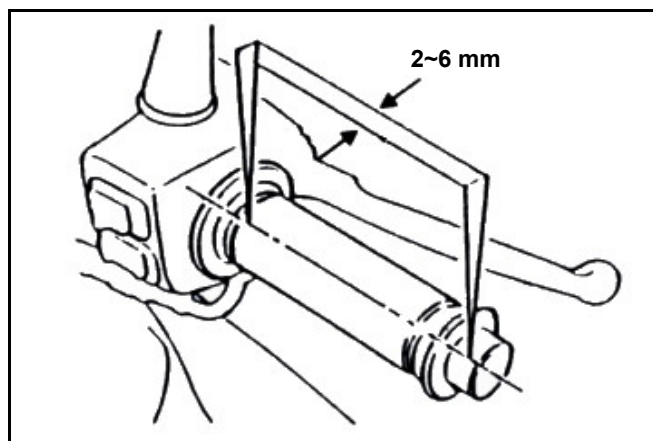

Primary adjustment is conducted from bottom side.

Loosen fixing nut, and adjust by turning the adjustment nut.

Tighten the fixing nut, and check acceleration operation condition.

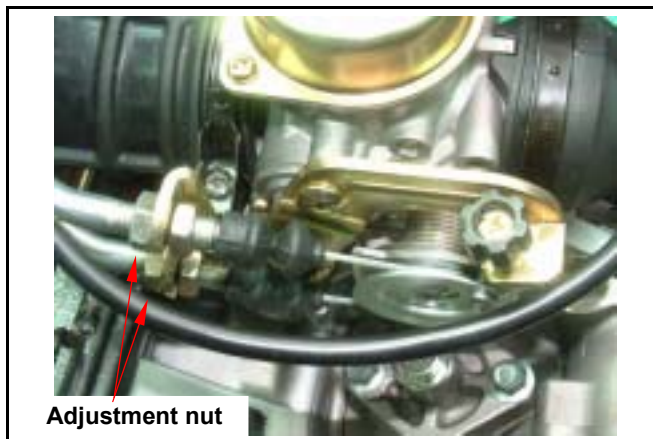

Air Cleaner

Air Cleaner Element

Remove 8 screws from the air cleaner cover and then remove the cover.

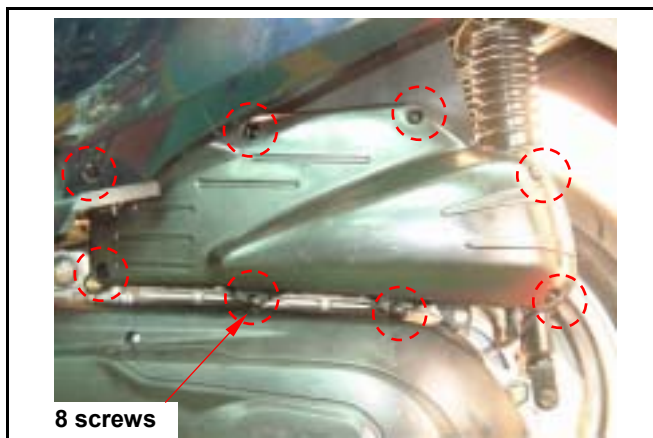

Remove the body cover.

Loosen bolt from the air cleaner air hose.



Remove 6 screws, and then remove the air cleaner element.

Caution

- The air cleaner element is made of paper so do not soap it into water or wash it with water.

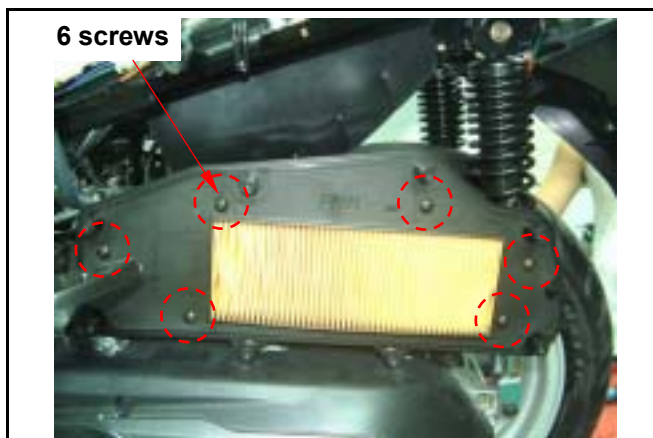

2. Maintenance Information

P.C.V. system

Draws out the plug from lower of the breather chamber hose.

Releases the dry internal deposit.

Every 2,000 kilometers release oil

Caution

A In releases the anal fistula in the transparent section as worthy of looking at as any deposit

- In the multi- rain or the accelerator in the situation rides, must reduce the maintenance traveling schedule
- In releases the anal fistula in the transparent section as worthy of looking at as any deposit

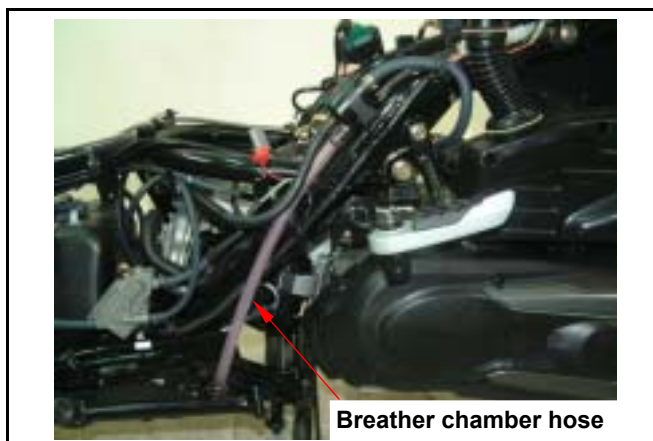

Valve Clearance

Caution

- Checks and adjustment must be performed when the engine temperature is below 35 .

Remove luggage box.

Remove cylinder head cover & side cover.

Remove ignition timing hole cap located in front upper side of engine right cover

Turn camshaft bolt in C.W. direction and let the "T" mark on the camshaft sprocket aligns with cylinder head mark so that piston is placed at TDC position in compression stroke.

Caution

- Do not turn the bolt in C.C.W. direction to prevent from camshaft bolt looseness.

Valve clearance inspection and adjustment:

Check & adjust valve clearance with feeler gauge.

Valve clearance (IN) : 0.1 ± 0.02 mm.

Valve clearance (EX) : 0.15 ± 0.02 mm.

Loosen fixing nut and turn the adjustment nut for adjustment.

Caution

- Re-check the valve clearance after tightened the fixing nut.

Special tool: Tappet adjuster

SYM-9001200-08

SYM-9001200-09

SYM-9001200-10

Special tool: Tappet adjuster wrench

SYM-9001200

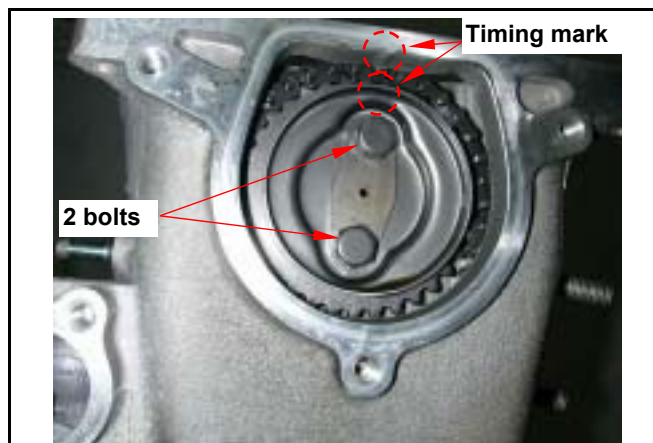

Carburetor Idle Speed Adjustment

⚠ Caution

- Inspection & adjustment for idle speed have to be performed after all parts in engine that needed adjustment have been adjusted.
- Idle speed check and adjustment have to be done after engine is being warm up. (It is enough that operates engine from stop to running for 10 minutes.)

Park the motorcycle with main stand and warm up engine.

Connect tachometer (the wire clamp of tachometer is connected to the high tension cable).

Open carburetor cover from the luggage box.

Turn the throttle valve stopper screw to specified idle speed

Specified idle speed: 1500±100 rpm.

Emission adjustment in idle speed

Warm up the engine for around 10 minutes and then conduct this adjustment.

Connect the tachometer onto engine.

Adjust the throttle valve stopper screw and let engine runs in 1500±100 rpm.

Insert the exhaust sampling pipe of exhaust analyzer into the front section of exhaust pipe.

Adjust the air adjustment screw so that emission value in idle speed is within standard.

Slightly accelerate the throttle valve and release it immediately. Repeat this for 2~3 times.

Read engine RPM and value on the exhaust analyzer. Repeat step 2 to step 4 procedures until measured value within standard.

Emission standard CO: 3.0 %↓

HC: 2,000 P.P.M.↓

Ignition coil cable



Throttle valve stopper screw



Mixture air adjusting screw

2. Maintenance Information

Ignition System

⚠ Caution

- C.D.I ignition system is set by manufacturer so it can not be adjusted.
- Ignition timing check procedure is for checking whether CDI function is in normal or not.

Remove right side cover.

Remove ignition timing hole cap located in front upper side of engine right cover.

Connect tachometer and ignition lamp.

Start engine.

As engine in idle speed: 2,500 rpm, aim at the "F" mark with the ignition lamp. Then, it is means that ignition timing is correct.

Increase engine speed to 6,000 rpm to check ignition advance degree. If indent is located within the ignition advance degrees, it is means that the ignition advance degree is in normal.

If ignition timing is incorrect, check CDI set, pulse rotor and pulse generator. Replace it if malfunction of these parts is found.

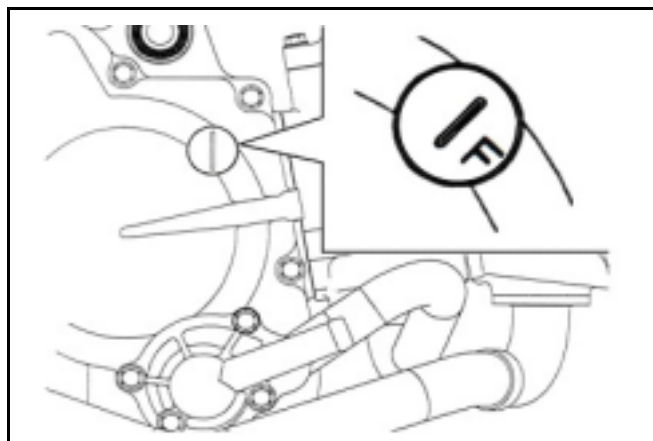

Spark Plug

Recommended spark plug: CR8E

Remove luggage box

Remove central cover.

Remove spark plug cap.

Clean dirt around the spark plug hole.

Remove spark plug.

Measure spark plug gap.

Spark plug gap: 0.6~0.7 mm

Carefully bend ground electrode of the plug to adjust the gap if necessary.

Hold spark plug washer and install the spark plug by screwing it.

Tighten the plug by turning 1/2 turn more with plug socket after installed.

Tighten torque: 1.0~1.2kgf-m

Connect spark plug cap

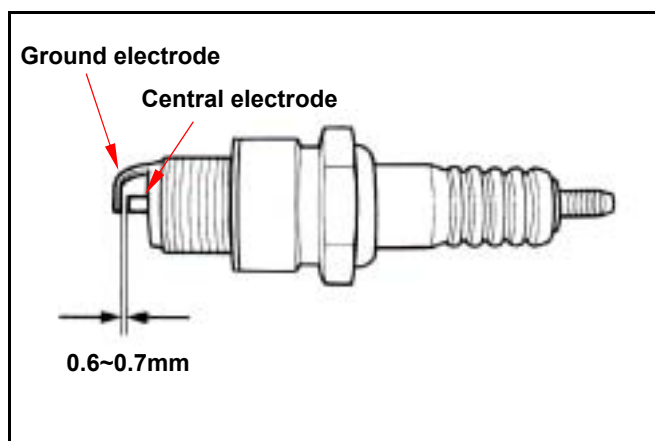

Cylinder Compression Pressure

Warm up engine.

Turn off the engine.

Remove luggage box and central cover

Remove spark plug cap and spark plug.

Install compression gauge.

Full open the throttle valve, and rotate the engine by means of starter motor.

Caution

Rotate the engine until the reading in the gauge no more increasing.

- Usually, the highest pressure reading will be obtained in 4~7 seconds.

Compression pressure : $12 \pm 2 \text{ Kg/cm}^2$

Check following items if the pressure is too low:

- Incorrect valve clearance.
- Valve leaking.
- Cylinder head leaking, piston, piston ring and cylinder worn out.

If the pressure is too high, it means carbon deposits in combustion chamber or piston head.

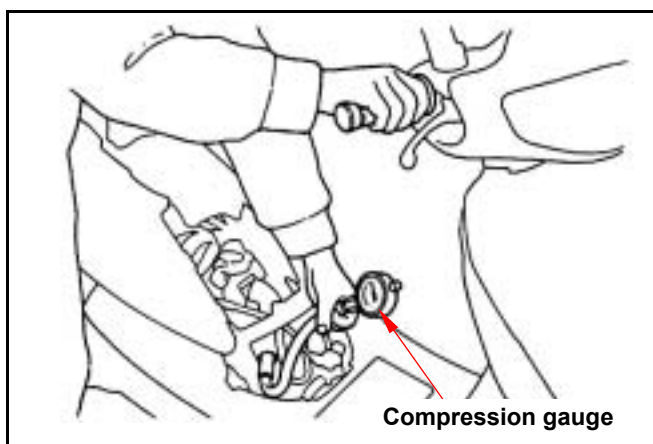
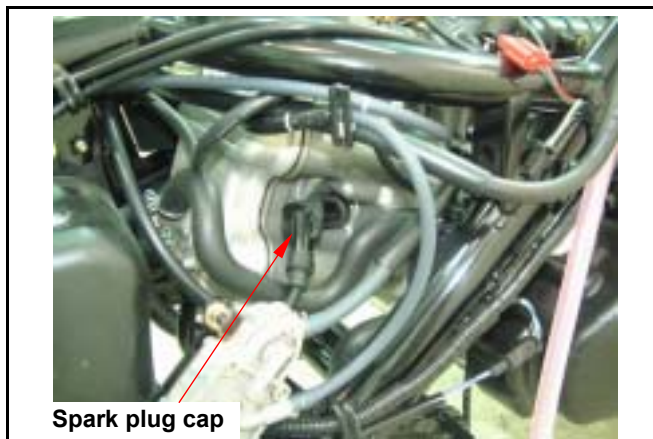

Drive Belt

Remove mounting bolt located under air cleaner.

Remove the engine left side cover and the cover.

Check if the belt is crack or worn out.

Replace the belt if necessary or in accord with the periodical maintenance schedule to replace it.

Width limit: 22.5 mm or above

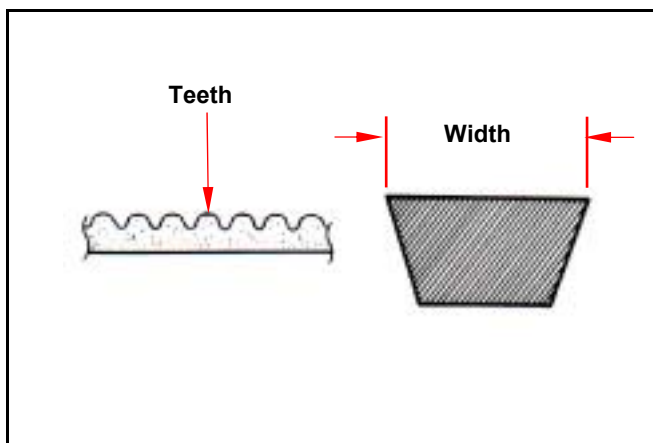

Clutch Disc Wear

Run the motorcycle and increase throttle valve opening gradually to check clutch operation.

If the motorcycle is in forward moving and shaking, check clutch disc condition. Replace it

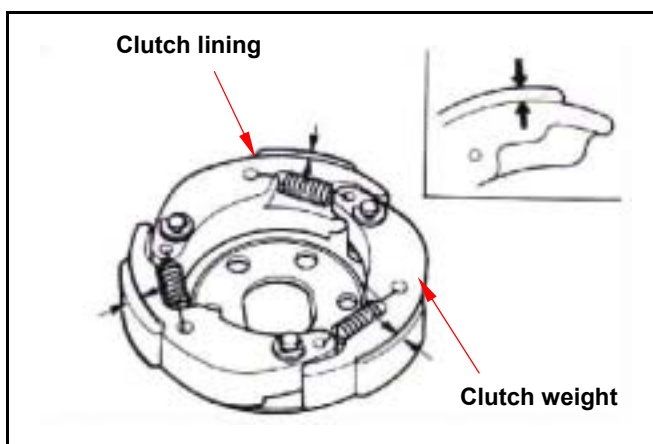

2. Maintenance Information

Steering Handle Top Bearing

Caution

- Check all wires and cables if they are interfered with the rotation of steering handle bar.

Lift the front wheel out of ground.
Turn handle from right to left alternative and check if turning is smoothly.
If handle turning is uneven and bending, or the handle can be operated in vertical direction, then adjust the handle top bearing.

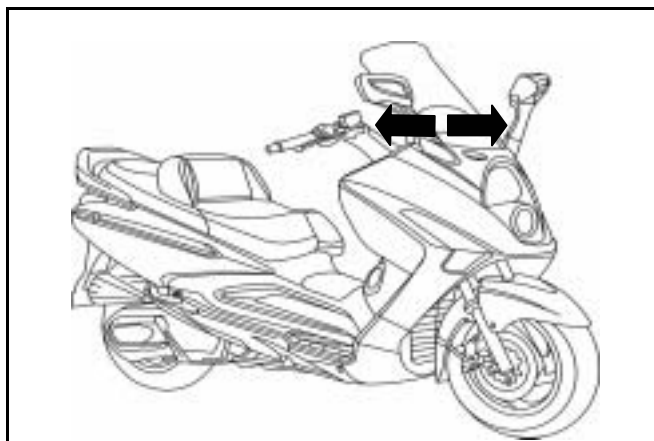

Cushion

Caution

- Do not ride the motorcycle with poor cushion.
- Looseness, wear or damage cushion will make poor stability and drive-ability.

Front cushion

Press down the front cushion for several times to check it operation.
Check if it is damage
Replace relative parts if damage found.
Tighten all nuts and bolts.

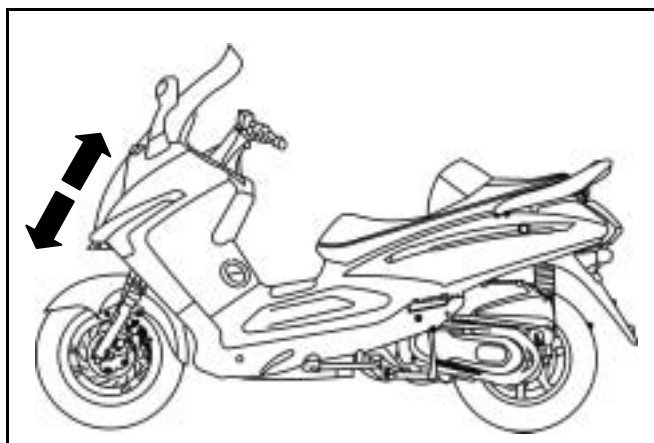

Rear Cushion

Press down the front cushion for several times to check it operation.
Check if it is damage
Replace relative parts if damage found.
Park motorcycle with main stand.
Turn the rear wheel forcefully and check if engine bracket bushing worn out
Replace the bushing if looseness found.
Tighten all nuts and bolts.

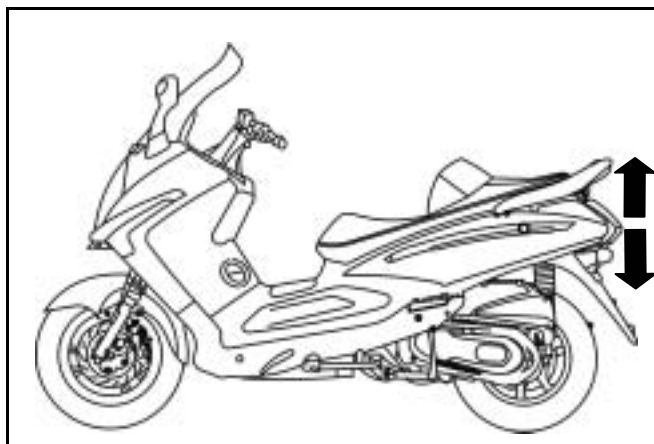



Disk Brake System

Brake System Hose

Make sure the brake hoses for corrosion or leaking oil.

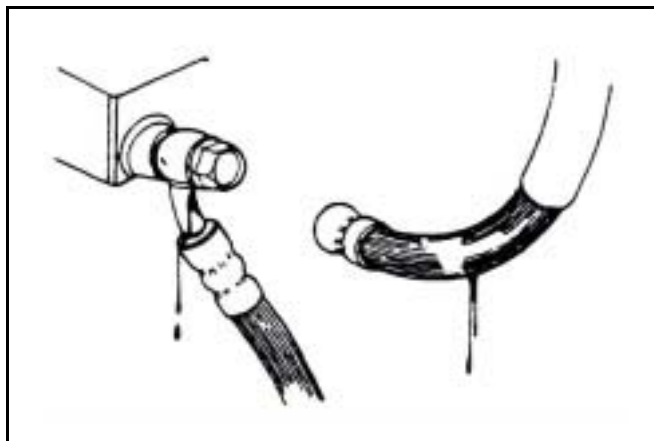

Brake Fluid

Check brake fluid level in the brake fluid reservoir. If the level is lower than the **LOWER** limit, add brake fluid to **UPPER** limit. Also check brake system for leaking if low brake level found

⚠ Caution

- In order to maintain brake fluid in the reservoir in horizontal position, do not remove the cap until handle stop.
- Do not operate the brake lever after the cap had been removed. Otherwise, the brake fluid will spread out if operated the lever.
- Do not mix non-compatible brake fluid together.

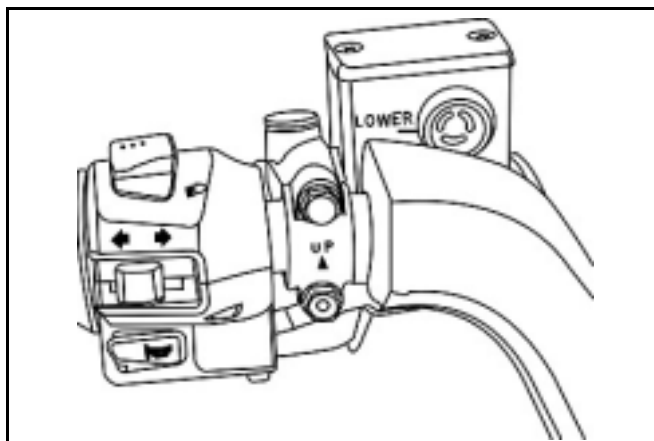

Filling Out Brake Fluid

Tighten the drain valve, and add brake fluid. Operate the brake lever so that brake fluid contents inside the brake system hoses.

Added Brake Fluid

Add brake fluid to **UPPER** limit lever. Recommended brake fluid: DOT3 or DOT4 WELL RUN brake fluid.

⚠ Caution

Never mix or use dirty brake fluid to prevent from damage brake system or reducing brake performance.

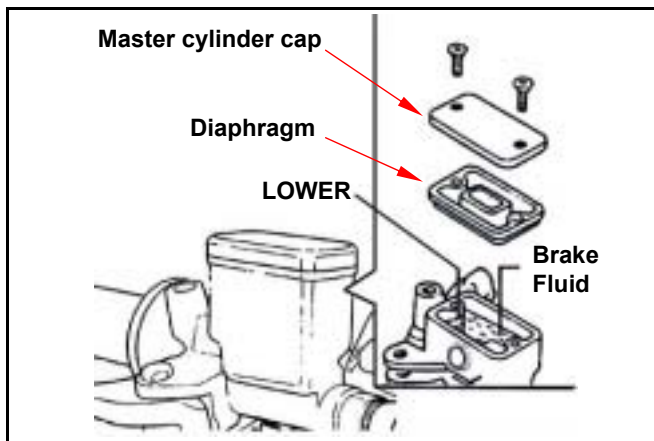

Air Bleed Operation

Connect a transparent hose to draining valve. Hold the brake lever and open air bleeding valve. Perform this operation alternative until there is no air inside the brake system hoses.

⚠ Caution

Before closing the air bleed valve, do not release the brake lever.

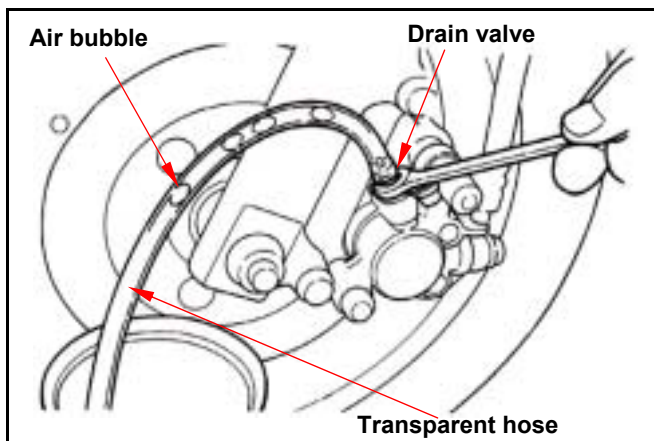

2. Maintenance Information

Brake Lining Wear

The indent mark on brake lining is the wear limitation.

Replace the brake lining if the wear limit mark closed to the edge of brake disc.

Caution

It is not necessary to remove brake hose when replacing the brake lining.

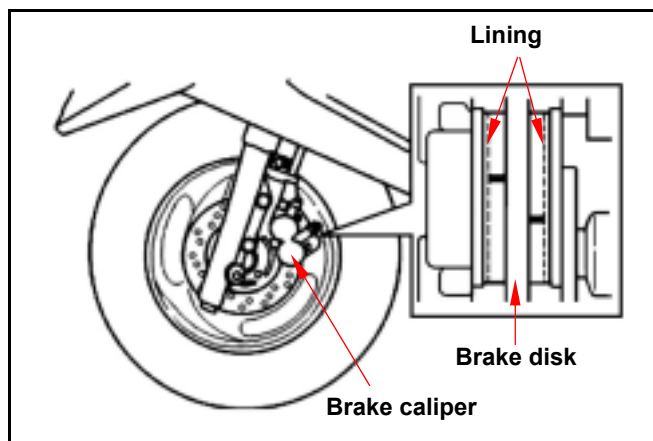

Remove the brake clipper bolt, and take out the clipper.

Caution

Do not operate the brake lever after the clipper removed to avoid clipping the brake lining.

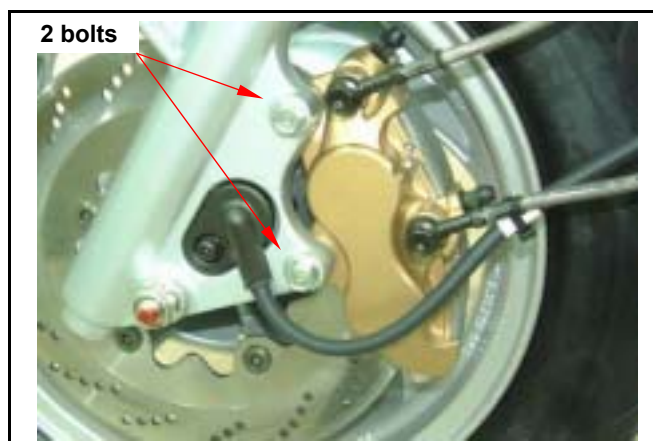

Pry out the brake lining with a flat driver if lining is clipped.

Remove 2 cotter pins

Caution

- In order to maintain brake power balance, the brake lining must be replaced with one set.

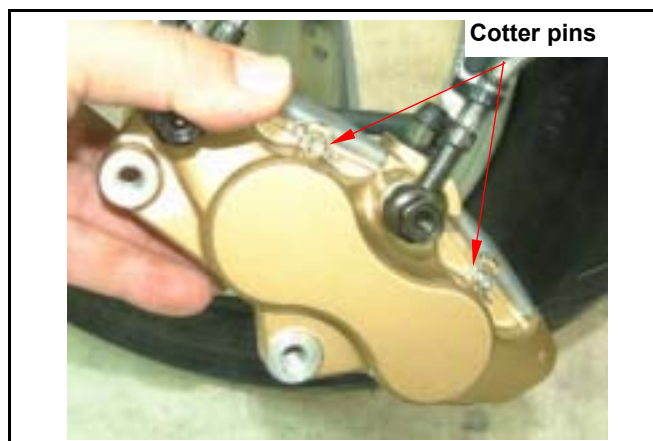

Remove the brake pad shafts and pads.



Brake Light Switch/Starting Inhibitor Switch

The brake lamp switch is to light up brake lamp as brake applied.

Make sure that electrical starter can be operated only under brake applying.

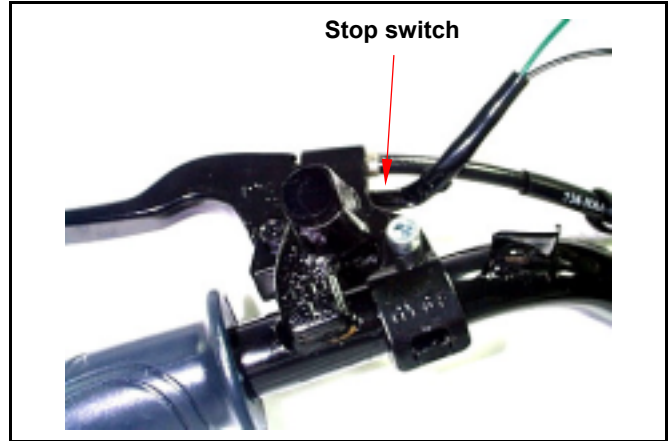

Headlight Beam Distance

Turn on main switch

Headlight beam adjustment. Turn the headlight adjustment screw to adjust headlight beam high.

⚠ Caution

- To adjust the headlight beam follows related regulations.
- Improper headlight beam adjustment will make in coming driver dazzled or insufficient lighting.

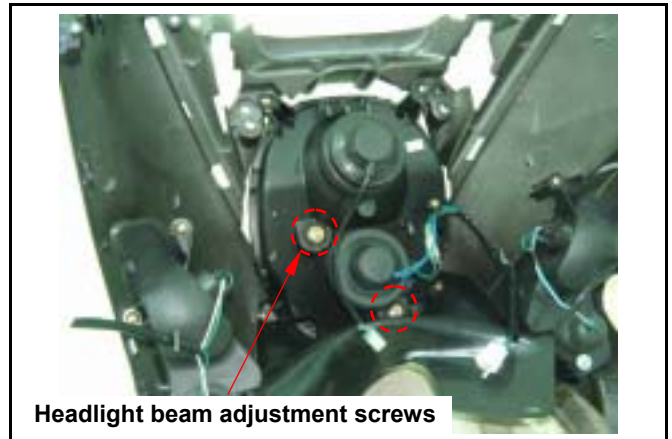

Wheel / Tire

⚠ Caution

- Tire pressure check should be done as cold engine.

Appointed tire pressure

Tire size		Front tire	Rear tire
Tire pressure as cold engine (Kg/cm ²)	Load for under 90 Kg	1.75	2.25
	Full loaded	1.75	2.50

Check if tire surface is ticked with nails, stones or other materials.

Check if front and rear tires' pressure is in normal. Measure tire thread depth from tire central surface.

Replace the tire if the depth is not come with following specification

Front tire : 1.5 mm

Rear tire : 2.0 mm

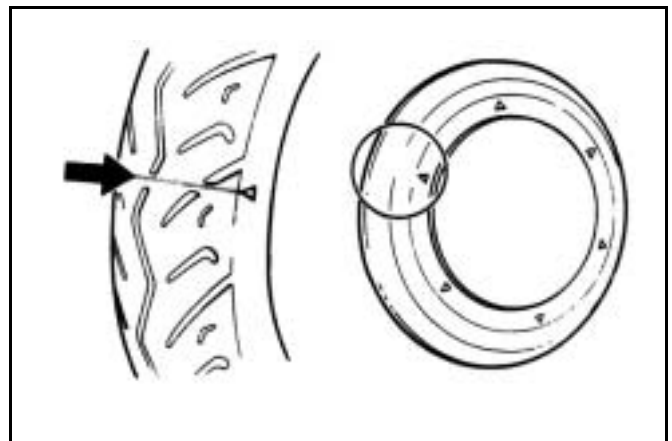
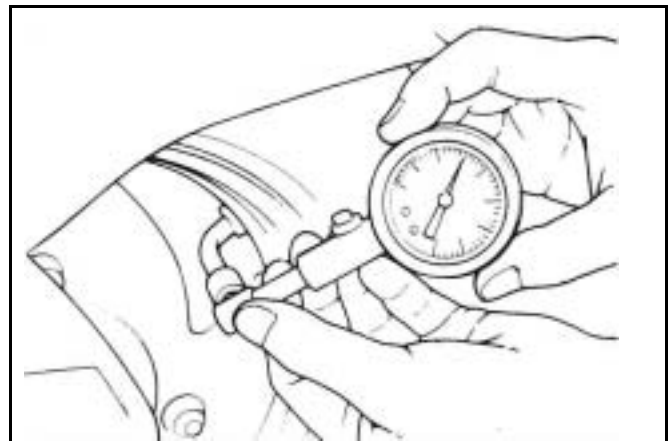

2. Maintenance Information

Battery

Open the inner box lid.

Loosen screw & remove the battery cover

Battery cable remove :

1. Disconnect the cable negative terminal (-),
2. then the cable positive terminal (+)
3. Remove the battery from the motorcycle..

If there is some rust on battery posts, clean it with steel brush

Install the battery in the reverse procedures of removal

Caution

- If there is rust on the posts very serious, spray some hot water on the posts. Then, clean it with steel brush so that can remove rust for more easily.
- Apply some grease on the posts after rust removed to prevent from rust again.

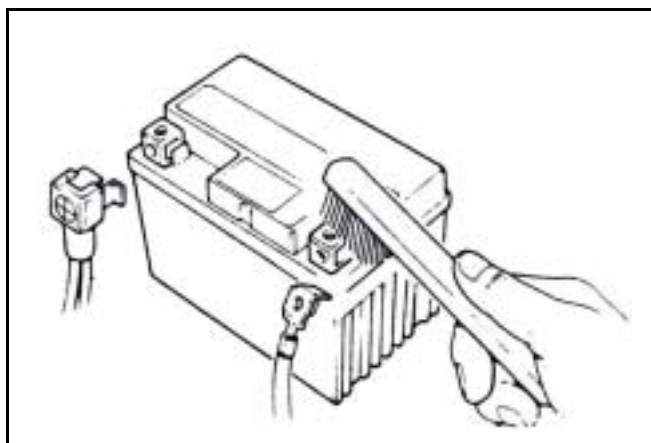

Nuts, Bolts Tightness

Perform periodical maintenance in accord with the Periodical Maintenance Schedule.

Check if all bolts and nuts on the frame are tightened securely.

Check all fixing pins, snap rings, hose (pipe) clamps, and wire holders for security.

Special Tools List

					
NAME	Left crank bearing puller	NAME	R/L. crank case disassemble tool	NAME	Valve cotter remove & assembly tool
NO	SYM-9100100	NO	SYM-1120000-HMA H9A	NO	SYM-1471110/20
					
NAME	L. Crank shaft puller	NAME	Tappet adjusting wrench	NAME	Tappet adjusting
NO	SYM-1130000-HMA H9A	NO	SYM-9001200	NO	SYM-9001200-08 09 10
					
NAME	R. crank case bearing 6201 assembles tool	NAME	Left crankshaft & oil seal assembly socket.	NAME	Rocker arm shaft disassemble
NO	SYM-9614000-HMA 6201	NO	SYM-2341110- HMA RB1	NO	SYM-1445100
					
NAME	Bearing driver 6204	NAME	Assembly directs puller	NAME	Drive shaft puller
NO	SYM-9110400	NO	SYM-2341110	NO	SYM-2341110- HMA RB1

2. Maintenance Information



					
NAME	Inner bearing puller	NAME	Outer bearing puller	NAME	Handle stand nut wrench
NO	SYM-6204022	NO	SYM-6204001	NO	SYM-5321100
					
NAME	Clutch nut wrench	NAME	Universal holder	NAME	AC.G. Flywheel puller
NO	SYM-9020200	NO	SYM-2210100	NO	SYM-3110000-HMA
					
NAME	Steering head top thread wrench	NAME	Bearing driver HK1516	NAME	Bearing puller 6205
NO	SYM-5320010	NO	SYM-9100200-HMA RB1 HK1516	NO	SYM-9100400 HMA RAI 6205
					
NAME	Air operated bearing puller	NAME	Oil seal driver 34*52*5	NAME	Right crankcase cover bearing 6201 puller.
NO	SYM-9100410-400 A6205	NO	SYM-9125500-HMA	NO	SYM-9614000-HMA RB1 6201

					
NAME	Bearing driver 6205	NAME	Drive shaft & oil seal (25*40*8) socket	NAME	Bearing puller 6303
NO	SYM-9615000-6205	NO	SYM-9120200-HMA	NO	SYM-6303000-HMA H9A 6303
					
NAME	Bearing driver 6201	NAME	Steering stem top thread wrench	NAME	
NO	SYM-9614000-6201	NO	SYM-5320010	NO	

2. Maintenance Information

Note:

Mechanism Diagram 3-1	Engine Oil Strainer Clean 3-3
Precautions in Operation 3-2	Oil Pump 3-4
Troubleshooting 3-2	Gear Oil 3-7
Engine Oil 3-3	

Mechanism Diagram

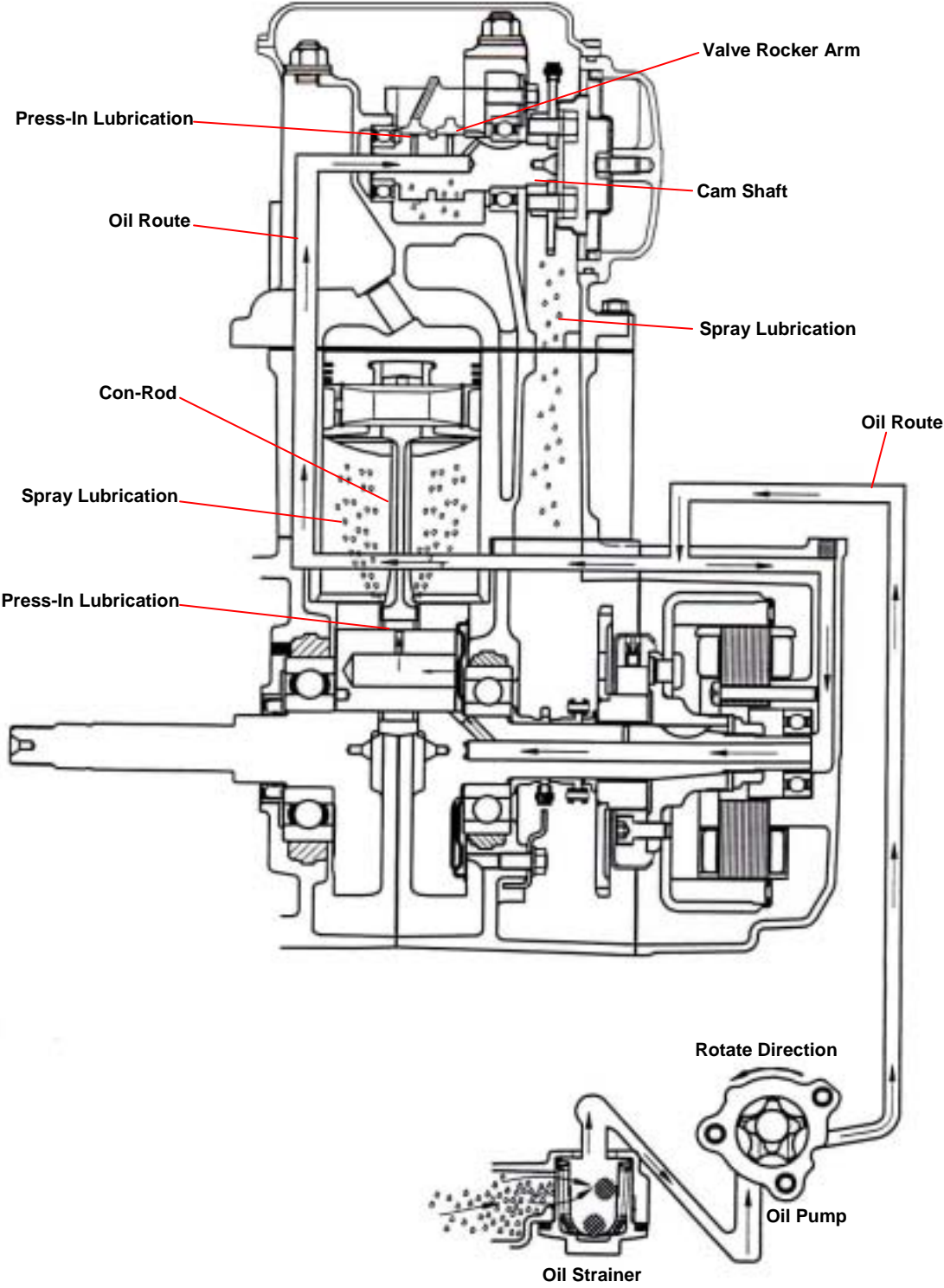

3. Lubrication System

Precautions in Operation

General Information:

- This chapter contains maintenance operation for the engine oil pump and gear oil replacement.

Specifications

Engine oil quantity Disassembly: 1400 c.c.

Change: 1200c.c.

Oil viscosity SAE 10W-30 (Recommended King serial oils)

Gear oil Disassembly: 180c.c.

Change: 170c.c.

Gear oil viscosity SAE 140

(Recommended SYM Hypoid gear oils)

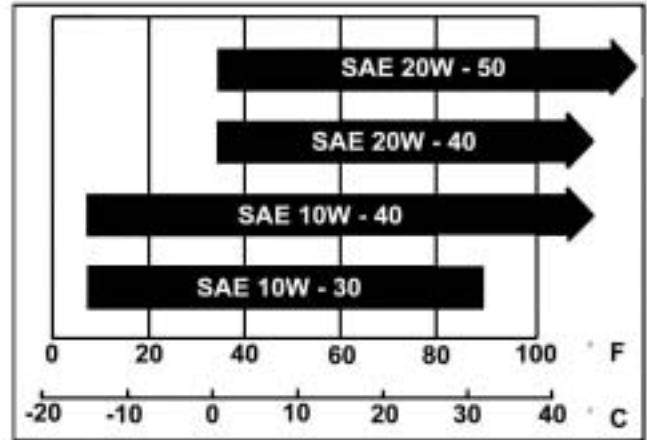

Unit:

mm

Items		Standard (mm)	Limit (mm)
Oil pump	Inner rotor clearance	0.15	0.20
	Clearance between outer rotor and body	0.15~0.20	0.25
	Clearance between rotor side and body	0.04~0.09	0.12

Torque value

Torque value oil strainer cap	1.3~1.7kgf-m
Engine oil drain bolt	3.5~4.5kgf-m
Gear oil drain bolt	1.1~1.5kgf-m
Gear oil join bolt	1.0~1.4kgf-m
Oil pump connection screw	0.1~0.3kgf-m

Troubleshooting

Low engine oil level

- Oil leaking
- Valve guide or seat worn out
- Piston ring worn out

Low oil pressure

- Low engine oil level
- Clogged in oil strainer, circuits or pipes
- Oil pump damage

Dirty oil

- No oil change in periodical
- Cylinder head gasket damage
- Piston ring worn out

Engine Oil

Turn off engine, and park the ATV in flat surface with main stand.

Check oil level with oil dipstick.

So not screw the dipstick into engine as checking.

If oil level is nearly low level, fill out recommended oil to upper level.

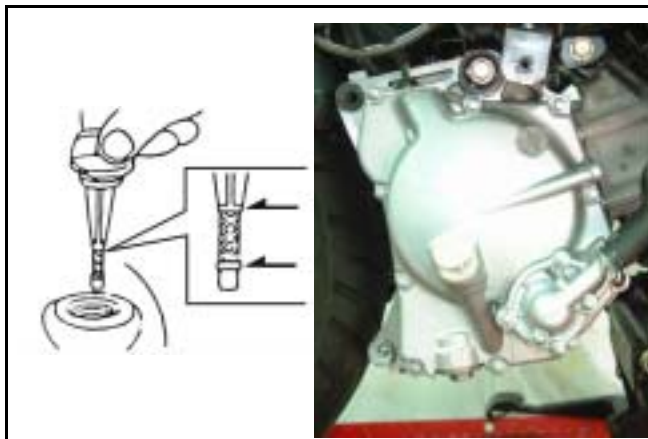

Oil Change

Caution

Drain oil as engine warmed up so that makes sure oil can be drained smoothly and completely.

Place an oil pan under the ATV, and remove oil drain bolt.

After drained, make sure washer can be re-used.

Install oil drain bolt.

Torque value : 3.5~4.5kgf-m

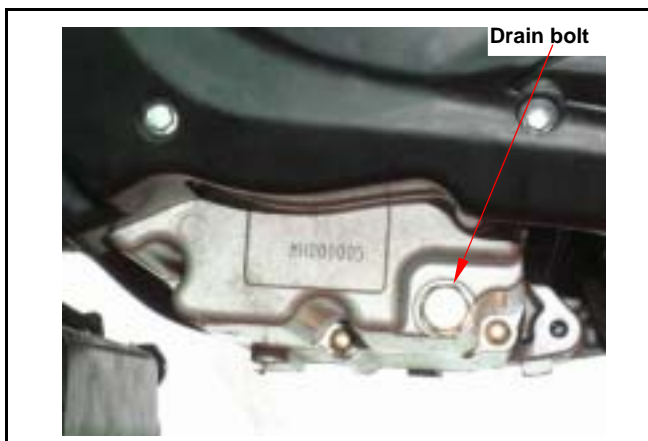

Engine Oil Strainer Clean

Drain engine oil out.

Remove oil strainer and spring.

Clean oil strainer.

Check if O-ring can be re-used.

Install oil strainer and spring.

Install oil strainer cap.

Torque value : 1.3~1.7kgf-m

Add oil to crankcase (oil viscosity SAE 10W-30)

Recommended using King serial oil.

Engine oil capacity: 1200c.c. when replacing

Install dipstick, start the engine for running several minutes.

Turn off engine, and check oil level again.

Check if engine oil leaks.

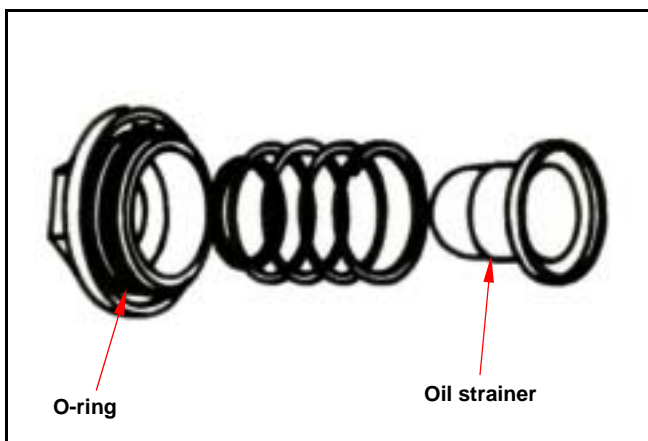

3. Lubrication System

Oil Pump

Oil Pump Removal

Remove generator and starting gear. (Refer to chapter 10) .



Remove cir clip and take out oil pump driving chain and sprocket.



Make sure that pump shaft can be rotated freely. Remove 2 screws on the oil pump, and then remove oil pump.

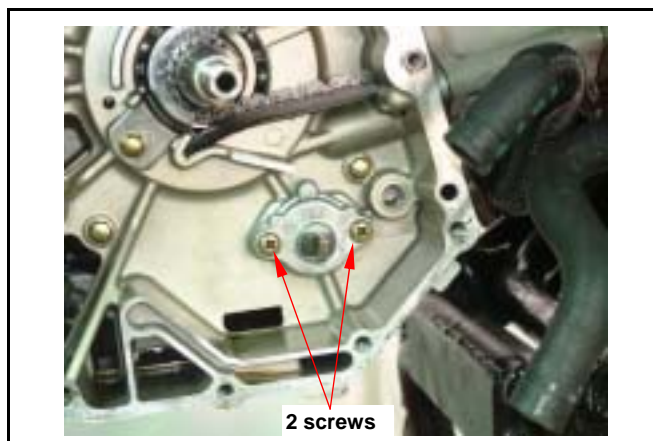

Oil Pump Disassembly

Remove the screws on oil pump cover and remove the cover.

Remove oil pump shaft roller and shaft.

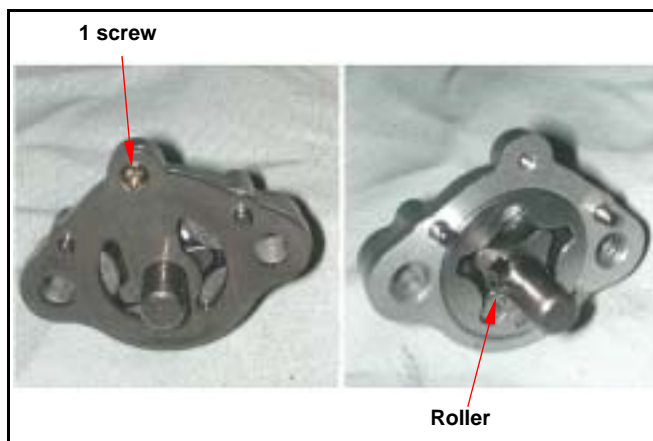

Oil Pump Inspection

Check the clearance between oil pump body and outer rotor.

Limit: 0.25 mm



Check clearance between inner and outer rotors.

Limit: 0.20 mm

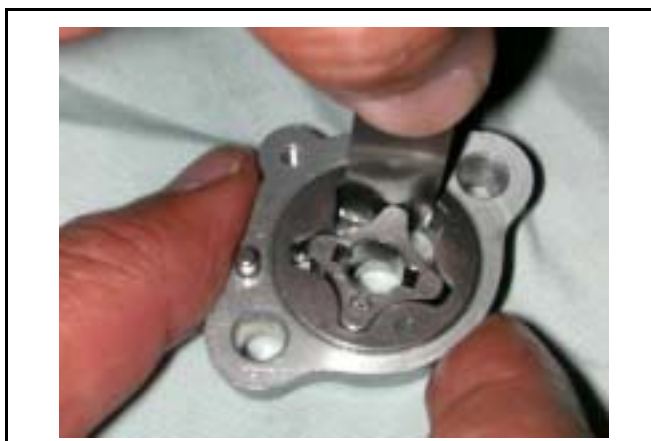

Check clearance between rotor side face and pump body

Limit: 0.12 mm



Oil Pump Re-assembly

Install inner and outer rotors into the pump body.
Align the indent on driving shaft with that of inner rotor.

Install the oil pump shaft and roller.

Install the oil pump cover and fixing pins properly.

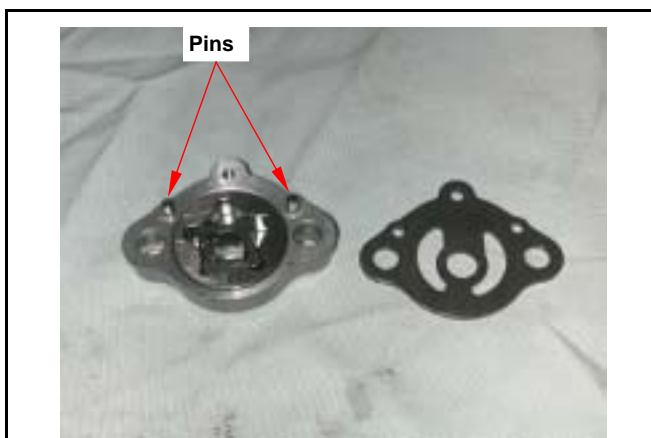

3. Lubrication System

Tighten the oil pump screw.

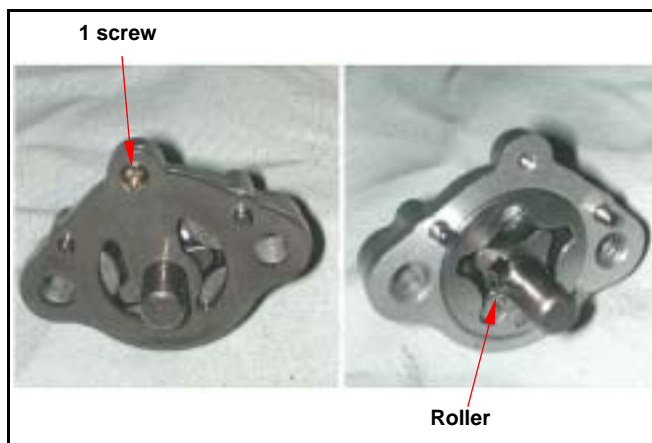

Oil Pump Installation

Install the oil pump, and then tighten screws.

Torque value : 0.1~0.3kgf-m

Make sure that oil pump shaft can be rotated freely.

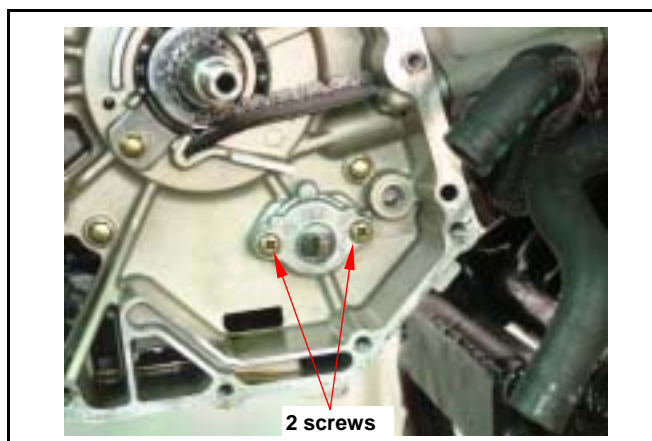

Install oil pump drive chain and sprocket, and then install cir clip onto oil pump shaft.

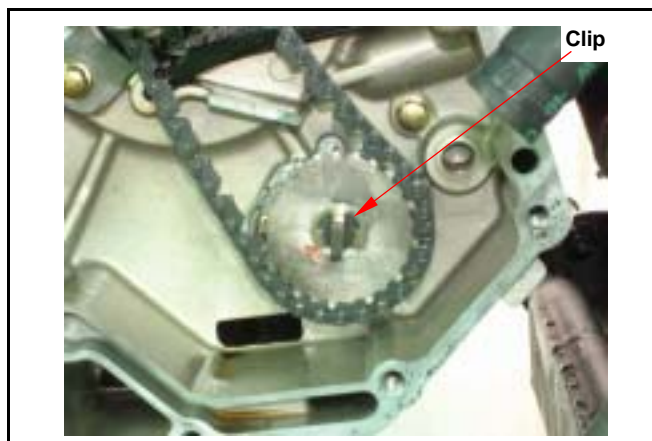

Install starting gear and generator.
(Refer to chapter 10)



Gear Oil**Gear Oil Change**

Remove oil join bolt.

Remove drain bolt and drain gear oil out.

Install the drain bolt after drained.

Torque value: 1.1~1.5kgf-m

Make sure that the drain bolt washer can be re-used.

Add oil to specified quantity from the join hole.

Gear Oil Quantity: 170c.c. when replacing

Make sure that the join bolt washer can be re-used, and install the bolt.

Torque value: 1.0~1.4kgf-m

Start engine and run engine for 2-3 minutes.

Turn off engine and make sure that oil level is in correct level.

Make sure that no oil leaking.

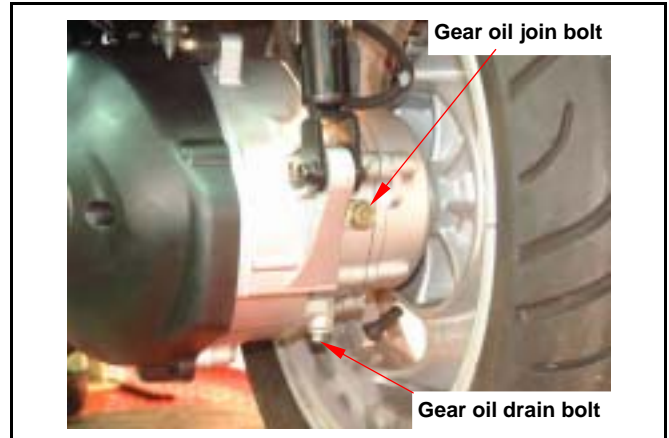

3. Lubrication System



Notes:

Mechanism Diagram	4-1	Automatic by-starter	4-7
Precautions in Operation.....	4-2	Float Chamber	4-8
Trouble Diagnosis.....	4-3	Adjustment of Idle Speed	4-10
Carburetor Remove / Install	4-4	Fuel Tank.....	4-11
Vacuum Chamber.....	4-4	Fuel Pump	4-13
Air Cut-off Valve	4-6	Air Cleaner.....	4-14

Mechanism Diagram

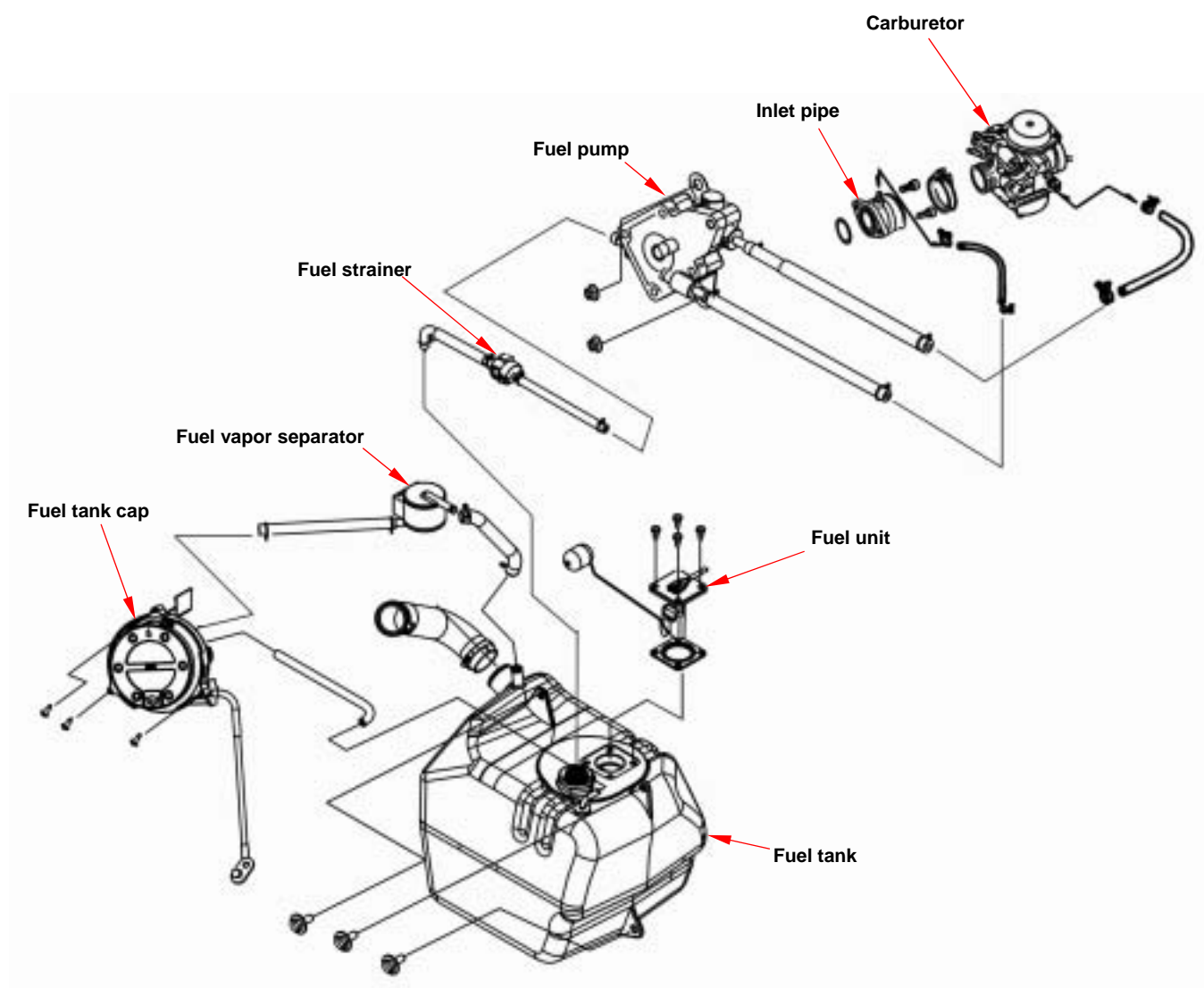

4. Fuel System

Precautions in Operation

General Information

Warning

Gasoline is a low ignition point and explosive materials, so always work in a well-ventilated place and strictly prohibit flame when working with gasoline.

Cautions

- Do not bend off throttle cable. Damaged throttle cable will make unstable drive-ability.
- When disassembling fuel system parts, pay attention to O-ring position, replace with new one as re-assembly
- There is a drain screw in the float chamber for draining residual gasoline.
- Do not disassemble air cut valve arbitrarily.

Specification

ITEM	LM25W
Carburetor diameter	Ø28.8 mm
I.D. number	CVK122B
Fuel level	18.5 mm
Main injector	# 122
Idle injector	# 38
Idle speed	1500±100 rpm
Throttle handle clearance	2~6 mm
Pilot screw	2±1/2 turns

Tool

Special service tools

Vacuum/air pressure pump

Fuel level gauge

Trouble Diagnosis

Poor engine start

- No fuel in fuel tank
- Clogged fuel tube
- Too much fuel in cylinder
- No spark from spark plug(malfunction of ignition system)
- Clogged air cleaner
- Malfunction of carburetor chock
- Malfunction of throttle operation

Stall after started

- Malfunction of carburetor chock
- Incorrect ignition timing
- Malfunction of carburetor
- Dirty engine oil
- Air existing in intake system
- Incorrect idle speed

Rough idle

- Malfunction of ignition system
- Incorrect idle speed
- Malfunction of carburetor
- Dirty fuel

Intermittently misfire as acceleration

- Malfunction of ignition system

Late ignition timing

- Malfunction of ignition system
- Malfunction of carburetor

Power insufficiency and fuel consuming

- Fuel system clogged
- Malfunction of ignition system

Mixture too lean

- Clogged fuel injector
- Vacuum piston stick and closed
- Malfunction of float valve
- Fuel level too low in float chamber
- Clogged fuel tank cap vent
- Clogged fuel filter
- Obstructed fuel pipe
- Clogged air vent hose
- Air existing in intake system

Mixture too rich

- Clogged air injector
- Malfunction of float valve
- Fuel level too high in float chamber
- Malfunction of carburetor chock
- Dirty air cleaner

4. Fuel System

Carburetor Remove / Install

Removal

Remove luggage box.
Drain out fuel in the float chamber.



Disconnect the fuel hose, vacuum hose.
Disconnect the auto by-start coupler.
Loosen the adjustment nut and fixing nut of throttle valve cable, and release the cable from carburetor.
Release the clamp strip of carburetor, and then remove the carburetor.

Installation

Install in reverse order of removal procedures.

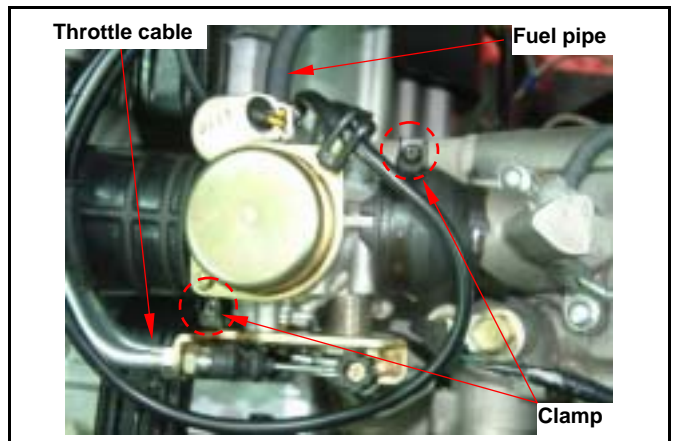

Vacuum Chamber

Removal

Loosen drain screw, and drain out residual fuel in float chamber.
Remove screws (2 screws) of vacuum chamber cover and the cover.

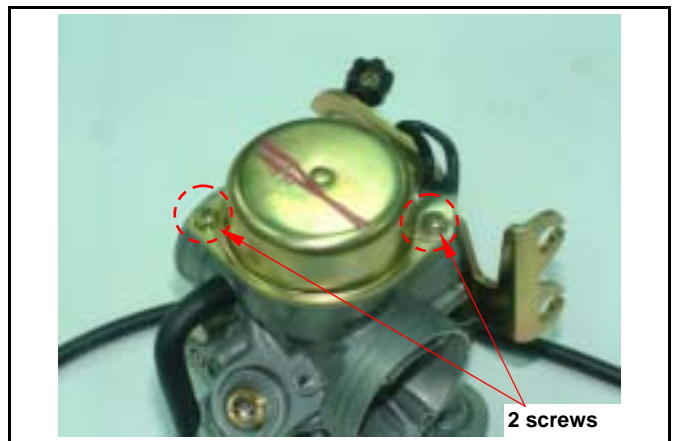

Remove compress spring and vacuum piston.

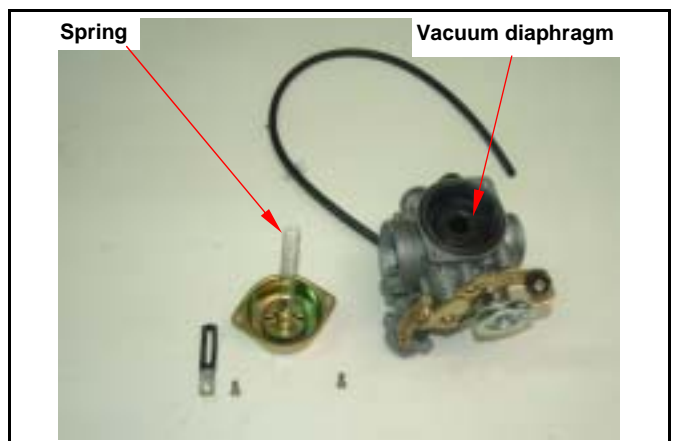

Remove fuel needle seat, spring, and injector needle.

Inspection

Check if the vacuum piston and needle for wear out, crack or other damage.
Check if the diaphragm for damage or crack.

⚠ Caution

- Do not damage vacuum diaphragm.

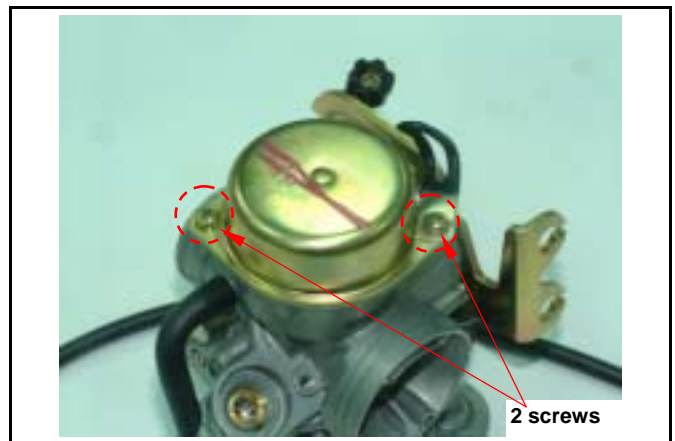
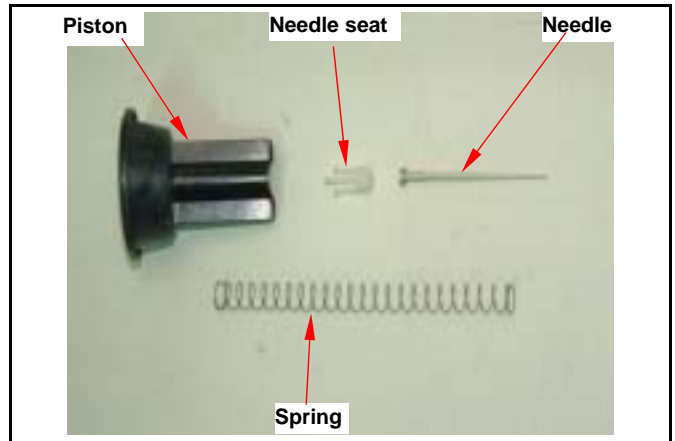

4. Fuel System

Air Cut-off Valve

Removal

Remove the throttle cable seat (2 screws)

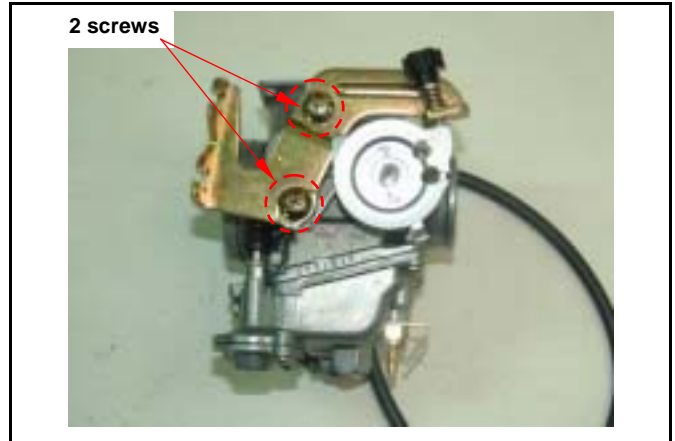

Remove the screws (2 screws) of the air cut-off valve and its cover.

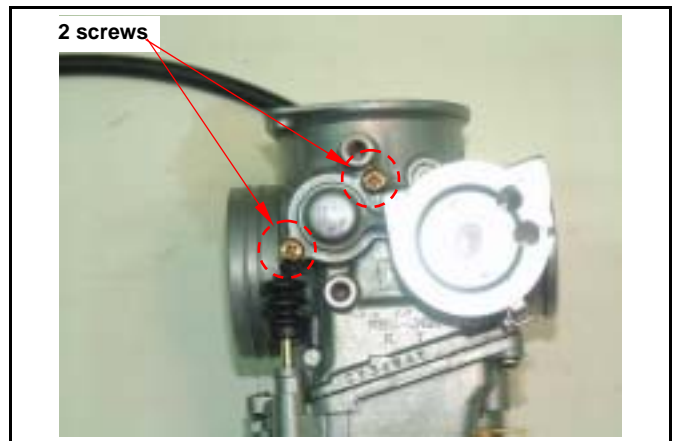

Remove the spring and vacuum diaphragm.
Check if the diaphragm for deterioration or crack.



Installation

Install the valve as reverse order of removal.

Caution

- Do not damage the vacuum diaphragm or in opposite installation direction.

Automatic by-starter

Inspection

Turn off engine and waiting for over 10 minutes for cooling.

Check resistance across the two terminals of the automatic by-starter.

Resistance value: Max. 10 (Measured after engine stopped for more than 10 minutes)

Replace the automatic by-starter with a new one if resistance value exceeds standard.

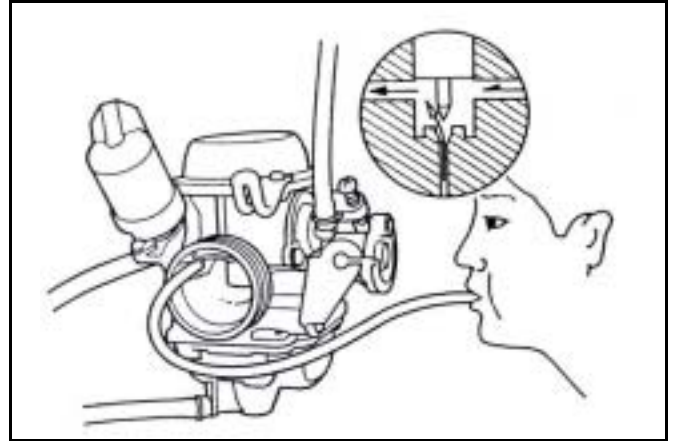

Remove the carburetor, allow it to cool off for 30 minutes.

Connect a pressure tester from air pump.

Connect fuel rich circuit.

Pump compressed air to the circuit.

Replace the automatic by-starter if the circuit clogged.

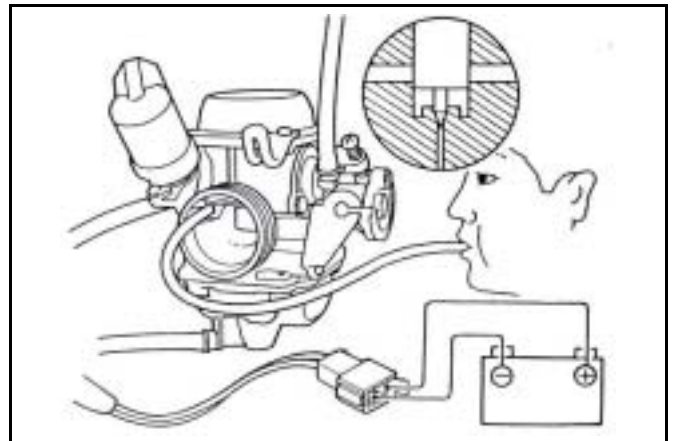

Connect battery posts (12V) to starter's connectors. After 5 minutes, test the rich circuit with compressed air.

If air flow through the circuit, then replace the by-starter.

Removal

Remove fixing plate screw, and then remove the plate and automatic by-starter from carburetor.



Valve inspection

Check if automatic by-starter and valve needle for damage or wear out.

Installation

Install automatic by-starter to the carburetor body. Install fixing plate to the upper groove of automatic by-starter, and install its flat surface to carburetor. Install screw and tighten it.

⚠ Caution

- Align the round point of the starter with the screw hole of air intake side.



4. Fuel System

Float Chamber

Disassembly

Remove 3 mounting screws and remove float chamber cover.

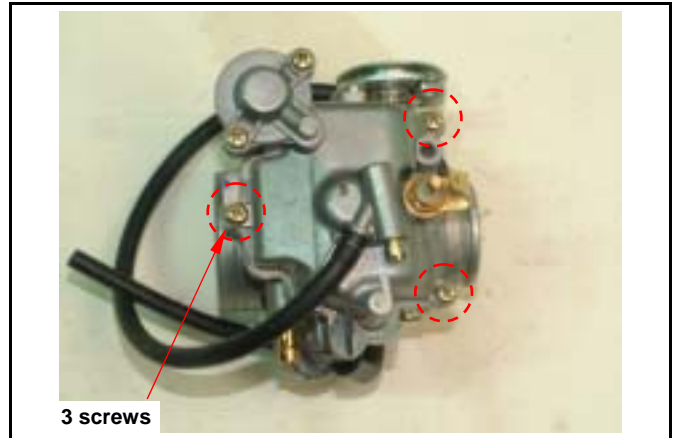

Remove the fuel level plate, float pin, float and float valve.



Inspection

Check float valve and valve seat for damage, blocking, blocking.
Check float valve for wearing, and check valve seat face for wear, dirt.

Caution

In case of worn out or dirt, the float valve and valve seat will not tightly close causing fuel level to increase and as a result, fuel flooding. A worn out or dirty float valve must be replaced with a new one.

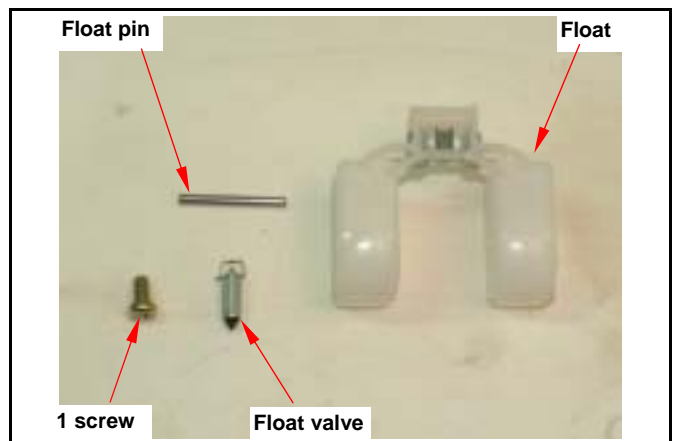

Remove main jet, needle jet holder, needle jet, slow jet and air adjustment screw.

Caution

Take care not to damage jets and adjust screw.

- Before removing adjustment screw, turn it all the way down and note the number of turns.
- Does not turn adjust screw forcefully to avoid damaging valve seat face.

Clean jets with cleaning fluid. Then use compressed air to blow the dirt off.
Blow carburetor body passages with compressed air.

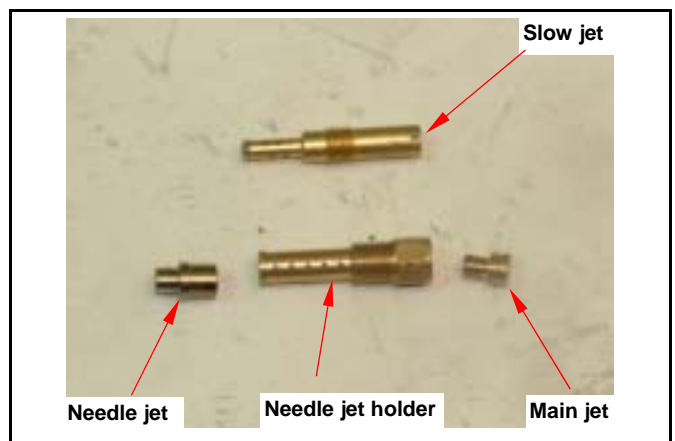

Assembly

Install main jet, needle jet holder, needle jet, slow jet and air adjustment screw.

⚠ Caution

Set the air adjustment screw in according to number of turns noted before it was removed.

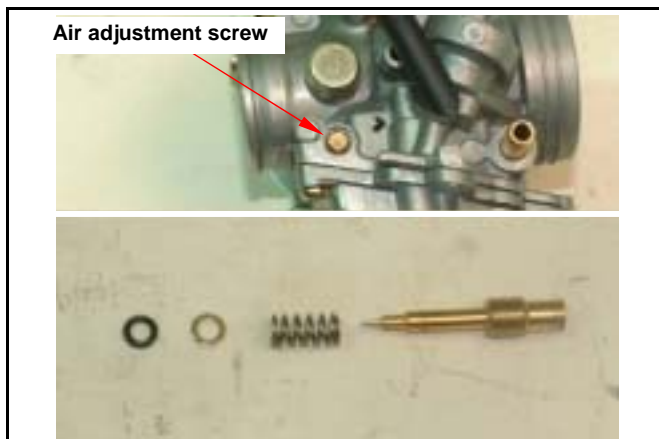

Install the float valve, float, and float pin.

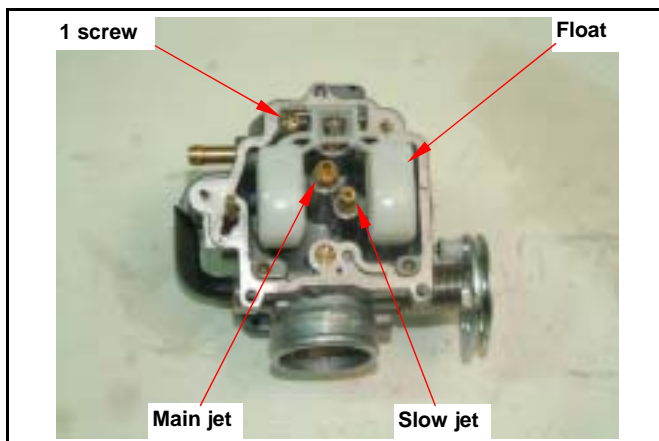
**Checking fuel level****⚠ Caution**

- Check again to ensure float valve, float for proper installation.
- To ensure correct measurement, position the float meter in such a way so that float chamber face is vertical to the main jet.

Fuel level: 18.5mm

**Installation of carburetor**

Install carburetor in the reverse order of removal. Following adjustments must be made after installation.

- Throttle cable adjustment.
- Idle adjustment

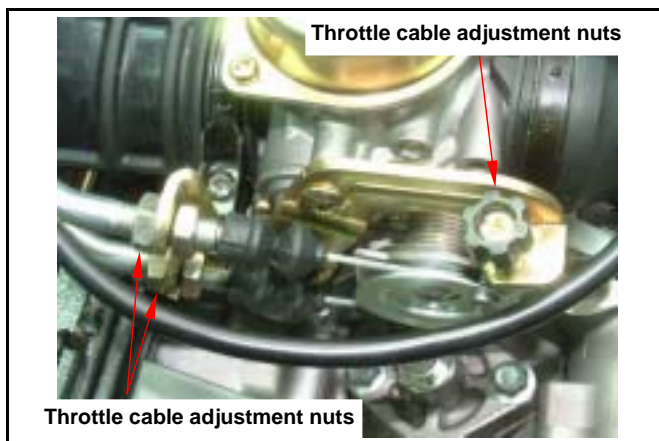

4. Fuel System

Adjustment of Idle Speed

Caution

- Air screw was set at factory, so no adjustment is needed. Note the number of turns it takes to screw it all the way in for ease of installation.
- The parking brake must be used to stop the ATV to perform the adjustments.

Use a tachometer when adjusting engine RPM. Screw in air adjustment screw gently, then back up to standard turns.

Standard turns: 2 1/2 turns

Warm up engine; adjust the throttle stopper screw of throttle valve to standard RPM.

Idle speed rpm: 1500 ± 100 rpm

Connect the hose of exhaust analyzer to exhaust front end. Press test key on the analyzer.

Adjust the pilot screw and read CO reading on the analyzer

CO standard value: 1.3~2.0 %

Accelerate in gradual increments; make sure rpm and CO value are in standard value after engine running in stable. If rpm and CO value fluctuated, repeat the procedures described above for adjusting to standard value.

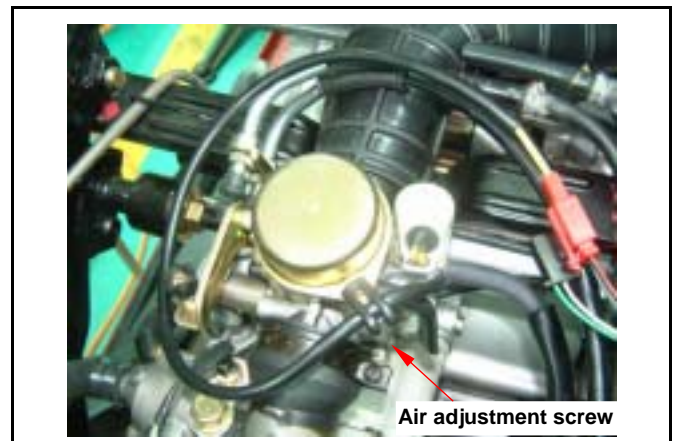
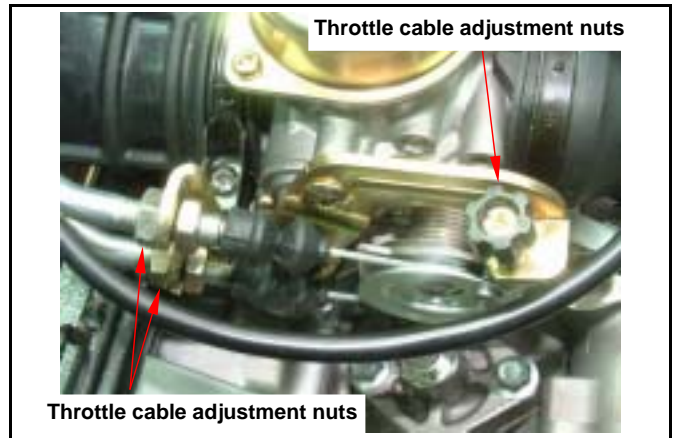

Fuel Tank

Fuel unit removal

Remove the left and right side covers.
 Open seat and remove the luggage box.
 Remove rear carrier.
 Remove the left and right body covers.
 Remove the foot pedal (please refer to chapter 13 for these components above.)

Remove fuel unit coupler, and then remove fuel unit (4 screws).

Caution

- Do not bend the float arm of fuel unit
- Do not fill out too much fuel to fuel tank.

Fuel unit inspection (Refer to electrical equipment chapter 17).

Fuel unit installation

Install the fuel unit in the reverse order of removal.

Caution

Do not forget to install the gasket of fuel unit or damage it.

Fuel tank removal

Remove the left and right side covers.
 Open seat and remove the luggage box.
 Remove rear carrier.
 Remove the left and right body covers.
 Remove the foot pedal (please refer to chapter 13 for these components above.)
 Remove under cover (4 bolts).
 Disconnect fuel unit coupler.
 Remove the fuel inlet tubes.

Remove the vapor tube, fuel outlet tube.
 Remove fuel tank front and rear side 4 bolts, and then remove fuel tank.

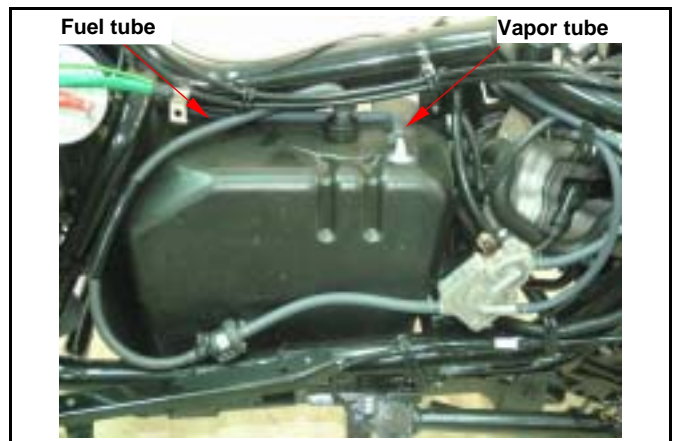
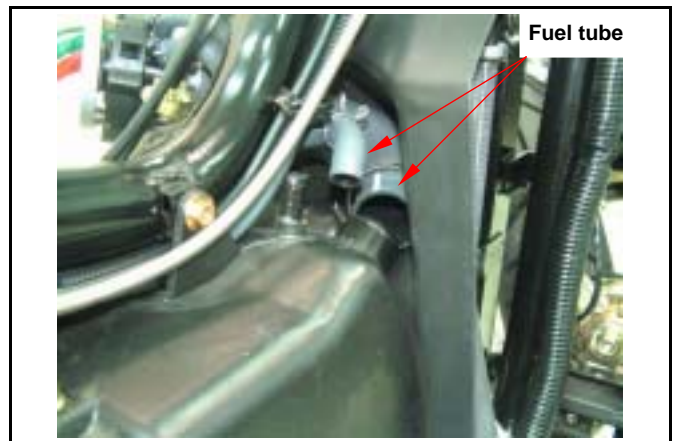
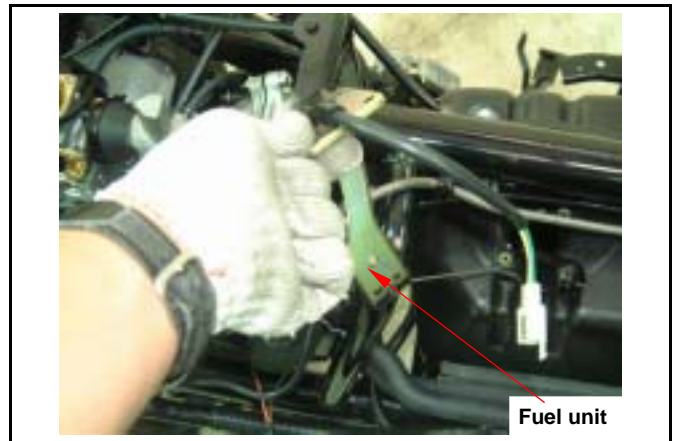
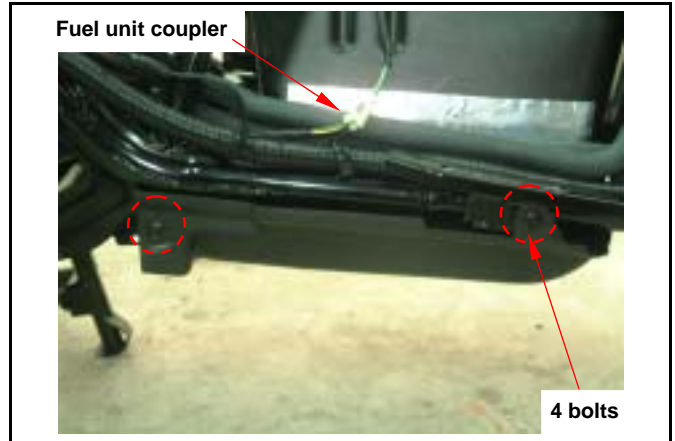

4. Fuel System

Remove fuel tank upper bolts (2 bolts).

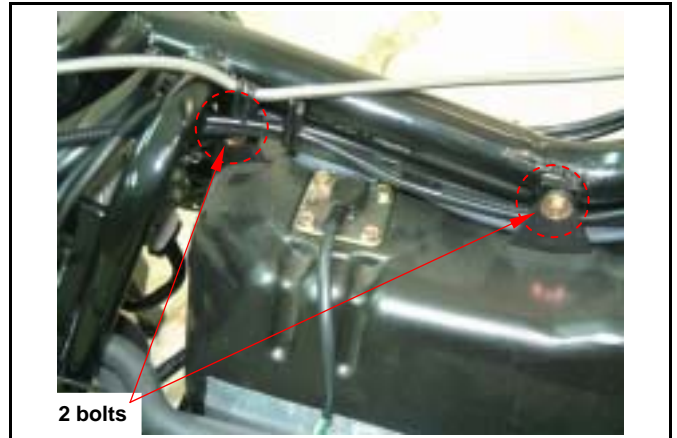

Remove fuel tank under bolt (1 bolt).



Remove fuel tank.

Installation

Install the fuel tank in the reverse order of removal.



Fuel Pump

Inspection

Remove the body cover.

Warm up the engine and adjust idle speed.

Remove fuel hose from carburetor and then wait for 5 minutes.

Measure the output of fuel pump. Its output time is 10 seconds.

Output quantity: Min. 20 c.c.

If the output quantity is lower than 20 c.c., check fuel hose, vacuum hose and fuel filter.

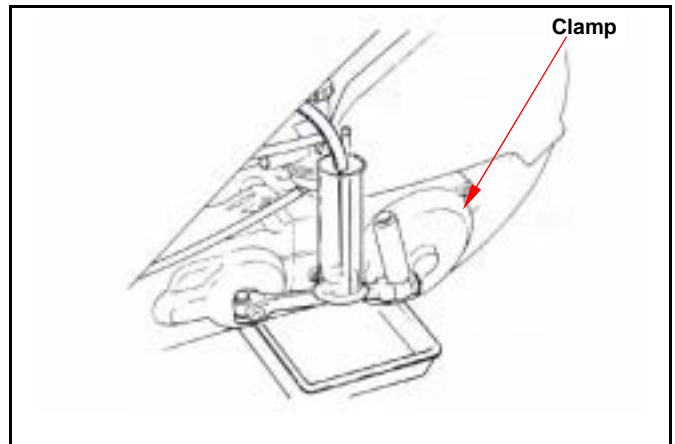

Removal / Installation

Remove floor plate.

Remove fuel inlet, outlet and vacuum tube.

Remove 2 nuts and fuel pump.

Install the fuel pump in the reverse order of removal procedures.

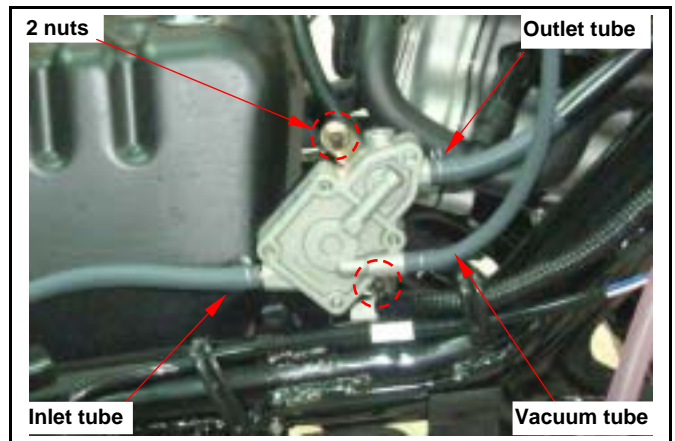

4. Fuel System

Air Cleaner

Removal

Loosen the clamp strip of air cleaner and carburetor, and then remove the vapor hose.

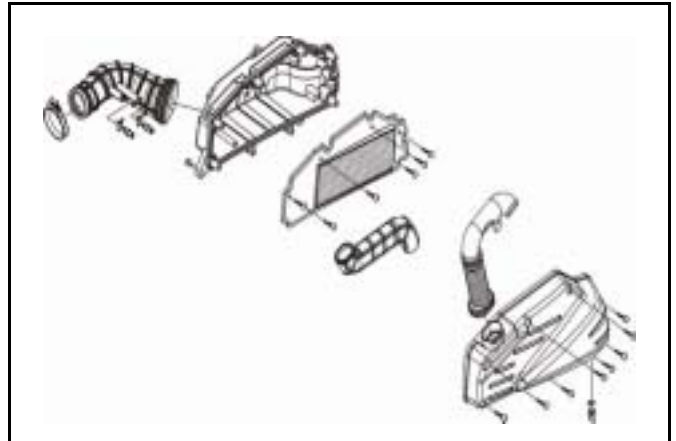

Remove the air cleaner (3 bolts).

Installation

Install the tank in the reverse order of removal.

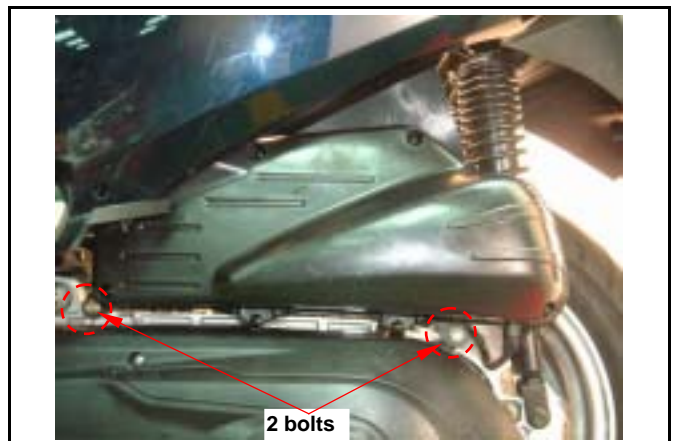

Cleaning air cleaner element

Remove the air cleaner cover (8 screws).

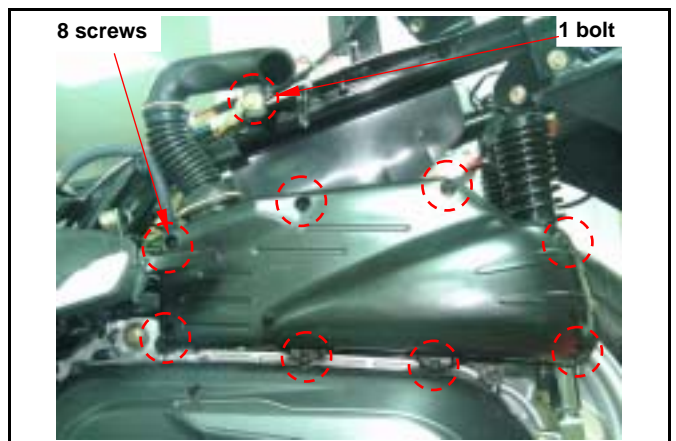

Remove element mounting screws (6 screws).
Remove the air cleaner element.
With compressed air to cleaning dirty around the element. Replace it if it is too dirty to clean.

Caution

The air cleaner element is made of paper so do not soap it into water or wash it with water.

Install the element onto the element seat and then install the air cleaner cover.

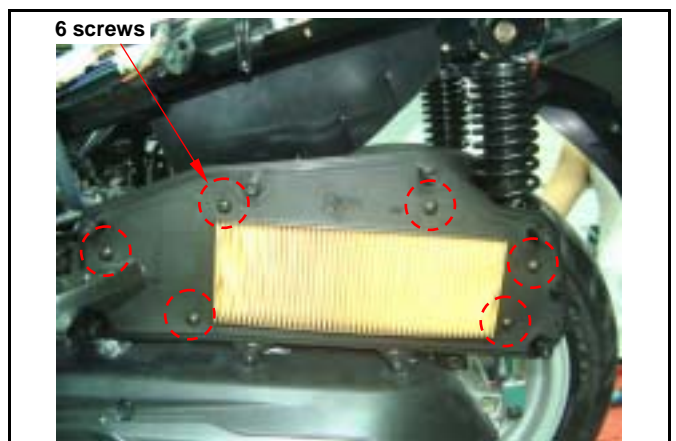

Operational Precautions 5-1	Rear Fork 5-7
Engine Removal 5-2	Removal of Engine Bush 5-9
Engine Hanger 5-6	Installation of Engine 5-10

Operational Precautions

General Information

- Engine must be supported by a bracket or adjustable tool in height.
- The following parts can be serviced with the engine installed on the frame.
 1. Carburetor
 2. Driving disk, driving belt, clutch, and transporting disk
 3. Final reduction gear mechanism

Specification

Item		LM25W
Engine Oil Capacity	Replacement	1,200 c.c.
	Disassemble	1,400 c.c.
Gear Oil Capacity	Replacement	170 c.c.
	Disassemble	180 c.c.
Capacity of coolant	Engine + radiator	850 c.c.
	Reservoir upper	420 c.c.

Torque Values

Engine hanger bolt (frame side)	7.5~9.5kgf-m
Engine hanger nut (engine side)	7.5~9.5kgf-m
Bolt of rear cushion upper connection	3.5~4.5kgf-m
Bolt of rear cushion lower connection	2.4~3.0kgf-m
Rear wheel axle nut	11.0~13.0kgf-m

5. Removal & Installation of Engine

Engine Removal

Open inner box cover.

Remove battery cover (1 screw).

Remove the battery negative (-) cable.

Remove the battery positive (+) cable.

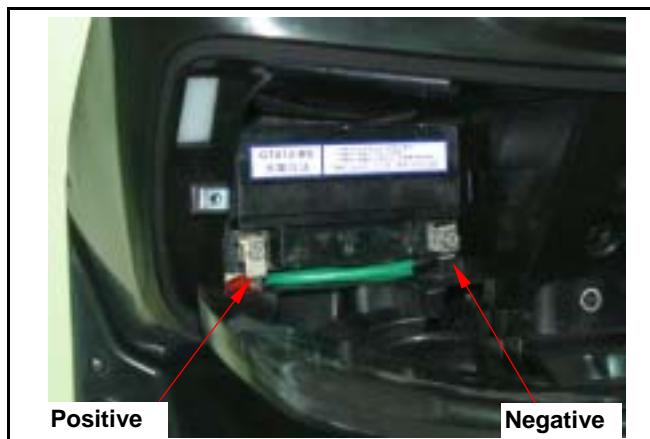

Open the seat.

Remove the luggage box (6 bolts, 2 screws).

(Refer to chapter 13)



Remove right and left side covers (4 screws on each side.).

Remove rear carrier (4 bolts).

Remove body cover (4 screws & 1 coupler).

(Refer to chapter 13)



Remove the power coupler of auto by-starter.

Remove the spark plug cap.

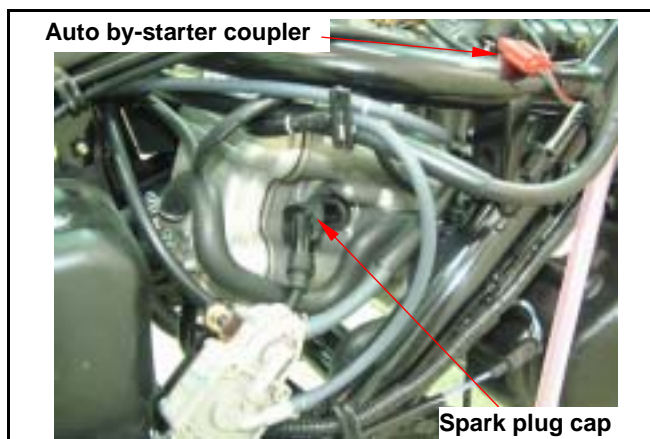

5. Removal & Installation of Engine

Remove the generator power wire and pulse generator connector.
Remove the starter motor wire.

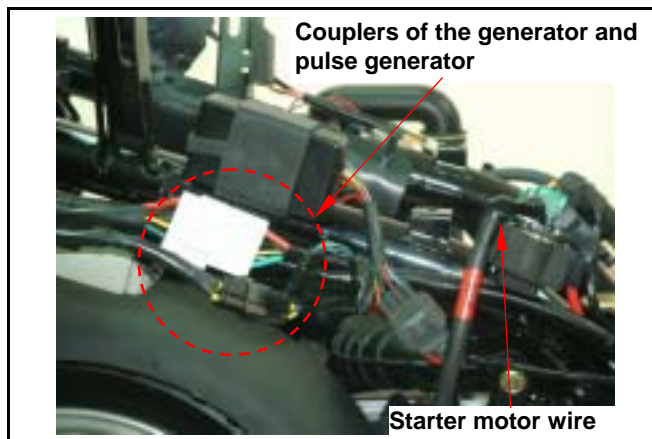

Remove engine blow-by pipe.

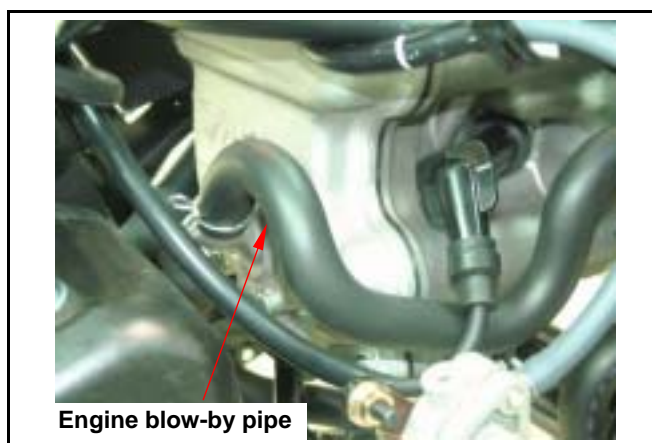

Remove the fuel line, vacuum hose, and throttle valve cable from the carburetor.
Loosen the clamp strip of air cleaner and carburetor, and then remove the air cleaner hose.

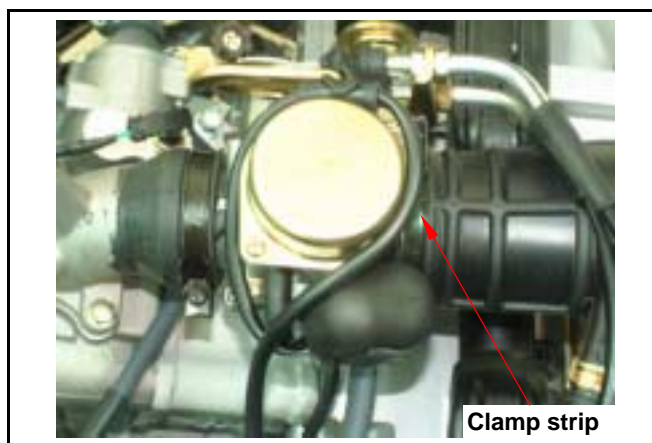

Remove the air cleaner inlet pipe connection bolt (1 bolt).

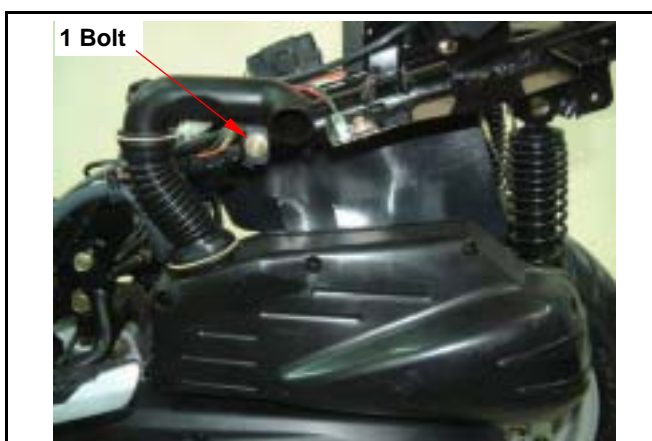

5. Removal & Installation of Engine

Remove the air cleaner connection bolts (2 bolts).
Remove the air cleaner.

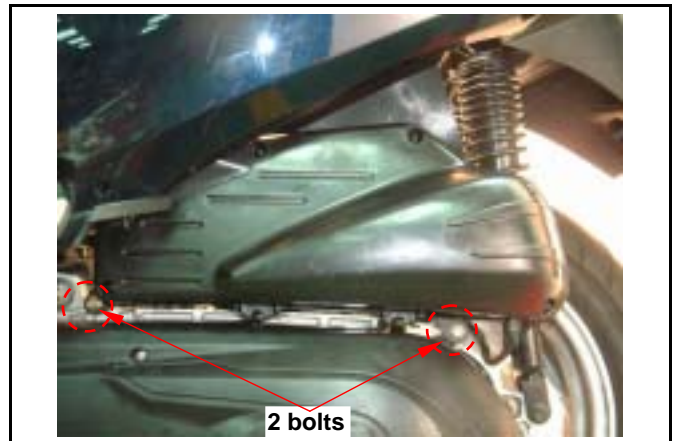

Remove the exhaust muffler (3 bolts, 2 nuts).

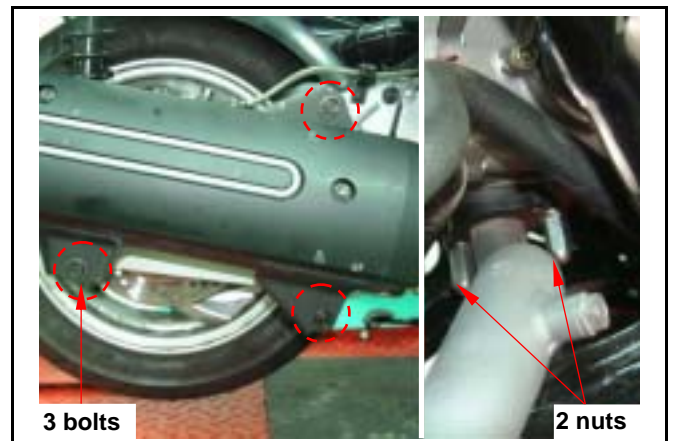

Drain out coolant, and remove coolant inlet hose.

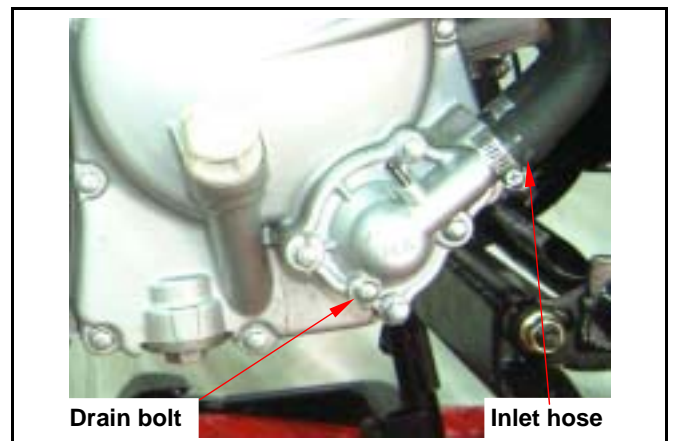

Remove the coolant inlet hose and thermo-sensor wire.

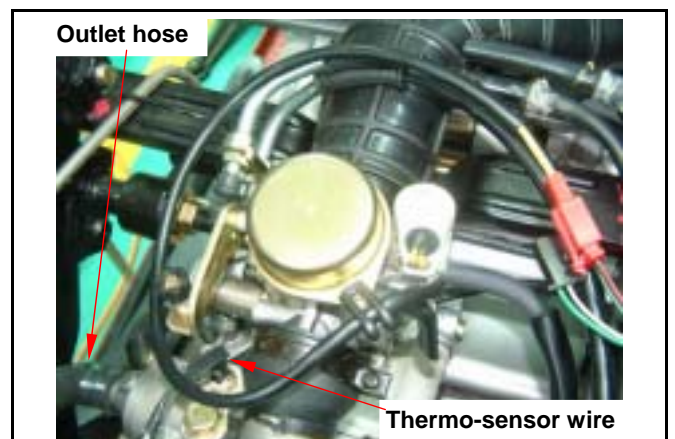

Remove rear brake hose clamp and rear brake caliper.

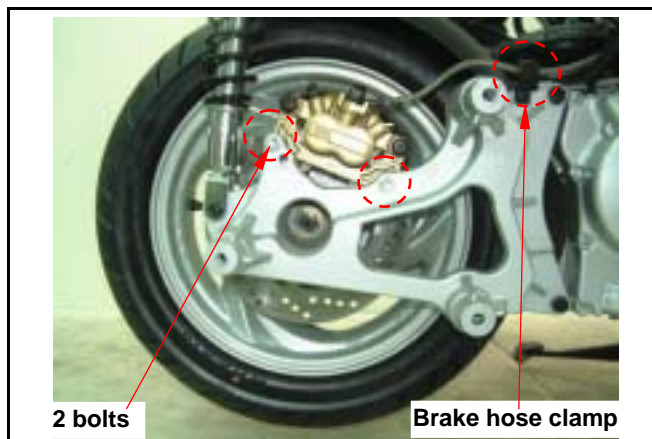

Remove the right rear cushion lower bolt (1 bolt).
Remove the rear fork bolts (2 bolts).
Remove the rear wheel axle nut (1 nut).

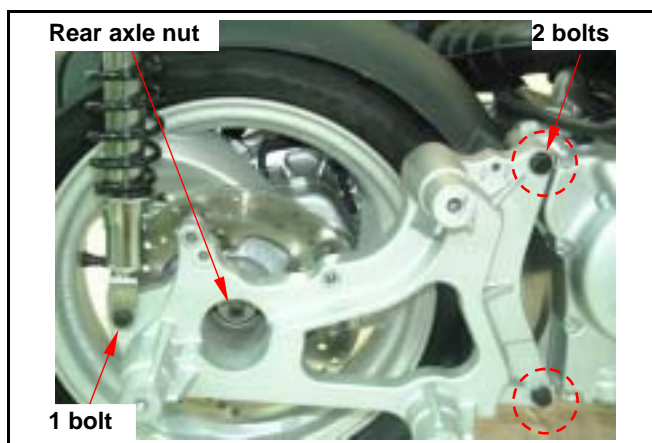

Remove the rear fork and rear axle collars.



Remove left rear cushion lower bolt (1 bolt).



5. Removal & Installation of Engine

With a bracket to support the engine to prevent from it damage by falling down as removing the engine.

Remove frame side engine hanger bolts (each side 1 bolt), and then remove engine.

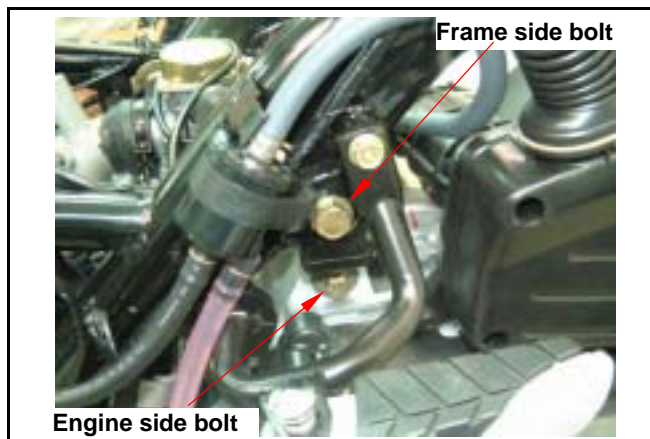

Engine Hanger

Removal

Remove the engine side bolts of engine hanger. (1 bolt on each side)

Remove the engine hanger.

Check if the engine hanger bush and cushion rubber for damage. If so, replace with new ones.

Installation

Tighten the bolts and nuts of engine hanger.

Engine hanger nut:

Torque Value: 7.5~9.5kgf-m

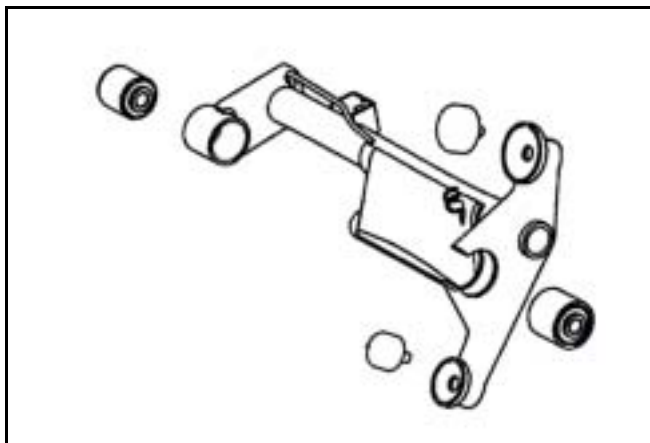

Rear Fork

Bearing Inspection

Check bearings on rear fork.
 Rotate bearing inner ring with fingers.
 Check if bearing can be turned in smooth and silent, and also check if bearing outer ring is mounted on rear fork tightly.
 If bearing rotation is uneven, noising, or loose bearing mounted, then replace it.

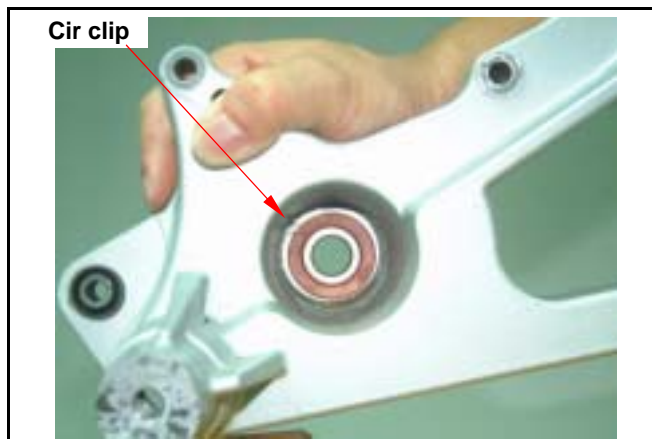

Bearing removal

Remove bearing mounting cir clip.
 Drive the bearing out of the rear fork.



Bearing installation

Install new rear axle bearing and bearing puller into rear fork.

Special Service Tools:

Rear fork bearing puller SYM-6303000-6303

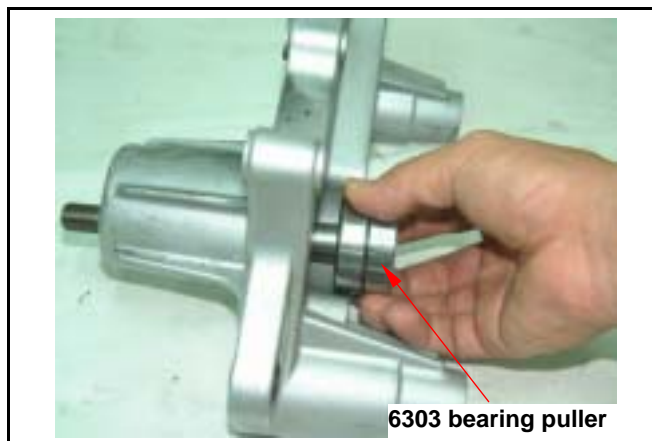

Install the washer of the 6303 bearing puller.

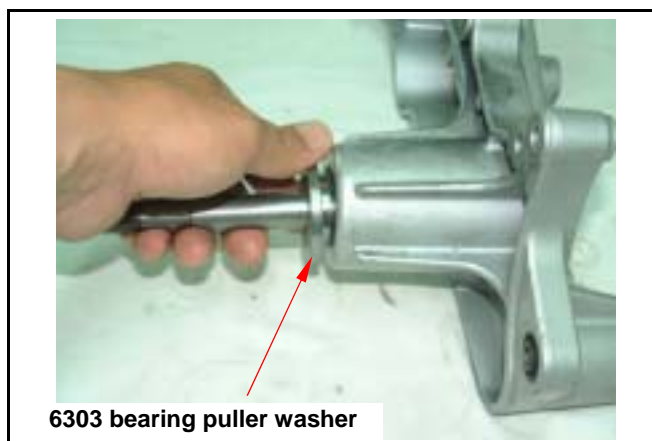

5. Removal & Installation of Engine

Install assembly directs puller bearing puller.

Special Service Tools:

Assembly directs puller SYM-2341110



Use screw driver holder bearing puller lower part, and turn the bearing puller upper part to install the rear fork bearing.



Install bearing mounting cir clip.

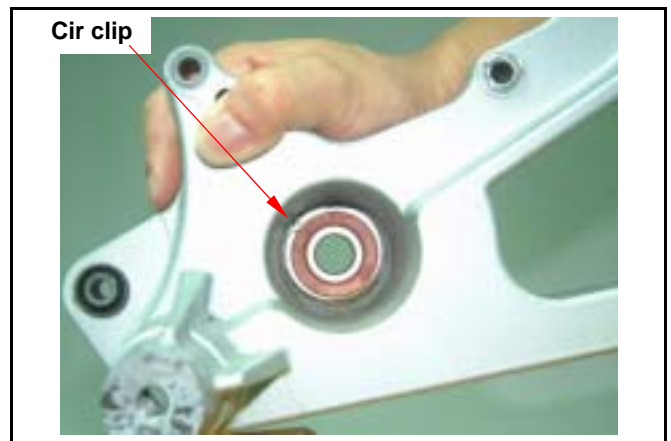

Removal of Engine Bush

If engine hanger frame and the cushion rubber of rear cushion bush damaged. Then, with the bush remover / presser, $\varnothing 28\text{mm}$ & $\varnothing 20\text{mm}$, to press the bush out, and replace it with new one.

Engine hanger bush: $\varnothing 28\text{mm}$

Rear cushion bush: $\varnothing 20\text{mm}$



Pressing out

Place the detent section of the bush remover toward the bush, and drive both the pressing ring and bolt in to press the bush out.

Special Service Tools:

Crankcase bush remover/presser SYM-1120310

Crankcase bush remover/presser SYM-1120320



Pressing In

Place the flat section of the remover toward the bush, and then drive the bush, pressing ring, and bolt in to install the bush.



5. Removal & Installation of Engine

Installation of Engine

Install the engine according to the reversing order of removal.

Caution

- Note both feet and hands safety for squeezing as engine installation.
- Do not bent or squeeze each wires or hose.
- Route all cables and wires in accordance with the routine layout.

Engine hanger nut:

Torque Value: 7.5~9.5kgf-m

Rear cushion bolt:

Torque Value: upper: 3.5~4.5kgf-m

Under: 2.4~3.0kgf-m

Rear wheel axle nut:

Torque Value: 11.0~13.0kgf-m



Mechanism Diagram.....	6-1	Valve Stem Replacement.....	6-10
Precautions in Operation	6-2	Valve Seat Inspection and Service...	6-11
Troubleshooting.....	6-3	Cylinder Head Reassembly.....	6-13
Cylinder Head Removal.....	6-4	Cylinder Head Installation.....	6-14
Cylinder Head Disassembly.....	6-6	Valve Clearance Adjustment.....	6-16
Cylinder Head Inspection.....	6-8		

Mechanism Diagram

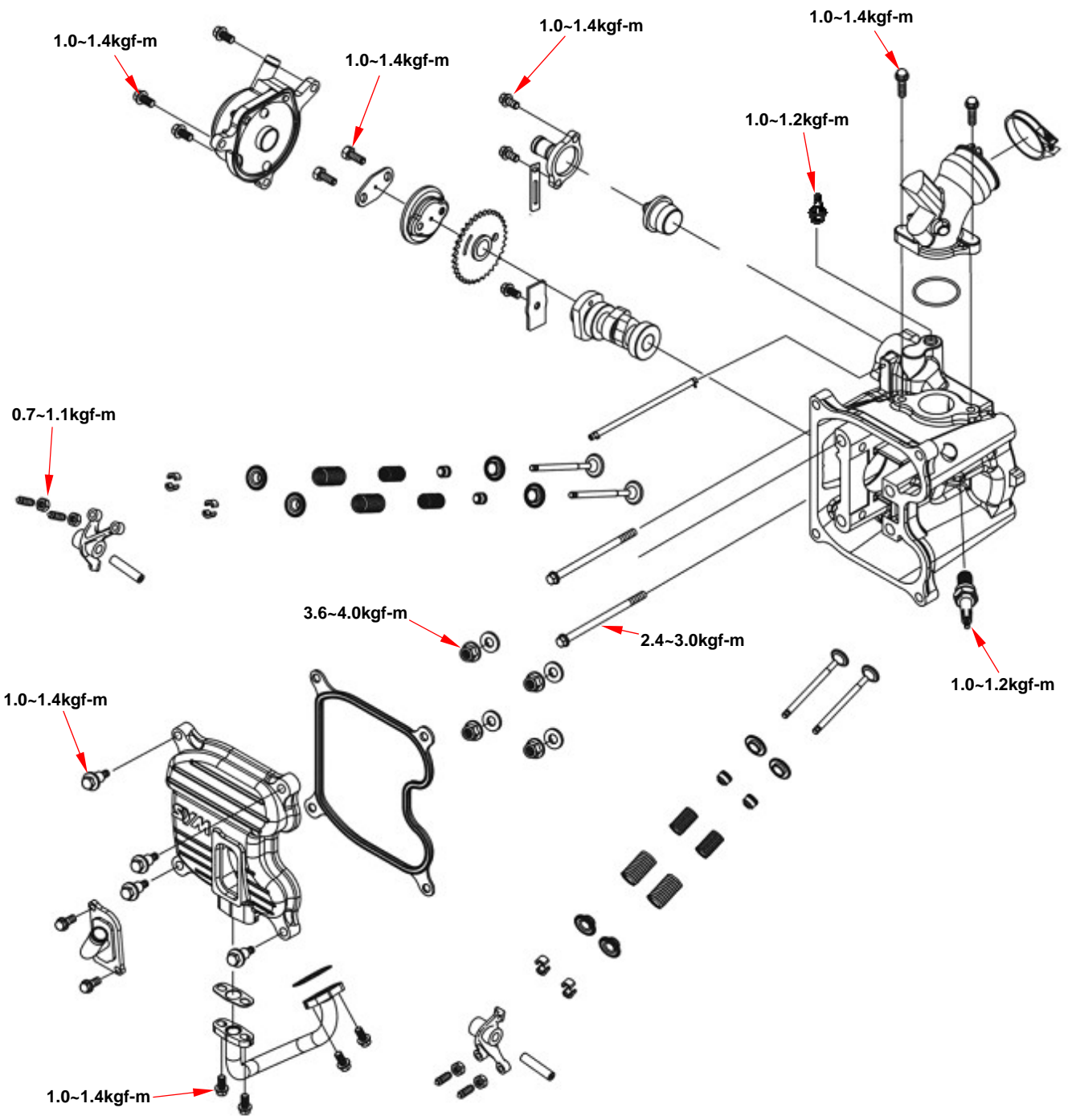

6. Cylinder Head / Valve

Precautions in Operation

General Information

- This chapter is contained maintenance and service for cylinder head, valve, and camshaft as well as rocker arm.
- Cylinder head service can be carried out when engine is in frame.

Specification

Item		Standard	Limit
Compression pressure		12±2 kg/cm ²	---
Camshaft	Height of cam lobe	Intake	34.880
		Exhaust	34.740
Rocker arm	ID of valve rocker arm		11.982~12.000
	OD of valve rocker arm shaft		11.966~11.984
Valve	OD of valve stem	Intake	4.975~4.990
		Exhaust	4.950~4.975
	ID of valve guide		5.000~5.012
	Clearance between valve stem and guide	Intake	0.010~0.037
		Exhaust	0.025~0.062
	Free length of valve spring	Inner	38.700
		outer	40.400
	Valve seat width		1.600
	Valve clearance	Intake	0.10±0.02mm
		Exhaust	0.15±0.02mm
Tilt angle of cylinder head		---	0.050

Torque Value

Cylinder head cover bolt	1.0~1.4kgf-m
Exhaust pipe stud bolt	2.4~3.0kgf-m
Cylinder head bolt	1.0~1.4kgf-m
Cylinder head Nut	3.6~4.0kgf-m
Sealing bolt of cam chain auto-tensioner	0.8~1.2kgf-m
Bolt of cam chain auto-tensioner	1.2~1.6kgf-m
Cylinder side cover bolt	1.0~1.4kgf-m
Cam sprocket bolt	1.0~1.4kgf-m
Tappet adjustment screw nut	0.7~1.1kgf-m
Spark plug	1.0~1.2kgf-m

Tools

Special service tools

Valve reamer: 5.0mm
 Valve guide driver: 5.0mm
 Valve spring compressor

Troubleshooting

Engine performance will be affected by troubles on engine top parts. The trouble usually can be determined or by performing cylinder compression test and judging the abnormal noise generated.

Low compression pressure

1. Valve

- Improper valve adjustment
- Burnt or bent valve
- Improper valve timing
- Valve spring damage
- Valve carbon deposit.

2. Cylinder head

- Cylinder head gasket leaking or damage
- Tilt or crack cylinder

3. Piston

- Piston ring worn out.

High compression pressure

- Too much carbon deposit on combustion chamber or piston head

Noise

- Improper valve clearance adjustment
- Burnt valve or damaged valve spring
- Camshaft wear out or damage
- Chain wear out or looseness
- Auto-tensioner wear out or damage
- Camshaft sprocket
- Rocker arm or rocker arm shaft wear out

6. Cylinder Head / Valve

Cylinder Head Removal

Remove engine. (Refer to chapter 5)



Remove 2 bolts of thermostat and then remove the thermostat.

Remove hole bolt and spring for the cam chain tensioner.

Loosen 2 bolts, and then remove tensioner.

Remove thermostat (2 bolts).

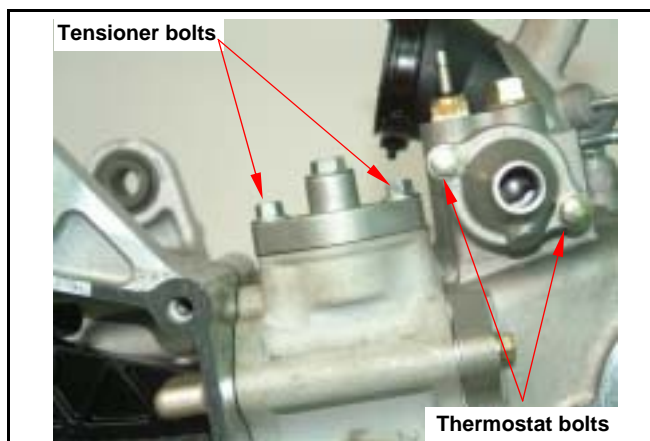

Remove Air Injection system (AI) pipe mounting bolts.

Remove spark plug.



Remove cylinder head cover (4 bolts).



Remove the side cover mounting bolts of cylinder head, and then take out the side cover.

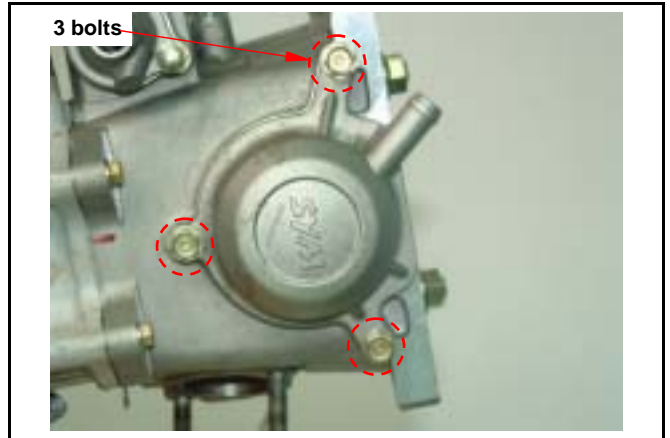

Remove left crankcase cover, and turn the crankshaft. Turn the drive face, and align the timing mark on the sprocket with that of cylinder head, piston is at TDC position.

Remove cam sprocket bolts and then remove the sprocket by prying chain out.

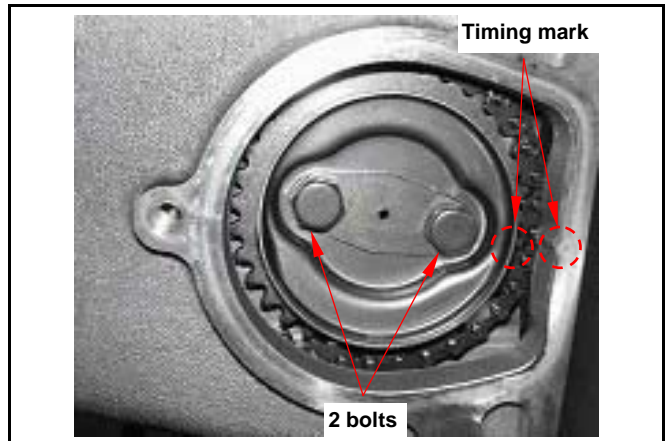

Remove the 2 cylinder head mounting bolts from cylinder head right side, and then remove 4 nuts and washers from cylinder head upper side. Remove the cylinder head.

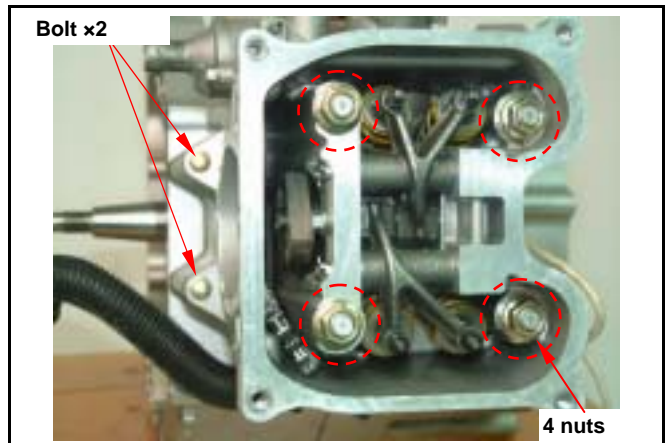

Remove cylinder head gasket and 2 dowel pins. Remove chain guide. Clean up residues from the matching surfaces of cylinder and cylinder head.

⚠ Caution

- Do not damage the matching surfaces of cylinder and cylinder head.
- Avoid residues of gasket or foreign materials falling into crankcase as cleaning.

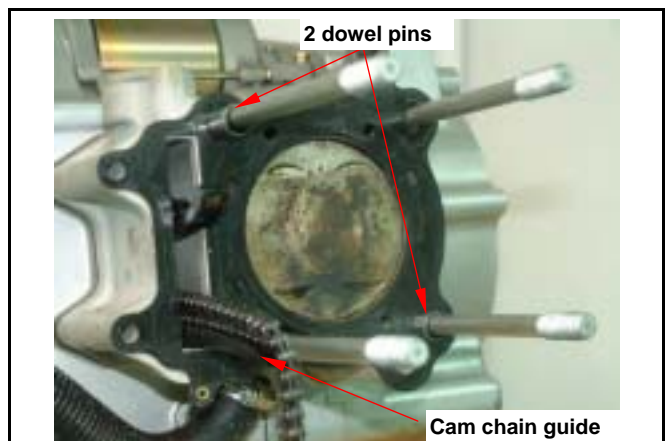

6. Cylinder Head / Valve

Cylinder Head Disassembly

Remove cam shaft setting plate (1 bolt).

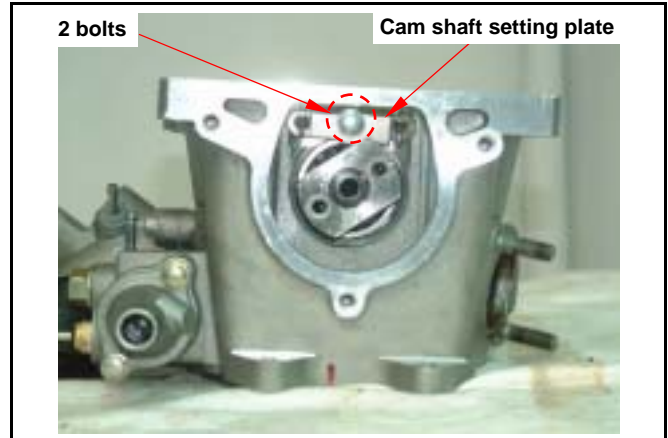

Remove rocker arm shafts and rocker arms.

Special Service Tool:

Rocker arm and cam shaft puller SYM-1445100



Remove cam shafts.

Special Service Tool:

Rocker arm and cam shaft puller SYM-1445100



Use a valve cotter remove & assembly tool to press the valve spring, and then remove valves.

Caution

- In order to avoid losing spring elasticity, do not press the spring too much. Thus, press length is based on the valve cotter in which can be removed.

Special Service Tool:

Valve cotter remove & assembly tool SYM-1471110-SY125

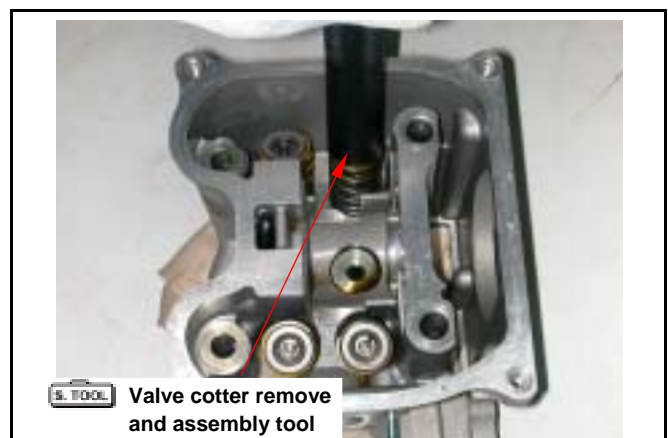

Remove valve cotters, spring retainers, springs and valves.

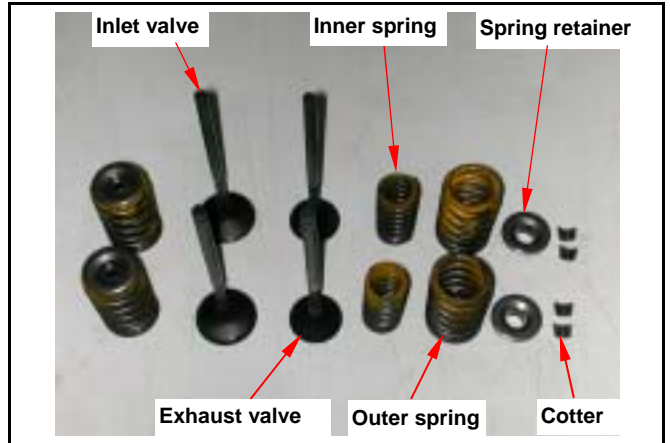

Remove valve stem seals.

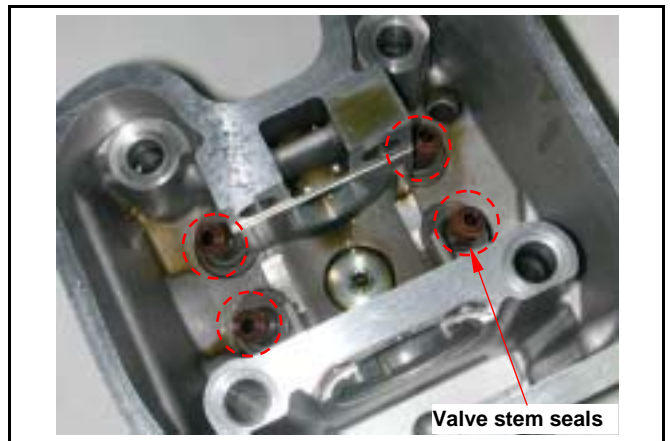

Clean carbon deposits in combustion chamber.
Clean residues and foreign materials on cylinder head matching surface.

⚠ Caution

Do not damage the matching surface of cylinder head.



6. Cylinder Head / Valve

Cylinder Head Inspection

Check if spark plug and valve holes are cracked. Measure cylinder head warp with a straightedge and thickness gauge.

Service limit: 0.05 mm

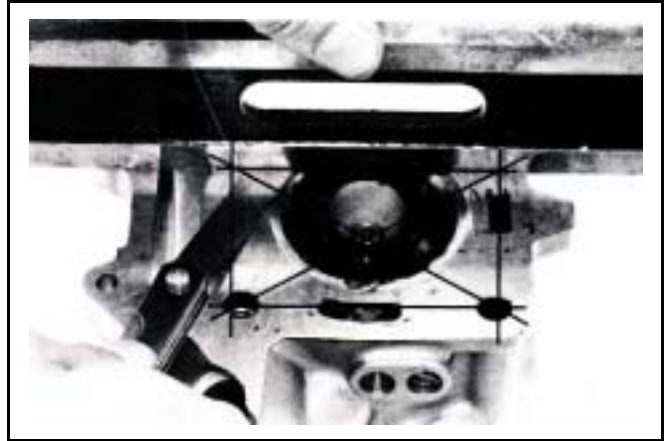

Camshaft

Inspect cam lobe height for damaged.

Service Limit:

IN: Replacement when less than 34.860mm

EX: Replacement when less than 34.725mm

Inspect the camshaft bearing for looseness or wear out. If any damage, replace whole set of camshaft and bearing.

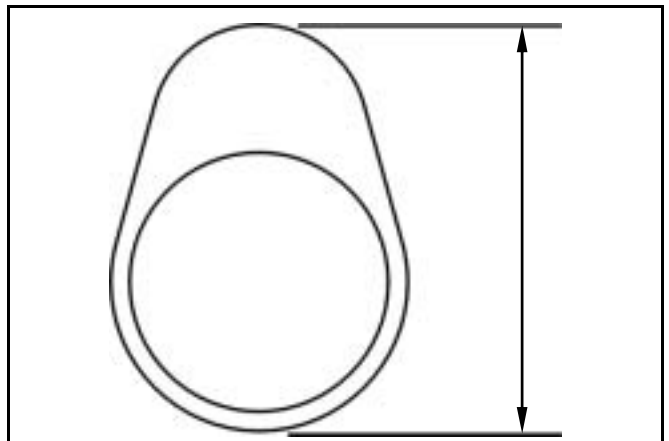

Rocker Arm

Measure the cam rocker arm I.D., and wear or damage, oil hole clogged?

Service Limit: Replace when it is less than 12.080 mm.

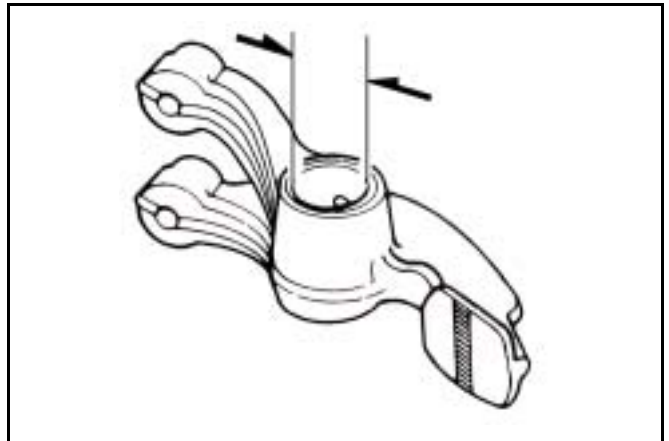

Rocker Arm Shaft

Measure the active O.D. of the cam rocker arm shaft and cam rocker arm.

Service Limit: Replace when it is less than 11.936 mm.

Calculate the clearance between the rocker arm shaft and the rocker arm.

Service Limit: Replace when it is less than 0.10 mm.

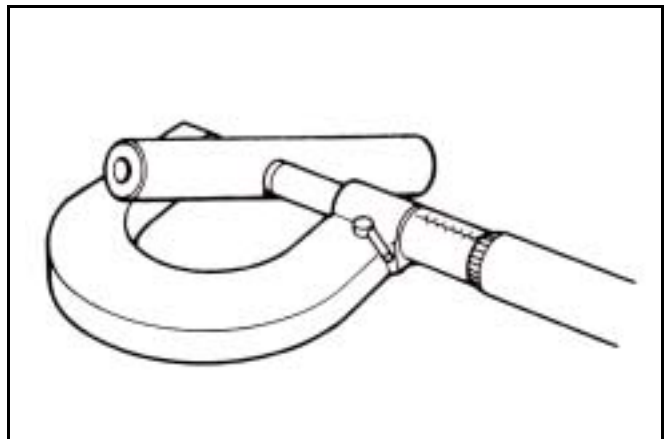

Valve spring free length

Measure the free length of intake and exhaust valve springs.

Service limit:

Inner spring 35.20 mm

Outer spring 36.90 mm

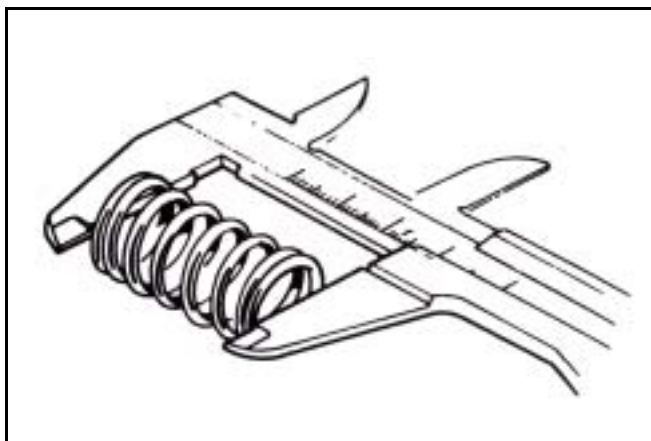

Valve stem

Check if valve stems are bend, crack or burn. Check the operation condition of valve stem in valve guide, and measure & record the valve stem outer diameter.

Service Limit: IN: 4.90 mm

EX: 4.90 mm

Valve guide

Caution

Before measuring the valve guide, clean carbon deposits with reamer.

Tool: 5.0 mm valve guide reamer



Measure and record each valve guide inner diameters.

Service limit: 5.03 mm

The difference that the inner diameter of valve guide deducts the outer diameter of valve stem is the clearance between the valve stem and valve guide.

Service Limit: IN 0.08 mm

EX 0.10 mm

Caution

If clearance between valve stem and valve guide exceeded service limit, check whether the new clearance that only replaces new valve guide is within service limit or not. If so, replace valve guide.

Correct it with reamer after replacement. If clearance still exceeds service limit after replaced valve guide, replace valve stem too.

Caution

It has to correct valve seat when replacing valve guide.

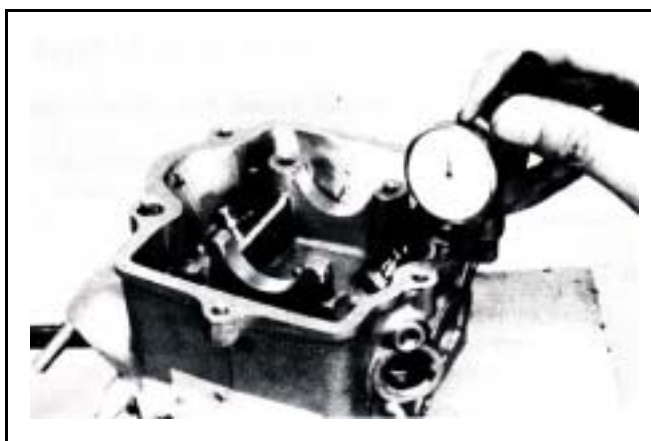
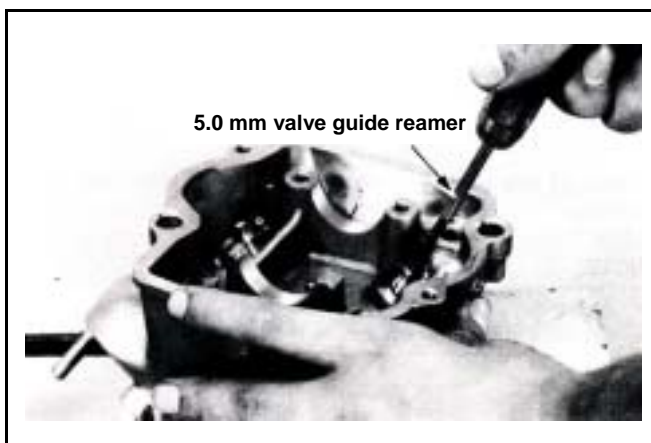

6. Cylinder Head / Valve

Valve Stem Replacement

Heat up cylinder head to 100~150 with heated plate or toaster.

Caution

- Do not let torch heat cylinder head directly. Otherwise, the cylinder head may be deformed as heating it.
- Wear on a pair of glove to protect your hands when operating.

Hold the cylinder head, and then press out old valve guide from combustion chamber side.

Tool: Valve guide driver: 5.0 mm

Caution

- Check if new valve guide is deformation after pressed it in.
- When pressing in the new valve guide, cylinder head still have to be kept in 100~150 .

Adjust the valve guide driver and let valve guide height is in 13 mm.

Press in new valve guide from rocker arm side.

Tool: Valve guide driver: 5.0 mm

Wait for the cylinder head cooling down to room temperature, and then correct the new valve guide with reamer.

Caution

- Using cutting oil when correcting valve guide with a reamer.
- Turn the reamer in same direction when it be inserted or rotated.

Correct valve seat, and clean up all metal residues from cylinder head.

Tool: Valve guide reamer: 5.0 mm

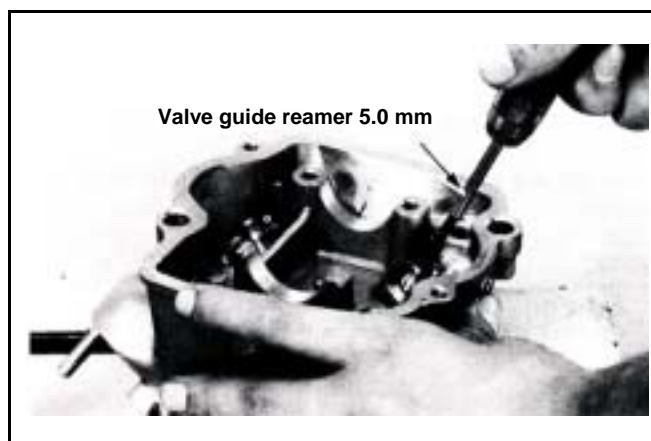
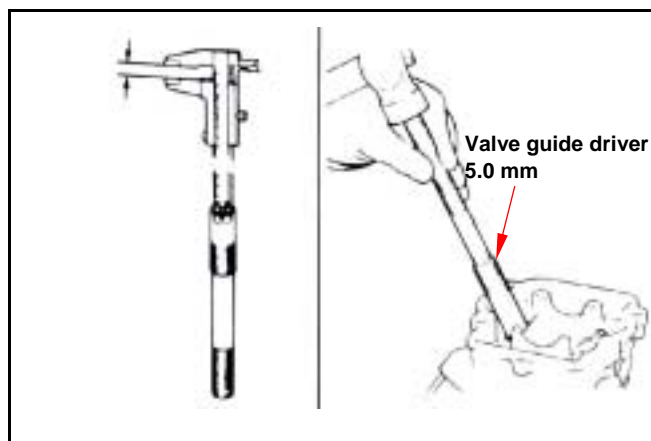
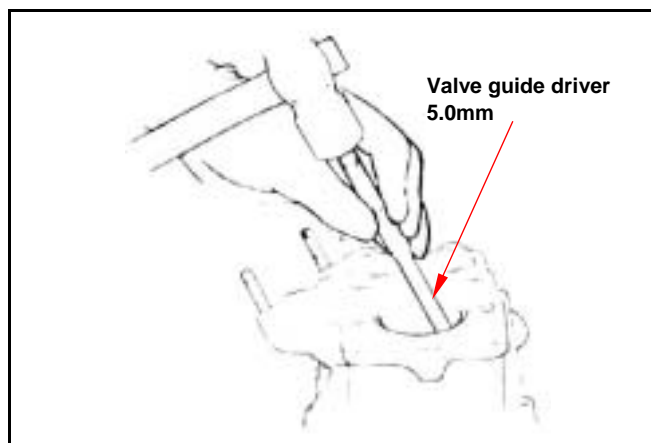

Valve Seat Inspection and Service

Clean up all carbon deposits onto intake and exhaust valves.

Apply with emery slightly onto valve contact face.
Grind valve seat with a rubber hose or other manual grinding tool.

⚠ Caution

- Do not let emery enter into between valve stem and valve guide.
- Clean up the emery after corrected, and apply with engine oil onto contact faces of valve and valve seat.

Remove the valve and check its contact face.

⚠ Caution

Replace the valve with new one if valve seal is roughness, wear out, or incomplete contacted with valve seat.

Valve seat inspection

If the valve seat is too width, narrow or rough, corrects it.

Valve seat width

Service limit: 1.6mm

Check the contact condition of valve seat.

Valve seat grinding

The worn valve seat has to be ground with valve seat chamfer cutter.

Refer to operation manual of the valve seat chamfer cutter.

Use 45° valve seat chamfer cutter to cut any rough or uneven surface from valve seat.

⚠ Caution

After valve guide had been replaced, it has to be ground with 45° valve seal chamfer cutter to correct its seat face.

Use 32° cutter to cut a quarter upper parts out.

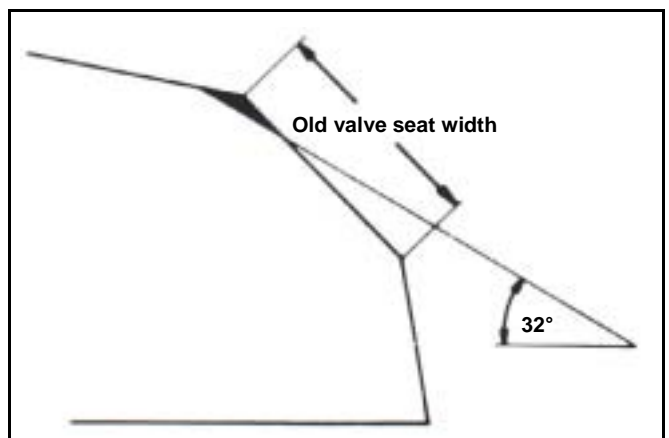
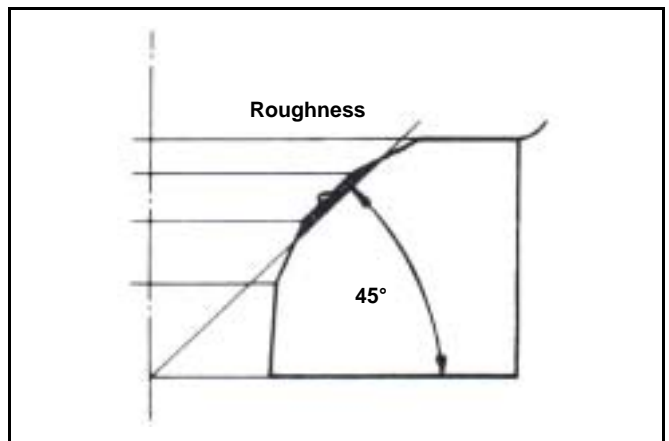
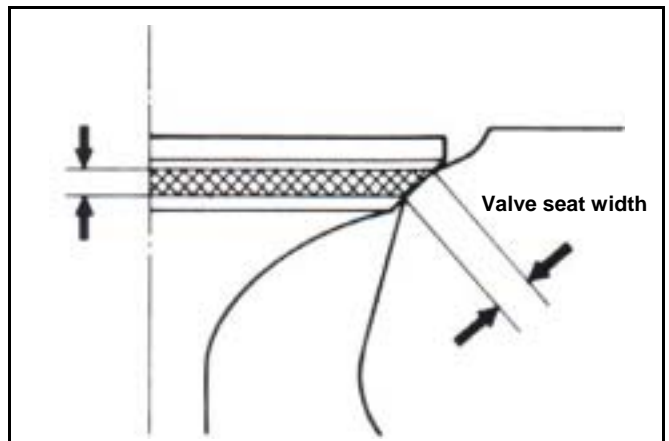
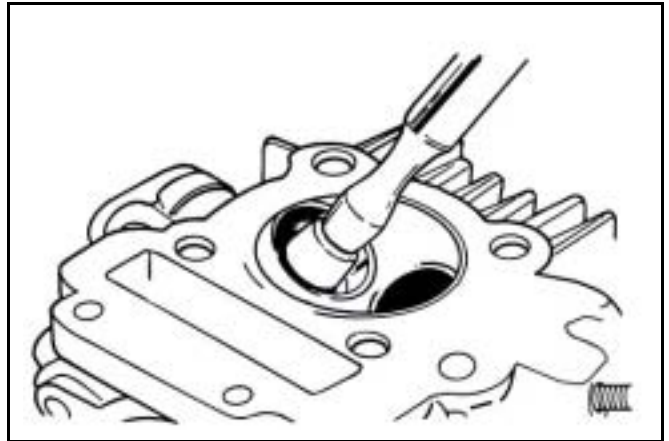

6. Cylinder Head / Valve

Use 60° cutter to cut a quarter lower parts out.
Remove the cutter and check new valve seat.

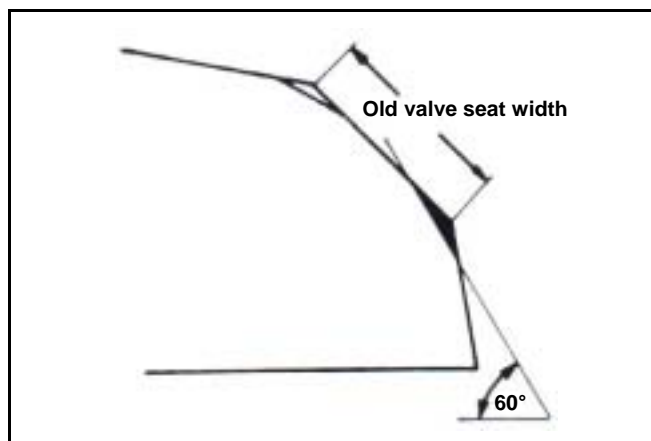

Use 45° cutter to grind the valve seat to specified width.

Caution

Make sure that all roughness and uneven faces had been ground.

Grind valve seat again if necessary.

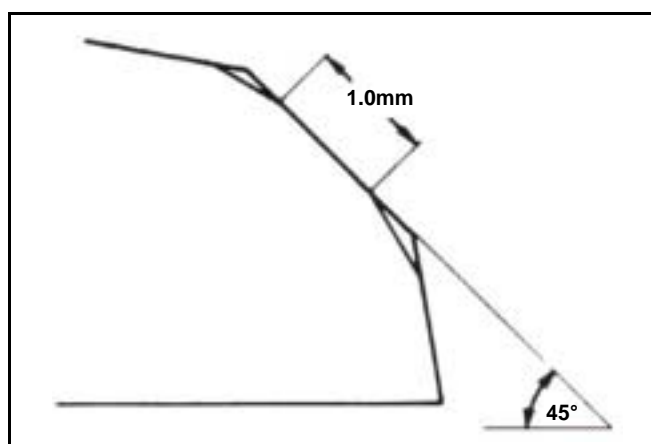

Coat the valve seat surface with red paint.
Install the valve through valve guide until the valve contacting with valve seat, slightly press down the valve but do not rotate it so that a seal track will be created on contact surface.

Caution

The contact surfaces of valve and valve seat are very important to the valve sealing capacity.

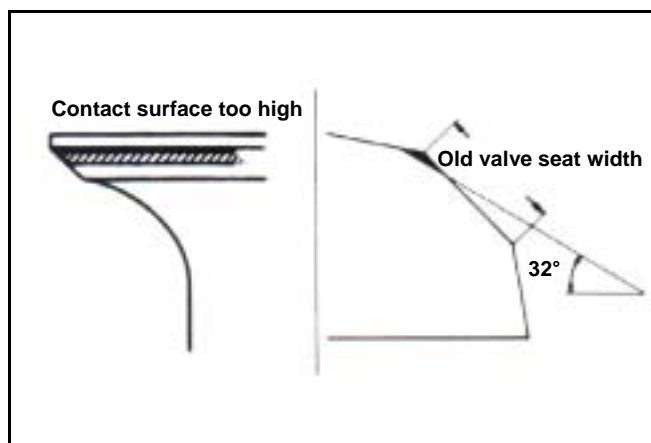

If the contact surface too high, grind the valve seat with 32° cutter.
Then, grind the valve seat to specified width.

If the contact surface too low, grind the valve seat with 60° cutter.
Then, grind the valve seat to specified width.

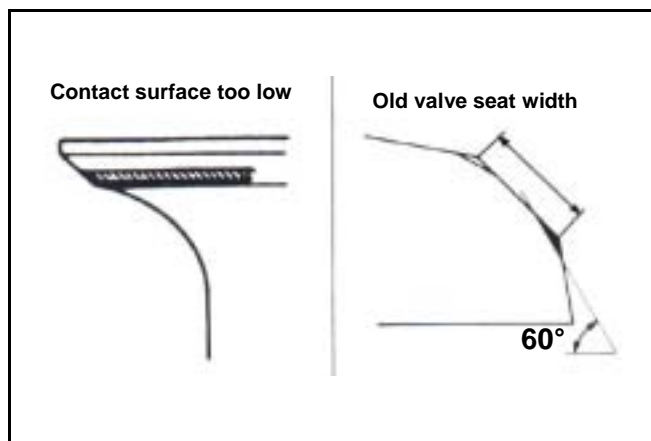

After the valve seat ground, coat valve seat surface with emery and then slightly press the ground surface.
Clean up all emery coated onto cylinder and valve after ground.

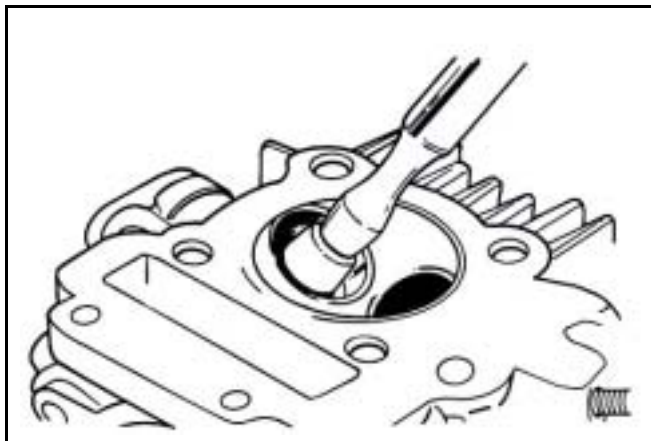

Cylinder Head Reassembly

Lubricate valve stem with engine oil, and then insert the valve into valve guide.
Install new valve stem oil seal.
Install valve springs and retainers.

Caution

The closed coils of valve spring should face down to combustion chamber.

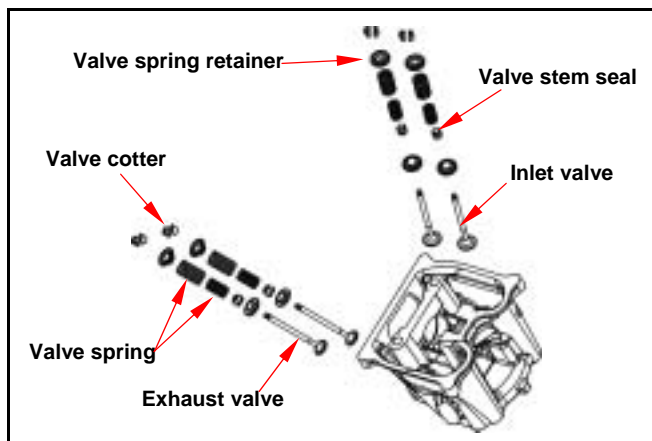

Use a valve cotter remove & assembly tool to press the valve spring, and then remove valves.

Caution

In order to avoid damaging the valve stem and the cylinder head, in the combustion chamber place a rag between the valve spring remover/installer as compressing the valve spring directly.

Special Service Tool:
Valve cotter remove & assembly tool
SYM-1471110-SY125

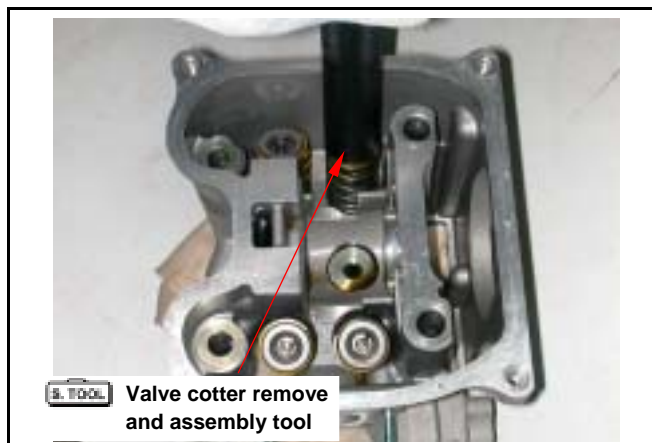

Tap the valve stems gently with a plastic hammer to make sure valve retainer and valve cotter is settled.

Caution

Place and hold cylinder head on to working table so that can prevent from valve damaged.

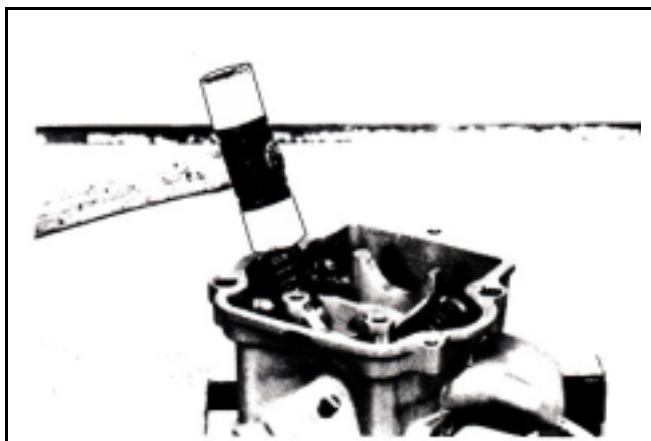

6. Cylinder Head / Valve

Install camshaft into cylinder head.
Install valve rocker arm, rocker arm shaft and cam shaft setting plate.

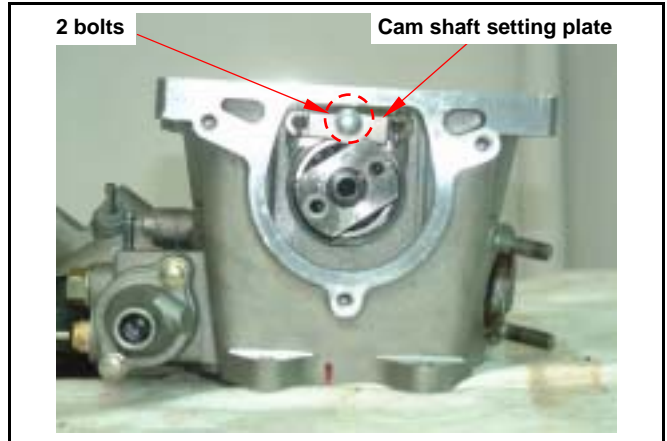

Cylinder Head Installation

Clean up all residues and foreign materials onto the matching surfaces of both cylinder and cylinder head.
Install chain guide, dowel pins and a new cylinder head gasket onto the cylinder.

⚠ Caution

Do not damage the matching surfaces of cylinder and cylinder head.
Avoid residues of gasket or foreign materials falling into crankcase as cleaning.

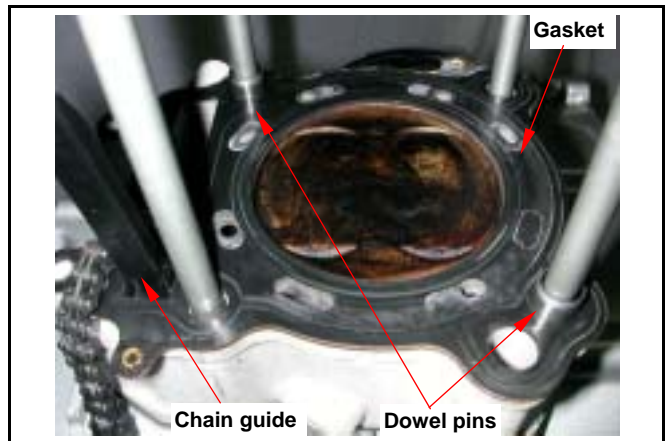

Install 4 washers and tighten 4 nuts on the cylinder head upper side, and then tighten 2 cylinder head mounting bolts of cylinder head right side.

Torque value:

Nut 3.6~4.0kgf-m

Bolt 1.0~1.4kgf-m

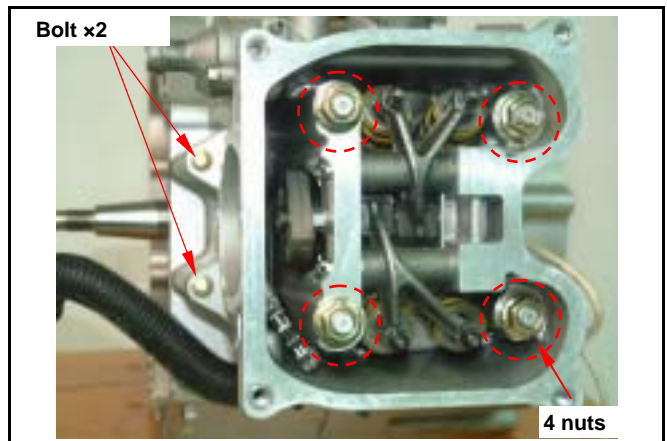

Install cam chain on to sprocket and align the timing mark on the sprocket with that of cylinder head.

Align sprocket bolt hole with camshaft bolt hole.
Tighten the sprocket mounting bolts.

⚠ Caution

Make sure timing marks are matched.

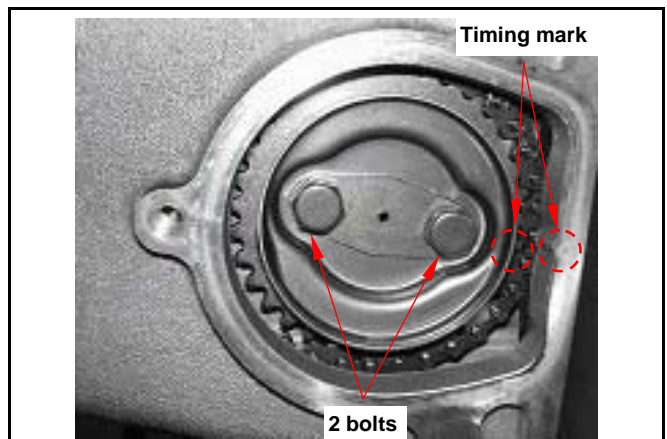

Install cylinder head side cover (3 bolts).

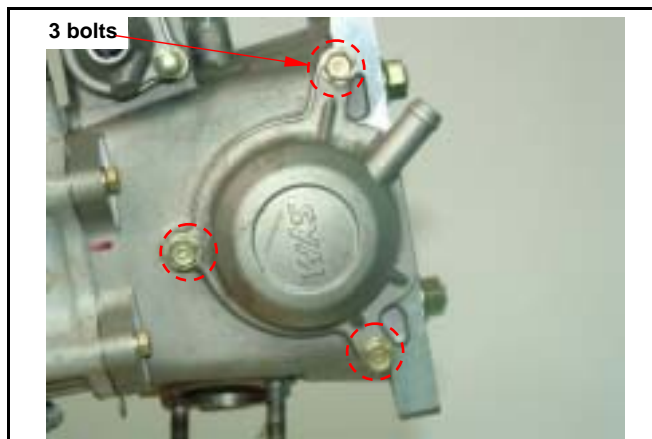

Install thermostat (2 bolts).
Loosen auto tensioner adjustment bolt and remove bolt and spring.
Install tensioner and install spring and adjustment bolt.

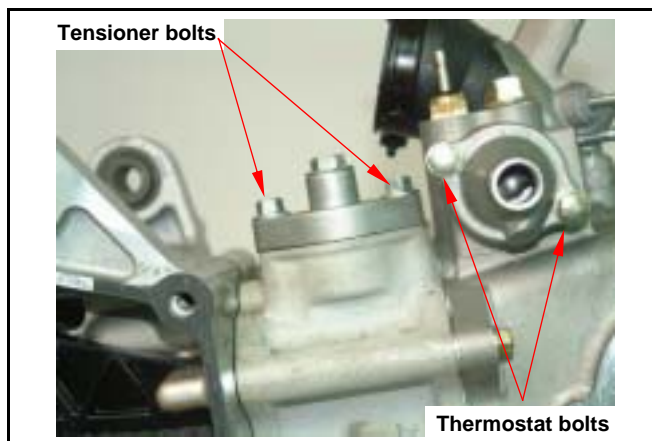

Install cylinder cover (4 bolts).



Install Air Injection system (AI) pipe. (4 bolts)
Install inlet pipe onto cylinder head.
Install and tighten spark plug.

Torque value: 1.0~2.0kgf-m

⚠ Caution

This model is equipped with more precision 4-valve mechanism so its tighten torque can not be exceeded standard value in order to avoid causing cylinder head deformation, engine noise and leaking so that motorcycle's performance be effected.

Install the engine onto frame (refer chapter 5).

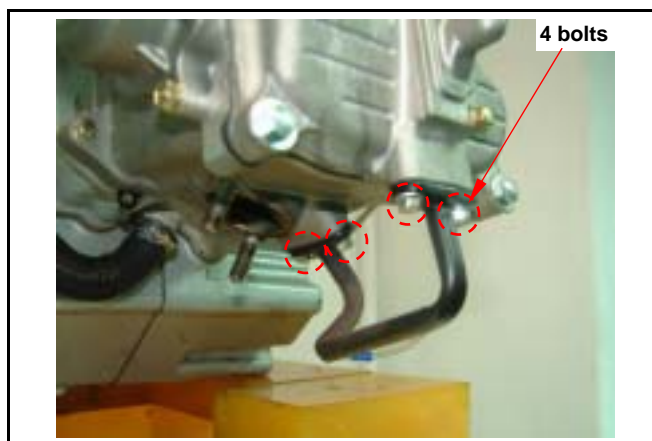

6. Cylinder Head / Valve

Valve Clearance Adjustment

Loosen Air Injection system (AI) pipe upper side bolt (2 bolts).

Remove cylinder head cover.

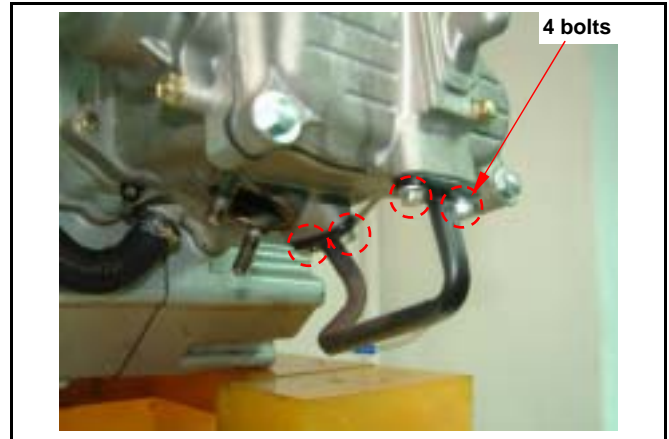

Remove the cylinder head side cover.

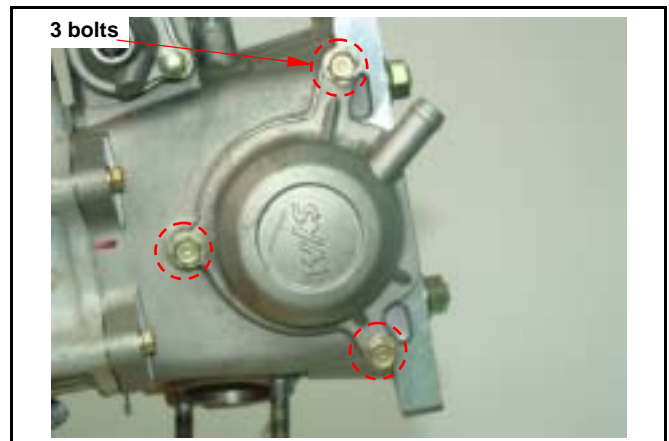

Remove left crankcase cover, and turn the drive face, and align the timing mark on the cam sprocket with that of cylinder head, piston is at TDC position.

Loosen valve clearance adjustment nuts and bolts located on valve rocker arm.

Measure and adjust valve clearance with feeler gauge.

After valve clearance had been adjusted to standard value, hold adjustment bolt and then tighten the Adjustment nut.

Standard Value: IN 0.10 ± 0.02 mm
EX 0.15 ± 0.02 mm

Install the cylinder head side cover.

Start the engine and make sure that engine oil flows onto the cylinder head.

Stop the engine after confirmed, and then install the cylinder head cover and AI pipe.

Caution

- If lubricant does not flow to cylinder head, engine components will be worn out seriously. Thus, it must be confirmed.
- When checking lubricant flowing condition, run the engine in idle speed. Do not accelerate engine speed.

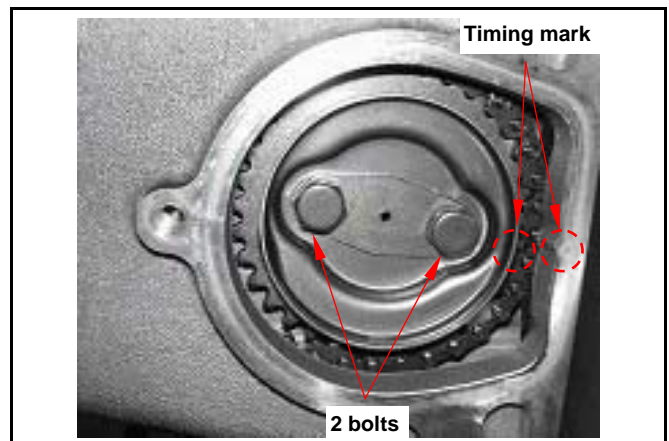

Mechanism Diagram 7-1	Piston Ring Installation 7-6
Precautions in Operation 7-2	Piston Installation 7-7
Trouble Diagnosis..... 7-2	Cylinder Installation 7-7
Cylinder and Piston Removal 7-3	

Mechanism Diagram

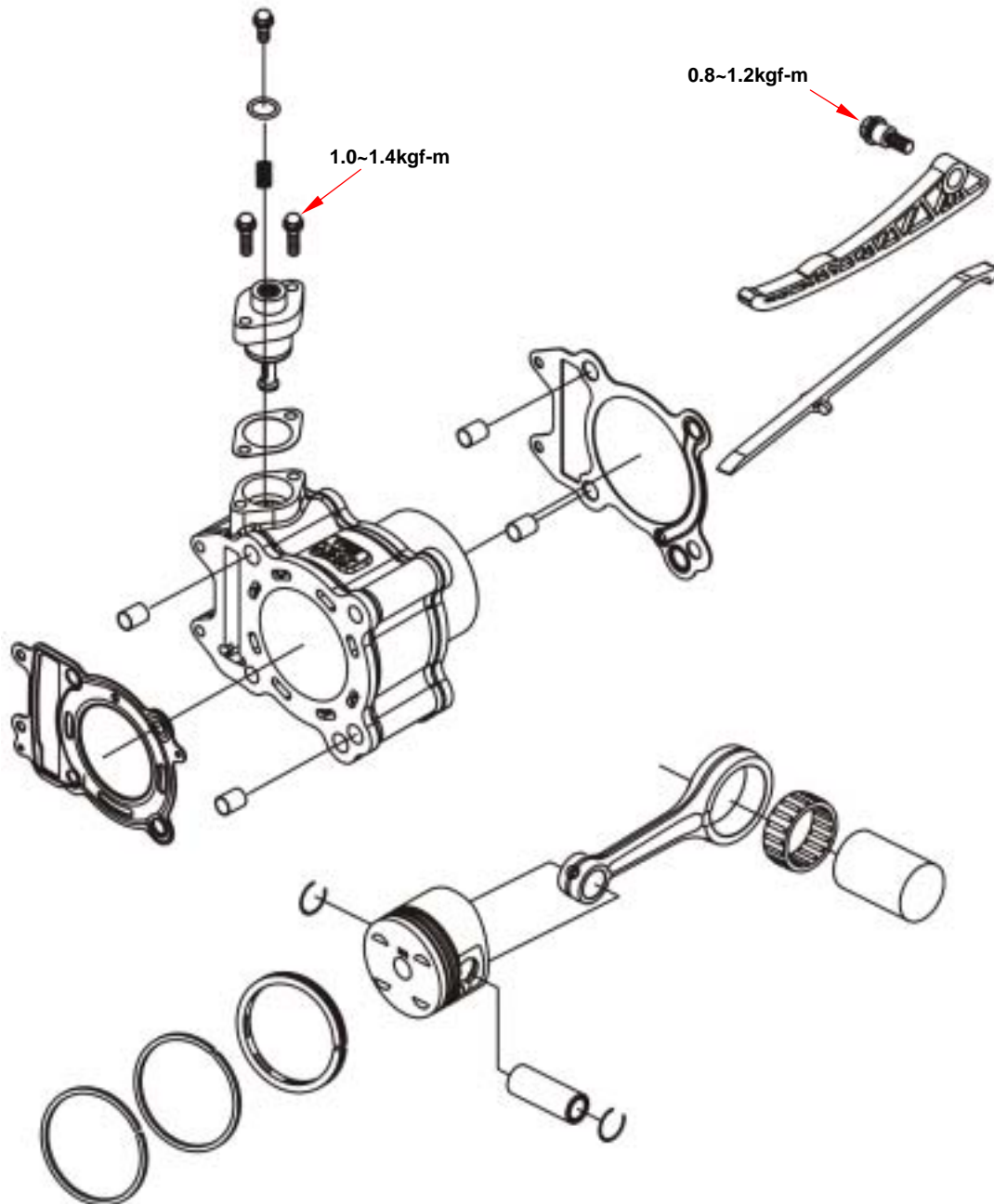

7. Cylinder / Piston

Precautions in Operation

General Information

- Both cylinder and piston service cannot be carried out when engine mounted on frame.

UA25A

Specification

Unit : mm

Item		Standard	Limit	
Cylinder	ID	70.995~71.015	71.100	
	Bend	-	0.050	
Piston/ Piston ring	Clearance between piston rings	Top ring	0.015~0.050	
		2 nd ring	0.015~0.050	
	Ring-end gap	Top ring	0.150~0.300	
		2 nd ring	0.300~0.450	
		Oil ring side rail	0.200~0.700	
	OD of piston (2 nd)		70.430~70.480	70.380
	Clearance between piston and cylinder		0.010~0.040	0.100
ID of piston pin boss		17.002~17.008	17.020	
OD of piston pin		16.994~17.000	16.960	
Clearance between piston and piston pin		0.002~0.014	0.020	
ID of connecting rod small-end		17.016~17.034	17.064	

Trouble Diagnosis

Low or Unstable Compression Pressure

- Cylinder or piston ring worn out

Knock or Noise

- Cylinder or piston ring worn out
- Carbon deposits on cylinder head top-side
- Piston pin hole and piston pin wear out

Smoking in Exhaust Pipe

- Piston or piston ring worn out
- Piston ring installation improperly
- Cylinder or piston damage

Engine Overheat

- Carbon deposits on cylinder head top side
- Cooling pipe clogged or not enough in coolant flow

Cylinder and Piston Removal

Remove cylinder head (refer to chapter 6).

Remove coolant hose from cylinder.

Remove cylinder.

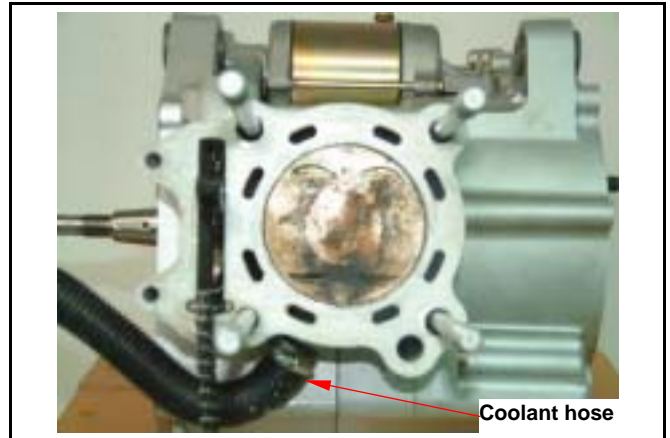

Cover the holes of crankcase and cam chain with a piece of cloth.

Remove piston pin clip, and then remove piston pin and piston.



Remove cylinder gasket and dowel pin.

Clean up all residues or foreign materials from the two matching surfaces of cylinder and crankcase.

Caution

- Soap the residues into solvent so that the residues can be removed more easily.



Inspection

Check if the inner diameter of cylinder is wear out or damaged.

In the 3 positions, top, center and bottom, of cylinder, measure the X and Y values respective in the cylinder.

Service limit: 71.100 mm

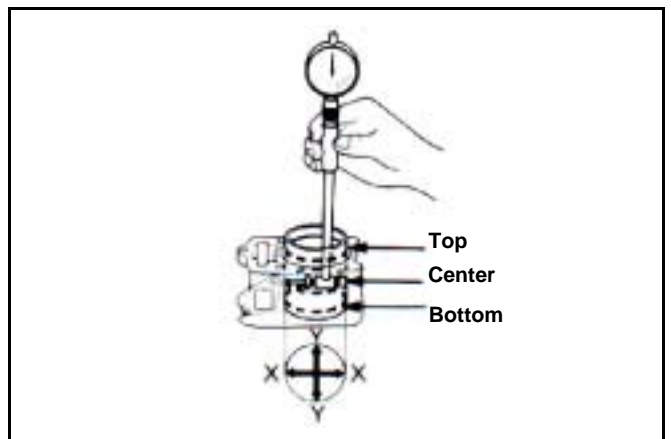

7. Cylinder / Piston

Check cylinder if warp.

Service limit: 0.05 mm

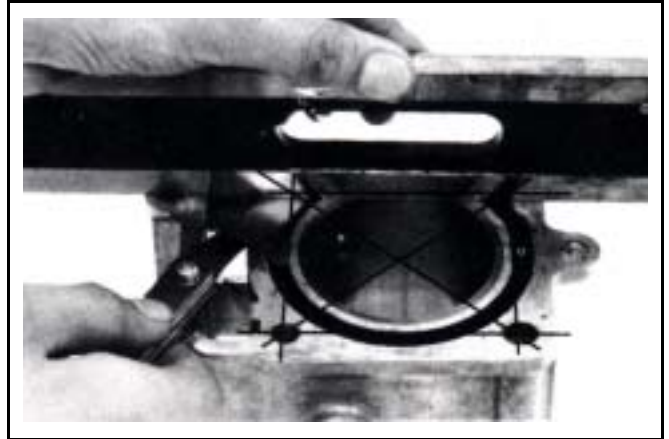

Measure clearance between piston rings and grooves.

Service Limit: Top ring: 0.09 mm

2nd ring: 0.09 mm



Remove piston rings

Check if the piston rings are damaged or its grooves are worn.

Caution

Pay attention to remove piston rings because they are fragile.



Place piston rings respective into cylinder below 20 mm of cylinder top. In order to keep the piston rings in horizontal level in cylinder, push the rings with piston.

Service Limit: Top ring: 0.50 mm

2nd ring: 0.65 mm

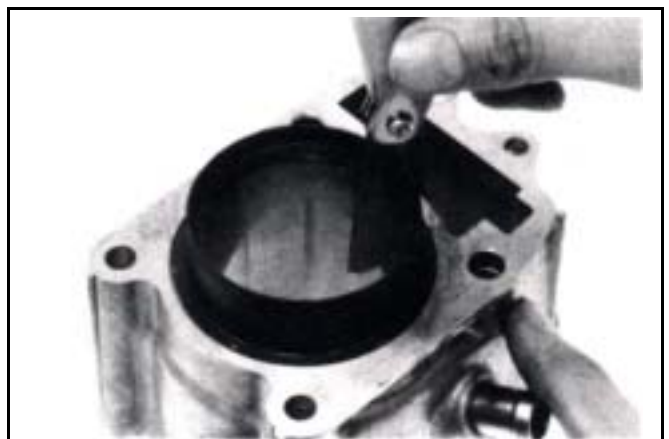

Measure the outer diameter of piston pin.

Service Limit: 16.96 mm



Measure the inner diameter of connecting rod small end.

Service Limit: 17.064 mm



Measure the inner diameter of piston pin hole.

Service Limit: 17.02 mm

Calculate clearance between piston pin and its hole.

Service Limit: 0.02 mm

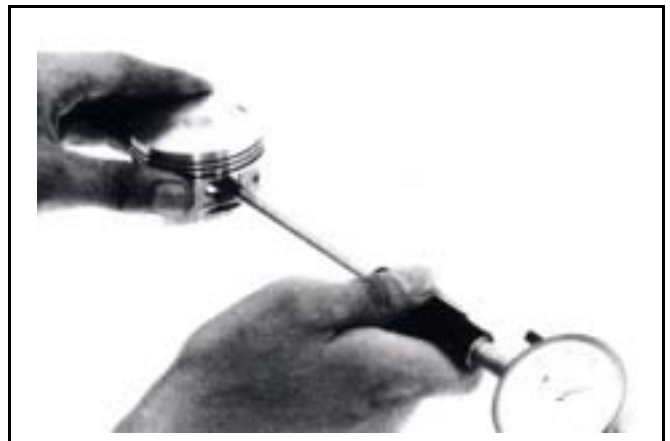

Measure piston outer diameter.

⚠ Caution

The measurement position is 10 mm distance from piston bottom side, and 90° to piston pin.

Service limit : 70.380 mm

Compare measured value with service limit to calculate the clearance between piston and cylinder.



7. Cylinder / Piston

Piston Ring Installation

Clean up piston top, ring groove, and piston surface.

Install the piston ring onto piston carefully.

Place the openings of piston ring as diagram shown.

Caution

- Do not damage piston and piston rings as installation.
- All marks on the piston rings must be forwarded to up side.
- Make sure that all piston rings can be rotated freely after installed.

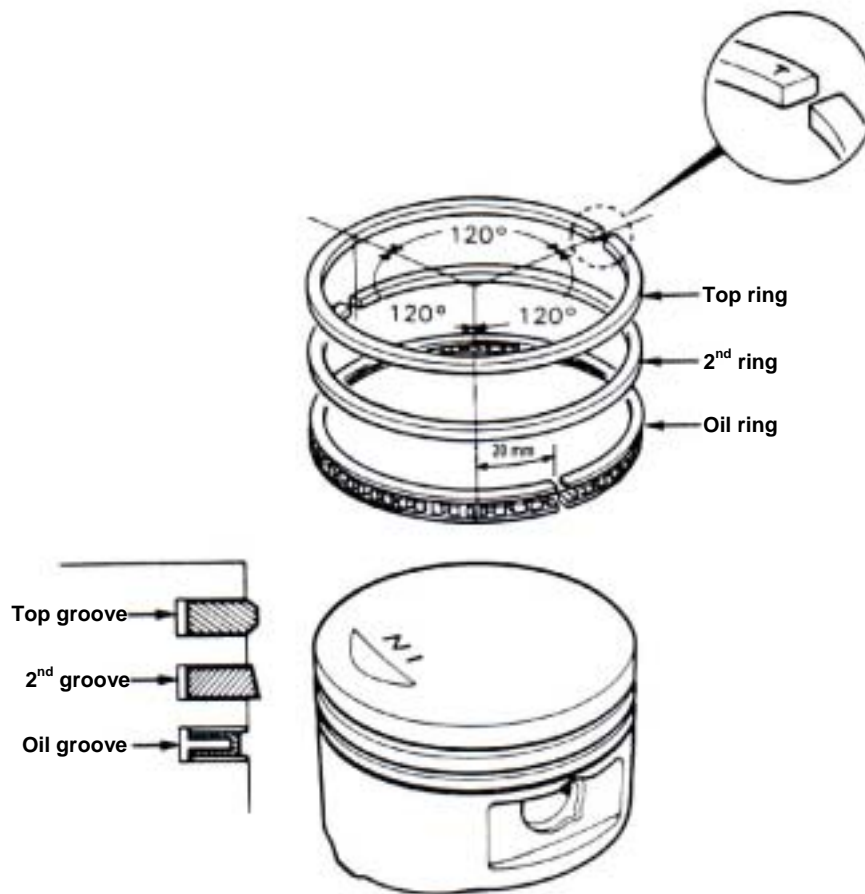

Piston Installation

Install piston and piston pin, and place the IN marks on the piston top side forward to inlet valve.

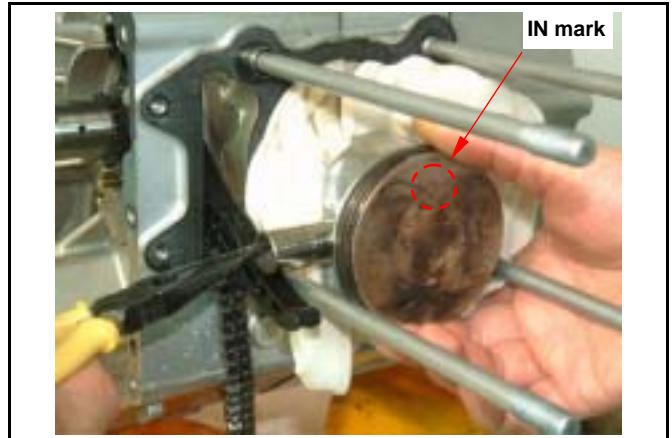

Install new piston pin clip.

Caution

- Do not let the opening of piston pin clip align with the piston cutout.
- Place a piece of cloth between piston and crankcase in order to prevent snap ring from falling into crankcase as operation.

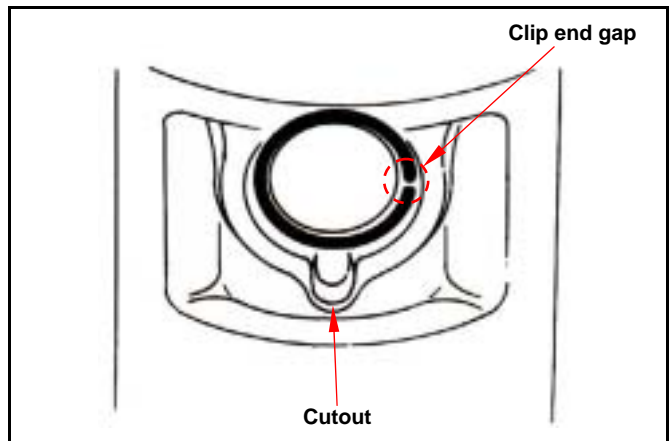

Cylinder Installation

Clean up all residues and foreign materials on the matching surface of crankcase. Pay attention to not let these residues and foreign materials fall into crankcase.

Caution

Soap the residues into solvent so that the residues can be removed more easily.



Install dowel pins and new cylinder gasket.

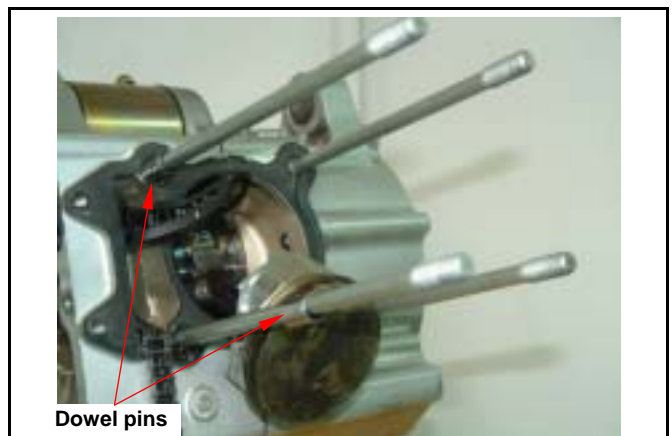

7. Cylinder / Piston

Coat some engine oil to inside of cylinder, piston and piston rings.

Care to be taken when installing piston into cylinder. Press piston rings in one by one as installation.

Caution

Do not push piston into cylinder forcefully because piston and piston rings will be damaged.



Install coolant hose onto cylinder.

Install cylinder head (refer to Chapter 6).

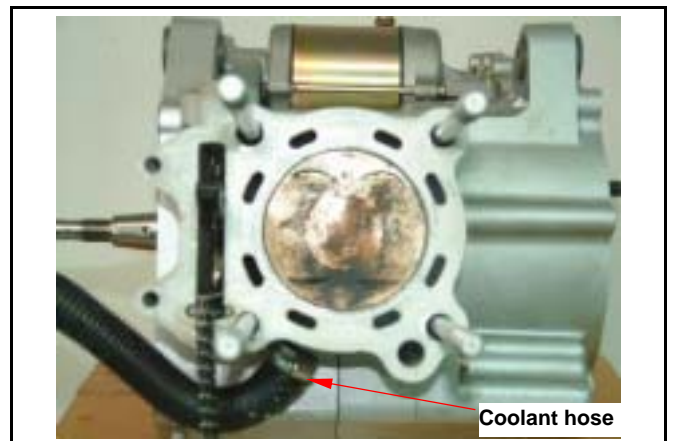

Mechanism Diagram 8-1	Drive Belt8-5
Maintenance Description..... 8-2	Drive Face.....8-7
Trouble Diagnosis 8-2	Clutch Outer / Driven Pulley.....8-10
Left Crankcase Cover 8-3	

Mechanism Diagram

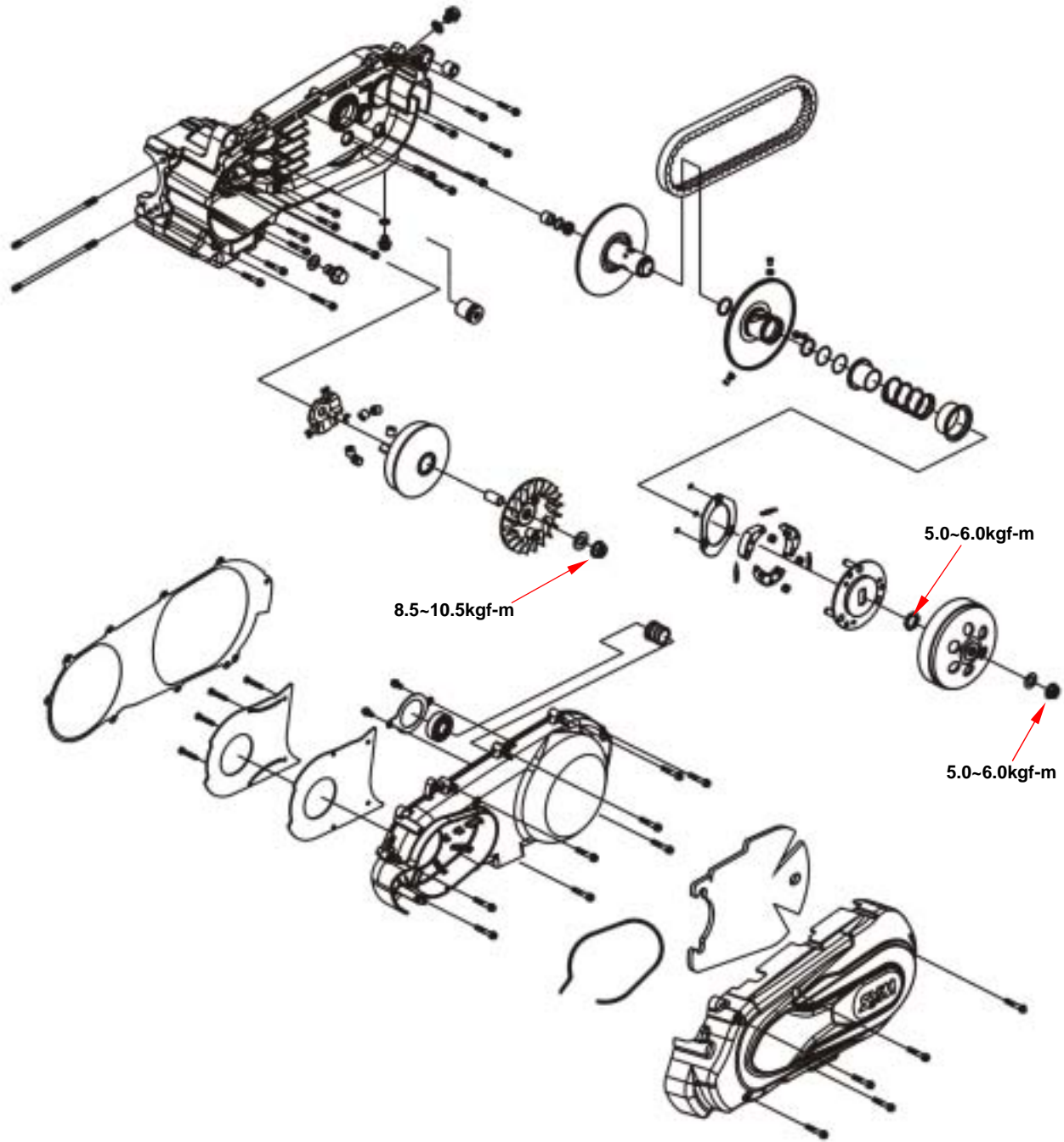

8. V-Belt Driving System

Maintenance Description

Precautions in Operation

General Information

- Drive face, clutch outer, and driven pulley can be serviced on the motorcycle.
- Drive belt and drive pulley must be free of grease.

Specification

Item	Standard value	Limit
Driving belt width	24.000 mm	22.500 mm
OD of movable drive face boss	29.946~29.980 mm	29.926 mm
ID of movable drive face	30.000~30.040 mm	30.060 mm
OD of weight roller	19.500~20.000 mm	19.000 mm
ID of clutch outer	144.850~145.150 mm	145.450 mm
Thickness of clutch weight	6.000 mm	3.000 mm
Free length of driven pulley spring	102.400 mm	97.400 mm
OD of driven pulley boss	40.950~40.990 mm	40.930 mm
ID of driven face	41.000~41.050 mm	41.070 mm
Weight of weight roller	17.700~18.300 g	17.200 g

Torque value

- Drive face nut: 8.5~10.5kgf-m
- Clutch outer nut: 5.0~6.0kgf-m
- Drive plate nut: 5.0~6.0kgf-m

Special Service Tools

Clutch spring compressor: SYM-2301000
 Inner bearing puller: SYM-6204002
 Clutch nut wrench 39 x 41 mm: SYM-9020200
 Universal holder: SYM-2210100
 Bearing driver: SYM-9100100

Trouble Diagnosis

Engine can be started but motorcycle can not be moved

1. Worn drive Belt
2. Worn drive face
3. Worn or damaged clutch weight
4. Broken driven pulley

Insufficient horsepower or poor high speed performance

1. Worn drive belt
2. Insufficient spring force of driven pulley
3. Worn roller
4. Driven pulley operation un-smoothly

Shudder or misfire when driving

1. Broken clutch weight
2. Worn clutch weight

Left Crankcase Cover

Left crankcase cover removal

Loosen 4 bolts from left side crank out cover & remove it.

Remove left crankcase cover. (8 bolts)

Remove 2 dowel pin and gasket.

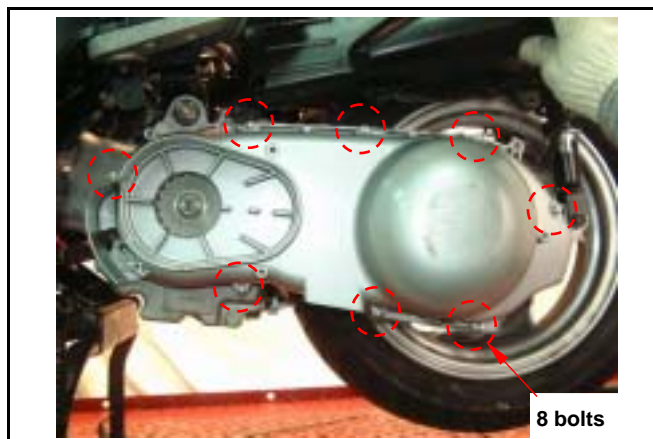

Left crankcase cover install

Install left crankcase cover in the reverse procedures of removal.

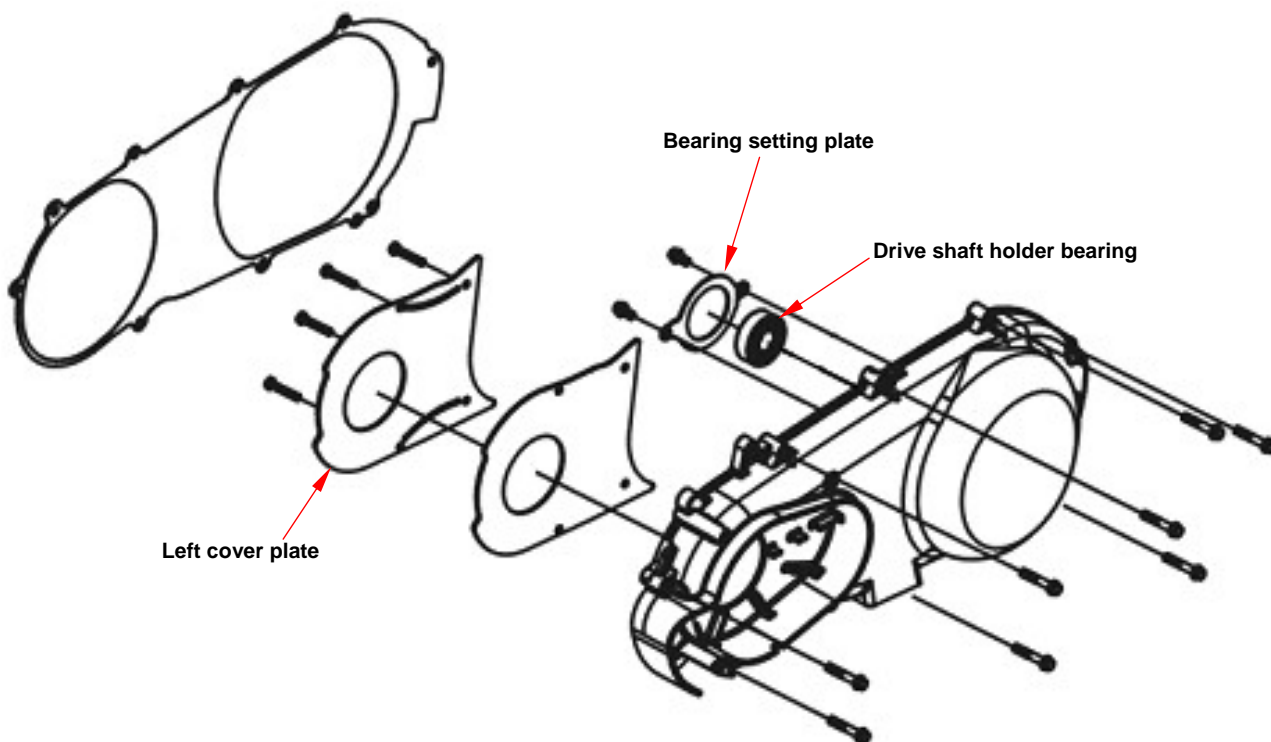

8. V-Belt Driving System

Left crankcase cover inspection

Remove 2 bolts to remove left crankcase cover bearing setting plate.

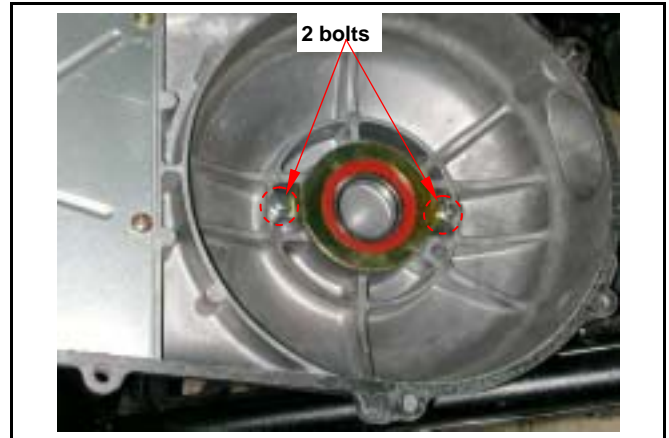

Check bearing on left crankcase cover. Rotate bearing's inner ring with fingers. Check if bearings can be turned in smooth and silent, and also check if bearing outer ring is mounted on cover tightly. If bearing rotation is uneven, noising, or loose bearing mounted, then replace it.



Bearing replacement

Remove bearing with special service tools

Special tools:

Inner bearing puller SYM-6204022



Install bearing with special service tools.

Special tools:

Right crank case bearing 6201 assemblies tool
SYM-9614000-HMA 6201



Drive Belt

Removal

Remove left crankcase cover.

Hold drive face with universal holder, and remove nut and drive face.

Special Tool : universal holder



Hold clutch outer with universal holder, and remove nut, bearing stay collar and clutch outer.

Caution

- Using special service tools for tightening or loosening the nut.
- Fixed rear wheel or rear brake will damage reduction gear system.

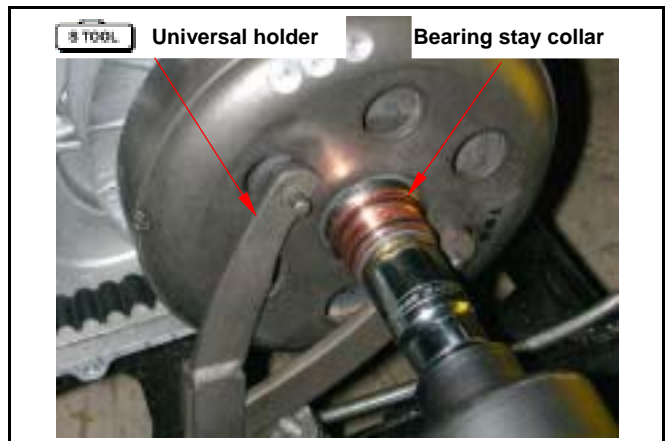

Push the drive belt into belt groove as diagram shown so that the belt can be loosened, and then remove the driven pulley.
Remove driven pulley. Do not remove drive belt.
Remove the drive belt from the groove of driven pulley.

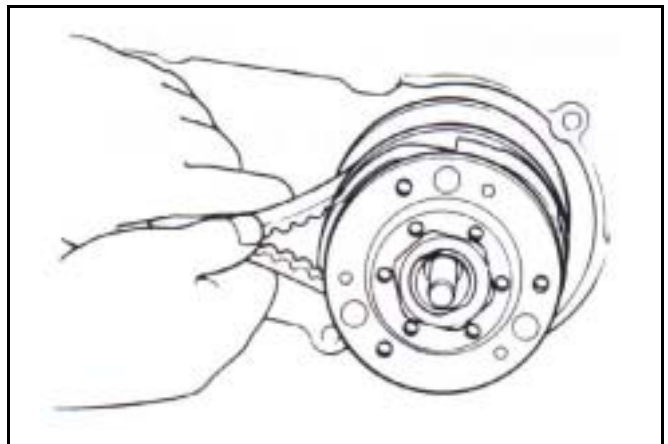

Inspection

Check the drive belt for crack or wear. Replace it if necessary.

Measure the width of drive belt as diagram shown.

Service Limit: 22.5 mm

Replace the belt if exceeds the service limit.

Caution

- Using the genuine parts for replacement.
- The surfaces of drive belt or pulley must be free of grease.
- Clean up all grease or dirt before installation.

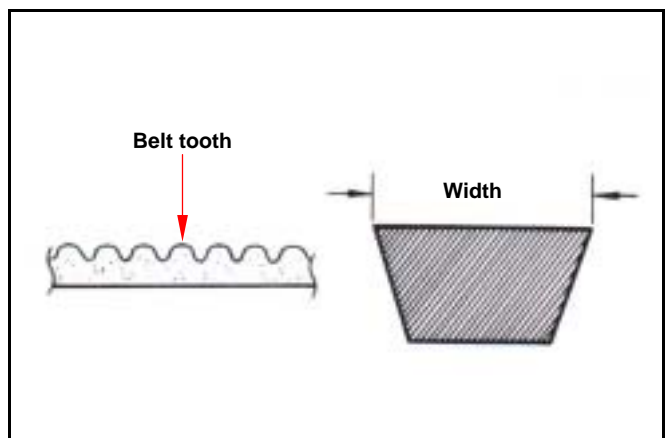

8. V-Belt Driving System

Installation

Caution

- Pull out driven face to avoid it closing.
- Cannot oppress friction plate comp in order to avoid creates the distortion or the damage.

Install drive belt onto driven pulley.

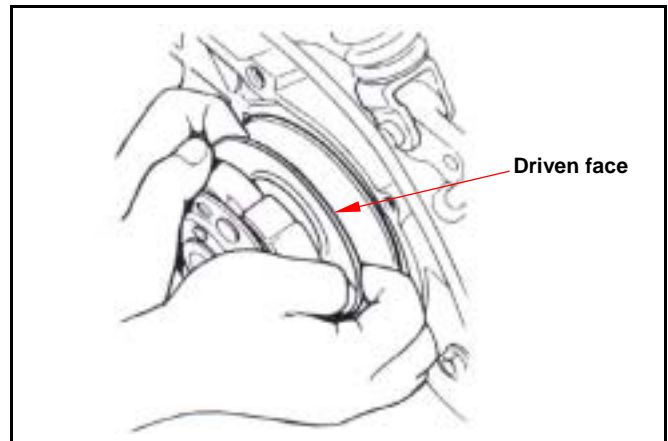

Install the driven pulley that has installed the belt onto drive shaft.

On the drive belt another end to the movable drive face.

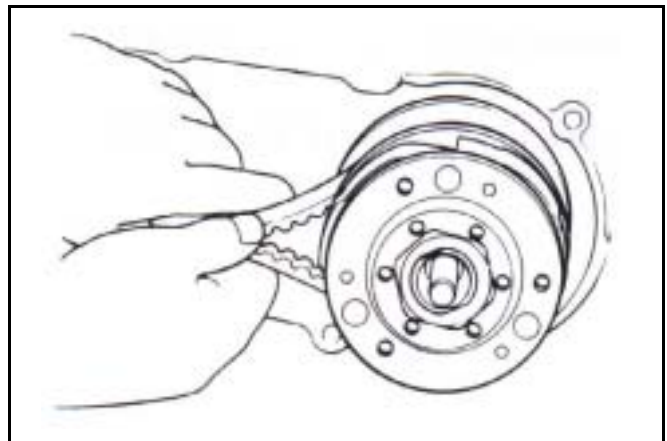

Install the clutch outer and bearing stay collar. Hold the clutch outer whit universal holder, and then tighten nut to specified torque value.

Torque value: 5.0~6.0kgf-m

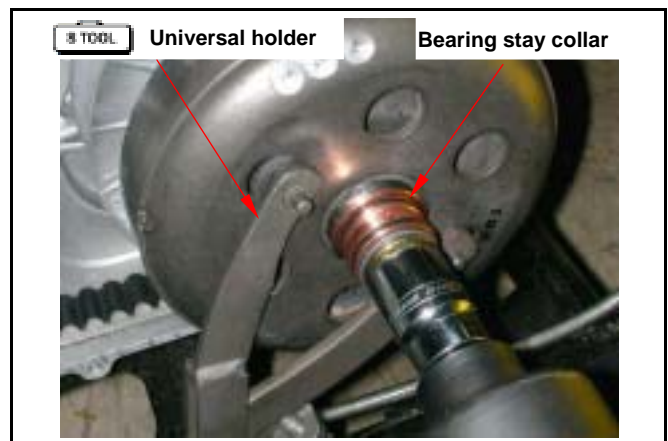

Install the drive face, washer and drive face nut. Hold drive face with universal holder, and then tighten nut to specified torque value.

Torque value: 8.5~10.5kgf-m



Drive Face

Removal

Remove left crankcase cover.
 Hold drive face with universal holder, and then
 remove drive face nut.
 Remove drive face and drive belt.



Remove movable drive face comp and drive face
 boss from crankshaft.

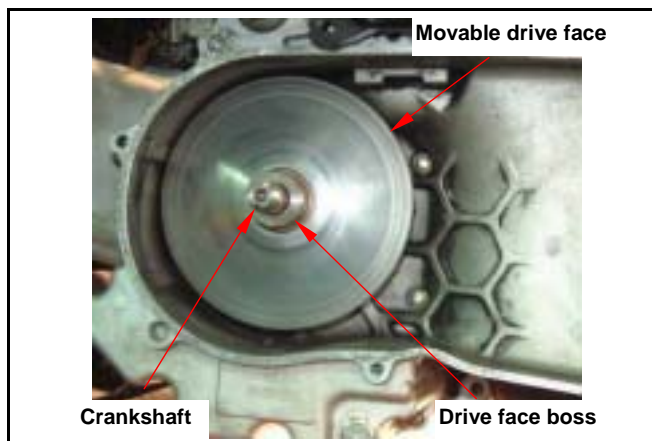

Remove ramp plate.



Remove weight rollers from movable drive face.

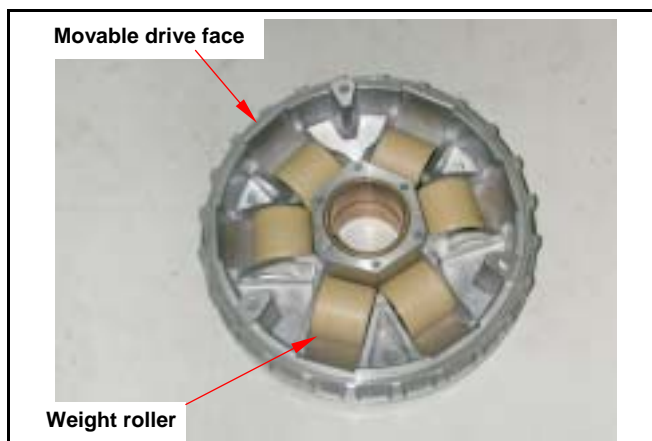

8. V-Belt Driving System

Inspection

The weight rollers are to press movable drive face by means of centrifuge force.

Thus, if weight rollers are worn out or damaged, the centrifuge force will be affected.

Check if rollers are worn or damaged. Replace it if necessary.

Measure each roller's outer diameter. Replace it if exceed the service limit.

Service limit: 19.0 mm

Weight: 17.2g

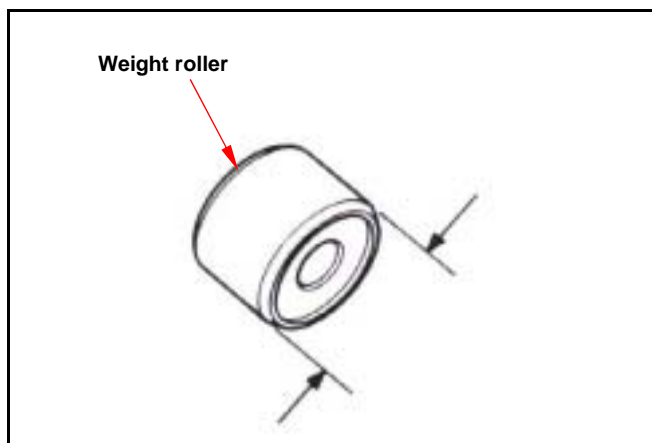

Check if drive face boss is worn or damaged and replace it if necessary.

Measure the outer diameter of movable drive face boss, and replace it if it exceed service limit.

Service limit: 29.962 mm

Measure the inner diameter of movable drive face, and replace it if it exceed service limit.

Service limit: 30.060 mm

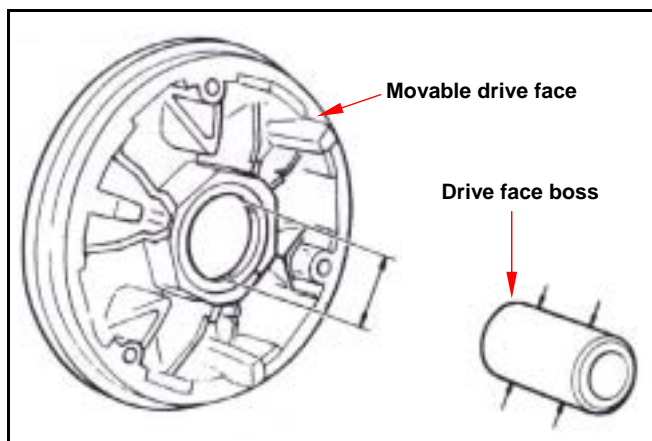

Reassembly/installation

Install weight rollers.

Caution

- The weight roller two end surfaces are not certainly same. In order to lengthen the roller life and prevented exceptionally wears the occurrence, Please end surface of the closure surface counter clockwise assembles onto movable drive face.

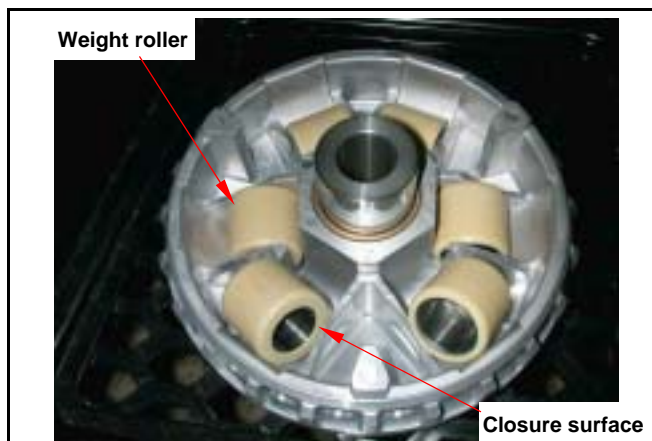

Install ramp plate.

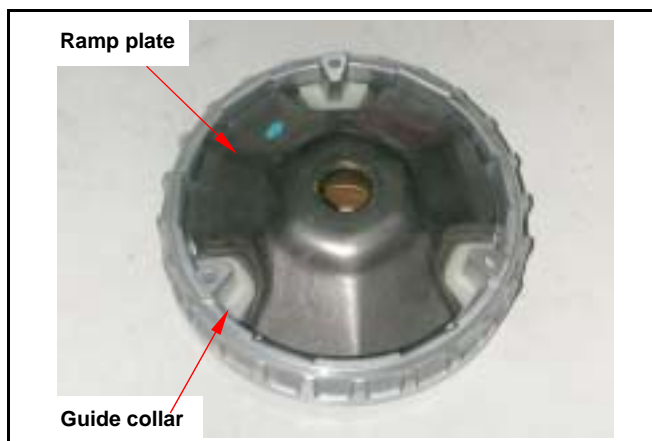

With 4~5g grease spreads wipes drives in the movable drive face axis hole.
Install drive face boss.

⚠ Caution

- The movable drive face surface has to be free of grease. Clean it with cleaning solvent.

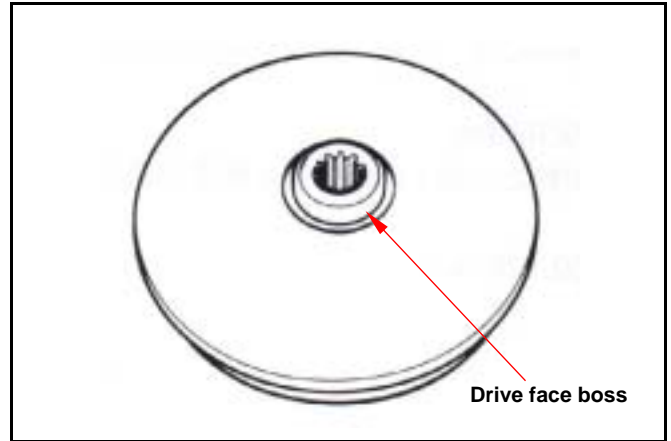

Install movable drive face comp. onto crankshaft.

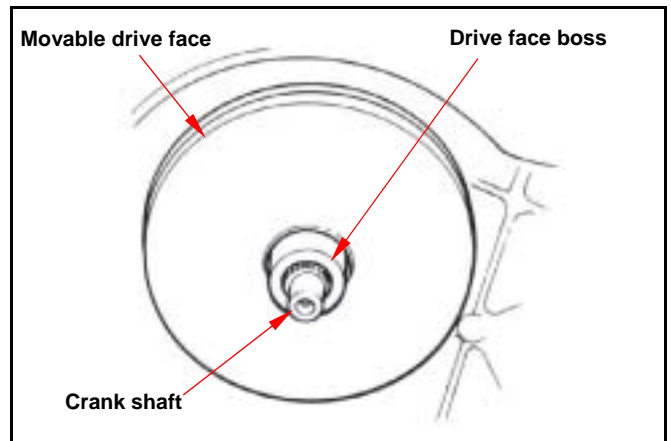

Driven pulley installation

Press drive belt into pulley groove, and then pull the belt onto drive shaft.

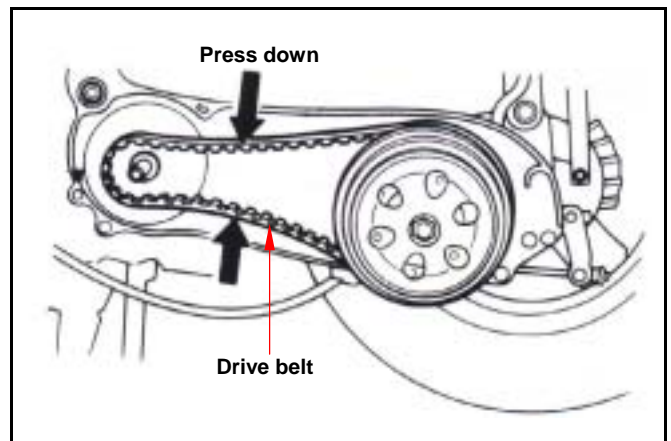

Install drive face, washer and nut.

⚠ Caution

- Make sure that two sides of pulley surfaces have to be free of grease. Clean it with cleaning solvent.

Hold drives face with universal holder.
Tighten nut to specified torque.

Torque value: 8.5~10.5kgf-m
Install left crankcase cover.



8. V-Belt Driving System

Clutch Outer/Driven Pulley

Disassembly

Remove drive belt, clutch outer and driven pulley. Install clutch spring compressor onto the pulley assembly, and operate the compressor to let the wrench be installed more easily.

⚠ Caution

- Do not press the compressor too much.

Hold the clutch spring compressor onto bench vise, and then remove mounting nut with special service tool.

Release the clutch spring compressor and remove friction plate, clutch weight and spring from driven pulley.

Remove seal collar from driven pulley.

Remove guide pin, guide pin roller, and movable driven face, and then remove O-ring & oil seal seat from movable driven face.

Inspection

Clutch outer

Measure the inner diameter of clutch outer. Replace the clutch outer if exceed service limit.

Service limit: 145.450 mm

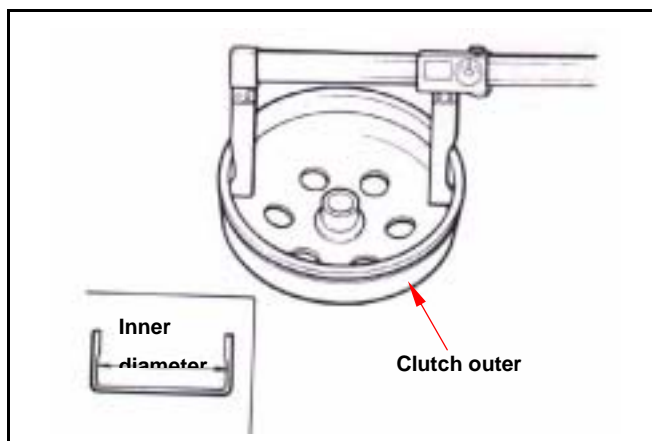
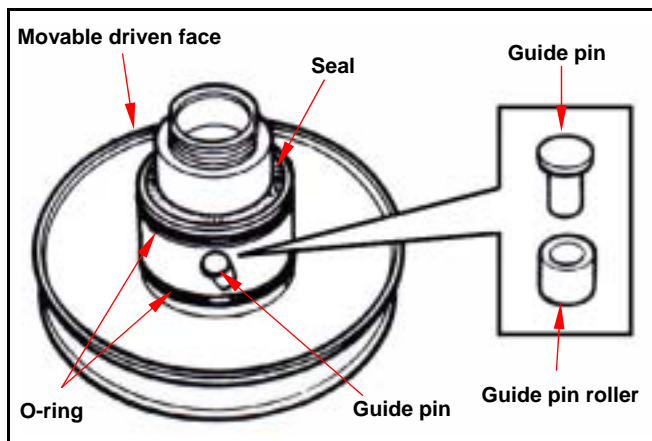
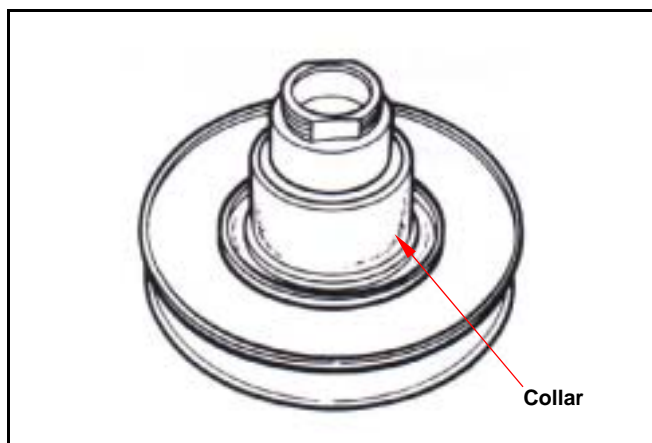
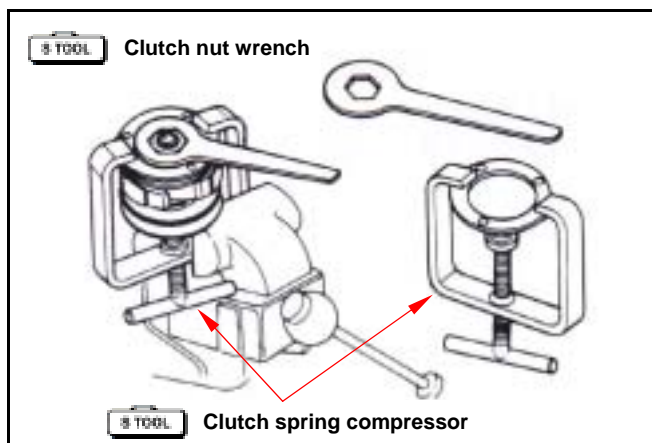

Clutch lining

Measure each clutch weight thickness. Replace it if exceeds service limit.

Service limit: 3.0 mm

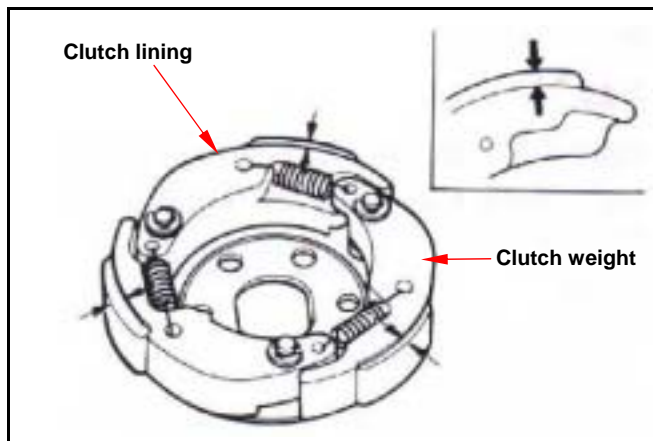

Driven pulley spring

Measure the length of driven pulley spring. Replace it if exceeds service limit.

Service limit: 97.400 mm

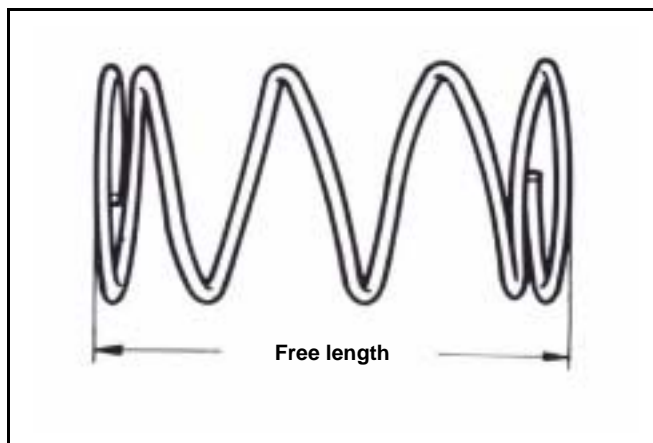

Driven pulley

Check following items:

- If both surfaces are damaged or worn.
- If guide pin groove is damaged or worn.

Replace damaged or worn components.

Measure the outer diameter of driven face and the inner diameter of movable driven face. Replace it if exceeds service limit.

Service limit: Outer diameter 40.93 mm

Inner diameter 41.07 mm

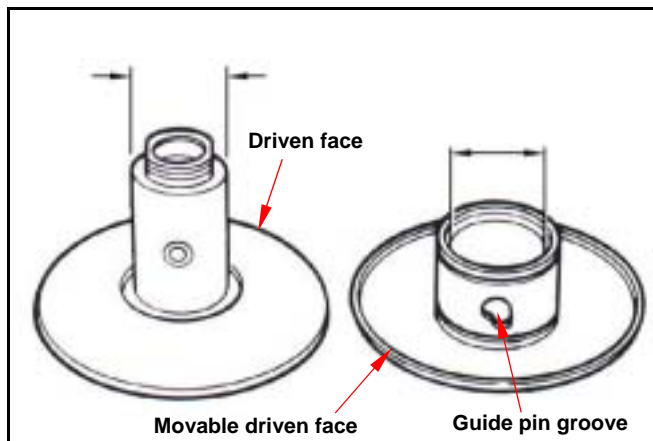

Driven Pulley Bearing Inspection

Check if the inner bearing oil seal is damage. Replace it if necessary.

Check if needle bearing is damage or too big clearance. Replace it if necessary.

Rotate the inside of inner bearing with fingers to check if the bearing rotation is in smooth and silent.

Check if the bearing outer parts are closed and fixed. Replace it if necessary.

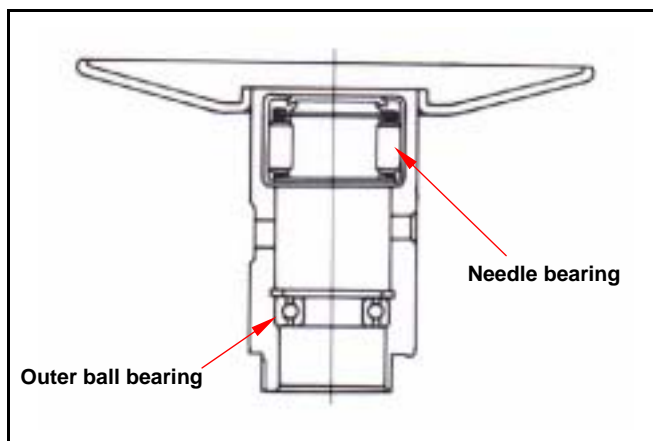

8. V-Belt Driving System

Clutch weight Replacement

Remove snap ring and washer, and then remove clutch weight and spring from driving plate.

Caution

- Some of models are equipped with one mounting plate instead of 3 snap rings.

Check if spring is damage or insufficient elasticity.

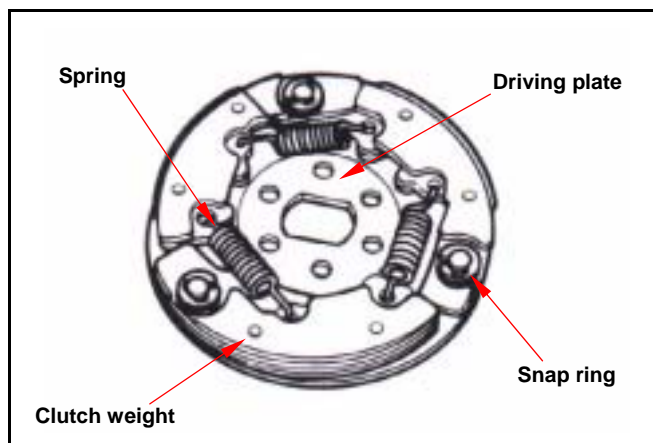

Check if shock absorption rubber is damage or deformation. Replace it if necessary. Apply with grease onto setting pins.

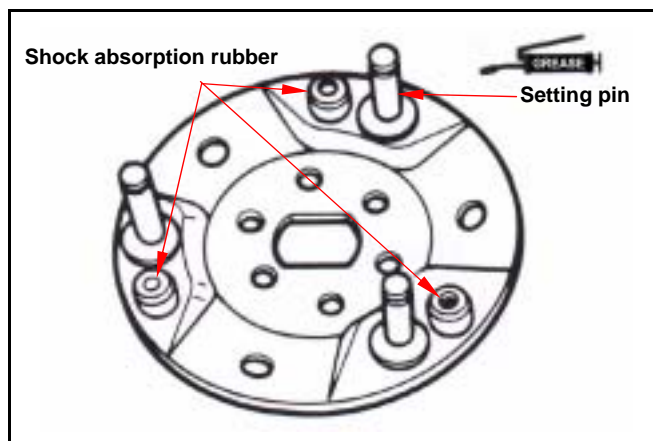

Install new clutch weight onto setting pin and then push to the specified location. Apply with grease onto setting pins. But, the clutch block should not be greased. If so, replace it.

Caution

- Grease or lubricant will damage the clutch weight and affect the block's connection capacity.

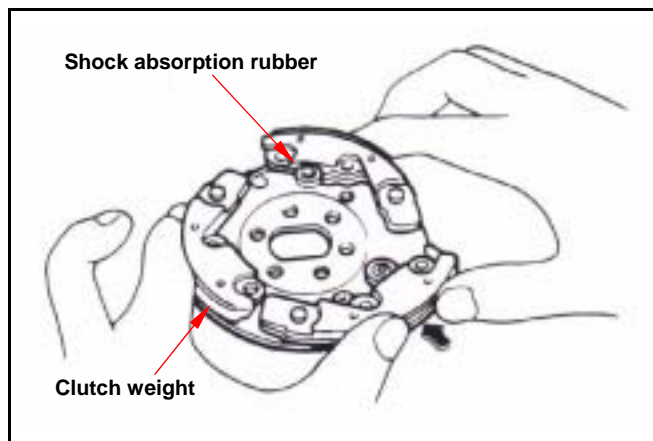

Install the spring into groove with pliers.

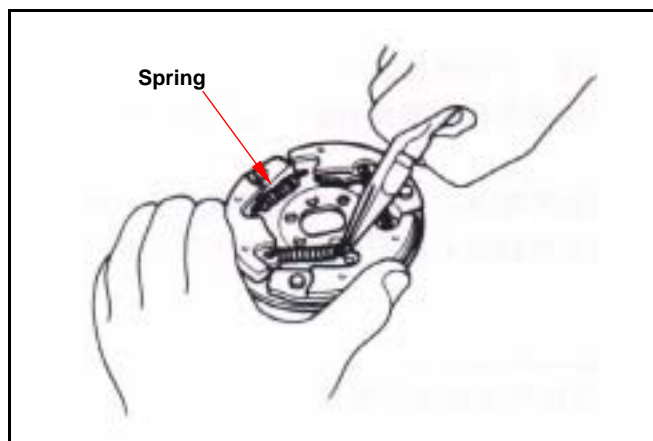

Install snap ring and mounting plate onto setting pin.

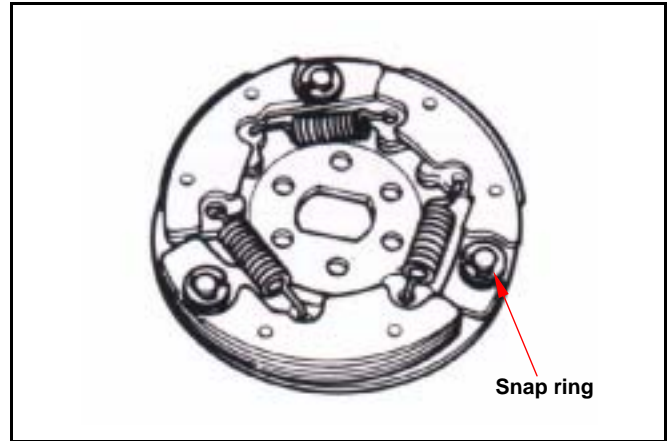

Replacement of Driven Pulley Bearing

Remove inner bearing.

Caution

- If the inner bearing equipped with oil seal on side in the driven pulley, then remove the oil seal firstly.
- If the pulley equipped with ball bearing, it has to remove snap ring and then the bearing.

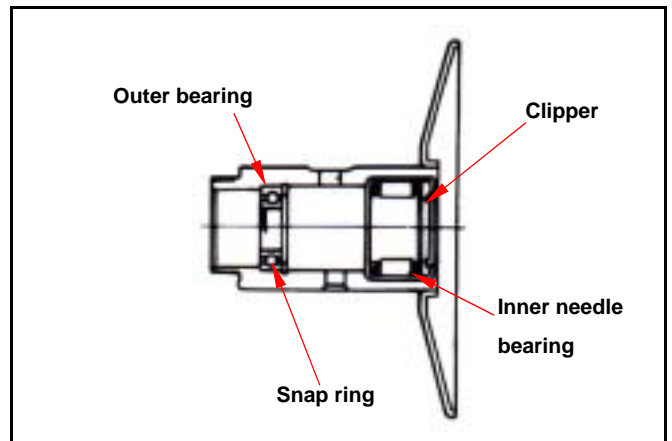

Remove snap ring and then push bearing forward to other side of inner bearing.

Place new bearing onto proper position and its sealing end should be forwarded to outside.

Apply with specified oil.

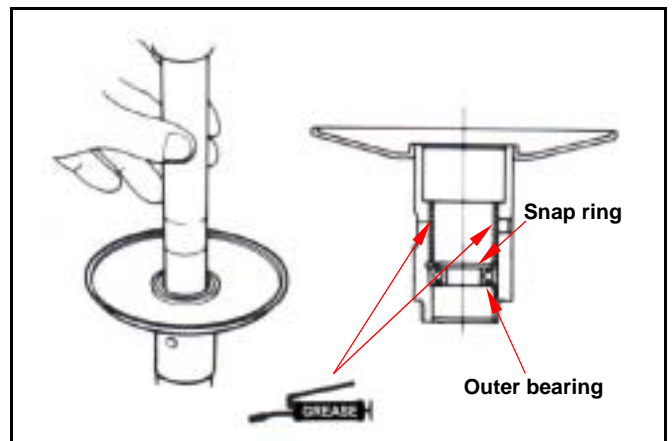

Install new inner bearing.

Caution

- Its sealing end should be forwarded to outside as bearing installation.
- Install needle bearing with hydraulic presser. Install ball bearing by means of hydraulic presser.

Install snap ring into the groove of drive face.

Align oil seal lip with bearing, and then install the new oil seal (if necessary).

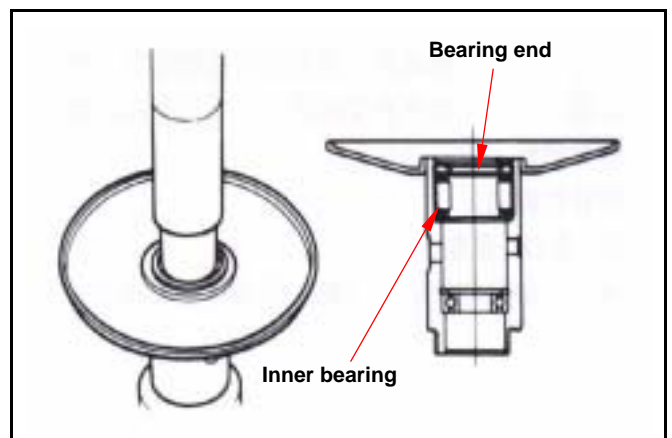

8. V-Belt Driving System

Installation of Clutch OUTER/Driven Pulley Assembly

Install new oil seal and O-ring onto movable driven face.

Apply with specified grease to lubricate the inside of movable driven face.

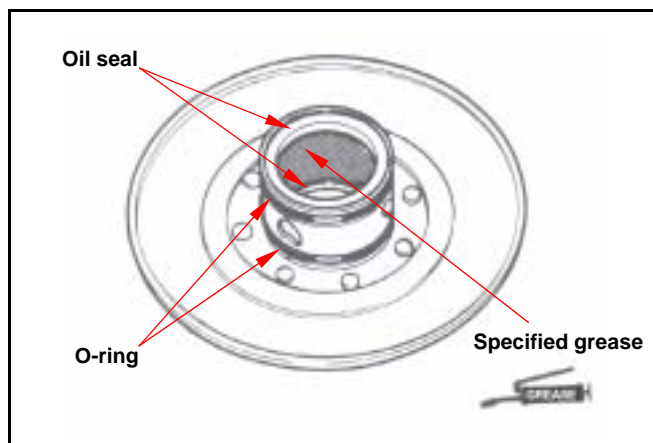

Install the movable driven face onto driven face.
Install the guide pin and guide pin roller.

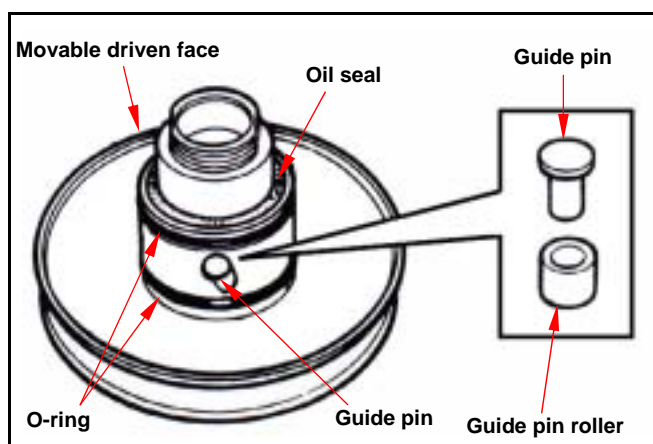

Install the collar.

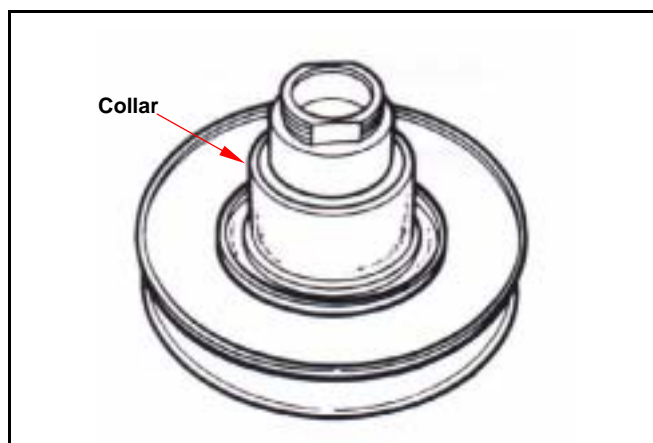

Install friction plate, spring and clutch weight into clutch spring compressor, and press down the assembly by turning manual lever until mounting nut that can be installed.

Hold the compressor by bench vise and tighten the mounting nut to specified torque with clutch nut wrench.

Remove the clutch spring compressor.

Torque value: 5.0~6.0kgf-m

Install clutch outer/driven pulley and drive belt onto drive shaft.

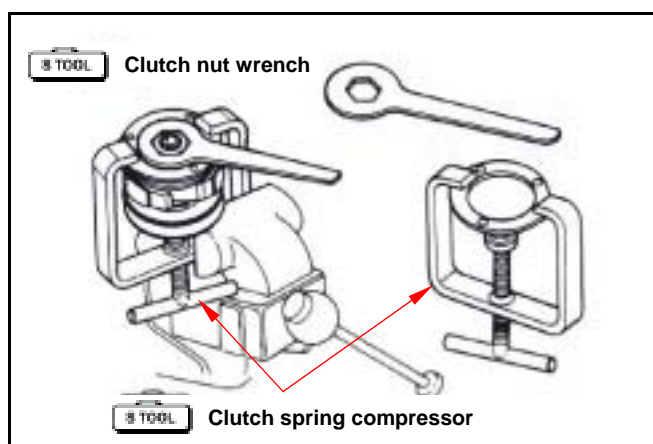

Mechanism Diagram.....	9-1	Inspection of Final Driving Mechanism	9-4
Precautions in Operation	9-2	Bearing Replacement	9-5
Trouble Diagnosis	9-2	Re-Assembly of Final Driving Mechanism	9-8
Disassembly of Final Driving Mechanism	9-3		

Mechanism Diagram

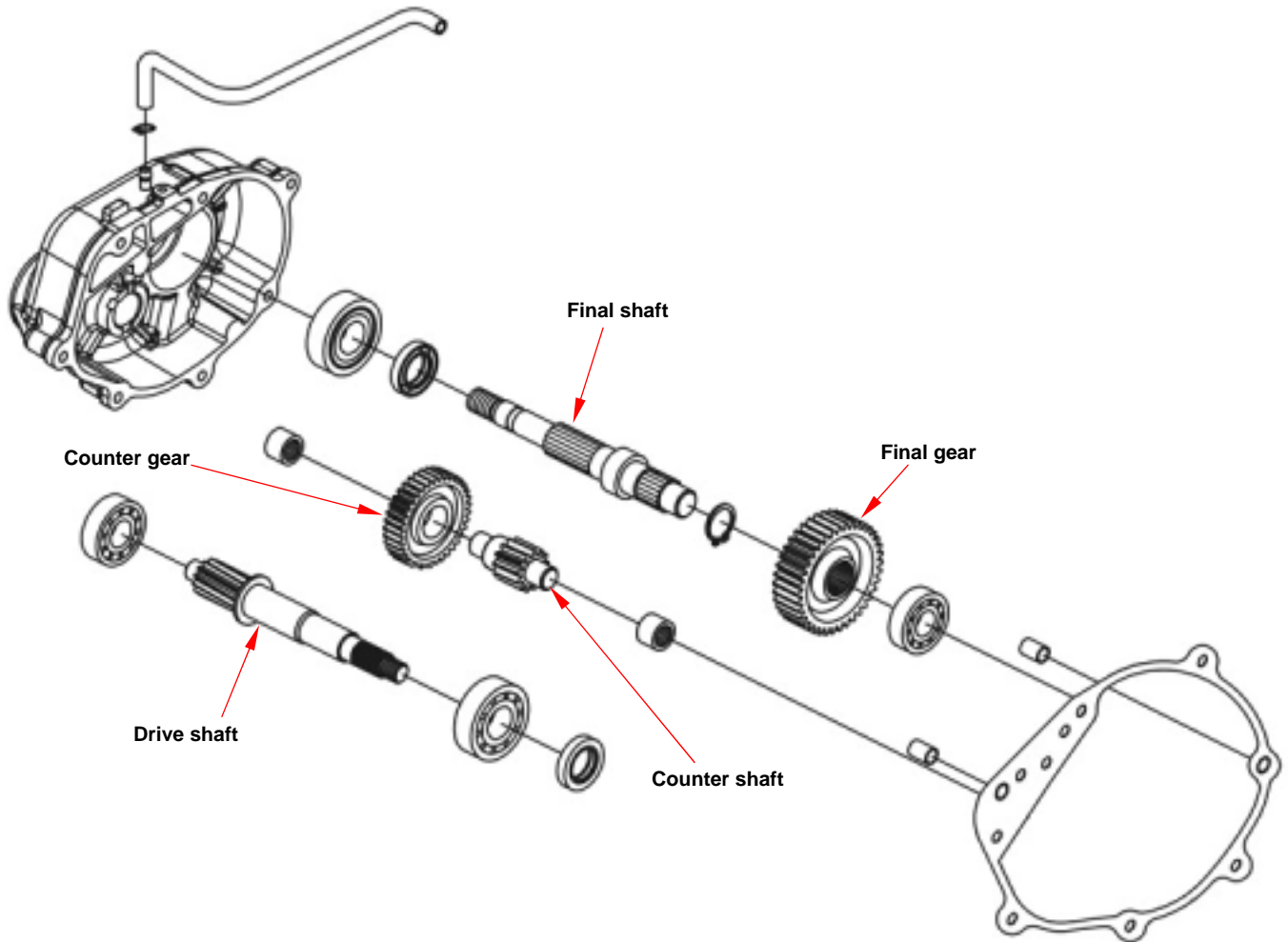

9. Final Driving Mechanism

Precautions in Operation

Specification

Application oil: scooter gear oil

Recommended oil: KING MATE serial gear oils

Oil quantity: 180 c.c. (170 c.c. when replacing)

Torque value

Gear box cover 2.6~3.0kgf-m

Special tools

Bearing (6205) driver	SYM-9615000-6205
Bearing (6205) puller	SYM-9100400 HMA RA1 6205
Bearing (6203) driver	SYM-9620000
Drive shaft & oil seal (25*40*8) socket	SYM-9120200-HMA
Bearing (HK1516) driver	SYM-9100200-HMA HK1516
Bearing (6204) driver	SYM-9110400-6204
Oil seal drive 34*52*5	SYM-9125500-HMA
Inner bearing puller	SYM-6204020 or SYM-6204021
Outer bearing puller	SYM-6204001

Trouble Diagnosis

Engine can be started but motorcycle can not be moved.

- Damaged driving gear
- Burnt out driving gear
- Damaged driving belt.

Noise

- Worn or burnt gear
- Worn gear

Gear oil leaks

- Excessive gear oil.
- Worn or damage oil seal

Disassembly of Final Driving Mechanism

Remove the rear wheel.
 Remove the clutch.
 Drain out gear oil from gear box.
 Loosen 7 bolts and remove gear box cover bolts.

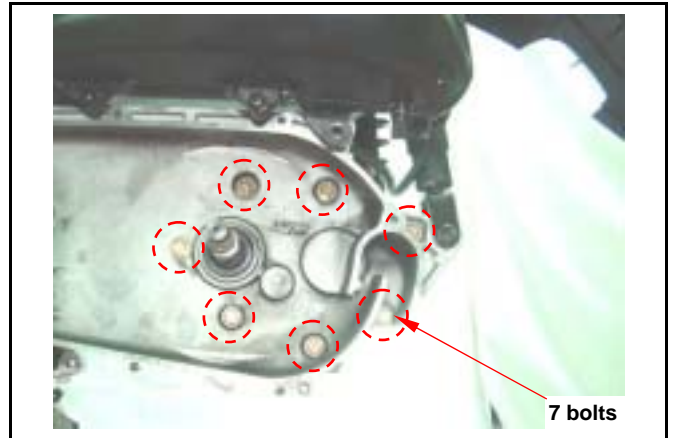

Remove the gear box cover, counter shaft and final shaft.
 Remove the gasket & dowel pin.

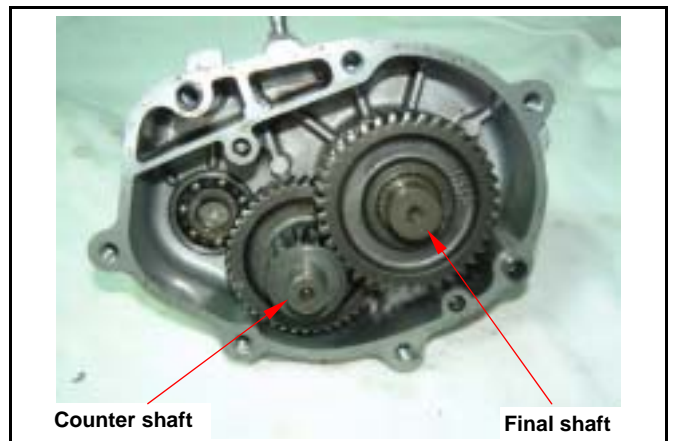

Remove final gear.
 Remove counter shaft, gear and 2 washers.
 Remove final shaft.



Remove the drive shaft.

Special tool:
Shaft protector

Caution

- If non- essential do not remove the drive shaft from the cover upper side.
- If remove the drive shaft from the gear box cover, then its bearing has to be replaced.



9. Final Driving Mechanism

Inspection of Final Driving Mechanism

Check if the drive shaft are burn, wear or damage and replace it if necessary.

Caution

- If remove the drive shaft from the gear box upper side, then its bearing has to be replaced.

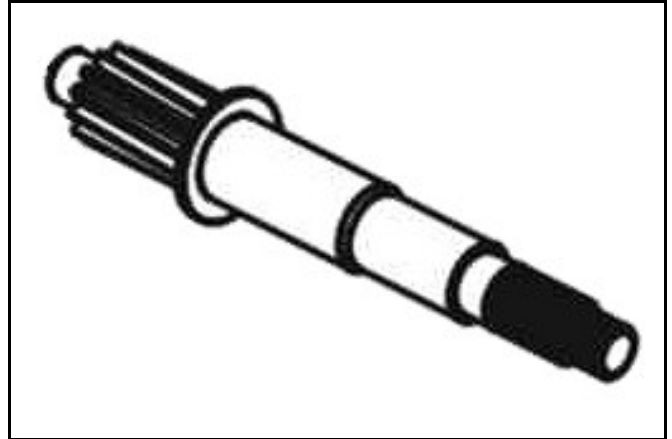

Check if the countershaft is wear or damage and replace it if necessary.

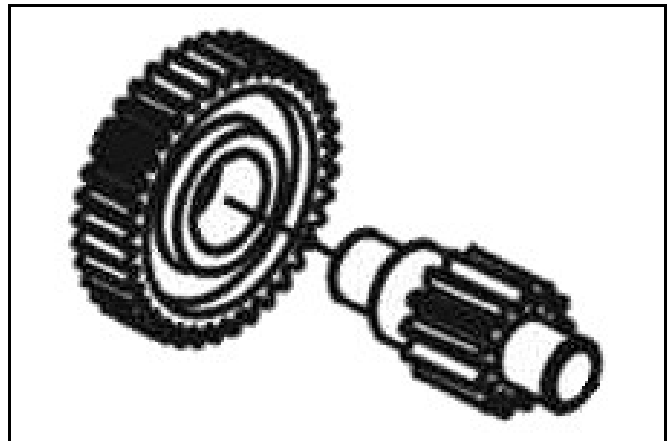

Check if the final shaft and gear are burn, wear or damage and replace it if necessary.

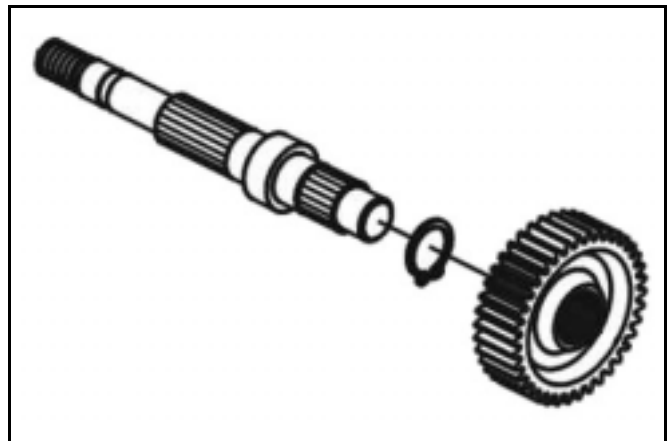

Check bearings on gear box cover.
 Rotate each bearing's inner ring with fingers.
 Check if bearings can be turned in smooth and silent, and also check if bearing outer ring is mounted on gear tightly.
 If bearing rotation is uneven, noising, or loose bearing mounted, then replace it.
 Check oil seal for wear or damage, and replace it if necessary.
 Check gear box bearing as the same way above, and replace it if necessary.

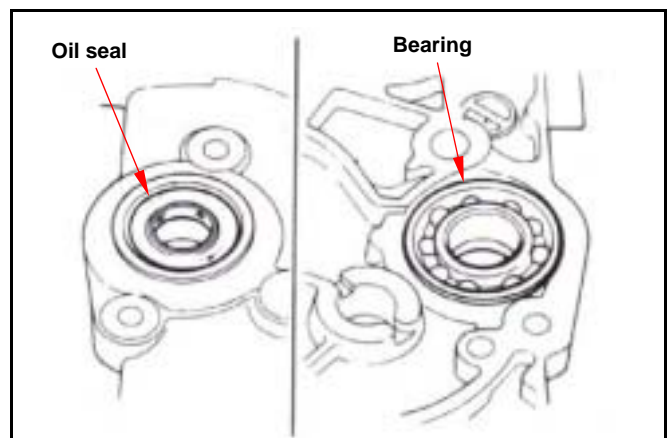

Bearing Replacement

Left crankcase side

If the drive shaft is pulled out with its bearing, then remove the bearing with bearing puller and shaft protector.

Special tool:

Multi-functional bearing puller or Outer bearing puller SYM-6204001
Shaft protector SYM-6204010



Remove final shaft bearing and counter shaft bearing from left crankcase using following tools.

Special tool:

Inner bearing puller SYM-6204020 or SYM-6204021



⚠ Caution

- Never install used bearings. Once bearing removed, it has to be replaced with new one.

Install new final shaft bearing and counter shaft bearing into left crankcase.

Special tool:

Bearing driver 6205 SYM-9615000-6205
Bearing driver HK1516 SYM-9100200-HK1516



Install new drive shaft bearing and bearing puller onto left crankcase.

Special tool:

Bearing puller 6205 SYM-9100400-6205



9. Final Driving Mechanism

Install assembly directs puller bearing puller.

Special Service Tools:

Assembly directs puller **SYM-2341110**

Use screw driver hold bearing puller lower part, and turn the bearing puller upper part to install the drive shaft bearing.

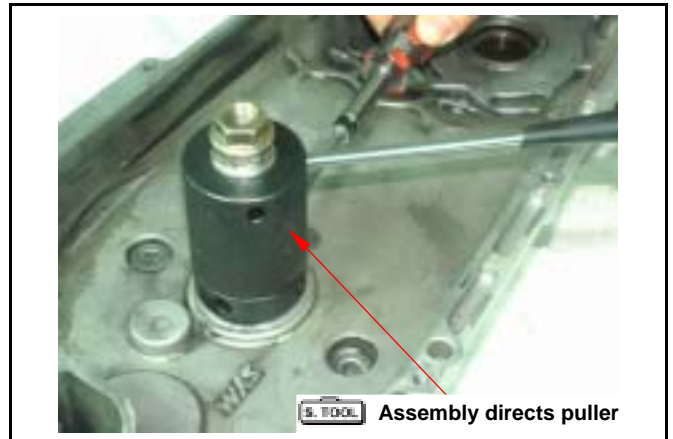

Gear box cover side

Remove drive shaft bearing and counter shaft bearing from gear box cover using following tools.

Special tool:

Inner bearing puller **SYM-6204020** or
SYM-6204021



Remove oil seal, and then remove final shaft bearing from gear box cover using following tools.

Special tool:

Inner bearing puller **SYM-6204022**

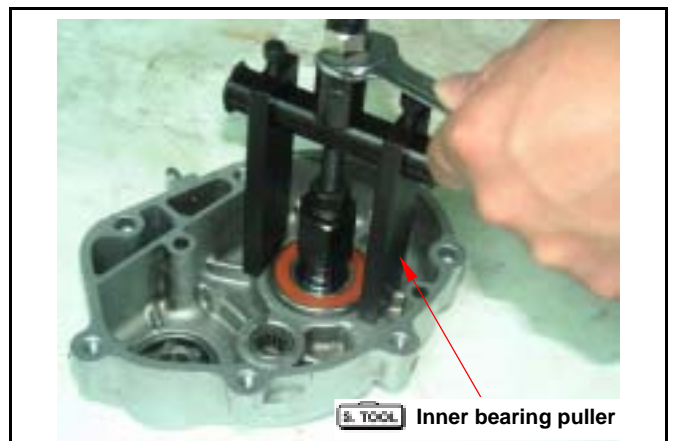

Install a new drive shaft bearing and counter shaft bearing into gear box cover.



Install new final shaft bearing and bearing puller onto left crankcase.

Special tool:

Bearing puller 6205 SYM-9100400-6205

Install assembly directs puller bearing puller.

Special Service Tools:

Assembly directs puller SYM-2341110



Use screw driver holder bearing puller lower part, and turn the bearing puller upper part to install the final shaft bearing.

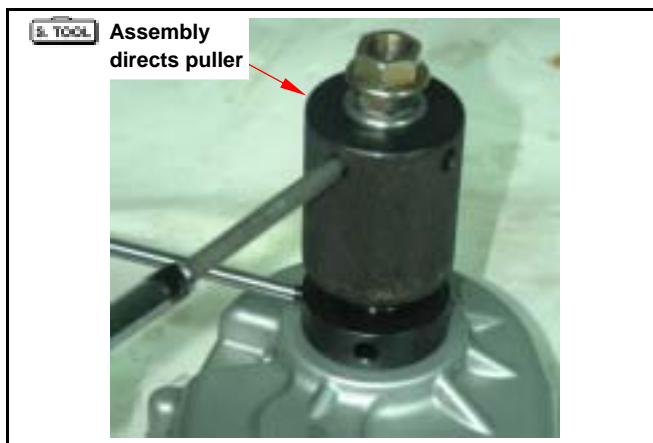

Apply with grease onto final shaft oil seal.
Install the oil seal into gear box cover.

Special tool:

Oil seal driver 34*52*5 SYM-9125500-HMA



9. Final Driving Mechanism

Re-Assembly of Final Driving Mechanism

Install drive shaft.

Special tool:

Drive shaft puller SYM-2341110- HMA RB1

Drive shaft socket & oil seal driver (25*40*8)

SYM-9120200-HMA

Clutch nut wrench SYM-9020200

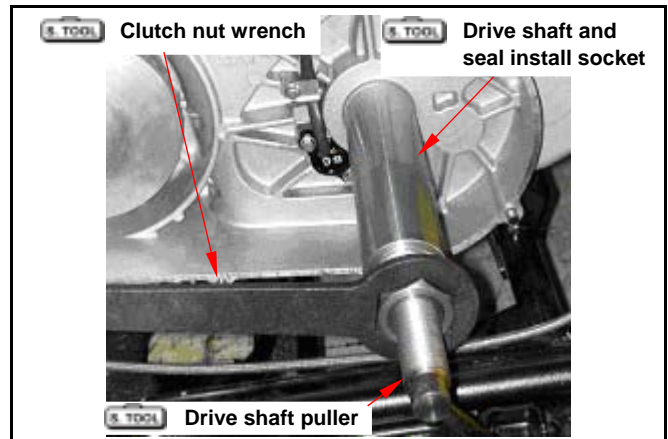

Apply with grease onto drive shaft oil seal.

Install the oil seal to left crankcase.

Special tool:

Drive shaft socket & oil seal driver (25*40*8)

SYM-9120200-HMA



Apply with grease onto the oil seal lip of final shaft.

Install counter shaft and final shaft into the gear box cover.

Install 2 dowel pins & new gasket.

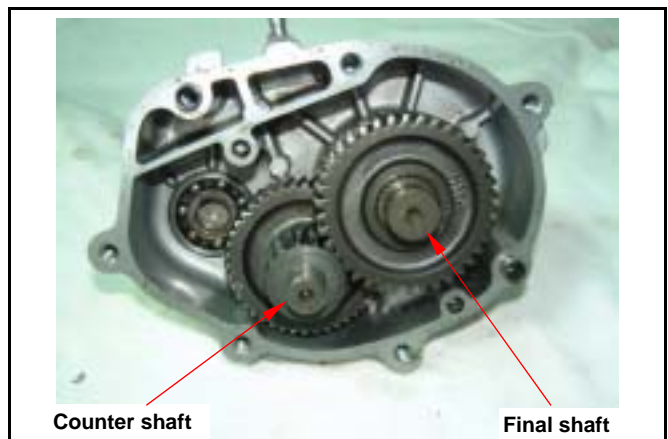

Install the gear box and tighten the bolts (7 bolts).

Torque value: 2.6~3.0kgf-m

Install driven pulley / clutch outer / belt.

Install movable drive face, drive face and left crankcase cover.

Install rear wheel.

Add gear oil.

Gear oil quantity: 180c.c.

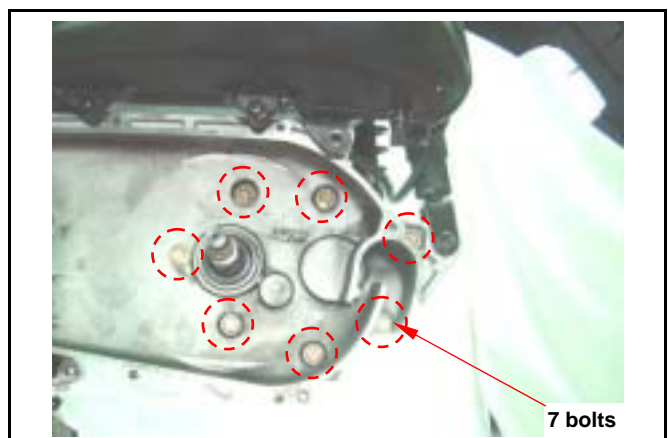

Mechanism Diagram10-1	Flywheel Removal 10-5
Precautions in Operation10-2	Starting Clutch..... 10-6
Right Crankcase Cover Removal10-3	AC.G. Flywheel Installation 10-8
AC.G. Set Removal10-4	AC.G. Set Installation 10-9
Right Cover Bearing10-4	Right Crankcase Cover Installation .. 10-9

Mechanism Diagram

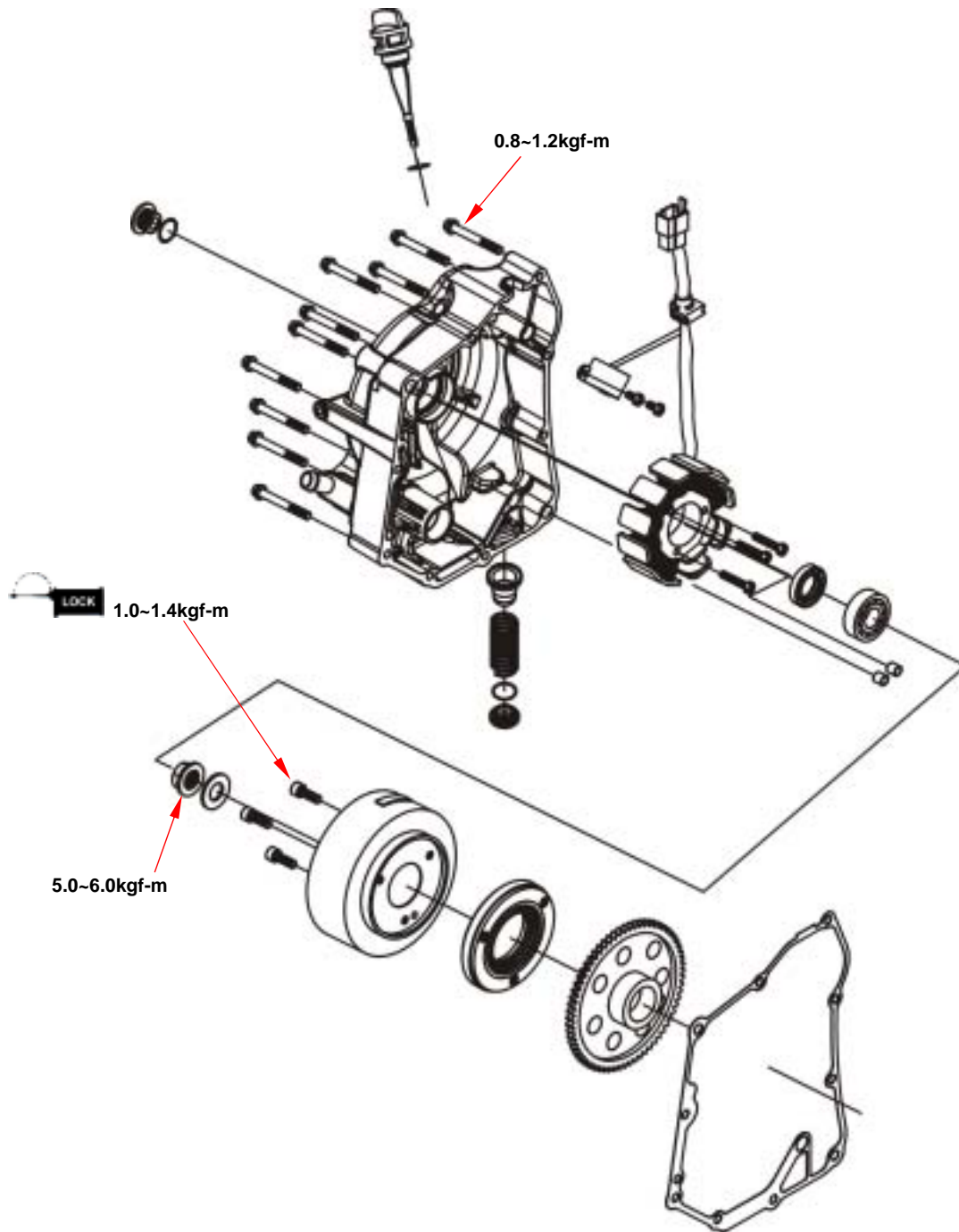

10. Alternator / Starting Clutch

Precautions in Operation

General information

- Refer to chapter 17: The troubleshooting and inspection of alternator.
- Refer to chapter 17: The service procedures and precaution items of starter motor.

Specification

Item	Standard value (mm)	Limit (mm)
ID of starting clutch gear	25.026~25.045	25.050
OD of starting clutch gear	42.192~42.208	42.100

Torque value

Flywheel nut	5.0~6.0kgf-m
Starting clutch hexagon bolt	1.0~1.4kgf-m with adhesive
8 mm bolts	0.8~1.2kgf-m
12 mm bolts	1.8~2.2kgf-m

Special tools

AC.G. flywheel puller	SYM-3110000-HMA
Right crank case cover 6201 bearing puller	SYM-9614000-HMA RB1 6201
Inner bearing puller	SYM-6204022
Universal holder	SYM-2210100

Right Crankcase Cover Removal

Remove left side cover.
 Remove seat and luggage box.
 (Refer chapter 13)
 Remove the exhaust muffler (3 bolts, 2 nuts).

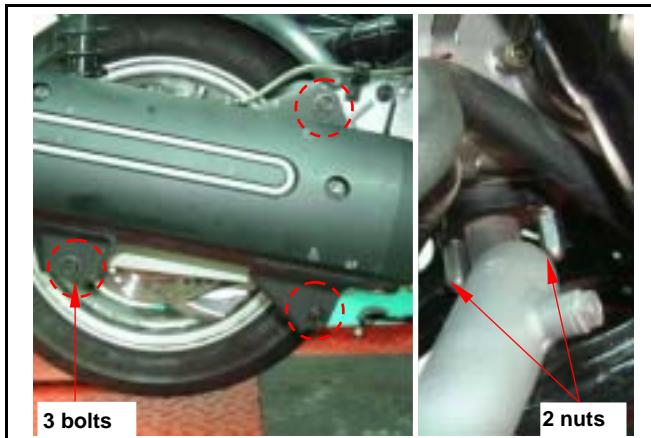

Drain out the engine oil and coolant (refer chapter 5).
 Remove coolant hoses.

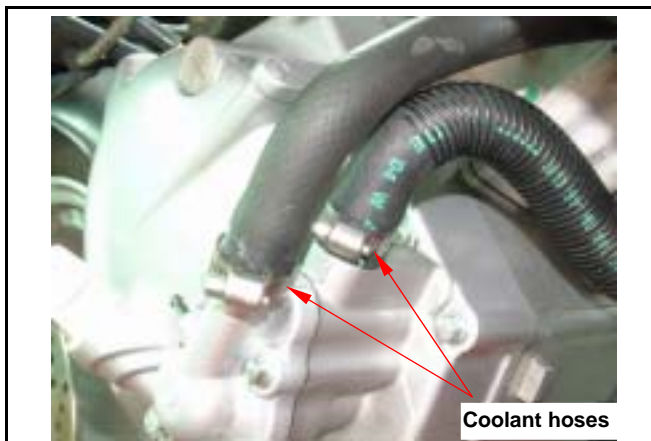

Disconnect the couplers of the Power source output line

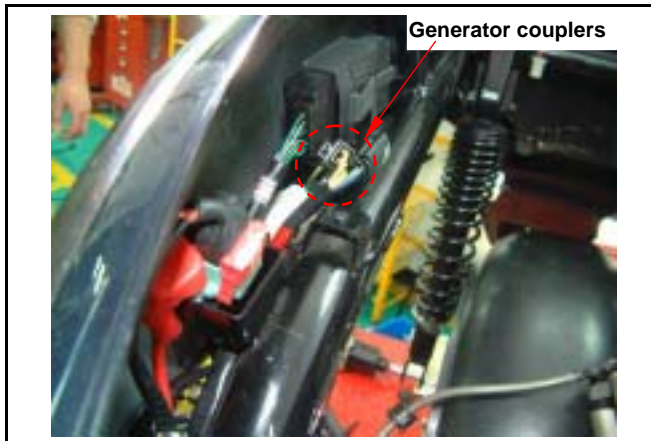

Remove water pump cover (4 bolts).
 Remove 10 bolts from the right crankcase cover.
 Remove the right crankcase cover.
 Remove dowel pin and gasket.

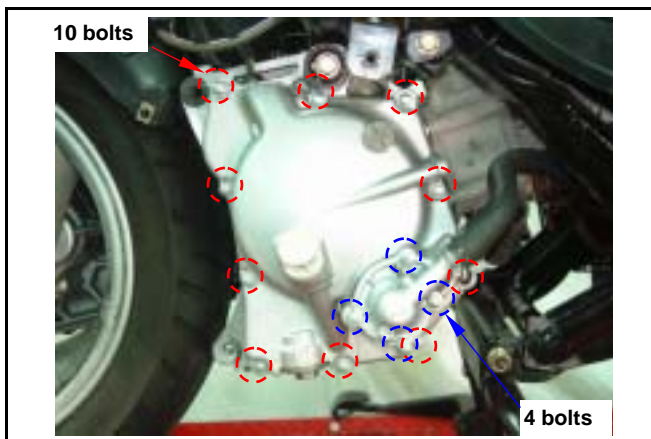

10. Alternator / Starting Clutch

AC.G. Set Removal

Remove 2 mounting screws from pulse generator.
Remove 3 screws from right crankcase cover and then remove generator coil set.

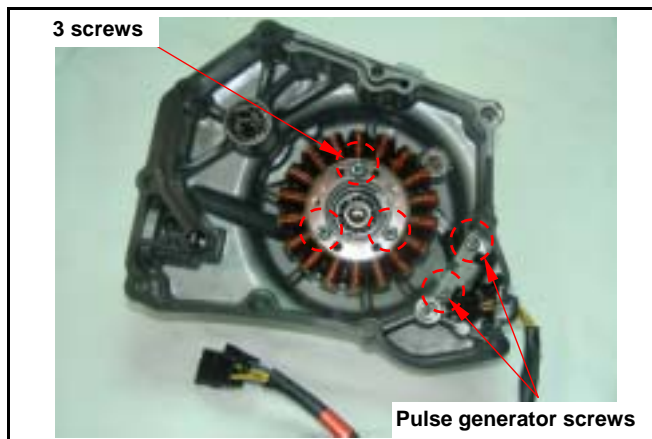

Right Cover Bearing

Rotate the bearing with finger to check if the bearing rotation is in smooth and silent.
Check if the bearing outer parts are closed and fixed. Replace it if necessary.

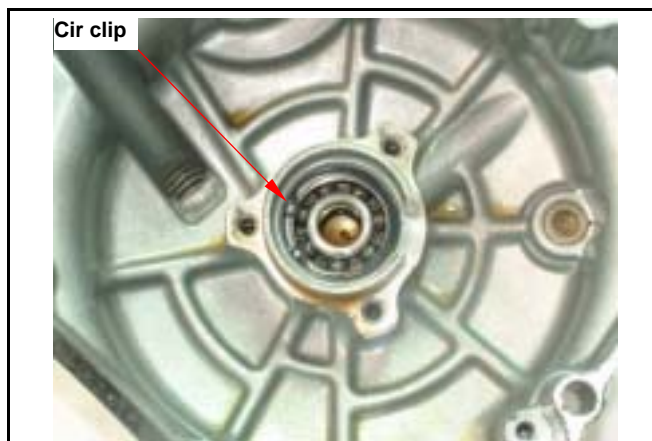

Remove the bearing 6201 with inner bearing puller.

Special tool:

Inner bearing puller SYM-6204022



Install the bearing 6201 bearing with special tool.

Special tool:

**Right crankcase cover bearing 6201 presser
SYM-9614000-HMA RB1 6201**



Flywheel Removal

Remove right crankcase cover and generator coil.
Remove flywheel nut.

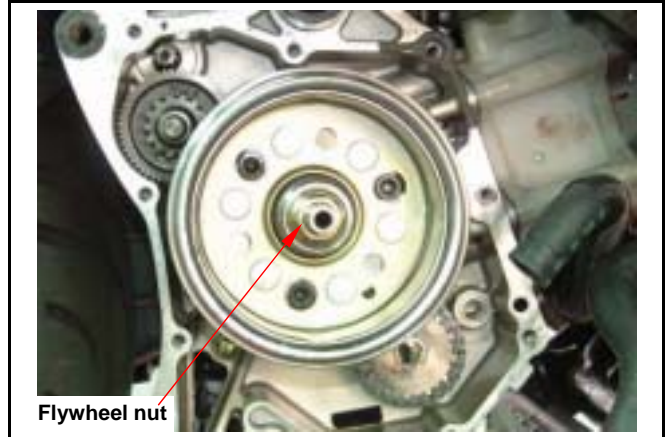

Installs shaft protector onto the crank shaft.

Special tool:
Shaft protector

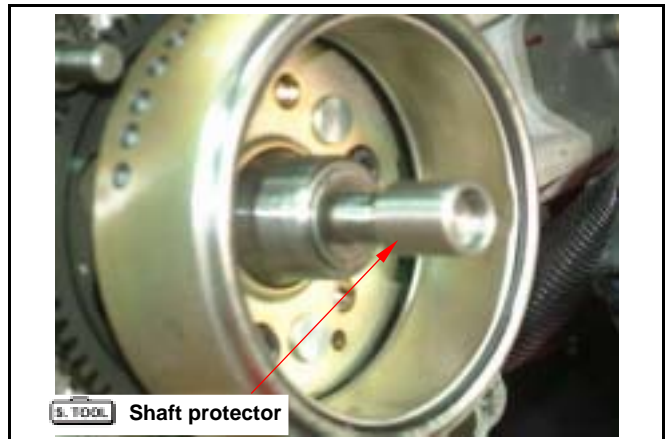

Remove starter reduction gear and shaft.
Pull out flywheel with AC.G. flywheel puller.

Special tool:
AC.G. Flywheel puller SYM-3110000-HMA

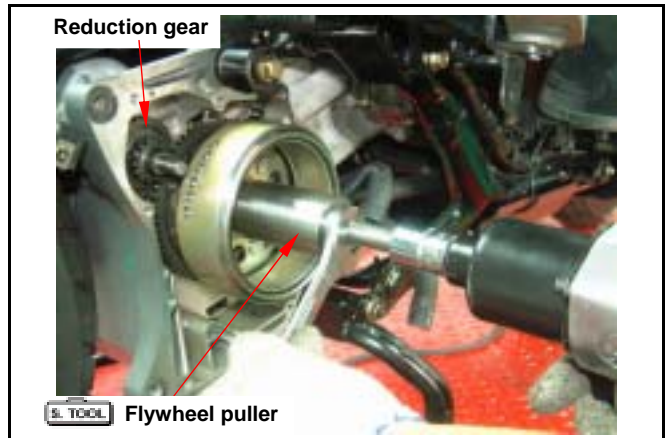

Remove flywheel and starting driven gear.



10. Alternator / Starting Clutch

Starting Clutch

Starting Clutch Inspection

Remove starting clutch driven gear.
Check the gear for wear or damage.
Measure the ID and OD of the starting clutch driven gear.

Service Limit: ID: 25.050 mm
OD: 42.100 mm

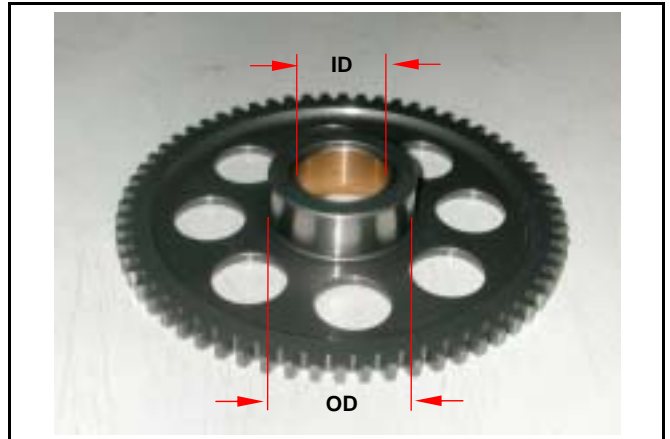

Check the starting reduction gear and shaft for wear or damage.



Check each roller for wear or damage.



Install starting clutch driven gear onto one way clutch.

Hold flywheel and rotate starting clutch gear.
The starting clutch gear should be rotated in C.C.W direction freely, but not C.W direction.
(View as shown in this figure.)



Remove the starting gear
Loosen 3 starting clutch socket bolts from one way clutch and remove one way clutch.

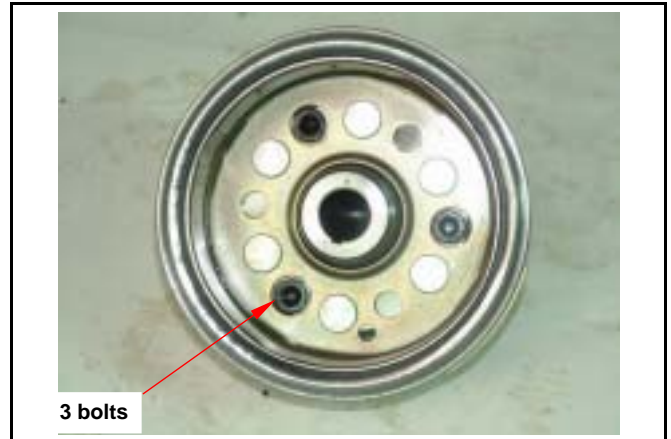

Push out the roller set and check each roller for wear or damage.



One way clutch Installation

Install the components in the reverse procedures of removal.

Torque value: 1.0~1.4kgf-m

Caution

Cannot lock the thread of socket bolt.

Caution

The one way clutch must to with the generator flywheel and the starter gear, after one and loads the crank in, only then may lock the socket bolt, otherwise will create concentric the deviation, will cause the part to suffer injury.

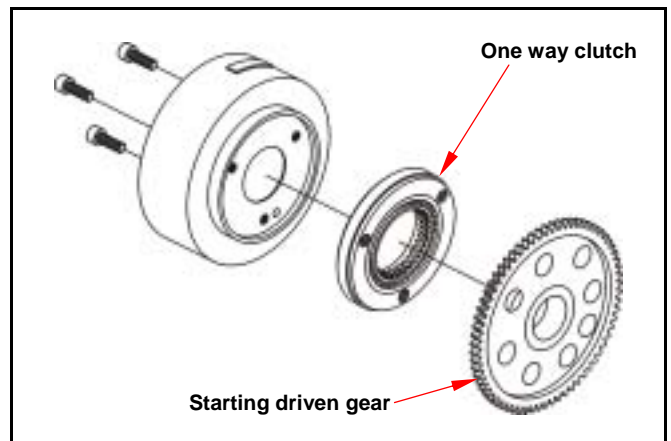

10. Alternator / Starting Clutch

AC.G. Flywheel Installation

Install starting driven gear onto one way clutch.

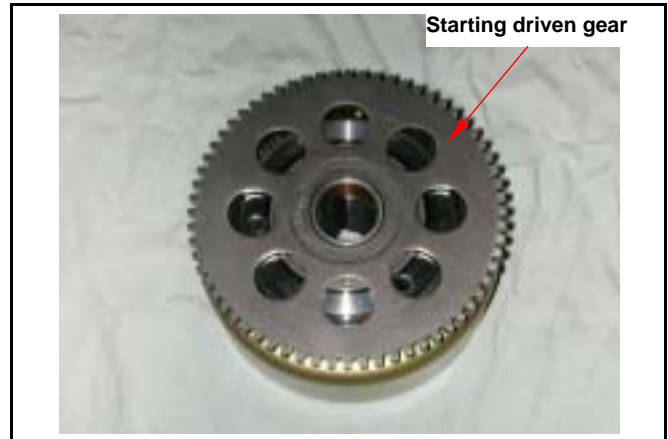

Align the key on crankshaft with the flywheel groove, and then install the flywheel.



Hold the flywheel by drive face with universal holder, and tighten flywheel nut.

Torque value: 5.0~6.0kgf-m

Special tool:

Universal Holder SYM-2210100

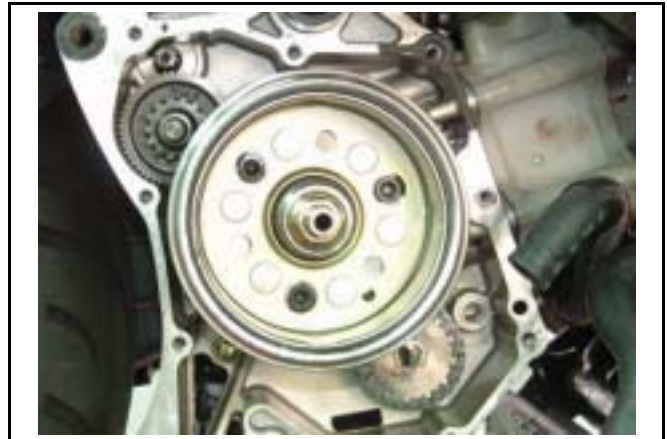

AC.G. Set Installation

Install the AC.G. coil set onto right crankcase cover (3 screws).
 Install pulse generator (2 screws).
 Tie the wire harness securely onto the indent of crankcase.

⚠ Caution

Make sure that the wire harness is placed under pulse generator.

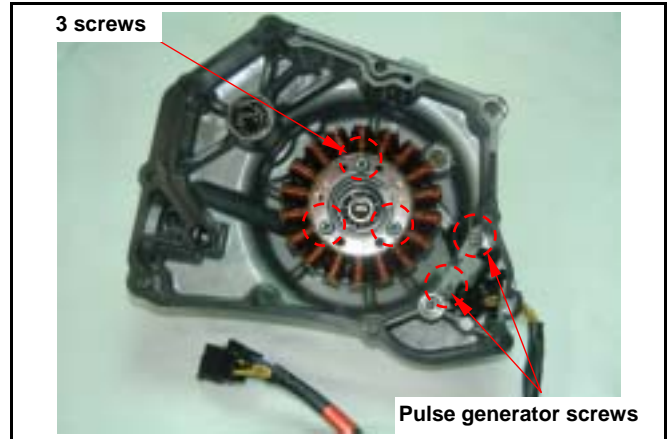

Right Crankcase Cover Installation

Install dowel pins and new gasket.
 Remove water pump cover.
 Install right crankcase cover onto the crankcase.
 Note: Align the water pump shaft indent with the oil pump shaft.

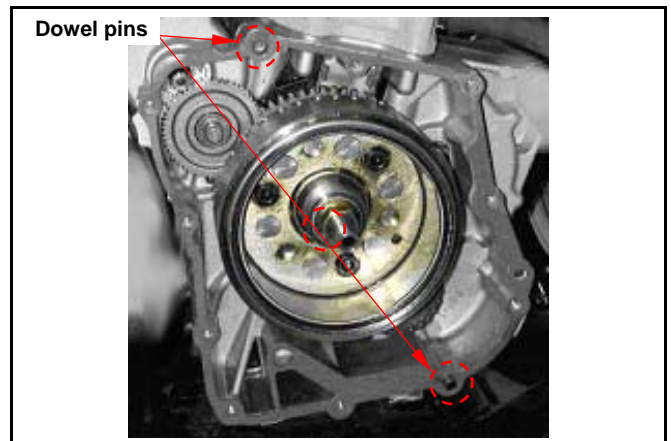

Install right crankcase cover (10 screws).
 Install the dowel pin, new gasket and water pump cover onto crankcase cover.

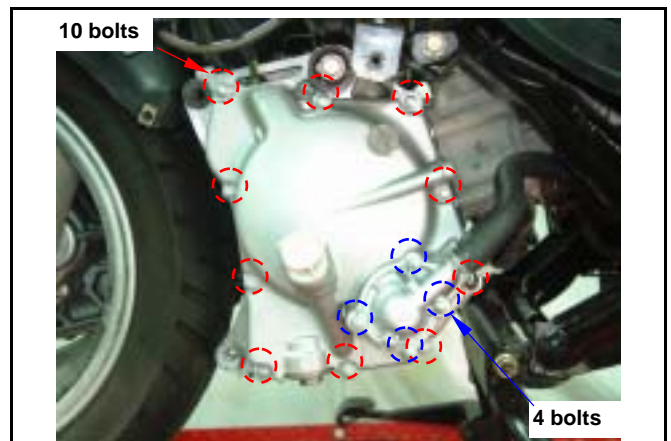

Connect coolant hoses onto the right crankcase cover.
 Add engine oil and coolant.



10. Alternator / Starting Clutch

Notes:

Mechanism Diagram11-1	Disassembly of Crankcase..... 11-3
General Information11-2	Crankshaft Inspection 11-4
Trouble Diagnosis11-2	Assembly of Crankcase..... 11-6

Mechanism Diagram

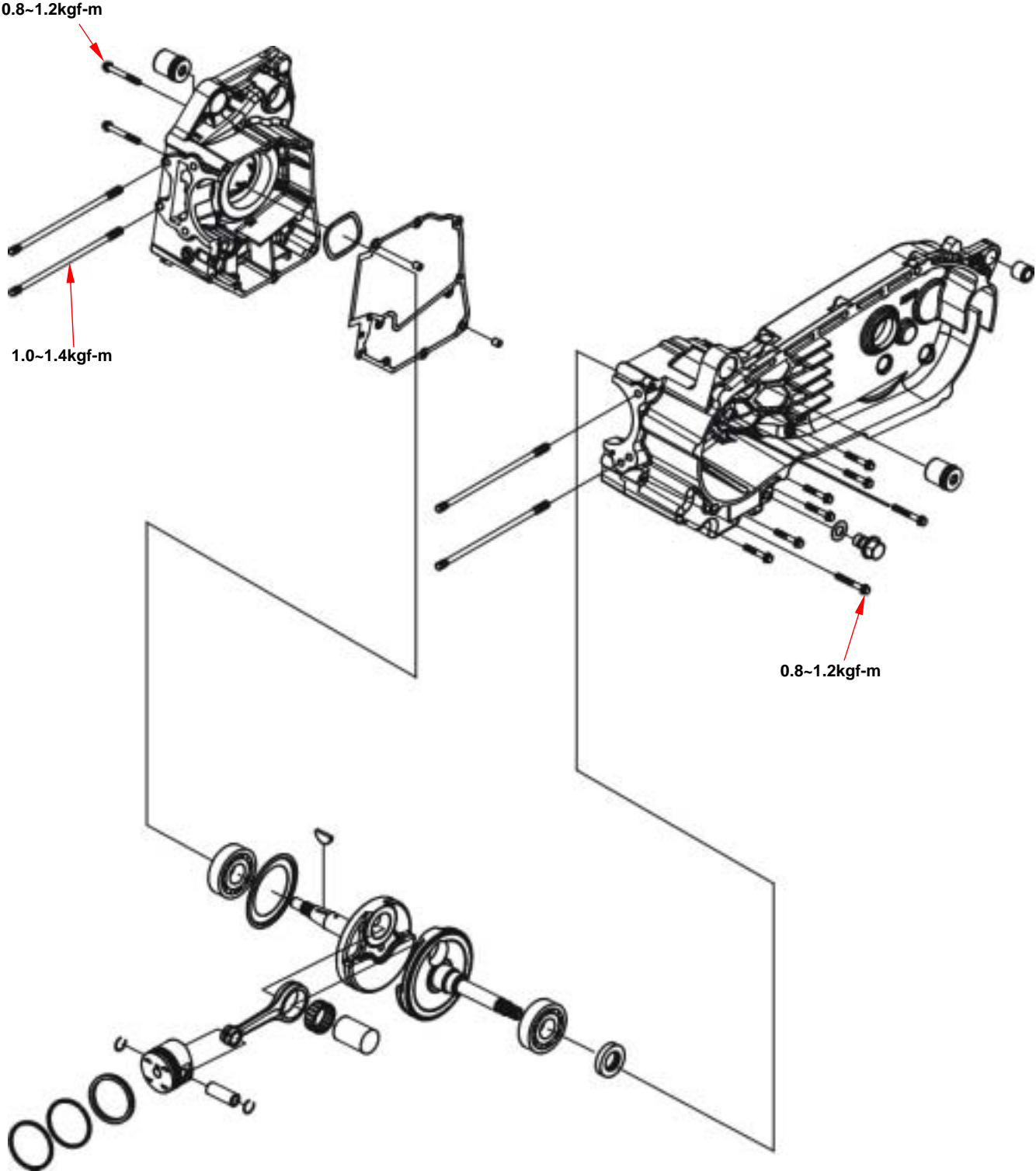

11. Crankcase / Crank

General Information

Operational precautions

- This Section concerns disassembly of the crankcase for repair purpose.
- Remove following components before disassembling crankcase.
 - Engine remove Chapter 5
 - Cylinder head Chapter 6
 - Cylinder and piston Chapter 7
 - Drive face and driven pulley Chapter 8
 - AC generator/Start one way clutch Chapter 10
- In case it requires replacing the crankshaft bearing, the driving chain of engine oil pump or the timing chain, it is preferably to replace crankshaft as a unit.

Specification

Unit: mm

Item	Standard	Limit
Connecting rod side clearance of the big end	0.100~0.400	0.600
Vertical clearance of the big end of the connecting rod	0~0.008	0.050
Run-out	-	0.100

Torque value

Bolts for crankcase	0.8~1.2kgf-m
Cylinder stud bolts	1.0~1.4kgf-m
Bolt for cam chain adjuster	1.2~1.6kgf-m

Special tools

R/L. crank disassemble tool	SYM-1120000-HMA H9A
L. crank shaft bearing puller	SYM-9100100
Crank shaft install socket & oil seal driver	SYM-2341110- HMA RB1
Crank shaft puller	SYM-1130000-HMA H9A
Outer bearing puller	SYM-6204001
Inner bearing puller	SYM-6204022
Clutch nut wrench	SYM-9020200

Trouble Diagnosis

Engine noise

- Loose crankshaft bearing
- Loose crankshaft pin bearing
- Worn out piston pin and pin hole

Disassembly of Crankcase

Remove the cam chain setting plate, and then remove cam chain.
Loosen the pivot bolt and remove the tensioner.
Loosen 2 bolts on the right crankcase.

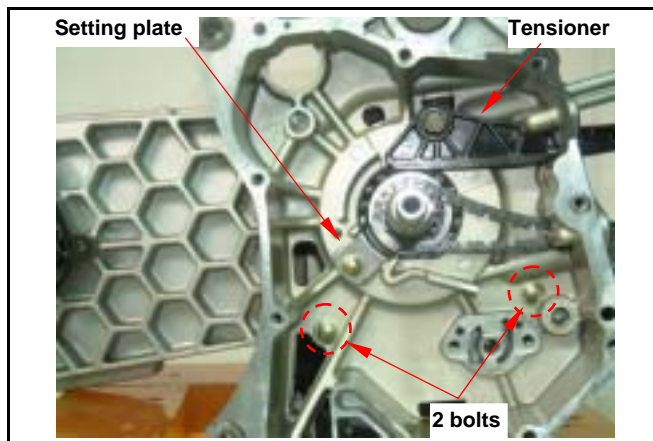

Loosen 8 bolts on the left crankcase.

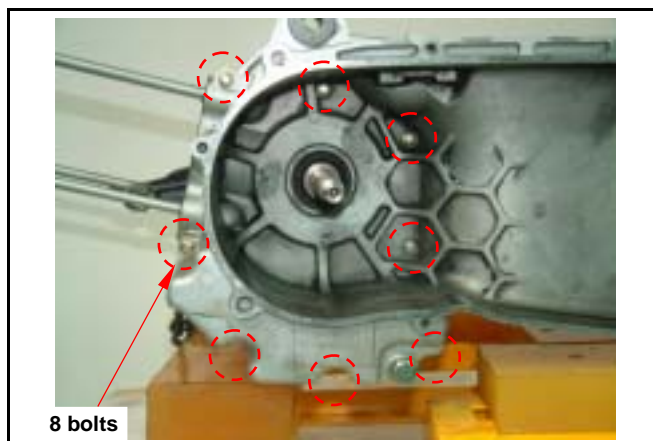

Place right crankcase downward and left crankcase upward.
Install crank disassemble tool onto left crankcase.

⚠ Caution

Care should be taken not to damage the contact surfaces.



Install left crank shaft puller into crank case disassemble.
Hold left crank shaft puller nut by clutch nut wrench, and turn the shaft puller to press out crank shaft from left crankcase.

Special tool:

- Crank case disassemble
SYM-1120000-HMA H9A
- L. Crank shaft puller
SYM-1130000-HMA H9A
- Clutch nut wrench SYM-9020200



11. Crankcase / Crank

Remove crankshaft and wave washer from right crankcase.



Remove gasket and dowel pins.
Scrape gasket residues off the crankcase contact surface.

Caution

Do not damage contact surface of the gasket.
It is better to moisten the gasket residue for easy scrapping.



Drive out left crankcase oil seal.

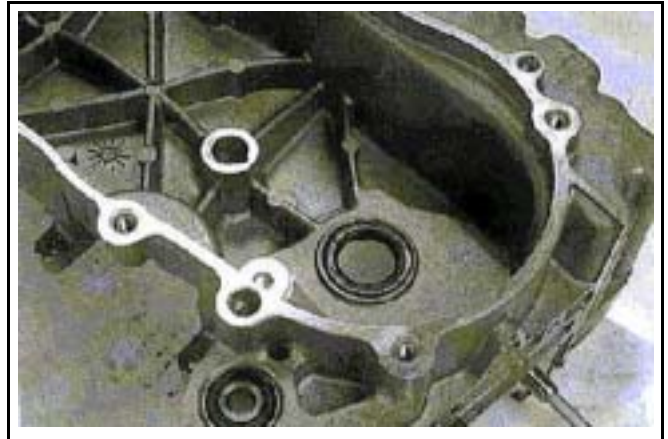

Crankshaft Inspection

Use a thickness gauge to measure left and right clearance of connecting rod big end.

Service limit: 0.6 mm

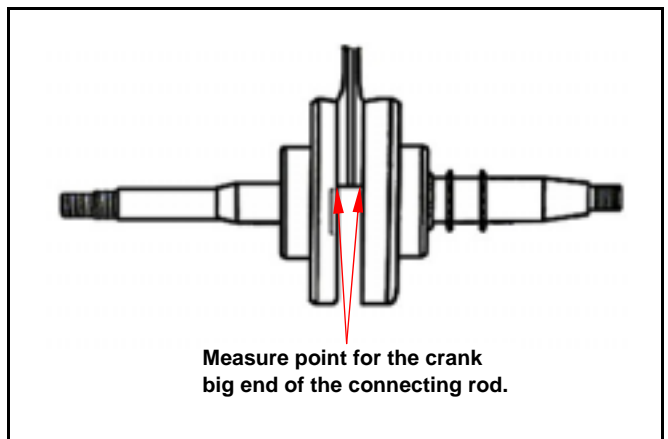

Measure the clearance of the big end at the vertical directions.

Service limit: 0.05 mm

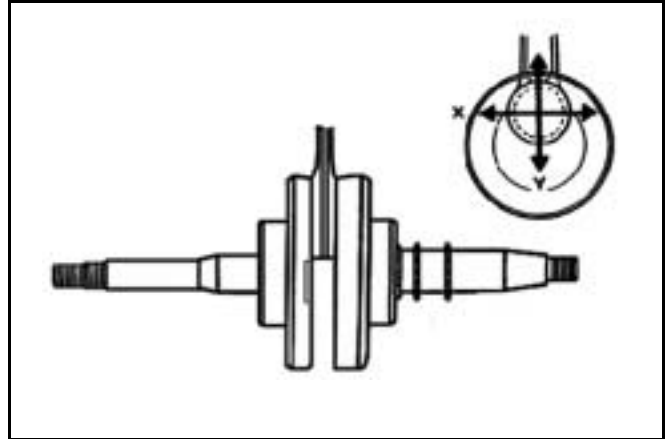

Place the crankshaft on a V-block, measure run-out of the crankshaft.

Service limit: 0.10 mm

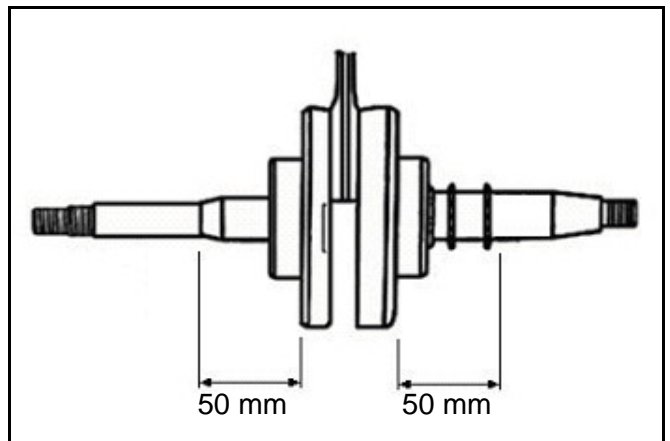

Check crankshaft bearing

Use hand to crank the bearing to see it moves freely, smoothly and noiseless.
Check the inner ring to see it links firmly on the bearing.

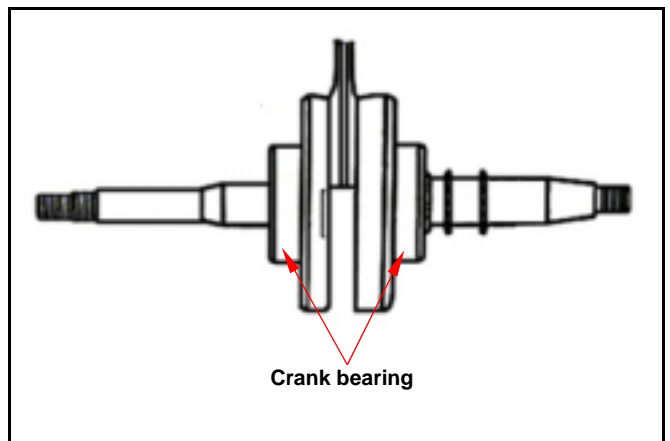

If any roughness, noise and loose linkage are detected, replace the bearing with new one.

⚠ Caution

The bearing shall be replaced in pair.

Special tool:

Outer bearing puller SYM-6204001

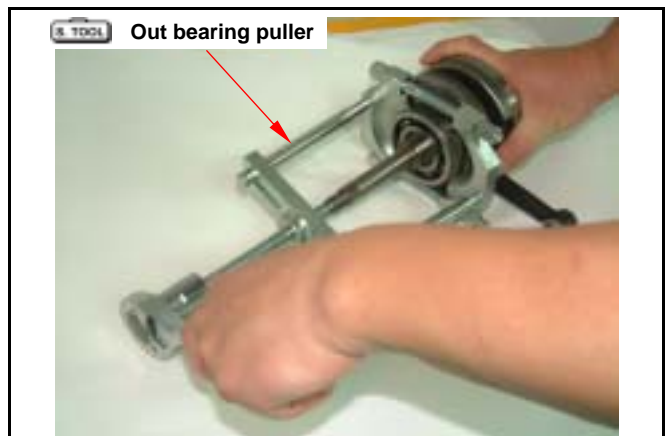

11. Crankcase / Crank

Assembly of Crankcase

Install new bearing and bearing puller onto left crankcase bearing hole.

Special tool:

L. crank shaft bearing puller SYM-9100100

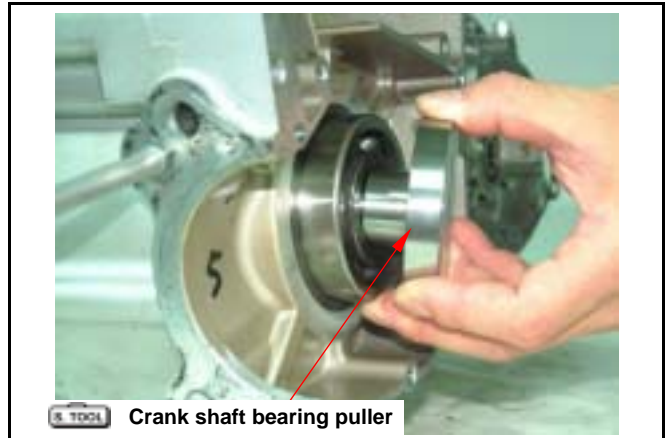

Install crank disassemble tool onto left crankcase. Install left crank shaft puller into crank case disassemble.

Hold left crank shaft puller, and turn the shaft puller nut by clutch nut wrench to pull in crank shaft bearing into left crankcase.

Special tool:

Crank case disassemble SYM-1120000-HMA H9A

L. Crank shaft puller SYM-1130000-HMA H9A

Clutch nut wrench SYM-9020200



Install crank shaft onto the left crankcase and install crank shaft install socket.

Special tool:

Crank shaft install socket & oil seal driver SYM-2341110- HMA RB1



Turn in the crank shaft puller spiral tooth to the left crank shaft.

Special tool:

L. Crank shaft puller SYM-1130000-HMA H9A

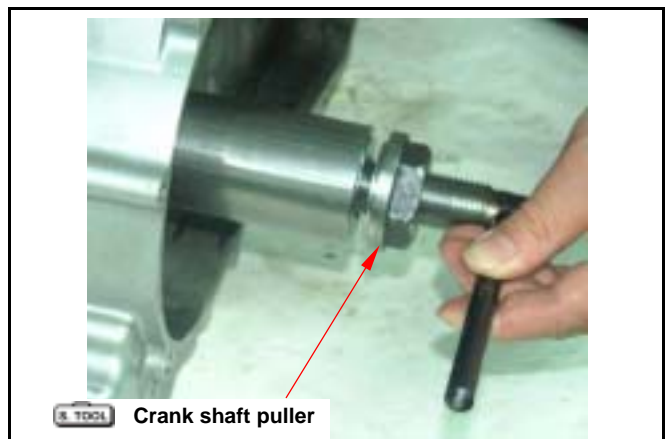

Hold left crank shaft puller, and turn the shaft puller nut by clutch nut wrench to pull in crank shaft into left crankcase.



Put wave washer onto right crank bearing.

⚠ Caution

Right flank the wave washer piece certainly must install. Cannot install the wrong position or leak the attire. Otherwise can cause the motorcycle to have the fierce vibration



Install 2 dowel pins and new gasket.
Install the right crankcase onto the left crankcase



Tighten 8 bolts on the left crankcase.
Tighten 2 bolts on the right crankcase.
Torque value: 0.8~1.2kgf-m

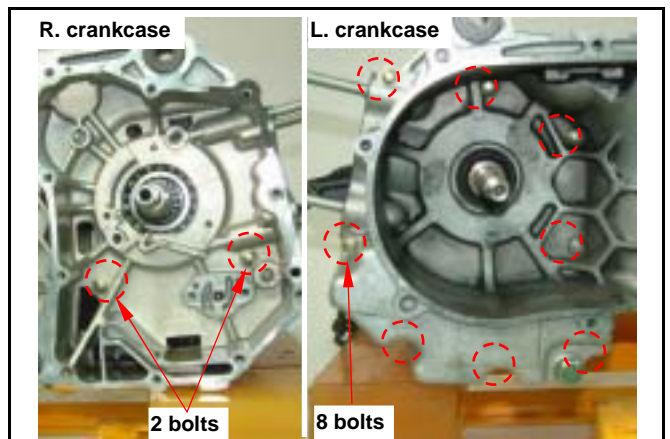

11. Crankcase / Crank

Apply a layer of grease on the lip of oil seal
Clean the crankshaft with clean solvent.



Install the oil seal in the left crankcase with special tool.

Special tool:

Crank shaft install socket & oil seal driver
SYM-2341110- HMA RB1



Install the cam chain tensioner & and tighten the bolts.

Torque value: 1.2~1.6kgf-m

Install the cam chain.

Install the cam chain setting plate.

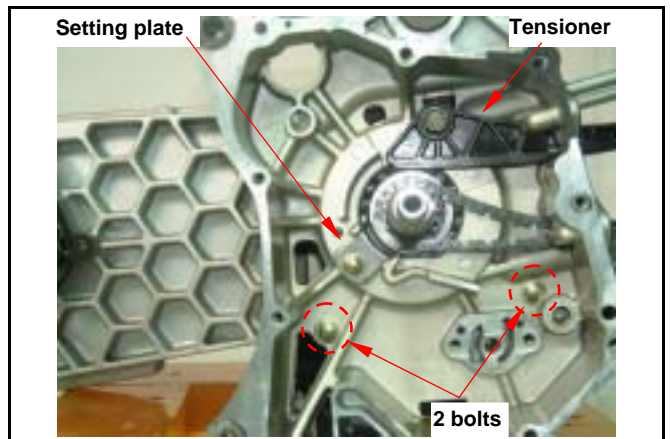

Mechanism Diagram 12-1	Change of coolant..... 12-5
General Information 12-2	Radiator 12-6
Trouble Diagnosis 12-2	Water Pump 12-8
Trouble Diagnosis for Cooling System 12-3	Thermostat 12-12

Mechanism Diagram

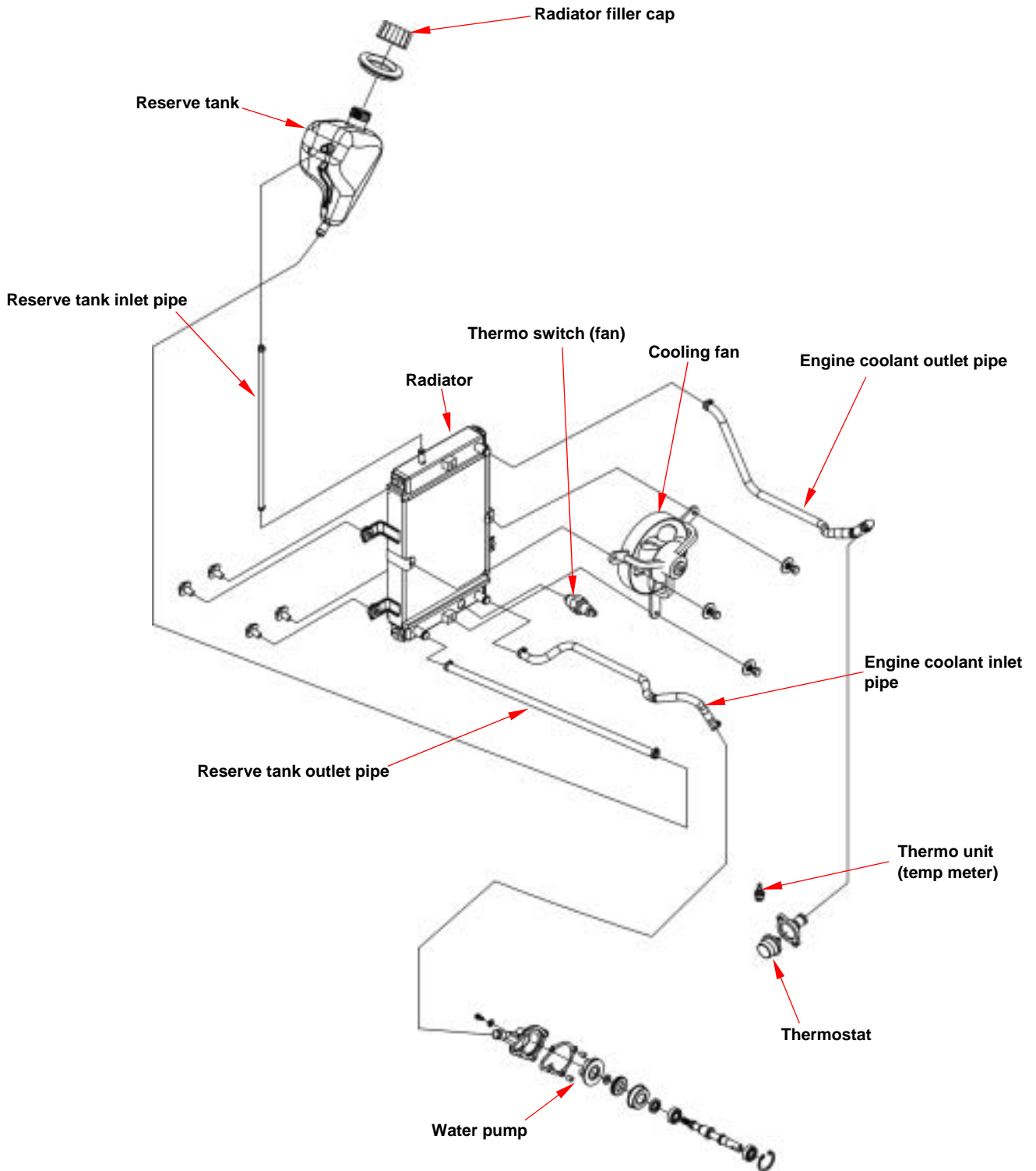

12. Cooling System

General Information

General

Warning:

While the engine is running, never attempt to open the radiator filler cap, the pressurized hot coolant may shoot out and cause serious scalding injury. No maintenance work is allowed to perform unless the engine is completely cooled down.

- Refill the radiator with distilled water or specified additives.
- Add coolant to the reservoir.
- The cooling system can be serviced on the motorcycle.
- Never spill the coolant to the painted surface.
- Test the cooling system for any leakage after the repair.
- Please refer to Section 17 for inspection of the temperature sensor switch for the fan motor and the water thermometer.

Technical Specification

Item	Specification
Pressure to open filler cap	0.9 ± 0.15 Kg/cm ²
Capacity of coolant: Engine + radiator	850c.c.
Reservoir upper	420c.c.
Thermostat	Begins to activate at : 82~92°C Stroke : 0.05~3.0mm/80°C
Boiling point	Not-pressure : 107.7°C Pressurized: 125.6°C

Torque Value

For water pump rotor 1.0~1.4kgf-m

Tools Requirement

Special tools

Water pump bearing driver (6901): SYM-9100100

Water pump oil seal driver (Inner): SYM-9120500-H9A

Water pump mechanical seal driver: SYM-1721700-H9A

Inner bearing puller: SYM-6204020

Trouble Diagnosis

The engine temperature is too high

- The water thermometer and the temperature sensor do not work properly.
- The thermostat is stuck to closed.
- Insufficient coolant.
- The water hose and jacket are clogged.
- Fan motor malfunction.
- The filler cap of the radiator malfunction.

The engine temperature is too low

- The water thermometer and the temperature sensor malfunction.
- The thermostat is stuck to open.

Coolant is leaking

- The water pump mechanical seal does not function properly.
- The O ring is deteriorated.
- The water hose is broken or aged

Trouble Diagnosis for Cooling System

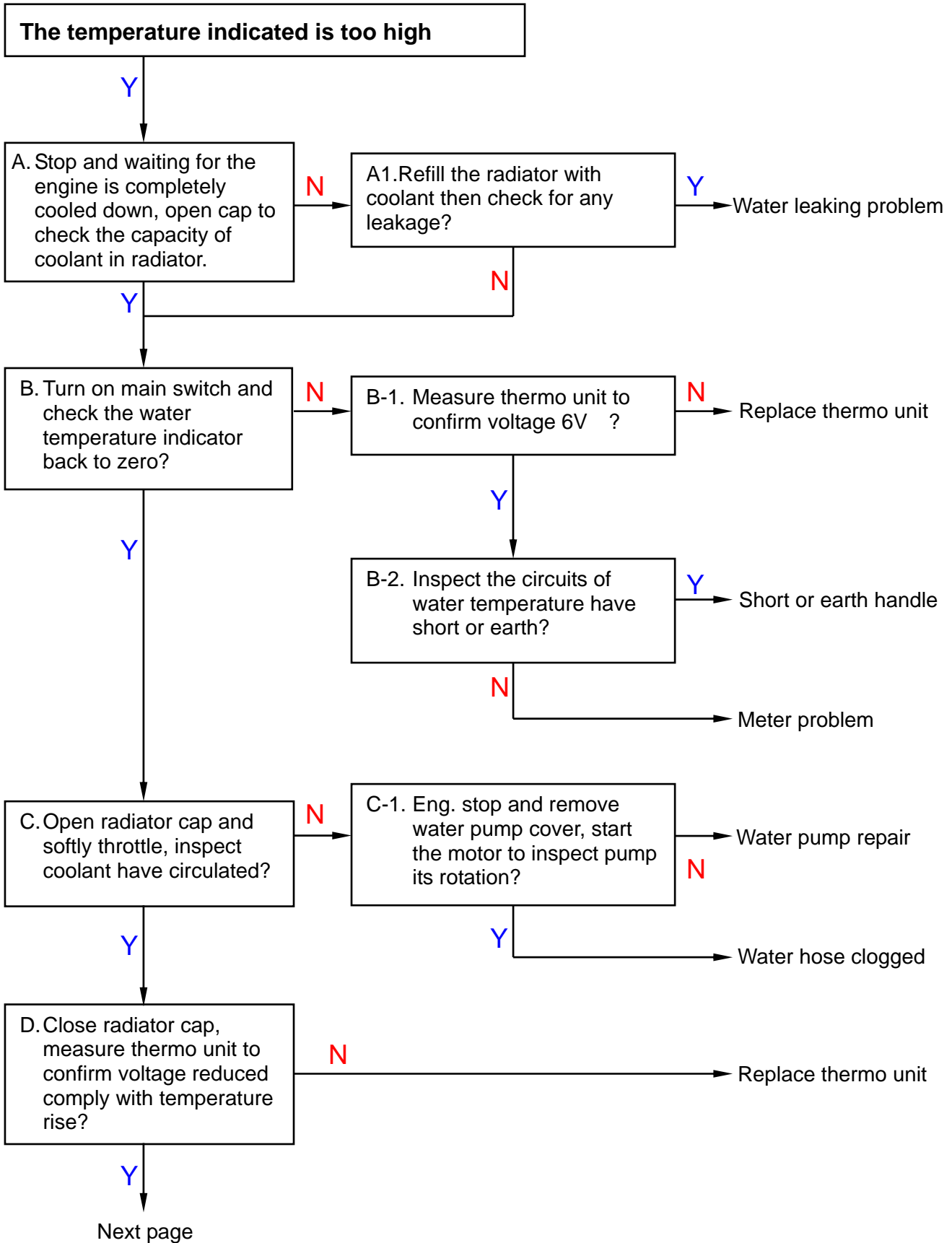

12. Cooling System

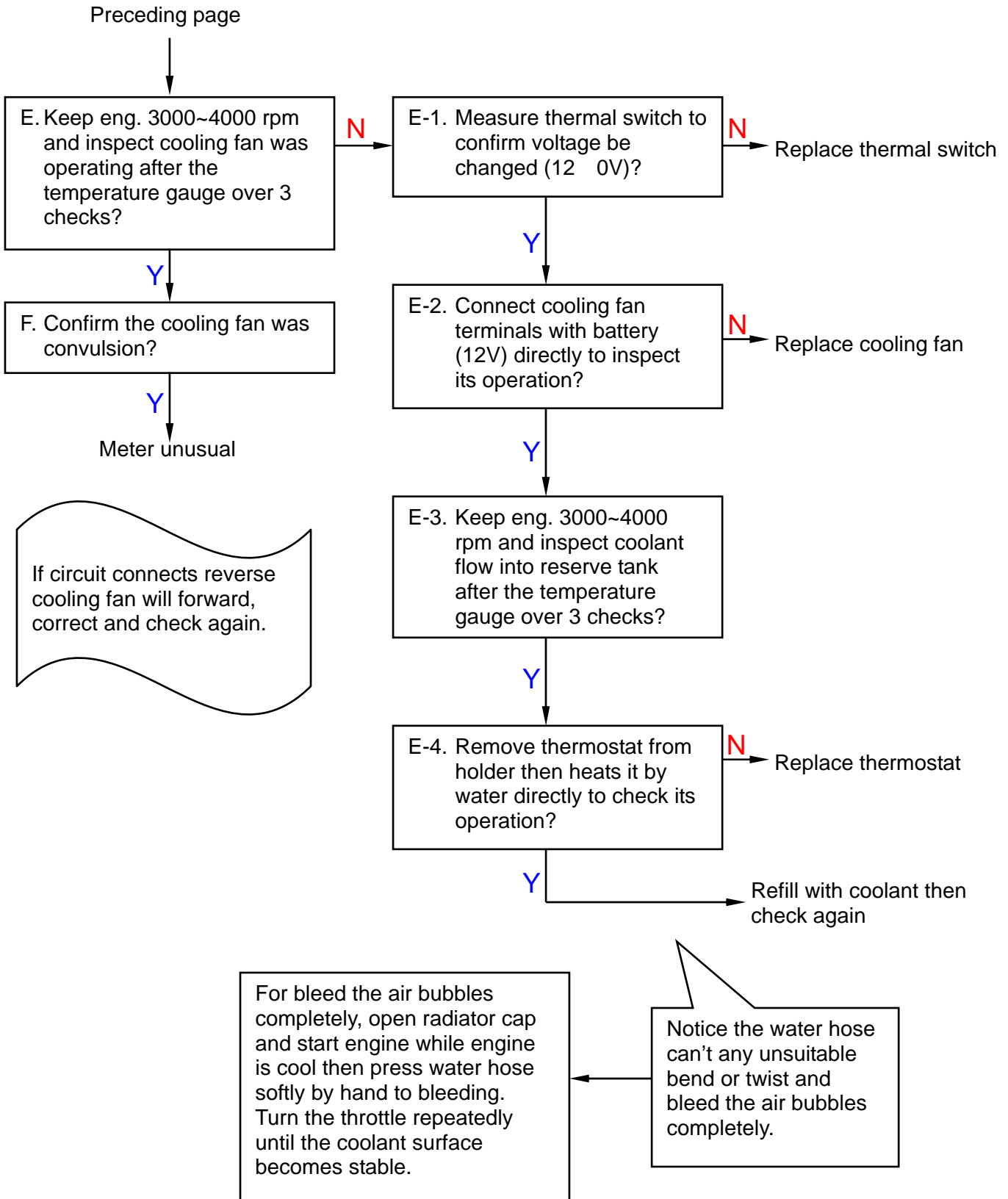

Change of coolant

Warning

- Never attempt to carry out service work on the cooling system unless the engine is completely cooled down, otherwise, you may get scalded.

Remove the reserve tank cap cover, and then remove tank cap.



Place a water pan under the water pump; loosen the drain bolt to drain out the coolant.

Reinstall the drain bolt.

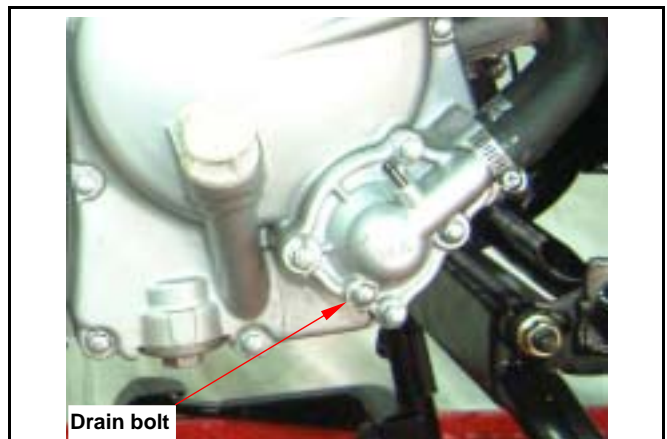

Refilling system with coolant and bleeding the air bubbles.

- Run the engine, and remove by-pass pipe.
- Check by-pass hole whether has the air bubble to emit.
- If emits without the air bubble, only has the coolant to flow out, then backflow pipe joint on, engine flameout.
- Remove radiator filler cap.
- Starts the engine, inspects does not have the air bubble in the radiator coolant, also the coolant liquid level is stable.
- Stop the engine. Add coolant to proper level if necessary.
- Screw and tighten up the radiator filler cap.

Caution

- In order to avoid the water tank rusting, please do not use the unclear trade mark refrigerant.

Coolant recommended: SYM Bramax radiator agent.

Concentration: 50%

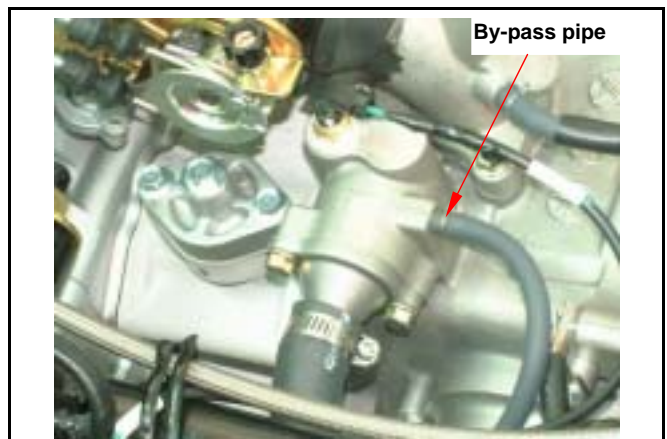

12. Cooling System

Check reserve tank

- Open the inner box lid.
- Check the liquid level in the reservoir.
- Add coolant to proper level if too low.

Caution

- The reserve tank liquid level too low is not high, after avoids the water temperature elevating, in the cooling system the refrigerant backflow floods.



Radiator

Check

Check for any leakage from weld seam. Blow radiator clean using compressed air. If the radiator is blocked by dirt, use low pressure water jet to clean it. Care shall be taken when straightening the sink fan.

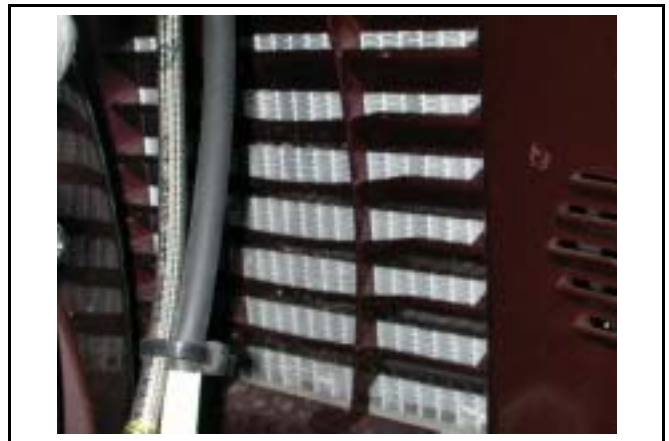

Remove

Place a water pan under the water pump; loosen the drain bolt to drain out the coolant.

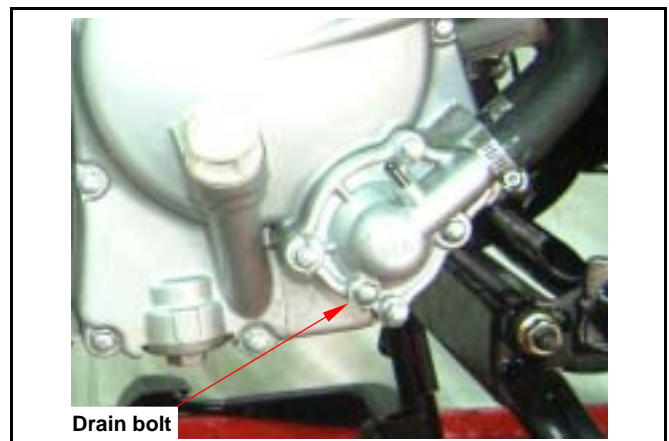

Remove the front cover and under spoiler (refer chapter 13). Loosen the radiator mounting bolts (4 bolts).

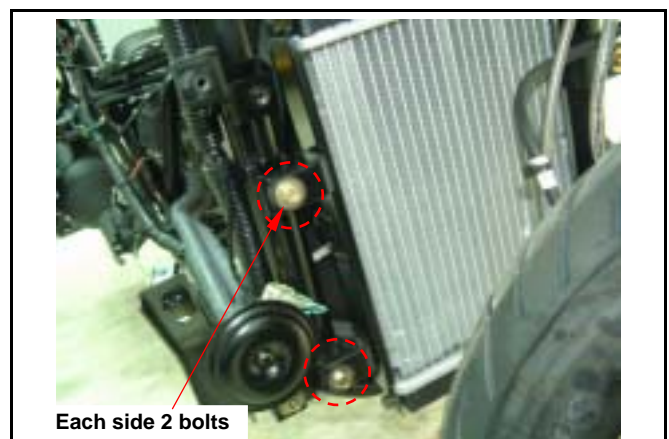

Disconnect the couplers for the thermo switch and fan motor.
Remove engine coolant inlet pipe, reserve tank inlet pipe and radiator inlet pipe.

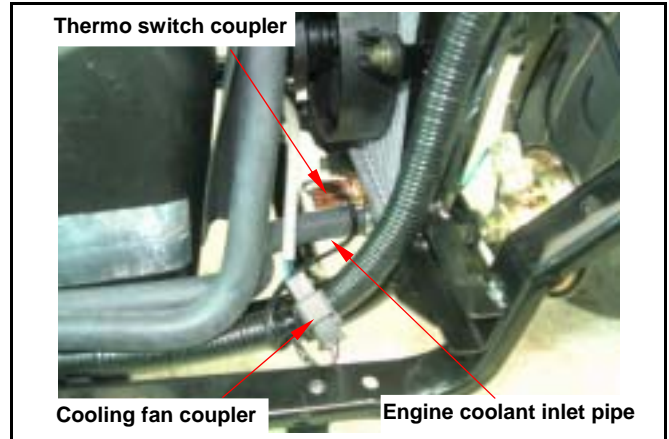

Remove reserve tank coolant inlet pipe.
Remove the radiator and the cooling fan.

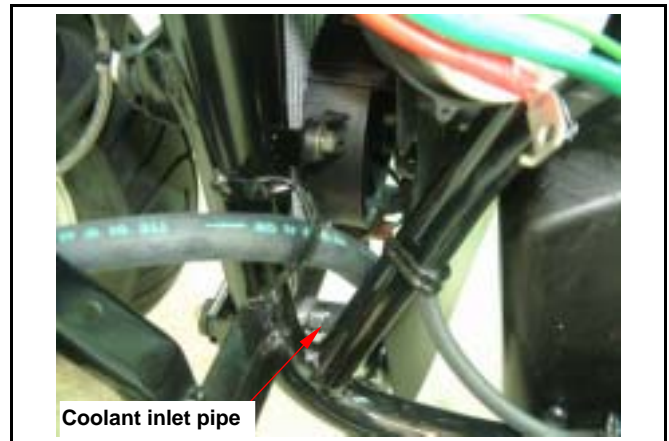

Loosen the cooling fan mounting bolts (3 bolts).
Remove thermo switch.

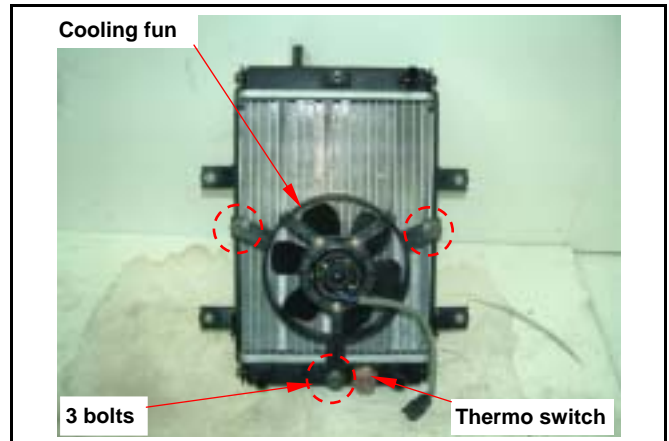

Installation

Install the removed parts in the reverse order of removal.
Install radiator in the reverse order of removal.
Upon completion, check for any leakage.

Caution

- Liquid packing must be applied to the thermo switch before installing to avoid damaging the radiator.



12. Cooling System

Water Pump

Check water pump seal / cooling system divulges inspection

- Disassembles the refrigerant drain bolt, overflows little buckles the N actually fluid, confirmed overflows the refrigerant whether has the greasy dirt.
- Turns on lathe the engine oil gauge rule, the inspection engine oil whether does have bleaches situation of the emulsified.

If has the above two kind of interior to divulge the phenomenon, possibly for the water pump inner two seal damages, the engine cooling system damages or the cylinder and the cylinder head gasket damages, please first dismantles the right crank case to say A confirms the replacement water pump seal, if does not have the question to take apart for overhaul cooling system of system again the cylinder head, the cylinder.

Removal of water pump

Loosen the drain bolt to drain out the coolant.

Remove the water hose.

Loosen 4 bolts and remove the pump cover.

Loosen 10 bolts and remove the engine right cover.

Take off the gasket and dowel pins.

Turn pump rotor clockwise and remove.

Caution

- The rotor is provided with left turn thread.

Remove the cir clip from the right crankcase cover.

Remove the water pump shaft and the inner bearing.

Remove the outside bearing by inner bearing puller.

Rotate the inner ring of bearing, the bearing shall move smoothly and quietly.

If the bearing does not rotate smoothly or produces a noise, replace it with new one.

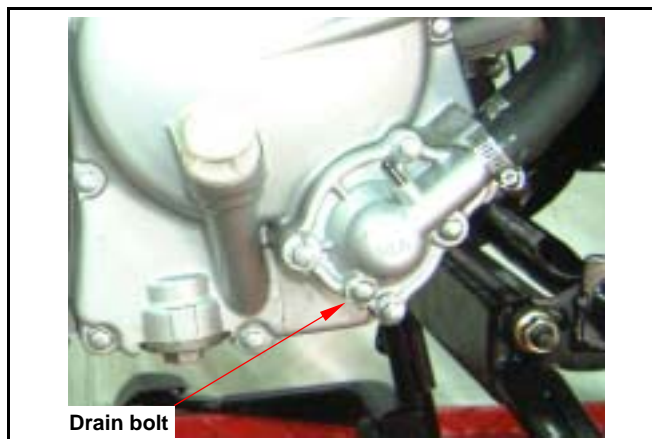

Check any wear and damage of the mechanical seal and inside seal.

⚠ Caution

The mechanical seal and inside seal must be replaced as a unit.

Replacement of Mechanical Seal

Remove the inside bearing by inner bearing puller. Drive the mechanical seal and inner seal out of the right crankcase.

Special tools:

Inner bearing puller

Water pump bearing drive

⚠ Caution

Replace a new mechanical seal after removing it.

Apply a coat of sealant to the mating surfaces of the right crankcase before installing the new mechanical seal.

Install the mechanical seal onto the right crankcase.

Special tools:

Water pump mechanical seal driver



12. Cooling System

Install the new inner seal onto the right crankcase.

Special tools:

Water pump oil seal driver (inner)



Install a new outside bearing to the right crankcase cover.

Special tools:

Water pump bearing driver (6901)

⚠ Caution

- Do not reuse old bearing. It must be replaced with a new one once it has been removed.

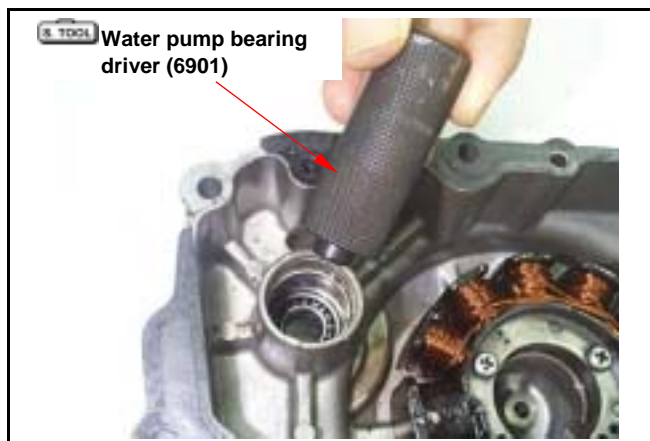

Mount the water pump shaft and the inner bearing to the right crankcase cover.

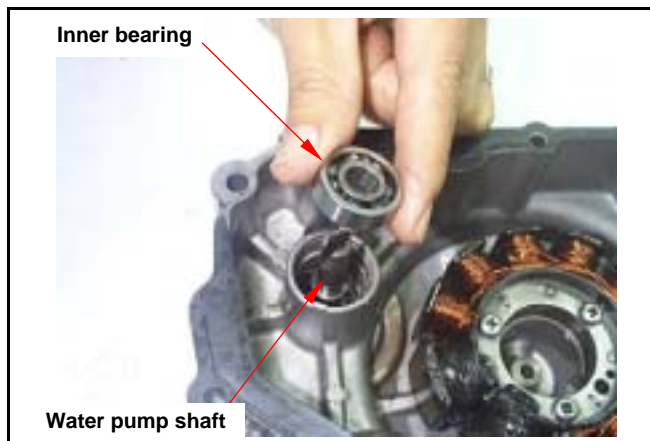

Install the cir clip to hold the inner bearing.



Install the seal washer into the rotor.

⚠ Caution

- Washer must be replaced together with the mechanical seal.



Install the rotor onto the water pump shaft and tighten.

Torque Value: 1.0~1.4kgf-m

⚠ Caution

- The rotor is left thread.

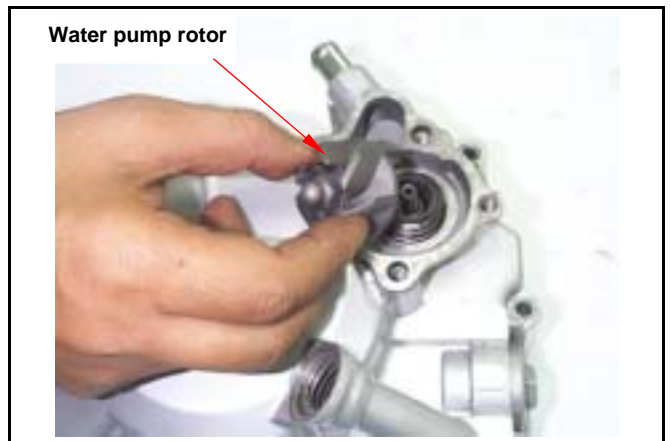

Install the dowel pin and right cover gasket.
The rotation water pump rotor, causes the water pump drive shaft scoop channel, aligns the oil pump drive shaft flange, install the right crank case. (bolts x 9)



Install the dowel pin and new gasket.
Install the water pump cover with 4 bolts.



12. Cooling System

Thermostat

Please refer to chapter 17 for inspection of thermo unit.

Removal

Remove the luggage box and body cover.
Drain out the coolant.

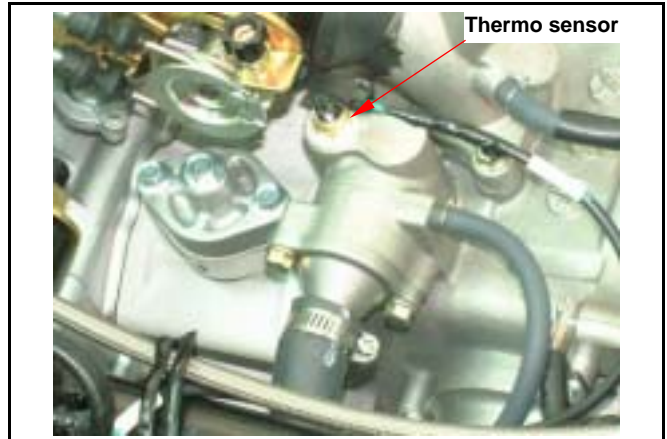

Remove the thermostat cover. (2 bolts)

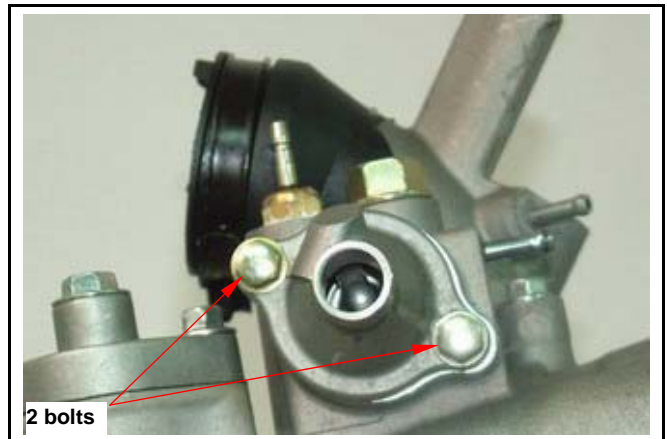

Remove the thermostat.



Inspection

Visually inspect thermostat for any damage.



Place the thermostat into heated water to check its operation.

⚠ Caution

- Whenever the thermostat and the thermometer are in contact to the wall of heated water container, the reading displayed is incorrect. If the valve of the thermostat remains open at room temperature or the valve operation is not corresponding to the temperature change, then it must be replaced.

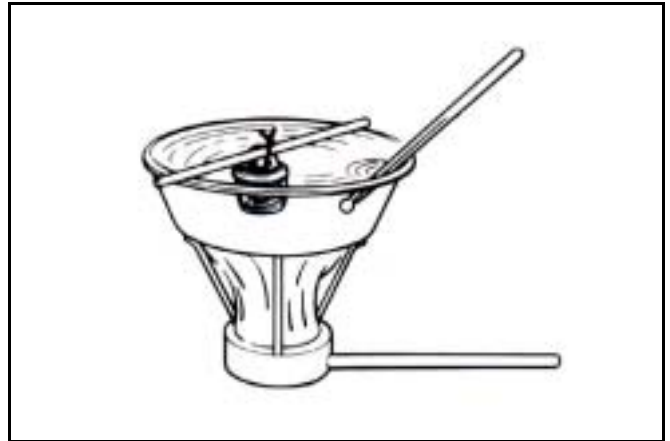

Technical Data

Valve begins to open	82~95
Valve stroke	0.05 ~ 3mm

Installation

Install the thermostat.

Install the thermostat cover. (2 bolts)

Refill the coolant and bleed out the air bubble (Page 12-5).

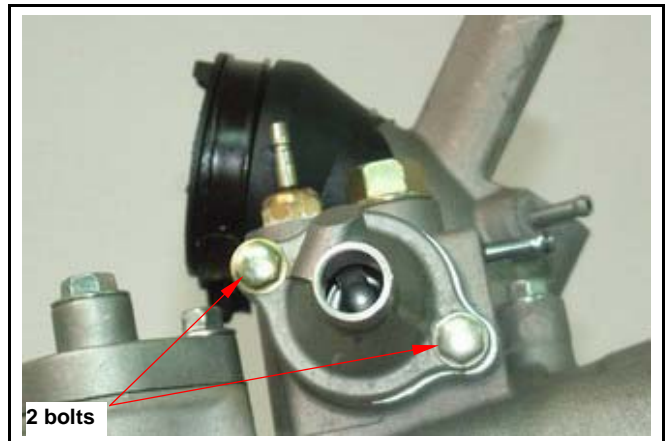

12. Cooling System



Notes:

Mechanism Diagram.....	13-1	Front under Spoiler.....	13-10
Maintenance.....	13-2	Rear Carrier	13-10
Handle Cover.....	13-3	Luggage Box	13-11
Front Cover	13-4	Rear Body Cover.....	13-12
Meter Panel.....	13-6	Floor Panel	13-13
Inner Box	13-7	Front Fender.....	13-13
Side Cover.....	13-9	Rear Fender.....	13-14

Mechanism Diagram

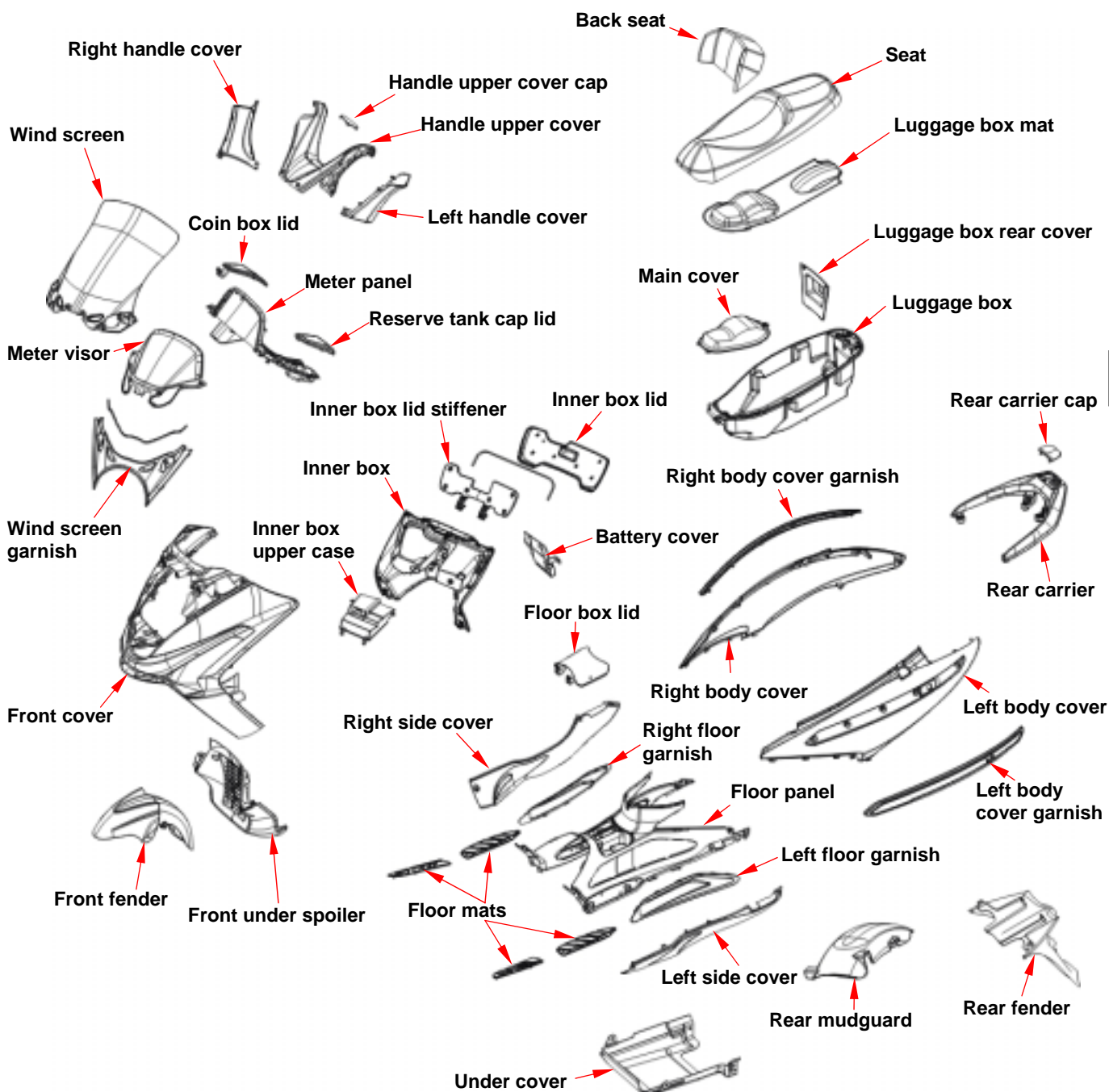

13. Body Cover

Maintenance

Body covers disassemble sequence:

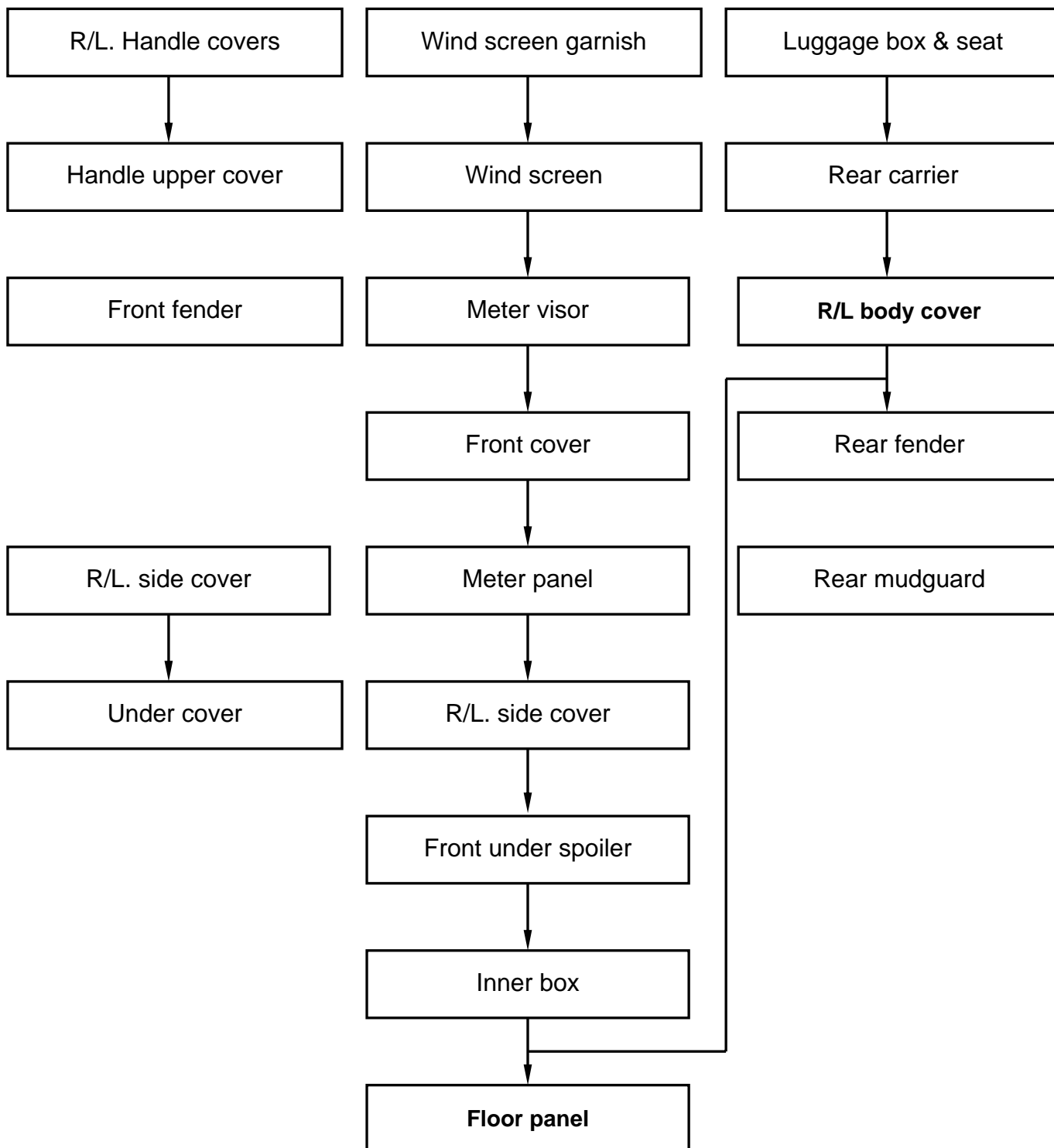

- Be careful not to damage various covers in assembly or disassembly operation.
- Never injure hooks molded on the body covers.
- Align the buckles on the guards with slot on the covers.
- Make sure that each hook is properly installed during the assembly.
- Never compact forcefully or hammer the guard and the covers during assembly.

Handle Cover

Remove

Loosen the 2 screws from handle upper cover front end.



Loosen the 2 screws from handle upper cover rear end.



Remove the handle upper cover cap.



Loosen the 3 screws from the handle upper cover, and then remove handle upper cover.

Installation

Install in reverse order of removal procedures.

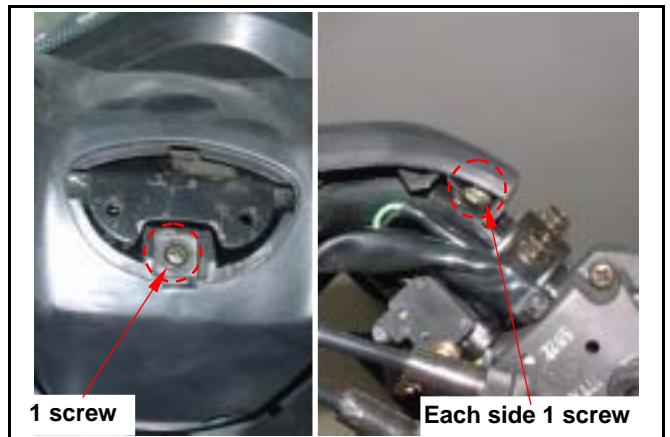

13. Body Cover

Front Cover

Remove

Loosen 4 screws from the wind screen garnish and remove the wind screen garnish.

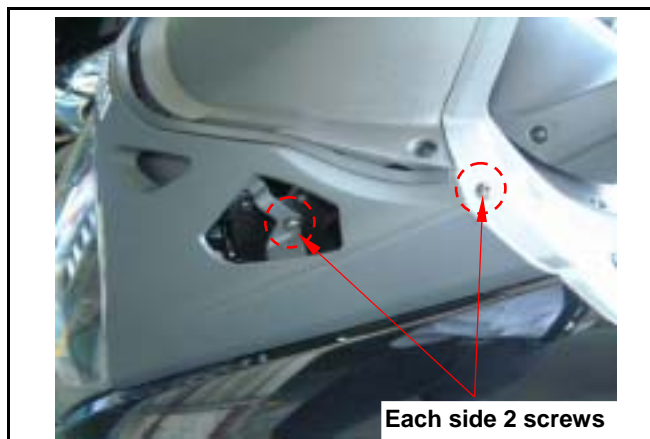

Loosen 8 screws from the wind screen and remove the wind screen.



Loosen 4 screws from the meter visor and remove the meter visor.

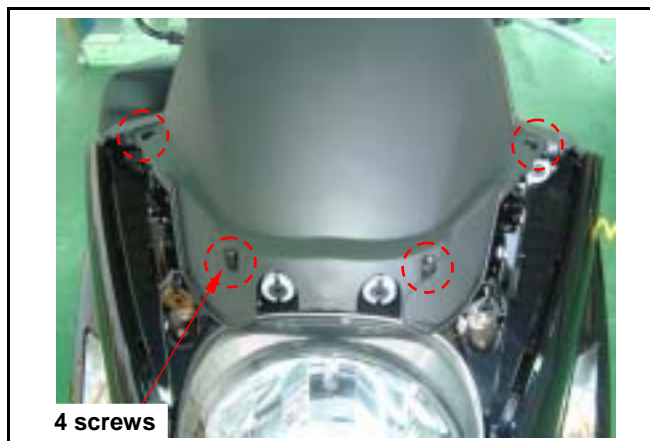

Loosen 8 screws from the inner box.



Loosen 2 bolts from the front cover under side.

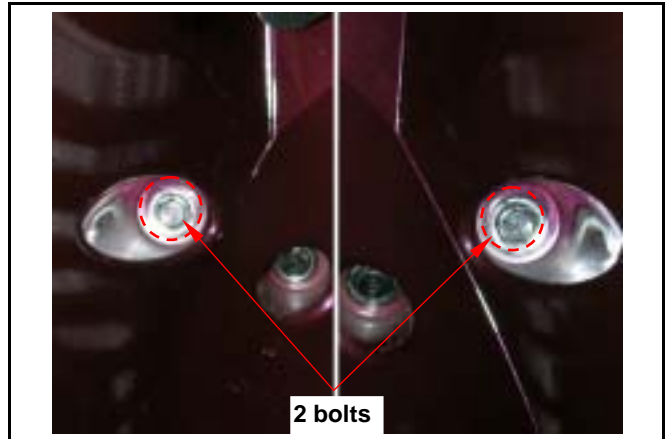

Loosen 2 screws and 2 bolts from the front cover upper side.

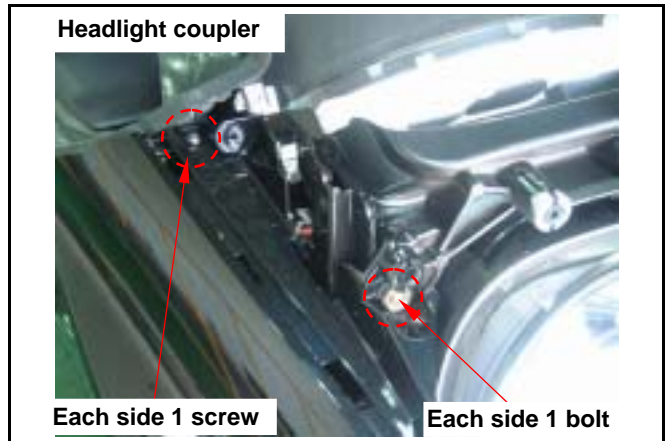

Disconnect the headlight, foggy light and winker light couplers.
Remove the front cover.

Installation

Install in reverse order of removal procedures.

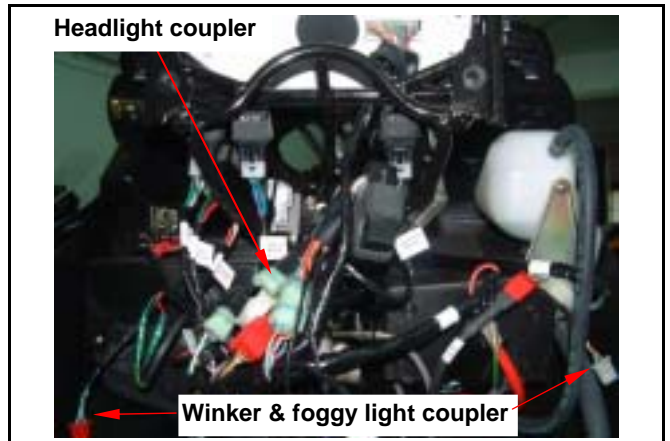

13. Body Cover

Meter Panel

Remove

Remove wind screen garnish, wind screen, meter visor and front cover.

Remove reserve tank cap.

Loosen 4 screws from right & left side of the meter panel.

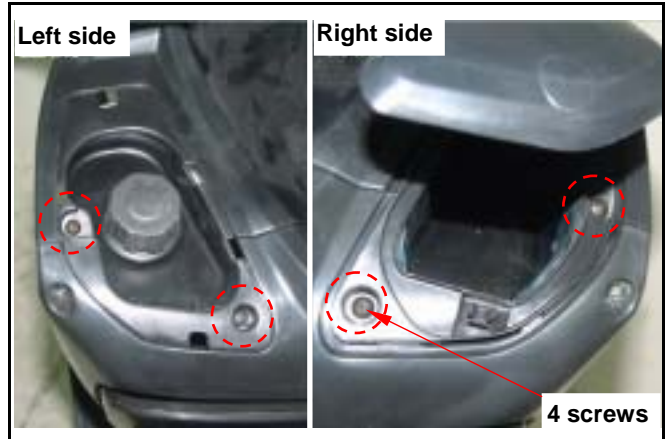

Loosen 2 screws from in side of meter panel.



Loosen the meter cord coupler.

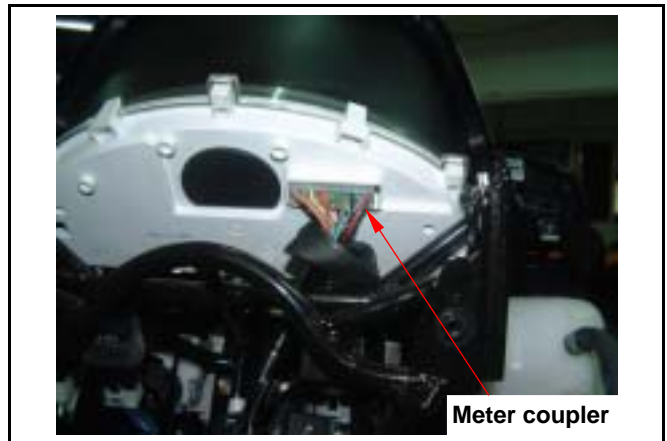

Remove the meter panel.

Installation

Install in reverse order of removal procedures.



Inner Box

Remove

Remove wind screen garnish, wind screen, meter visor, front cover, meter panel, R/L side cover and front under spoiler.

Loosen 1 screw from reserve tank stay.

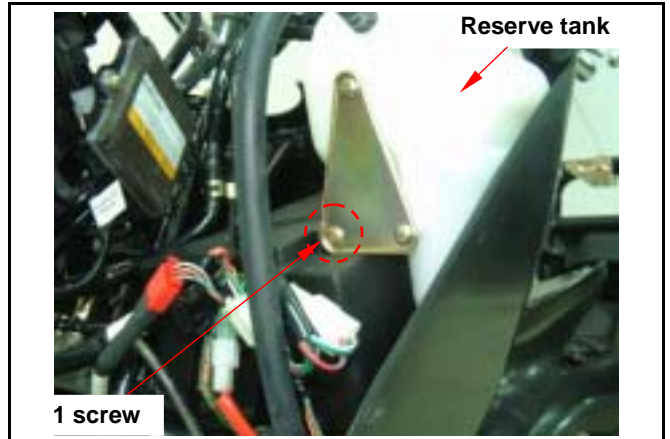

Loosen 1 screw from fuse box and remove it. Loosen 1 screw from main switch cap and remove the cap.

Loosen DC power outlet mounting nut, and remove DC power outlet.

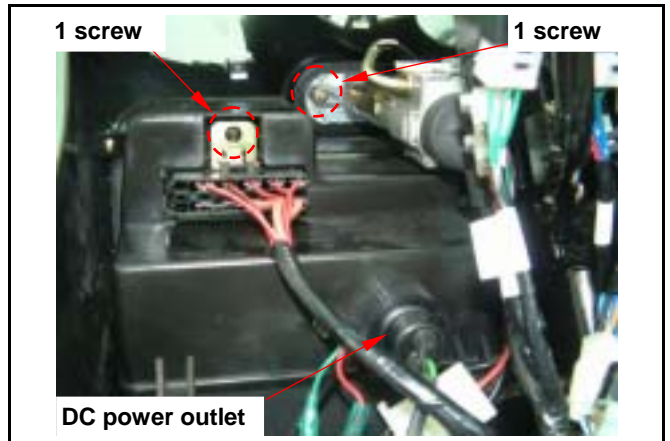

Loosen 1 screw from battery cover and remove it.



Remove the battery negative (-) cable. Remove the battery positive (+) cable. Remove the battery.

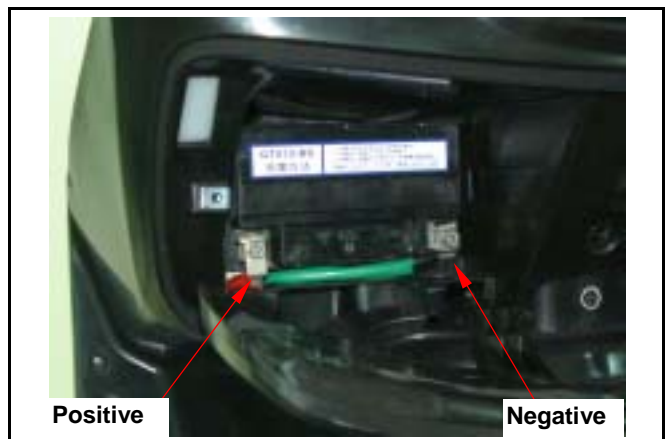

13. Body Cover

Remove the filler pipe cover.
Loosen 3 screws of the filler pipe.

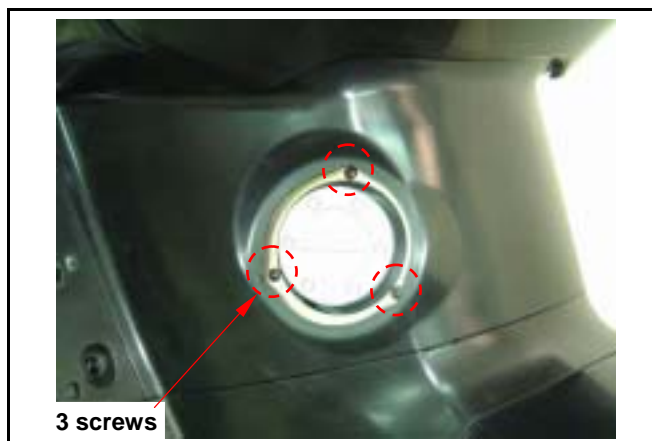

Loosen 2 bolts from inner box under side.

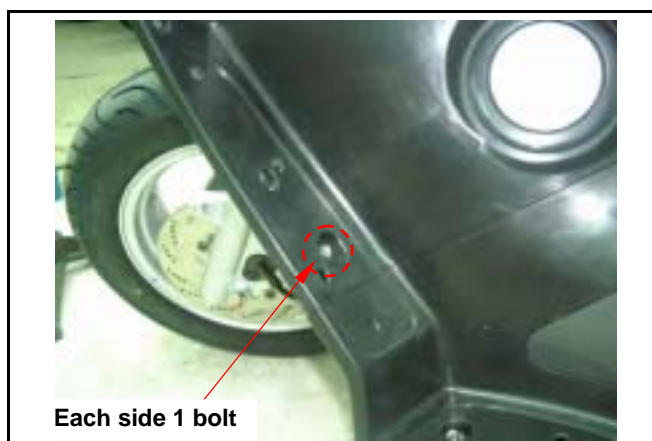

Loosen 2 bolts from inside of the inner box.
Disconnect the hazard light and foggy light switch couplers.
Remove inner box.

Installation

Install in reverse order of removal procedures.

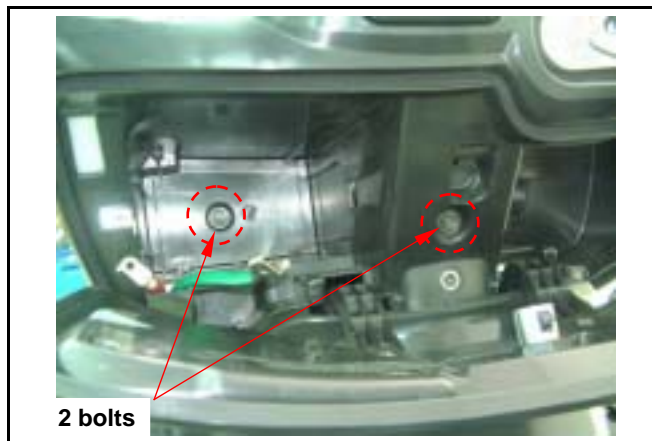

Side Cover

Remove

Loosen 2 screws from the side cover side end.

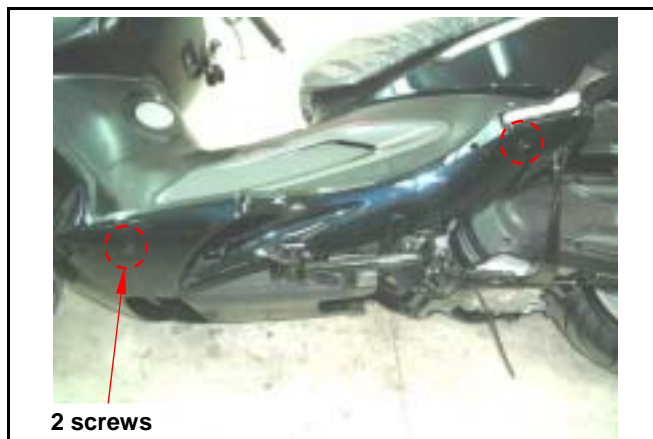

Loosen 2 screws from the side cover upper end.



Remove the side cover.

Installation

Install in reverse order of removal procedures.



13. Body Cover

Front under Spoiler

Remove

Remove wind screen garnish, wind screen, meter visor, front cover and R/L side cover.

Loosen 2 screw and 2 bolts from the front under spoiler upper end.

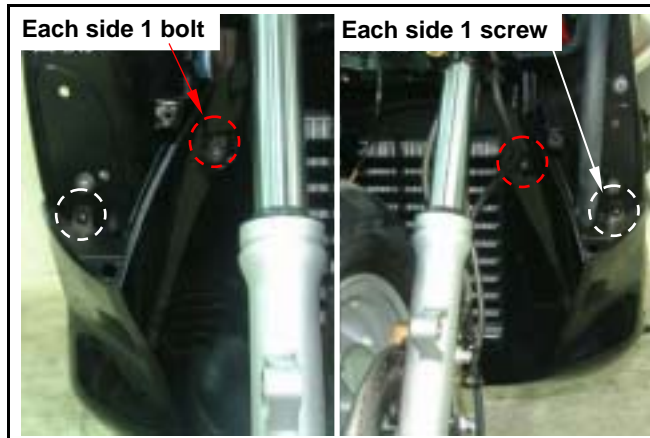

Remove the front spoiler.

Installation

Install in reverse order of removal procedures.



Rear Carrier

Remove

Loosen 4 bolts from the rear carrier and remove it.

Installation

Install in reverse order of removal procedures.

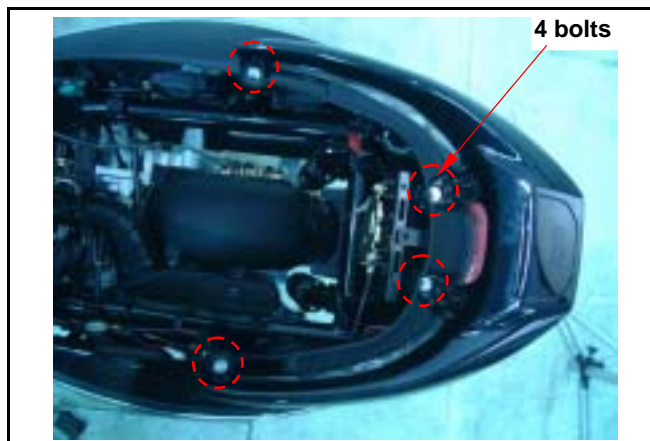

Luggage Box

Remove

Open the seat.
 Loosen 2 screws from the luggage box rear cover.
 Disconnect the luggage box light and switch coupler.
 Remove the luggage box rear cover.

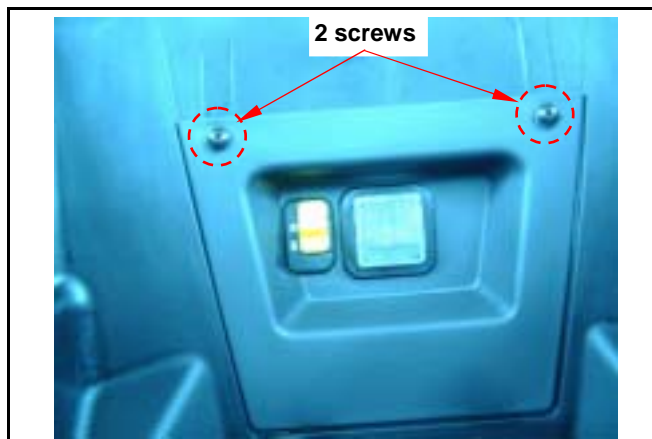

Loosen 2 bolts from luggage box front side



Loosen 4bolts from luggage box rear side.

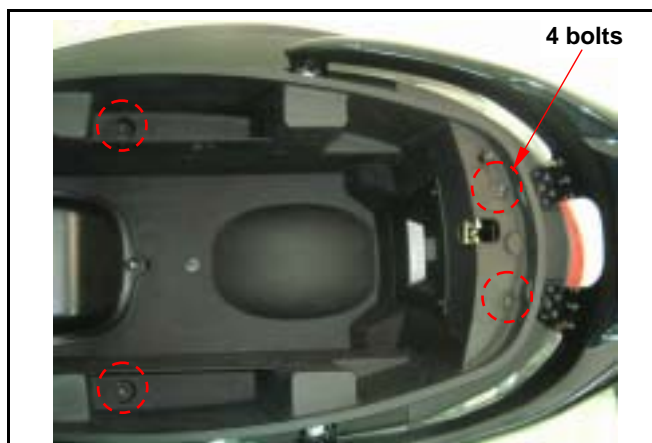

Remove the luggage box.

Installation

Install in reverse order of removal procedures.



13. Body Cover

Rear Body Cover

Remove

Loosen right and left side screws from rear end of floor panel.



Loosen right and left side screws from rear side of the body cover.



Disconnect the tail light coupler.



Remove the body cover.

Installation

Install in reverse order of removal procedures.



Floor Panel

Remove

Remove wind screen garnish, wind screen, meter visor, front cover, R/L side cover, front under spoiler, inner box, luggage box and body cover. Loosen 4 bolts and 2 screws from floor panel.

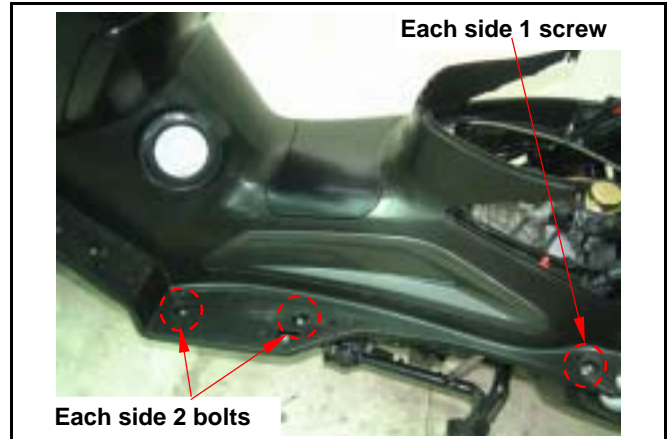

Remove floor panel.

Installation

Install in reverse order of removal procedures.



Front Fender

Remove

Loosen 4 screws from front cushion.



Remove the front fender.

Installation

Install in reverse order of removal procedures.



13. Body Cover

Rear Fender

Loosen 4 bolts from rear fender.

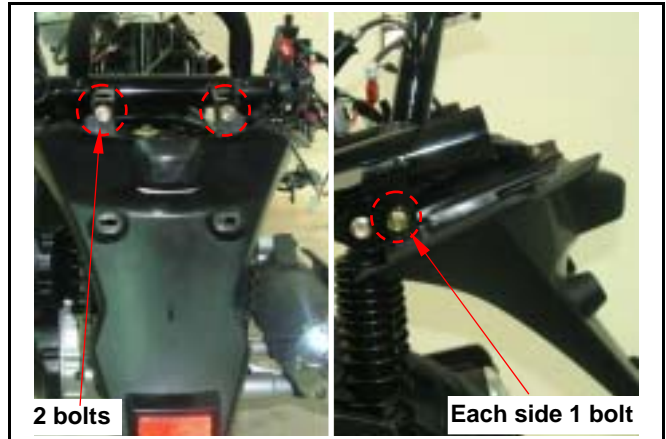

Remove the rear fender.

Installation

Install in reverse order of removal procedures.



Mechanism Diagram.....	14-1	Brake fluid replacement / Air-bleed..	14-6
Maintenance Description	14-2	Front Brake Caliper.....	14-7
Trouble Diagnosis	14-3	Rear Brake Caliper	14-8
Disk Brake System Inspection.....	14-4	Brake Disk	14-9
Adding Brake Fluid.....	14-5	Master Cylinder	14-9

Mechanism Diagram

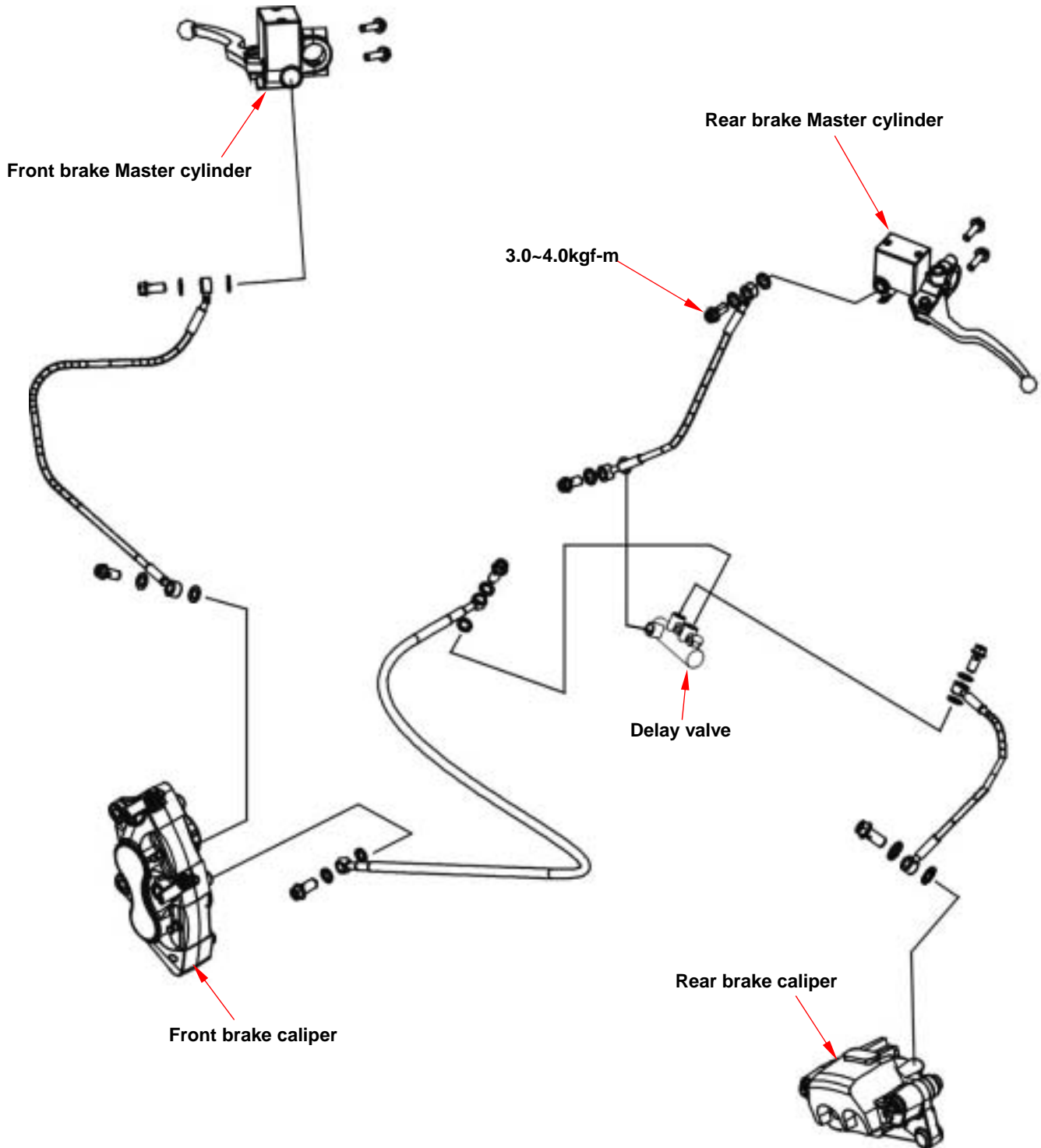

14. Brake System

Maintenance Description

Operational precautions

Caution

Inhaling asbestos may cause disorders of respiration system or cancer, therefore, never use air hose or dry brush to clean brake parts. Use vacuum cleaner or other authorized tool instead.

- The brake caliper can be removed without removing the hydraulic system.
- After the hydraulic system is removed, or the brake system is felt to be too soft, bleed the hydraulic system.
- While refilling brake fluid, care should be taken not to let the foreign material entering into the brake system.
- Do not spill brake fluid on the painted surfaces, plastic or rubber parts to avoid damage.
- Check the operation of the brake system before riding.

Specifications

unit: mm

Item	Standard	Limit
The thickness of front brake disk	4.000	2.500
The thickness of rear brake disk	5.000	3.500
Front and rear brake disk eccentricity	< 0.100	0.300
Front brake master cylinder inner diameter	11.000~11.043	11.055
Front brake master cylinder piston outer diameter	10.957~10.984	10.945
Rear brake master cylinder inner diameter	14.000~14.043	14.055
Rear brake master cylinder piston outer diameter	13.957~13.984	13.945
Diameter of front disk	240.000	
Diameter of rear disk	220.000	
Thickness of front brake lining	5.000	2.000
Thickness of rear brake lining	6.000	2.000

Torque values:

Brake hose bolts	3.0~4.0kgf-m
Bolt for front brake caliper	2.9~3.5kgf-m
Brake lever nut	0.8~1.0kgf-m
Air-bleed valve	0.8~1.0kgf-m

Trouble Diagnosis

Soft brake lever

1. Air inside the hydraulic system
2. Hydraulic system leaking
3. Worn master piston
4. Worn brake pad
5. Poor brake caliper
6. Worn brake lining/disk
7. Low brake fluid
8. Blocked brake hose
9. Warp/bent brake disk
10. Bent brake lever

Hard operation of brake lever

1. Blocked brake system
2. Poor brake caliper
3. Blocked brake pipe
4. Seized/worn master cylinder piston
5. Bent brake lever

Uneven brake

1. Dirty brake lining/disk
2. Poor wheel alignment
3. Clogged brake hose
4. Deformed or warped brake disk
5. Restricted brake hose and fittings

Tight brake

1. Dirty brake lining/disk
2. Poor wheel alignment
3. Deformed or warped brake disk

Brake noise

1. Dirty lining
2. Deformed brake disk
3. Poor brake caliper installation
4. Imbalance brake disk or wheel

14. Brake System

Disk Brake System Inspection

Inspection

By visual examination whether divulges or the damage, with spanner inspection brake tube seam whether becomes less crowded, and the inspection handle bar turn right or turn left, or pressure the cushion, whether besides the pipeline protection department, whether there is interferes, contacts other parts of.

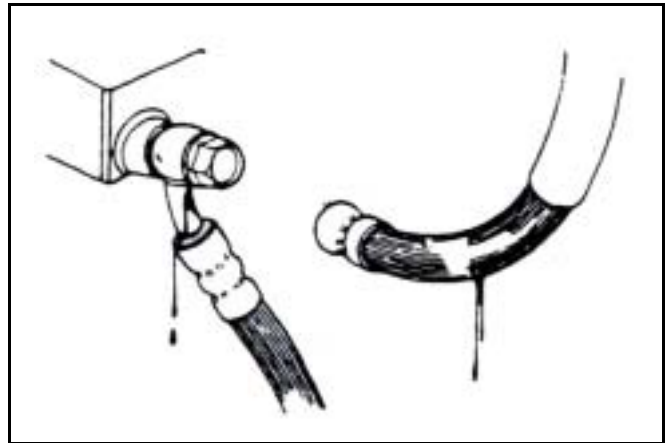

Remove the front brake pad cap.
Check the brake from behind the brake caliper.

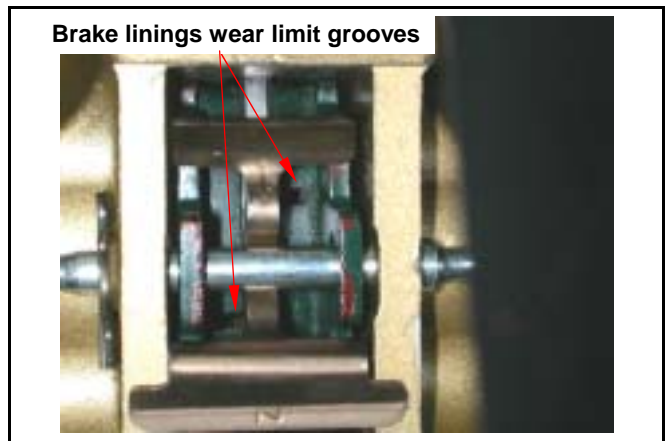

The brake pad must be replaced with new lining when the brake pad wear limit reaches the brake disk.

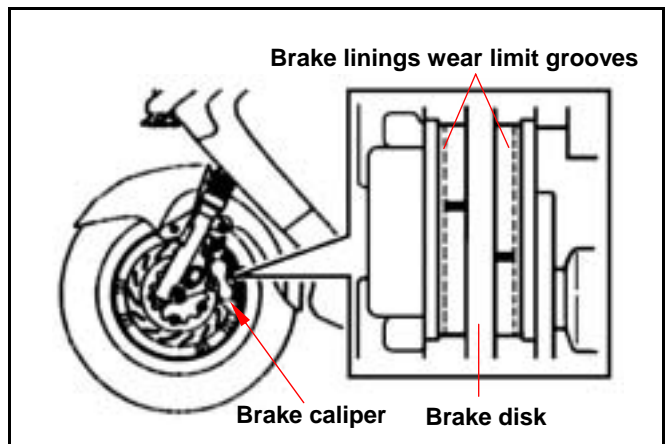

Park the motorcycle on a level ground, and check if fluid level is under the "LOWER" mark.
Recommended Brake Fluid: WELL RUN BRAKE OIL (DOT 3).

Caution

- The vehicles inclined or just stop, the survey oil level could not be accurate, had to settle the 3~5 minute.
- In order to prevent has the chemical change, please do not use counterfeiting or other unclear trade marks brake fluid.
- Uses by all means must with the trade mark brake fluid, guarantees the ghost vehicle efficiency.

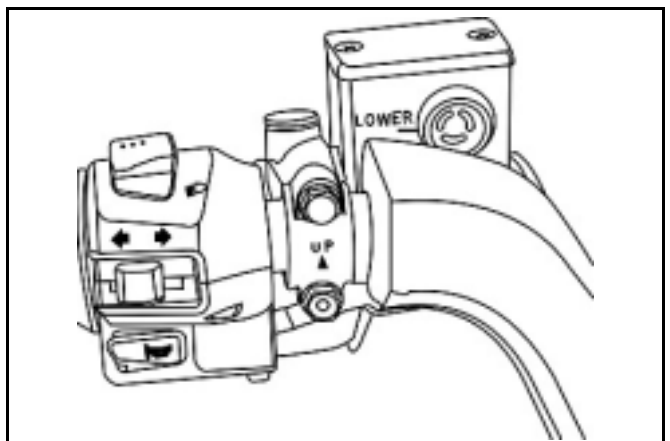

Adding Brake Fluid

Before the brake fluid reservoir is removed, turn the handle so that the brake fluid reservoir becomes horizontal, and then remove the brake fluid reservoir.

When maintenance brake system, will be supposed to paint the surface or the rubber parts catches up by the rags.

⚠ Caution

Supplement brake fluid please do not surpass the upper limit, spilled brake fluid on painted surfaces, plastic or rubber components may result in their damages.

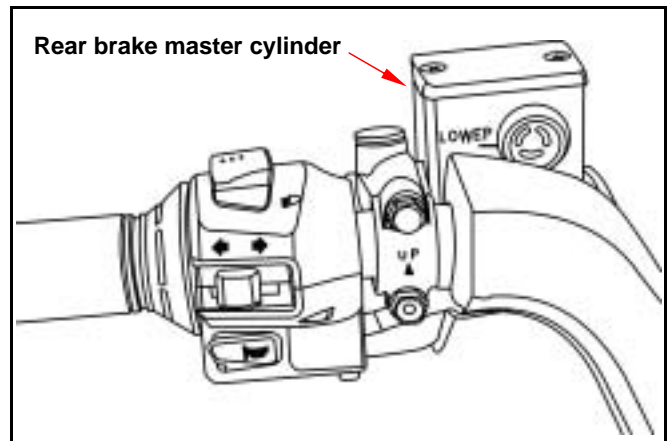
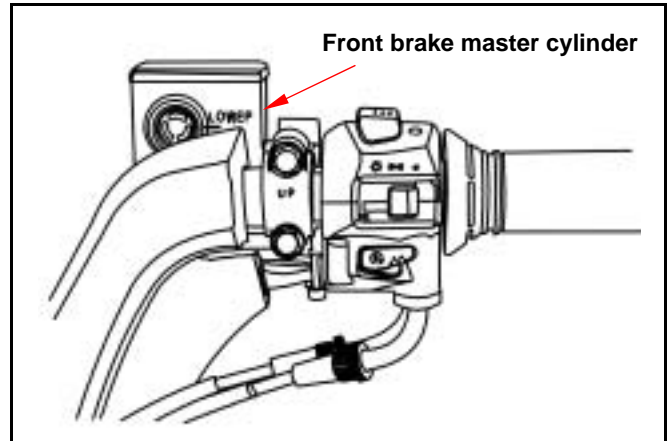

Remove the master cylinder cap and diaphragm. Increases the high quality brake fluid, uses by all means must with the trade mark brake fluid joins in the master cylinder. Clean the dirty brake disk.

⚠ Caution

- The dirty brake lining or disk will reduce the brake performance.
- To mixed non-compatible brake fluid will reduce brake performance.
- Foreign materials will block the system causing brake performance to be reduced or totally lost.

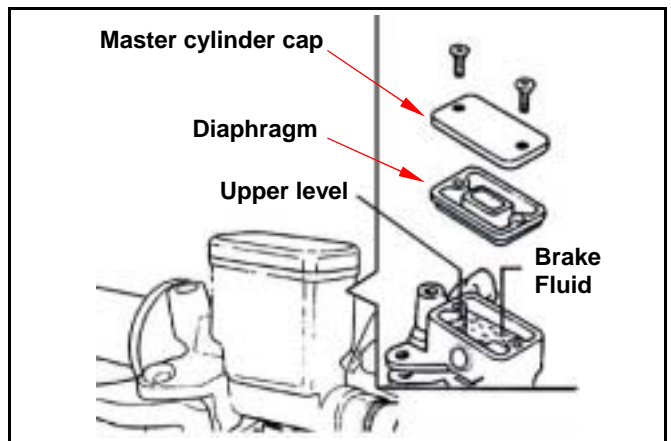

14. Brake System

Brake fluid replacement / Air-bleed

Connect drain hose to air-bleed valve.

Open the drain valve on the calipers and delay valve the brake lever until the old brake fluid is entirely drained out.

Close the drain valve and add specified brake fluid into the brake master cylinder.

Recommended brake fluid: WELLRUN DOT 3 brake fluid

Connect one end of transparent hose to the drain valve, and put the other end into a container.

Open the drain valve around 1/4 turns, and at the same time hold the brake lever until there is no air bubble in the drain hose and also feeling resistance on the brake lever.

Close the drain valve when finishing the brake system refilling fluid procedure, and operate the brake lever to check whether air bubble is in brake system or not.

If brake is still soft, please bleed the system as described below:

1. Tightly hold the brake lever and open the drain valve around 1/4 turns, and then close the valve.

Caution

- Do not release the brake lever before the drain valve is closed.
- Always check the brake fluid level when carrying out the air bleeding procedure to avoid air enter into the system.

2. Slowly release the brake lever, and wait for a few seconds until it reaches its top position.
3. Repeat the steps 1 and 2 until there is no air bubble at the end of the hose.
4. Tightly close the drain valve.
5. Make sure the brake fluid is in the UPPER level of the master cylinder, and refill the fluid if necessary.
6. Cover the cap

Caution

Divulges the air to have to pump by the minute first divulges, then to caliper.
May use fluid the replacement machine, the replacement fluid, the time is quicker, the air bubble also Compared with cannot remain

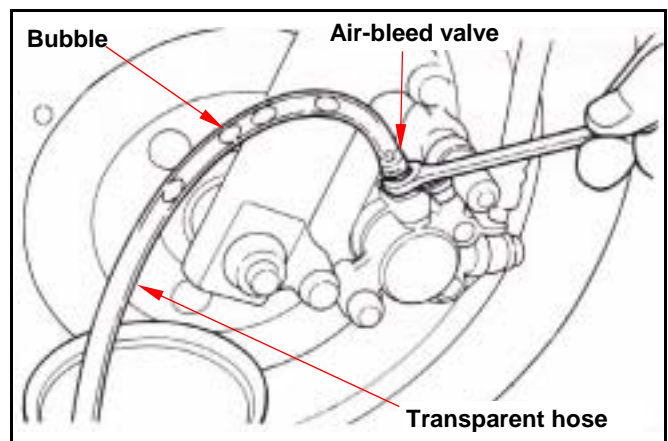
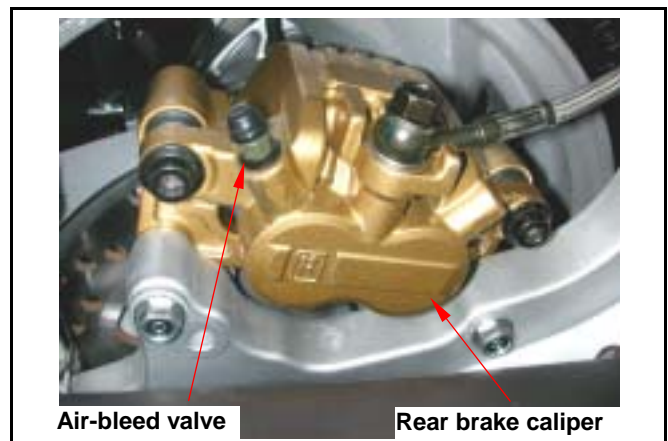
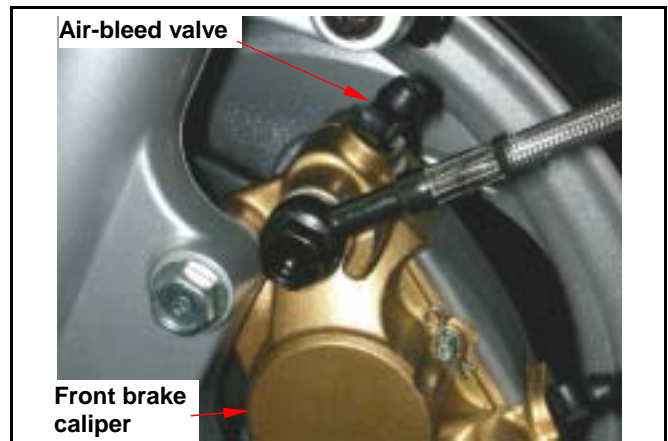
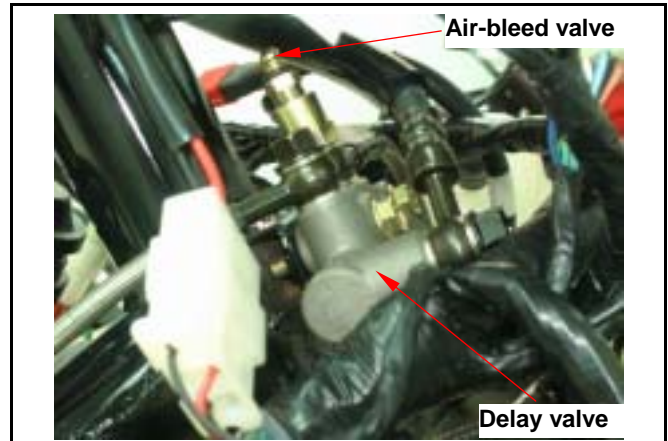

Front Brake Caliper

Removal

Place a container under the brake caliper, and loosen the brake hose bolts and finally remove the brake hoses.

⚠ Caution

Do not spill brake fluid on painted surfaces.

Remove two caliper mounting bolts and the caliper.

Installation

Install the brake caliper and tighten the mounting bolts.

Torque: 2.9~3.5kgf-m

⚠ Caution

- Use M8 x 35 mm flange bolt only.
- Long bolt will impair the operation of brake disk.

Use two seal washers and hose bolts to lock the hoses and brake caliper in place.

Torque: 3.0~4.0kgf-m

Refill up the brake fluid to the reservoir and make necessary air bleeding.

Brake pad replacement

Remove brake caliper.
Remove brake pad caps.
Remove the brake pad guidance shafts cotter pins.

Remove the brake pad guidance shafts and locking spring, and then remove brake pads.

Install the new brake pads onto brake caliper.
Install the brake pad guidance shafts and locking springs.
Install the brake pad guidance shafts cotter pins.
Install the brake caliper and tighten the mounting bolts.

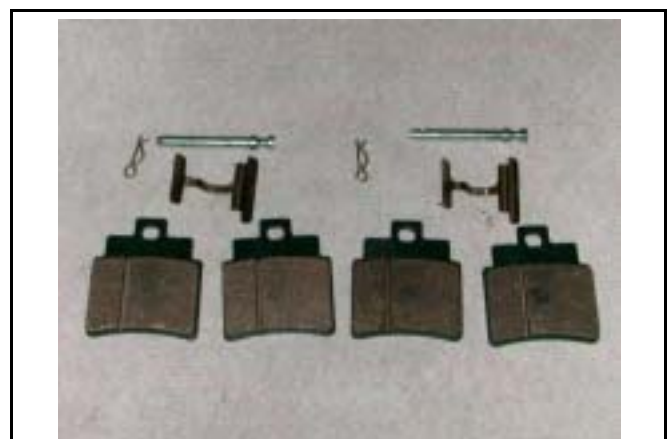
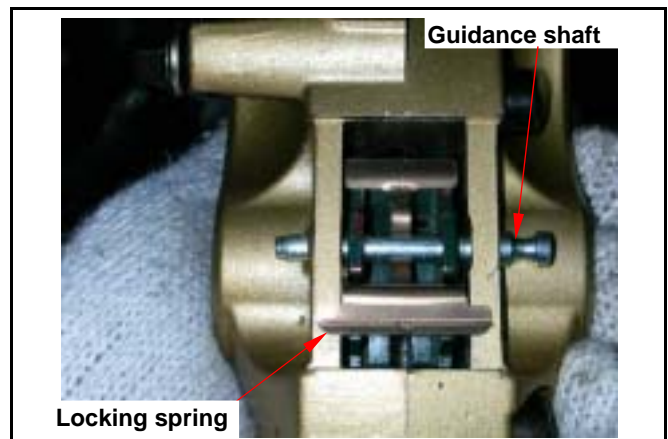
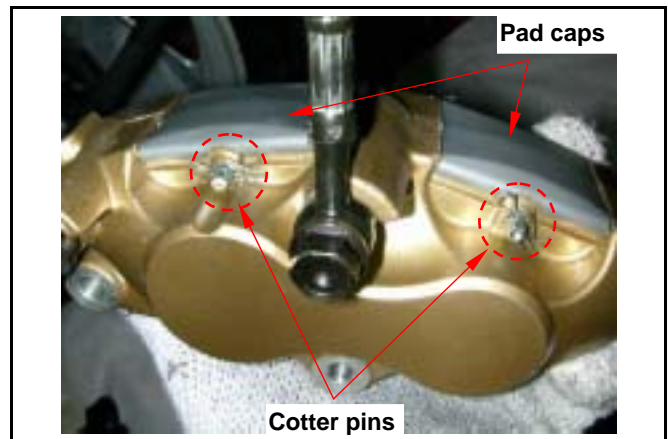
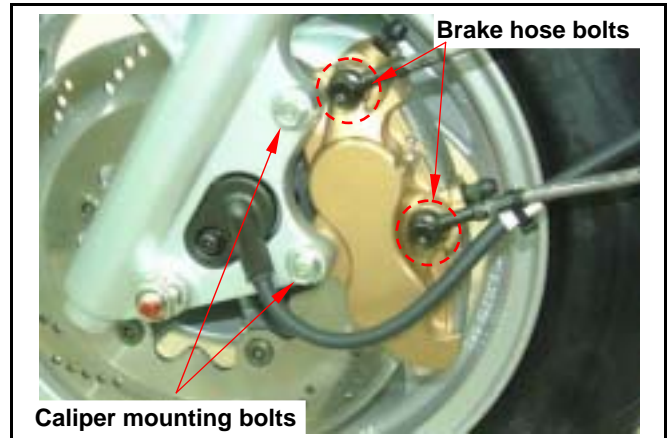

14. Brake System

Rear Brake Caliper

Removal

Place a container under the brake caliper, and loosen the brake hose bolt and finally remove the brake hose.

⚠ Caution

Do not spill brake fluid on painted surfaces.

Remove two caliper mounting bolts and the caliper.

Installation

Install the brake caliper and tighten the mounting bolts.

Torque: 2.9~3.5kgf-m

⚠ Caution

- Use M8 x 35 mm flange bolt only.
- Long bolt will impair the operation of brake disk.

Use two seal washers and hose bolts to lock the hoses and brake caliper in place.

Torque: 3.0~4.0kgf-m

Refill up the brake fluid to the reservoir and make necessary air bleeding.

Brake pad replacement

Remove the brake caliper upper parts (2 socket bolts).

Take out the brake pads.

Install the new brake pads onto brake caliper bracket.

Install the brake caliper upper parts and tighten the socket bolts.

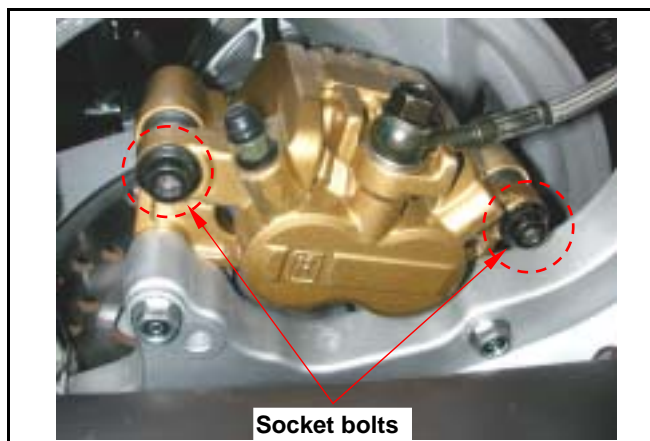
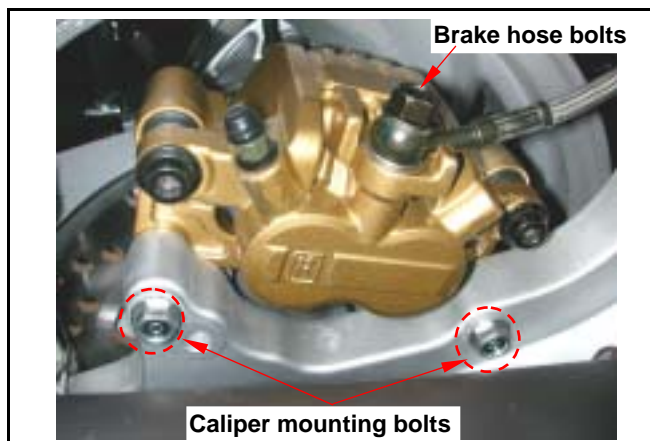

Brake Disk

Inspection

Visually check the brake disk for wear or break. Measure the thickness of the disk at several places. Replace the disk if it has exceeded the service limit.

Allowable limit:

Front brake disk 2.5 mm

Rear brake disk 3.5 mm

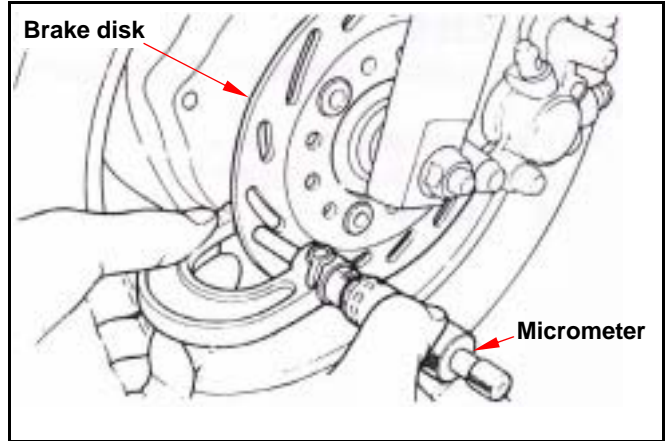

Remove the brake disk from wheel. Check the disk for deformation and bend.

Allowable limit: 0.30 mm

⚠ Caution

- The dirty brake lining or disk will reduce the brake performance.
- Brake lining includes the asbestos ingredient, cannot use the air-gun to be clean, the operator should dress the mouthpiece and the glove, use vacuum cleaner clean it.

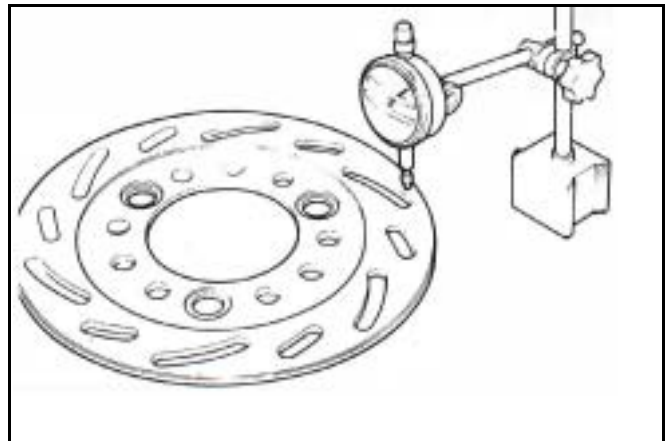

Master Cylinder

Master Cylinder Removal

⚠ Caution

Do not let foreign materials enter into the cylinder.

⚠ Caution

The whole set of master cylinder, piston, spring, diaphragm and cir clip should be replaced as a set.

- Remove the handlebar covers.
- Remove the leads of brake light switch.
- Drain out the brake fluid.
- Remove the brake lever from the brake master cylinder.
- Remove the brake hose.
- Remove the master cylinder bolts and the master cylinder.

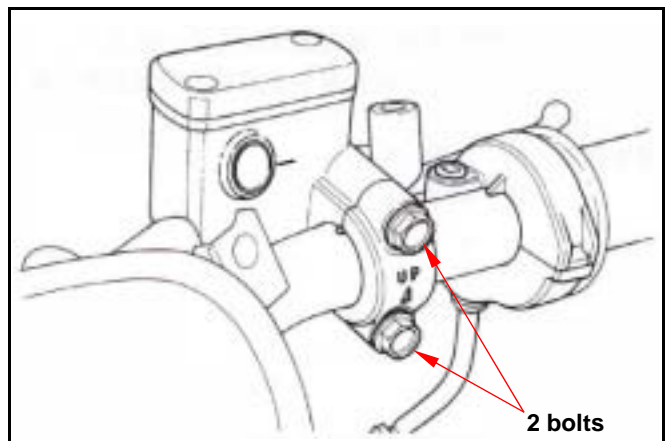
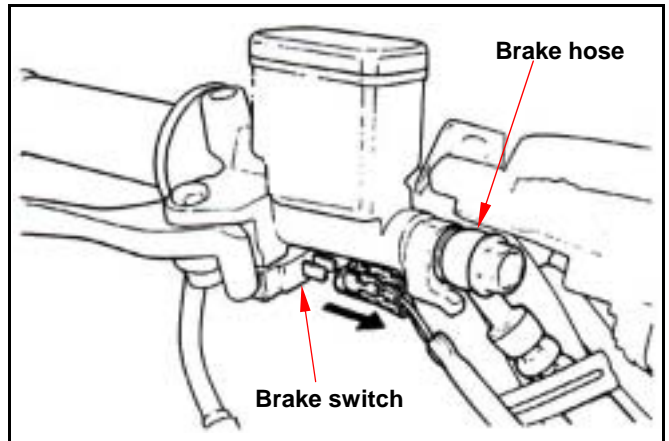

14. Brake System

Remove the rubber pad.
 Remove the cir clip.
 Remove the piston and the spring.
 Clean the master cylinder with recommended brake fluid.

Master Cylinder Inspection

Check the master cylinder for damage or scratch.
 Replace it if necessary.
 Measure the cylinder inner diameter at several points along both X and Y directions.
 Replace the cylinder if the measured values exceed allowable limit.

Allowable limit:

Front brake: 11.055 mm

Rear brake: 14.055 mm

Measure the outer diameter of the piston.
 Replace the piston if its measured value exceeds allowable limit.

Allowable limit:

Front brake: 10.945 mm

Rear brake: 13.945 mm

Master Cylinder Assembly

⚠ Caution

- It is necessary to replace the whole set comprising piston, spring, piston cup, and cir clip.
- Make sure there is no dust on all components before assembling.

Apply clean brake fluid to the piston cup, and then install the cup onto the piston.

Install the larger end of the spring onto the master cylinder.

The master cup's cavity should be face inside of master cylinder when installing the master cup.
 Install the cir clip.

⚠ Caution

- Never install cup lip in the opposite direction.
- Make sure the cir clip is seated securely in the groove.

Install the rubber pad into groove properly.

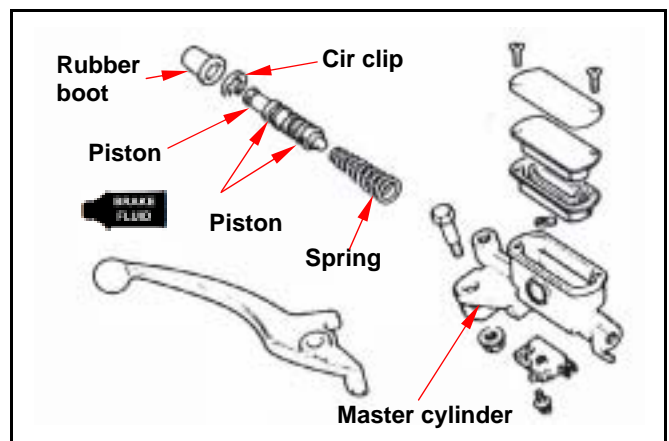
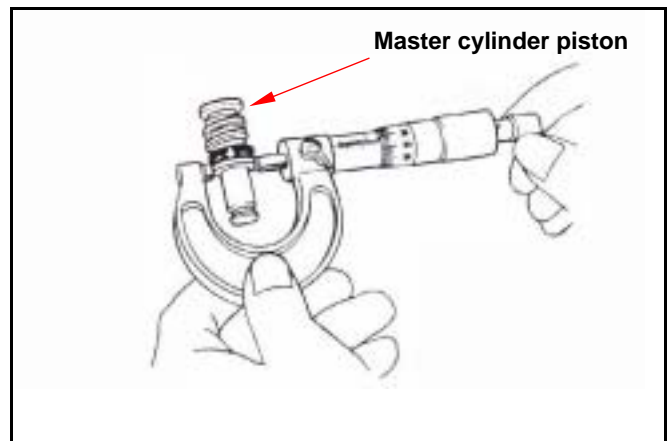
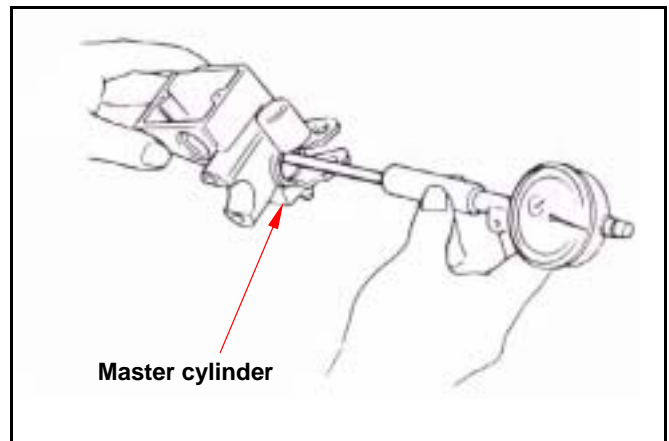
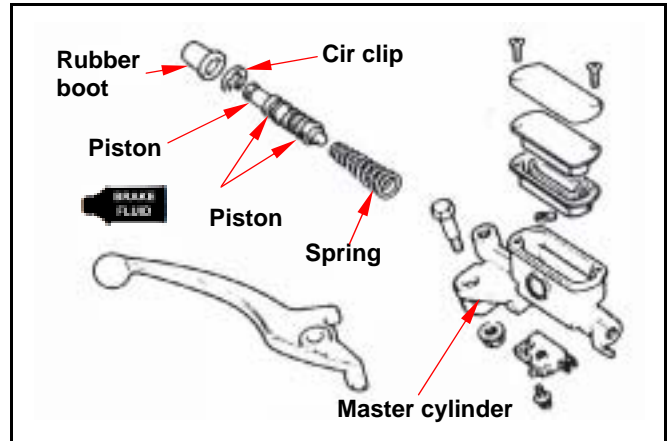

Master Cylinder Install

Install the rubber pad into the groove correctly. Place the master cylinder onto handlebar, and install the bolts. Install the brake lever, and connect leads to brake light switch.

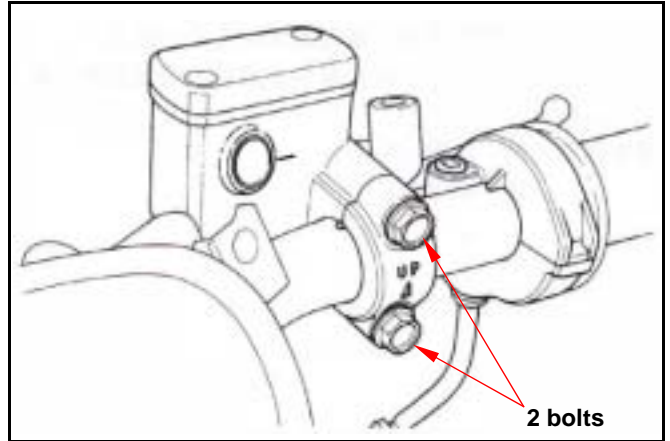

Connect brake hoses with 2 new washers. Tighten the brake hose bolt to the specified torque value. Make sure the hose is installed correctly. Install all wires, hoses, and components carefully so avoid to twisting them together.

⚠ Caution

Improper routing may damage leads, hoses or pipes.

⚠ Caution

Kink of brake leads, hose or pipe may reduce brake performance.

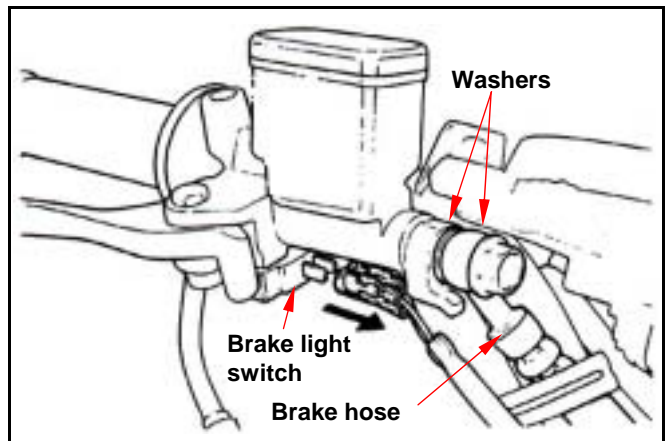

Add specified brake fluid and bleed the system.

14. Brake System

Note:

15. Steering / Front Wheel / Front Cushion

Mechanism Diagram	15-1	Front Wheel	15-5
Operational Precautions	15-2	Front Cushion	15-8
Trouble Diagnosis	15-2	Steering Stem	15-9
Steering Handle	15-3		

Mechanism Diagram

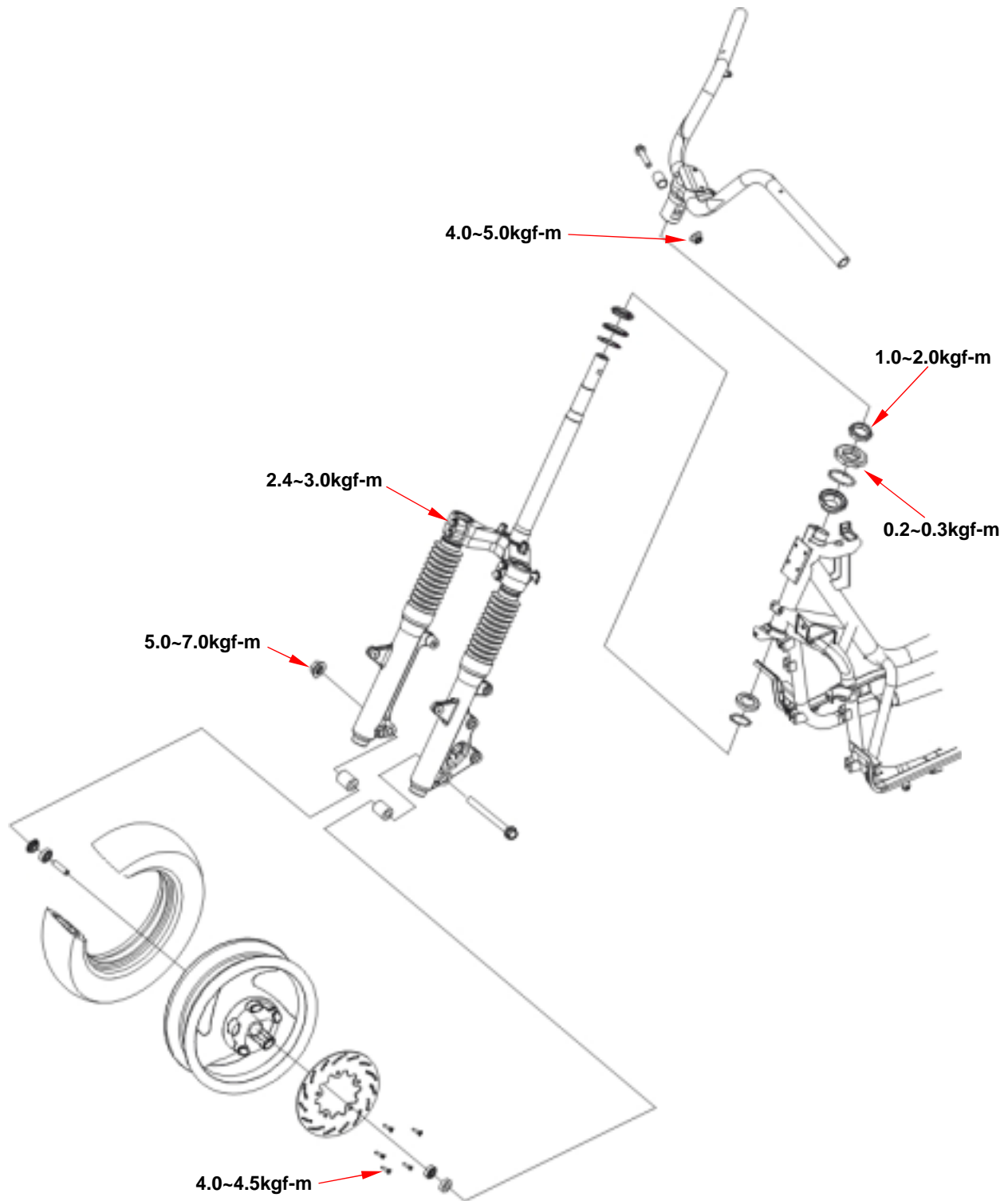

Operational Precautions

General

Please refer to the Maintenance Manual of tubeless tire in respect to the removal, repair and installation of the tire.

Torque Values

Nut for the front wheel axle	5.0 ~ 7.0kgf-m
Nut for the steering handle	4.0 ~ 5.0kgf-m
Lock nut for the steering handle stem	1.0 ~ 2.0kgf-m
Top crown for the steering handle stem	0.2 ~ 0.3kgf-m
Locating screw for the speedometer cable	0.15 ~0.3kgf-m
Front cushion upper lock bolt	2.4 ~ 3.0kgf-m
Front brake disk	4.0~4.5kgf-m

Special Tools

Steering handle top thread wrench	SYM-5320000、SYM-5321100
Inner bearing puller	SYM-6204020
Steering nut wrench	SYM-6204010
Driver 32*35mm	
Driver 42*47mm	

Trouble Diagnosis

Hard to steer

- The steering handle stem nut is too tight.
- The ball and the top crown of the steering handle stem are damaged.
- Insufficient tire pressure.

The steering handlebar is tilted

- Uneven arrangement of the front cushion.
- The front fork is bent.
- The front wheel axle is bent

The front wheel rim run-out

- The rim is bent.
- The wheel axle nut is not tightened enough.
- Side-worn or poor tire.
- The bearing clearance of the wheel axle is too large.

Soft front cushion

- The front cushion spring is worn out.
- The oil seal of the front cushion is leaking.

Noise in front cushion

- Front cushion is warped.
- The joint of the front cushion gets loose.

Steering Handle

Remove

Remove the right and left handle side cover, handle upper cover and front cover. (Refer to chapter 13)

Loosen the lock bolts for the master cylinder of the front brake.

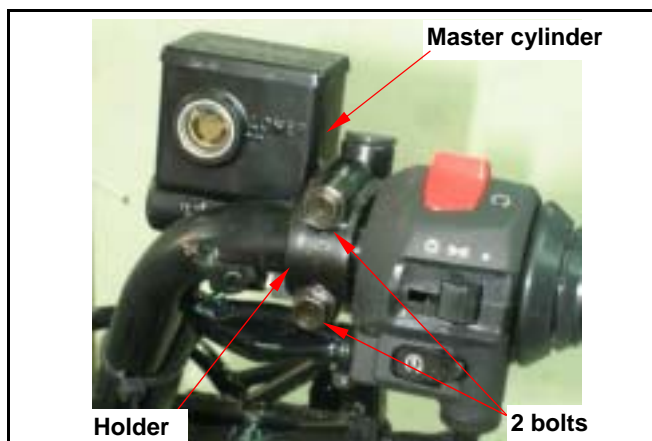

Loosen the deceleration throttle cable fixing nut. Loosen 1 screw from the acceleration throttle fixing plate.

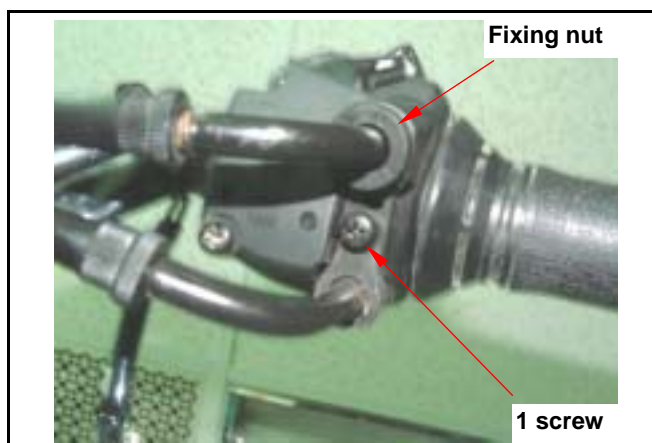

Loosen 2 screws from the throttle holder.

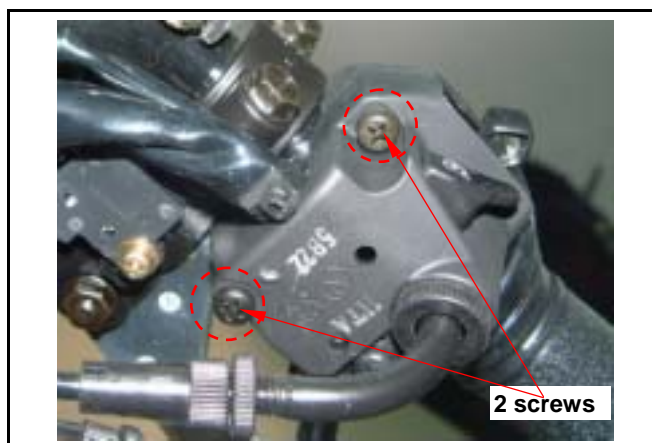

Remove throttle holder, handle switch, cables and grip.

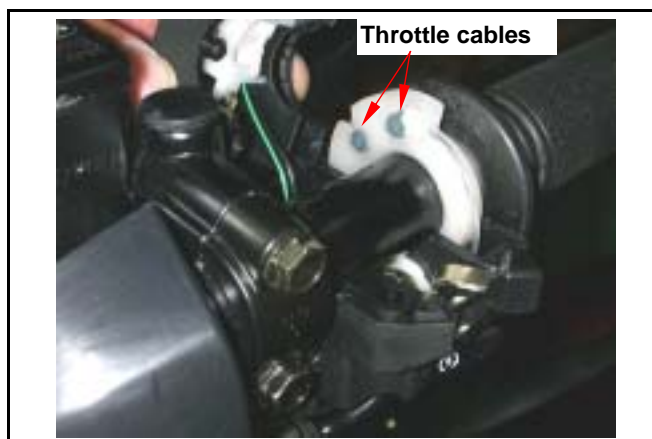

Loosen 2 bolts from the master cylinder of the rear brake.
Remove holder and master cylinder.

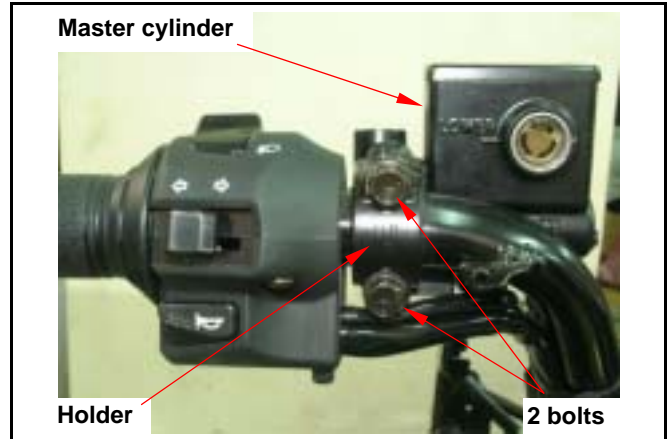

Loosen left handle switch connector.
Loosen 2 screws from left side handle switch holder.
Remove the right handle switch.

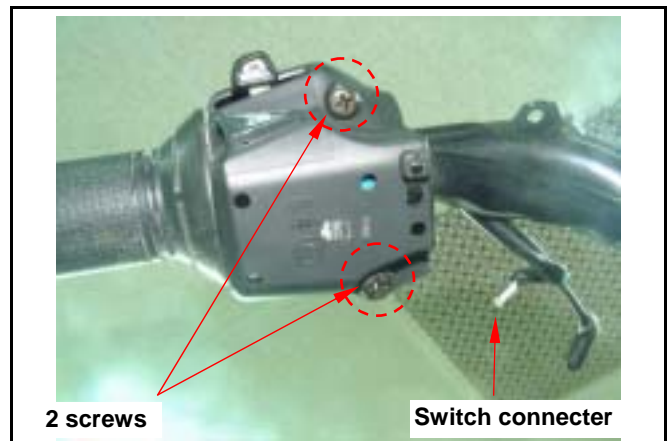

Loosen handle mounting nut.
Remove handle mounting bolt, and then remove the handle.

Installation

Install handle and align with bolt hole.
Install bolt and nut and then tighten it.

Torque value: 4.0~5.0kgf-m



Apply with grease onto throttle cable and the sliding surface of handle.
Align the lock pin with the hole on the handle.
After the installment completes, carries on the following inspection and the adjustment:

- Throttle grip operation.
- All electric appliances, the meter function



Front Wheel

Loosen 2 bolts from the front brake caliper and remove it

Caution

- Care shall be taken not to push the brake lever to avoid the brake pad being squeezed out. In case that the brake pad is accidentally squeezed out, use a screwdriver to force it back to the place.

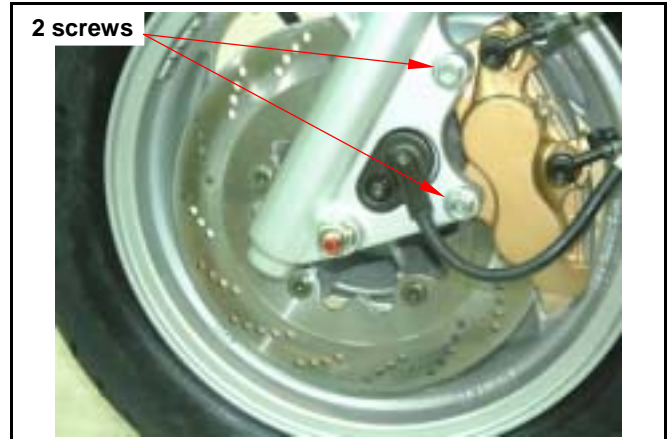

Loosen screw & remove speedometer cable.
Turn loose the axle nut.

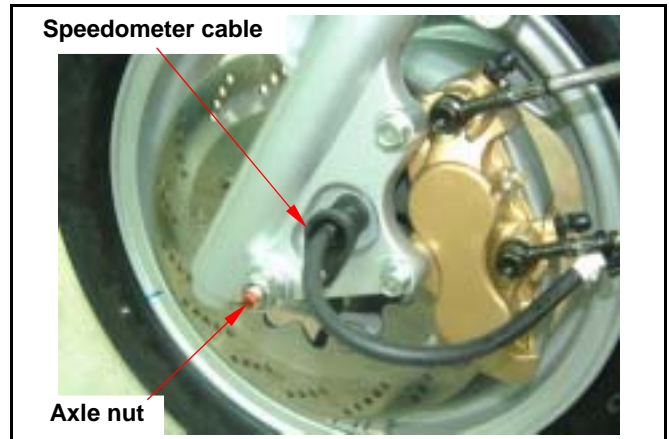

Pull out the front wheel axle.
Remove the front wheel and both side collar.



Inspection

Wheel axle

Place the wheel axle on a V block, measure its run out.

Service limit: 0.2 mm

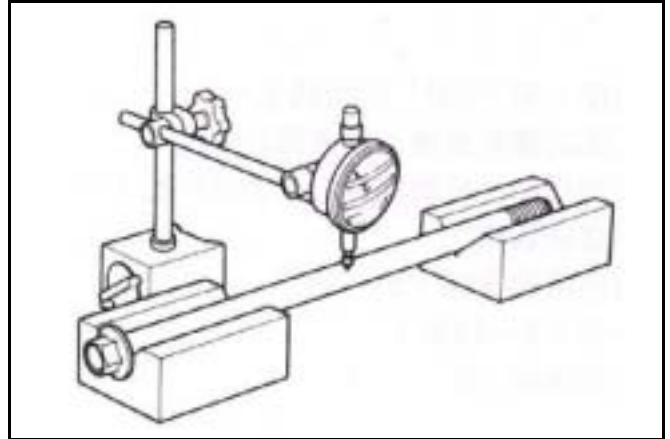

Bearing

Use finger to move the inner ring of each bearing, it shall move smoothly and quietly. Check the outer ring is securely attached on the wheel hub. If the motion of the inner ring of the bearing is not smooth, or noisy and loose when being moved, remove and discard it.

⚠ Caution

- The bearing shall be replaced in pair.

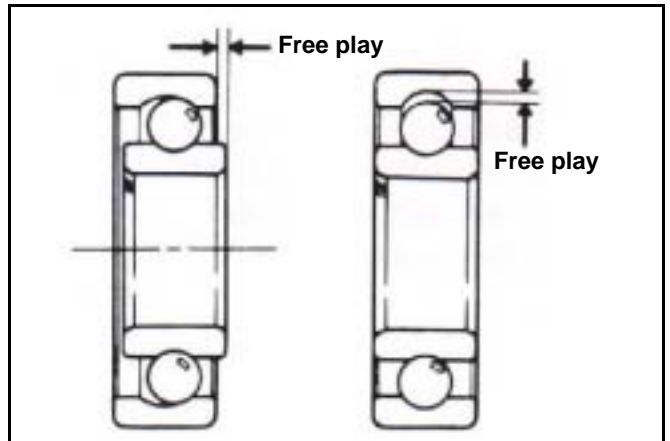

Wheel

Place the wheel on to a rotation seat to check its rim wobbling.

Turn the wheel with hand and measure its rim wobbling value with a dial gauge.

Service limit:

Radial: 2.0 mm (0.08 in)

Axial: 2.0 mm (0.08 in)

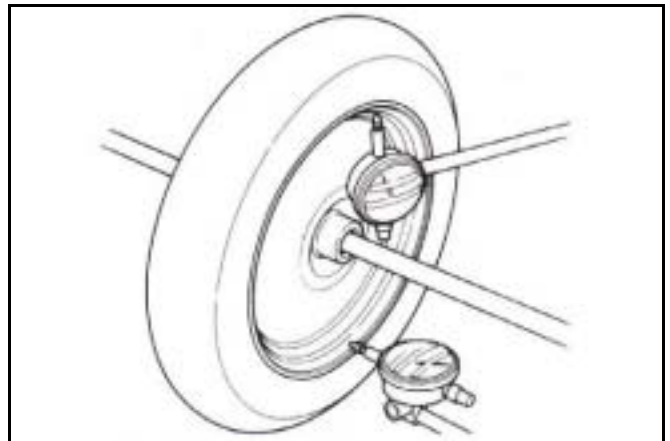

Disassembly

Remove brake disk (5 bolts).

Remove dust seal, bearing and dist collar from left side.

Remove dust seal and bearing from right side.

Special tools:

Inner bearing puller SYM-6204020

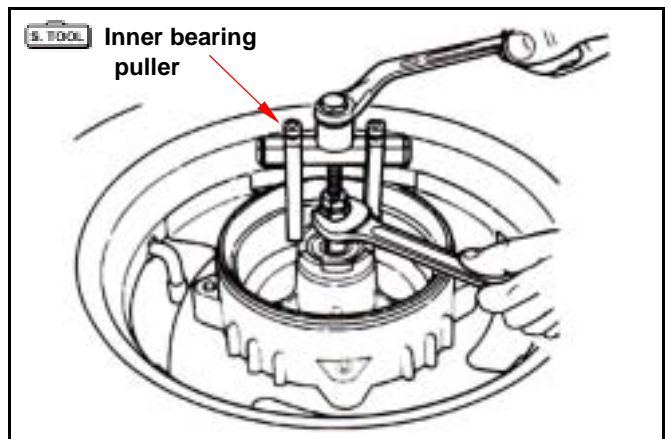

Assembly

Fill out the block of bearing by grease.
Drive the left bearing, dust seal and install the dist. collar.
Install the right side bearing.

⚠ Caution

- Carefully install the bearing in correct and evenly.
- Bearing outer face should be faced up as bearing installation.

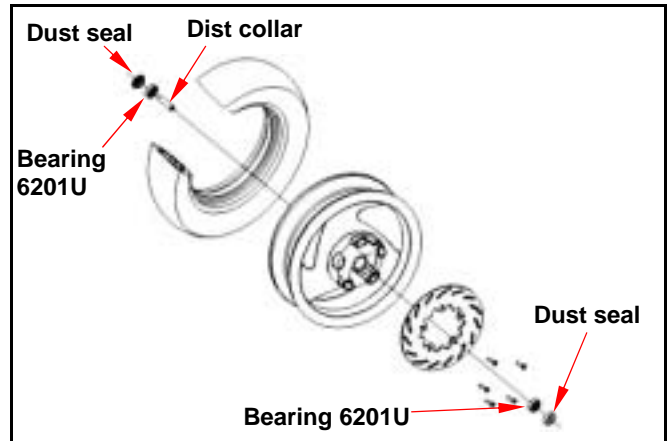

Install the brake disk and then tighten the bolts.

Torque value: 4.0~4.5kgf-m



Front Cushion

Remove

Remove front cover, front under spoiler and front fender.

Remove front wheel.

Remove front brake caliper.

Remove speedometer cable.

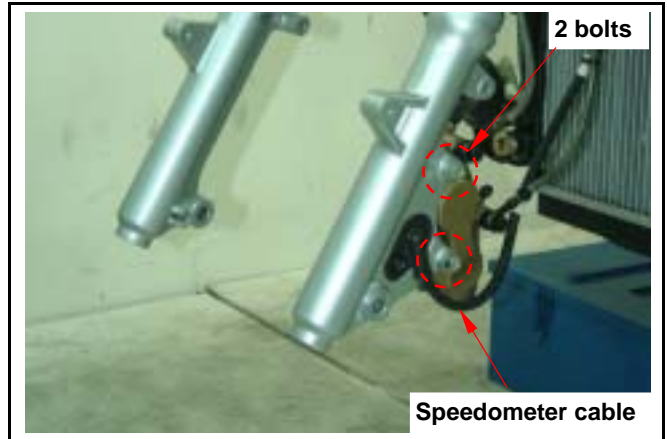

Loosen 4 bolts from steering stem.

Remove the front cushions.

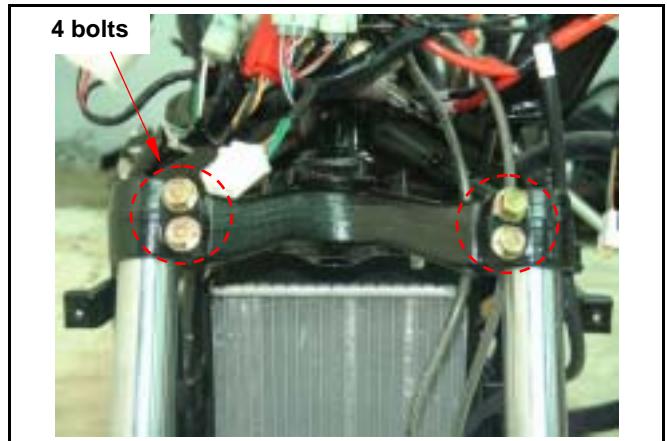

Installation

Align the cover flange with upper level of the cushion clamp, and then tighten bolts.

Torque value: 2.4~3.0kgf-m

Install the removed components in reverse order of removal procedures.

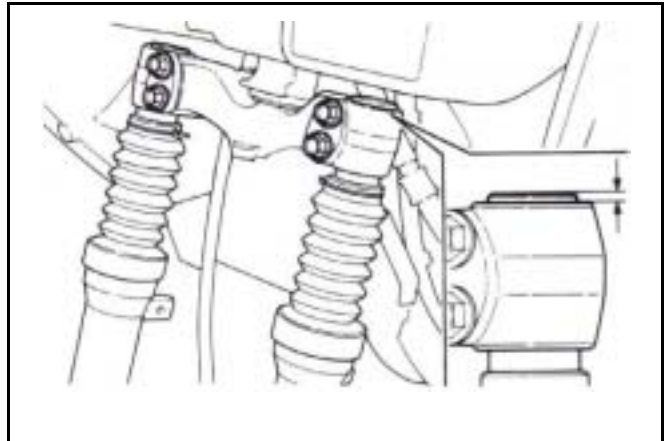

Steering Stem

Remove

Remove handle, front wheel and front cushion.
Remove the steering stem mounting nut.

Remove top cone race and steering stem.

⚠ Caution

- Place the steel ball onto a parts container to prevent from missing.

Special tools:

Steering stem top thread wrench SYM-5320010

Handle stand nut wrench SYM-5321100

Slightly tap the top and bottom ball bearing seats with a plastic hammer to remove the seats.
Remove bottom cone race body with a punch.

⚠ Caution

- Do not damage the steering stem.

Installation

Install a new bottom cone race onto the steering stem.
Push the cone race until to mounted position.

⚠ Caution

- Do not tilt the ball bearing seats as installation.

Apply with grease onto the ball bearing seats, and install steel balls onto the seats. (Top: 26 balls, bottom: 29 balls)

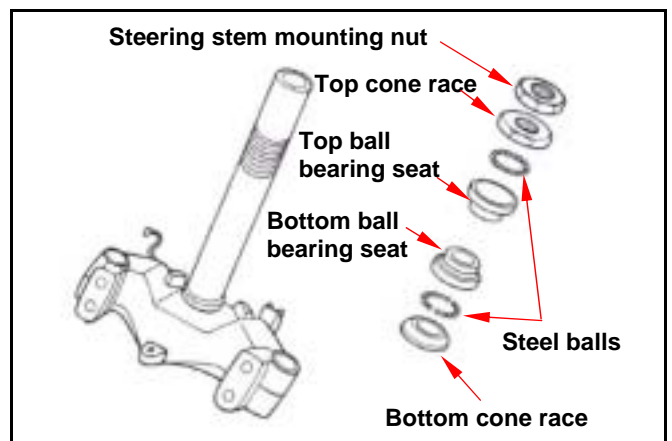
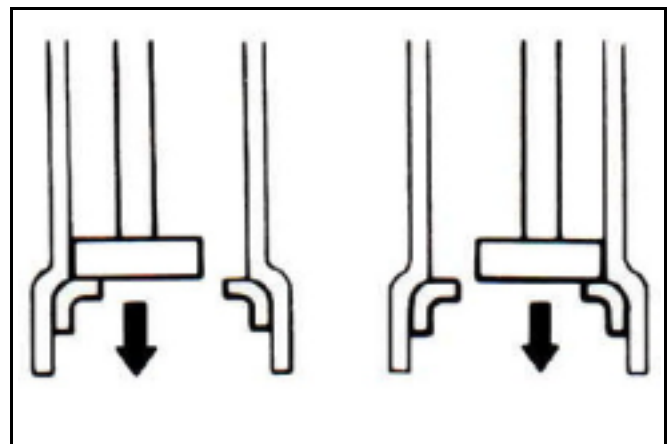
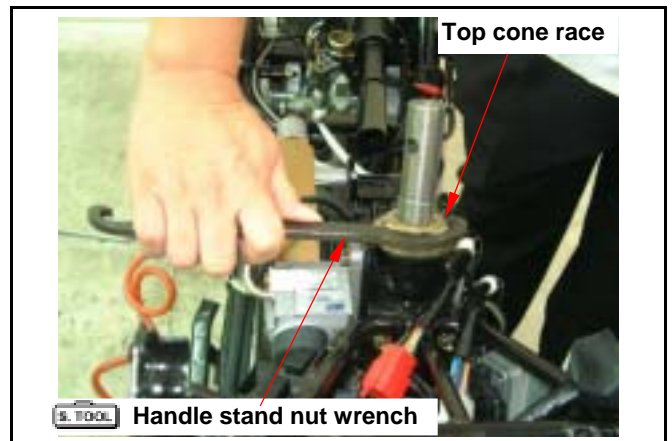
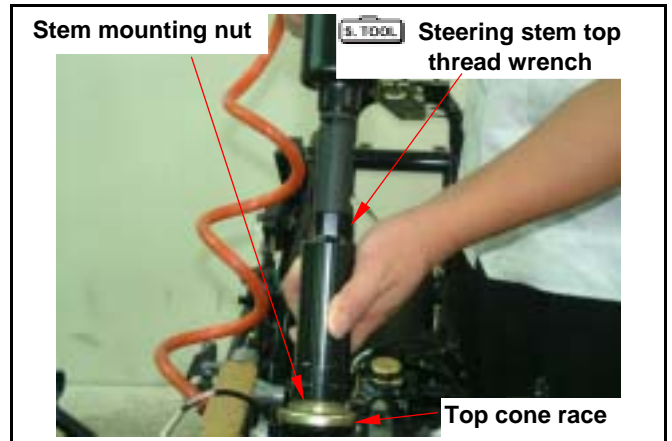

Lubricate the top cone race seat with grease. Screw the cone race in to top ball bearing seat till touching, and then screw out the cone race 1/4~3/8 turns.

Torque value: 0.25kgf-m

⚠ Caution

- Check the steering stem that should be rotated freely and no clearance in vertical direction.

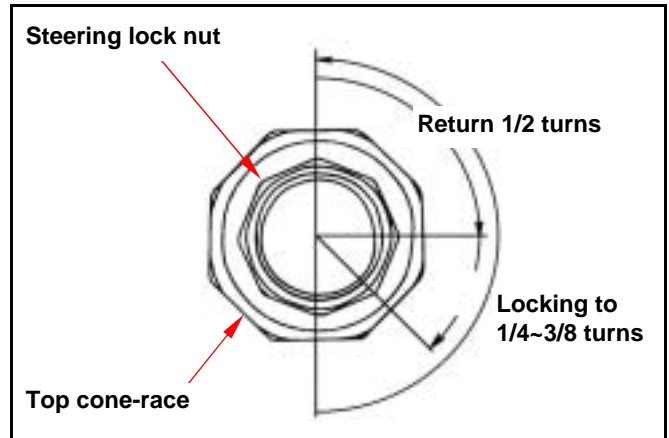

Install the steering stem mounting nut and tighten the nut by means of holding the top cone race body.

Torque value: 1.0~2.0kgf-m

Install in reverse order of removal procedures.





16. Rear Wheel / Rear Fork / Rear Cushion

Mechanism Diagram.....	16-1	Rear Wheel	16-3
Operational Precaution	16-2	Rear Fork	16-5
Trouble Diagnosis	16-2	Rear Cushion.....	16-6
Muffler.....	16-3		

Mechanism Diagram

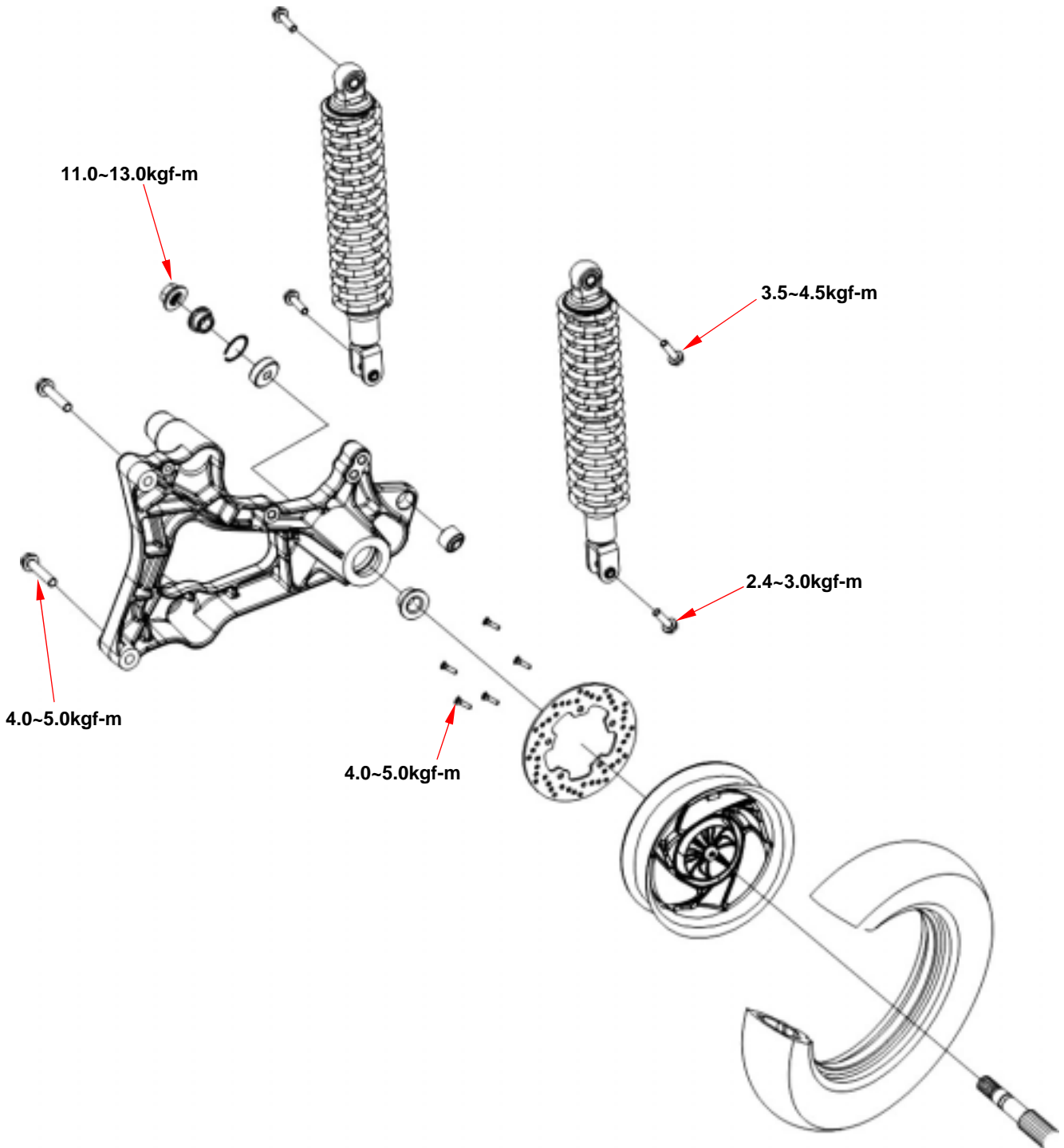

16. Rear Wheel / Rear Fork / Rear Cushion

Operational Precaution

General

Please refer to the Maintenance Manual for tubeless tire in respect to the removal, repair and installation of the tires.

Service data

Unit: mm

Item		Standard	Allowable Limit
Run-out of rear rim	Radial	-	2.0
	Axial	-	2.0

Torque Value

Rear wheel axle nut	11.0~13.0kgf-m
Rear cushion upper bolt	3.5~4.5kgf-m
Rear cushion under bolt	2.4~3.0kgf-m
Rear fork mounting bolt	4.0~5.0kgf-m
Exhaust muffler mounting nut	1.0~1.2kgf-m
Exhaust muffler mounting bolt	3.2~3.8kgf-m
Brake clipper mounting bolts	2.9~3.5kgf-m
Brake disc mounting bolt	4.0~5.0kgf-m

Trouble Diagnosis

Run-out of rear wheel

- Deformed or bent wheel hub.
- Improper tires.
- Loose wheel shaft.

Soft Cushion

- The spring is too weak.

Noisy Brake

- Worn brake lining.
- Offset brake disc.
- Improper assembly of brake caliper.
- Brake disc or wheel imbalance.

Poor Performance of Brake

- Improperly adjusted brake.
- Contaminated brake disc.
- Worn brake lining.
- Air inside brake fluid pipe.
- Grease on brake disc.
- The brake fluid piping is clogged.
- The brake fluid pipe is deformed or bent.
- The brake fluid pipe is deformed or bent.
- Insufficient amount of brake fluid in the reservoir

Muffler

Removal

Loosen the 2 nuts from exhaust muffler front side.

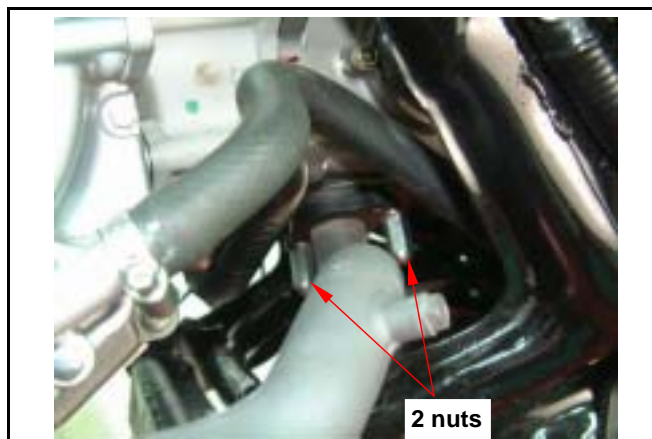

Loosen the 3 mounting bolts by exhaust muffler right side.
Remove exhaust muffler.



Installation

Install in reverse order of removal procedures.

⚠ Caution

- Replace the front side muffler pipe gasket if worn or deformed.

Torque Value:

Muffler mounting bolt 3.2 ~ 3.8kgf-m

Muffler mounting nut 1.0 ~ 1.2kgf-m

Rear Wheel

Removal

Remove the exhaust muffler.
Remove the rear brake caliper (2 bolts) and brake hose clamp (1 bolt).

⚠ Caution

- Care shall be taken not to push the brake lever to avoid the brake pad being squeezed out. In case that the brake pad is accidentally squeezed out, use a screwdriver to force it back to the place.

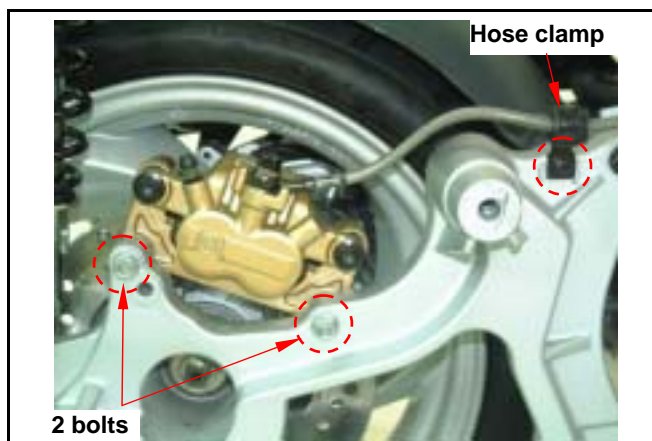

Remove the lower bolt of the right side rear cushion.
Remove 2 bolts of the rear fork.

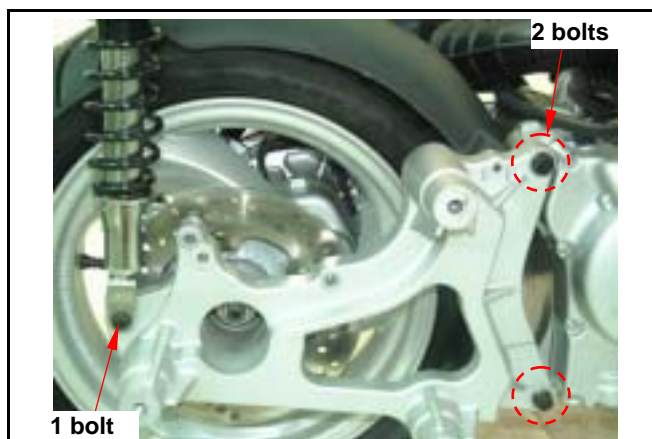

16. Rear Wheel / Rear Fork / Rear Cushion

Remove rear wheel axle nut.



Remove rear fork and both side collars.
Remove the rear wheel.



Inspection rear wheel rim

Place the wheel rim on a rotational support.
Rotate it by hand and measure the run-out with a dial indicator.

Run-out limit: 2.0 mm

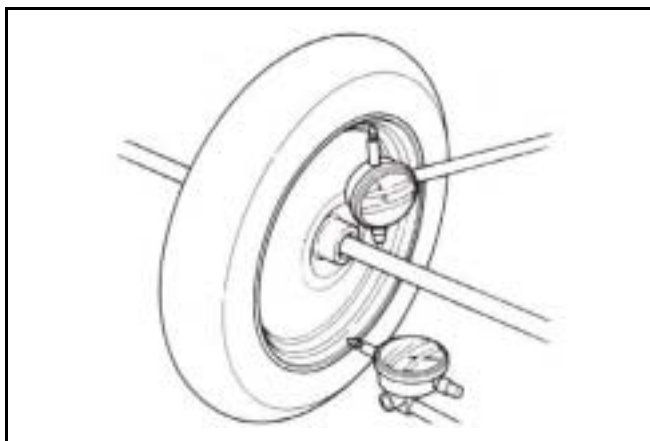

Installation

Install in reverse order of removal procedures.

Torque Value:

Rear wheel axle nut	11.0~13.0kgf-m
Rear cushion under bolt	2.4~3.0kgf-m
Rear fork mounting bolt	4.0~5.0kgf-m
Brake clipper mounting bolts	2.9~3.5kgf-m

Rear Fork

Inspection rear fork bearing

Rotate the inner ring of the bearing with a finger. The bearing should move smoothly and quietly. Check the fit of the bearing and rim. Replace the bearing if its motion is not smooth or noisy.

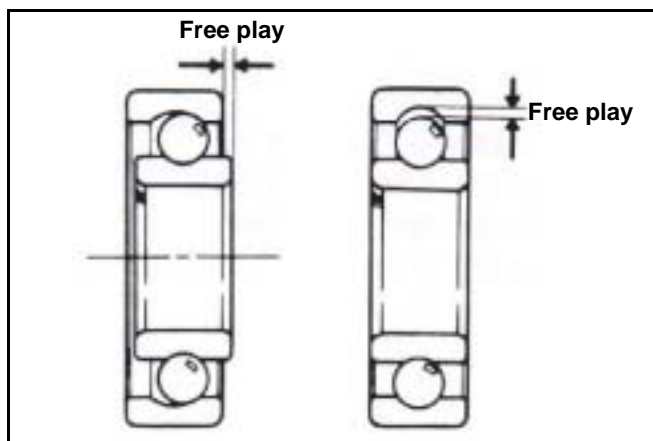

Replacement of rear fork bearing

Remove the bearing lock cir clip.

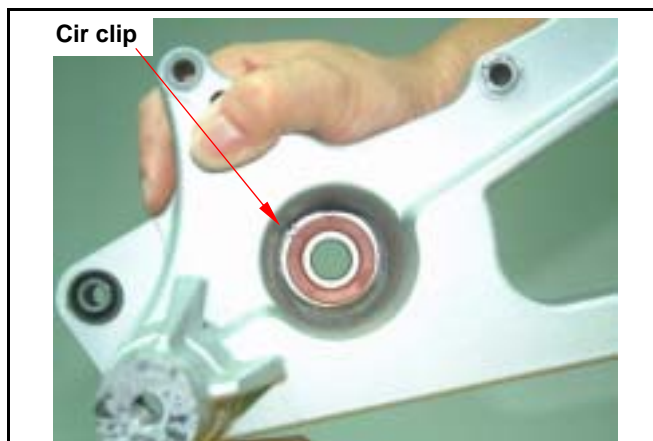

Uses the bearing driver; drive out the bearing.

Special tool: Bearing driver



Install new rear fork bearing and bearing puller (6303) onto rear fork.

Install assembly directs puller bearing puller.

Special Service Tools:

Rear fork bearing 6303 bearing puller

SYM-6303000-HMA H9A 6303

Assembly directs puller SYM-2341110

Use screw driver hold bearing puller lower part, and turn the bearing puller upper part to install the rear fork bearing.



16. Rear Wheel / Rear Fork / Rear Cushion



Install the bearing lock cir clip.

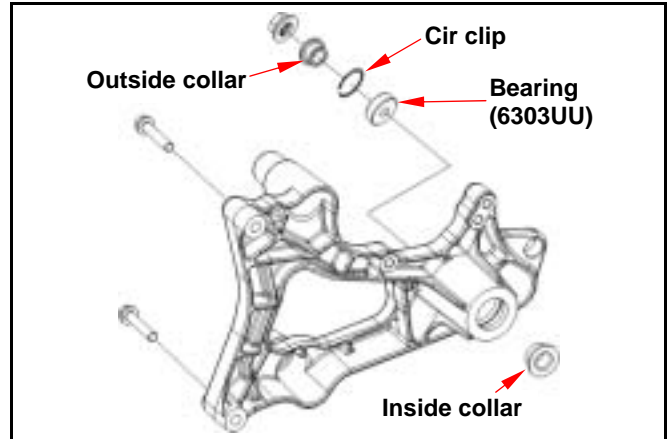

Rear Cushion

Removal

Remove the luggage box, rear carrier and body covers.

Loosen the mounting bolts of the air cleaner (2 bolts).

Remove the exhaust muffler (3 bolts, 2 nuts).

Remove the under bolts by left and right rear cushions.

Remove the upper bolts by left and right rear cushions, and then remove the cushion.

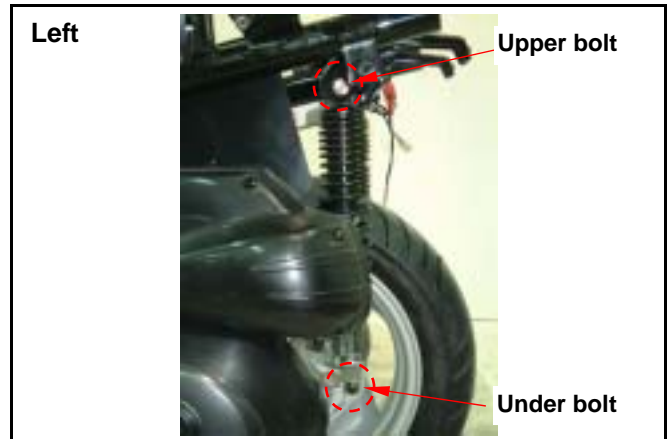

Installation

Install in reverse order of removal procedures.

⚠ Caution

- The rear cushion must be replaced as a unit. Never disassemble the rear cushion as that would damage the structure.

Torque Value

Rear cushion upper bolt: 3.5~4.5kgf-m

Rear cushion under bolt: 2.4~3.0kgf-m

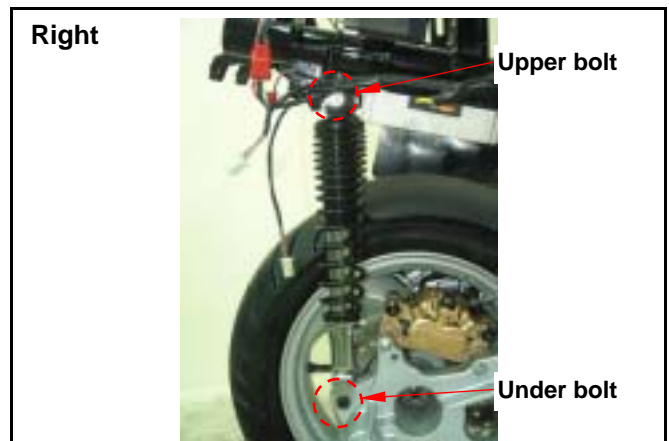

Mechanism Diagram	17-1	Starting System	17-11
Maintenance Data	17-2	Meters	17-13
Technical Specification	17-2	Light / Bulb	17-15
Trouble Diagnosis	17-3	Switch / Horn	17-19
Battery	17-4	Fuel Unit	17-21
Fuse	17-5	Cooling Fan Thermo Switch	17-22
Charging System	17-6	Thermo Sensor	17-23
Ignition System	17-9	Water Temperature Meter	17-23

Mechanism Diagram

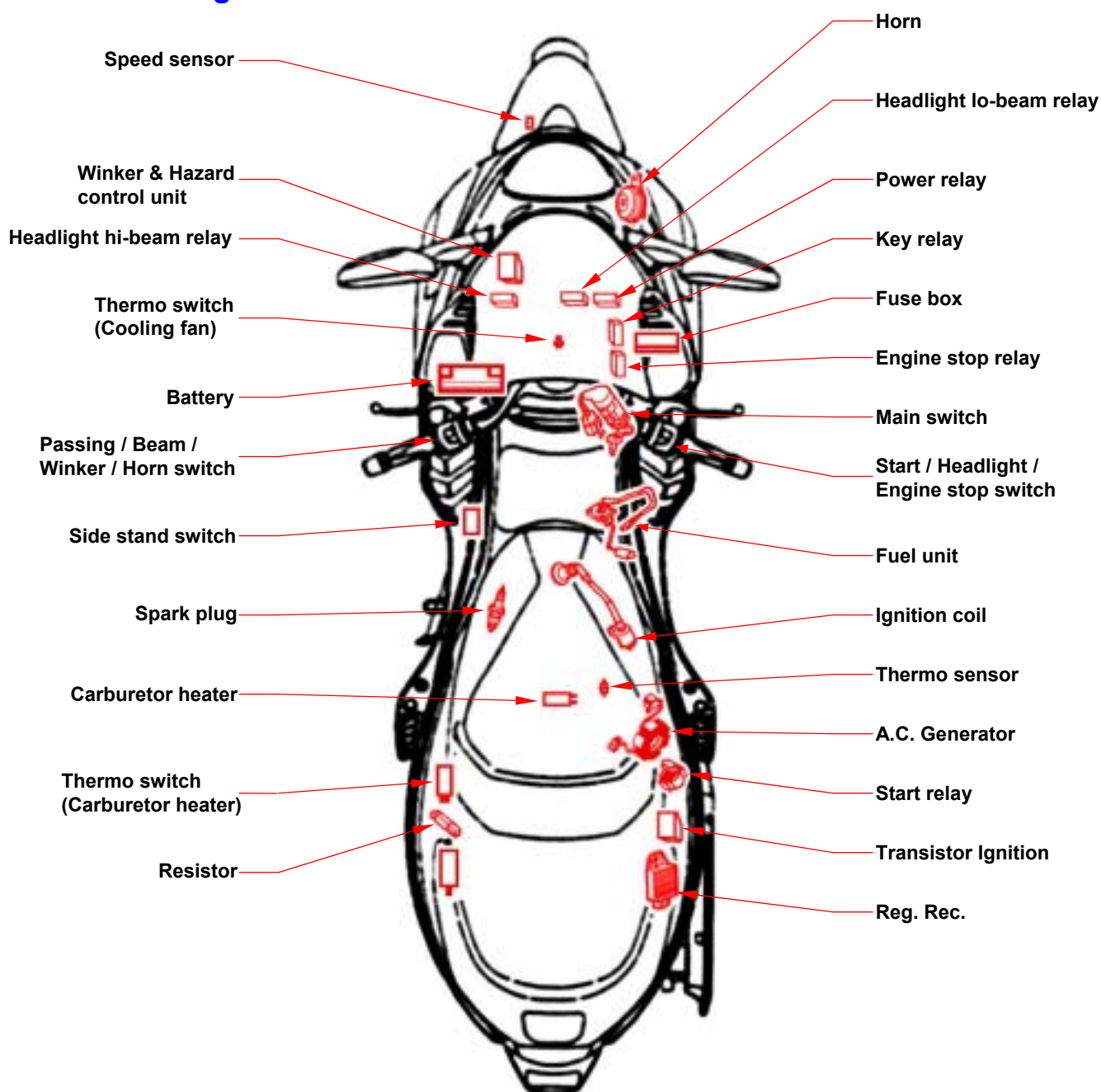

17. Electrical System

Maintenance Data

Operational precaution

- When remove the battery, the disconnection sequence of cable terminals shall be strictly observed. (First disconnect the negative cable terminal, next, the positive cable terminal.)
- The model of the spark plug and the tightening torque.
- The ignition timing.
- Adjustment of headlight.
- Removal and installation of AC generator.
- The maintenance free battery requires no inspection of electrolyte level and refilling of distilled water.
- To recharge the battery, remove the battery from rack without removing ventilation caps.
- Unless in emergency, never rapid charge the battery.
- The voltage must be checked with the voltmeter while charging the battery.
- As C.D.I assembly does not require an ignition timing check. In case ignition timing is incorrect, check C.D.I and AC generator. Verify with an ignition timing light after replacement if necessary.

Technical Specification

Charging system

Description		Specification
Battery	Capacity	12V10Ah
	Charging rate	1.2A / 10hr (standard) 17A / 0.5hr (fast charging)
Leak current		Below 1mA
Charging current		1.2A / 1500 rpm
Control voltage in charging		14.5+0.5 V / 2,000 rpm

Ignition system

Description		Specification
Spark plug	Model	NGK CR7HSA (Recommended)
	Gap	0.6~0.7 mm
Ignition coil and resistance	Primary winding	0.17±10% Ω
	Secondary winding	Without cap: 9 ± 20% KΩ
With cap: 14.1 ± 20% KΩ		
Pulse generator		480~550 Ω
Ignition timing	10° TDC / 2500 rpm "F" mark	
	26° TDC / 3500 rpm	
	30° TDC / 6000 rpm	
	16° TDC / 8300 rpm	

Trouble Diagnosis

No voltage

- Battery discharged
- The cable disconnected
- The fuse is blown
- Improper operation of the main switch
- Low voltage
- The battery is not fully charged
- Poor contact
- Poor charging system
- Poor voltage regulator

No spark produced by spark plug

- The spark plug is out of work
- The cable is poorly connected, open or short-circuited
- Between AC.G. and C.D.I.
- Poor connection between C.D.I. and ignition coil
- Poor connection between C.D.I. and the main switch
- Poor main switch
- Poor C.D.I.
- A.C.G. is out of work

Starter motor does not work

- The fuse is blown
- The battery is not fully charge
- Poor main switch
- Poor starter switch
- The front and rear brake switches do not operate correctly
- Starter relay is out of work
- The ignition coil is poorly connected, open or short-circuited
- The starter motor is out of work

Intermittent power supply

- The connector of the charging system becomes loose
- Poor connection of the battery cable
- Poor connection or short-circuit of the discharging system
- Poor connection or short-circuit of the power generation system

Charging system does not operate properly

- Burnt fuse
- Poor contact, open or short circuit
- Poor regulator
- Poor ACG

Engine does not crank smoothly

- Primary winding circuit
 - Poor ignition coil
 - Poor connection of cable and connectors
 - Poor main switch
- Secondary winding circuit
 - Poor ignition coil
 - Poor spark plug
 - Poor ignition coil cable
 - Current leakage in the spark plug
- Incorrect ignition timing
 - Poor AC.G.
 - Improper installation of the pulse sensor
 - Poor C.D.I.

Weak starter motor

- Poor charging system
- The battery is not fully charged
- Poor connection in the windings
- The motor gear is jammed by foreign material

Starter motor is working, but engine does not crank

- Poor starter motor pinion
- The starter motor run in reverse direction
- Poor battery

17. Electrical System

Battery

Removal

Loosen 1 screw and remove the battery cover. Disconnect the negative cable terminal first, then the positive cable terminal.

Remove the battery.

Voltage Check

Use the digital voltmeter to check the voltage of the battery.

Voltage:

Fully charged: 12.8V ↑ at 20

Undercharged: Below 12.0 V at 20

Warning

- Keep flames away while recharging.
- Charging is completely controlled by the ON/OFF switch on the charger, not by battery cables.

Charging

Connect the positive terminal (+) of the charger to the battery positive terminal (+).

Connect the negative terminal (-) of the charger to the battery negative terminal (-).

	Standard	Maximum
Charging current	1.2A	17A
Charging time	10 hr	0.5 hr

Warning

- Keep flames away while recharging.
- Charging is completely controlled by the ON/OFF switch on the charger, not by battery cables.

Caution

- Never rapid charge the battery unless in emergency.
- Verify the battery is recharged with current and duration prescribed above.
- Large current and fast time to charge will render damage to the battery.

When installing the battery, coat the cable terminal with grease.

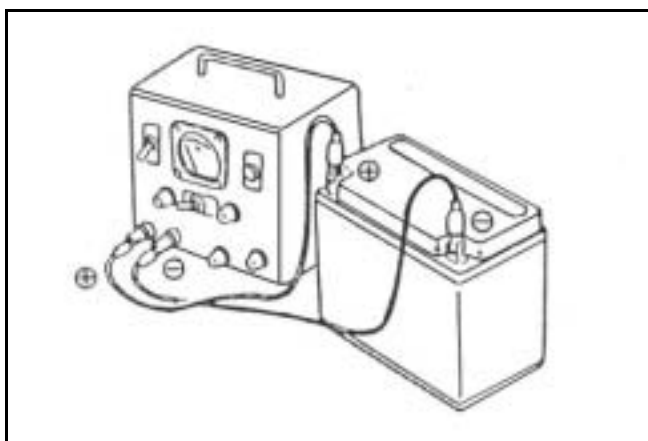
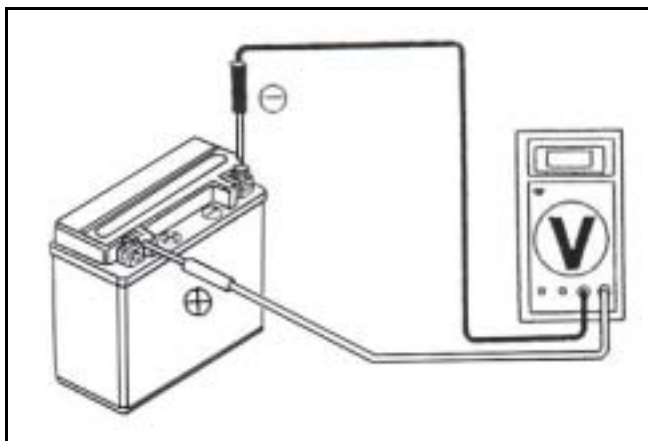

Fuse

Fuse circuit diagram

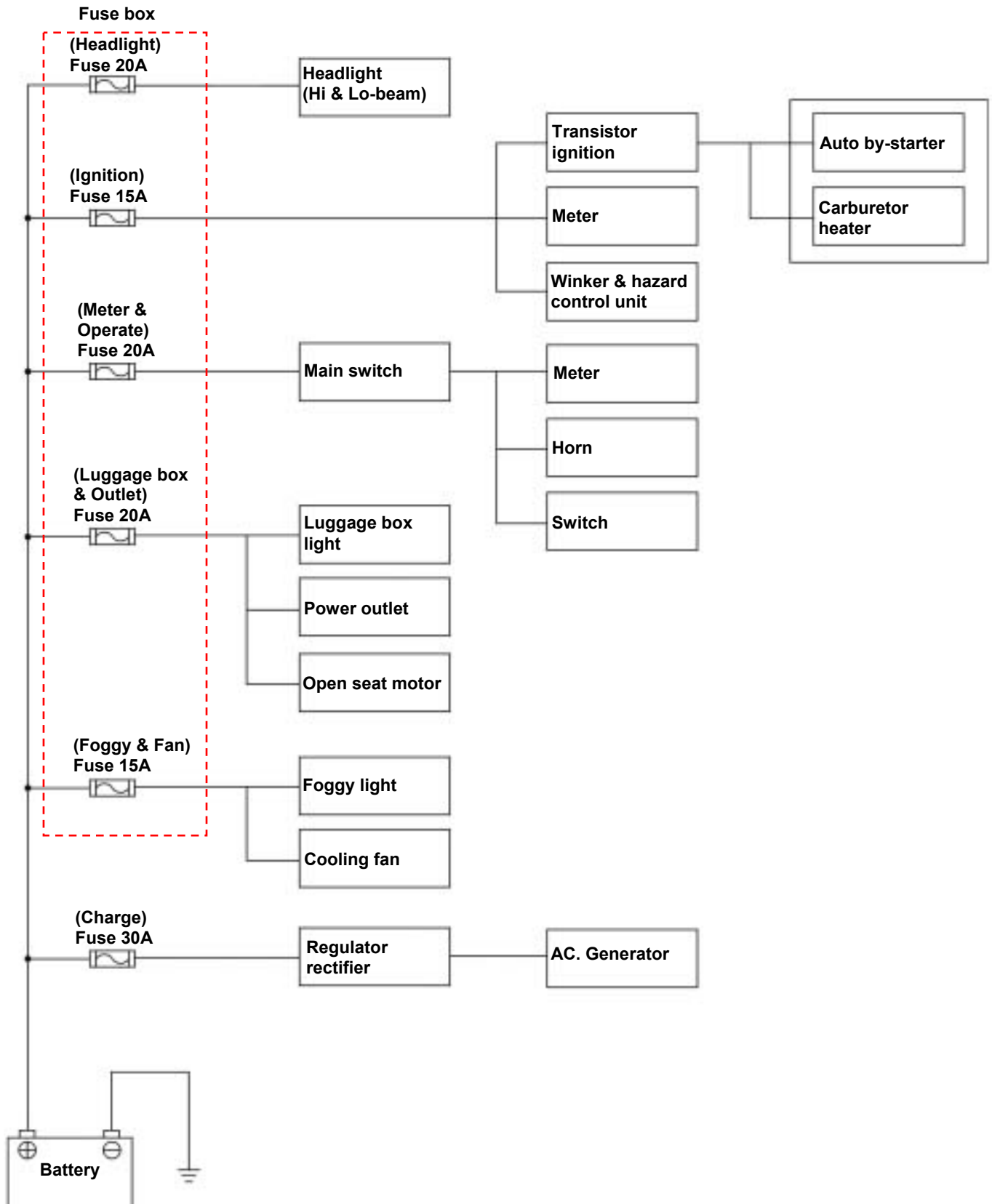

17. Electrical System

Charging System

Charging circuit

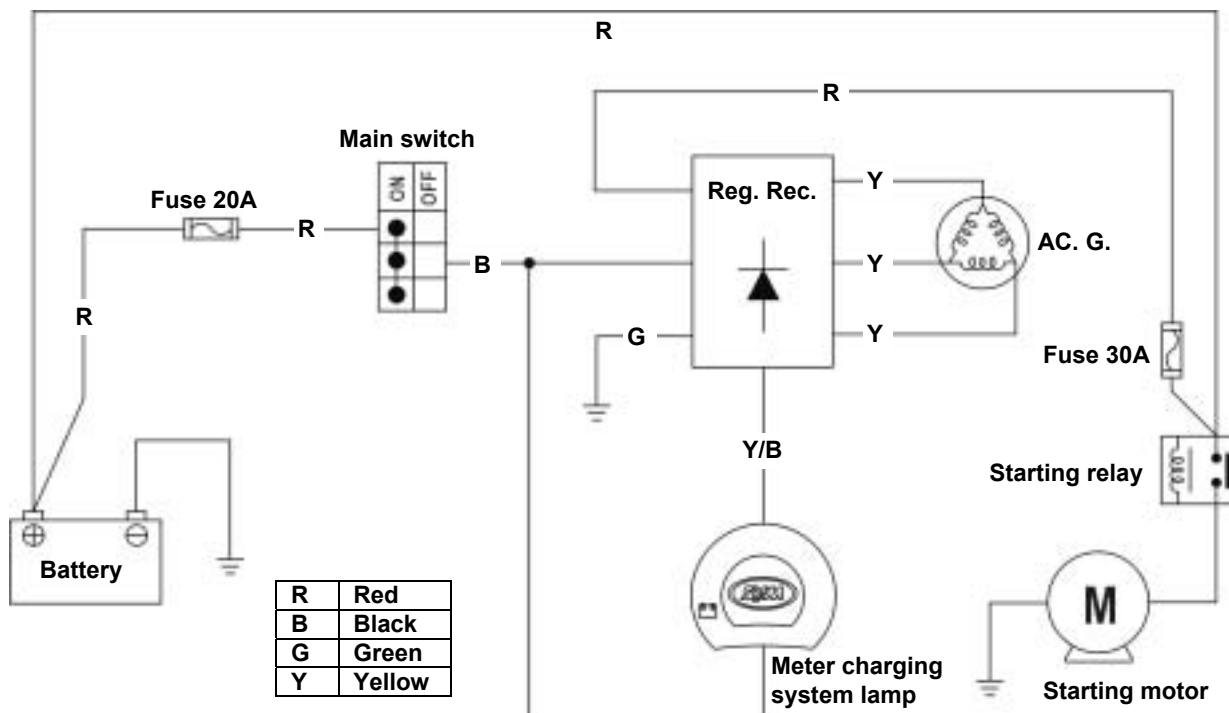

Regulator rectifier Inspection

(KΩ)

	+	Y1	Y2	Y3	R	B	Y/L	G
-								
Y1								
Y2								
Y3								
R								
B		5~30	5~30	5~30			5~30	1~10
Y/L								
G		2~20	2~20	2~20		1~10	5~30	

Inspection on regulator rectifier wire

Remove the luggage box, rear carrier and body covers.

Disconnect two 3 pin couplers of the regulator rectifier.

Inspection the rectifier coupler to the wire harness passes the condition.

Item	Check Points	Standard Value
Main switch connection	R B	Battery voltage (ON)
Battery connection	R G	Battery voltage
Charging coil	Y Y	0.2~0.4 Ω

If the readings measured are not normal, check parts in the circuit.

If the parts are normal, then trouble is in the wiring. If there is nothing wrong with parts and wiring, replace the regulator rectifier.

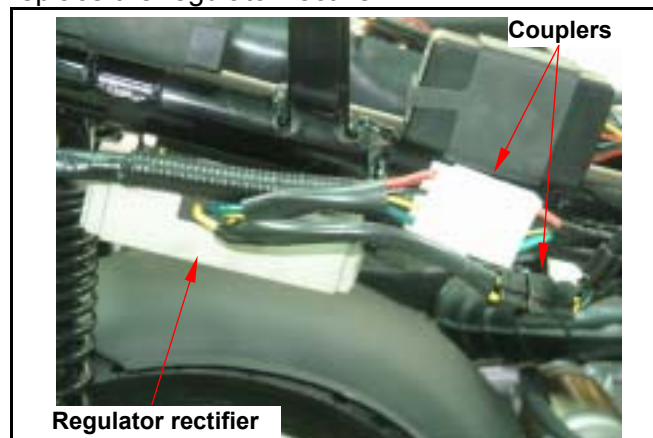

Inspection on AC. Generator coil

Remove the luggage box, rear carrier and body covers.

Disconnect 3 pin couplers of the generator coil.

Connect an ohmmeter to the each terminal end.

Check the continuity of the each terminal end, and engine ground with short circuit?

If there is no continuity or short circuit, replace the AC. Generator.

	V	Ω
Y1	70~80	0.2~0.4
Y2	70~80	0.2~0.4
Y3	70~80	0.2~0.4

And you can check voltage by engine is running.

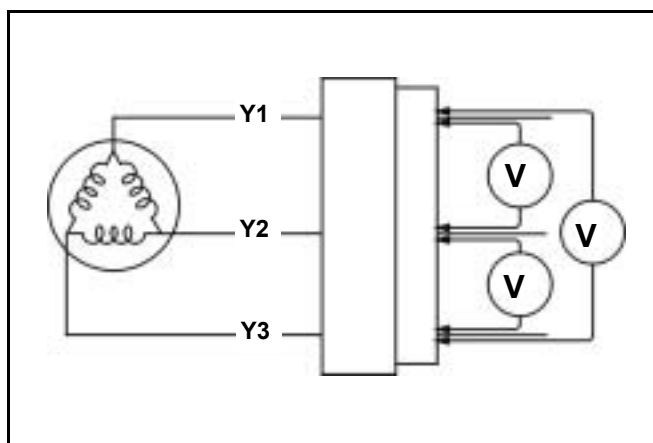
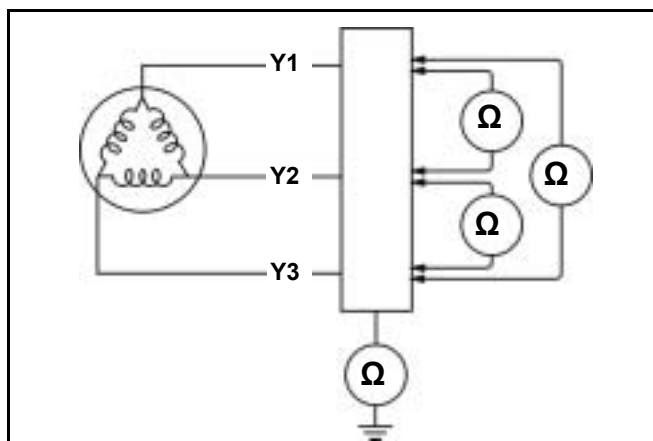

Current Leakage Inspection

Turn the main switch to OFF position, and remove the negative cable terminal (-) from the battery.

Connect an ammeter between the negative cable terminal and the battery negative terminal.

Disconnect each cable one by one and take measurement of the current of each cable to locate the short circuit.

Allowable current leakage: Less than 1mA

⚠ Caution

- In the current leakage test, set the current range at the largest scale, then gradually decrease to the lower scale as the test process goes to avoid possible damage to the ammeter and the fuse.
- Do not turn the main switch to ON position during test.

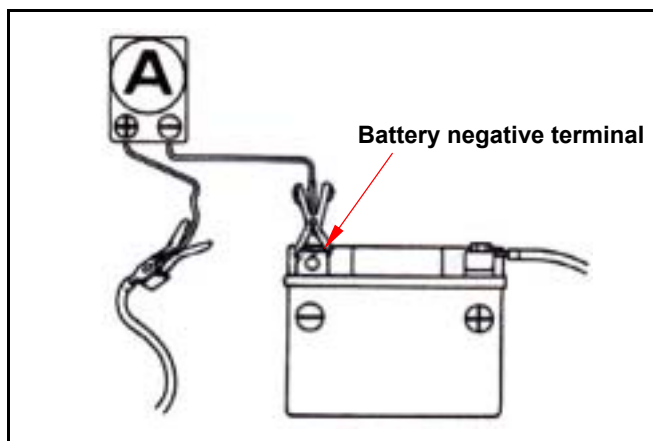

If the leaked current exceeds the specified value, it may indicate a short circuit.

17. Electrical System

Inspection on Charging Voltage

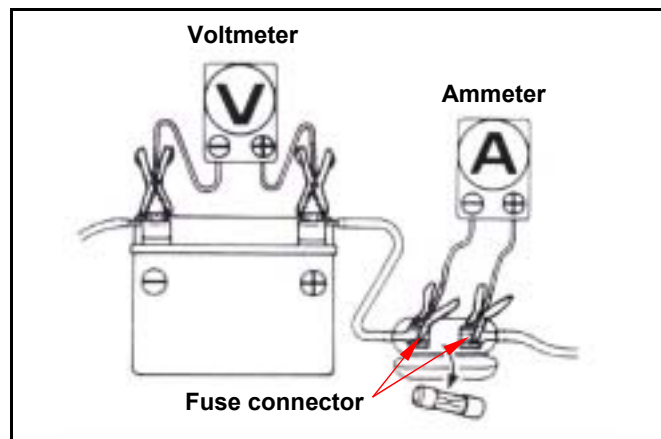

⚠ Caution

- Before conducting the inspection, be sure that the battery is fully charged. If undercharged, the current changes dramatically.
- Use a fully charged battery having a voltage larger than 13.0 V
- While starting the engine, the starter motor draws large amount of current from the battery.

After the engine is warmed up, replace original battery with a fully charged battery. Connect a digital voltmeter to the battery terminals. Connect an ammeter between both ends of the main fuse.

⚠ Caution

- When the probe is reversibly connected, use a voltmeter having an indication that the current flows from the positive or the negative direction and the measurement should be at zero, ammeter at one direction only.

⚠ Caution

- Do not use short-circuit cable.
- It is possible to measure the current by connecting an ammeter between the battery positive terminal and the cable position terminal, however, while the starter motor is activated, the surge current the motor draws from the battery may damage the ammeter. Use the kick starter to start the engine.
- The main switch shall be turned to OFF position during the process of inspection. Never tamper with the ammeter and the cable while there is current flowing through. It may damage the ammeter.

Connect a tachometer.

Turn on the headlight to high beam and start the engine.

Accelerate the engine to the specified revolution per minute and measure the charging voltage.

Specified Charging Current:

1.2 A / 6000 rpm

Control Charging Voltage:

14.5 V/1500 rpm

⚠ Caution

- To replace the old battery, use a new battery with the same current and voltage.

The following problems are related to the charging system, follow the instructions provided in the checking list to correct it if any one of the problems takes place.

1. The charging voltage can not exceed the voltage between two battery terminals and the charging current is in the discharging direction.
2. The charging voltage and current are too much higher than the standard values.

The following problems are not related to the charging system; correct it if any by following steps indicate in the checking list.

- (1) The standard charging voltage and current can only reach when the revolution of the engine exceeds the specified rpm.
 - Bulbs used exceed their rate and consume too much power.
 - The replacement battery is aged and does not have enough capacity.
- (2) The charging voltage is normal, but the current is not.
 - The replacement battery is aged and does not have enough capacity.
 - Battery used do not have enough electricity or is over charged.
 - The fuse of the ammeter is blown.
 - The ammeter is improperly connected.
- (3) The charging current is normal, but the voltage is not.
 - The fuse of the voltmeter is blown.

Ignition System

Ignition circuit diagram

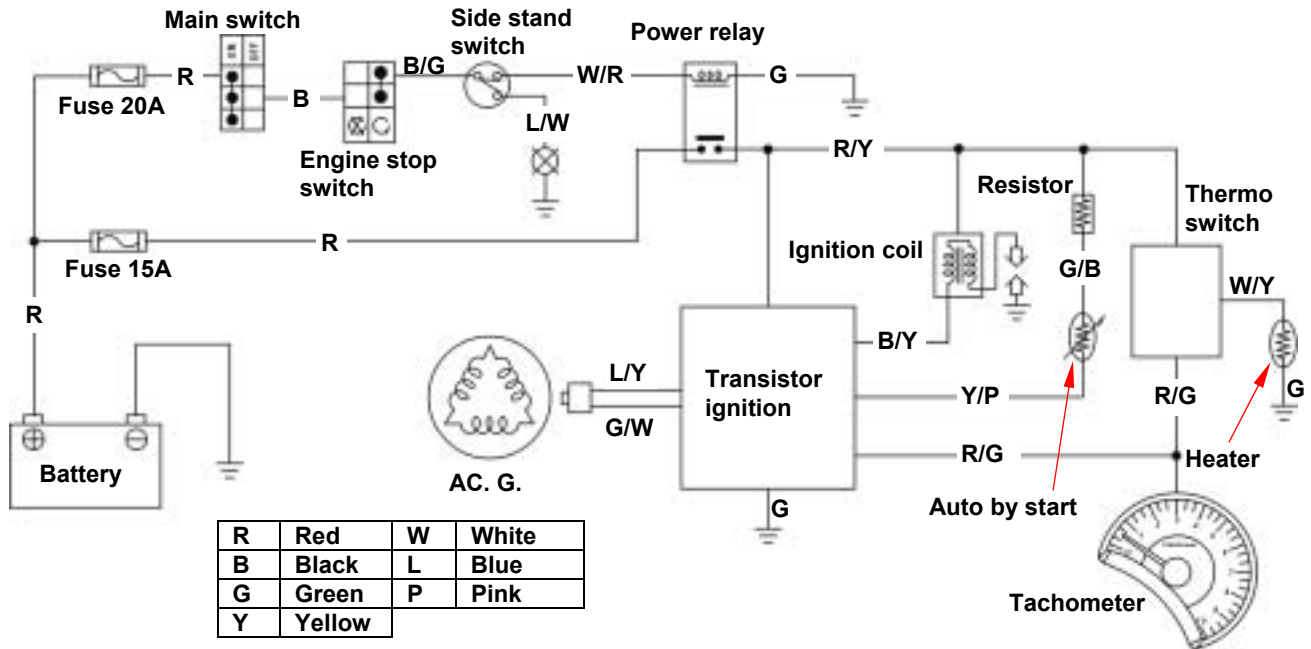

Inspection on transistor ignition

(KΩ)

	G/W	B/Y	Y/P	R/Y	G	R/G	L/Y
G/W		20~150		50~200	10~100	50~200	50~200
B/Y							
Y/P							
R/Y	50~200	10~100			5~30	0.1~5	50~200
G	10~100	5~30		10~100		10~100	10~100
R/G	50~200	10~100		0.1~5	5~30		50~200
L/Y	50~200	10~100		50~200	10~100	50~200	

17. Electrical System

Inspection on ignition coil

Remove the luggage box.

Disengage the connector of the ignition coil and the spark plug cap.

Measure the resistance between the terminals of the primary winding.

Standard resistance: $0.17 \pm 10\% \Omega$

Remove the cap from the spark plug and measure the resistance between the spark plug and the primary winding.

Standard resistance:

Without cap $9 \pm 20\% K\Omega$

With cap $14.1 \pm 20\% K\Omega$

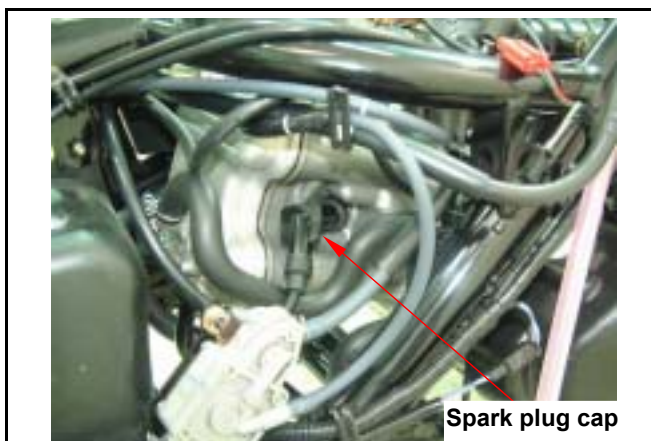
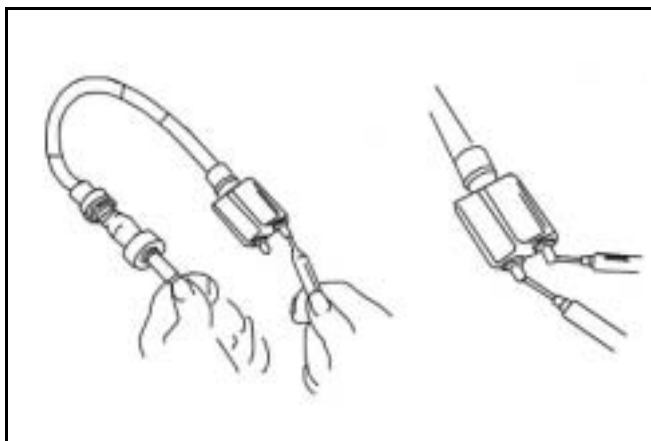

Replacement on ignition coil

Loosen 2 screws and replace the ignition coil if necessary.

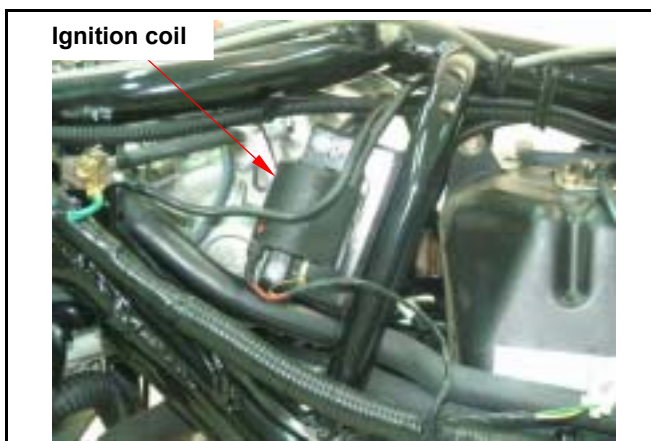

Inspection of pulse generator

Disconnect the coupler of the pulse generator and measure the resistance between the terminals of green/white and blue/yellow.

Standard resistance: $480 \sim 550\Omega$

Please refer to the Section 10 for disassembly of coil.

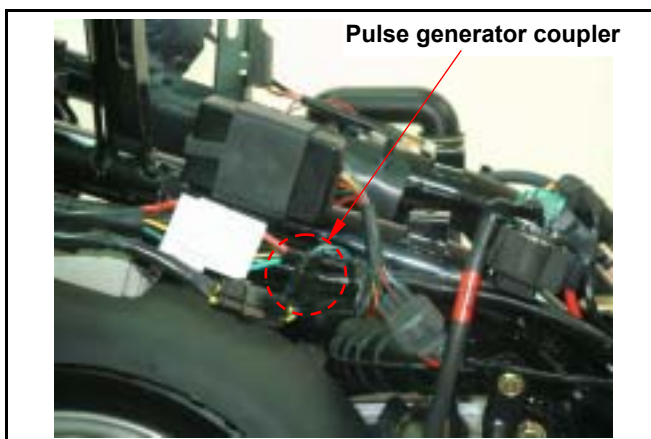

Starting System

Starting circuit diagram

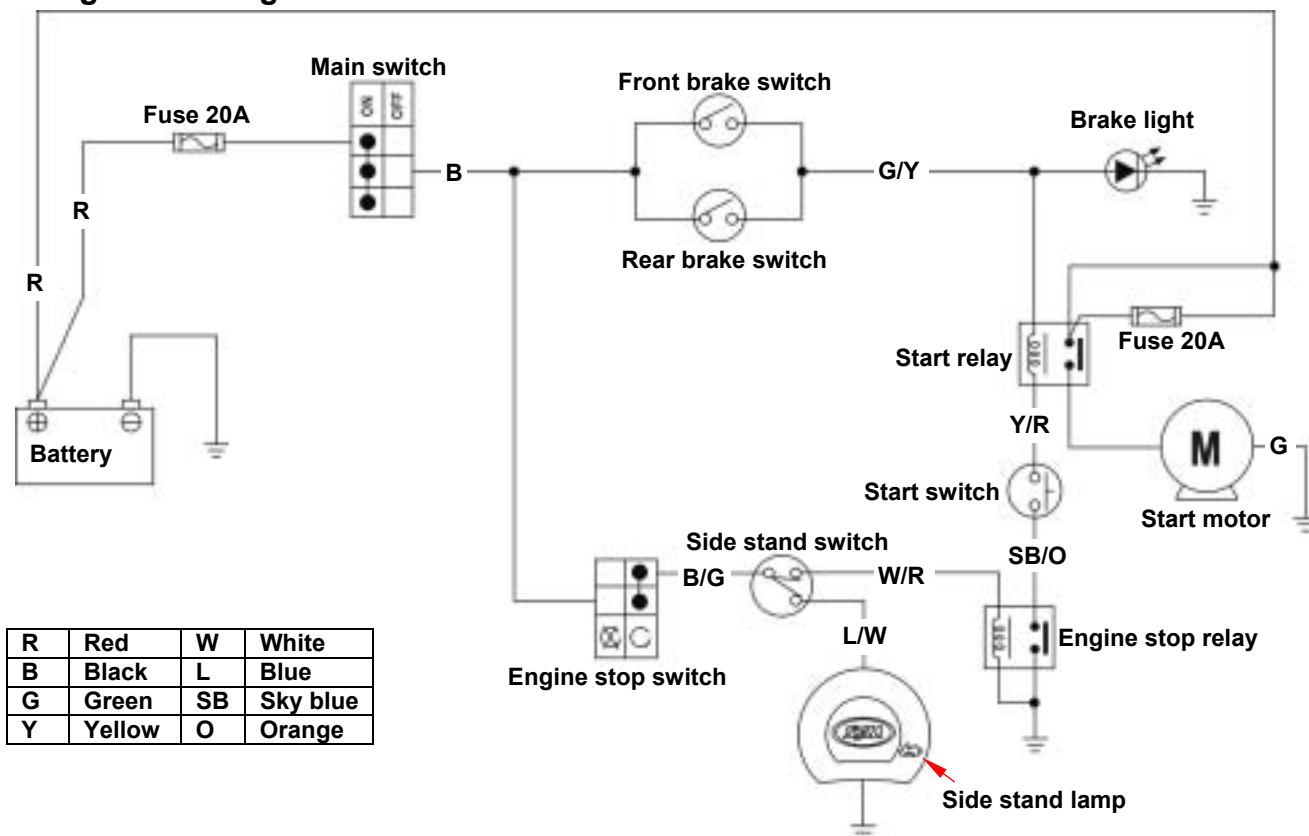

Inspection on starter relay

Open the main switch.
 Press the brake.
 Push down the starter switch.
 If a sound of “Looh Looh” is heard, it indicates the relay function normally.

Open the inner box lid, and remove battery cover.
 Disconnect the negative cable terminal of the battery.

Remove the luggage box.
 Disconnect the cable positive terminal from the start relay.



17. Electrical System

Disconnect the positive cable of the starter motor.
 Disconnect the coupler of the relay.
 Connect an ohmmeter to the large terminal end.
 Connect the yellow/red cable to the battery positive terminal and the green/yellow cable to the battery negative terminal.
 Check the continuity of the large terminal end.
 If there is no continuity, replace the relay.

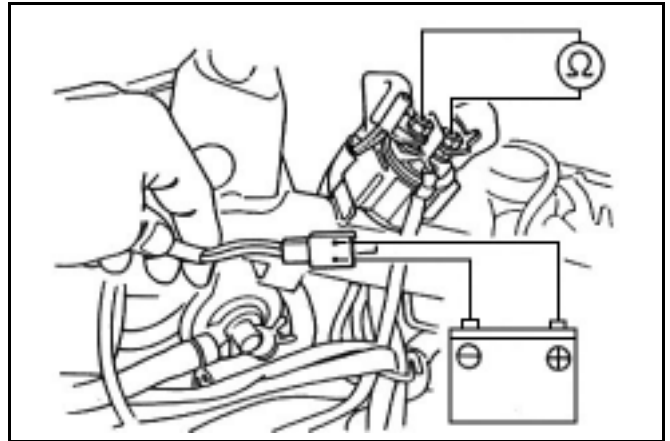

Removal of Starter motor

Turns off the main switch
 Remove the luggage box.
 Disconnect the coupler of the start relay.
 Disconnect the cable negative terminal of the battery.
 Disconnect the starter motor power cable.
 Loosen 2 bolts & remove starter motor.

Installation of starter motor

Install in reverse order of removal procedures.

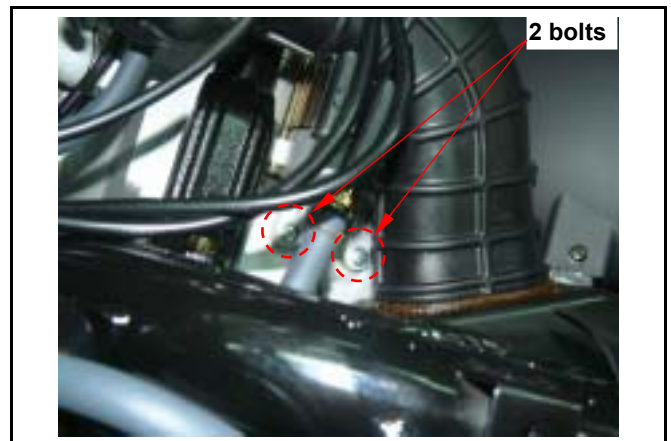

Meters

Meter circuit diagram

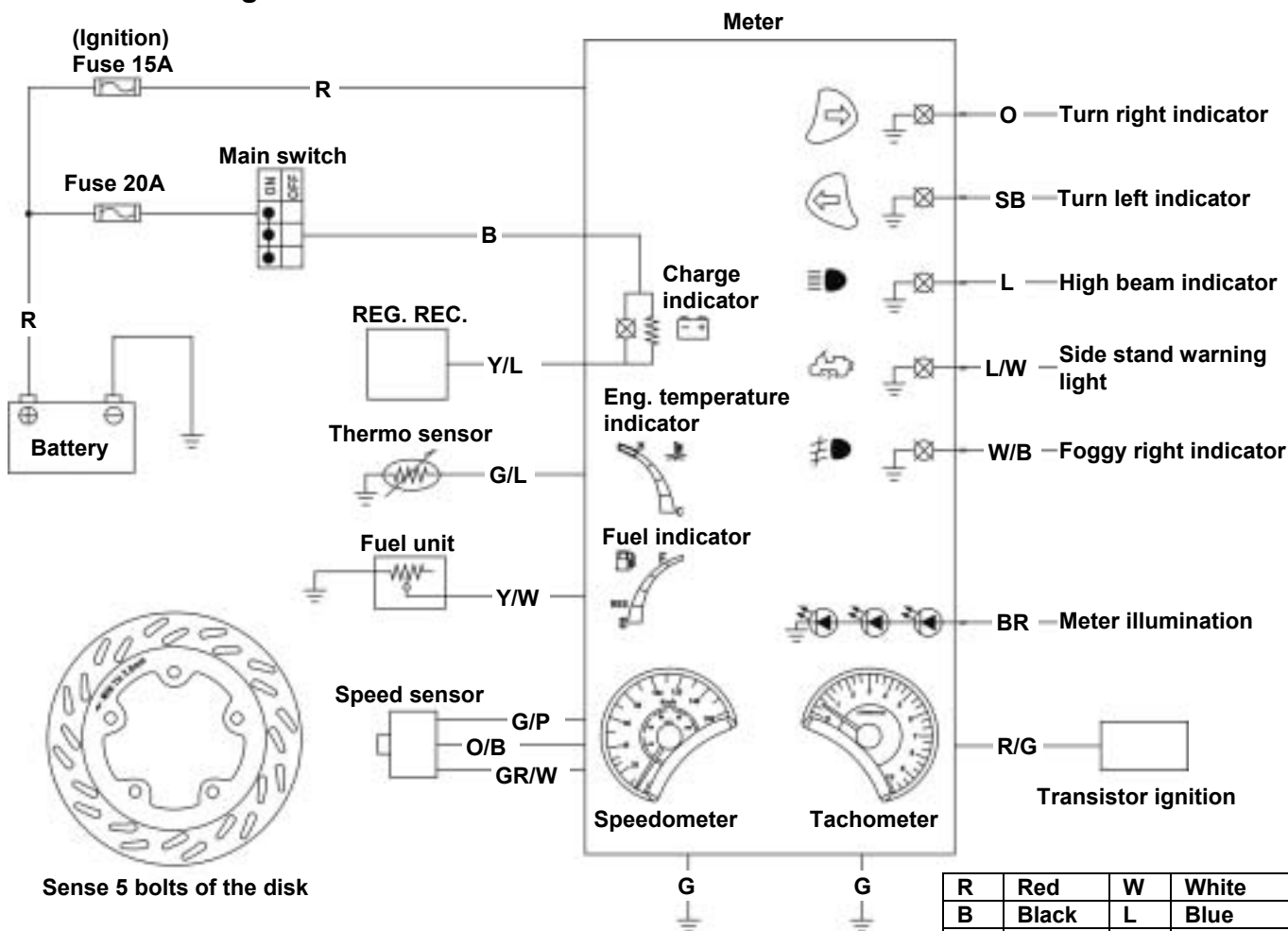

R	Red	W	White
B	Black	L	Blue
G	Green	SB	Sky blue
Y	Yellow	O	Orange
P	Pink	GR	Gray
BR	Brown		

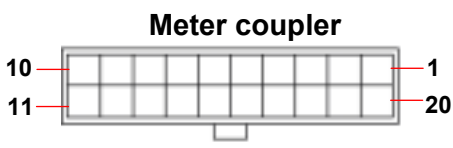

Wire harness coupler

Red		Black	Green	Green / Pink		Red / Green	Yellow / White	Gray / White	Orange / black
BATT+		IGN+	BATT-	SP-		RPM	Fuel+	SP+	SP
Green	Blue / White	Blue	Yellow / Blue	Brown	Orange	Sky Blue	White / Black	Green / Blue	Brown
GND.	Side stand	Hi-beam	Charge	ILLUMI.	Turn-R	Turn-L	Foggy	TEMP.	LUGG. Box

17. Electrical System

Removal of meter

Remove wind screen garnish, wind screen, meter visor, front cover, meter panel.
(Refer chapter 13)



Disconnect the coupler of the speedometer, and take off the meter panel and meter.

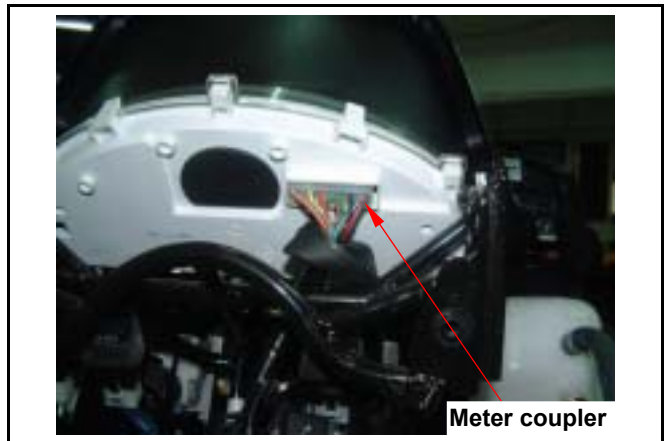

Loosen 4 screws from meter panel.
Remove the speedometer.

Installation of meter

Install in reverse order of removal procedures

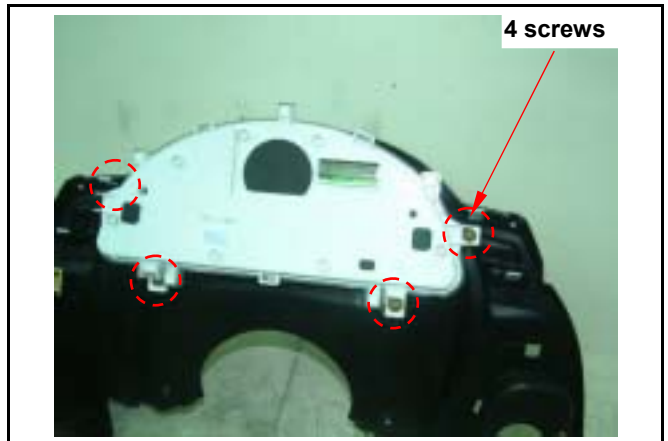

Light / Bulb

Headlight and foggy light circuit diagram

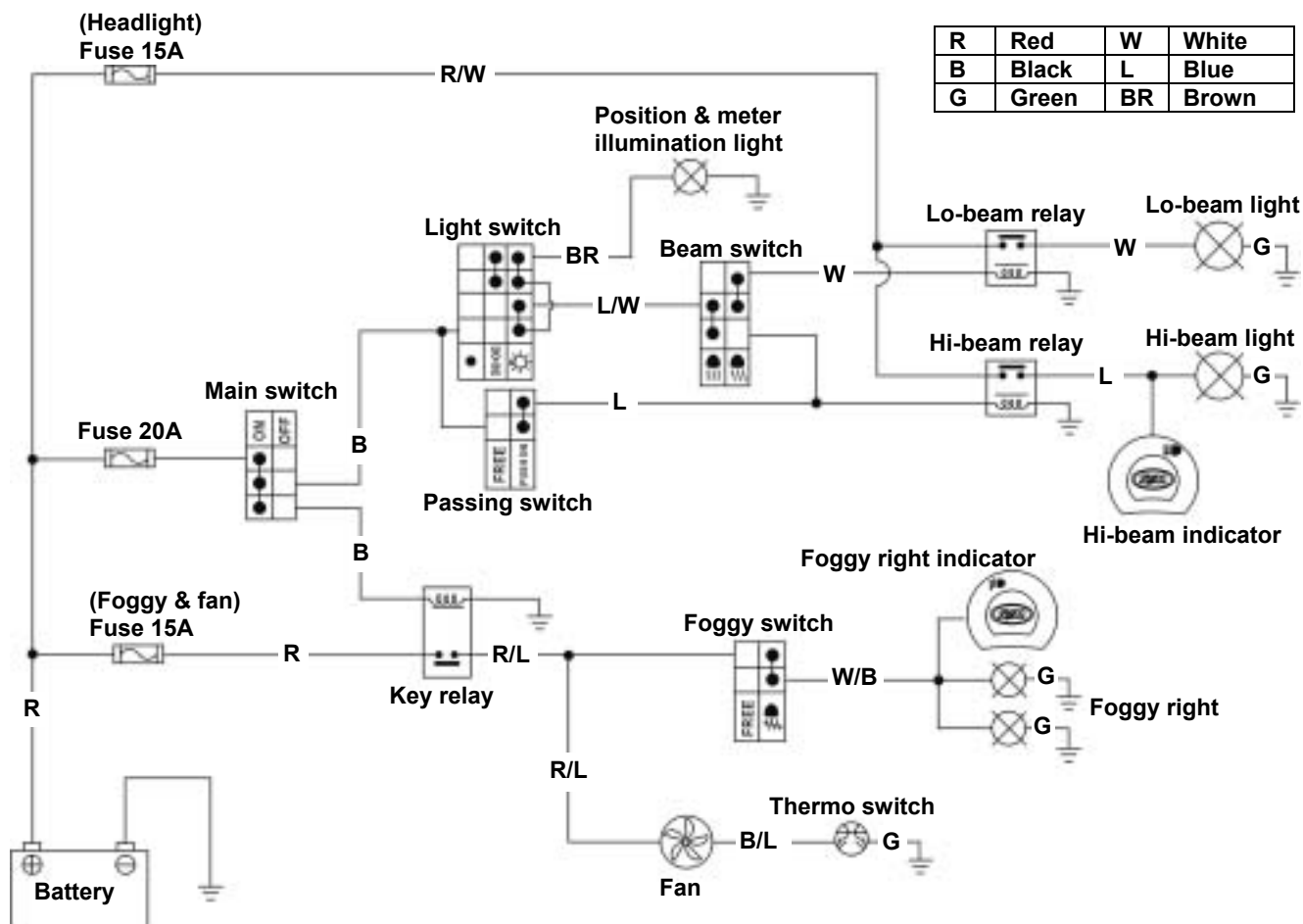

Winker light circuit diagram

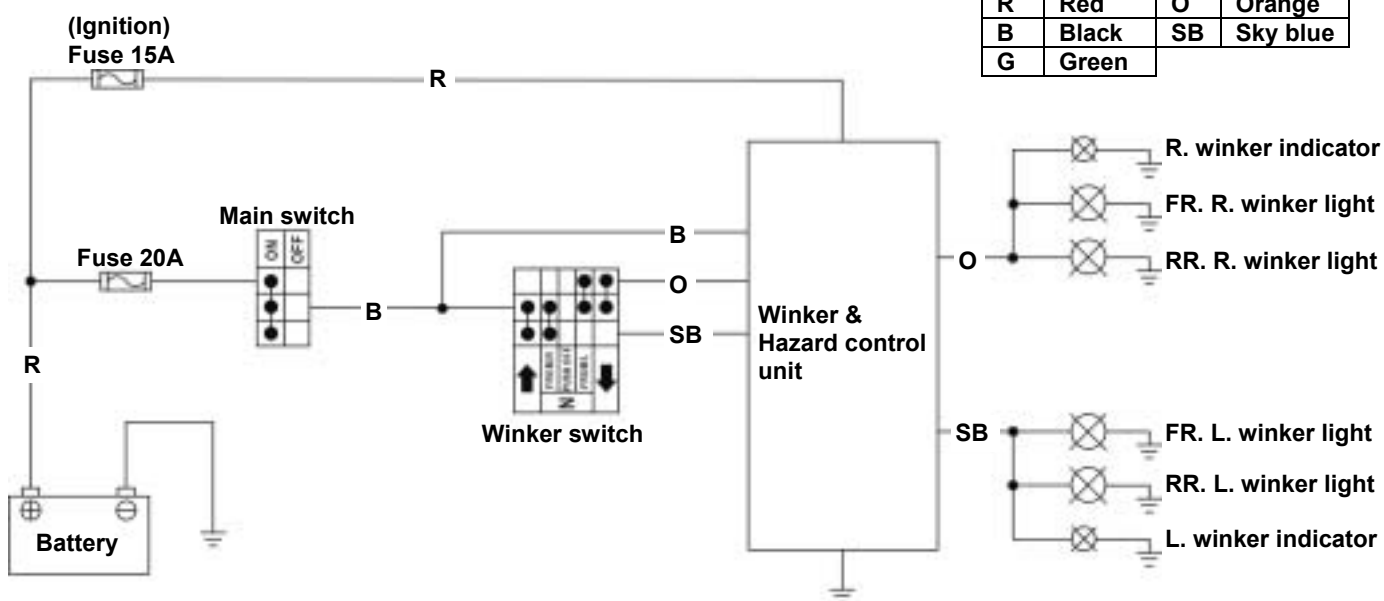

17. Electrical System

Replacement headlight bulbs

Remove wind screen garnish, wind screen, meter visor, front cover.

(Refer chapter 13)

Disconnect the rubber sleeve and the terminal coupler from the headlight.

Loosen 1 screw from the headlight bulb setting stay.

Remove setting stay and take out the headlight bulb.

Replace with new bulb if necessary.

Specification:

Lo-beam bulb 12V 55W (H7)

Hi-beam bulb 12V 55W (H7)

Caution

- Never touch the bulb with finger, which will create a heat point.
- Clean the fingerprint left on the bulb with alcohol.

Installation

Install the bulb of the headlight in reverse order of removal.

Upon completion of replacement, turn on the main switch to ensure the headlight works well.

Adjust the beam and distance of the headlight if necessary.

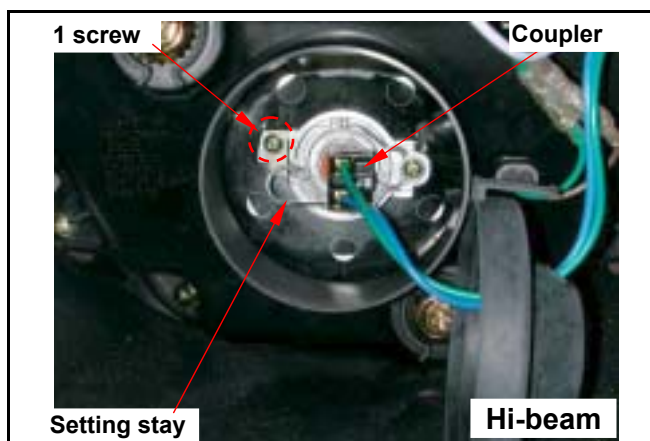
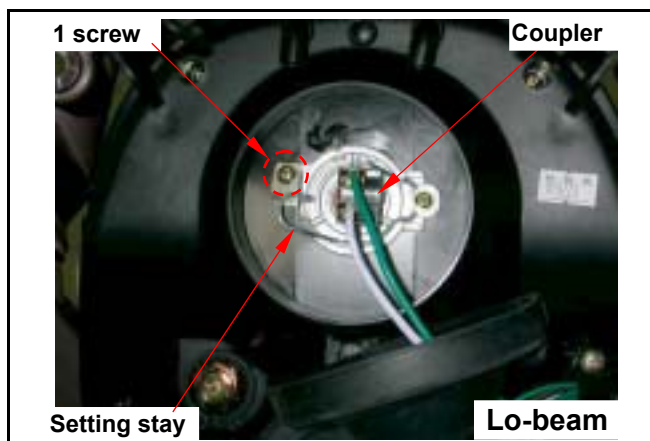

Replacement the front winker light and foggy light bulb

Remove wind screen garnish, wind screen, meter visor, front cover.
(Refer chapter 13)

Disconnect the rubber sleeve and turn the foggy light bulb seat in C.C.W. direction to remove the bulb seat and bulb.
Turn the winker light bulb seat in C.C.W. direction to remove the bulb seat and bulb.
Replace with new bulb if necessary.

Specification:

Foggy light bulb 12V 27W
Winker light bulb 12V 21W

Replacement the rear winker light bulb

Remove the luggage box.
Turn the winker light bulb seat in C.C.W. direction to remove the bulb seat and bulb.

Presses the bulb, counterclockwise rotation and remove it.
Replace with new bulb if necessary.

Specification:

Winker light bulb 12V 21W

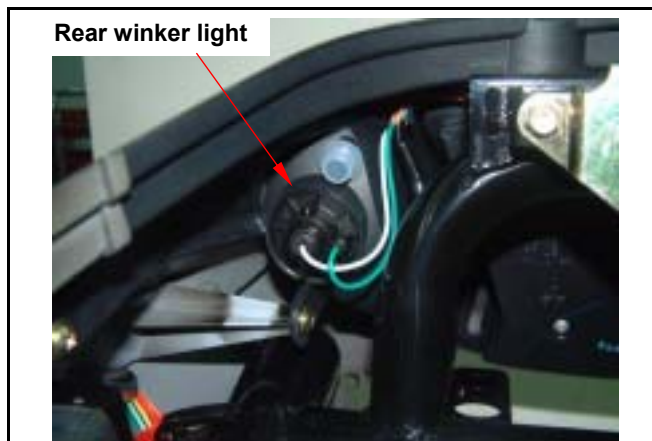
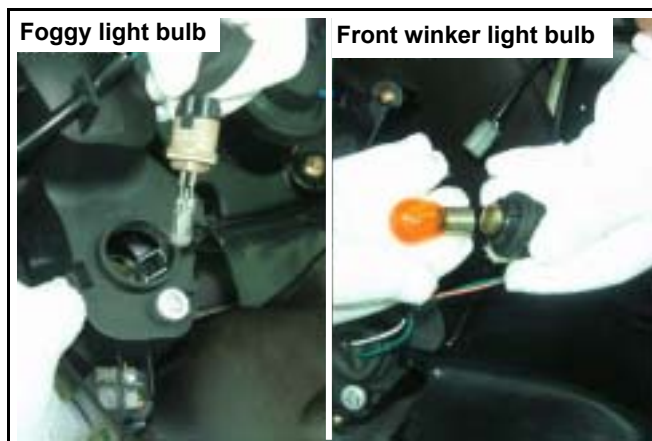
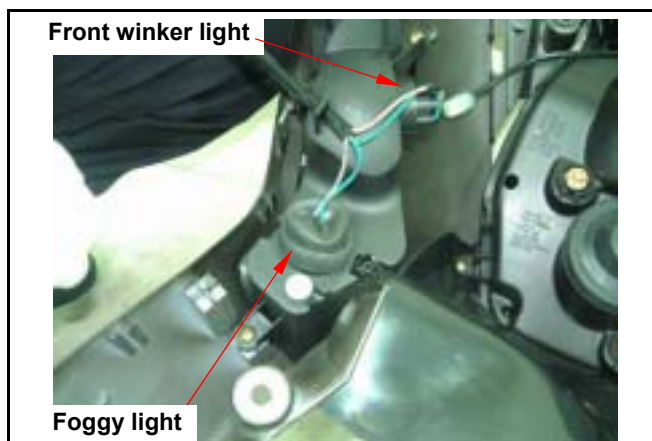

17. Electrical System

Replacement the meter bulbs

Remove the meter board waterproofing rubber.

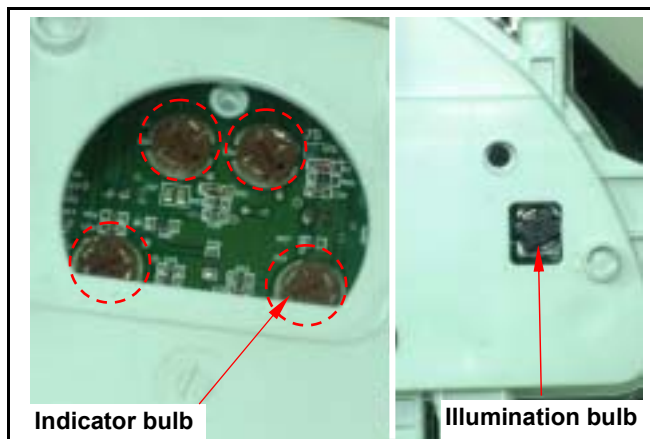

Uses the “-“ screw driver turn the indicator bulb seat in C.C.W. direction, and take out the indicator bulb.

Uses the round nose pliers turn the illumination bulb seat in C.C.W. direction, and take out the illumination bulb.

Specification:

Indicator bulb 12V 1.7W

Illumination bulb 12V 1.7W



Switch / Horn

Main switch

Inspection

Remove the front cover.
 Disconnect the main switch coupler.
 Check the continuity between two points as indicated below

Position	Pin	BAT	BAT1	BAT2
LOCK				
OFF				
ON		●	●	●
Wire Color		Red	Black	Blake

Replacement of main switch

Remove main switch cap.
 Disconnect the coupler of the main switch and loosen the mounting bolts (3 bolts).
 Remove the main switch.
 Install the new main switch and tighten the mounting bolts.
 Install the main switch coupler and cap.

Right handle switch

Remove the handle cover and front cover.
 Disconnect the coupler of right handle switch.
 Check the continuity between two points as indicated in the table below

Headlight switch

Position	Pin	TL	CI	HL	CI
		●	●		
		●	●	●	●
Wire Color		Brown	Black	Black	Blue /White

Start and engine stop switch

Position	Pin	ST	E	ST	E
		●	●		
FREE					
				●	●
Wire Color		Black	Black /Green	Yellow / Red	Sky blue/ Orange

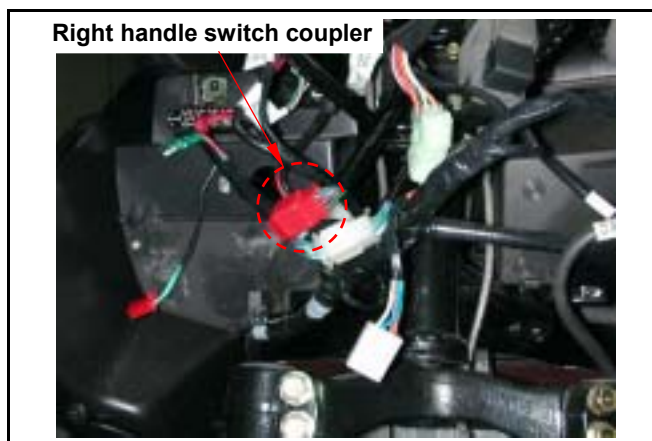
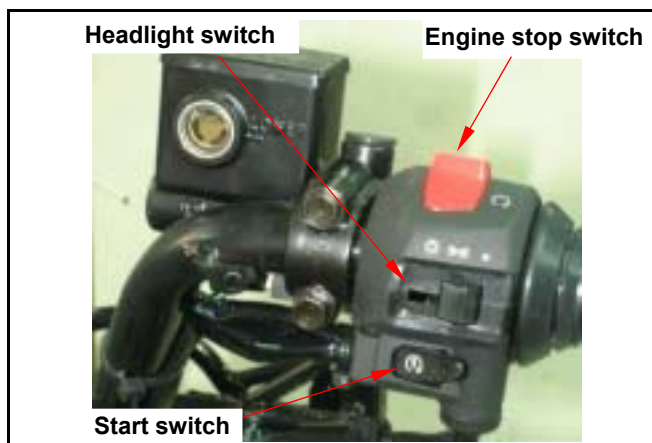
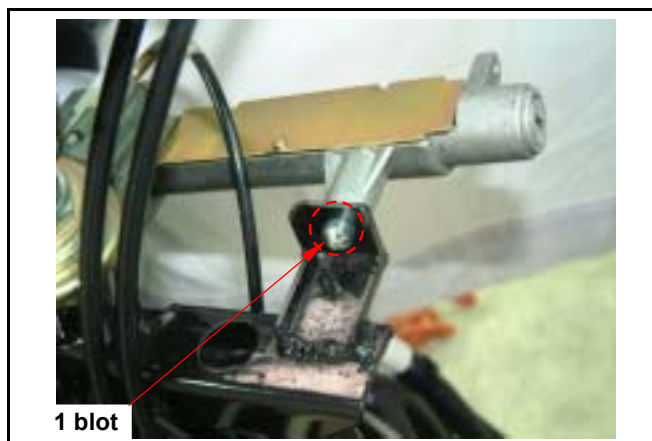
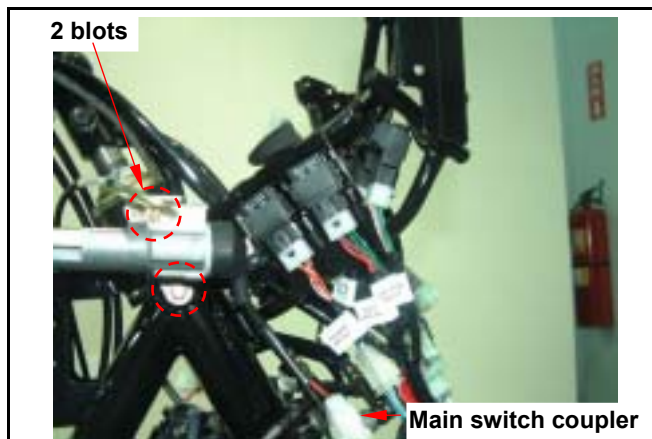

17. Electrical System

Left handle switch

Remove the handle cover and front cover.
Disconnect the coupler of left handle switch.
Check the continuity between two points as indicated in the table below

High and low beam switch

Position \ Pin	LO	HL	HI
		● — ●	●
	● — ●		
Wire color	White	Blue / White	Blue

Winker switch

Position \ Pin	R	WR	L
	● — ●	●	
N	FROM R	● — ●	
	PUSH OFF		
	FROM L		● — ●
		● — ●	●
Wire color	Sky blue	Gray	Orange

Brake Switch

While grasp the brake lever firmly, the terminals of white/green and green/yellow of the brake should have continuity.
Replace the switch if damaged.

Horn

Remove the front cover and front under spoiler.
Apply 12 V power source to two terminals of the horn, the horn should sound.
Replace the horn if necessary.

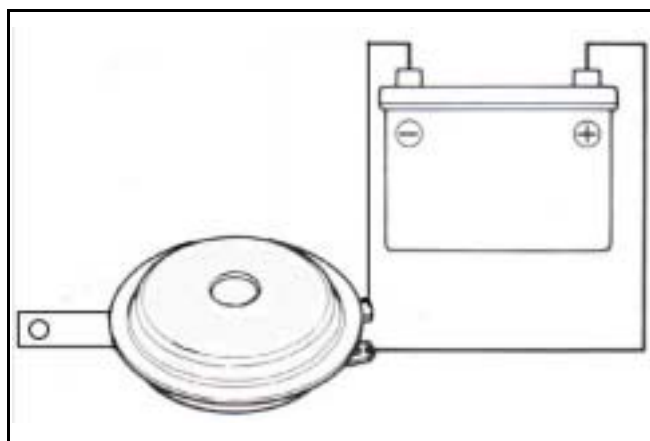
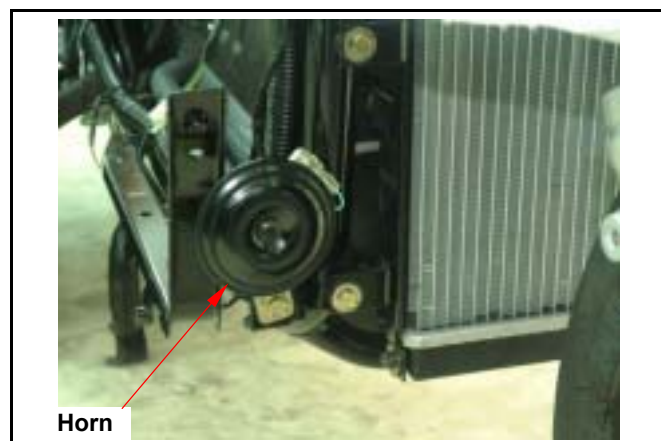
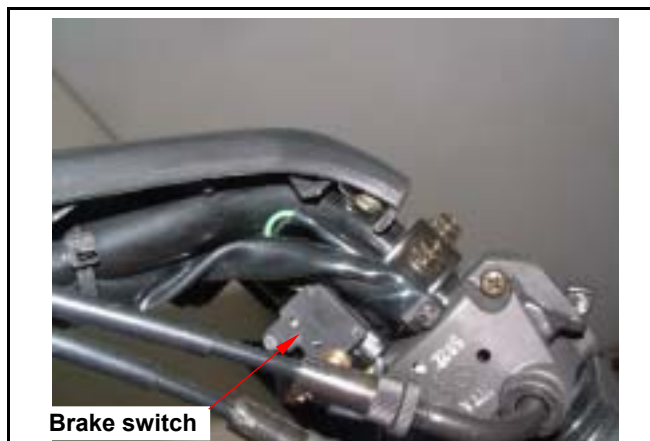
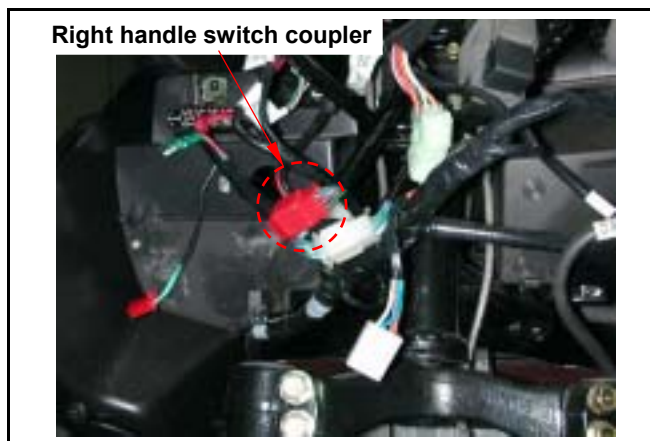
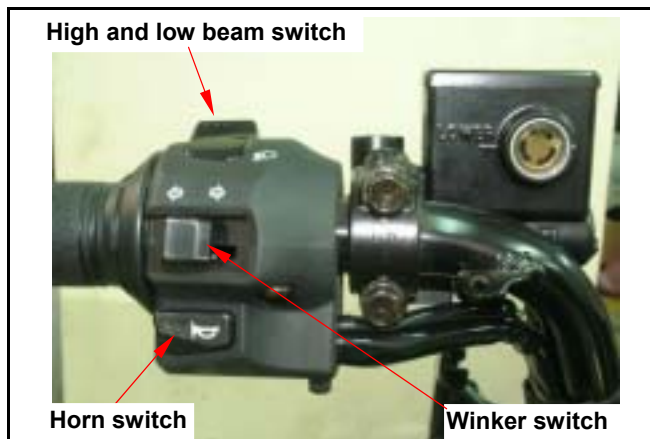

Fuel Unit

- Open the seat.
- Remove the luggage box.
- Remove the rear carrier.
- Remove right & left side cover.
- Remove the body cover
- Remove the floor panel.
- Disconnect the coupler of the fuel unit.
- Loosen 4 bolts from fuel unit and remove it.

⚠ Caution

- Great care shall be taken not to damage or bend the float arm of the gauge.

When the float arm shifts to the F position or the E position, the resistance measured shall be as follows:

Position	Resistance
E (Empty)	97.5~107.5 Ω
F (Full)	4~10 Ω

- Connect the wiring to the fuel unit and the ohmmeter as shown.
- Connect the fuel unit coupler to the wire harness.
- Turn on the main switch.
- Move the float arm to verify the proper position the fuel gauge needle indicates.

Arm Position	Needle Position
Up (Full)	F (Full)
Down (Empty)	E (Empty)

⚠ Caution

- While conducting the test, turn on the direction indication lamp to make sure that the battery is in serviceable condition.

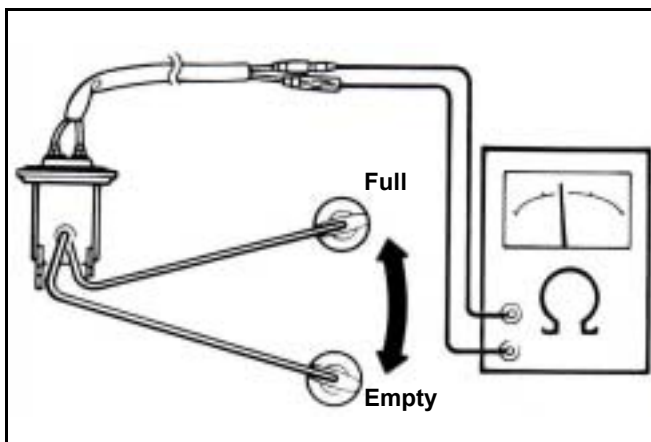
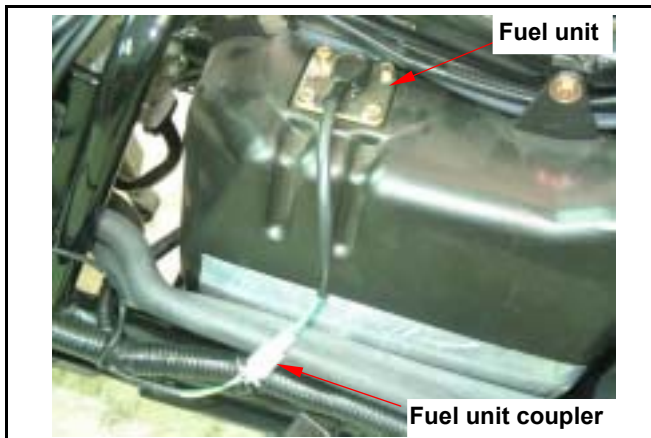

17. Electrical System

Cooling Fan Thermo Switch

The thermo switch mounted on the radiator controls the operation of the cooling fan motor. In case that the fan motor fails to work, disconnect the green and black/blue leads and connect jump wires to the terminals, then, turn on the main switch, the fan motor should operate. If the fan motor still fails to run, measure battery voltage between the green and black / blue leads. If there is no voltage, check for blown fuse, loose connection or short-circuit.

If the fan motor runs, check the thermo switch in the manner as described below:

Hang the thermo switch on the bowl filled with coolant to check the switch's opening and closing temperatures, confirm the switch is open circuited at room temperature, increase the coolant temperature gradually. The switch should have a continuity at 95-101 .

Caution

- Keep the coolant at a constant temperature at least for three minutes. Sudden increase the coolant temperature will cause the thermometer and the tester to indicate wrong readings.
- Never let the thermometer and the thermo switch contact the wall of the bowl, which may result in wrong readings.
- The thermo switch shall be placed in the coolant until the teeth are completely submerged.

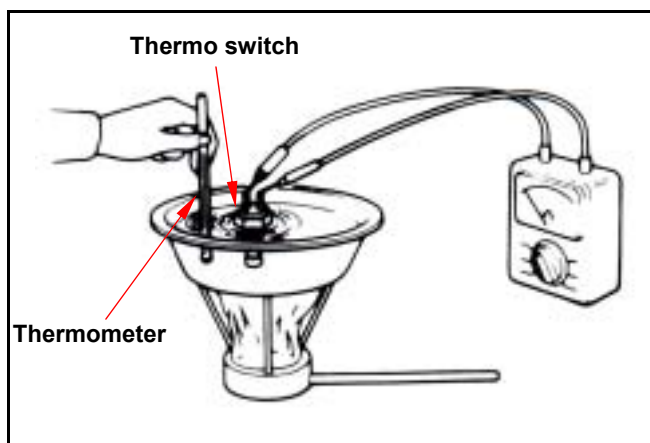

Thermo Sensor

Remove the thermo unit.

Hang the thermo unit in an oil heater, heat the oil and measure the resistance at each temperature.

Temperature	50°C	80°C	100°C	120°C
Standard ()	134~149	47.5~57.0	26~29	14.8~17.2

⚠ Caution

- Wear gloves and goggles when performing this test.

⚠ Caution

- Engine oil should be used as a heating medium as the test temperature must be higher than 100 .
- Contacting the container wall by the thermometer and the thermo unit may result in wrong readings.

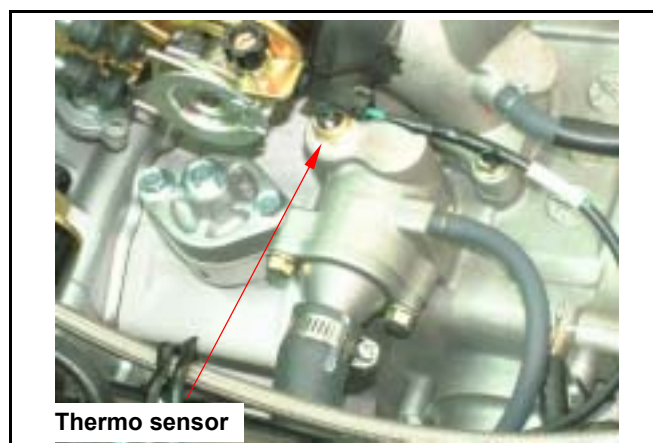
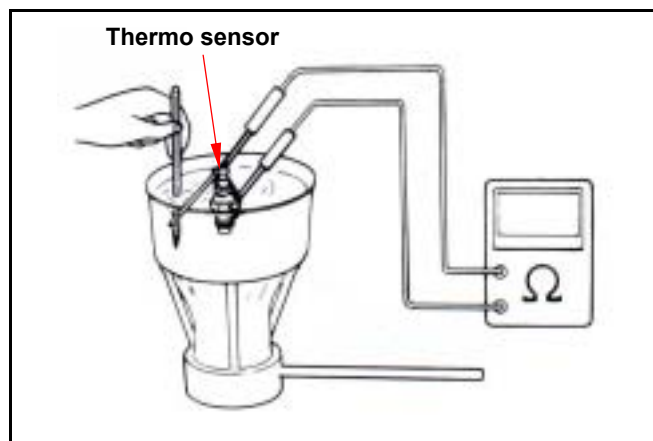

Water Temperature Meter

Disconnect the thermo sensor coupler and connect it to engine ground.

Turn on the main switch.

The needle of the water temperature meter should move to other end, H position.

⚠ Caution

- Do not ground the water temperature more than 5 seconds, or the meter will be damaged.

17. Electrical System



Note:

LM25W Electrical Diagram

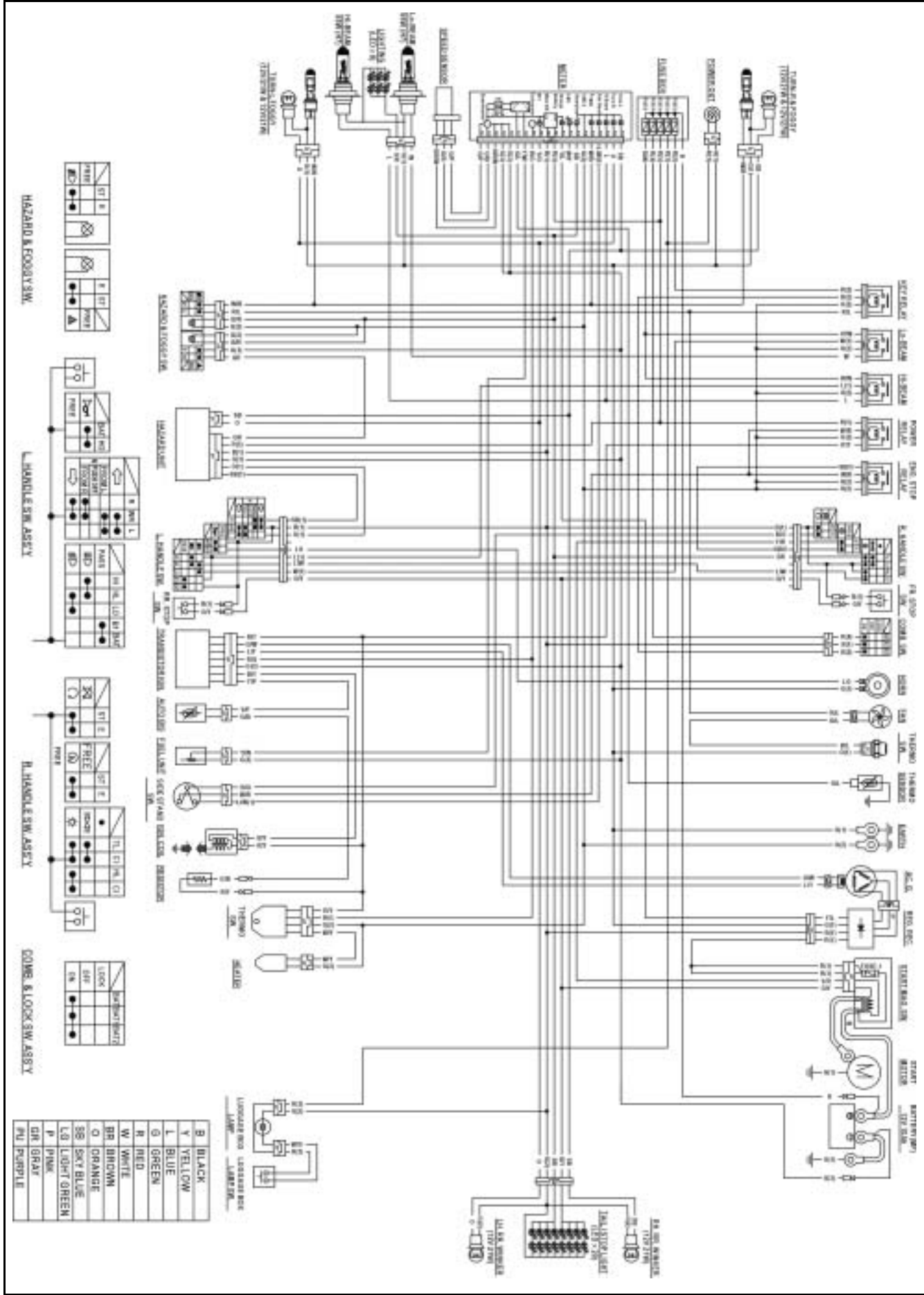

18. Electrical Diagram

Note: