

Vespa would like to thank you

for choosing one of its products. We have prepared this booklet to help you to get the very best from your scooter. Please read it carefully before riding the scooter for the first time. It contains information, tips and precautions for using your scooter. It also describes features, details and devices to assure you that you have made the right choice. We believe that if you follow our suggestions, you will soon get to know your new vehicle and it will serve you well for a long time to come. This booklet forms an integral part of the scooter; should the scooter be sold, it must be transferred to the new owner.

# Vespa GTS Super 300



*Ed. 2*

The instructions given in this booklet are intended to provide a clear, simple guide to using your scooter; details are also given of routine maintenance procedures and regular checks that should be carried out on the vehicle at an **Authorised PIAGGIO Dealer or Service Centre**. The booklet also contains instructions for simple repairs. Any operations not specifically described in this booklet require the use of special tools and/or particular technical knowledge: to carry out these operations refer to any **authorised PIAGGIO Dealer of Service Centre**.



### **Personal safety**

Failure to completely observe these instructions will result in serious risk of personal injury.



### **Safeguarding the environment**

Sections marked with this symbol indicate the correct use of the vehicle to prevent damaging the environment.



### **Vehicle intactness**

The incomplete or non-observance of these regulations leads to the risk of serious damage to the vehicle and sometimes even the invalidity of the guarantee.

*The signs that you see on this page are very important. They are used to highlight those parts of the booklet that should be read with particular care. As you can see, each sign consists of a different graphic symbol, making it quick and easy to locate the various topics.*



# INDEX

<b>VEHICLE</b> .....	7	Automatic transmission.....	33
Dashboard.....	9	Safe driving.....	34
Analogue instrument panel.....	10	<b>MAINTENANCE</b> .....	37
Clock.....	11	Engine oil level.....	38
Key switch.....	12	Engine oil level check.....	38
Locking the steering wheel.....	12	Engine oil top-up.....	38
Releasing the steering wheel.....	12	Warning light (insufficient oil pressure).....	39
Switch direction indicators.....	13	Engine oil change.....	39
Horn button.....	13	Hub oil level.....	40
Light switch.....	14	Tyres.....	42
Start-up button.....	14	Spark plug dismantlement.....	43
Engine stop button.....	15	Removing the air filter.....	44
The immobilizer system.....	15	Cooling fluid level.....	46
Keys.....	15	Checking the brake oil level.....	47
Immobilizer device enabled indicator led.....	16	Battery.....	49
Operation.....	17	Use of a new battery.....	50
Programming the immobilizer system.....	18	Long periods of inactivity.....	50
Accessing the fuel tank.....	19	Fuses.....	51
Opening the saddle.....	20	Front light group.....	56
Identification.....	21	Headlight adjustment.....	57
Rear top box opening.....	22	Front direction indicators.....	58
Bag clip.....	23	Rear optical unit.....	59
<b>USE</b> .....	25	Rear turn indicators.....	59
Checks.....	26	Rear-view mirrors.....	60
Refuelling.....	26	Front and rear disc brake.....	60
Tyre pressure.....	28	Puncture.....	61
Shock absorbers adjustment.....	29	Periods of inactivity.....	62
Running in.....	30	Cleaning the vehicle.....	62
Starting up the engine.....	30	<b>TECHNICAL DATA</b> .....	67
Precautions.....	31	Kit equipment.....	72
Difficult start up.....	32	<b>SPARE PARTS AND ACCESSORIES</b> .....	73
Stopping the engine.....	32	Warnings.....	74
Stand.....	33	<b>PROGRAMMED MAINTENANCE</b> .....	77

Scheduled maintenance table..... 78

# Vespa GTS Super 300

The Vespa logo is rendered in a stylized, black, italicized font with a registered trademark symbol (®) at the end.

**Chap. 01  
Vehicle**

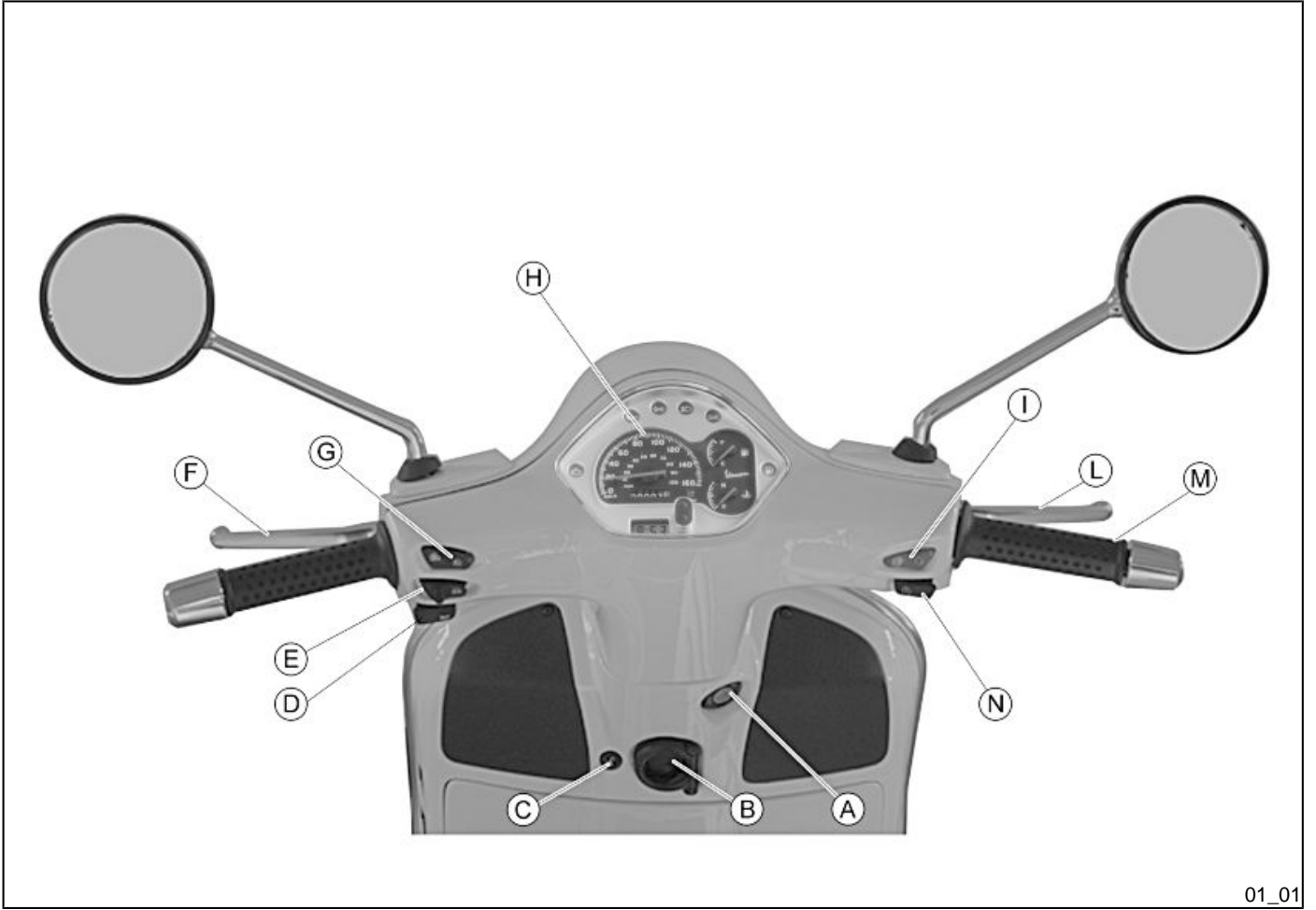



**Dashboard (01\_01)**

**A** = Ignition key-switch

**B** = Bag hook

**C** = Saddle electric opening switch

**D** = Horn button

**E** = Turn indicator switch

**F** = Rear brake lever

**G** = Light switch

**H** = Instrument panel

**I** = Emergency cut-off switch RUN/OFF

**L** = Front brake lever

**M** = Throttle grip

**N** = Starter button

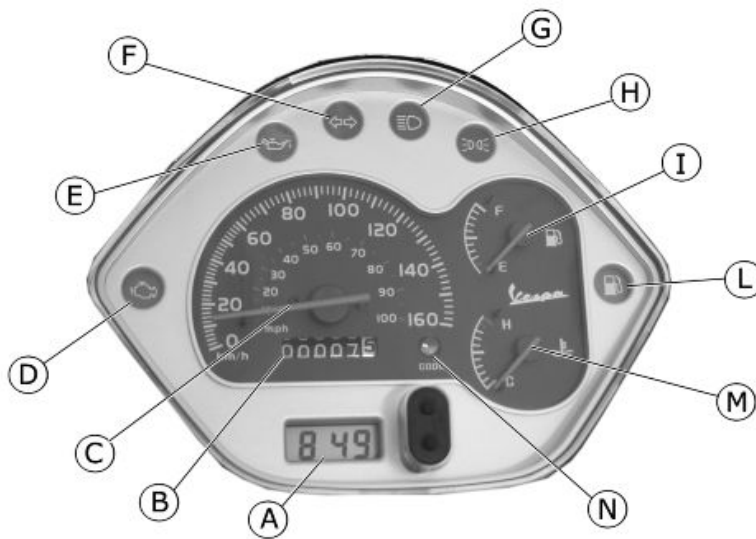

01\_02

### Analogue instrument panel (01\_02)

- A = Digital clock
- B = Odometer
- C = Speedometer
- D = Injection telltale light
- E = Engine oil pressure warning light
- F = Turn indicators
- G = High-beam warning light

- H = Headlight warning light
- I = Fuel gauge
- L = Low fuel warning light
- M = Coolant temperature gauge
- N = Immobilizer LED

### Clock (01\_03)

Located in the instrument panel, it displays hours and minutes with 1 to 12-hour time, AM or PM.

Operate the function selection button «**B**» and month, day and seconds are also displayed besides hours and minutes.

To adjust the different functions, select the desired function with button «**A**» and adjust with button «**B**». The time counter can be reset by pressing button «**A**» with the clock in the seconds function.

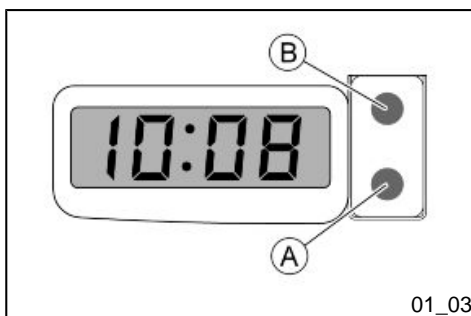

The digital clock is powered by a battery (battery life is about 2 years); lift the whole instrument panel to replace the battery. It is advisable to take your vehicle to an **Authorised Service Centre** for this operation.

#### WARNING



**DEAD BATTERIES ARE HARMFUL TO THE ENVIRONMENT. THEY MUST DISPOSED OF IN SUITABLE CONTAINERS AS PRESCRIBED BY THE REGULATIONS IN FORCE.**

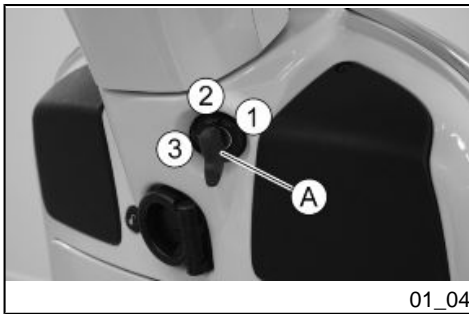

### Key switch (01\_04)

Key switch «A» is located on the front knee-guard panel near the bag hook.

#### SWITCH POSITIONS

**ON «1»:** Ready to start position, non-extractable key, mechanical anti-theft device disabled.

**OFF «2»:** Ignition disabled, extractable key, mechanical anti-theft device disabled.

**LOCK «3»:** Ignition disabled, extractable key, mechanical anti-theft device enabled.

### Locking the steering wheel

Turn the handlebar to the left (as far as it will go), turn the key to «**LOCK**» and remove the key.

#### CAUTION



**DO NOT TURN THE KEY TO «LOCK» OR «OFF» WHILE RIDING.**

### Releasing the steering wheel

Reinsert the key and turn it to «**OFF**».

**CAUTION**

**DO NOT TURN THE KEY TO «LOCK» OR «OFF» WHILE RIDING.**

**Switch direction indicators (01\_05)**

Move switch «E» to the left to indicate a left turn; move switch «E» to the right to indicate a right turn. Push the central part of switch «E» to deactivate the turn indicators.

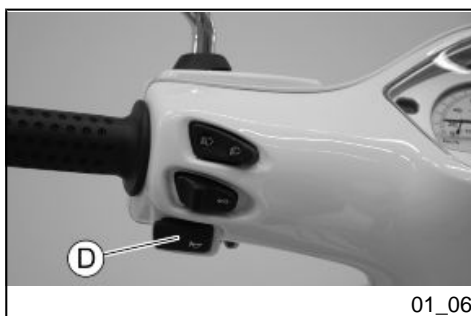
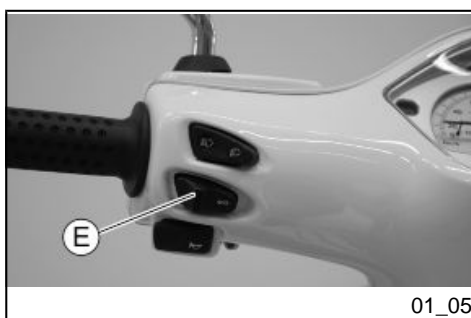
**Horn button (01\_06)**

Push the button «D» to sound the horn.

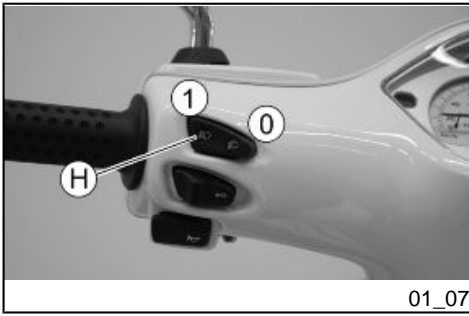

### Light switch (01\_07)

When the light switch «H» is set to «0», the low-beam light is on. When set to «1», the high-beam light is activated.

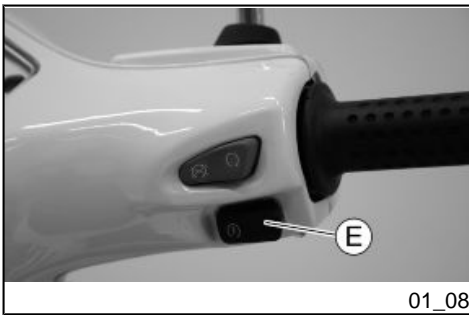

### Start-up button (01\_08)

Starter button «E»

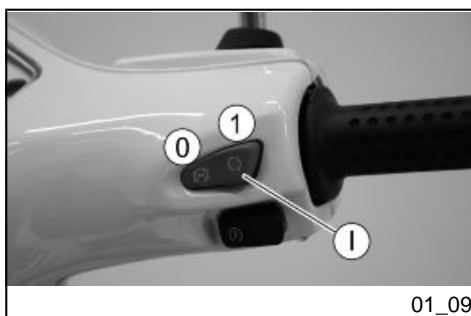

### Engine stop button (01\_09)

The engine can be started when the emergency cut-off switch «**I**» is set to «**1**» **RUN**; if the emergency cut-off switch «**I**» is set to «**0**» **OFF** , the engine cannot be started, or it shuts off if already running.

### The immobilizer system

In order to enhance theft protection, the scooter is equipped with a «**PIAGGIO IMMOBILIZER** » electronic engine locking device that is activated automatically when the starter key is removed. Upon start-up, the «**PIAGGIO IMMOBILIZER**» system checks the starter key, and only if this key is recognised will the immobilizer system allow the scooter to be started.

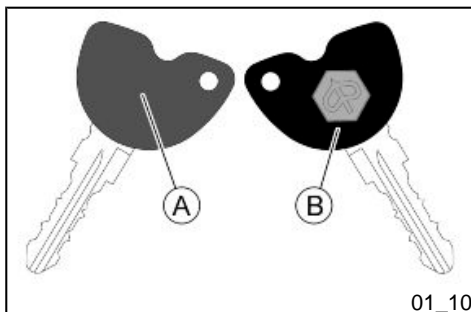

### Keys (01\_10, 01\_11, 01\_12)

Two types of keys come with the vehicle.

The key «**A**» is the «**MASTER**» key.

Only a single copy of this key is supplied, which is necessary to program all your other keys and for your dealer to perform some maintenance operations. For this reason it is advised that it be used only in exceptional circumstances.

The key «**B**» (single copy supplied) is used for regular operations such as:

- Engine start-up.

Together with the two keys, you will be given a **CODE CARD** bearing the same code imprinted onto the two keys.

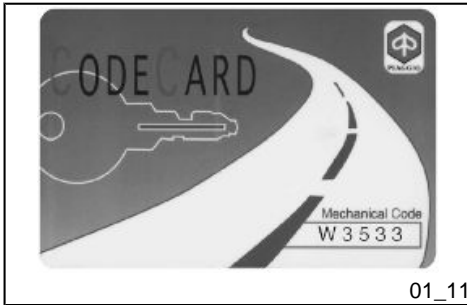

01\_11

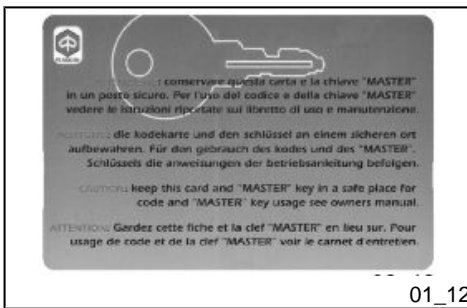

01\_12



01\_13

**WARNING**

**LOSING THE MASTER KEY PREVENTS ANY FURTHER REPAIR OF THE "PIAGGIO IMMOBILIZER" SYSTEM AND OF THE ENGINE CONTROL UNIT.**

**WARNING**

**KEEP THE "CODE CARD" AND THE MASTER KEY IN A SAFE PLACE (NOT IN THE VEHICLE).**

**Immobilizerdevice enabled indicator led (01\_13)**

The activation of the «**PIAGGIO IMMOBILIZER**» system is signalled by the a flashing indicator «**N**».

In order to reduce battery discharge, the indicator LED turns off automatically after 48 hours of uninterrupted functioning.

Should the system fail, different LED flashing patterns will provide the **Authorised Service Centre** with information on the type of fault detected.



## Operation

Each time the starter key «**B**» is removed while in the «**OFF**» or «**LOCK**» positions, the protection system activates the engine lock. Turning the starter key «**B**» to «**ON**» disables the engine lock, provided that the safety system recognises the code transmitted by the key. If the code is not recognised, turn the starter key «**B**» first to «**OFF**» and then back to «**ON**» again; if lock persists, try again using the «**A**» MASTER key. If the engine cannot be started, contact an **Authorised Service Centre**, which is provided with the electronic equipment required to detect and repair the system.

When the supplementary starter keys are required, remember that the all the keys, whether new or existing, should be programmed.

Contact an **Authorised Service Centre** and bring the «**A**» MASTER key and all «**B**» starter keys that you own.

The codes of starter keys not submitted for the new programming procedure are deleted from the memory. Any lost starter keys will therefore not be enabled to start the engine.

### WARNING



**EACH KEY HAS ITS OWN AND UNIQUE CODE, WHICH MUST BE STORED BY THE SYSTEM CONTROL UNIT.**

**VIOLENT SHOCKS MAY AFFECT THE ELECTRONIC COMPONENTS OF THE KEY.**

**IF THE VEHICLE IS SOLD, THE MASTER-HANDGRIP KEY (AS WELL AS THE OTHER STARTER KEYS) AND THE «CODE CARD» MUST ALSO BE TRANSFERRED TO THE NEW OWNER.**

## Programming the immobilizer system (01\_14)

Below is described the procedure to follow for programming the **PIAGGIO IMMOBILIZER** system and/or for storing other key codes. The programming procedure should be carried out with the engine stop switch set to «**RUN**».

### START PROCEDURE

Insert the «**MASTER**» key «**A**» into the key switch (in «**OFF**») and turn it to «**ON**». After 1 - 3 seconds, turn the key to «**OFF** » again and pull it out.

### INTERMEDIATE STAGE

After extracting the «**MASTER**» key «**A**», insert, within ten seconds, the key that is going to be programmed «**B**» and turn it immediately to «**ON**». After 1-3 seconds, turn the key to «**OFF**» again and pull it out. In this way, a maximum of 7 keys can be programmed by repeating the above procedure and keeping the indicated times.

### FINAL STAGE

After extracting the key to be programmed «**B**», insert the «**MASTER**» key «**A**» again and turn it to «**ON**» (perform this operation within the 10 seconds following the extraction of the previous key). Leave it in this position for 1 to 3 seconds and return it to «**OFF**».

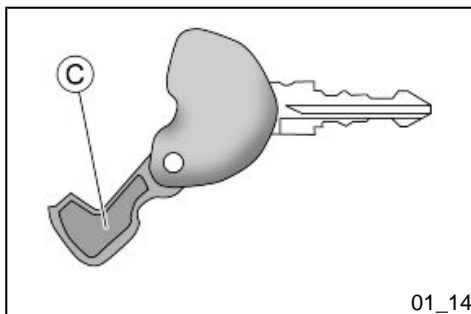

#### CORRECT PROGRAMMING CHECK PHASE

Insert the «MASTER» key «A» disabling the transponder «C» (i.e., by tilting the key cap by 90°), and turn the key to «ON». Perform the engine start-up operation. Ensure that the engine does not start. Insert the programmed key «B» and repeat the start-up operation. Check that engine starts.

#### WARNING



**SHOULD YOU STAR THE ENGINE WITH THE MASTER KEY (WITH TRANSPONDER OFF) OR IN THE EVENT OF WRONG OPERATION DURING PROGRAMMING, REPEAT THE PROCEDURE FROM THE BEGINNING.**

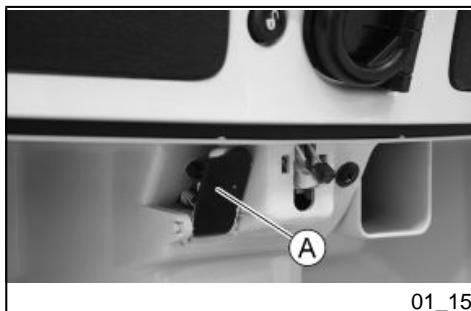

#### Accessing the fuel tank (01\_15, 01\_16)

With the key set to «OFF» or «ON», or with engine on, it is possible to electrically open the saddle by pressing the button «C». If the saddle opening system does not work, operate the emergency lever «A».

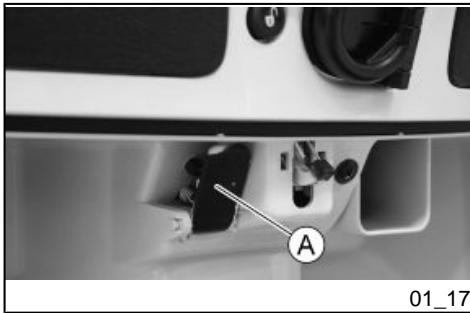
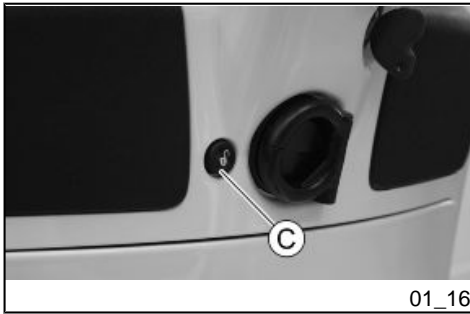

### Opening the saddle (01\_17, 01\_18)

With the key set to «OFF» or «ON», or with engine on, it is possible to electrically open the saddle by pressing button «C». If the electric opening does not work, use the emergency lever "A". When the key is set to «LOCK» the saddle cannot be opened.

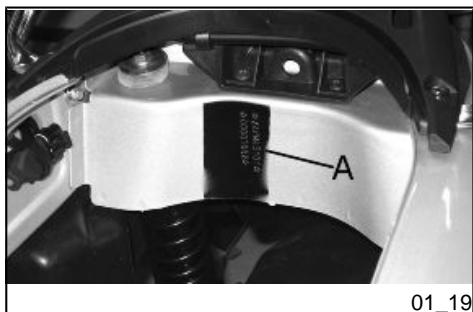

### Identification (01\_19, 01\_20, 01\_21)

The identification registration numbers consist of a prefix followed by a number stamped on both the chassis «A» and the engine «B». These numbers must always be indicated on spare parts requests. To read the chassis number, lift the saddle and remove the helmet compartment «C». We recommend checking that the chassis registration number stamped on the vehicle corresponds with that on the vehicle documentation.

#### CAUTION



**BE REMINDED THAT ALTERING IDENTIFICATION REGISTRATION NUMBERS CAN LEAD TO SERIOUS PENAL SANCTIONS (IMPOUNDING OF THE VEHICLE, ETC.).**

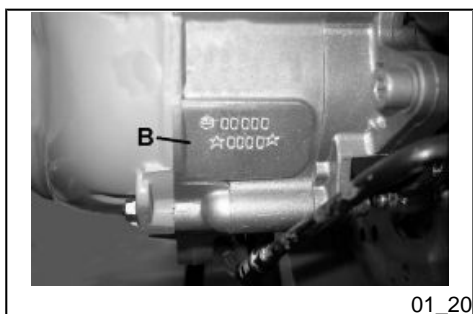

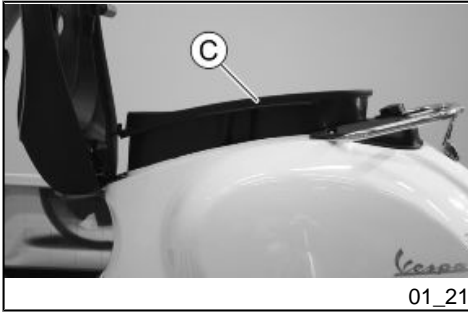

### Rear top box opening (01\_22)

Insert the key into the switch and press down until the glove compartment opens. If the switch is set to "LOCK", turn the key to "OFF" or "ON" before pressing it down.



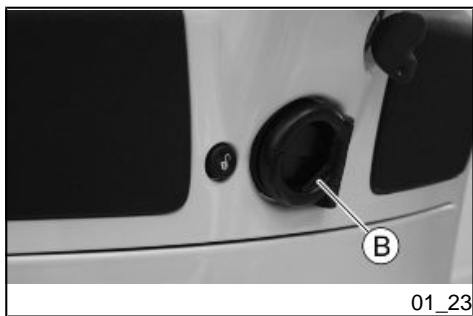

### Bag clip (01\_23)

To use the retractile bag hook «**B**» mounted on the knee-guard panel, pull it slightly towards the back part of the vehicle.





# Vespa GTS Super 300

The Vespa logo is rendered in a bold, black, stylized script font, slanted downwards from left to right. A registered trademark symbol (®) is located at the end of the word.

**Chap. 02**  
**Use**

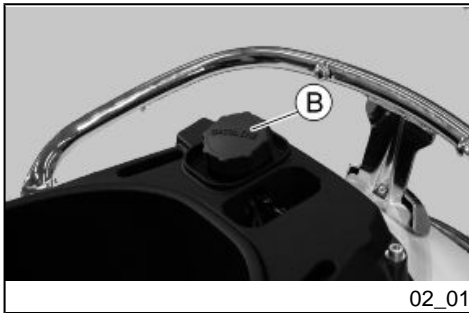

02\_01

## Checks

Before using the vehicle, check:

1. There is enough fuel in the fuel tank.
2. The correct fluid level for front and rear brakes.
3. That tyres are properly inflated.
4. The correct functioning of tail lights, headlamp, turn indicators, stop light and license plate light.
5. The correct functioning of front and rear brakes.
6. The oil level in the gearcase.
7. The engine oil level.
8. The coolant level.

## Refuelling (02\_01, 02\_02)

Fuel: lift the saddle and unscrew the cap «B». Recommended fuel: Unleaded petrol, min octane rating of 95. The fuel reserve level is signalled when the warning light «L» turns on.

### WARNING



**SWITCH OFF THE ENGINE BEFORE REFUELLING WITH PETROL.**

**PETROL IS HIGHLY INFLAMMABLE.**

**DO NOT SMOKE AND KEEP OPEN FLAMES AT A DISTANCE: FIRE HAZARD.**

**DO NOT INHALE FUEL FUMES.**

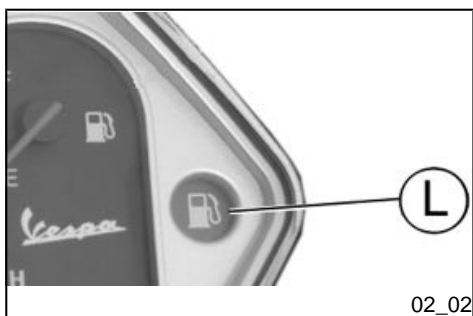

**DO NOT ALLOW PETROL TO COME INTO CONTACT WITH HOT ENGINE OR ANY PLASTIC PARTS.**

**CAUTION**



**PETROL DAMAGES THE PLASTIC PARTS OF THE BODYWORK.**

**CAUTION**



**USING OILS OTHER THAN THOSE RECOMMENDED CAN SHORTEN THE LIFE OF THE ENGINE.**

**CAUTION**



**DO NOT USE THE VEHICLE TO THE COMPLETE EXHAUSTION OF THE FUEL; IN THE EVENT THAT THIS SHOULD OCCUR, DO NOT ATTEMPT TO START THE ENGINE. TURN THE KEY SWITCH TO OFF AND TOP-UP THE TANK AS SOON AS POSSIBLE. FAILURE TO FOLLOW THESE GUIDELINES COULD DAMAGE THE FUEL PUMP AND/OR THE CATALYTIC CONVERTER.**

**Characteristic**

**Fuel tank capacity**

~ 9.2 litres

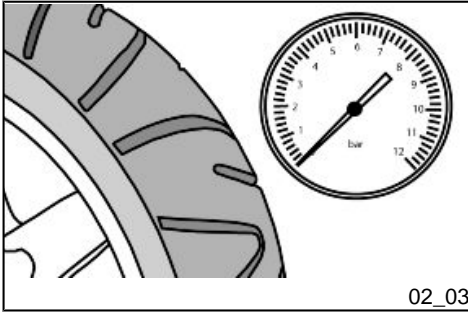

### Tyre pressure (02\_03)

Check the tyre pressure and wear periodically (roughly every 500 km). Tyres feature wear indicators; replace tyres as soon as these indicators become visible on the tyre tread. Also check that the tyres do not show signs of splitting at the side or irregular tread wear; if this occurs, go to an authorised workshop or at least to a workshop equipped to perform the replacement.

#### CAUTION



**TYRE PRESSURE SHOULD BE CHECKED WHEN TYRES ARE COLD. INCORRECT TYRE PRESSURE CAUSES ABNORMAL TYRE WEAR AND MAKES RIDING DANGEROUS.**

**TYRES MUST BE REPLACED WHEN THE TREAD REACHES THE WEAR LIMITS SET FORTH BY LAW.**

### TYRES

Front tyre	120/70 - 12" 51P Tubeless
Rear tyre	Tubeless 130/70 12" 62P

### TYRE INFLATION PRESSURE

Front tyre pressure (with passenger)	1.8 bar (-)
Rear tyre pressure (with passenger)	2.2 bar (-)

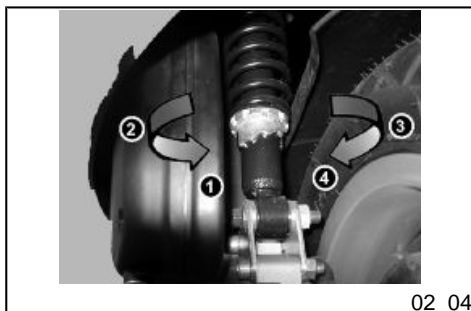

### Shock absorbers adjustment (02\_04)

The preloading of the springs can be adjusted to 4 positions using the ring nut located in the lower part of the shock absorbers and the specific spanner supplied.

**Position 1:** minimum preload: driver only

**Position 2:** medium preloading: driver only

**Position 3:** medium preloading: rider and passenger

**Position 4:** maximum preloading: driver, passenger, and luggage.

In order to carry out this operation you will need to use the specific spanner in the kit.

#### CAUTION



**RIDING THE VEHICLE WITH THE SPRING PRELOADING NOT CORRECTLY SET FOR THE RIDER AND POSSIBLE PASSENGER, COULD REDUCE THE COMFORT OF THE RIDE AND THE PRECISION OF THE STEERING.**

#### WARNING



**WE RECOMMEND WEARING GLOVES WHILE CARRYING OUT THIS OPERATION IN ORDER TO AVOID INJURIES.**

#### WARNING



**WE STRONGLY RECOMMEND NOT TO ADJUST BOTH SHOCK ABSORBERS WITH DIFFERENT PRELOADING**

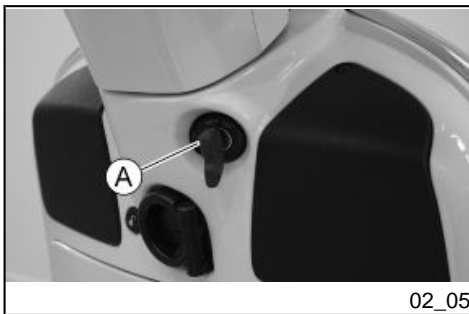

## Running in

### WARNING



**DURING THE FIRST 1000 KM DO NOT RIDE THE VEHICLE OVER 80% OF ITS MAXIMUM SPEED. AVOID TWISTING THE THROTTLE GRIP FULLY OR KEEPING A CONSTANT SPEED ALONG LONG SECTIONS OF ROAD. AFTER THE FIRST 1000 KM, GRADUALLY INCREASE SPEED UNTIL REACHING THE MAXIMUM PERFORMANCE.**

## Starting up the engine (02\_05, 02\_06)

To start the engine it is necessary, before pressing the starter button, to pull and keep pulled the front or rear brake lever, which activates the appropriate switch allowing start-up.

1. Rest the vehicle on its centre-stand, ensuring the rear wheel is not touching the ground.
2. Maintain the throttle grip «E» completely untwisted.
3. Insert the key into the ignition switch «A» and turn it to «ON».
4. Make sure that the «B» switch is set to «RUN».
5. Pull lever «C» of the front or rear brake and then activate the starter button «D».

### WARNING



**THE AUTOMATIC TRANSMISSION MAKES THE REAR WHEEL TURN EVEN WHEN THE THROTTLE IS SLIGHTLY TWISTED. RELEASE THE BRAKE CAREFULLY AFTER STARTING, AND THEN ACCELERATE GRADUALLY.**

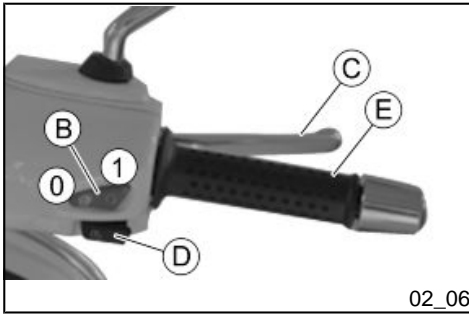

#### CAUTION



DO NOT START-UP THE ENGINE IN CLOSED AREAS BECAUSE EXHAUST GASES ARE TOXIC.

#### Precautions

#### CAUTION



NEVER STRESS THE ENGINE AT LOW TEMPERATURES IN ORDER TO AVOID POSSIBLE DAMAGE. BE CAREFUL NEVER TO EXCEED THE MAXIMUM SPEED WHILE RUNNING DOWNHILL, IN ORDER TO AVOID DAMAGING THE ENGINE. IN ANY CASE, IN ORDER TO PRESERVE THE ENGINE FROM PROLONGED EXCESSIVE REVOLUTIONS, THE REVOLUTION LIMITER WILL BE ACTIVATED IF THE ENGINE SPEED EXCEEDS THE ESTABLISHED THRESHOLD.

#### WARNING



AFTER A LONG DISTANCE COVERED AT THE MAXIMUM SPEED, DO NOT STOP THE ENGINE IMMEDIATELY, BUT LET IT RUN AT IDLE FOR A FEW SECONDS.

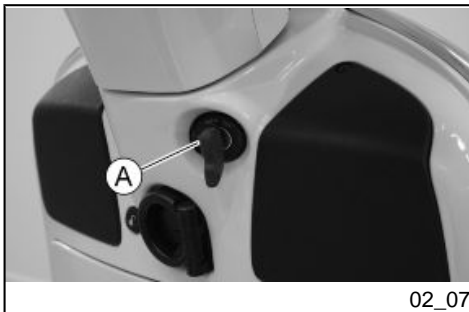

02\_07

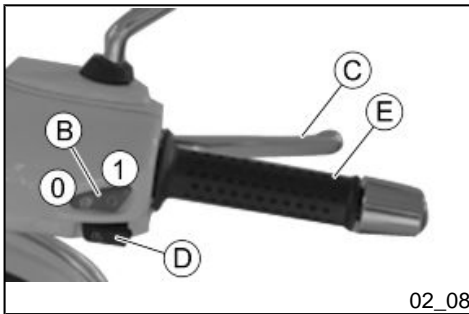

02\_08

### Difficult start up

In the rare case of flooding the engine, to facilitate start-up, it is possible to try to put the vehicle into action with the gas hand grip partially or completely open. It is however necessary, once the engine is started, to take your vehicle to an **Authorised Service Centre** to determine the cause of this problem and to re-establish the vehicle proper functioning.

### Stopping the engine (02\_07, 02\_08)

Fully untwist the throttle grip and then turn the switch key «A» to «OFF» (extractable key), or turn the switch «B» to «OFF».

#### CAUTION



**DUE TO THE HIGH TEMPERATURES THE CATALYTIC CONVERTER CAN REACH, ALWAYS TAKE CARE, WHEN PARKING THE SCOOTER, THAT THE EXHAUST DOES NOT COME INTO CONTACT WITH FLAMMABLE MATERIALS, TO AVOID SERIOUS BURNS.**

#### CAUTION



**DO NOT SWITCH OFF THE ENGINE WHILE THE VEHICLE IS MOVING. UNBURNED FUEL COULD ENTER THE CATALYTIC CONVERTER AND BURN, CAUSING IT TO OVERHEAT AND POSSIBLY DESTROYING IT.**



## Stand (02\_09)

### CENTRE STAND

Push with your foot on the centre stand's fork «F» while lifting the vehicle backward, holding onto the handlebar.

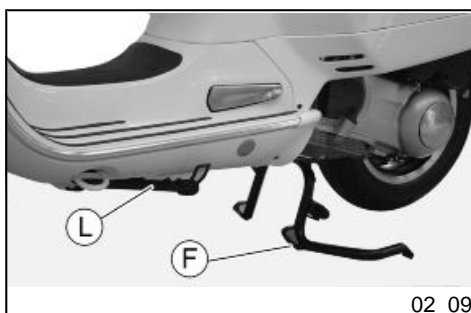

### SIDE STAND

With your foot push the projection of the stand «L » in order to open it and at the same time lean the vehicle on you.

## Automatic transmission

To ensure simple, pleasurable riding, the vehicle is equipped with automatic transmission with regulator and centrifugal clutch. The system is designed to provide the best performance (acceleration and consumption) while riding on both flat roads and uphill.

If you have to stop on an uphill slope (traffic lights, traffic jam, etc.) **use only the brake to keep the vehicle still, leaving the engine running at idle speed. Using the engine to keep the vehicle still can cause the clutch to overheat, due to the friction of the clutch mechanism itself against the clutch bell.**

It is therefore recommended to avoid conditions of prolonged clutch slippage (other than those previously indicated) like driving uphill fully laden on steep slopes or starting off with driver and passenger at slopes with steepness greater than 25%.

Observe the following precautions if the clutch overheats:

1. Do not continue riding in such conditions.
2. Let the clutch cool down with the engine at idle speed for a few minutes.

### Safe driving (02\_10)

#### WARNING



**SOME SIMPLE TIPS ARE PROVIDED BELOW THAT WILL ENABLE YOU TO USE YOUR SCOOTER ON A DAILY BASIS IN GREATER SAFETY AND WITH MORE PEACE OF MIND.**

<



Your ability and your knowledge of the vehicle form the basis of safe riding. We recommend trying out the vehicle in traffic-free zones to get to know your vehicle completely.

#### **ALWAYS DRIVE WITHIN YOUR LIMITS**

1. Before riding off, remember to put on your helmet and fasten it correctly.
2. Reduce speed and ride cautiously on uneven roads.
3. Remember that after riding on a long stretch of wet road without using the brakes, the braking effect is initially lower. Given these conditions, it is a good idea to operate the brakes from time to time.
4. Do not brake hard on a wet surface, on dirt tracks or on any slippery road surface.
5. If you have to brake, use both brakes in order to divide the braking action between both wheels.

6. Avoid starting off by mounting the scooter while it is still resting on its stand. In any case, the rear wheel should not be turning when it comes into contact with the ground, in order to avoid abrupt departures.

7. If the vehicle is used on roads covered with sand, mud, snow mixed with salt, etc., clean the brake disc frequently with mild detergent in order to prevent abrasive substances from building up within the holes, which can result in early wear of the brake pads.

8. Any elaboration that modifies the vehicle's performances, such as tampering with original structural parts is strictly forbidden by law, and renders the vehicle not conforming to the approved type and therefore dangerous to ride.

**CAUTION**

**DO NOT FORGET THAT DRIVING IN A STATE OF DRUNKENNESS, OR WHEN UNDER THE EFFECT OF DRUGS OR CERTAIN MEDICINES, CAN BE EXTREMELY DANGEROUS FOR ONESELF AND FOR OTHERS.**

**CAUTION**

**ANY CHANGES TO THE VEHICLE PERFORMANCE AS WELL AS ALTERATIONS TO ORIGINAL STRUCTURAL PARTS IS STRICTLY FORBIDDEN BY LAW, AND RENDERS THE VEHICLE NO LONGER CONFORMING TO THE APPROVED TYPE AND DANGEROUS FOR RIDING.**



# Vespa GTS Super 300

The Vespa logo is a stylized, italicized script font in black, positioned below the main title.

**Chap. 03  
Maintenance**

## Engine oil level

In 4T engines, engine oil is used to lubricate the distribution elements, main bearings and thermal group. **An insufficient quantity of oil can cause serious damage to the engine itself.** In all four-stroke engines, a loss of efficiency in oil performance and consumption should be considered normal. Consumption can particularly reflect the conditions of use (i.e. when driving at "full acceleration" all the time, oil consumption increases). The replacement frequencies provided for by the maintenance programme are defined, depending on the total contents of oil in the engine and average consumption measured following standardised methods. **In order to prevent any problems, we recommend checking oil level more frequently than indicated in the Scheduled Maintenance table or before setting off on long journeys. The vehicle is, however, equipped with an oil pressure warning light on the instrument panel.**

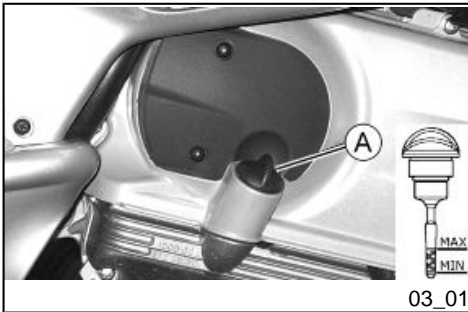

### Engine oil level check (03\_01)

Every time the scooter is used, a visual check should be made on the level of the engine oil when the engine is cold. The oil level should be somewhere between the **MAX** and **MIN** index marks on the level bar; the check must be made with the scooter upright, resting on the centre stand. If the check is carried out after the vehicle has been used, and therefore with a hot engine, the level line will be lower; in order to carry out a correct check, wait at least 10 minutes after the engine has been stopped so as to get the correct level.

### Engine oil top-up

Always check oil level before topping-up and add oil **without exceeding the MAX level.** Getting an oil level between the **MIN** and **MAX** levels requires ~ 400 cm<sup>3</sup> of oil. Take your vehicle to an **Authorised Service Centre** to have the engine oil checked and if necessary, topped-up as indicated in the scheduled maintenance table.

### Warning light (insufficient oil pressure)

The vehicle is equipped with a warning light that lights up when the key is turned to the «ON». However, this light should switch off once the engine has been started. **If the light comes on while braking, at idle speed or while turning a corner, it is necessary to check the oil level and top it up if required. If after having topped-up the oil, the warning light still comes on while braking, at idle speed or while turning a corner, it will be necessary to take your vehicle to an Authorised Service Centre.**

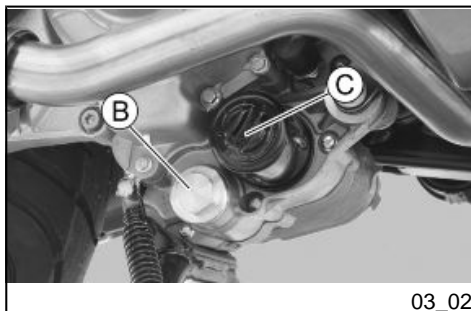

03\_02

### Engine oil change (03\_02)

Have oil changed and the cartridge filter «C» replaced as indicated in the scheduled maintenance table at an **Authorised Service Centre**. The engine should be emptied by draining the oil through drainage plug «B» of the mesh filter on the flywheel side. In order to facilitate the oil drainage, loosen the cap/dipstick. Since a certain quantity of oil still remains in the circuit, add approx. 950 ÷ 1000 cm<sup>3</sup> of oil through the cap «A». Then start the engine, leave it running for a few minutes and shut it off: after 5 minutes, check the level and if necessary, top-up **without exceeding the MAX level**. The cartridge filter must be replaced at every oil change. For top-ups and changes, use new oil of the recommended type.

#### WARNING



**RUNNING THE ENGINE WITH INSUFFICIENT LUBRICATION OR WITH INADEQUATE LUBRICANTS ACCELERATES THE WEAR AND TEAR OF THE MOVING PARTS AND CAN CAUSE IRRETRIEVABLE DAMAGE.**

#### WARNING



**EXCESSIVE OIL LEVEL AT TOP-UPS CAN LEAD TO SCALE FORMATION AND VEHICLE MALFUNCTION.**

**CAUTION**

USED OILS CONTAIN SUBSTANCES HARMFUL TO THE ENVIRONMENT. FOR OIL CHANGE, CONTACT AN AUTHORISED PIAGGIO SERVICE CENTRE, AS THEY ARE EQUIPPED TO DISPOSE OF USED OILS IN AN ENVIRONMENTALLY FRIENDLY AND LEGAL WAY.

**CAUTION**

USING OILS OTHER THAN THOSE RECOMMENDED CAN SHORTEN THE LIFE OF THE ENGINE.

**Recommended products****AGIP CITY HI TEC 4T***Engine oil*

SAE 5W-40, API SL, ACEA A3, JASO MA Synthetic oil

**Hub oil level (03\_03, 03\_04)**

Check the oil in the rear hub. To check the rear hub oil level, proceed as follows:

- 1) Park the scooter on level ground and rest it on its stand.
- 2) Unscrew dipstick «A», wipe it clean with a cloth, reinsert it and **tighten completely**.
- 3) Pull out the dipstick and check that the oil level is above the first notch from the bottom.
- 4) Reinsert the dipstick and ensure that it is tightened correctly.

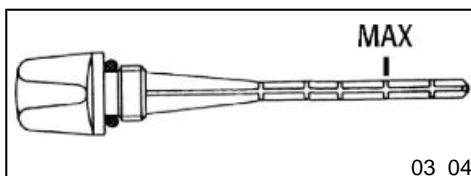

**N.B.**

THE NOTCHES ON THE HUB OIL LEVEL DIPSTICK, EXCEPT THE ONE INDICATING THE MAX LEVEL, REFER TO OTHER MODELS BY THE MANUFACTURER AND HAVE NO SPECIFIC FUNCTION FOR THIS MODEL.

**CAUTION**

RIDING THE VEHICLE WITH INSUFFICIENT HUB LUBRICATION OR WITH CONTAMINATED OR IMPROPER LUBRICANTS ACCELERATES THE WEAR AND TEAR OF THE MOVING PARTS AND CAN CAUSE SERIOUS DAMAGE.

**CAUTION**

USED OIL CAN HARM THE ENVIRONMENT. COLLECTION AND DISPOSAL SHOULD BE CARRIED OUT IN COMPLIANCE WITH CURRENT REGULATIONS.

**CAUTION**

AN EXCESSIVE QUANTITY OF OIL CAN LEAD TO SPILL OVER, WHICH MAY CAUSE THE ENGINE AND THE WHEEL TO GET DIRTY.

**CAUTION**

WHEN REPLACING THE HUB OIL DO NOT LET THE OIL COME INTO CONTACT WITH THE REAR BRAKE DISC.

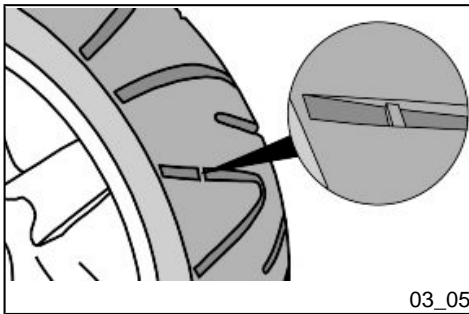

03\_05

**CAUTION**

**FOR OIL REPLACEMENT, CONTACT ANY AUTHORISED SERVICE CENTRE AS THEY ARE EQUIPPED TO DISPOSE OF USED OILS IN AN ENVIRONMENTALLY FRIENDLY AND LEGAL WAY.**

**Recommended products**

**AGIP ROTRA 80W-90**

*Rear hub oil*

SAE 80W/90 Oil that exceeds the requirements of API GL3 specifications

**Characteristic**

**Rear hub oil**

250 cc

**Tyres (03\_05)**

Check the tyre pressure and wear periodically (roughly every 500 km). Tyres feature wear indicators; replace tyres as soon as these indicators become visible on the tyre tread. Also check that the tyres do not show signs of splitting at the side or irregular tread wear; if this occurs, go to an authorised workshop or at least to a workshop equipped to perform the replacement.

**CAUTION**

**TYRE PRESSURE SHOULD BE CHECKED WHEN TYRES ARE COLD. INCORRECT TYRE PRESSURE CAUSES ABNORMAL TYRE WEAR AND MAKES RIDING DANGEROUS.**

**TYRES MUST BE REPLACED WHEN THE TREAD REACHES THE WEAR LIMITS SET FORTH BY LAW.**

### **TYRES**

Front tyre	120/70 - 12" 51P Tubeless
Rear tyre	Tubeless 130/70 12" 62P

### **TYRE INFLATION PRESSURE**

Front tyre pressure (with passenger)	1.8 bar (-)
Rear tyre pressure (with passenger)	2.2 bar (-)

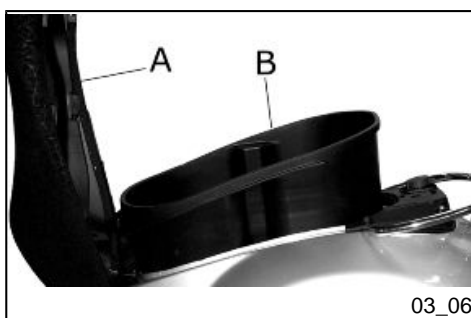

### **Spark plug dismantlement (03\_06, 03\_07)**

Proceed as follows:

1. Lift the saddle «**A**».
2. Lift the helmet compartment «**B**» and reach into the spark plug with your hand.
3. Disconnect the cap of the spark plug HV wire «**C**».
4. Unscrew the spark plug using the wrench supplied.
5. Upon refitting, place the spark plug in the hole at the due inclination and finger tighten it as far as it will go.

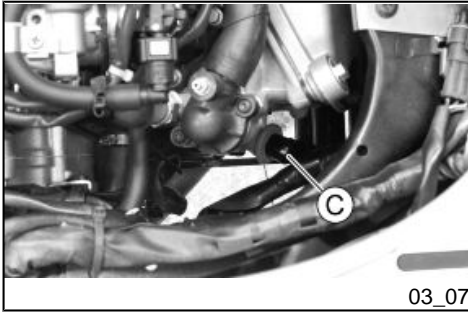

6. Use the box-spanner supplied only for locking.
7. Place the cap fully over the spark plug.

#### CAUTION



**SPARK PLUGS MUST BE REMOVED WHEN THE ENGINE IS COLD. SPARK PLUGS MAINTENANCE OPERATIONS ARE DESCRIBED IN THE SCHEDULED MAINTENANCE TABLE. USING NON-CONFORMING ELECTRONIC CENTRAL UNITS AND ELECTRONIC IGNITIONS OR SPARK PLUGS OTHER THAN THOSE PRESCRIBED MAY SERIOUSLY DAMAGE THE ENGINE.**

#### N.B.

**THE USE OF SPARK PLUGS OTHER THAN THE INDICATED TYPE OR OF SHIELDLESS SPARK PLUG CAPS CAN CAUSE ELECTRICAL SYSTEM FAILURES.**

#### Electric characteristic

##### Spark plug

NGK CR8EKB

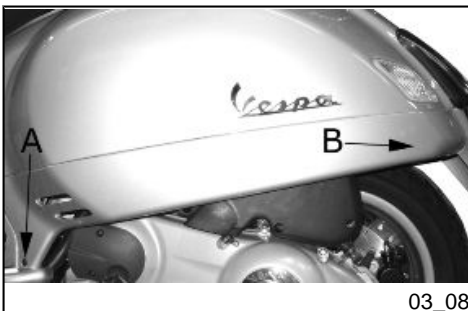

#### Removing the air filter (03\_08, 03\_09, 03\_10, 03\_11)

Proceed as follows:

1. unscrew the fixing screw «A».
2. unscrew the nut «B» under the body.
3. remove the left side fairing.
4. remove the helmet compartment;



03\_09

5. unscrew the fixing screws «C» that can be reached once the helmet compartment has been removed;

6. Unscrew the screws «D» and remove the air filter cover.

Remove the filtering element and clean it with water and shampoo; then dry it with a clean cloth and short blasts of compressed air. Finally, immerse it in a mixture of 50% oil of the recommended type and 50% petrol. Then gently squeeze the filter element between your hands, allow it to drip and then refit it. Oil or water deposits in the filter housing can be cleaned off by removing the two rubber caps «E».

#### CAUTION



IF THE VEHICLE IS USED ON DUSTY ROADS, IT IS NECESSARY TO SERVICE THE AIR FILTER MORE OFTEN TO AVOID DAMAGING THE ENGINE.

#### CAUTION



IN ORDER NOT TO DAMAGE THE VEHICLE PLASTIC COVERS CONTACT AN AUTHORISED SERVICE CENTRE TO HAVE THE AIR FILTER CLEANED.

#### Recommended products

##### AGIP FILTER OIL

*Oil for air filter sponge*

Mineral oil with specific additives for increased adhesiveness

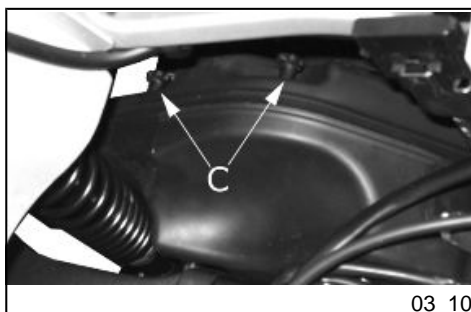

03\_10

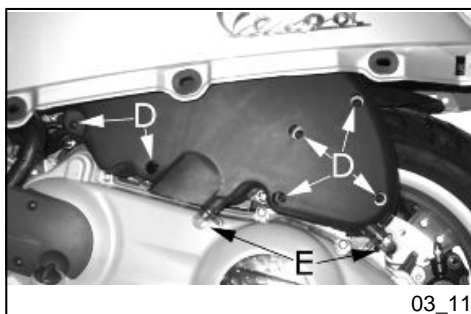

03\_11



03\_12



03\_13

### Cooling fluid level (03\_12, 03\_13)

The engine is cooled by a forced-circulation coolant system. The cooling circuit holds coolant consisting of a mixture of 50% de-ionised water and 50% glycol ethylene-based antifreeze solution with corrosion inhibitors. The recommended coolant is supplied premixed and ready to use. To ensure correct engine operation, the needle on the coolant temperature gauge must be at the centre of the scale. If the needle enters the red zone, turn off the engine, allow the engine to cool then check the coolant level; if the level is OK, take your scooter to an **Authorised Piaggio Service Centre**. If when using your scooter at a low gear the coolant temperature exceeds the above values, shut off the engine and let it cool down. Then check the coolant level; if level is OK, take your scooter to an **Authorised Piaggio Service Centre**. Check coolant when the engine is cold at the intervals indicated in the scheduled maintenance table, following the steps below.

- a) Place the scooter in a vertical position on the stand.
- b) Unscrew the fixing screw «A» and remove the cover.
- c) Check the fluid level according to the two marks- MIN and MAX «B» on the reservoir
- d) Top up if the fluid level is below the MIN level on the scale inside the expansion tank. The fluid level must always be between the MIN and MAX levels.

If the fluid is near the minimum level, top-up only when the engine is cold. If the coolant needs to be topped up frequently or the expansion tank is completely dry, check the cooling system for the cause of the problem. Have the cooling system checked at an **Authorised Piaggio Service Centre**. Coolant must be changed every 2 years at an **Authorised Piaggio Service Centre**.

#### WARNING



**TO AVOID THE RISK OF SCALDING, DO NOT UNSCREW THE EXPANSION TANK COVER WHILE THE ENGINE IS STILL HOT.**

**WARNING**

IN ORDER TO AVOID HARMFUL FLUID LEAKS WHILE RIDING, IT IS IMPORTANT TO MAKE SURE THAT THE LEVEL NEVER EXCEEDS THE MAXIMUM VALUE.

IN ORDER TO GUARANTEE THE PROPER FUNCTION OF THE ENGINE, IT IS NECESSARY TO KEEP THE RADIATOR GRILLE CLEAN.

**Recommended products****AGIP PERMANENT SPEZIAL***coolant*

Monoethylene glycol-based antifreeze fluid, CUNA NC 956-16

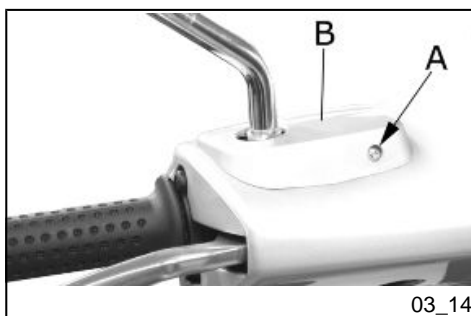
**Checking the brake oil level (03\_14, 03\_15)**

The brake fluid reservoirs are located on the pumps under the handlebar cover (front on the right-hand side, rear on the left-hand side). The procedures to check the brake fluid level for the front and rear brakes are identical.

Proceed as follows:

1. rest the scooter on its centre stand and make sure the handlebar is centred;
2. check fluid level through the corresponding warning light «C».

A certain lowering of the level is caused by wear on the pads. Should the level appear to be below the minimum mark, please contact an **Authorised Service Centre or Dealer** in order to have a thorough inspection of the braking system carried out. Proceed as follows:

3. remove the tank cover «D» loosening the two screws «E» and refill reaching the correct level with the prescribed brake fluid type only and without exceeding the maximum level.

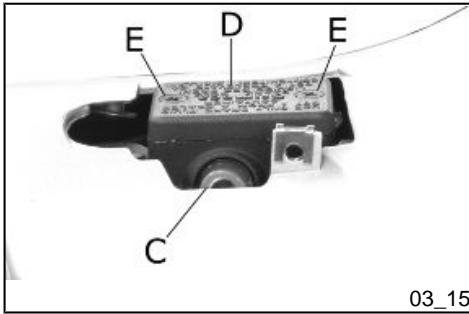

Under normal climatic conditions, the brake fluid should be changed every 2 years. This operation must be carried out by trained personnel; take your vehicle to an **authorised Service centre or Dealer**.

#### WARNING



**ONLY USE DOT 4 CLASS BRAKE FLUIDS. COOLING SYSTEM FLUIDS ARE HIGHLY CORROSIVE. MAKE SURE THAT IT DOES NOT COME INTO CONTACT WITH THE PAINTWORK**

#### CAUTION



**AVOID CONTACT OF BRAKE FLUID WITH EYES, SKIN, AND CLOTHING. IN CASE OF CONTACT, RINSE WITH WATER. THE BRAKING CIRCUIT FLUID IS HYGROSCOPIC, THAT IS, IT ABSORBS HUMIDITY FROM THE SURROUNDING AIR. IF THE HUMIDITY IN THE BRAKING FLUID EXCEEDS A CERTAIN VALUE, IT WILL LEAD TO INEFFICIENT BRAKING. NEVER USE BRAKING FLUID KEPT IN CONTAINERS THAT HAVE ALREADY BEEN OPENED, OR PARTIALLY USED.**

#### Recommended products

##### AGIP BRAKE 4

*Brake fluid*

FMVSS DOT 4 Synthetic fluid



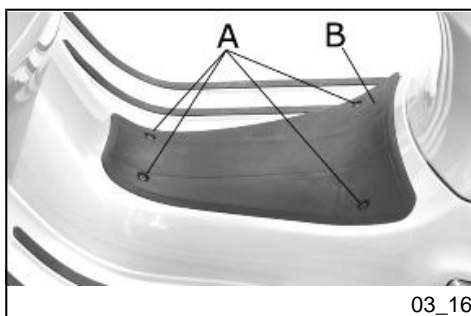

03\_16

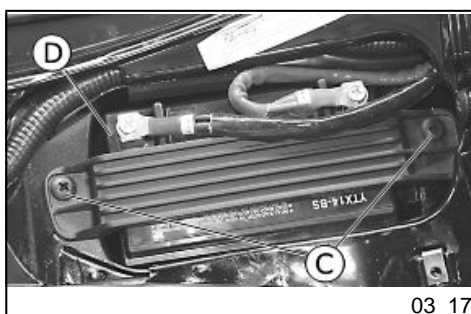

03\_17

### Battery (03\_16, 03\_17)

To reach the battery «D», proceed as follows:

1. rest the scooter on its centre stand;
2. unscrew the 4 screws «A», remove the footrest «B».
3. remove the two battery fixing screws «C».

#### WARNING



IN ORDER TO AVOID DAMAGING THE ELECTRICAL SYSTEM, NEVER DISCONNECT THE WIRING WHILE THE ENGINE IS RUNNING.

#### CAUTION

UPON CONNECTING THE BATTERY TERMINALS, AVOID CONTACT WITH THE METAL BODY

#### WARNING

DO NOT TRY TO REMOVE THE BATTERY SEAL. THE ELECTROLYTE IN THE BATTERY CONTAINS SULPHURIC ACID : AVOID CONTACT WITH EYES, SKIN AND CLOTHES. IN THE CASE OF ACCIDENTAL CONTACT, RINSE WITH ABUNDANT OF WATER AND CONSULT A DOCTOR.

#### WARNING



SPENT BATTERIES ARE HARMFUL FOR THE ENVIRONMENT. COLLECTION AND DISPOSAL SHOULD BE CARRIED OUT IN COMPLIANCE WITH CURRENT REGULATIONS.

### Electric characteristic

#### Battery

12V - 12 Ah

### Use of a new battery

Ensure that the terminals are connected correctly and check voltage.

#### CAUTION



**DO NOT REVERSE THE POLARITY: RISK OF SHORT CIRCUIT AND DAMAGE TO THE ELECTRICAL SYSTEM.**

#### WARNING



**SPENT BATTERIES ARE HARMFUL FOR THE ENVIRONMENT. COLLECTION AND DISPOSAL SHOULD BE CARRIED OUT IN COMPLIANCE WITH CURRENT REGULATIONS.**

### Long periods of inactivity

Battery performance will decrease if the vehicle is not used for a long time. This is the result of the natural phenomenon of battery discharging plus residual absorption by vehicle components with constant power consumption. Poor battery performance may also be due to environmental conditions and the cleanliness of the poles. In order to avoid difficult starts and/or irreversible damage to the battery, follow any of these steps:

- **At least once a month** start the engine and run it slightly above idle speed for 10-15 minutes. This keeps all the engine components, as well as the battery, in good working order.

- Take your vehicle to a garage (as indicated in the "Vehicle not used for extended periods" section) to have the battery removed. Have the battery cleaned, charged fully and stored in a dry, ventilated place. Recharge **at least once every two months**.

**N.B.**

**THE BATTERY MUST BE CHARGED WITH A CURRENT EQUAL TO 1/10 OF THE RATED CAPACITY OF THE BATTERY AND FOR NOT LONGER THAN 10 HOURS. CONTACT AN AUTHORISED SERVICE CENTRE TO CARRY OUT THIS OPERATION SAFELY. WHEN REFITTING THE BATTERY MAKE SURE THE LEADS ARE CORRECTLY CONNECTED TO THE TERMINALS.**

**WARNING**

**DO NOT DISCONNECT THE BATTERY CABLES WITH THE ENGINE RUNNING, THIS CAN CAUSE PERMANENT DAMAGE TO THE VEHICLE ELECTRONIC CONTROL UNIT.**

**WARNING**

**SPENT BATTERIES ARE HARMFUL FOR THE ENVIRONMENT. COLLECTION AND DISPOSAL SHOULD BE CARRIED OUT IN COMPLIANCE WITH CURRENT REGULATIONS.**

**Fuses (03\_18, 03\_19, 03\_20, 03\_21, 03\_22, 03\_23)**

The electrical system is equipped with:

1. six protection fuses «A» located in the glove compartment to the left
2. two fuses «B» located under the helmet compartment under the saddle hinge latch.

3. one fuse «C» located under the helmet compartment on the left fairing.

The chart shows the position and characteristics of the fuses in the vehicle.

#### CAUTION



**BEFORE REPLACING A BLOWN FUSE, FIND AND SOLVE THE FAILURE THAT CAUSED IT TO BLOW. NEVER TRY TO REPLACE THE FUSE WITH ANY OTHER MATERIAL (E.G., A PIECE OF ELECTRIC WIRE).**

#### CAUTION



**MODIFICATIONS OR REPAIRS TO THE ELECTRICAL SYSTEM, PERFORMED INCORRECTLY OR WITHOUT STRICT ATTENTION TO THE TECHNICAL SPECIFICATIONS OF THE SYSTEM, CAN CAUSE ERRORS IN FUNCTIONING AND RISK OF FIRE.**

### FUSES

Fuse No. 1	<p><b>Capacity:</b> 30 A</p> <p><b>Protected circuits:</b> Battery recharge circuit, fuses No. 6-7.</p> <p><b>Live:</b> Fuses No. 4 - 5 - 8 - 9</p>
Fuse No. 2	<p><b>Capacity:</b> 7.5 A</p> <p><b>Protected circuits:</b> Electric fan remote control, injection load</p>

remote control, immobilizer aerial,  
ECU.

Fuse No. 3	<b>Capacity:</b> 15A <b>Protected circuits:</b> Injection load (via remote control), ECU.
------------	--

Fuse No. 4	<b>Capacity:</b> 10 A <b>Protected circuits:</b> Turn indicators, pre-installation for anti-theft device, instrument panel.
------------	--

Fuse No. 5	<b>Capacity:</b> 7.5 A <b>Protected circuits:</b> Horn, headlight remote control.
------------	--

Fuse No. 6	<b>Capacity:</b> 15A <b>Protected circuits:</b> Electric fan (via remote control), high-beam and low-beam lights (via remote control). <b>Live:</b> Saddle opening actuator.
------------	--

Fuse No. 7	<b>Capacity:</b> 10 A <b>Protected circuits:</b> Pre-installation for anti-theft device, instrument panel.
------------	---

Fuse No. 8	<b>Capacity:</b> 7.5 A <b>Protected circuits:</b> Start-up circuit, stop light.
------------	--

Fuse No. 9

**Capacity:** 7.5 A

**Protected circuits:** Tail lights, instrument panel lighting.

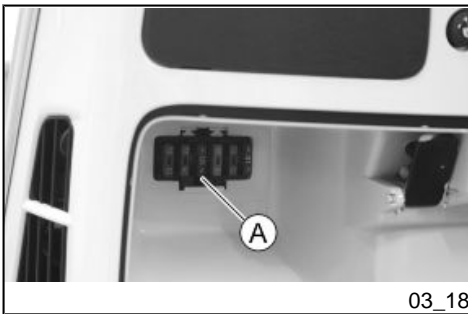

03\_18

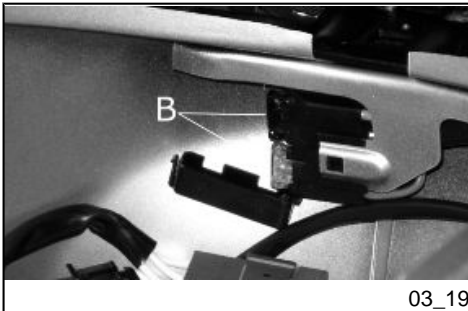

03\_19

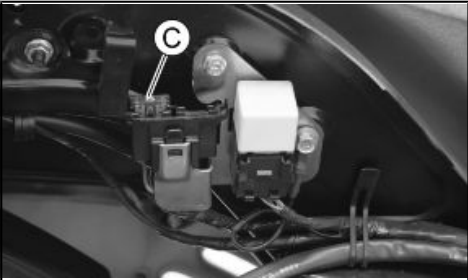

03\_20

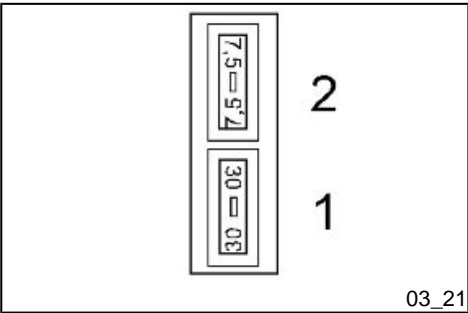

03\_21

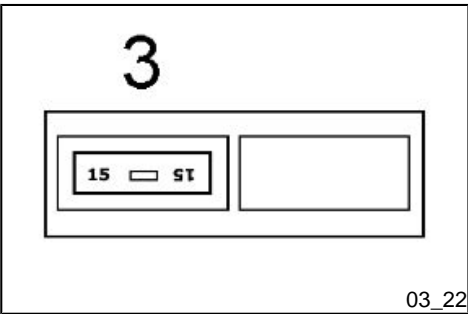

03\_22

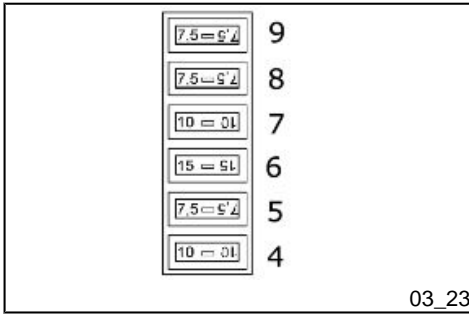

03\_23

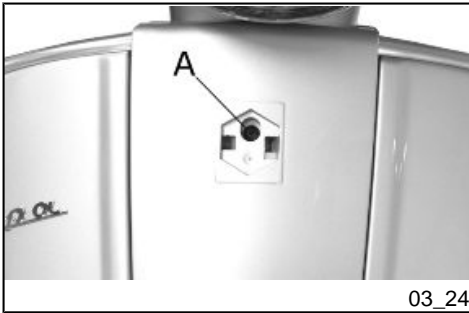

03\_24

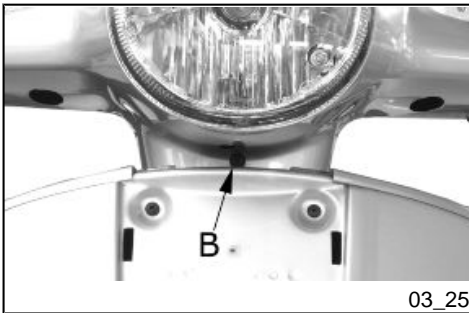

03\_25

### Front light group (03\_24, 03\_25, 03\_26, 03\_27)

To remove the front headlight assembly, proceed as follows:

1. Remove the rear-view mirrors.
2. Remove the screw «A» of the legshield grille.
3. Remove the screw «B» fixing the front handlebar cover.
4. Remove the screws «C» fixing the rear handlebar cover.
5. Detach the front handlebar cover.

So there is access to the bulbs. Open the ring nut and take out the high-/low-beam light bulb «D». To change the tail light take out the rubber bulb socket from its fitting. To reassemble, repeat the operation in the reverse order.

#### WARNING



**THE TWIN-FILAMENT (HIGH-BEAM AND LOW-BEAM) BULB IS HALOGEN: DO NOT TOUCH THE BULB WITH YOUR FINGERS TO AVOID COMPROMISING ITS FUNCTIONING**





03\_26

**N.B.**

IF MISTING IS NOTICED ON THE INSIDE OF THE HEADLAMP GLASS, THIS DOES NOT INDICATE A FAULT AND IS RELATED TO THE HUMIDITY AND/OR TO LOW TEMPERATURES.

THE PHENOMENON SHOULD QUICKLY DISAPPEAR WHEN THE LIGHT IS SWITCHED ON.

THE PRESENCE OF DROPS OF WATER, ON THE OTHER HAND, COULD INDICATE THAT WATER IS INFILTRATING. CONTACT THE PIAGGIO AFTER-SALES SERVICE NETWORK.

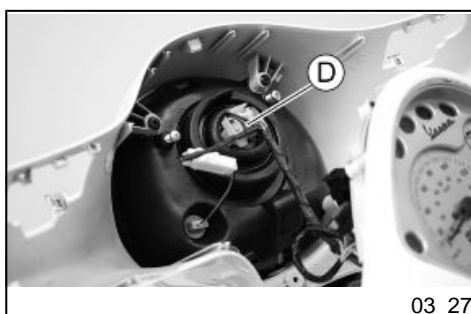

03\_27

**Headlight adjustment (03\_28, 03\_29)**

Proceed as follows:

1. Place the vehicle in running order and with the tyres inflated to the prescribed pressure, on a flat surface 10 m away from a white screen situated in a shaded area, making sure that the longitudinal axis of the scooter is perpendicular to the screen;
2. Turn on the headlight and check that the borderline of the projected light beam on the screen is not lower than 9/10 of the distance from the ground to the centre of vehicle headlamp and higher than 7/10;
3. If otherwise, adjust the right headlight with screw «A».

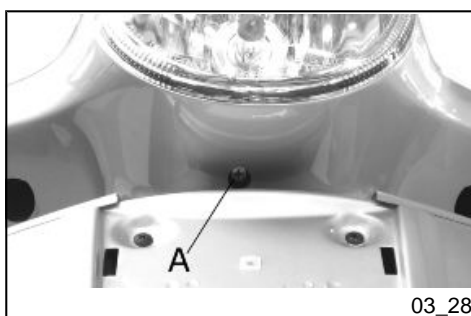

03\_28

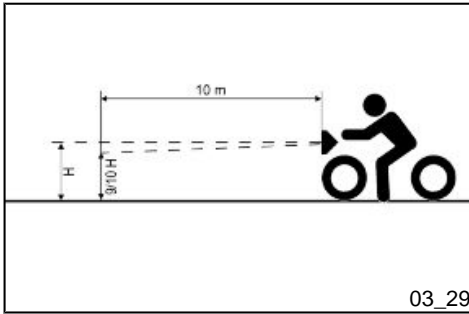
**N.B.**

THE ABOVE PROCEDURE COMPLIES WITH THE EUROPEAN STANDARDS REGARDING MAXIMUM AND MINIMUM HEIGHT OF LIGHT BEAMS. REFER TO THE STATUTORY REGULATIONS IN FORCE IN EVERY COUNTRY WHERE THE vehicle IS USED.

**Front direction indicators (03\_30)**

To replace the front turn indicator bulbs, remove the tail light taking out the retaining screw "A", remove the bulb holder from its fitting; gently turn the bulb around 30° and remove it. Follow the process in reverse order to refit.



03\_31

### Rear optical unit (03\_31)

Remove screw «A» to remove the rear headlight assembly.

Access to taillight bulbs, stop light bulb and license plate bulb.

To reassemble, repeat the operation in the reverse order.

#### N.B.

**IF MISTING IS NOTICED ON THE INSIDE OF THE HEADLAMP GLASS, THIS DOES NOT INDICATE A FAULT AND IS RELATED TO THE HUMIDITY AND/OR TO LOW TEMPERATURES.**

**THE PHENOMENON SHOULD QUICKLY DISAPPEAR WHEN THE LIGHT IS SWITCHED ON.**

**THE PRESENCE OF DROPS OF WATER, ON THE OTHER HAND, COULD INDICATE THAT WATER IS INFILTRATING. CONTACT THE PIAGGIO AFTER-SALES SERVICE NETWORK.**

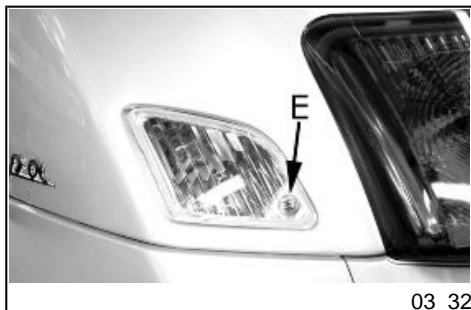

03\_32

### Rear turn indicators (03\_32)

To gain access to the turn indicator bulbs, remove the fastening screws «E».

The bulbs have a bayonet coupling, to remove them press gently and twist anticlockwise about 30°. To refit follow the same steps but in reverse order.

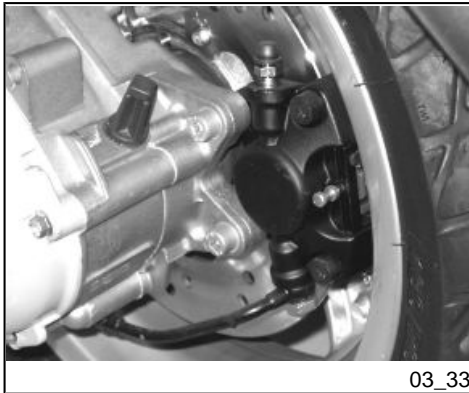

### Rear-view mirrors

Adjust the mirrors by applying slight pressure to the side of the mirror to move it to the desired position.

### Front and rear disc brake (03\_33, 03\_34)

The brake disc and pad wear is automatically compensated, therefore it has no effect on the functioning of the front and rear brakes. For this reason it is not necessary to adjust the brakes. An excessively elastic brake lever stroke may indicate the presence of air in the braking circuit or a failure in the braking system. In this case, mainly due to the importance of brakes to guarantee safe riding conditions, the vehicle should be taken to an **Authorised Service Centre or Dealer**.

#### CAUTION



**THE BRAKING ACTION SHOULD BEGIN AFTER ABOUT 1/3 OF THE BRAKE LEVER STROKE.**

#### CAUTION



**HAVE THE BRAKE PADS CHECKED BY THE DEALER ACCORDING TO THE CHECKS SPECIFIED IN THE SCHEDULED MAINTENANCE TABLE. HOWEVER, IN THE EVENT OF NOISES COMING FROM THE FRONT AND/OR REAR BRAKE SYSTEM DURING OPERATION, IT IS ADVISABLE TO HAVE THE BRAKE SYSTEM CHECKED BY A PIAGGIO DEALER OR AUTHORISED SERVICE CENTRE. AFTER REPLACING THE BRAKE PADS, DO NOT USE THE SCOOTER BEFORE HAVING USED THE BRAKE LEVER SEVERAL TIMES IN ORDER TO ALLOW THE PISTONS TO SETTLE AND THE LEVER STROKE TO BE SET TO THE CORRECT POSITION.**



**CAUTION**

**THE PRESENCE OF SAND, MUD, SNOW MIXED WITH SALT, ETC. ON THE ROAD, CAN DRASTICALLY REDUCE THE DURATION OF THE BRAKE PADS. IN ORDER TO AVOID THIS, WE RECOMMEND WASHING THE VEHICLE FREQUENTLY WHEN RIDING IN THESE ROAD CONDITIONS.**

**Puncture**

The vehicle is equipped with Tubeless tyres (without inner tube). In the event of a puncture, contrary to the situation with a tyre with inner tube, the tyre deflates more slowly, resulting in a greater steering safety. In the event of a puncture, it is admissible to make an emergency repair using an "inflate and repair" spray can. For a final repair, take your vehicle to an **Authorised Service Centre or Dealer**. The replacement of a tyre involves removing the wheel in question. Take your vehicle to an **Authorised Service Centre or Dealer** for these operations.

**CAUTION**

**TO USE THE "INFLATE AND REPAIR" SPRAY PROPERLY FOLLOW THE INSTRUCTIONS ON THE PACKAGING.**

**WARNING**

**THE WHEELS FITTED WITH TYRES SHOULD ALWAYS BE BALANCED. RIDING THE VEHICLE WITH VERY LOW TYRE PRESSURE OR WITH INCORRECTLY BALANCED TYRES CAN LEAD TO DANGEROUS STEERING VIBRATIONS.**



03\_35

### Periods of inactivity (03\_35)

We recommend carrying out the following operations:

1. Clean the scooter thoroughly and then cover it with a canvas;
2. With the engine off and the piston in the bottom dead centre position, remove the spark plug, and pour into its hole 1 to 2 cc of the recommended oil. Operate the starter button 1-2 times for roughly 1 second to turn the engine over slowly, then insert the spark plug again;
3. Ensure that the **fuel tank is at least half full (in order to ensure the total immersion of the fuel pump)**; spread antirust grease on the unpainted metal parts; keep the wheels lifted above the ground by resting the chassis on two wooden wedges;
4. As regards the battery, follow the instructions in the "Battery" section.

### Recommended products

#### **AGIP CITY HI TEC 4T**

*Oil to lubricate flexible transmissions (throttle control)*

Oil for 4-stroke engines

### Cleaning the vehicle

Use a low pressure water jet in order to soften the dirt and mud deposited on painted surfaces. Once softened, mud and dirt must be removed with a soft sponge for body-work soaked with water and shampoo (2-4% of shampoo in water). Then rinse abundantly with water, and dry with a shammy cloth. Any polishing with silicon wax must always be preceded by washing

**WARNING**

IF THE SCOOTER IS USED ON DUSTY ROADS IT IS NECESSARY TO SERVICE THE TRANSMISSION COVER FILTER SPONGE MORE FREQUENTLY.

**CAUTION**

DETERGENTS CAN POLLUTE WATER. THE VEHICLE MUST BE WASHED AT A WASH STATION EQUIPPED WITH A SPECIAL WATER PURIFICATION SYSTEM.

**WARNING**

THE USE OF A HIGH-PRESSURE WATER JET IS STRONGLY DISCOURAGED FOR ANY ENGINE CLEANING OPERATION; HOWEVER, IF NO OTHER MEANS ARE AVAILABLE, IT IS THEN NECESSARY TO:

- ONLY USE FAN SPRAY JETS.
- DO NOT PLACE THE WATER JET NOZZLE CLOSER THAN 60 CM.
- DO NOT USE WATER AT TEMPERATURES OVER 40°C.
- DO NOT USE HIGH-PRESSURE WATER JETS.
- DO NOT STEAM WASH.
- DO NOT DIRECT THE JET STRAIGHT TO THE WIRING AND SLOT DIFFUSER ON THE TRANSMISSION COVER.

**WARNING**

NEVER WASH THE SCOOTER IN DIRECT SUNLIGHT, ESPECIALLY DURING SUMMER WHEN THE BODYWORK IS STILL HOT, AS THE SHAMPOO CAN DAMAGE THE PAINTWORK IF IT DRIES BEFORE BEING RINSED OFF. NEVER USE

**CLOTHS SOAKED IN PETROL, DIESEL OIL OR KEROSENE FOR CLEANING THE PAINTED OR PLASTIC SURFACES SO AS NOT TO DAMAGE THE LUSTRE FINISH OR ALTER THE MECHANICAL PROPERTIES.**

### **STARTING FAILURE**

Emergency switch in «OFF»	Set the switch back to « <b>ON</b> »
Fuse blown	Replace the blown fuse and have the vehicle checked by an <b>Authorised Service Centre.</b>

### **IGNITION PROBLEM**

Faulty spark plug	Contact an <b>Authorised Service Centre.</b>
Faulty ignition / injection control unit.	Contact an <b>Authorised Service Centre.</b>
Faulty coil. Due to the presence of high voltage, this check should only be carried out by an expert.	Contact an <b>Authorised Service Centre.</b>



### **LACK OF COMPRESSION**

Loose spark plug.	Screw in the spark plug tightly
Cylinder head loose, piston gas rings worn.	Contact an <b>Authorised Service Centre.</b>
Valve stuck	Contact an <b>Authorised Service Centre.</b>

### **HIGH CONSUMPTION AND LOW PERFORMANCE**

Air filter blocked or dirty.	Clean with water and shampoo and impregnate with petrol and specific oil (section «Removing the air filter»)
------------------------------	--

### **INSUFFICIENT BRAKING**

Greasy disc. Worn pads. Faulty braking system. Presence of air in the front and rear brake circuit.	Contact an <b>Authorised Service Centre.</b>
---	--

### **INEFFICIENT SUSPENSIONS**

Shock absorber fault, oil leak, end buffer damaged; shock absorber preloading incorrectly set	Contact an <b>Authorised Service Centre</b> .
---	---

### **IRREGULAR AUTOMATIC TRANSMISSION**

Variator rollers and/or driving belt damaged	Contact an <b>Authorised Service Centre</b> .
--	---

# Vespa GTS Super 300

The Vespa logo is rendered in a stylized, black, italicized font with a registered trademark symbol (®) at the end.

**Chap. 04**  
**Technical data**

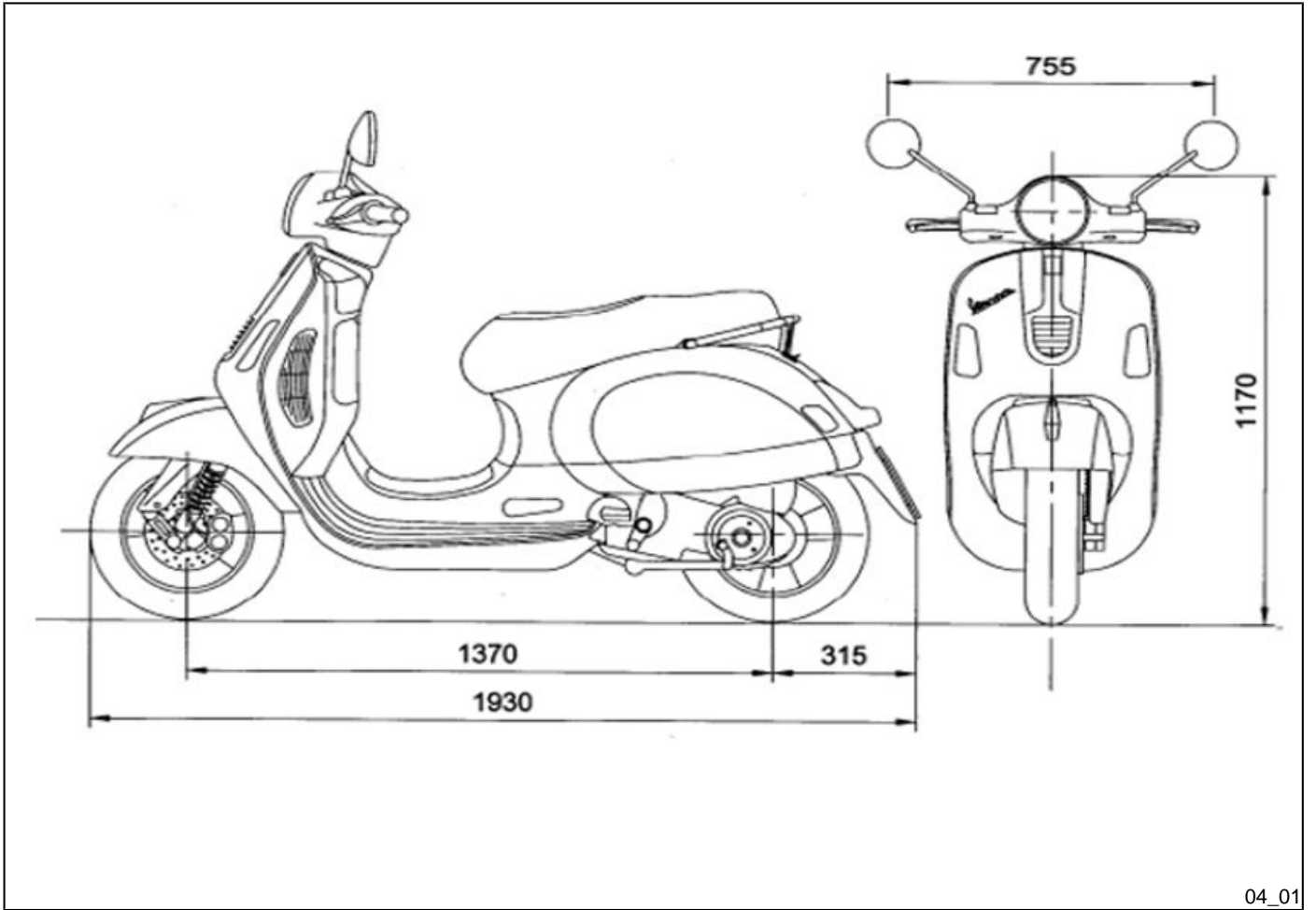

04\_01

**ENGINE TECHNICAL DATA**

Type	Single-cylinder, 4-stroke
Cubic capacity	278 cm <sup>3</sup>
Bore x Stroke	75x63 mm
Compression ratio	11 ± 0.5 : 1
Engine idle speed	1,700 ± 100 rpm
Timing system	4 valves, single overhead camshaft, chain-driven.
Valve clearance	Inlet: 0.10 mm Outlet: 0.15 mm
Max. Power	16.2 kW at 7,500 rpm
MAX. torque	22.3 at 5,000 rpm
Transmission	Automatic expandable pulley variator with torque server, V-belt, self-ventilating dry automatic centrifugal clutch and transmission housing with forced-circulation air cooling.
Final reduction	Gear reduction unit in oil bath.
Lubrication	Engine lubrication with lobe pump (inside crankcase) controlled by a chain with double filter: mesh and paper.
Cooling	Forced-circulation coolant system.
Start-up	Electric

Ignition	Electronic inductive discharge ignition, high efficiency, with separate HV coil.
Ignition advance	$\alpha/N$ three-dimensional map managed by control unit
Spark plug	NGK CR8EKB
Alternative spark plug	-
Fuel supply	Electronic injection with $\varnothing$ 32-mm throttle body and electric fuel pump.
Fuel	Unleaded petrol (95 RON)
Exhaust muffler	Absorption-type exhaust muffler with a 3-way catalytic converter and lambda probe.
Emission regulations	EURO 3

### **VEHICLE TECHNICAL DATA**

Chassis	Stamped plate supporting body.
Front suspension	Single arm suspension (cantilever wheel) fitted with a dual-chamber hydraulic shock absorber with coaxial spring.
Rear suspension	Two double-acting shock absorbers, adjustable to four positions at preloading.
Front brake	$\varnothing$ 220 mm disc with calliper with counteracting pistons.

Rear brake	disc brake, diameter 220 mm, with hydraulic servo operated from the handlebar with the left-hand lever.
Wheel rim type	Light alloy rims.
Front rim	12" x 3.00
Rear rim	12" x 3.00
Front tyre	120/70 - 12" 51P Tubeless
Rear tyre	Tubeless 130/70 12" 62P
Front tyre pressure (with passenger)	1.8 bar (-)
Rear tyre pressure (with passenger)	2.2 bar (-)
Kerb weight	151 ± 5 kg
Maximum weight allowed	340 kg
Battery	12V-12Ah

### **CAPACITY**

Engine oil	1.3 l
Transmission oil	250 cm <sup>3</sup>
Cooling system fluid	~ 2 l
Fuel tank capacity	~ 9.2 litres

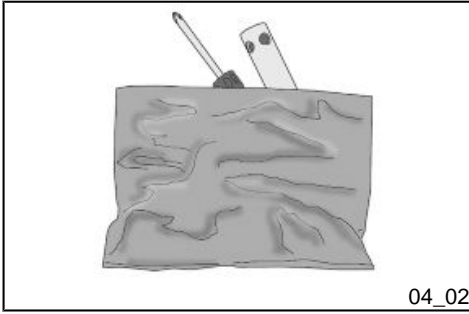

### **Kit equipment (04\_02)**

One box-spanner for spark plugs; one twin screwdriver; one special spanner for adjusting the rear shock absorber. The tools are arranged in the front case.



# Vespa GTS Super 300

The Vespa logo is a stylized, italicized script font in black, positioned below the main title.

**Chap. 05**  
**Spare parts and**  
**accessories**

## Warnings

### WARNING



TO PREVENT ACCIDENTS AND TO GUARANTEE PROPER STABILITY, PERFORMANCE AND SAFETY, RIDE THE VEHICLE VERY CAREFULLY WHEN IT IS FITTED WITH ACCESSORIES OR WITH UNUSUAL LOADS.

### WARNING



IT IS ALSO RECOMMENDED THAT "ORIGINAL PIAGGIO SPARE PARTS" BE USED, AS THESE ARE THE ONLY ONES OFFERING YOU THE SAME QUALITY GUARANTEE AS THOSE INITIALLY FITTED ON THE SCOOTER. THE USE OF NON-ORIGINAL SPARE PARTS RENDERS THE WARRANTY VOID.

### WARNING



PIAGGIO MARKETS ITS OWN LINE OF ACCESSORIES THAT ARE RECOGNISED AND GUARANTEED FOR USE. IT IS THEREFORE ESSENTIAL, IN ORDER TO CHOOSE AND MOUNT THE ACCESSORIES CORRECTLY, TO CONTACT AN AUTHORISED DEALER OR SERVICE CENTRE. THE USE OF NON-ORIGINAL ACCESSORIES MAY AFFECT THE STABILITY AND OPERATION OF YOUR VEHICLE AND REDUCE SAFETY LEVELS WITH POTENTIAL RISKS FOR THE RIDER.

**WARNING**

**NEVER RIDE THE SCOOTER EQUIPPED WITH ACCESSORIES (TOP BOX AND/OR WINDSHIELD) AT A SPEED HIGHER THAN 100 km/h.**

**THE SCOOTER CAN BE RIDDEN AT A HIGHER SPEED WITHOUT THE ACCESSORIES MENTIONED BEFORE WITHIN THE LIMITS ESTABLISHED BY LAW.**

**IF THERE SHOULD BE NON-PIAGGIO ACCESSORIES INSTALLED, OR AN ABNORMAL LOAD, OR IF THE SCOOTER IS NOT IN A GENERALLY GOOD CONDITION, OR WHENEVER WEATHER CONDITIONS DEMAND IT, SPEED SHOULD BE REDUCED FURTHER.**

**WARNING**

**BE EXTREMELY CAREFUL WHEN INSTALLING AND REMOVING THE MECHANICAL ANTI-THEFT DEVICE ON THE VEHICLE ( U-SHAPED PADLOCK, DISK BLOCK, ETC.).**

**MAINLY NEAR THE BRAKE PIPES, TRANSMISSIONS AND/OR ELECTRIC CABLES, AN INCORRECT INSTALLATION OR REMOVAL OF THE ANTI-THEFT DEVICE AS WELL AS LEAVING IT ON BEFORE STARTING THE VEHICLE CAN SERIOUSLY DAMAGE ITS COMPONENTS, COMPROMISE THE CORRECT FUNCTIONING OF THE VEHICLE AND USERS' SAFETY.**



# Vespa GTS Super 300

The Vespa logo is rendered in a stylized, italicized, black font with a registered trademark symbol (®) at the end.

**Chap. 06**  
**Programmed**  
**maintenance**



### Scheduled maintenance table (06\_01)

Adequate maintenance is fundamental to ensuring long-lasting, optimum operation and performance of your vehicle.

To this end, a series of checks and maintenance operations (at the owner's expense) have been suggested, which are included in the summary table on the following page. Any minor faults should be reported without delay to an **Authorised Service Centre or Dealer** without waiting until the next scheduled service to solve it.

All scheduled maintenance services must be carried out at the specified intervals, even if the stated mileage has not yet been reached. Punctual scooter servicing is essential to ensure your warranty remains valid. For any further information concerning Warranty procedures and "Scheduled Maintenance", please refer to the "Warranty Booklet".

### SCHEDULED MAINTENANCE TABLE

km x 1,000	1	5	10	15	20	25	30	35	40	45	50	55	60
Safety locks	I		I				I				I		I
Spark plug			R		R		R		R		R		R
Driving belt				R			R			R			R
Throttle control	A		A		A		A		A		A		A
Air filter			C		C		C		C		C		C
Belt compartment air filter			I		I		I		I		I		I
Oil filter	R		R		R		R		R		R		R
Valve clearance					A				A				A
Electrical system and battery	I		I		I		I		I		I		I
Brake fluid *	I		I		I		I		I		I		I

km x 1,000	1	5	10	15	20	25	30	35	40	45	50	55	60
Coolant *	I		I		I		I		I		I		I
Engine oil	R	I	R	I	R	I	R	I	R	I	R	I	R
Hub oil	R		I		R		I		R		I		R
Brake pads	I	I	I	I	I	I	I	I	I	I	I	I	I
Sliding blocks / variable speed rollers			R		R		R		R		R		R
Tyre pressure and wear	I		I		I		I		I		I		I
Vehicle road test	I		I		I		I		I		I		I
Suspensions			I		I		I		I		I		I
Steering	A		A		A		A		A		A		A

*I: CHECK AND CLEAN, ADJUST, LUBRICATE OR REPLACE IF NECESSARY.*

*C: CLEAN, R: REPLACE, A: ADJUST, L: LUBRICATE*

*\* Replace every 2 years*

### RECOMMENDED PRODUCTS TABLE

Product	Description	Specifications
AGIP ROTRA 80W-90	Rear hub oil	SAE 80W/90 Oil that exceeds the requirements of API GL3 specifications
AGIP CITY HI TEC 4T	Oil to lubricate flexible transmissions (throttle control)	Oil for 4-stroke engines
AGIP FILTER OIL	Oil for air filter sponge	Mineral oil with specific additives for increased adhesiveness

<b>Product</b>	<b>Description</b>	<b>Specifications</b>
AGIP GP 330	Grease for brake levers, throttle	White calcium complex soap-based spray grease with NLGI 2; ISO-L-XBCIB2
AGIP CITY HI TEC 4T	Engine oil	SAE 5W-40, API SL, ACEA A3, JASO MA Synthetic oil
AGIP BRAKE 4	Brake fluid	FMVSS DOT 4 Synthetic fluid
AGIP PERMANENT SPEZIAL	coolant	Monoethylene glycol-based antifreeze fluid, CUNA NC 956-16



## TABLE OF CONTENTS

### **A**

Air filter: 44

### **B**

Battery: 49, 50

Brake: 47, 60

### **C**

Clock: 11

### **D**

Disc brake: 60

### **E**

Engine oil: 38, 39

Engine stop: 15

### **F**

Fuel: 19

Fuses: 51

### **H**

Headlight: 57

Horn: 13

Hub oil: 40

### **I**

Identification: 21

Immobilizer: 15, 18

Instrument panel: 10

### **K**

Key switch: 12

Keys: 15

### **L**

Light switch: 14

### **M**

Maintenance: 37, 77, 78

Mirrors: 60

### **S**

Saddle: 20

Scheduled maintenance: 78

Shock absorbers: 29

Spark plug: 43

Stand: 33

Start-up: 14

### **T**

Tank: 19

Technical Data: 67

Top box: 22

Transmission: 33

Turn indicators: 59

Tyre pressure: 28

Tyres: 42



The descriptions and illustrations given in this publication are not binding. While the basic specifications as described and illustrated in this manual remain unchanged, PIAGGIO-GILERA reserves the right, at any time and without being required to update this publication beforehand, to make any changes to components, parts or accessories, which it considers necessary to improve the product or which are required for manufacturing or construction reasons.

Not all versions/models shown in this publication are available in all countries. The availability of single versions should be checked at the official Piaggio sales network.

"© Copyright 2007 - PIAGGIO & C. S.p.A. Pontedera. All rights reserved. Reproduction of this publication in whole or in part is prohibited."

PIAGGIO & C. S.p.A. - After-Sales

V.le Rinaldo Piaggio, 23 - 56025 PONTEDERA (PI)