

Manual de Reparación

(en inglés)



Yamaha SR250

CHAPTER 1. GENERAL INFORMATION

MOTORCYCLE IDENTIFICATION.....	1-1
EXTERNAL VIEW.....	1-2
SPECIAL TOOLS.....	1-2

CHAPTER 1. GENERAL INFORMATION

MOTORCYCLE IDENTIFICATION

The frame serial number is located on the right-hand side of the head pipe. The first three digits identify the model. This is followed by a dash. The remaining digits identify the production number of the unit.

The engine serial number is located on a raised boss on the upper rear, right-hand side of the engine. Engine identification follows the same code as frame identification.

Starting Serial Number

SR250G	3Y6-000101
--------	------------

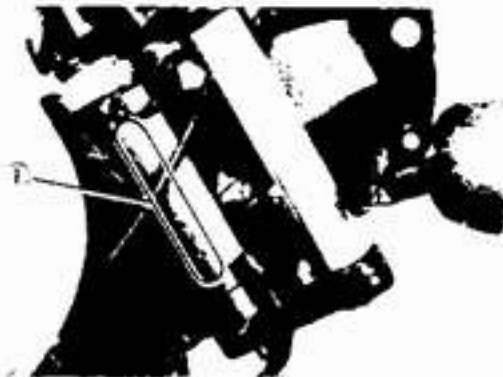

1 Frame serial number



1 Engine serial number

EXTERNAL VIEW

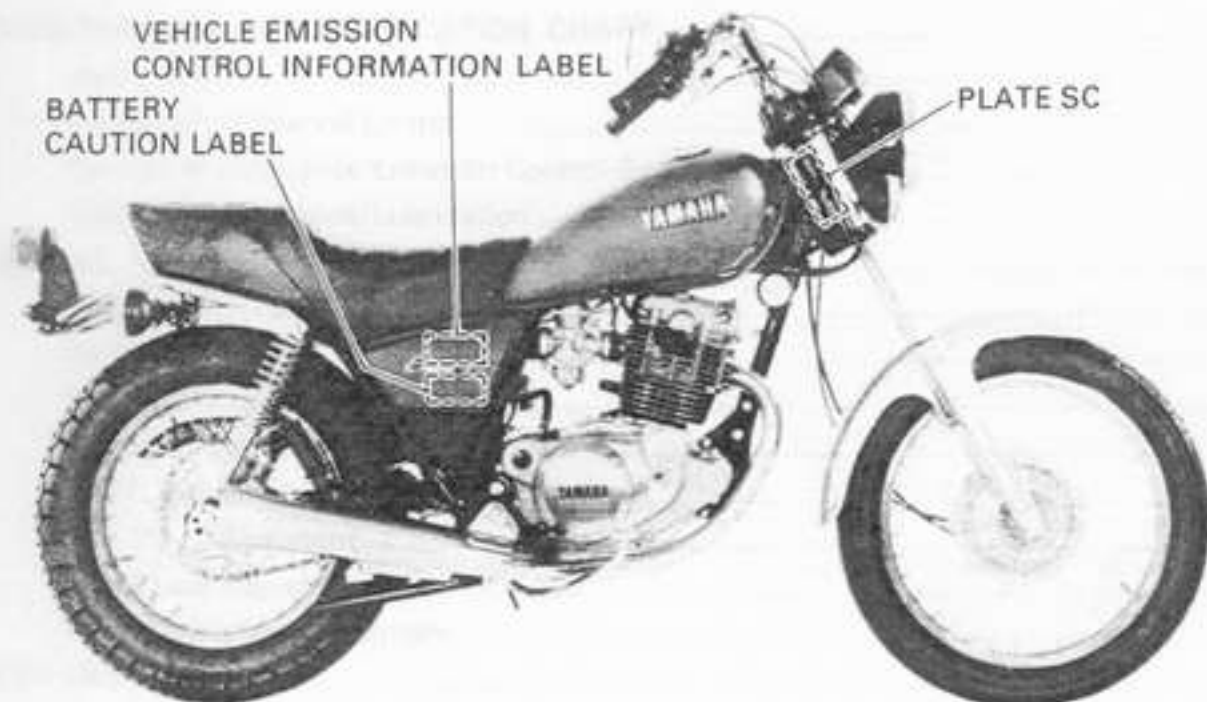

SPECIAL TOOLS

1. Pocket tester (P/No. 90890-03112-00)
2. Electro tester (P/No. 90890-03021-00)
3. Dial gauge (P/No. 90890-03097-00)
4. Rotar holding tool (P/No. 90890-01235-00)
5. Flywheel puller (P/No. 90890-01189-00)
6. Clutch holding tool (P/No. TLM-90910-42-00)
7. Crankcase separating tool (P/No. 90890-01135-00)
8. Tappet adjusting tool (P/No. 90890-01311-00)
9. Front fork cylinder complete holder (P/No. 90890-01294-00)
10. T type handle (P/No. 90890-01301-00)
11. Ring nut wrench (P/No. 90890-01266-00)
12. Spoke wrench (P/No. 90890-05087-00)
13. Valve seat cutter set (P/No. TLM-90910-43-20)
14. Valve guide installer (P/No. 90890-04017-00)
15. Valve guide remover (P/No. 90890-01225-00)
16. Valve spring compressor (P/No. 90890-01253-00)
17. Hand reamer (P/No. 90890-01227-00)
18. Drive chain cutter (P/No. 90890-01286-00)
19. Fuel level gauge (P/No. 90890-01312-00)
20. rocker arm shaft puller bolt (P/No. 90890-01083-00)
21. Rocker arm shaft puller weight (P/No. 90890-01084-00)

CHAPTER 2. PERIODIC INSPECTIONS AND ADJUSTMENTS

MAINTENANCE AND LUBRICATION CHART.....	2-1
Introduction.....	2-1
Maintenance Interval Charts.....	2-1
Periodic Maintenance Emission Control System.....	2-1
General Maintenance/Lubrication.....	2-2
ENGINE.....	2-3
Carburetor.....	2-3
Air Filter.....	2-3
Engine Oil.....	2-4
Engine Oil and Oil Filter Replacement.....	2-5
Clutch Adjustment.....	2-6
Free Play Adjustment.....	2-6
Cam Chain Adjustment.....	2-7
Valve Clearance Adjustment.....	2-7
CHASSIS.....	2-8
Fuel Petcock.....	2-8
Front Brake and Wheel.....	2-8
Front Brake Adjustment.....	2-8
Spoke Adjustment and Torque.....	2-9
Front Axle.....	2-9
Tire Pressure.....	2-9
Rear Brake and Wheel.....	2-9
Rear Brake Adjustment.....	2-9
Brake Lining Inspection.....	2-9
Spoke Adjustment and Tension.....	2-10
Rear Axle.....	2-10
Tire Pressure.....	2-10
Drive Chain Tension Check.....	2-10
Drive Chain Tension Adjustment.....	2-10
Drive Chain Lubrication.....	2-11
Front Fork Oil Change.....	2-11
Suspension, Steering and Swing Arm.....	2-12
Rear Shock Absorber.....	2-13
Cable Inspection and Lubrication.....	2-13
Throttle Cables and Grip Lubrication.....	2-13
Lubrication of Levers, Pedals, etc.....	2-13
ELECTRICAL.....	2-13
Ignition Timing.....	2-13
Spark Plug.....	2-14

CHAPTER 2. PERIODIC INSPECTIONS AND ADJUSTMENTS

MAINTENANCE AND LUBRICATION CHART

Introduction

This chapter includes all information necessary to perform recommended inspection and adjustments. These preventative maintenance procedures, if followed, will insure more reliable vehicle operation and a longer service life. The need for costly overhaul work will be greatly reduced. This information applies not only to vehicles already in service, but also to new vehicles that are being prepared for sale. Any service technician performing preparation work should be familiar with this entire chapter.

Maintenance Intervals Charts

Proper periodic maintenance is important. Especially important are the maintenance services related to emissions control. These controls not only function to ensure cleaner air but are also vital to proper engine operation and maximum performance. In the following tables of periodic maintenance, the services related to emissions control are grouped separately.

Periodic Maintenance Emission Control System

No.	Item	Remarks	Initial break-in		Thereafter every	
			1,000 km (600 mi) or 1 month	4,000 km (2,500 mi) or 7 months	3,000 km (2,000 mi) or 6 months	6,000 km (4,000 mi) or 12 months
1*	Cam chain	Check and adjust chain tension	○	○	○	
2*	Valve clearance	Check and adjust valve clearance when engine is cold.	○	○	○	
3	Spark plug	Check condition. Adjust gap/clean. Replace after initial 7,000 km (4,500 mi).		○	○	Replace
4*	Crankcase ventilation system	Check ventilation hose for cracks or damage. Replace if necessary.		○		○
5*	Fuel line	Check fuel hose for cracks or damage. Replace if necessary.		○		○
6*	Exhaust system	Check for leakage. Retighten as necessary. Replace gasket if necessary.		○	○	
7*	Idle speed	Check and adjust engine idle speed. Adjust cable free play if necessary.		○	○	

* It is recommended that these items be serviced by a Yamaha dealer or other qualified mechanic.

General Maintenance/Lubrication

No.	Item	Remarks	Type	Initial break-in		Thereafter every		
				1,000 km (600 mi) or 1 month	4,000 km (2,500 mi) or 7 months	3,000 km (2,000 mi) or 6 months	6,000 km (4,000 mi) or 12 months	15,000 km (9,500 mi) or 24 months
1	Engine oil	Warm-up engine before draining	Yamalube 4-cycle oil or SAE 20W/40 type "SE" motor oil	○	○		○	
2	Oil filter/ Oil strainer	Replace filter element and clean oil strainer	—	○	○		○	
3*	Air filter	Wet-type filter must be washed and damped with oil	Yamalube 2-cycle oil or equivalent	○	○	○		
4*	Brake system	Adjust free play. Replace shoes if necessary.	—	○	○	○		
5*	Clutch	Adjust free play	—	○	○	○		
6	Drive chain	Apply chain lube thoroughly.	Yamaha chain and cable lube or SAE 10W/30 motor oil	Check chain tension and lube every 500 km (300 mi)				
7	Control and meter cable	Apply chain lube thoroughly.	Yamaha chain and cable lube or SAE 10W/30 motor oil	○	○	○		
8*	Rear arm pivot shaft	Apply grease lightly	Lithium soap base grease					○
9	Brake pedal shaft	Apply chain lube lightly	Yamaha chain and cable lube or SAE 10W/30 motor oil		○	○		
10	Brake/clutch lever pivot shafts	Apply chain lube lightly	Yamaha chain and cable lube or SAE 10W/30 motor oil		○	○		
11	Center stand pivot	Apply chain lube lightly	Yamaha chain and cable lube or SAE 10W/30 motor oil		○	○		
12*	Front fork oil	Drain completely. Refill to specification.	Yamaha fork oil 10Wt or equivalent					○
13*	Steering ball bearing and races	Check bearings assembly for looseness. Moderately repack every 15,000 km (9,500 mi)	Medium weight wheel bearing grease		○	○		Repack
14*	Wheel bearings	Check bearings for smooth rotation. Replace if necessary.	—		○	○		
15	Battery	Check specific gravity. Check breather pipe for proper operation.	—		○	○		

* It is recommended that these items be serviced by a Yamaha dealer or other qualified mechanic.

NOTE:

The air filter should be cleaned more often than specified intervals if the motorcycle is operated in extremely dusty area.

ENGINE

Carburetor

1. Idle speed setting procedure

Start the engine and warm it up for a few minutes. Set the engine idle speed to specified r/min. by turning the throttle stop screw in to increase the engine speed and back off the screw to decrease the engine speed.

Use a tachometer for checking and adjusting the engine speed.

Idle speed: 1,200 r/min



1 Throttle stop screw

2. Idle mixture

The idle mixture is set at the factory by the use of special equipment. Not attempt should be made by the dealer to change this adjustment.

3. Throttle cable adjustment.

NOTE:

Idle speed should be set before making this adjustment.

The throttle grip should have a play of 2 ~ 5 mm (0.08 ~ 0.2 in) in the turning direction at the grip flange. If the play is not this range, take the following step for adjustment:

Loosen the adjuster lock nut on the throttle cable, and turn the adjuster in or out so the play is correct. After the adjustment, tighten the lock nut.

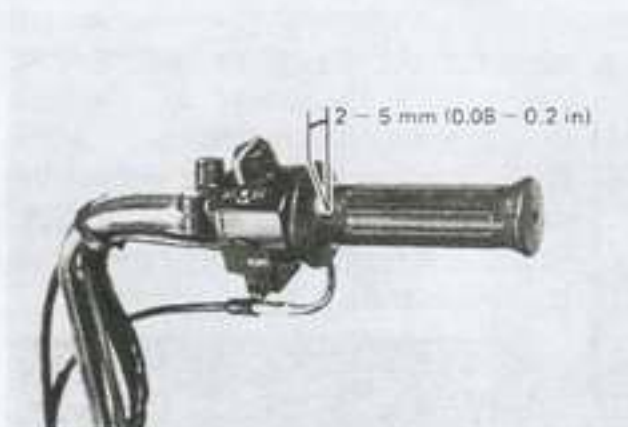

Air Filter

The air filter protects the engine from dirt which can enter with the intake air and cause rapid engine wear. This dirt is filtered from the air by the air filter element. This model uses a cartridge type air filter element which consists of foam rubber moistened with oil. When this filter element becomes dirty it should be cleaned.

1. Remove the seat and the side cover (left).
2. Remove the air filter element from its case, remove element from guide and clean with solvent. After cleaning, remove the remaining solvent by squeezing the element.

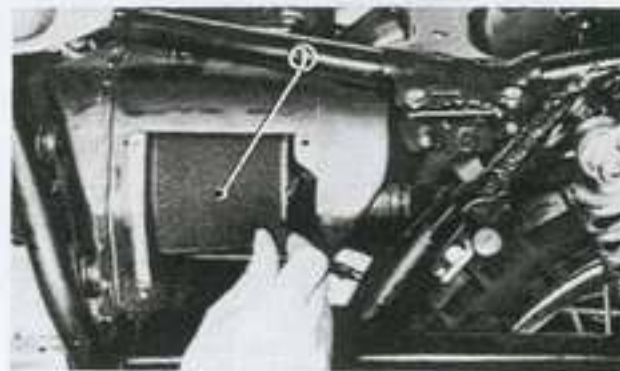
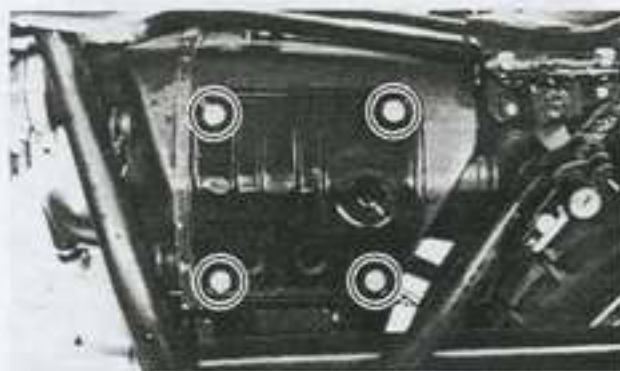

1 Air filter element

3. Then apply Yamalube 2-cycle oil or equivalent to the entire surface and squeeze out the excess oil. Element should be wet but not dripping.
4. When installing the air filter element in its case, be sure its sealing surface matches perfectly the sealing surface of the case so there is not air leakage.



5. The air filter element should be cleaned at the specified intervals. It should be cleaned more often if the motorcycle is operated in dusty or wet areas.



CAUTION:

The engine should never be run without the air cleaner element installed; excessive piston and/or cylinder wear may result.

Engine Oil

1. Oil level measurement
 - a. Place the motorcycle on a level place and hold it in an upright position. Warm up the engine for several minutes.

NOTE:

Be sure the motorcycle is positioned straight up when checking the oil level; a slight tilt toward the side can produce false readings.

- b. With the engine stopped, check the oil level through the level window located at the lower part of the right side crankcase cover.

NOTE:

Wait a few minutes until the oil level settles before checking.

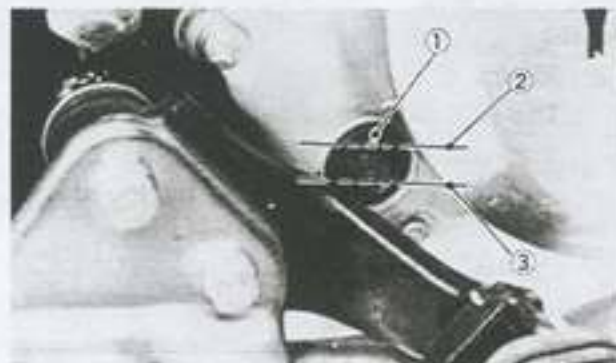

- | | |
|-----------------|-----------------|
| 1. Level window | 3. Minimum mark |
| 2. Maximum mark | |

2. Oil capacity

After engine overhaul:
1.6 lit (1.7 US qt)
After oil filter replacement:
1.3 lit (1.4 US qt)

Engine Oil and Oil Filter Replacement

CAUTION:

After replacement of engine oil, be sure to check the oil pressure in the following procedure.

1. Remove the air bleed screw from oil filter cover, and loosen the check bolt in the cylinder head.
2. Start the engine and keep it idle running till oil flows out of the bleed hole, and at the check bolt (see the following photo).

The check bolt has a slit for checking oil.

If no oil comes out even after a lapse of over one minute, cut the engine immediately for fear of seizure.

Restart the engine after solving the problem(s) and recheck the oil pressure.



1. Oil filter replacement

NOTE:

When replacing the engine oil after the break-in period, clean the oil strainer at the bottom of the engine.

- a. Start the engine. After a few minutes of warm-up stop the engine.
- b. Place an oil pan under the engine.

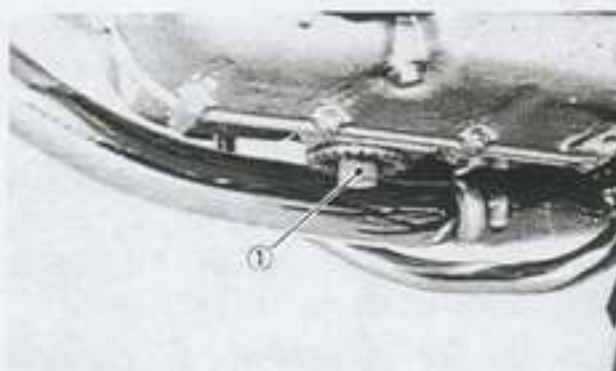

1. Drain plug

- c. Remove the oil filler cap, drain plug and air bleed screw attached to the oil filter cover, and drain the engine oil.

NOTE:

The oil filter cover is secured by three screws. The lower one should be loosened until the threaded portion comes out completely.



1. Air bleed screw 2. Filter cover screw

CAUTION:

When removing the drain plug, the compression spring, oil strainer and O-ring will fall off. Take care not to lose these parts.



- d. Remove the oil filter cover, and replace the filter element.

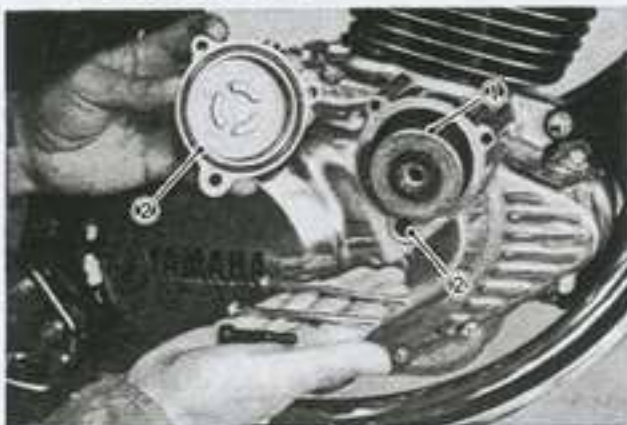

1. Filter element 2. "O" ring

- e. Install the drain plug, air bleed screw, oil filter and oil filter cover.

CAUTION:

Before reinstalling the drain plug, do not forget to fit the O-ring, compression spring and oil strainer.

Drain plug torque:
3.2 m-kG (23.0 ft-lb)

- f. Add 1.3 liters of engine oil. Install the oil filler cap and tighten. Use Yamalube 4-cycle oil or SAE 20W/40 type "SE" oil.



- g. Start the engine and allow a few minutes of warm up. While warming up, check for oil leakage. If oil leaks, stop the engine immediately, and check for the cause.
- h. After warm up, stop the engine and check the oil level. (Refer to page 2-4, "Engine Oil".)
2. Regular oil replacement (without replacing filter)

- a. Start the engine and stop after a few minutes of warm-up.
- b. Place an oil receiver under the engine.
- c. Remove the oil filler cap, drain plug and air bleed screw attached to the oil filter cover.

NOTE:

The oil filter cover is secured by three screws. The lower one should be removed so that the filter cavity will drain.

- d. Check each O-ring. If damaged replace.
- e. Install the drain bolt and the bleed screw.
- f. Add 1.3 liters of engine oil. Install the oil filler cap and tighten.
- g. Start the engine and allow a few minutes of warm-up.
While warming up, check for oil leakage. If oil leaks, stop the engine immediately, and check for the cause.
- h. Stop the engine and check the oil level. (Refer to page 2-4, "Engine Oil".)

Clutch Adjustment

This model has two clutch cable length adjusters and a clutch mechanism adjuster. Cable length adjusters are used to take up slack from cable stretch and to provide sufficient free play for proper clutch operation under various operating conditions. The clutch mechanism adjuster is used to provide the correct amount of clutch "throw" for proper disengagement (see page 3-24). Normally, once the mechanism is properly adjusted, the only adjustment required is maintenance of free play at the clutch handlebar lever.

Free Play Adjustment

Loosen the handlebar lever adjuster lock nut. Next, turn the length adjuster either in or out until proper lever free play is achieved.

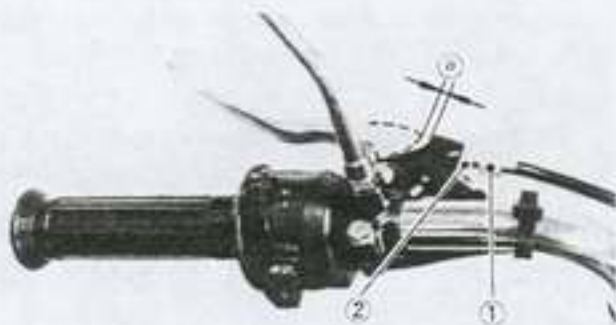

1. Adjuster 2. Lock nut $a = 3 \sim 5 \text{ mm}$
(0.12 ~ 0.20 in)

Cam Chain Adjustment

1. Remove the left crankcase cover.
2. Rotate crank shaft in a counter-clockwise direction (viewed from the left side of the engine) to place all slack in the area of the chain tensioner. Align the "T" mark on the flywheel with the timing mark on the crankcase at the compression stroke.



3. Remove the adjuster cap.
4. Loosen the adjuster lock nut.
5. Turn the adjuster in until the push rod (inside the adjuster) is flush with the end of the adjuster.

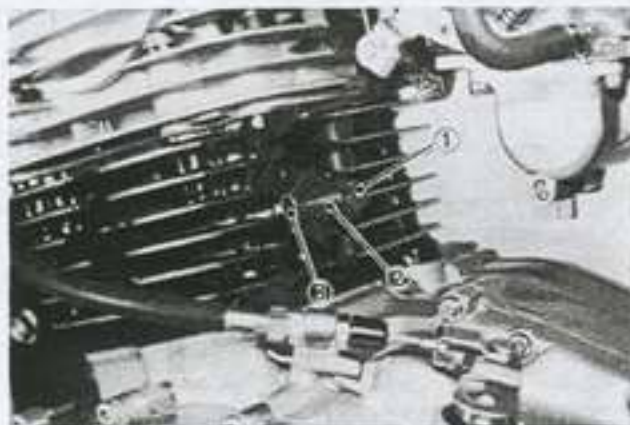

1. Push rod 2. Adjuster 3. Lock nut

NOTE:

Start the engine. While keeping it idling, check the movement of the push rod. If it moves slightly, the adjustment is correct. If it does not move at all, the adjuster is too tight. Loosen the adjuster so the push rod moves slightly.

6. Tighten the adjuster lock nut.
7. Install the adjuster cap and the left crankcase cover.

Adjuster lock nut tightening torque:
3.0 m·kg (22 ft·lb)

Adjuster cap tightening torque:
0.5 m·kg (3.6 ft·lb)

Valve Clearance Adjustment

1. Remove the seat.
2. Turn the fuel petcock to "ON" and disconnect the fuel pipe.
3. Remove the bolt securing the fuel tank to the frame and remove the fuel tank.
4. Remove intake and exhaust tappet covers and left crankcase cover.



1. Intake tappet cover 2. Exhaust tappet cover

5. Align the "T" mark on the flywheel with the timing mark on the crankcase. This places the piston at the top dead center and the valve clearance should be checked and adjusted at T.D.C. on the compression stroke by observing when the valve adjusters have clearance.
6. Use a feeler gauge to determine the clearance.

Intake valve (Cold):

0.05 ~ 0.10 mm (0.002 ~ 0.004 in)

Exhaust valve (Cold):

0.12 ~ 0.17 mm (0.005 ~ 0.007 in)

7. Loosen the valve adjuster lock nut. Turn the adjuster in or out to obtain the correct clearance. Hold the adjuster to prevent it from moving and thoroughly tighten the lock nut.
Recheck the clearance after tightening.

NOTE:

Valve clearance check and adjustment should be done when the engine is cold.

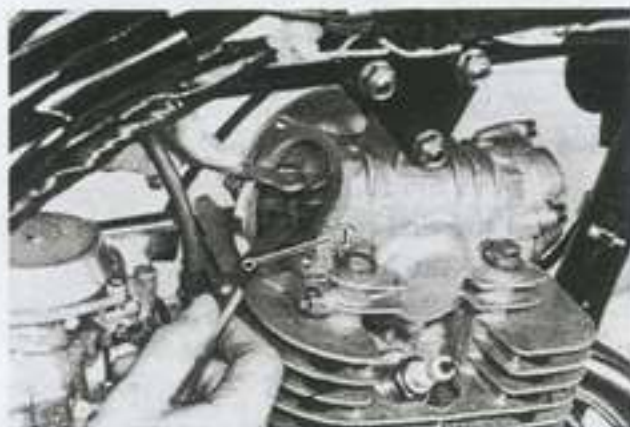

1. Feeler gauge

8. Install the intake and exhaust tappet covers and left crankcase cover.
9. Install the fuel tank and seat.
10. Connect the fuel pipe.

CHASSIS

Fuel Petcock

1. First, drain out the fuel tank and remove the fuel pipe.
2. Loosen the fuel cock securing bolts and remove the fuel cock assembly from fuel tank.
3. Clean the attached filter with solvent. Examine the filter and replace if damaged.
4. Inspect the gasket, replace if damaged and install the outlet fitting.

Front Brake and Wheel

Front Brake Adjustment

The front brake should be adjusted to suit rider preference within a 5 ~ 8 mm (0.2 ~ 0.3 in) free play at the lever pivot side. Adjustment is accomplished at one of two places; either the handlebar lever holder or the front brake hub.

1. Loosen the lock nut.
2. Turn the cable length adjuster in or out until adjustment is suitable.
3. Tighten the lock nut.
4. If proper adjustment can not be obtained at the handlebar lever holder, make a brake hub adjustment.

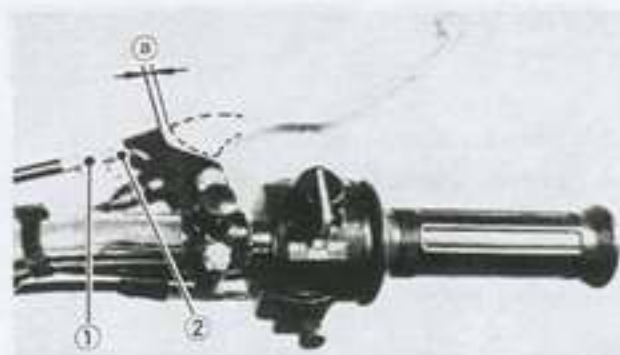

1. Adjuster a. 5 ~ 8 mm (0.2 ~ 0.3 in)
2. Lock nut

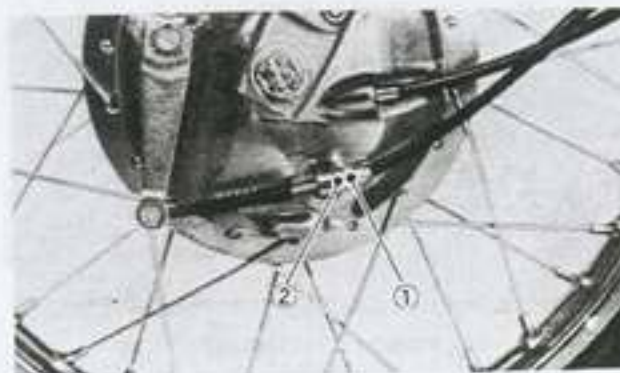

1. Adjuster 2. Lock nut

Spoke Adjustment and Torque

- a. Raise the wheel off the ground.
Spin wheel.
Check rim run out as shown in illustration.

Rim runout limits:

Vertical: 2.0 mm (0.08 in)

Lateral: 2.0 mm (0.08 in)

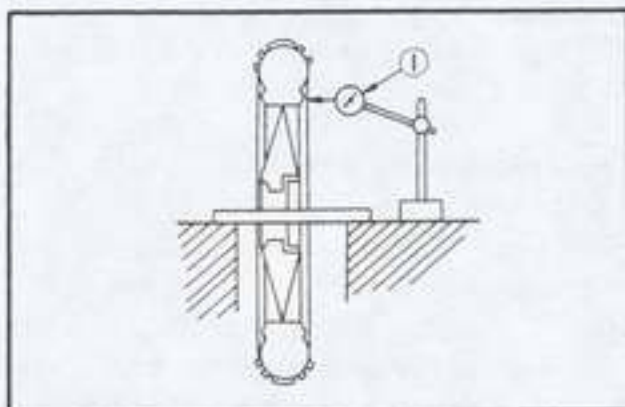

1 Dial gauge

- b. Check each spoke for tightness.

Spoke torque:

Front wheel: 0.3 m·kg (2.2 ft·lb)

Rear wheel: 0.3 m·kg (2.2 ft·lb)

Front Axle

Check axle nut.

Front axle nut torque:

10.7 m·kg (77.5 ft·lb)

Tire Pressure

See page 5-3 "Installation".

Rear Brake and Wheel

Rear Brake Adjustment

1. Pedal height
 - a. Loosen the adjuster lock nut (for pedal height).
 - b. By turning the adjuster bolt clockwise or counterclockwise, adjust the brake pedal position so that its top end is approx. 15 mm (0.6 in) below the footrest top end.
 - c. Secure the adjuster lock nut.

WARNING:

After adjusting the pedal height, the brake pedal free play should be adjusted.

2. Free play

Turn the adjuster on the brake rod clockwise or counterclockwise to provide the brake pedal end with a free play of 20 ~ 30 mm (0.8 ~ 1.2 in).



- 1 Adjuster bolt (For pedal height)
- 2 Lock nut
 - a 15 mm (0.6 in)
 - b 20 ~ 30 mm (0.8 ~ 1.2 in)



1 Adjuster

Brake Lining Inspection

To check, see the wear indicator position while depressing the brake pedal or pulling the brake lever. If the indicator reaches to the wear limit line to replace the shoes.

Front

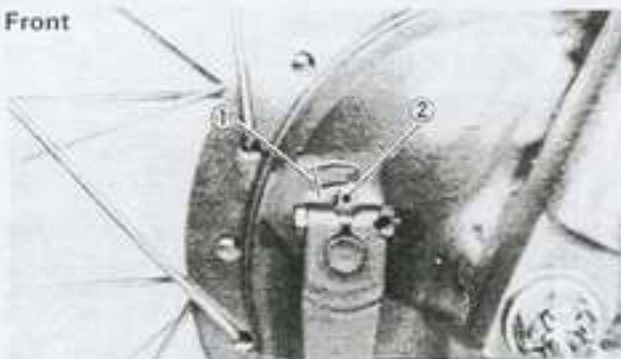

1. Wear limit 2. Wear indicator

Rear

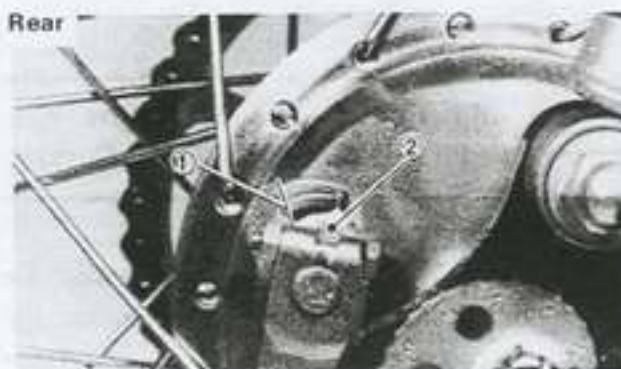

1. Wear limit 2. Wear indicator

Spoke Adjustment and Tension

Adjust rear wheel spoke tension per front wheel instructions.

Rear Axle

Check axle nut.

Rear axle nut torque:
10.7 m·kg (77.5 ft·lb)

Tire Pressure

See page 5-3 "Installation".

Drive Chain Tension Check

NOTE:

Before checking and/or adjusting, rotate the rear wheel through several revolutions and check tension at several points to find the tightest point. Check and/or adjust the chain tension with the rear wheel in this "tightest" position.

Inspect the drive chain with the center stand put. Check the tension at the position shown in the illustration. The normal vertical deflection is approximately 25 ~ 35 mm (1.0 ~ 1.4 in). If the deflection exceeds 35 mm (1.4 in) adjust the chain tension.



a. 25 ~ 35 mm (1.0 ~ 1.4 in)

Drive Chain Tension Adjustment

1. Loosen the rear brake adjuster.

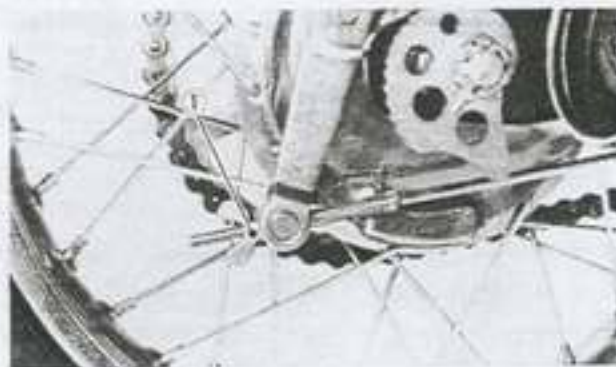

1. Rear brake adjuster

2. Remove the cotter pin of the rear wheel axle nut with pliers.
3. Loosen the rear wheel axle nut.
4. Turn the chain puller both left and right until axle is situated in same puller slot position on each side.

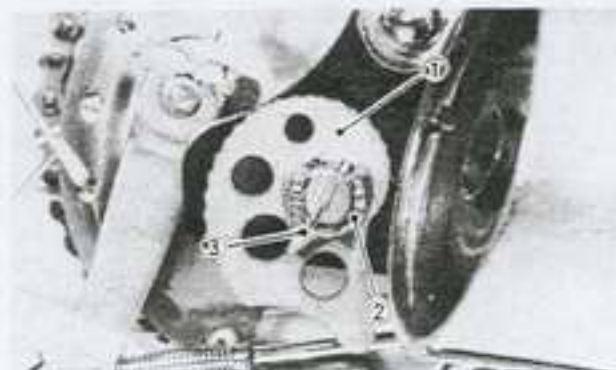

1. Chain puller 2. Axle nut 3. Cotter pin

5. Tighten the rear axle nut.

Axle nut torque:
10.7 m·kg (77.5 ft·lb)

6. Insert the cotter pin into the rear wheel axle nut and bend the end of the cotter pin as shown in the illustration (if the nut notch and the cotter pin hole do not match, tighten the nut slightly to match).
7. In the final step, adjust the play in the brake pedal.

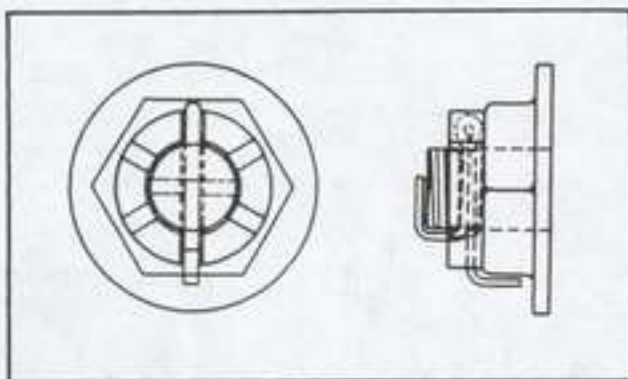

CAUTION:

Excessive chain tension will overload the engine and other vital parts; keep the tension within the specified limits. Also, replace the rear axle cotter pin with a new one.

Drive Chain Lubrication

1. First, remove dirt and mud from the chain with a brush or cloth and then spray the lubricant between both rows of side plates and on all center rollers.
2. To clean the entire chain, first remove the chain from the motorcycle, dip it in solvent and clean out as possible. Then take the chain out of the solvent and dry it. Immediately, lubricate the chain to prevent the formation of rust.

Recommended lubricant:
Yamaha chain and cable lube or
SAE 10W/30 motor oil

Front Fork Oil Change

WARNING:

Securely support the motorcycle so there is no danger of it falling over.

1. Raise the motorcycle or remove the front wheel so that there is no weight on the front end of the motorcycle. Remove the handlebar if necessary.
2. Remove the rubber cap from the top of each fork.

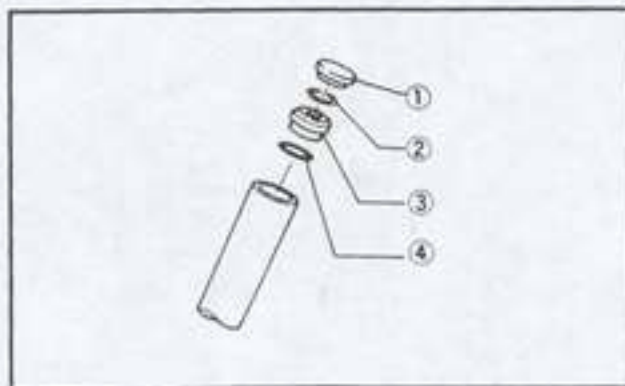

1. Cap 3. Spring seat
2. Stopper ring 4. O-ring

CAUTION:

Always use a new stopper ring (wire circlip).

3. The spring seat and fork spring are retained by a stopper ring (spring wire circlip). It is necessary to depress the spring seat and fork spring to remove the stopper ring. Remove the stopper ring by carefully prying out one end with a small screwdriver.
4. Place an open container under each drain hole. Remove the drain screw from each outer tube.
5. When most of the oil has drained, slowly raise and lower the outer tubes to pump out the remaining oil.
6. Inspect the drain screw gasket. Replace if damaged. Reinstall the drain screw.
7. Pour the specified amount of oil into the fork inner tube.

Recommended oil:
Yamaha fork oil 10Wt or equivalent

Quantity per leg:
168 cc (5.7 oz)

8. After filling, slowly pump the forks up and down to distribute the oil.
9. Inspect the "O" ring on the spring seat. Replace "O" ring if damaged.
10. Reinstall the spring seat, stopper ring and rubber cap.

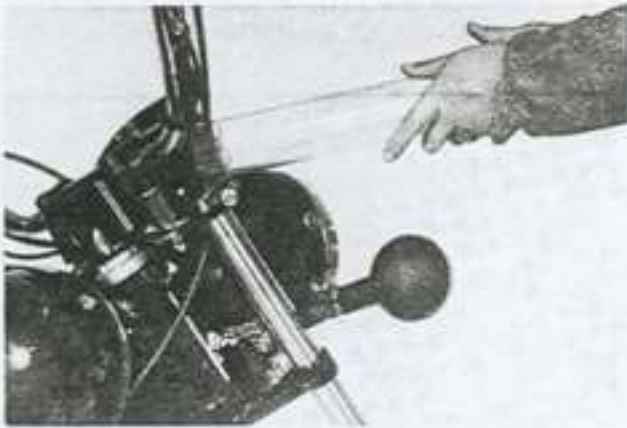

Suspension, Steering and Swing Arm

1. Steering head adjustment
 - a. Block the motorcycle up so that front wheel is off the ground.
 - b. Grasp the bottom of the forks and gently rock fork assembly backward and forward, checking for any looseness in the steering assembly bearing.
 - c. If the steering head needs adjustment, remove the handlebar cover and loosen the steering fitting bolt.
 - d. Using the ring nut wrench, adjust the steering ring nut until steering head is tight without binding when the forks are turned.

NOTE: Excessive tightening of this nut will cause rapid wear of the ball bearings and races. Re-check for looseness and freedom of movement.



1 Ring nut wrench

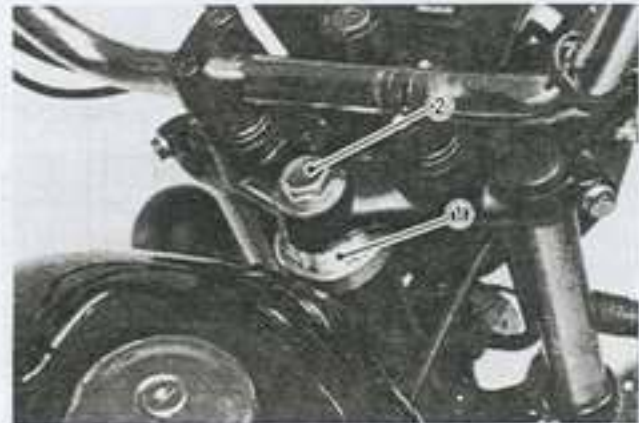

1 Steering ring nut 2 Steering fitting bolt

- e. Tighten the steering fitting bolt.

NOTE: After completing the steering adjustment, make certain forks pivot from stop to stop without binding. If binding is noticed, repeat adjustment.

2. Suspension
 - a. Check the all suspension components for proper operation.
 - b. Check the all suspension fittings for proper tightness.
3. Swing arm
 - a. Check for freedom of up and down movement.
 - b. Check side to side freeplay.

Swing arm free play:
1.0 mm (0.04 in) at end of swing arm

- c. Check the all securing bolts for proper tightness.

Rear Shock Absorber

See Chapter 5 "Rear Shock Absorber".

The spring preload of the rear shock absorbers can be adjusted to suit rider preference and riding conditions. If the spring seat is raised, the spring becomes stiffer and if lowered the spring becomes softer.

WARNING:

Always adjust the shock absorbers on each side to the same position. Uneven adjustment can cause poor handling and loss of stability.



A Stiffer B Softer

Cable Inspection and Lubrication

1. Damage to the outer housing of the various cables, may cause corrosion and often free movement will be impaired. An unsafe condition may result so replace cables as soon as possible.
2. If the inner cables do not operate smoothly, lubricate or replace them.

Recommended lubricant:

Yamaha chain and cable lube or
SAE 10W/30 motor oil

Throttle Cables and Grip Lubrication

The throttle twist grip assembly should be greased at the time that the cables are lubricated, since the grip must be removed to get at the ends of the throttle cables.

Two screws hold the throttle housing to the handlebar. Once these two screws are removed, the ends of the cables can be held high to pour in several drops of lubricant. With the throttle grip disassembled, coat the metal surfaces of the grip assembly with a suitable all-purpose grease to cut down friction.

Lubrication of Levers, Pedals, etc.

1. Lubricate the pivoting parts of the brake and clutch levers with recommended lubricant.

Recommended lubricant:

Yamaha chain and cable lube or
SAE 10W/30 motor oil

2. Lubricate the shaft of the brake pedal with lithium soap grease.

ELECTRICAL

Ignition Timing

1. Checking the ignition timing
Ignition timing is checked with a timing light by observing the position of the mark on the case and the marks on the rotor.
 - a. Remove the crankcase cover (L).
 - b. Connect the timing light to the spark plug lead wire.
 - c. Start the engine and keep it running at the specified speed.
 - d. The index projection on the crankcase must be between the two marks for firing on the rotor.
If not, refer to Chapter 6 "Ignition System".

Specified idling speed: 1,200 r/min

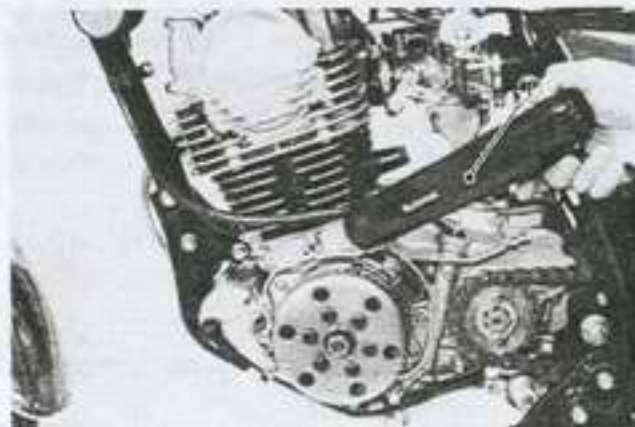

1 Timing light

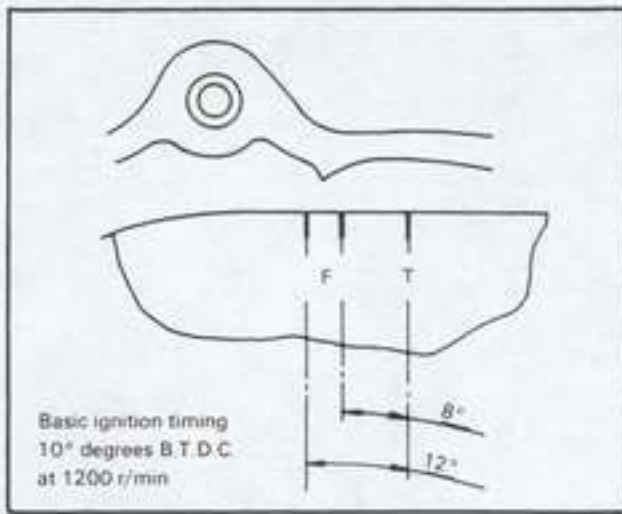

NOTE:
Ignition timing is not adjustable.

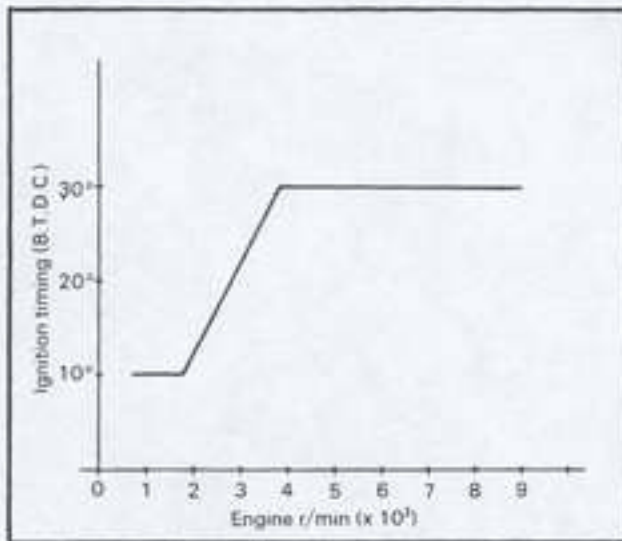

Spark plug

The life of a spark plug and its discoloring vary according to the habits of the rider. At each periodic inspection, replace burned or fouled plug with new ones of the specified type. It is actually economical to install new plug often since it will tend to keep the engine in good condition and prevent excessive fuel consumption.

1. The spark plug should be inspected and cleaned at the specified intervals.
2. Clean the electrodes of carbon and adjust the electrode gap to the specification.
3. Be sure to use the proper reach, type and electrode gap plug as a replacement to avoid overheating, fouling or piston damage.

Type:
BP7ES (NGK) or W22EP (ND)
Electrode gap:
0.7 ~ 0.8 mm (0.028 ~ 0.031 in)
Tightening torque:
2.0 m·kg (14.5 ft·lb)

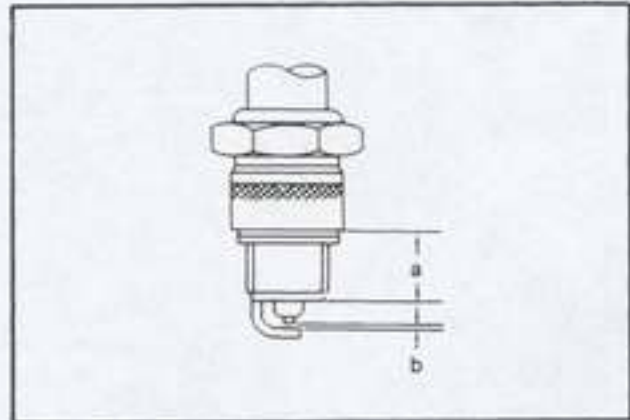

a. 19 mm (0.75 in)
b. 0.7 ~ 0.8 mm (0.027 ~ 0.031 in)

CHAPTER 3. ENGINE OVERHAUL

REMOVAL.....	3-1
Preparation for Removal.....	3-1
Fuel Tank.....	3-1
Muffler, Footrest and Brake Pedal.....	3-1
Wiring and Cables.....	3-1
Carburetor.....	3-2
Drive Chain.....	3-2
Engine Mounting Bolts.....	3-2
DISASSEMBLY.....	3-3
Cylinder Head and Cylinder.....	3-3
Piston Pin and Piston.....	3-5
Crankcase Cover (Right) and Starter Motor.....	3-5
Clutch Assembly and Drive Gear.....	3-6
Clutch Push Lever Axle.....	3-7
Balancer Gear.....	3-7
Oil Pump Assembly.....	3-7
Change Shaft Assembly.....	3-7
Crankcase.....	3-8
Transmission.....	3-8
Crankshaft.....	3-8
INSPECTION AND REPAIRING.....	3-9
Cylinder Head.....	3-9
Valves, Valve Springs, Valve Guides and Valve Seats.....	3-10
Camshaft and Camshaft Bearing.....	3-13
Cylinder.....	3-14
Piston and Piston Rings.....	3-15
Piston Pin.....	3-16
Crankshaft.....	3-16
Oil Pump.....	3-17
Primary Drive.....	3-17
Clutch.....	3-18
Transmission.....	3-18
Bearings and Oil Seals.....	3-19
Crankcase.....	3-20

ENGINE ASSEMBLING AND ADJUSTMENT.....	3-20
Crankshaft Installation	3-20
Shifter	3-21
Oil Pump.....	3-22
Balancer Drive Gear and Driven Gear	3-22
Push Lever Assembly	3-23
Clutch.....	3-23
Clutch Adjustment.....	3-24
Crankcase Cover Right.....	3-24
Piston.....	3-24
Cylinder.....	3-25
Cylinder Head	3-25
Cam Shaft, Cam Shaft Driven Sprocket and Cam Chain.....	3-25
Drain Plug.....	3-27
MOUNTING.....	3-27

CHAPTER 3. ENGINE OVERHAUL

REMOVAL

Preparation for Removal

1. All dirt, mud, dust and foreign material should be thoroughly removed from the exterior of the before removal and disassembly. This will prevent any harmful foreign material from entering the interior of engine assembly.
2. Before engine removal and disassembly, be sure you have proper tools and cleaning equipment so you can perform a clean and efficient job.
3. During disassembly of the engine, clean and place all parts in trays in order of disassembly. This will ease and speed assembly time and insure correct re-installation of all engine parts.
4. Start the engine and warm it for a few minutes; turn off the drain plug and drain engine oil.

Fuel Tank

1. Remove the seat and fuel tank.
2. Remove the right side cover and disconnect battery wire.

Muffler, Footrest and Brake Pedal

1. Remove the bolts holding the exhaust pipe to the cylinder head.
2. Remove the bolts holding the exhaust pipe to the frame.



3. Remove the exhaust pipe assembly.
4. Remove the left side footrest.
5. Remove the brake rod wing nut and the return spring.

Wiring and Cables

1. Remove the spark plug cap.
2. Remove the change pedal.
3. Remove the left crankcase cover.



4. Disconnect the magneto lead wire coupler and the band.
5. Disconnect the starter lead wire.
6. Remove the clutch wire at the handlebar lever first and then at clutch push lever. Next, remove the breather pipe.

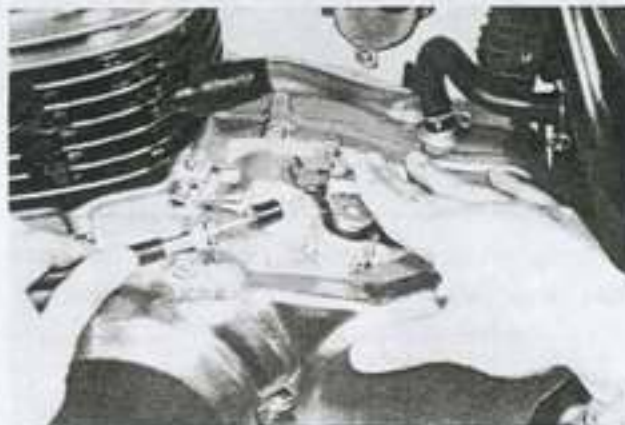



Carburetor

1. Loosen the carburetor hose clamps as shown in the photo.
2. Remove the carburetor assembly while pulling the carburetor body backward.

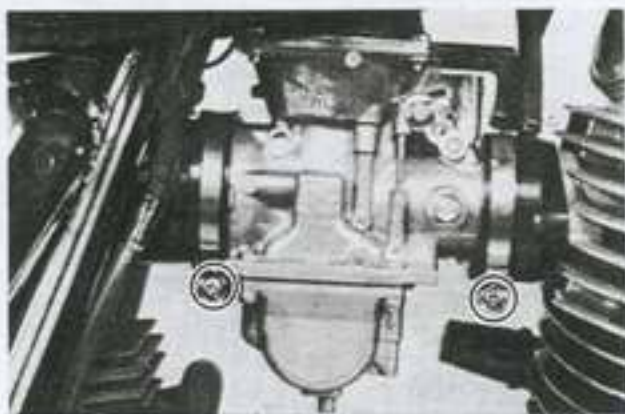

Drive Chain

1. Loosen the sprocket securing bolts and remove the holder plate.
2. Remove the drive sprocket.



NOTE:

The following procedure gives an alternative way to remove the chain from the engine.

3. Bring the master link clip slightly before the sprocket wheel, and remove the clip.
4. Set the chain cutter (special tool) on the chain, and remove the chain joint plate. Then, separate the chain.

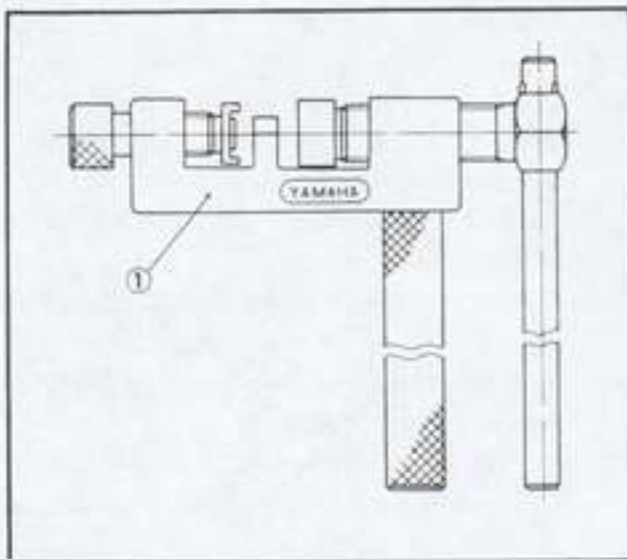

1 Chain cutter

Engine Mounting Bolts

1. Remove the left hand footrest securing bolts.
2. Remove the engine mounting bolts.
3. Remove the engine from the right side of frame.

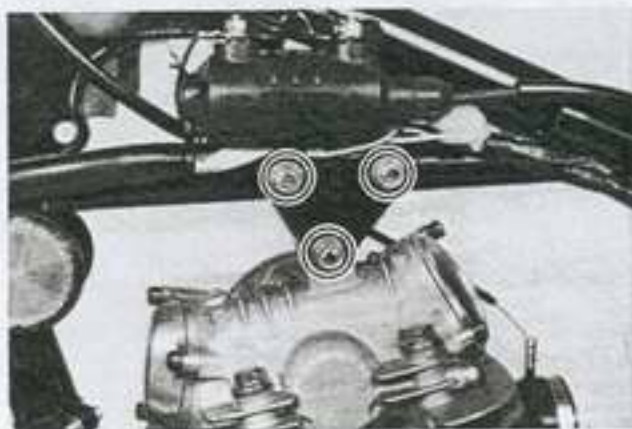

NOTE: _____

The engine and rear arm are installed using the same pivot shaft. Therefore take care so that the pivot shaft is pulled, not entirely out but further enough to see the engine free.

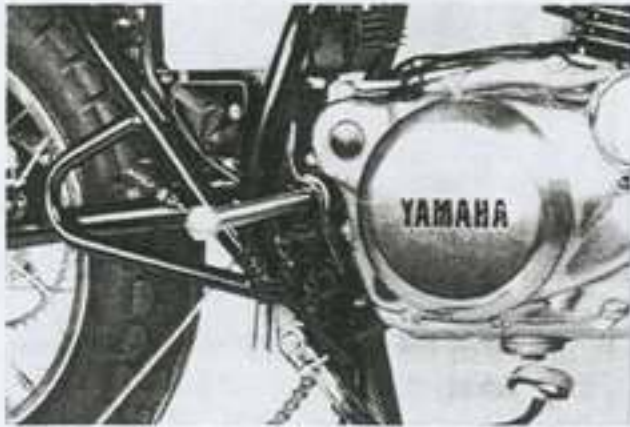

DISASSEMBLY

Cylinder Head and Cylinder

1. Remove the cam chain tensioner cap.
2. Loosen the tensioner lock nut.
3. Remove the chain tensioner assembly.
Note the location of each part.

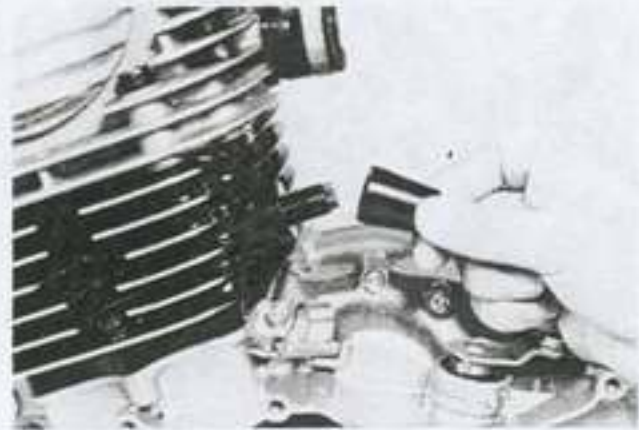

4. Loosen the side cover securing bolts and remove the side cover.
5. Remove the cam sprocket securing bolt (see the following photo). Then remove the flywheel magneto.

NOTE: _____

When removing the cam sprocket, it is not necessary to separate the cam chain.

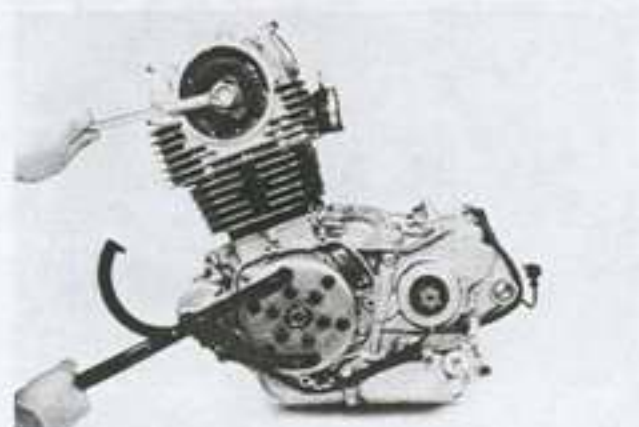
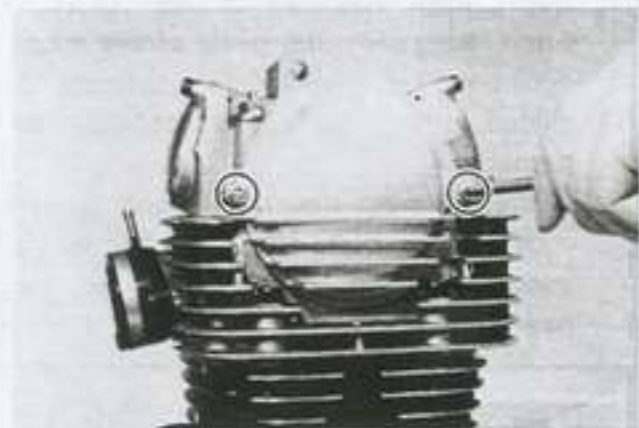

6. Flywheel magneto removal
 - a. Remove the flywheel securing nut using the rotor holding tool.

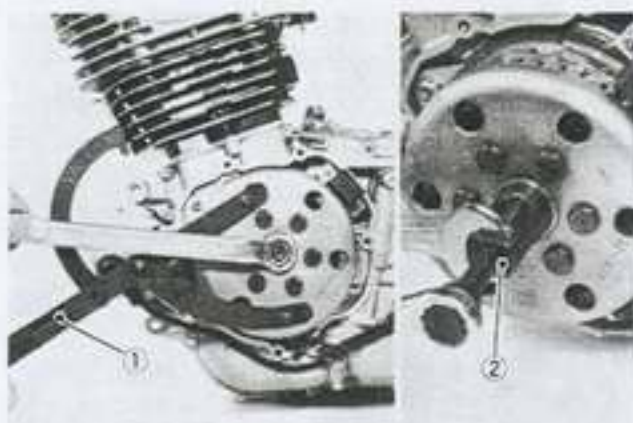

1. Rotor holding tool

2. Flywheel puller

- b. Install the flywheel puller on the flywheel and tighten it.

NOTE:

The puller body has a lefthand thread.

- c. While holding the puller body, tighten the push bolt. This will pull the flywheel off the tapered end of the crankshaft.
 - d. Remove the magneto base assembly with the lead wire.

NOTE:

1. Pay careful attention to the "O-ring" fitted along the outer circle of the magneto base because this ring is made of silicon rubber and is susceptible to damage.
2. If the magneto base is difficult to remove, screw bolts (M8) into the holes indicated by an arrow to pull out the base with.

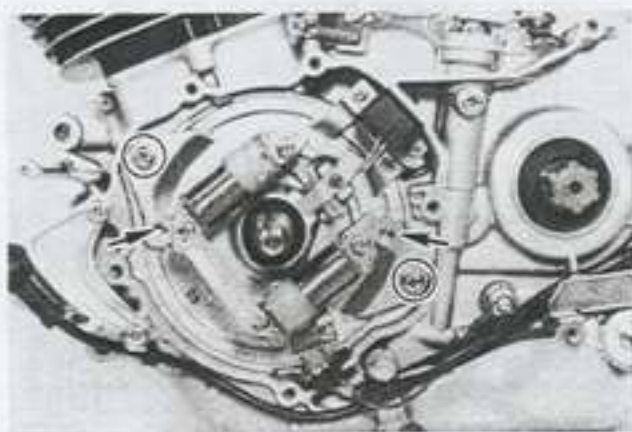

7. Loosen the guide stopper locking nut and bolt.

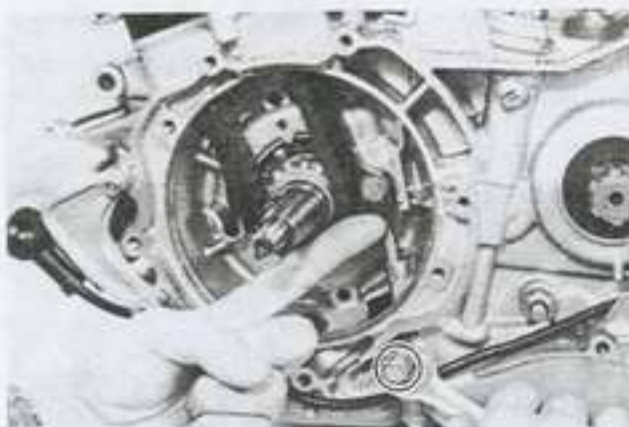

Guide stopper locking nut and bolt

8. Remove the cam chain and cam chain sprocket.



9. Remove the six cylinder head retaining bolts (2 of which are internal hexagon bolts) and the cylinder retaining bolt.

NOTE:

Loosen the bolts in the order indicated in the following photo.

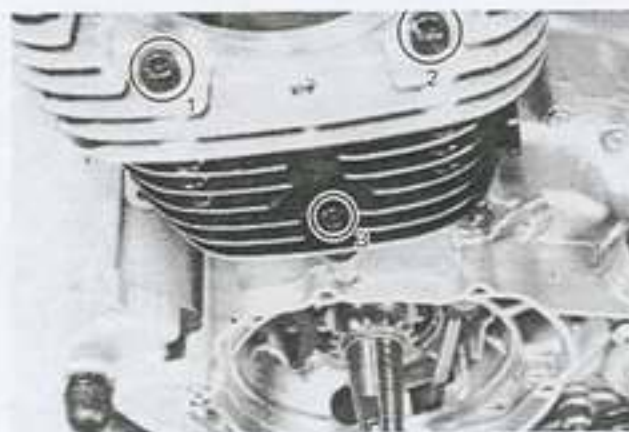

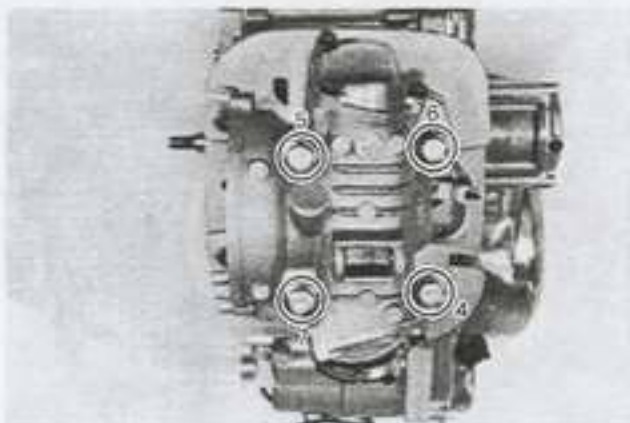

10. Remove the cylinder head and cylinder.
11. Remove the guide stoppers.

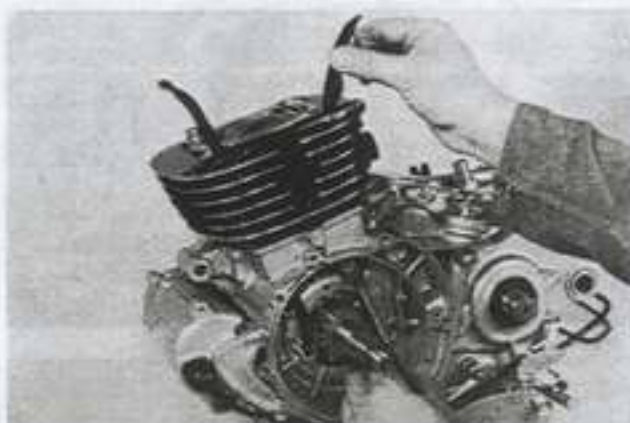

Piston Pin and Piston

1. Remove the piston pin clip from the piston.

NOTE: _____
 Before removing the piston pin clip, cover the crankcase with a clean rag so you will not accidentally drop the clip into the crankcase.



2. Push the piston pin from the opposite side, then pull out.

NOTE: _____
 Before removing piston pin, deburr the clip groove and pin hole area.

Crankcase Cover (Right) and Starter Motor

1. Remove the oil filter cover holding bolts and the cover.
2. Remove the oil filter element.
3. Remove the crankcase cover holding bolts and the cover.



NOTE: _____
 For this removal, slits in the crankcase can be used as shown in the photo.



4. Remove starter motor assembly.

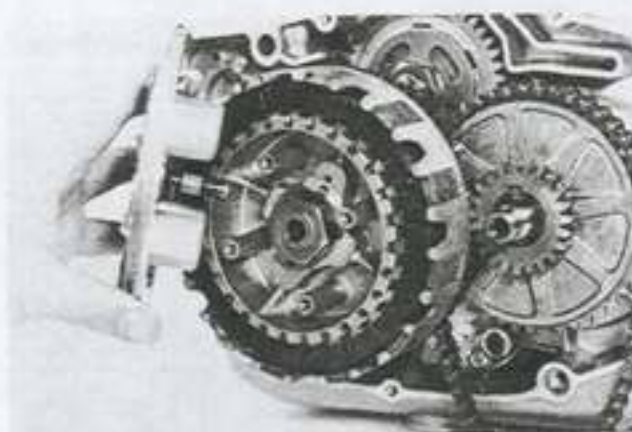
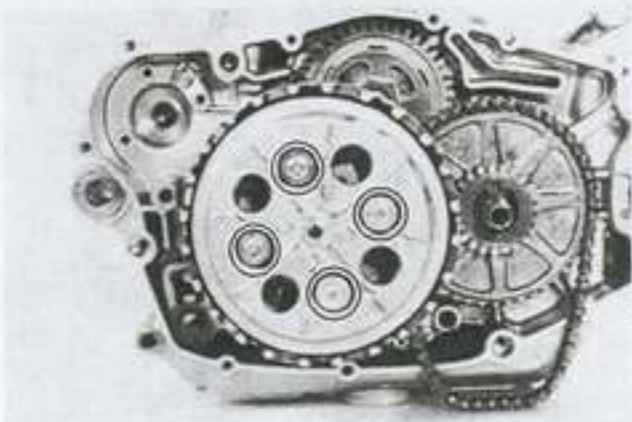

Clutch Assembly and Drive Gear

1. Loosen primary drive gear by first placing a folded rag between the teeth of the primary gears to lock them as shown in the photo. Then loosen drive gear nut.

Remove the nut and washer.

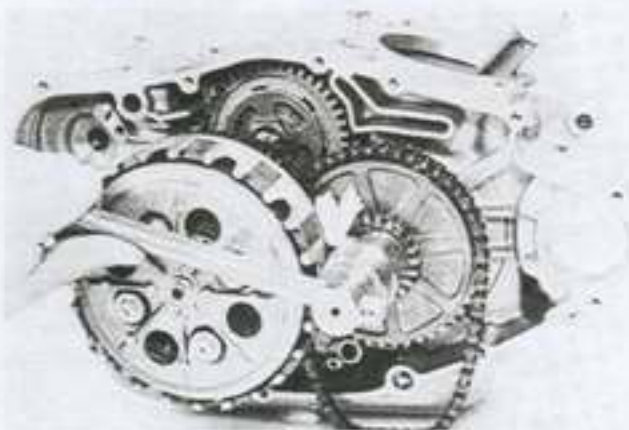

2. Remove the four clutch spring holding screws, pressure plates, clutch plates, friction plates, ball and push rod 2.



3. Install clutch holding tool on clutch boss. Remove lock nut, washer, clutch boss and housing in that order.

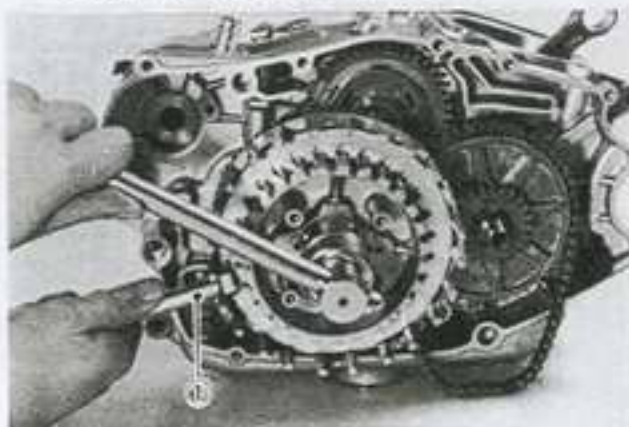

1. Clutch holding tool

Clutch Push Lever Axle

Loosen and remove the set screw, then remove the push lever axle by pulling it up.

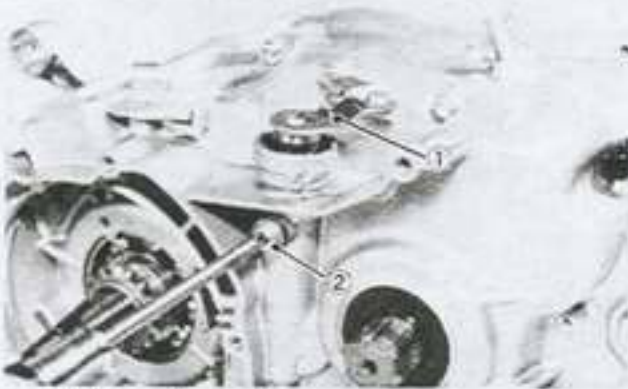

1. Push lever 2. Set screw

Balance Gear

1. Flatten the lock washer.
2. First place a folded rag between the teeth of the drive gear and balancer gear to lock them. Then loosen the balancer gear securing nut.
3. Remove the balancer gear, the washers and the key.
4. Remove the drive gear and key.

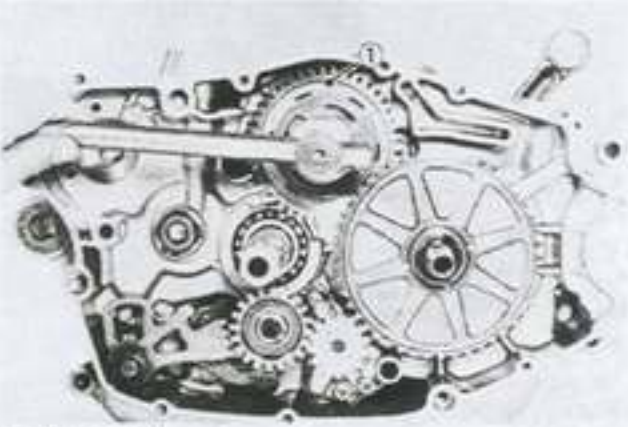

1. Balancer gear

Oil Pump Assembly

Remove the pump idle gear clip and then loosen the pump cover securing bolts and remove the oil pump assembly.

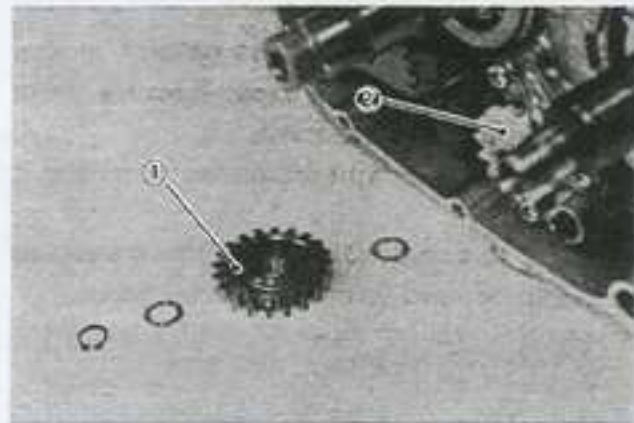

1. Pump idle gear 2. Pump driven gear

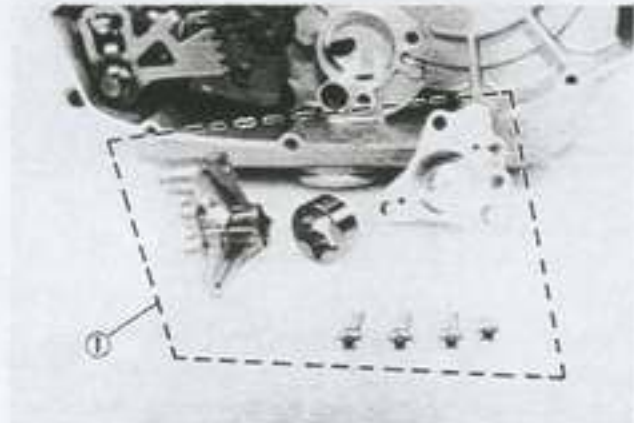

1. Pump Assembly

Change Shaft Assembly

1. Pull the shift shaft out from the right hand side.
2. Remove the shift lever 2 with the shift lever 3 as an assembly, and then remove the stopper lever assembly with the torsion spring.



1. Shift shaft 2. Shift lever 2
3. Shift lever 3 4. Stopper lever assembly

Crankcase

1. Working in a crisscross pattern, loosen all bolts 1/4 turn each. Remove them after all area loosened.
2. Remove the right crankcase by pulling it up.

For this removal, slits in the crankcase can be used as shown in the photo.

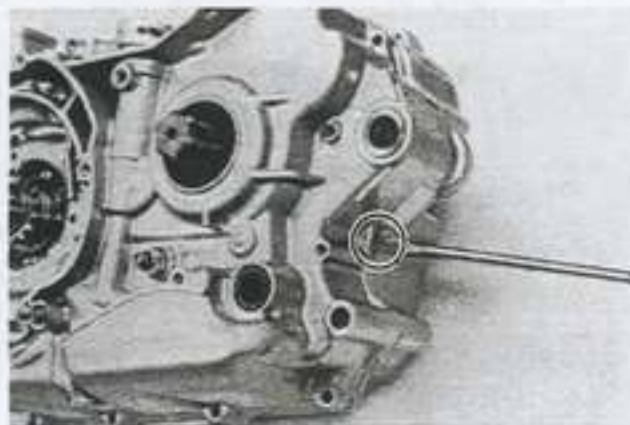
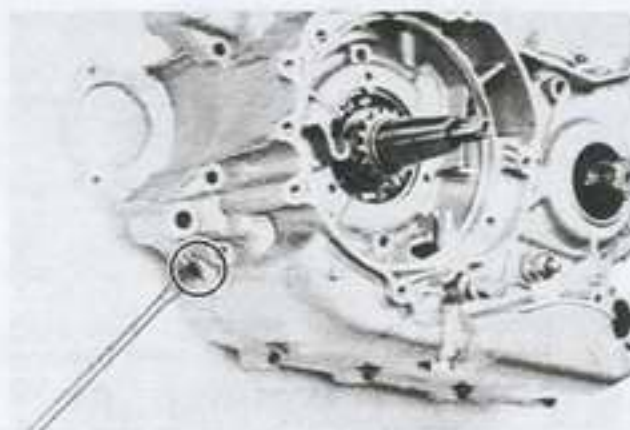
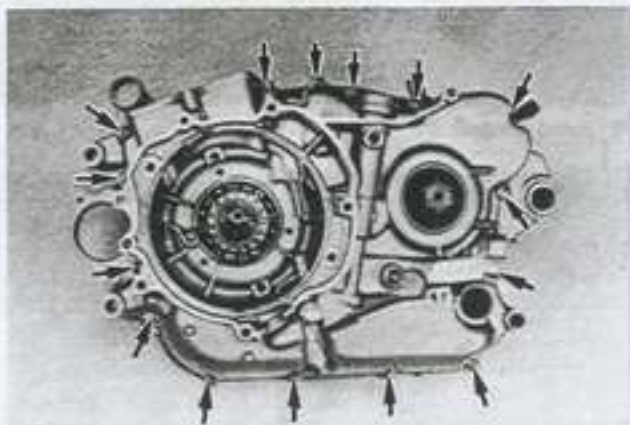

Transmission

Remove the transmission shaft, shift forks and shift cam. Tap lightly on the transmission drive shaft with a soft hammer to remove.

NOTE:

Remove assembly carefully. Note the position of each part. Pay particular attention to the location and direction of shift forks.

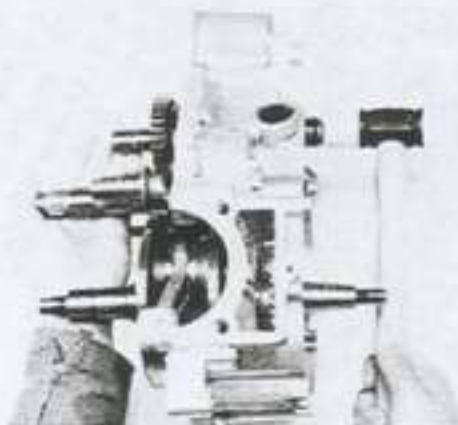

NOTE:

While removing the drive axle from the crankcase, pay careful attention to the oil seal lip. A recommended practice is to fit the "O" ring and to apply grease over the fitted area.



"O" ring

Crankshaft

Remove crankshaft assembly with the crankcase separation tool (Special tool).

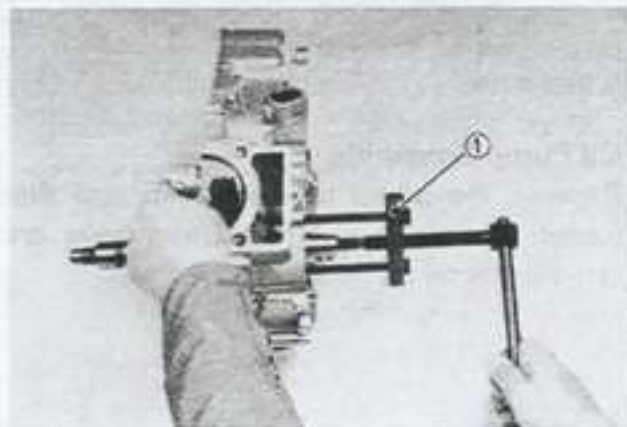

1. Crankcase separation tool

INSPECTION AND REPAIRING

Cylinder Head

1. Remove the intake and exhaust tappet covers.
2. Insert a 6 mm (0.24 in) screw into the rocker shaft, and withdraw the rocker shaft. It should be slide out easily.

NOTE: _____

If does not slide out easily, use the special tool as shown.

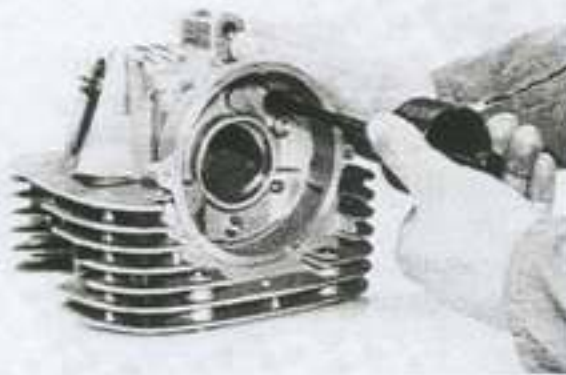
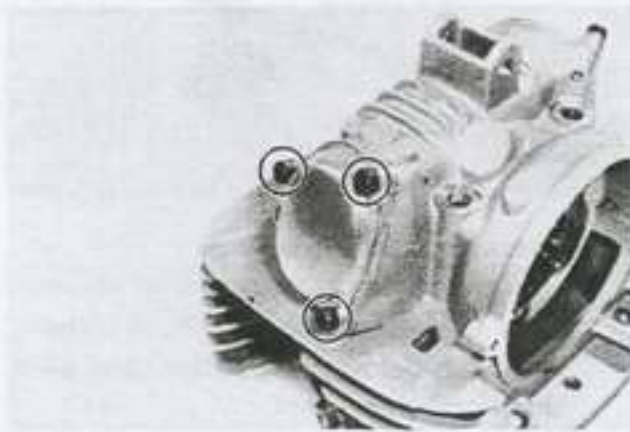

3. Rocker arm and rocker shaft
 - a. The rocker arm usually wears at two locations: (1) at the rocker shaft hole, (2) at the cam lobe contacting surface.
 - b. Measure the rocker arm inside diameter.

Standard size:
12.000 ~ 12.018 mm
(0.472 ~ 0.473 in)

- c. The shaft has been hardened and it should not wear excessively. If a groove has developed in this surface that can be felt, or if it shows a blue discoloration, then the shaft should be replaced

and the lubrication system (pump and passages) checked.

Standard shaft diameter:
11.975 ~ 11.990 mm
(0.471 ~ 0.472 in)

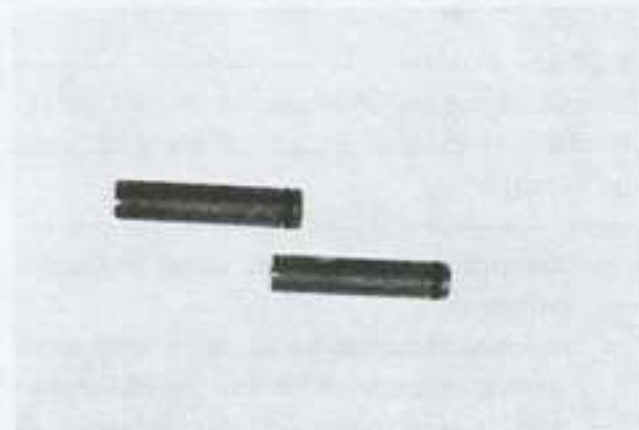
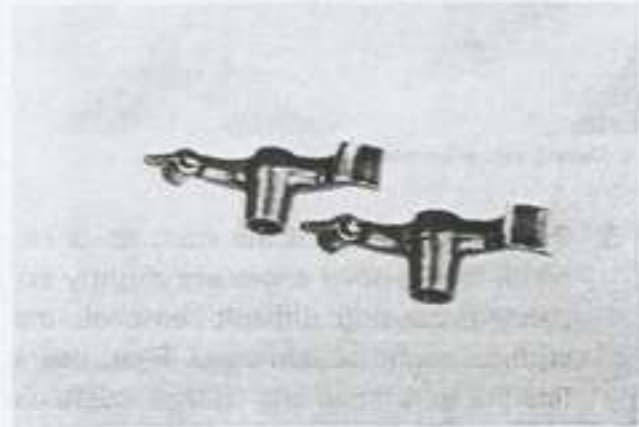

- d. Standard clearance between the rocker shaft and hole should be 0.010 ~ 0.043 mm (0.0004 ~ 0.0017 in). If measurement shows more than 0.1 mm clearance, replace either or both parts as necessary.
4. Compress the valve spring and then remove both retainer locks. Remove the compressor and lift off the retainer and springs.

NOTE: _____

The retainer locks might be partially stuck in the retainer. Use a rubber hammer to tap the edge of the retainer a few times to loosen the retainer locks.

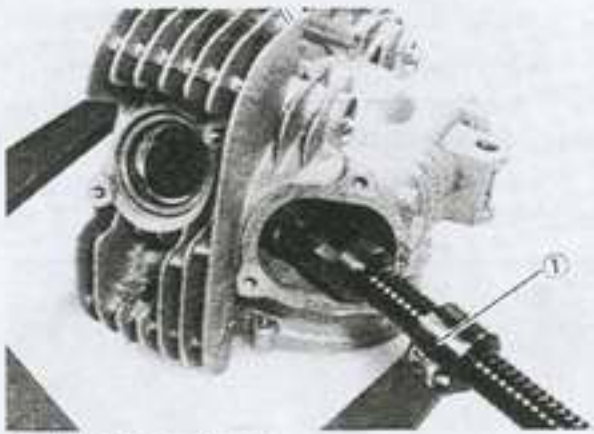

1. Valve spring compressor

5. Pull the valve out. If the stem tip or retainer lock groove edges are slightly expanded, causing difficult removal, the surface might be damaged. First, use a fine file to remove any lip that exists on the stem and then remove the valve.

NOTE:

Be sure to remove the valve stem seal before removing the valve. Otherwise the seal could be damaged.

6. Decarbonization of the head and components:
Carbon deposits build up in the combustion chambers, on the valves, and in the exhaust ports. Thoroughly clean all parts with a blunt scraper, then wash in solvent and dry with compressed air. The parts can then be examined and measured for wear.

Valves, Valve Springs, Valve Guides and Valve Seats

1. Check the intake and exhaust valve stems for bending and grooved wear. And check the stem ends for wear. Measurements should be done in three positions, upper, middle, and lower.

Intake valve stem diameter:
6.975 ~ 6.990 mm
(0.2746 ~ 0.2752 in)
Exhaust valve stem diameter:
6.955 ~ 6.970 mm
(0.2529 ~ 0.2744 in)



2. Checking the valve springs
 - a. This engine use two springs of different sizes to prevent valve float or surging. The chart below shows the basic value characteristics.
 - b. Even though the spring is constructed of durable spring steel, it gradually loses some of its tension. This is evidenced one way by a gradual shortening of free length. Use a vernier caliper to measure spring free length. If the free length of any spring has decreased more than 2 mm (0.08 in) from its specification, replace it.



	Outer	Inner
Free length	43.2 mm (1.70 in)	40 mm (1.57 in)
Installed length (Valve closed)	37.1 mm (1.46 in)	34.1 mm (1.34 in)
Installed pressure (Valve closed)	23.7 ± 1.9 kg (52.3 ± 4.2 lb)	12.2 ± 1.0 kg (26.9 ± 2.2 lb)
Compressed length (Valve open)	28.1 mm (1.11 in)	25.1 mm (0.99 in)
Compressed pressure (Valve open)	70.1 ± 4.9 kg (154.6 ± 10.8 lb)	36.6 ± 2.6 kg (80.7 ± 5.7 lb)

- c. Another symptom of a fatigued spring is insufficient spring pressure when compressed. This can be checked using a valve spring compression rate gauge. Test each spring individually. Place it in the gauge and compress the spring first to the specified compressed length with the valve closed (all spring specifications can be found in previous section, Valve Spring) then to the length with the valve open. Note the poundage indicated on the scale at each setting. Use this procedure on the outer springs, then the inner springs.

NOTE:

All valve springs must be installed with larger pitch upward as shown below.

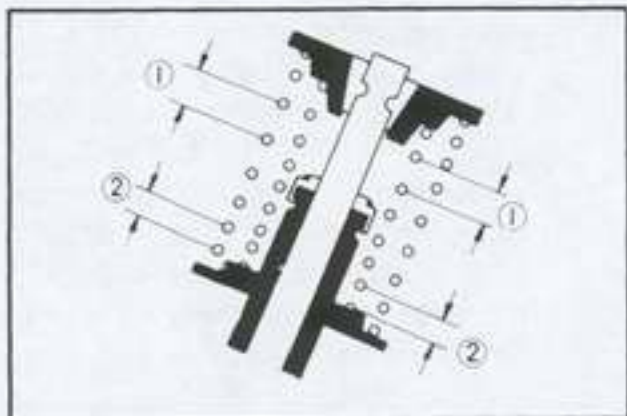

1. Larger pitch 2. Smaller pitch

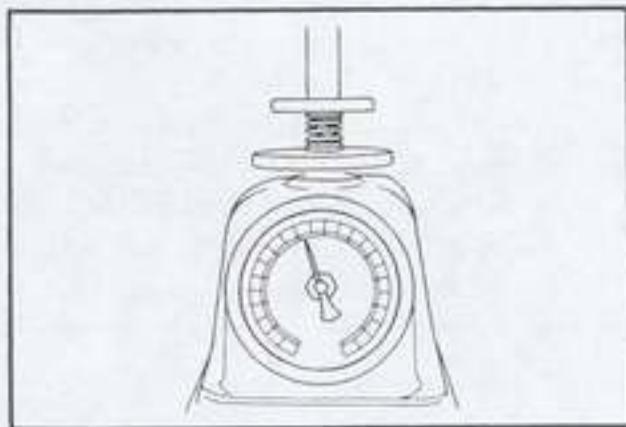

3. Valve leakage check

After all work has been performed on the valve and valve seat, and all head parts have been assembled, check for proper valve/valve seat sealing by pouring solvent into each of the intake ports, then the exhaust ports. There should be no leakage by the seat. If this

fluid leaks, disassemble and continue to lap with fine tapping compound. Clean all parts thoroughly, reassemble and check again with solvent. Repeat this procedure as often as necessary to obtain a satisfactory seal.

4. Valve stem seal

This seal slips down over the valve stem to prevent excessive amounts of oil from passing down stem and into the combustion chamber. If this seal is cracked, split, or hardened, replace it.

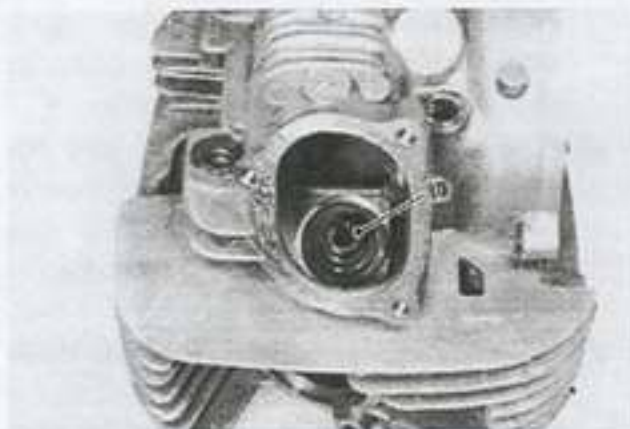

1. Valve stem seal

5. Valve guide

- a. If the valve guide inside diameter is beyond serviceable limits, replace with an oversize valve guide.

	Standard	Limit
Guide diameter (I.D.)	7.00 ~ 7.012 mm (0.2755 ~ 0.2761 in)	7.05 mm (0.278 in)

- b. To ease guide removal and reinstallation, and to maintain the correct interference fit, heat the head to 100°C (212°F). If possible, use an oven to avoid any possibility of head warpage due to uneven heating.
- c. Use the appropriate shouldered drive (special tool) to drive the old guide out and the new guide in.

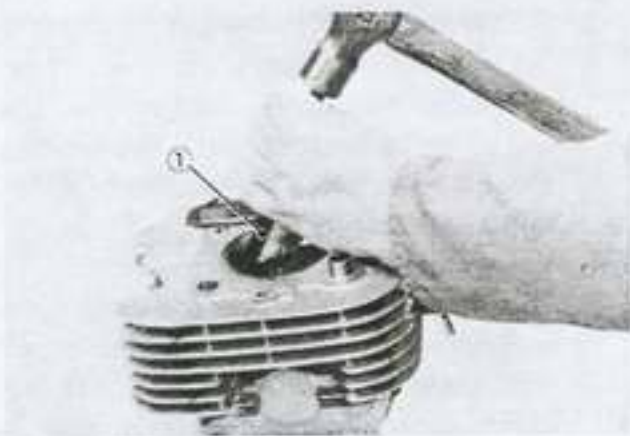

1. Valve guide remover

- d. After installing the valve guide, use 7 mm (0.276 in) reamer (special tool) to obtain the proper valve clearance.
 - e. After fitting the valve guide into the cylinder head, be sure to grind the valve seat, and perform valve lapping. The valve must be replaced by a new one.
6. Grinding the valve seat
- a. The valve seat is subject to severe wear similar to the valve face. Whenever the valve face is resurfaced, the valve seat should also be resurfaced at a 45° angle. In addition, if a new valve guide has been installed (without any valve repair), the valve seat should be checked to guarantee complete sealing between the valve face and seat.

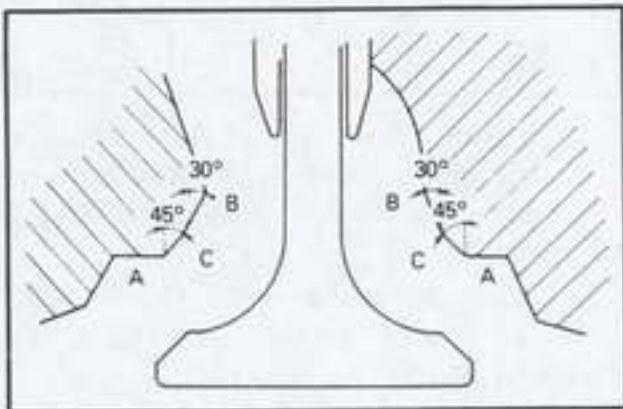

CAUTION:

If the valve seat is obviously pitted or worn, it should be cleaned with a valve seat cutter. Use the 45° cutter, and when twisting the cutter, keep an even downward pressure to prevent chatter marks.

If cutting section "A" of the intake valve seat, use "FLAT" cutter (radius cutter).
If cutting section "A" of the exhaust valve seat, use "FLAT" cutter (also radiused).

If cutting section "B", use the 30° cutter.

If cutting section "C", use the 45° cutter.

- b. Measure valve seat width. Apply mechanic's bluing dye (such as Dykem) to the valve face, apply a very small amount of fine grinding compound around the surface of the valve seat, insert the valve into position, and spin the valve quickly back and forth. Lift the valve, clean off all grinding compound, and check valve seat width. The valve seat will have removed the blueing wherever it contacted the valve face. Measure the seat width with vernier calipers. It should measure approximately 1.1 mm (0.043 in). Also, the seat should be uniform in contact area. If valve seat width varies, or if pits still exist, then continue to cut with the 45° cutter. Remove just enough material to achieve a satisfactory seat.

	Standard width	Wear limit
Seat width	1.1 mm (0.043 in)	1.8 mm (0.071 in)

- c. If the valve seat is uniform around the perimeter of the valve face, but is too wide or not centered on the valve face, it must be altered. Use either the "FLAT", 45°, or 30° cutters to correct the improper seat location in the manner described below:

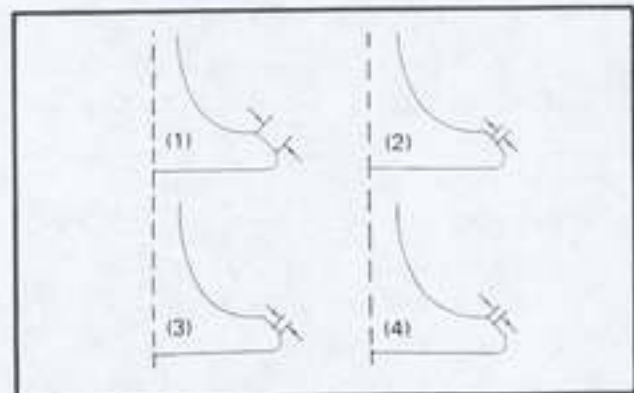

- c. Insert each ring into the cylinder and push it down approximately 20 mm (0.8 in), using the piston crown so that the ring forms the right angles to the cylinder bore. Measure the end gap of the ring with a feeler gauge. If the gap is beyond tolerance, replace the whole set of rings.

NOTE:

The end gap on the expander spacer of the oil control ring is unmeasurable. If the oil control ring rails show excessive gap all three components should be replaced.

	Standard	Limit
Top/2nd ring	0.2 ~ 0.4 mm (0.0079 ~ 0.0157 in)	0.80 mm (0.0315 in)
Oil control (Rails)	0.3 ~ 0.9 mm (0.0118 ~ 0.0354 in)	—



Piston Pin

1. Apply a light film of oil to pin. Install in connecting rod small end. Check for play. There should be no noticeable vertical play. If play exists, check connecting rod small end for wear. Replace pin and connecting rod as required.
2. The piston pin should have no noticeable free play in position. If the piston pin is loose, replace the pin and/or the piston.



Crankshaft

1. Check crankshaft components per chart.

Check connecting-rod axial play at small end (to determine the amount of wear or crank pin and bearing at big end).	Small end play should not exceed 2 mm (0.079 in).	If small end play exceeds 2 mm (0.079 in) disassemble crankshaft, check connecting rod, crank pin and big end bearing. Replace defective parts. Play after reassembly should be within 0.8 ~ 1.0 mm (0.031 ~ 0.039 in)
Check the connecting rod side clearance at big end.	Move the connecting rod to one side and insert a feeler gauge. Big end axial play should be within 0.35 ~ 0.65 mm (0.014 ~ 0.026 in).	If excessive axial play is present, 0.7 mm (0.028 in) or more, disassemble the crankshaft and replace any worn parts.
Check crankshaft assembly runout. (Misalignment of crankshaft parts.)	Dial gauge readings should be within 0.03 mm (0.00118 in).	Correct any misalignment by tapping the flywheel with a brass hammer and by using a wedge.