

Longer Engine Life
Lower Maintenance Cost
Less Exhaust Smoke
Reduces Wear and Tear

1B5-F8199-E0



PRINTED IN INDIA
2Y14(OM-01)284-11-06-E

LIBERO 65

1B56

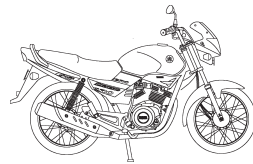

OWNER'S MANUAL

1B5-F8199-E0

LIBERO 65

⚠WARNING

PLEASE READ THIS MANUAL CAREFULLY AND COMPLETELY BEFORE OPERATING THIS MOTORCYCLE.

LIBERO
OWNER'S MANUAL
YAMAHA MOTOR INDIA PVT. LIMITED
All rights reserved. Any reprinting or
unauthorised use without the written
permission of
YAMAHA MOTOR INDIA PVT. LIMITED
is expressly prohibited.

TAKE NECESSARY PRECAUTIONS DURING RUNNING-IN PERIOD.

INTRODUCTION

Congratulations on your purchase of the **LIBERO**. This motorcycle has been produced using the latest technology in our modern plant, to provide you a happy, enjoyable and safe riding for many thousand kilometers and years. It represents the high degree of craftsmanship and reliability that have made **YAMAHA** a leader in these fields.

This Owner's Manual will give you an understanding of the operation, inspection and basic maintenance of this Motorcycle. To ensure a long trouble free performance, please take due care and ensure proper maintenance of your Motorcycle as recommended in this Owner's Manual. Always demand only **YAMAHA** Genuine Spare Parts and Yamalube oil. If you have any queries regarding the operation or maintenance of your Motorcycle, please consult your **YAMAHA DEALER** who will be too happy to help you.

This Owner's Manual also includes the GREEN BOOK containing Guidelines, DO's and DON'Ts to be followed by the Owner/ User of the Motorcycle for keeping Environment Clean and Green. You are requested to please read the GREEN BOOK carefully.

We Provide



At Your Caring Service,
YAMAHA MOTOR INDIA PVT. LTD.
A-3, Industrial Area, Noida Dadri Road
Surajpur-201 306 (India)

IMPORTANT MANUAL INFORMATION

Particularly important information is distinguished in this manual by the following notations:



The Safety Alert Symbol means ATTENTION ! BECOME ALERT ! YOUR SAFETY IS INVOLVED !

▲WARNING

Failure to follow WARNING instructions could result in severe injury to the Motorcycle operator, a bystander or a person inspecting or repairing the Motorcycle.

CAUTION :

A CAUTION indicates special precautions that must be taken to avoid damage to the Motorcycle.

NOTE :

A NOTE provides key information to make procedures easier or clearer.

NOTE :

- This manual should be considered a permanent part of this Motorcycle and should remain with it even if the Motorcycle is subsequently sold.
- YAMAHA continually seeks advancements in product design and quality. Therefore, while this manual contains the most current product information available at the time of printing, there may be minor discrepancies between your Motorcycle and this manual. If there is any question concerning this manual, please consult your YAMAHA dealer.

TABLE OF CONTENTS

1 ROAD SAFETY TIPS	1-1	Storage compartment	3-9
2 DESCRIPTION	2-1	Rear shock absorber adjustment	3-9
Left view	2-1	Handle Seat, Lifting Handle, stay Lock	3-10
Right view	2-2		
Controls/Instruments	2-3		
3 INSTRUMENT AND CONTROL		4 PRE-OPERATION CHECKS	4-1
FUNCTIONS	3-1	Pre-operation check list	4-1
Main switch cum steering lock	3-1	5 OPERATION AND IMPORTANT RIDING	
Speedometer	3-2	POINTS	5-1
Fuel gauge	3-2	Starting and warming up a	
Indicator lights	3-2	cold engine	5-1
Handlebar switches	3-3	Starting a warm engine	5-2
Clutch lever	3-3	Shifting	5-2
Shift pedal	3-4	Tips for reducing fuel consumption	5-3
Front brake lever	3-4	Running-in	5-3
Rear brake pedal	3-4	Parking	5-4
Fuel tank cap	3-5	6 PERIODIC MAINTENANCE AND MINOR	
Fuel	3-5	REPAIR	6-1
Fuel cock	3-6	Tool kit	6-1
Starter Lever	3-7	Preventive maintenance schedule	6-3
Kick starter	3-7	Panel removal and installation	6-5
Seat	3-8	Spark plug inspection	6-7
		Engine Oil	6-8

TABLE OF CONTENTS

Air filter	6-10	Fuse replacement	6-26
Carburetor adjustment	6-11	Headlight bulb replacement	6-27
Idle speed adjustment	6-12	Turn signal and taillight bulb replacement	6-28
Throttle cable free play adjustment	6-12	Front wheel removal	6-28
Valve clearance adjustment	6-13	Front wheel installation	6-30
Tyres	6-13	Rear wheel removal	6-30
Wheels	6-15	Rear wheel installation	6-32
Clutch lever free play adjustment	6-16	Troubleshooting	6-32
Front brake adjustment	6-16	Troubleshooting chart	6-33
Rear brake adjustment	6-17		
Brake light switch adjustment	6-17	7 CLEANING & STORAGE	
Checking the brake shoes	6-18	A. Cleaning	7-1
Drive chain slack check	6-18	B. Storage	7-2
Drive chain slack adjustment	6-19		
Drive chain lubrication	6-21	8 SPECIFICATIONS	8-1
Cable inspection and lubrication	6-21		
Throttle cable and grip lubrication	6-21	9 CUSTOMER INFORMATION	9-1
Brake and shift pedal lubrication	6-22	Key identification number	9-1
Brake and clutch lever lubrication	6-22	Frame serial number	9-1
Center and sidestand lubrication	6-22	Engine serial number	9-1
Front fork inspection	6-23	10 DETACHMENTS	
Steering inspection	6-23	Pre-Delivery Inspection	10-1
Wheel bearings	6-24	Installation	10-5
Battery	6-24	GREEN BOOK	

ROAD SAFETY TIPS

SAFE RIDING

1. Before riding, you should learn to ride your motorcycle properly and all the control functions should be known to you.
2. Remember that **there are no legal "rights" when it comes to survival** as far as Motorcyclists are concerned. The fact that you may be well within your rights is no guarantee that you will avoid a collision with a bigger vehicle whose driver fails to see you. Always ride defensively and take nothing on road for granted.
3. Develop the ability to **react swiftly** to any unexpected road hazards or emergencies giving yourself time to spare for appropriate response.
4. Develop the ability to get **the most out of your Motorcycle**, But at the same time get to know its **capabilities and limitations**.
5. Ride thoughtfully, planning your route well in advance.
6. **Give proper Signals** and use Horn and Headlights judiciously.
7. Don't ride in another **motorist's blind spot**.
8. Always make **pre-ride safety checks** before you start the Engine.

SAFE BRAKING

Use the basic methods of braking effectively.

1. Engine Brake : When the Throttle is released, compression backs up and acts as the Engine Brake. If the riding condition allows, reduce speed by shifting the Gear down.
2. Front and Rear Brakes : It is important to apply equal force to the Front and Rear Brakes simultaneously.

CAUTION :

- **Use Front and Rear Brakes simultaneously.**
 - **Be sure not to disengage the clutch while braking.**
 - **While riding downhill always use Engine as a Brake and never ride in Neutral Gear.**
 - **While riding down hill do not switch off ignition while Engine is in gear.**
-

DESCRIPTION

Left view

STANDARD VEHICLE

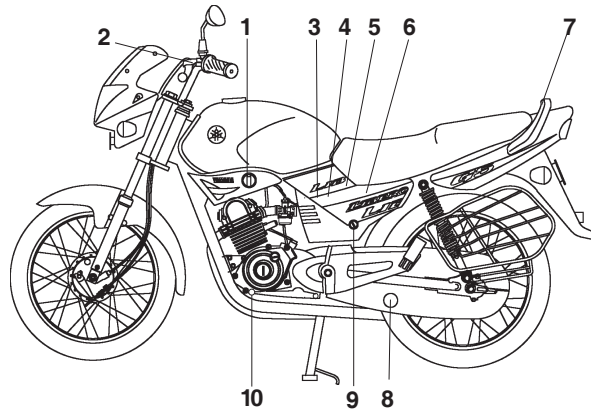

- | | | | |
|------------------------|-------------|---------------------------------------|-------------|
| 1. Fuel cock | (page 3-6) | 6. Toolkit | (page 6-1) |
| 2. Starter Lever | (page 3-7) | 7. Handle Seat | (page 3-10) |
| 3. Fuse | (page 6-26) | 8. Drive chain free play check window | (page 6-19) |
| 4. Battery | (page 6-24) | 9. Side panel (L.H.) lock | (page 6-5) |
| 5. Storage Compartment | (page 3-9) | 10. Shift pedal | (page 3-4) |

2-1

DESCRIPTION

Right view

STANDARD VEHICLE

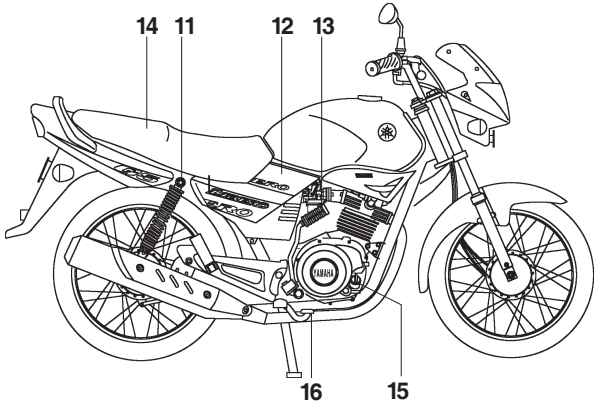

- | | | | |
|-------------------------|-------------|---------------------------|-----------------|
| 11. Rear shock absorber | (page 3-9) | 14. Seat | (page 3-8) |
| 12. Air filter | (page 6-10) | 15. Engine oil filler cap | (page 6-8) |
| 13. Kick starter | (page 3-7) | 16. Rear brake pedal | (page 3-4,6-17) |

DESCRIPTION

Controls / Instruments

STANDARD VEHICLE

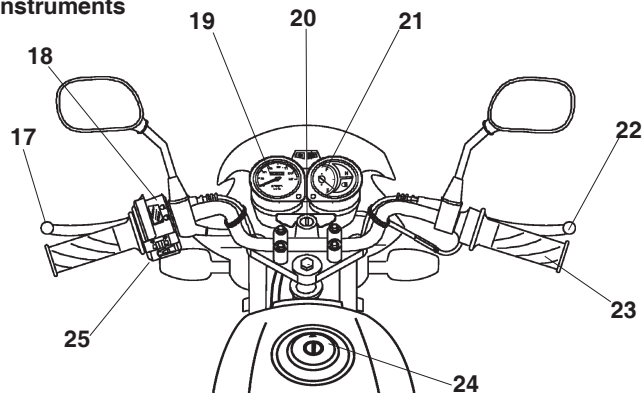

- | | | | |
|-----------------------------------|------------------|---------------------------|------------------|
| 17. Clutch Lever | (page 3-3, 6-16) | 22. Front Brake Lever | (page 3-4, 6-16) |
| 18. Left Hand Switch | (page 3-3) | 23. Throttle Grip | (page 6-12) |
| 19. Speedometer | (page 3-2) | 24. Fuel Tank Cap | (page 3-5) |
| 20. Main switch Cum Steering Lock | (Page 3-1) | 25. Turn Indicator Switch | (page 3-2) |
| 21. Fuel Gauge | (page 3-2) | | |

INSTRUMENT AND CONTROL FUNCTIONS

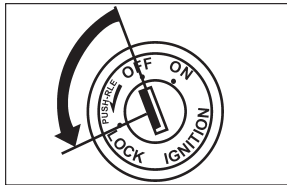

Main switch cum steering lock

The main switch controls the ignition and lighting systems. Its operation is described below.

ON:
Electrical circuits are switched on. The engine can be started. The key cannot be removed in this position.

OFF:
Engine will be shut off. All electrical circuits are switched off. The key can be removed in this position.

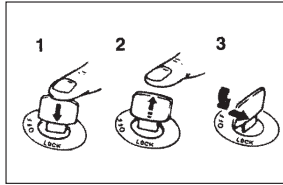

1. Push
2. Release
3. Turn

LOCK:

The steering is locked in this position and all electrical circuits are switched off.

The key can be removed in this position.

To lock the steering, turn the handlebars all the way to the left or right. With the key at "OFF", push it into the main switch and release it, turn it counter-clockwise to "LOCK" and remove it. To release the lock, turn the key to "OFF".

▲ WARNING

Never turn the key to "LOCK" when the Motorcycle is moving.

INSTRUMENT AND CONTROL FUNCTIONS

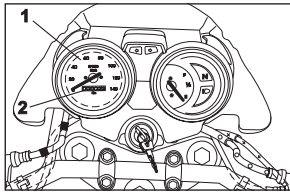

1. Speedometer
2. Odometer

Speedometer

The speedometer shows riding speed. This speedometer is equipped with an odometer.

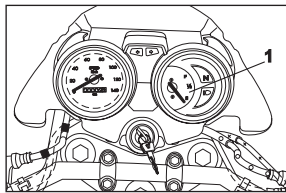

1. Fuel gauge

Fuel gauge

The fuel gauge indicates the quantity of the remaining petrol in the fuel tank. The gauge needle moves from "F" (Full) to "E" (Empty) as the fuel level decreases.

When the needle comes below "E" please refill the fuel tank at the earliest.

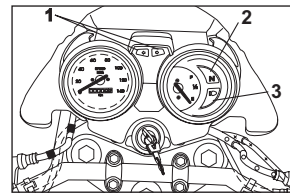

1. Turn indicator light "↔"
2. Neutral "N"
3. High beam.Indicator light "≡"

Indicator lights

1. Turn indicator light "↔"

The indicator flashes when the turn switch is moved to the left or right.

2. Neutral indicator light "N"

This indicator comes on when the transmission is in neutral.

3. High beam indicator light "≡"

This indicator comes on when the headlight high beam is used.

INSTRUMENT AND CONTROL FUNCTIONS

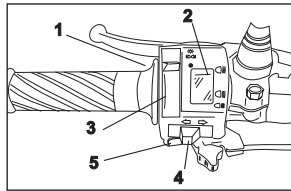

1. PassSwitch "☺"
2. Dimmer Switch
3. Light switch
4. Turn signal cum cancellation switch "↔"
5. Horn switch

Handlebar switches

Pass switch "☺"
Press the switch to operate the Passing Light.

Dimmers switch
Turn the switch to "☺" for the high beam and to "☹" for the low beam.

Turn signal switch

To signal a right-hand turn, push the switch to "☞". To signal a left-hand turn, push the switch to "☜". Once the switch is released it will return to the center position. To cancel the signal, push the switch in after it has returned to the center position.

Horn switch "☘"

Press the switch to sound the horn.

Lights switch

Turning the light switch to "☼☼", turns on the meter light and tail-light. Turning the light switch to "☼☼☼", turns the headlight on also.

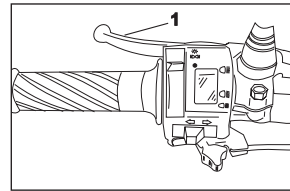

1. Clutch lever

Clutch lever

The clutch lever is located on the left handlebar. Pull the clutch lever to the handlebar to disengage the clutch, and release the lever to engage the clutch. The lever should be pulled rapidly and released slowly for smooth clutch operation.

INSTRUMENT AND CONTROL FUNCTIONS

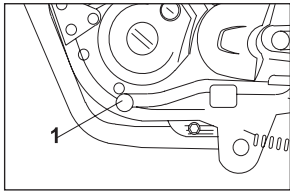

1. Shift pedal

Shift pedal

The shift pedal is located on the left side of the engine and is used in combination with the clutch when shifting.

Use your toe or heel to shift up and your toe to shift down.

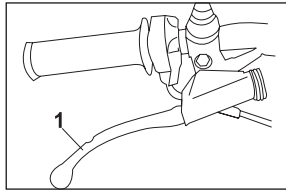

1. Front brake lever

Front brake lever

The front brake lever is located on the right handlebar. Pull it toward the handlebar to apply the front brake.

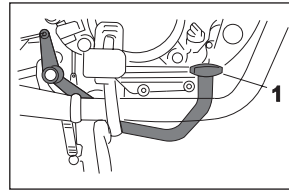

1. Rear brake pedal

Rear brake pedal

The rear brake pedal is on the right side of the Motorcycle. Press down on the brake pedal to apply the rear brake.

USE BOTH BRAKES SIMULTANEOUSLY

INSTRUMENT AND CONTROL FUNCTIONS

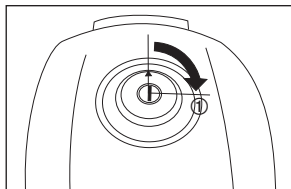

1. Open

Fuel tank cap

TO OPEN:

Insert the key and turn it 1/4 turn clockwise. The lock will be released and the cap can be opened.

TO CLOSE:

Push the tank cap into position with the key inserted. To remove the key, turn it counterclockwise to the original position.

Ensure the arrow on fuel tank is towards the Front of the bike when inserting Fuel Tank Cap in Fuel Tank.

NOTE :

This tank cap cannot be closed unless the key is in the lock. The key cannot be removed if the cap is not locked properly.

WARNING

Be sure the cap is properly installed and locked in place before riding the Motorcycle.

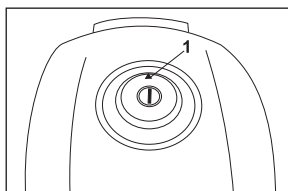

1. Arrow

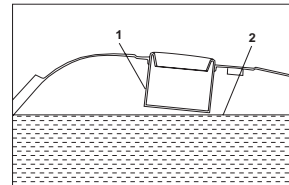

1. Filler tube
2. Fuel level

Fuel

Make sure there is sufficient fuel in the tank. Fill the fuel tank to the bottom of the filler tube as shown in the illustration.

WARNING

Do not overfill the fuel tank. Avoid spilling fuel on the hot engine. Do not fill the fuel tank above the bottom of the filler tube to avoid Spillage

INSTRUMENT AND CONTROL FUNCTIONS

CAUTION :

Always wipe off spilled fuel immediately with a dry and clean soft cloth. Fuel may deteriorate painted surfaces or plastic parts.

Recommended Fuel :
Regular gasoline (Petrol)
Fuel tank capacity :
Total :
13.0L
Reserve :
1.7 L

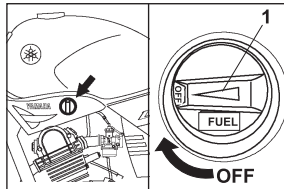

1. Arrow mark

Fuel cock

The fuel cock supplies fuel from the tank to the carburetor while filtering it also.

The fuel cock has three positions, which should be set as shown in the illustrations.

OFF: With the fuel cock in this position, fuel will not flow. Always set the fuel cock to this position when the engine is not running.

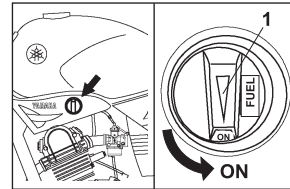

1. Arrow mark

ON: With the fuel cock in this position, fuel flows to the carburetor. Set the fuel cock to this position when starting the engine and while riding.

IT IS A GOOD PRACTICE TO RETURN THE FUEL COCK LEVER TO "Off" POSITION WHEN ENGINE IS NOT RUNNING

INSTRUMENT AND CONTROL FUNCTIONS

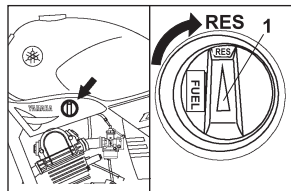

1. Arrow mark

RES: This indicates reserve. If you run out of fuel while riding, set the fuel cock to this position. Fill the tank at the first opportunity. Be sure to set the fuel cock back to "ON" after refueling

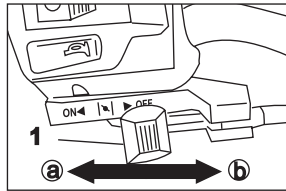

1. Starter lever

Starter lever

Starting a cold engine requires a richer air-fuel mixture. A separate starter circuit supplies this mixture.

- Move the Starter Lever in Direction **a** to Turn on the Starter
- Move the Starter Lever in Direction **b** to Turn Off the Starter

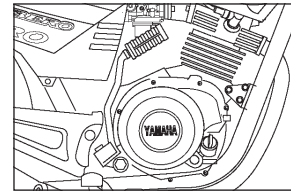

1. Kick starter

Kick-starter

Raise the right Pillion footrest, and rotate the kick starter away from the engine. Push the kick starter down lightly with your foot. Kick until the gears engage, then kick smoothly and forcefully to start the engine. This model has a primary-coupled kick starter so the engine can be started in any gear if the clutch is disengaged. However, shifting to neutral before starting is recommended.

NEVER MIX OIL IN PETROL

INSTRUMENT AND CONTROL FUNCTIONS

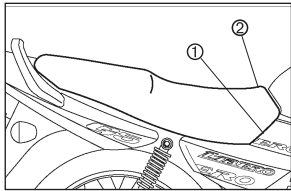

1. Open
2. Open

Opening of Seat

To remove

Open side panels as per instructions on page 6-5.

Remove the two bolts ① and ② as shown in figure. Lift the front of the seat and slide forward to remove.

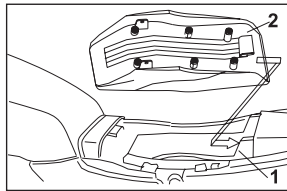

1. Seat Holder
2. Projection

To install

Insert the projection on the rear of seat in to seat holder. Then push down on front of the seat and tighten the bolts on the left and right hand side of the seat.

ALWAYS USE A HELMET WHILE RIDING FOR YOUR SAFETY

INSTRUMENT AND CONTROL FUNCTIONS

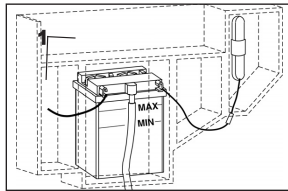

1. Storage compartment

Storage compartment

The storage compartment is located inside the L.H. Side Cover

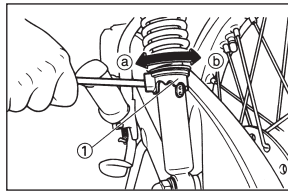

1. Spring preload adjusting ring
2. Position indicator

Rear shock absorber adjustment

Each shock absorber is equipped with a spring preload adjusting ring. Adjust spring preload as follows.

Turn the adjusting ring in direction ⓐ to increase spring preload and in direction ⓑ to decrease spring preload. Make sure that the appropriate notch in the adjusting ring is aligned with the position indicator on the rear shock absorber.

	Soft			Standard	Hard
Adjusting Position	1	2	3	4	5

WARNING

Always adjust each shock absorber to the same setting. Uneven adjustment can cause poor handling and loss of stability.

INSTRUMENT AND CONTROL FUNCTIONS

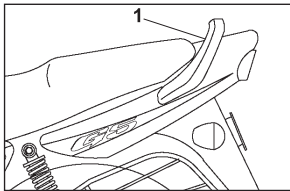

1. HandleSeat

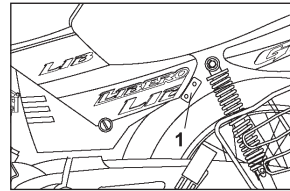

1. Stay Lock

Stay Lock

For mounting Helmet Lock

PRE-OPERATION CHECKS

Owners are personally responsible for their vehicle's condition. Your Motorcycle's vital functions can start to deteriorate quickly and unexpectedly- even if it remains unused (for instance, if it is exposed to the elements). Any damage, fluid leak or loss of tyre pressure could have serious consequence. Therefore it is very important that, in addition to a thorough visual inspection, you check the following points before each ride.

PRE - OPERATION CHECK LIST

ITEM	CHECKS	PAGE
Front brake	<ul style="list-style-type: none">• Check operation, condition and free play.• Adjust if necessary.	3-4, 6-16
Rear brake	<ul style="list-style-type: none">• Check operation, condition and free play.• Adjust if necessary.	3-4, 6-17
Clutch	<ul style="list-style-type: none">• Check operation, condition and free play.• Adjust if necessary.	3-3, 6-16
Throttle grip and housing	<ul style="list-style-type: none">• Check for smooth operation.• Lubricate if necessary.	6-12, 6-21
Engine oil	<ul style="list-style-type: none">• Check oil level.• Fill with oil if necessary.	6-8 ~ 6-9
Drive chain	<ul style="list-style-type: none">• Check chain slack and condition.• Lubricate if necessary.• Adjust if necessary.	6-18 ~ 6-21
Wheels and tyres	<ul style="list-style-type: none">• Check tyre pressure, wear, damage and spoke tightness.• Tighten spokes if necessary.	6-13 ~ 6-15
Control and meter cable	<ul style="list-style-type: none">• Check for smooth operation.• Lubricate if necessary.	6-21
Brake and shift pedal shafts	<ul style="list-style-type: none">• Check for smooth operation.• Lubricate if necessary.	6-22

PRE-OPERATION CHECKS

ITEM	CHECKS	PAGE
Brake and clutch lever pivots	<ul style="list-style-type: none">• Check for smooth operation.• Lubricate if necessary.	6-22
Center and sidestand pivot	<ul style="list-style-type: none">• Check for smooth operation.• Lubricate if necessary.	6-22
Chassis fasteners	<ul style="list-style-type: none">• Make sure that all nuts, bolts, and screws are properly tightened.• Tighten if necessary.	-
Fuel Tank	<ul style="list-style-type: none">• Check fuel level.• Fill with fuel if necessary.	3-5 - 3-7
Lights, signals and switches	<ul style="list-style-type: none">• Check for proper operation.	3-3, 6-27 - 6-28
Battery	<ul style="list-style-type: none">• Check fluid level.• Fill with distilled water if necessary.	6-24 - 6-26
Fuel gauge	<ul style="list-style-type: none">• Check for proper operation/Function	3.2

▲WARNING

If any item in the Pre-Operation Check is not working properly, have it inspected and repaired before operating the Motorcycle.

IF WAITING AT TRAFFIC SIGNAL IS FOR LONG, SWITCH OFF THE ENGINE TO PROTECT THE ENVIRONMENT AND TO LOWER FUEL CONSUMPTION

OPERATION AND IMPORTANT RIDING POINTS

▲WARNING

1. Before riding this Motorcycle, become thoroughly familiar with all operating controls and their functions. Consult a YAMAHA dealer regarding any control or function that you do not thoroughly understand.
2. Never start your engine or let it run for any length of time in a closed area. The exhaust fumes are poisonous and can cause loss of consciousness. Always operate your Motorcycle in an area with adequate ventilation.
3. Before starting out, always be sure the side stand is up. Failure to retract the side stand completely can result in a serious accident when you try to turn a corner.

Starting and warming up a cold engine

1. Turn the fuel cock to "ON"
2. Turn the main switch to "ON."
3. Shift the transmission into neutral.

NOTE :

When the transmission is in neutral, the neutral indicator light should be on. If the light does not come on, ask a YAMAHA dealer to inspect it.

4. Fully open the Starter Lever and completely close the throttle grip.
5. Kick the kick starter to start the engine.
6. After starting the Engine, turn back the Starter Lever to the Warming-up Position (About Half way)

7. After Warming-up the Engine, turn off the Starter Lever completely.

NOTE :

For better engine performance always warm up the engine. before take off. Never open throttle fully when engine is cold, otherwise engine tends to stop.

NOTE :

The engine is warm when it responds normally to the throttle with the Starter Lever in "OFF" direction.

OPERATION AND IMPORTANT RIDING POINTS

Starting a warm engine.

The Starter Lever may not be required when the engine is warm.

CAUTION :
See the "Running-in" section prior to operating the Motorcycle for the first time.

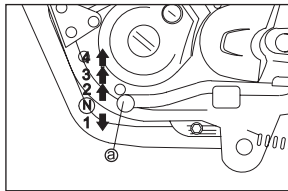

Ⓐ Shift pedal
N. Neutral, 1,2,3,4 Gear Shift Position

Shifting

The transmission lets you control the amount of power you have available at a given speed for starting, accelerating, climbing hills, etc. The use of the shift pedal is shown in the illustration.

To shift into neutral, depress the shift pedal repeatedly until it reaches the end of its travel, then raise the pedal slightly.

CAUTION :

- Do not ride downhill with Ignition Switch in "OFF" Position & in Neutral Gear.
- Always ride motor cycle with Ignition Switch in "ON" Position & in Neutral Gear.
- Always use the clutch when changing gears. The engine, transmission, and driveline are not designed to withstand the shock of forced shifting and can be damaged by shifting without using the clutch.

NEVER RIDE MOTORCYCLE WITH CLUTCH PARTIALLY ENGAGED.

OPERATION AND IMPORTANT RIDING POINTS

Tips for reducing fuel consumption

Your Motorcycle's fuel consumption depends to a large extent on your riding style. The following tips can help reduce fuel consumption:

1. Warm up the engine before riding.
2. Move the strater Lever to "Off" as soon as possible.
3. Shift up swiftly and avoid high engine speeds during acceleration.
4. Do not double-clutch or rev the engine while shifting down and avoid high engine speeds with no load on the engine.
5. Turn off the engine instead of letting it idle for an extended length of time, i.e. in traffic jams, at traffic lights or rail- road crossings.
6. Do not drive with excessive load on the Motorcycle.
7. Plan your route in advance.

8. Avoid frequent braking.
9. Always maintain your tyre pressure as per recommendation
10. Get your motorcycle serviced periodically after every 2000 kms.

Running-in

There is never a more important period in the life of your Motorcycle than the period between zero and 1,000 kms. For this reason we ask that you carefully read the following material. Because the engine is brand new, you must not put an excessive load on it for the first 1,000 kms. The various parts in the engine wear and polish themselves to the correct operating clearances. During this period, prolonged full throttle operation, or any condition which might result in excessive heating of the engine, must be avoided.

CAUTION : _____
Be sure to replace the engine oil as per recommended schedule.

1,000 kms and below :
Avoid prolonged full-throttle operation. Vary speed occasionally.

CAUTION : _____
If any engine trouble should occur during the "Running-in" period, consult a YAMAHA dealer immediately.

OPERATION AND IMPORTANT RIDING POINTS

Parking

When parking the Motorcycle, stop the engine and remove the ignition key. Turn the fuel cock to "OFF" whenever stopping the engine.

▲WARNING

The exhaust system is hot. Park the Motorcycle in a place where pedestrians or children are not likely to touch the Motorcycle. Do not park the Motorcycle on a slope or soft ground; the Motorcycle may overturn.

**IT IS NOT RECOMMENDED TO RIDE THE MOTORCYCLE WITH
CONSTANT THROTTLE OPENING FOR VERY LONG DISTANCE**

PERIODIC MAINTENANCE AND MINOR REPAIR

Periodic inspection, adjustment and lubrication will keep your Motorcycle in the safest and most efficient condition possible. Safety is an obligation of the Motorcycle owner. The maintenance and lubrication schedule chart should be considered strictly as a guide to general maintenance and lubrication intervals. YOU MUST TAKE INTO CONSIDERATION THAT WEATHER, TERRAIN, GEOGRAPHICAL LOCATIONS, AND A VARIETY OF INDIVIDUAL USES ALL TEND TO DEMAND THAT EACH OWNER ALTER THIS TIME SCHEDULE TO SHORTER INTERVALS TO MATCH THE ENVIRONMENT. The most important points of Motorcycle inspection, adjustment, and lubrication are explained in the following pages.

▲WARNING

If you are not familiar with Motorcycle service, this work should be done by a YAMAHA dealer.

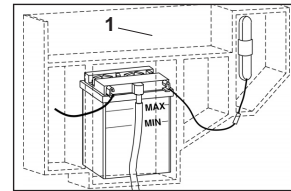

1. Tool kit

Tool kit

The service information included in this manual is intended to provide you, the owner, with the necessary information for completing some of your own preventive maintenance and minor repairs. The tools provided in the owner's tool kit are to assist you in the performance of periodic maintenance. However, some other tools such as a torque wrench are also necessary to perform the maintenance correctly.

PERIODIC MAINTENANCE AND MINOR REPAIR

NOTE :

If you do not have necessary tools required during a service operation, take your Motorcycle to a YAMAHA dealer for service.

▲WARNING

Modifications to this Motorcycle not approved by YAMAHA may cause loss of performance, and render it unsafe for use. Consult a YAMAHA dealer before attempting any changes.

KEEP YOUR MOTORCYCLE TUNED IN PERFECT CONDITION

PERIODIC MAINTENANCE AND MINOR REPAIR

PREVENTIVE MAINTENANCE SCHEDULE

SNO	ITEM	OPERATION	AFTER EVERY DAYS OR KMS			AFTER EVERY 2000 KMS
			30 Days OR 500-700 Km	90 Days OR 2500-2700 Km	180 Days OR 4500-5000 Km	
1	VALVES	Check valve clearances, adjust if necessary.	●	●	●	●
2	SPARK PLUG	Check condition, gap; Clean and reset if necessary.	●	●	●	●
			REPLACE EVERY 10,000 km			
3	CARBURETOR	Check idle speed, Choke lever operation.	●	●	●	●
4	AIR FILTER*	Clean, inspect & lubricate. (replace if necessary)	●	●	●	●
5	FUEL LINE	Check fuel hose, for cracks or damage. Replace if necessary.	●	●	●	●
6	FUEL FILTER	Check for free flow of petrol, cleanliness of filter bowl, replace if necessary.	●	●	●	●
7	ENGINE OIL	Replace with recommended oil - Yamalube SG Grade (Warm engine before draining)	●	●	●	●
8	ENGINE OIL FILTER SCREEN	Wash with petrol	●	●	●	●
9	BRAKE-FRONT & REAR	Check operation./ Adjust if necessary. Grease the brake cam.	●	●	●	●
10	BRAKE SHOES-FRONT & REAR	Check for wear, replace if necessary.	●	●	●	●
11	CLUTCH	Check alignment marks on Push Lever and Crankcase L.H. Adjust if necessary.	●	●	●	●
12	REAR ARM PIVOT	Check Rear Arm assembly for looseness. Tighten with specified Torque if necessary	●	●	●	●
13	WHEELS	Check runout, spoke tightness, damage; Correct it, if necessary.	●	●	●	●

PERIODIC MAINTENANCE AND MINOR REPAIR

PREVENTIVE MAINTENANCE SCHEDULE

S.NO	ITEM	OPERATION	AFTER EVERY DAYS OR KMS			AFTER EVERY 2000 KMS
			30 Days OR 500-700 Km	90 Days OR 2500-2700 Km	180 Days OR 4500-5000 Km	
14	WHEEL BEARING	Check Bearing assembly for looseness, damage; Replace if necessary.	•	•	•	•
		Repack grease	EVERY 10,000 KMS			
15	STEERING BEARING	Check Bearing assembly for looseness; Correct if necessary.	•	•	•	•
		Repack grease	EVERY 10,000 KM			
16	FRONT FORKS	Check operation/oil leakage. Repair if necessary.	•	•	•	•
		Relace oil	EVERY 10,000 KM			
17	REAR SHOCK ABSORBER	Check operation/oil leakage. Replace if necessary.	•	•	•	•
18	DRIVE CHAIN	Check Chain slack, alignment. Adjust if necessary. Clean periodically & lubricate.	•	•	•	•
19	NUTS, BOLTS AND FASTENERS	Check all Chassis fittings and fasteners for looseness. Tighten as per specification.	•	•	•	•
20	CENTERSTAND AND SIDE STAND	Check operation and lubricate if necessary.	•	•	•	•
21	BATTERY	Check electrolyte level and top it up if necessary. Check specific gravity and charge if required. Check breather pipe for blockage and routing.	EVERY MONTH			
22	CONTROL CABLES -THROTTLE -CLUTCH -FRONT BRAKE	Check operation, free play, cable damage Readjust or replace as required.	•	•	•	•

IT IS RECOMMENDED THAT THE ABOVE BE SERVICED BY AUTHORIZED **YAMAHA** DEALER.
* SERVICE MORE FREQUENTLY WHEN THE VEHICLE IS DRIVEN IN DUSTY AREAS.

PERIODIC MAINTENANCE AND MINOR REPAIR

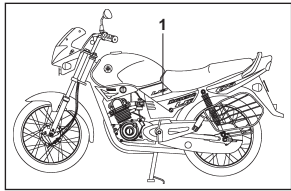

1. Panel A

Panel removal and installation

The panels illustrated need to be removed to perform some of the maintenance described in this manual. Refer to this section each time a panel has to be removed or reinstalled.

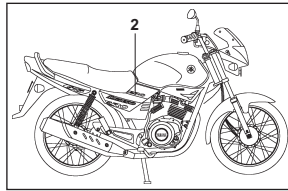

2. Panel B

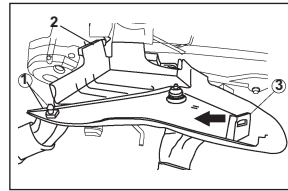

1. Lug
2. Panel A
3. Lug

Removal of Panel A

Unlock the panel.

Pull the lug 1 towards you to remove it from the fuel tank.

Slide the panel A towards the Front of the motorcycle for removing the lug 3 to free the panel.

PERIODIC MAINTENANCE AND MINOR REPAIR

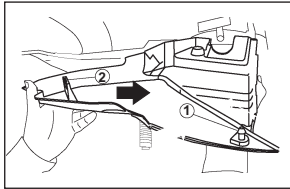

1. Lug
2. Lug

Removal of Panel B

Loosen screw completely and follow the same procedure as for removing panel A.

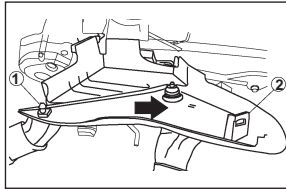

1. Lug
2. Lug

Installation of Panel A

Slide the panel towards the Rear of the motorcycle for inserting the lug ② in the slot given in the frame. Insert and push the lug ① in the fuel tank ensuring proper seating. After proper seating of the panel A, lock it.

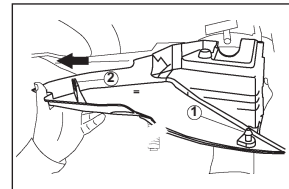

1. Lug
2. Lug

Installation of Panel B

Follow the same procedure as given for installation of panel A and tighten the screw for locking.

PERIODIC MAINTENANCE AND MINOR REPAIR

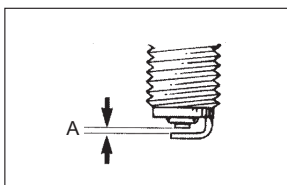

A. Spark plug gap

Spark plug inspection

The spark plug is an important engine component and is easy to inspect. The condition of the spark plug can indicate the condition of the engine. The ideal color on the white insulator around the center electrode is a medium-to-light tan color for a Motorcycle that is being ridden

normally. Do not attempt to diagnose any problems yourself. Instead, take the Motorcycle to a YAMAHA dealer. You should periodically remove and inspect the spark plug because heat and deposits will cause the spark plug to slowly break down and erode. If electrode erosion becomes excessive, or if carbon and other deposits are excessive, you should replace the spark plug with the specified plug.

Specified spark plug:
P-RA7HC-(CHAMPION)

Before installing the spark plug, measure the electrode gap with a wire thickness gauge; adjust the gap to specification as necessary.

A.- Spark plug gap: 0.8 ± 0.1 mm

When installing the plug, always clean the gasket surface and use a new gasket. Wipe off any grime from the threads and tighten the spark plug to the specified torque.

Tightening torque:
Spark plug:
12 ft-lb (1.75 m·kg)

NOTE :

If a torque wrench is not available when you are installing a spark plug, a good estimate of the correct torque is 1/4 to 1/2 turn past finger using a box spanner.

ALWAYS USE ONLY THE STANDARD RECOMMENDED MAKE AND TYPE OF SPARK PLUG

PERIODIC MAINTENANCE AND MINOR REPAIR

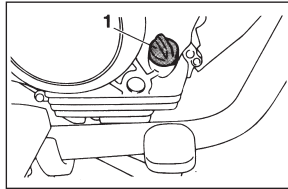

1. Engine oil filler cap

Engine oil

1. Oil level measurement

- Place the Motorcycle on the centerstand. Warm up the engine for several minutes.

NOTE : _____
Be sure the Motorcycle is positioned straight up when checking the oil level. A slight tilt toward the side can result in false readings.

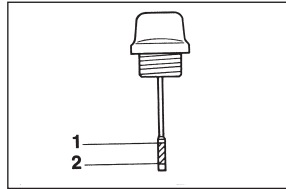

- Maximum level
- Minimum level

NOTE : _____

Wait a few minutes until the oil level settles before checking.

- Unscrew the dipstick and rest it on the threads of the oil filler hole. The oil level should be between the minimum and maximum mark on the dip-stick. If the level is low, add oil to raise it to the specified level.

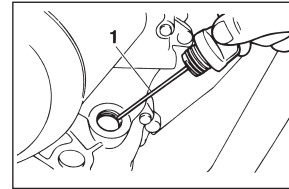

1. Dipstick

2. Engine oil replacement

- Warm up the engine for a few minutes.
- Stop the engine. Place an oil pan under the engine and remove the dipstick.

ALWAYS CHANGE ENGINE OIL AT RECOMMENDED INTERVALS FOR OPTIMUM ENGINE PERFORMANCE AND ENGINE LIFE

PERIODIC MAINTENANCE AND MINOR REPAIR

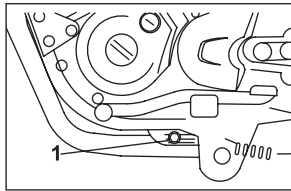

1 . Engine oil drain plug

- c. Remove the drain plug and drain the oil.
- d. Reinstall the drain plug and tighten it to the specified torque.

Tightening torque:
Drain plug:
14.5 ft-lb (2.0 m·kg)

- e. Fill engine with oil and install the dipstick.

Recommended oil:
YAMALUBE 4-stroke motor oil
(20W40 type SG).
Oil quantity:
Total amount:
1.2 L
Periodic oil change:
1.0 L

- f. Start the engine and warm up for a few minutes. While warming up, check for oil leakage. If oil leakage is found, stop the engine immediately and check for the cause.

ALWAYS USE ONLY THE RECOMMENDED GRADE OF ENGINE OIL

PERIODIC MAINTENANCE AND MINOR REPAIR

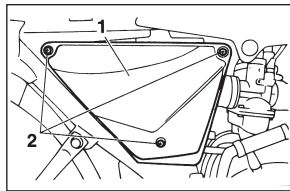

1. Air filter case cover
2. Screw(3 Nos)

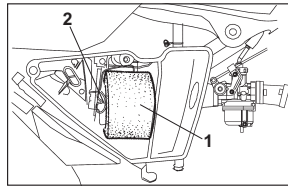

1. Air filter element
2. Lockable SpringWire

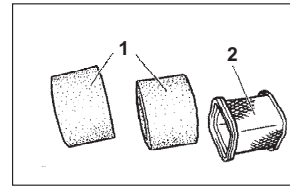

1. Air filter element
2. Frame

Air filter

The air filter should be cleaned at the specified intervals. It should be cleaned more frequently when riding in unusually wet or dusty areas.

1. Remove panel B. (See page 6-5 for removal and installation procedures.)
2. Remove the air filter case fitting screws and the air filter case cover.

3. Remove the air filter from the case.
4. Unlock the spring wire.

6. Apply recommended oil to the entire surface of the each element and squeeze out the excess oil. They should be wet but not dripping.

Recommended oil:
20W40 Type SG

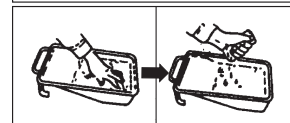

PERIODIC MAINTENANCE AND MINOR REPAIR`

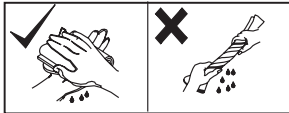

7. Pull the air filter elements over the frame and install the air filter in the case.
8. Install the Spring Wire
9. Install the air filter case cover and panel

CAUTION : _____
Do not twist Element Air Cleaner.

NOTE : _____
Ensure no distortion/proper positioning of felt Seal ① , if damaged contact YAMAHA Dealer.

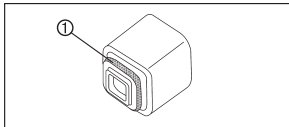

CAUTION : _____

- Make sure the air filter is properly seated in the air filter case.
- The engine should never be run without the air filter installed. Excessive piston and/or cylinder wear may result.
- Dirty Element Air Cleaner causes excessive fuel consumption and loss of power.
- Clean Element Air Cleaner after every 2000 Kms.
- The Element Air Cleaner should be cleaned and lubricated more frequently (every 1000 kms), if Motorcycle is operated in very dusty (e.g. unpaved, dust laden roads) conditions.

Carburetor adjustment

The carburetor is a vital part of the engine and requires very sophisticated adjustments. Most adjustments should be left to a YAMAHA dealer who has the professional knowledge and experience to do so. However, the following may be serviced by the owner as part of routine maintenance.

CAUTION : _____
The carburetor is set at the YAMAHA factory after many tests. If the settings are changed, poor engine performance and damage may result.

PERIODIC MAINTENANCE AND MINOR REPAIR

Idle speed adjustment

NOTE : _____

A diagnostic tachometer must be used for this procedure.

1. Attach the tachometer. Start the engine and warm it up for a few minutes at approximately 1,300 to 1,500 r/min. Occasionally rev the engine to 4,000 to 5,000 r/min. The engine is warm when it quickly responds to the throttle.

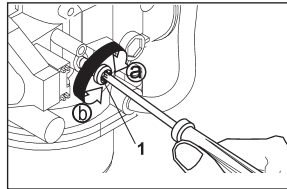

1. Throttle stop screw

2. Set the idle to the specified engine speed by adjusting the throttle stop screw. Turn the screw in direction (a) to increase engine speed and in direction (b) to decrease engine speed.

Standard idle speed:
1,300 ~ 1,500 r/min

NOTE : _____

If the specified idle speed cannot be obtained by performing the above adjustment, consult a **YAMAHA** dealer.

Throttle cable free play adjustment

NOTE : _____

Before checking the throttle cable free play, the engine idling speed should be adjusted.

Adjust the throttle cable by turning the adjusting nut so that specified free play at the throttle grip is obtained.

Free play:
3 ~ 7mm

PERIODIC MAINTENANCE AND MINOR REPAIR

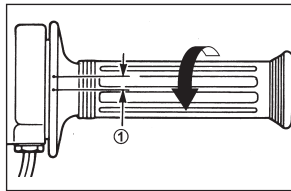

1. Free play

1. Loosen the locknut.
2. Turn the adjusting nut in direction **a** to increase free play and in direction **b** to decrease free play.
3. Tighten the locknut.

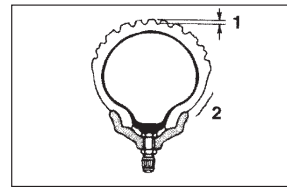

1. Tread depth
2. Side wall

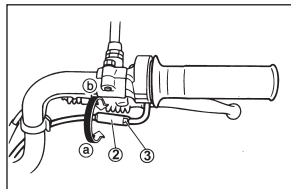

2. Locknut
3. Adjusting nut

Valve clearance adjustment

The correct valve clearance changes with use, resulting in improper fuel/air supply or engine noise. To prevent this, the valve clearance must be adjusted regularly. This adjustment however, should be left to a YAMAHA dealer.

Tyres

To ensure maximum performance, long service and safe operation, note the following:

1. Tyre air pressure
Always check and correct the tyre pressure before operating the Motorcycle.

KEEP RECOMMENDED TYRE PRESSURE IN BOTH THE TYRES

PERIODIC MAINTENANCE AND MINOR REPAIR

▲WARNING

Tyre inflation pressure should be checked and adjusted when the temperature of the tyre equals the ambient air temperature. Tyre inflation pressure must be adjusted according to total weight of cargo, rider, passenger, and accessories (fairing, saddlebags, etc. approved for this model), and vehicle speed.

Cold tyre pressure:	Front	Rear
Single Rider	25 psi (1.75kg/cm ²)	33 psi (2.25kg/cm ²)
With Pillion Rider	25 psi (1.75kg/cm ²)	36 psi (2.50kg/cm ²)

▲WARNING

Proper loading of your Motorcycle is important for several characteristics of your Motorcycle, such as handling, braking, performance and safety. Do not carry loosely packed items that can shift. Securely pack your heaviest items close to the center of the Motorcycle, and distribute the weight evenly from side to side. Properly adjust the suspension for your load, and check the condition and pressure of your tyres. **NEVER OVERLOAD YOUR MOTORCYCLE.** Make sure the total weight of the cargo, rider, passenger, and accessories (fairing, saddlebags, etc. approved for this model) does not exceed the maximum load of the Motorcycle. Operation of an overloaded Motorcycle could cause tyre damage, an accident, or even injury.

2. Tyre inspection

Always check the tyres before operating the Motorcycle. If a tyre tread shows crosswise lines (minimum tread depth), if the tyre has a nail or glass fragments in it, or if the side wall is cracked, contact a **YAMAHA** dealer immediately and have the tyre replaced.

Front tyre size:

2.75-18" 4PR

Rear tyre size:

3.00-18" 6PR

Minimum tyre
tread depth:
(front and rear)

1.0 mm

PERIODIC MAINTENANCE AND MINOR REPAIR

▲WARNING

1. It is dangerous to ride with a worn-out tyre. When a tyre tread begins to show lines, have a YAMAHA dealer replace the tyre immediately.

Wheels

To ensure maximum performance, long service, and safe operation, note the following:

1. Always inspect the wheels before a ride. Check for cracks, bends or warpage of the wheel. Be sure the spokes are tight and undamaged. If any abnormal condition exists in a wheel, consult a YAMAHA dealer. Do not attempt even small repairs to the wheel. If a wheel is deformed or cracked, it must be replaced.
2. Tyres and wheels should be balanced whenever either one is changed or replaced. Failure to have a wheel balanced can result in poor performance, adverse handling characteristics, and shortened tyre life.
3. Ride at moderate speeds after changing a tyre since the tyre surface must first be broken in for it to develop its optimal characteristics.

PERIODIC MAINTENANCE AND MINOR REPAIR

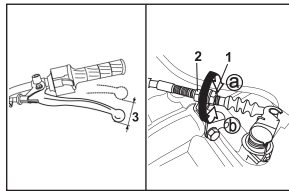

1. Locknut
2. Adjusting nut
3. Free play

Clutch lever free play adjustment

The clutch lever free play should be adjusted to 10 ~ 15 mm. If the free play is incorrect, adjust as follows.

1. Loosen the locknut.
2. Turn the adjusting nut in direction (a) to increase free play or in direction (b) to decrease free play.
3. Tighten the locknut.

NOTE :

If proper adjustment cannot be obtained or the clutch does not work correctly, ask a **YAMAHA** dealer to inspect the internal clutch mechanism.

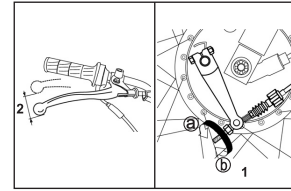

1. Adjusting nut
2. Free play

Front brake adjustment

The front brake lever free play should be adjusted to 10 ~ 15 mm.

1. Turn the adjusting nut in direction (a) to increase free play and direction (b) to decrease free play.

WARNING

When it is impossible to make the proper adjustment, ask a YAMAHA dealer.

PERIODIC MAINTENANCE AND MINOR REPAIR

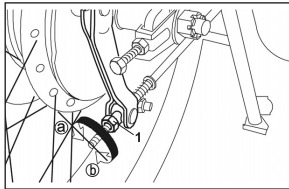

1. Adjusting Nut

Rear brake adjustment

The rear brake pedal free play should be adjusted to 20 ~ 30 mm at the brake pedal end. Turn the adjusting nut in direction ⓐ to increase free play and in direction ⓑ to decrease free play.

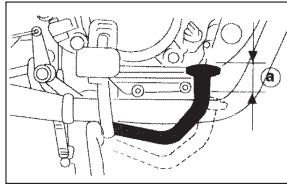

a. Freeplay

⚠WARNING

- **When it is impossible to make the proper adjustment, ask a YAMAHA dealer.**
- **Check the operation of the brake light after adjusting the rear brake.**

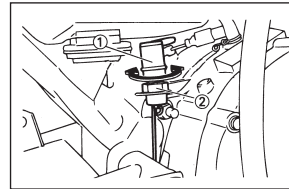

1. Brake light switch
2. Adjusting nut

Brake light switch adjustment

The rear brake light switch is activated by the brake pedal and is properly adjusted when the brake light comes on just before braking takes effect. To adjust the rear brake light switch, hold the switch body so it does not rotate while turning the adjusting nut.

Turn the adjusting nut in direction ⓐ to make the brake light come on earlier.

Turn the adjusting nut in direction ⓑ to make the brake light come on later.

PERIODIC MAINTENANCE AND MINOR REPAIR

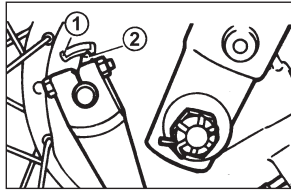

1. Wear limit line
2. Wear indicator

Checking the brake shoes

A wear indicator is provided on each brake. This indicator allows inspection of shoe wear without disassembling the brake. Apply the brake and inspect the position of the indicator. If the indicator reaches to the wear limit line, ask a YAMAHA dealer to replace the shoes.

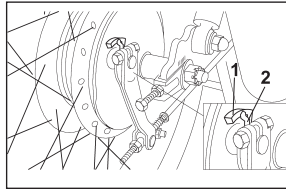

1. Wear limit line
2. Wear indicator

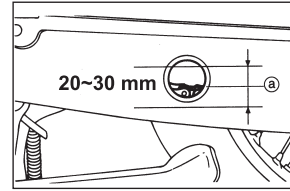

1. Free play

Drive chain slack check

NOTE :

Spin the wheel several times and find the tightest position of the chain. Check and/or adjust the chain slack while it's in this tightest position.

Inspect the drive chain when the Motorcycle is on the centerstand. Check the slack at the position shown in the illustration. Normal slack is approximately 20 ~ 30 mm. If the slack exceeds 30 mm, adjust.

PERIODIC MAINTENANCE AND MINOR REPAIR

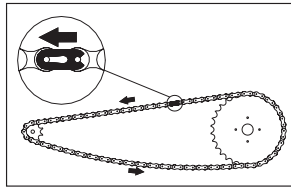

1. Chain joint

If the chain is disassembled, be sure the chain lock is placed in the correct direction when installing.

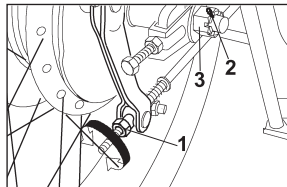

1. Adjusting nut
2. Cotter pin
3. Axle nut

Drive chain slack adjustment

1. Loosen the rear brake pedal free play adjusting nut.
2. Remove the cotter pin from the axle nut.
3. Loosen the axle nut.

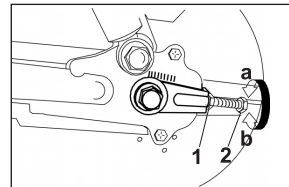

1. Locknut
2. Adjusting hex screw

4. Loosen the chain adjusting locknuts on each chain puller. To tighten the chain, turn the chain adjusting hex screw in direction (b) to loosen the chain, turn the chain adjusting hex screw in direction (a) and push the wheel forward. Turn each chain adjusting hex screw exactly the same amount to maintain correct axle alignment. There are marks on each chain puller. Use these marks to align the rear wheel.

PERIODIC MAINTENANCE AND MINOR REPAIR

CAUTION :

- Maintain chain slackness within specified limits as per specifications.
- To maintain correct axle alignment, Ensure the notch on the adjuster is on the same Mark on Left and Right Side.

5. After adjusting, be sure to tighten each chain adjusting locknut. Then tighten the axle nut to the specified torque.

Tightening torque:
Axle nut:
65 ft-lb (9.05 m-kg)

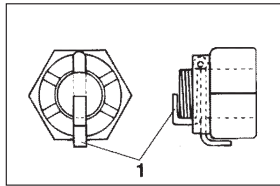

1. Cotter pin

6. Insert a new cotter pin into the axle nut and bend the end of the cotter pin as shown. If the notch in the axle nut and the cotter pin hole do not match, tighten the nut slightly to align them.

WARNING

Always use a new cotter pin on the axle nut.

7. Adjust the free play in the brake pedal.

WARNING

Check the operation of the brake light after adjusting the rear brake.

PERIODIC MAINTENANCE AND MINOR REPAIR

Drive chain lubrication

The chain consists of many parts which work with each other. If the chain is not maintained properly, it will wear out quickly. Therefore, the chain must be serviced regularly. This service is especially necessary when riding in dusty areas.

1. The drive chain should be lubricated every 5,000 km.
2. To clean the chain thoroughly, remove it from the Motorcycle, dip it in solvent, and clean out as much dirt as possible. Then, take the chain out of the solvent to dry it, and then dip the chain in oil of 20W40. Remove the chain and hang it on a peg for a while till the excess oil drips down completely. Then using a clean cloth wipe the chain.

Cable inspection and lubrication

▲WARNING
Damage to the outer housing of cables may lead to internal rusting and interfere with the cable movement. Replace damaged cables as soon as possible to prevent unsafe conditions.

Lubricate the cables with anti-corrosive oil and cable ends. If a cable does not operate smoothly, ask a YAMAHA dealer to replace it.

Recommended lubricant: 20W40 Type SG

Throttle cable and grip lubrication

The throttle twist grip assembly should be greased at the time that the cable is lubricated, since the grip must be removed to get at the end of the throttle cable. After removing the screws, hold the end of the cable up in the air and put in several drops of lubricant. With the throttle grip disassembled, coat the metal surface of the grip assembly with a suitable all purpose grease.

PERIODIC MAINTENANCE AND MINOR REPAIR

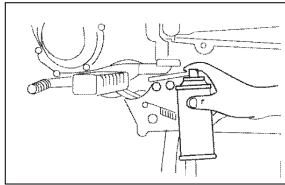

Brake and shift pedal lubrication

Lubricate the pivoting parts.

Recommended lubricant:
20W40 Type SG

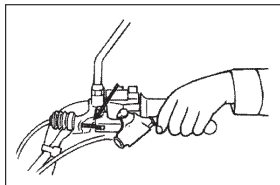

Brake and Clutch Lever Greasing

Grease the pivoting parts.

Recommended Grease :
MULTIPURPOSE

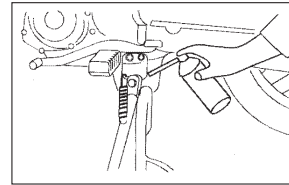

Center and sidestand lubrication

Lubricate the pivoting and mating joints.

Check to see that the center and sidestand move up and down smoothly.

Recommended lubricant:
20W40 Type SG

▲WARNING

If the center and/or sidestand does not move smoothly, consult a YAMAHA dealer.

PERIODIC MAINTENANCE AND MINOR REPAIR

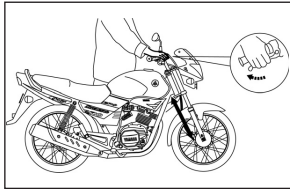

Front fork inspection

▲WARNING
Securely support the Motorcycle so there is no danger of it falling over.

1. Visual check
Check for scratches or damage on the inner tube and traces of oil leakage from the front fork.

2. Operation check
Place the Motorcycle on a level place.
 - a. Hold the Motorcycle in an upright position and apply the front brake.
 - b. Push down hard on the handlebars several times and check if the fork rebounds smoothly.

CAUTION :
If any damage or unsmooth movement is found with the front fork, consult a YAMAHA dealer.

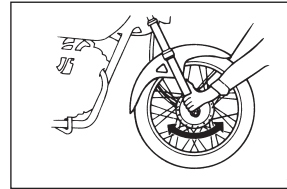

Steering inspection

Periodically inspect the condition of the steering. Worn out or loose steering bearings may be dangerous. Place a stand under the engine to raise the front wheel off the ground. Hold the lower end of the front forks and try to move them forward and backward. If any free play can be felt, ask a YAMAHA dealer to inspect and adjust the steering. Inspection is easier if the front wheel is removed.

PERIODIC MAINTENANCE AND MINOR REPAIR

▲WARNING

Securely support the Motorcycle so there is no danger of it falling over.

Wheel bearings

If there is play in the front or rear wheel hub or if the wheel does not turn smoothly, have a YAMAHA dealer inspect the wheel bearings.

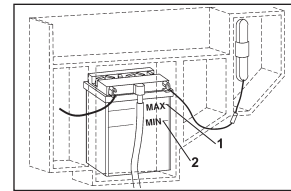

1. Maximum level mark
2. Minimum level mark

Battery

1. Battery is located inside the L.H. side panel (for removal & installation of L.H. side panel please refer page 6-5)
2. Open the lid.
3. Check the level of the battery electrolyte and make sure that the terminals are tight.

Top up with distilled water if the electrolyte level is low.

PERIODIC MAINTENANCE AND MINOR REPAIR

CAUTION : _____
When inspecting the battery, be sure the breather hose is routed correctly. If the breather hose is positioned in such a way as to cause battery electrolyte or gas to exit onto the frame, structural and cosmetic damage to the Motorcycle can occur.

Battery electrolyte is poisonous and dangerous, causing severe burns, etc. It contains sulfuric acid. Avoid contact with skin, eyes or clothing.

Antidote:
EXTERNAL: Flush with water.
INTERNAL: Drink large quantities of water or milk. Follow with milk of magnesia, beaten egg, or vegetable oil. Call a physician immediately. **EYES:** Flush with water for 15 minutes and get prompt medical attention. Batteries produce explosive gases. Keep sparks, flame, cigarettes etc., away. Ventilate when charging or using in an enclosed space. Always shield your eyes when working near batteries. **KEEP OUT OF REACH OF CHILDREN.**

Replenishing the battery fluid
A poorly maintained battery will corrode and discharge quickly. The battery fluid should be checked at least once a month. The level should be between the minimum level and maximum level marks. Use only distilled water if refilling is necessary.

CAUTION : _____
Normal tap water contains minerals which are harmful to a battery; therefore, refill only with distilled water.

⚠WARNING _____
Take care not to spill battery fluid on the chain. Battery fluid may weaken the chain causing shorter chain life and possibly result in an accident

ENSURE THAT BATTERY ELECTROLYTE LEVEL IS MAINTAINED BETWEEN MAX . AND MIN. MARKS. IF REQUIRED, ADD DISTILLED WATER ONLY

PERIODIC MAINTENANCE AND MINOR REPAIR

Battery storage

1. When the Motorcycle will not be used for a month or longer, remove the battery, fully charge it and store it in a cool, dry place. Completely recharge the battery before reinstallation.
2. If the battery will be stored for longer than two months, check the specific gravity of the fluid at least once a month and fully recharge the battery when it is too low.
3. Always make sure the connections are correct when putting the battery back in the motorcycle. Make sure the breather hose is properly connected and is not damaged or obstructed.

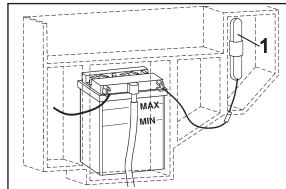

1. Main fuse

CAUTION :

Do not use fuse of higher amperage rating than those recommended. Substitution of a fuse of improper rating can cause extensive electrical system damage and possibly a fire.

Specified fuse: 10A

Fuse replacement

The fuse is located behind panel A. (See page 6-6 for panel removal and installation procedures.)

If the fuse is blown, turn off the main switch. Install a new fuse of proper amperage. Turn on the switches and see if the electrical device operates. If the fuse immediately blows again, consult a YAMAHA dealer.

PERIODIC MAINTENANCE AND MINOR REPAIR

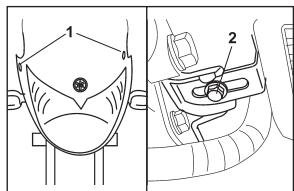

1. Screw (2 Nos.)

2. Bolt (1 No.)

Headlight bulb replacement

If the headlight bulb burns out, replace the bulb as follows:

1. Remove the two screws from the Head Light.
2. Loosen bolt.
3. Remove head light bezel assy. Forward.

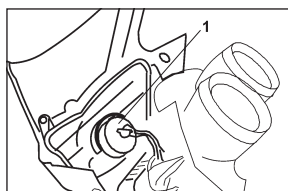

1. Bulb holder

3. Remove headlight bulb holder from bezel

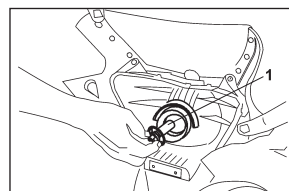

1. Bulb (Halogen)

▲WARNING

Keep flammable products and your hands away from the bulb while it is on, as it is hot. Do not touch the bulb until it cools down.

4. Remove the defective bulb.
5. Put a new bulb into position and secure it in place with the bulb holder.
6. Install the Head Light Assy.
7. If the headlight beam adjustment is necessary, ask a YAMAHA dealer to make adjustment.

PERIODIC MAINTENANCE AND MINOR REPAIR

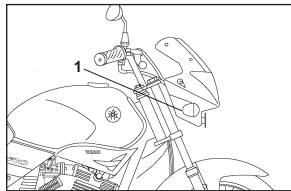

1. Indicator Screws (1 No.)

Turn signal and taillight bulb replacement

1. Remove the screws and the lense.
2. Push the bulb inward and turn it counterclockwise.
3. Place a new bulb in the socket. Push the bulb inward and turn it clockwise until it engages into the socket.
4. Install the lense and the screws.

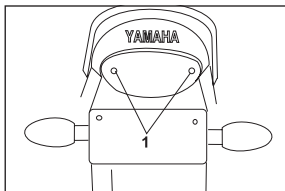

1. Tail lamp Screws (2 Nos.)

CAUTION :

Do not over-tighten the screws as the lense may break.

Front wheel removal

▲WARNING

- It is advisable to have a YAMAHA dealer service the wheel.
- Securely support the Motorcycle so there is no danger of it falling over.

PERIODIC MAINTENANCE AND MINOR REPAIR

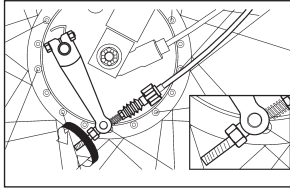

1. Brake cable adjusting nut
1. Place the Motorcycle on the centerstand.
2. Fully loosen the brake cable adjusting bolt at the handlebar lever holder.
- 3 Fully loosen the brake cable adjusting nut at the wheel hub and remove the cable from the brake cam lever.

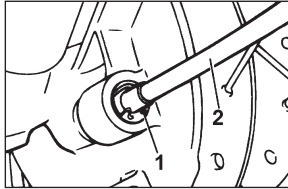

1. Clip
2. Speedometer cable
4. Remove the speedometer cable from the front wheel side. First remove the clip and then pull the cable out.

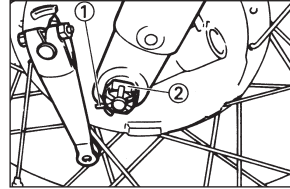

1. Cotter pin
2. Axle nut
5. Remove the cotter pin and axle nut.
6. Remove the wheel axle. Make sure the Motorcycle is properly supported.

PERIODIC MAINTENANCE AND MINOR REPAIR

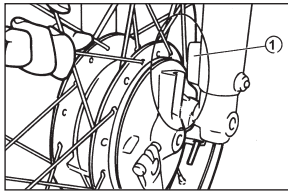

1. Stopper

Front wheel installation

When installing the front wheel, reverse the removal procedure.

Pay attention to the following points:

1. Make sure the slot in the brake shoe plate fits over the stopper on the front fork outer tube.
2. Make sure the axle nut is properly torqued and a new cotter pin is installed.

▲WARNING

Always use a new cotter pin.

Axle nut torque:
33 ft-lb (4.55 m-kg)

3. Adjust the free play in the brake lever.

Rear wheel removal

▲WARNING

- It is advisable to service the wheel by a YAMAHA dealer.
- Securely support the Motorcycle so there is no danger of it falling over.

PERIODIC MAINTENANCE AND MINOR REPAIR

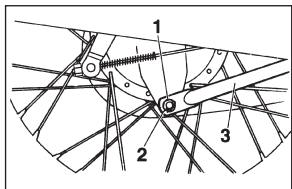

1. Nut
2. Cotter pin
3. Tension bar

1. Place the Motorcycle on the centerstand.
2. Remove the cotter pin and nut. Then remove the tension bar from the brake shoe plate.

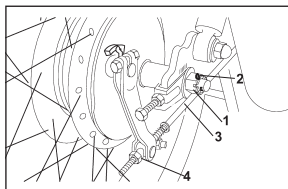

1. Axle nut
2. Cotter pin
3. Brake rod
4. Brake adjusting nut

3. Remove the brake adjusting nut and brake rod from the brake cam lever.
4. Remove the axle nut cotter pin and the axle nut.

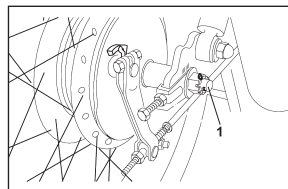

1. Rear axle
5. Pull out the rear axle.
6. Remove the wheel assembly.

ALWAYS USE YAMAHA GENUINE SPARE PARTS

PERIODIC MAINTENANCE AND MINOR REPAIR

Rear wheel installation

1. Install the rear wheel and the axle.
2. Install the axle nut.
3. Insert the brake rod into the brake cam lever and install the brake free play adjusting nut.
4. Install the tension bar onto the brake shoe plate and tighten the tension bar nut to the specified tightening torque.
5. Take the Motorcycle off the centerstand.
6. Tighten the axle nut to the specified tightening torque. Then install a new cotter pin.

Specified torque:

Tension bar nut:

14 ft-lb (1.9 m kg)

Axle nut:

65 ft-lb (9.05 m kg)

▲WARNING

Always use a new cotter pin.

7. Adjust the rear brake pedal free play. (See page 6-17.)

▲WARNING

Check the operation of the brake light after adjusting the rear brake.

Troubleshooting

Although YAMAHA Motorcycles receive a rigid inspection before shipment from the factory, trouble may occur during operation. Any problem in the fuel, compression, or ignition systems can cause poor starting and loss of power. The troubleshooting chart describes a quick, easy procedure for making checks. If your Motorcycle requires any repair, bring it to a YAMAHA dealer. The skilled technicians at a YAMAHA dealership have the tools, experience, and know-how to properly service your Motorcycle.

Use only genuine YAMAHA parts on your Motorcycle. Imitation parts may look like YAMAHA parts, but they are often inferior. Consequently, they have a shorter service life and can lead to expensive repair bills.

PERIODIC MAINTENANCE AND MINOR REPAIR

Troubleshooting chart - For Starting

⚠WARNING

Never Check the fuel system while smoking or in the vicinity of an open flame.

1. Fuel

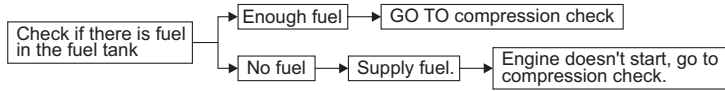

2. Compression

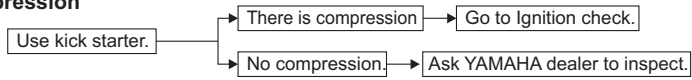

3. Ignition

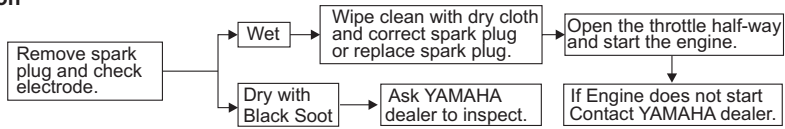

CLEANING AND STORAGE

A. CLEANING

Frequent, thorough cleaning of your Motorcycle will not only enhance its appearance but will improve its general performance and extend the useful life of many components.

CAUTION : _____

- **Improper cleaning can damage the cowlings, panels and other plastic parts. Use only a soft, clean cloth or sponge with mild detergent and water to clean plastic.**
 - **Do not use any harsh chemical products on plastic parts. Always use clean cloth or sponge for cleaning the Motorcycle.**
-

1. Before cleaning the Motorcycle:

- a. Block off the end of the exhaust pipe to prevent water entry; a plastic bag and strong rubber band may be used.
 - b. Make sure the spark plug and all filler caps are properly installed.
2. If the engine case is excessively greasy, apply degreaser with a paint brush. Do not apply degreaser to the chain, sprockets, or wheel axles.
 3. Rinse the dirt and degreaser off with a garden hose. Use only enough pressure to do the job.

CAUTION : _____

Direct excessive Hose Pressure may cause water Entry Into Wheel Bearing, Front Fork Brakes, Transmission Seals & Electrical Parts, there-by leading to its Detorioration.

4. After riding on dirty roads, wash the Motorcycle with cold water immediately. Do not use warm water to clean the tyre.
5. Once the majority of the dirt has been hosed off, wash all surfaces with warm water and mild, detergent-type soap. An old toothbrush or bottle brush is handy for hard-to-get-at places.
6. Rinse the Motorcycle off immediately with clean water and dry all surfaces with a chamois, clean towel, or soft absorbent cloth.
7. Dry the chain and lubricate it to prevent rust.

CLEANING AND STORAGE

8. Clean the seat with a vinyl upholstery cleaner to keep the cover pliable and glossy.
9. Automotive-type wax may be applied to all painted and chrome-plated surfaces. Avoid combination cleaner waxes. Many contain abrasive which may mar the paint or protective finish. When finished, start the engine and let it idle for several minutes.

B. STORAGE

Long term storage (60 days or more) of your Motorcycle will require some preventive procedures to guard against deterioration. After thoroughly cleaning the Motorcycle, prepare for storage as follows:

1. Drain the fuel tank, fuel lines, and carburetor float bowl.
2. Remove the empty fuel tank, pour a cup of SAE 10W30 or 20W40 motor oil in the tank, shake the tank to coat the inner surfaces thoroughly and drain off the excess oil. Reinstall the tank.
3. Remove the spark plug, pour about one tablespoon of SAE 10W30 or 20W40 motor oil in the spark plug hole and reinstall the spark plug. Kick the engine over several times (with the ignition off) to coat the cylinder wall with oil.
4. Remove the drive chain. Thoroughly clean the chain with solvent and lubricate it. Reinstall the chain or store it in a plastic bag (tied to frame for safe-keeping).

5. Lubricate all control cables.
6. Block up the frame to raise both wheels off the ground.
7. Tie a plastic bag over the exhaust pipe outlet to prevent moisture from entering.
8. If storing in a humid or salt-air atmosphere, coat all exposed metal surfaces with a light film of oil. Do not apply oil to any rubber parts or the seat cover.
9. Remove the battery and charge it. Store it in a dry place and recharge it once a month. Do not store the battery in an excessively warm or cold place (less than 0°C or more than Ambient).

NOTE : _____
Make any necessary repairs before storing the Motorcycle.

SPECIFICATIONS

Specifications

Model	LIBERO (5TS8)
Dimensions:	
Overall length	2,000 mm
Overall width	730 mm
Overall height	1,050 mm
Seat height (Upto Rider)	800 mm
(Upto Pillion Rider)	850 mm
Wheelbase	1,290 mm
Ground clearance	173 mm
Minimum turning radius	2,000 mm
Kerb weight : (With Engine Oil & 90% Fuel in Tank)-	119Kg.
Engine :	
Engine type	Air cooled 4-stroke, SOHC
Cylinder arrangement	Forward inclined single cylinder
Displacement	106 cm ³
Bore x Stroke	49X56 mm
Compression ratio	9 : 1
Starting system	Kick starter
Lubrication system	Wet sump
Maximum power	7.6 PS (5.59 KW) @ 7500RPM
Maximum torque	0.80 Kgm. @ 6000 RPM

Engine Oil:	
Type:	YAMALUBE 4-Stroke motor oil (20W40 type SG)

CAUTION :

Be sure to use motor oils that do not contain antifriction modifiers. Passenger car motor oils (often labelled Energy conserving) contain anti-friction additives which will cause clutch and/or starter clutch slippage, resulting in reduced component life and poor engine performance.

Capacity :	
Periodic oil change	1.0 L
Total amount	1.2 L (First fill/Overhaul)

Air filter:	Wet type element
--------------------	------------------

Fuel :	
Type	Gasoline (Petrol)
Fuel tank capacity	13.0 Litres
Reserve amount	1.7 Litres

Carburettor:	
Type	Variable Venturi Type
Manufacturer	M/S Keihin Fie Private Limited India.

SPECIFICATIONS

Spark plug :

Type/Manufacturer P-RA7HC--(CHAMPION)
Spark plug gap 0.8 ± 0.1 mm

Clutch type : Wet, multiple-disc

Transmission :

Primary reduction system	Spur gear
Primary reduction ratio	3.722 (67/18)
Secondary reduction system	Chain drive
Secondary reduction ratio	3.214 (45/14)
Transmission type	Constant mesh 4 speed
Operation	Left foot operation
Gear ratio	1st 3.000 (33/11)
	2nd 1.688 (27/16)
	3rd 1.200 (24/20)
	4th 0.875 (21/24)

Chassis:

Frame type	Double Cradle
Caster angle	26.4°
Trail	91mm

Tyre with Tube

Size	
Front	2.75 x18" 4PR
Rear	3.00 X18" 6PR

Air pressure (cold tyre):

Single Rider

Front	25 psi (1.75 Kg/cm ²)
Rear	33 psi (2.25Kg/cm ²)

With Pillion and rider

Front	25 psi (1.75Kg/cm ²)
Rear	36 psi (2.5 Kg/cm ²)

SPECIFICATIONS

Wheels:

Type:		
	Front	Spoke wheel
	Rear	Spoke wheel
Size:		
	Front	1.60 X 18
	Rear	1.60 X 18

Brakes:

Front :		
	Type	Drum brake
	Operation	Right Hand lever
Rear :		
	Type	Drum brake
	Operation	Right foot operation

Suspension :

Front	Telescopic fork
Rear	Swing arm

Shock absorber:

Front	Coil spring/ oil damper
Rear	Coil spring/ oil damper

Wheel travel:

Front	120 mm
Rear:	90 mm

Electrical:

Ignition system:	CDI (Digitally Timing Advanced)
------------------	---------------------------------

Generator system:

Type	Flywheel magneto
Standard output	12V

Battery:

Type	Lead acid
Voltage, capacity	12V 2.5AH

Bulb voltage ,Wattage x Quantity:

Headlight (Halogen-HS1)	12V 35W/ 35W x 1
Tail / Brake light	12V 5W/21W x 1
Front flasher light	12V 10 W x 2
Rear flasher light	12V 10 W x 2
Meter light	12V 3.4 W x 2
Neutral indicator light	12V 3.4 W x 1
High beam indicator light	12V 3.4 W x 1
Turn indicator light	12V 1.7 W x 2
Tuning Fork Logo	12V 3.4 W x 1

Fuse:

Main	10A
------	-----

CUSTOMER INFORMATION

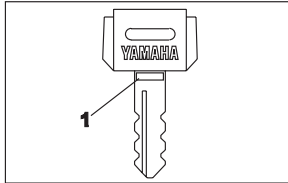

1. Key identification number

Key identification number

The key identification number is stamped on the key. Record this number in the space provided and use it for reference when obtaining a new key.

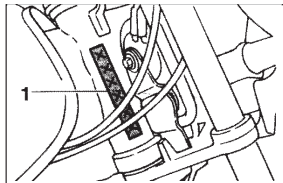

1. Frame serial number

Frame serial number

The frame serial number is stamped into the steering head pipe on right hand side.

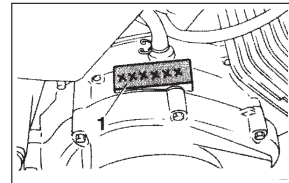

1. Engine serial number

Engine serial number

The engine serial number is stamped into the right hand crankcase.

PRE-DELIVERY INSPECTION REPORT

(To be filled in by the Dealer on receipt of the Motorcycle from YMIS)

No.	
-----	--

Frame No.	Engine No.	Odo-Meter Reading	Date of Inspection	Date of Sale

1. Check for any missing item(s), scratches in painted/plated part(s), saddle or other external visual damages and take corrective action.
 Check each of the following items individually and mention the corrective action (as per the recommended specifications) in the boxes provided.

Found OK
 Set Right
 Replaced
 Cleaned
 Lubricated

2. Check for missing part(s), if any.

A. FRAME

a. Brakes

Front : Free Play at Lever End (10 ~ 15 mm)
 Rear : Free Play at Rear Brake (20 ~ 30 mm)

b. Clutch : Free Play at Lever End (10 ~ 15 mm)

c. Throttle : Free Play at Throttle Grip (3 ~7 mm)

d. Steering : Check for Free Movement

e. Suspension

Front Fork : Check for any sticky movement

Rear Shock Abs : For Free Stroking & Setting on both

PRE-DELIVERY INSPECTION REPORT

f. Wheels			
Tyre	: Tyre pressure (PSI)	Solo	Double
	Front	25	25 <input type="checkbox"/>
	Rear	33	36 <input type="checkbox"/>
Rim	: Runout	- Radial - 1.5 mm (Max)	<input type="checkbox"/>
		- Lateral - 1.5 mm (Max)	<input type="checkbox"/>
	Spokes	: No loosenes	<input type="checkbox"/>
g. Locks Operation	:	<ul style="list-style-type: none"> • Ignition <input type="checkbox"/> • Steering <input type="checkbox"/> • Fuel Tank Cap <input type="checkbox"/> • Side Cover (L.H.) <input type="checkbox"/> 	
h. Fasteners		Specified Torque (Ft-Lb)	
	1. Front Wheel Axle Nuts	25-40	<input type="checkbox"/>
	2. Front Fork (Crown Handle & Inner Tube)	13-20	<input type="checkbox"/>
	2. Front Fork under Bracket Stem Nut	18-22	<input type="checkbox"/>
	3. Handle Bar Mounting Bolts	13-20	<input type="checkbox"/>
	4. Rear Shock Absorber Mounting Bolts	22-35	<input type="checkbox"/>
	5. Rear Swing Arm Pivot Shaft Nut	32-52	<input type="checkbox"/>
	6. Rear Wheel Axle/Sprocket. Shaft Nuts	60-70	<input type="checkbox"/>
B. ENGINE			
a. Engine Oil	:	<ul style="list-style-type: none"> • Oil Level (For checking - Refer Pg. 6-9) <input type="checkbox"/> • Check for any Leakages <input type="checkbox"/> 	

10-2

PRE-DELIVERY INSPECTION REPORT

- | | | |
|--|---|--------------------------|
| b. Spark Plug | : Recommended No. P-RA7HC(Champion) | <input type="checkbox"/> |
| | Gap 0.8 ±0.1 mm | <input type="checkbox"/> |
| c. Valve Clearance | : (Cold condition) | |
| (If required) | Inlet 0.08 ~ 0.12 mm | <input type="checkbox"/> |
| | Exhaust 0.10 ~ 0.14 mm | <input type="checkbox"/> |
| | (After matching of the mark on sprocket cam chain with mark on Cylinder Head Casting and ensuring the Piston at TDC of compression stroke.) | |
| d. Kick Operation | : For free Movement | <input type="checkbox"/> |
| e. Carburetor | : • Idle RPM <i>In warmed up condition</i> (1300~1500 RPM) | <input type="checkbox"/> |
| | • Check for Overflow | <input type="checkbox"/> |
| f. Drive Chain | : • Alignment | <input type="checkbox"/> |
| | • Slackness (20 ~ 30 mm) | <input type="checkbox"/> |
| g. Fasteners | Specified Torque (Ft-Lb) | |
| 1. Cylinder Head Bolts | 14-17 | <input type="checkbox"/> |
| 2. Engine Mounting | | |
| a) Engine Mounting Front and Stay Front | 25-29 | <input type="checkbox"/> |
| b) Stay Engine Front and Frame | 25-29 | <input type="checkbox"/> |
| c) Engine Mounting Rear and Frame | 25-29 | <input type="checkbox"/> |
| d) Engine Mounting Upper & Stay Engine Upper | 25-29 | <input type="checkbox"/> |
| e) Stay Engine Upper and Frame | 25-29 | <input type="checkbox"/> |
| f) Engine Mounting Front Lower and Frame | 25-29 | <input type="checkbox"/> |
| 3. Front and Rear Silencer Mounting Nut | 9-12 | <input type="checkbox"/> |
| 4. Crown Handle Centre Bolt | 8-14 | <input type="checkbox"/> |

10-3

PRE-DELIVERY INSPECTION REPORT

C. ELECTRICAL

- a. Ignition Switch Operation
- b. Left Hand Switch Operation & Pass Beam
 - Horn
 - Indicator
 - Head Light
- c. All Bulbs - Functioning
- d. Battery
 - Electrolyte Level
 - Specific Gravity
 - Routing of Breather Pipe
 - Fuse
 - Routing of Positive Wire (Red) Below Breather Pipe

D. ROAD TEST

- a. Starting
- b. Gear Shifting Operation
- c. Clutch Operation
- d. Application of Brakes (Front and Rear)
- e. Speedo/ Odo Meter Operation
- f. Fuel gauge Operation

EXPLAINED BY SIGNATURE: _____ NAME: MAIN SELLING DLR'S STAMP, SIGNATURE <input style="width: 50px;" type="text"/>	CUSTOMER'S SIGN
--	--

INSTALLATION

Procedures to be explained to the customer on delivery of the Motorcycle by the Dealer's Representative.

1. Operation of all the locks (Ignition, Steering, Fuel Tank Cap, Side Cover L.H.).
2. Fuel Cock Lever Operation and its reserve position; Fuel Tank Capacity including reserve & Fuel Gauge.
3. Operation and function of Starter Lever.
4. Operation of Kick Lever.
5. Operation of Throttle.
6. Operation of Handle Bar Switches, their Functions and Pass Beam.
- Ⓒ 7. Disadvantages of riding on half Clutch (Never ride with clutch pressed).
8. Gear shifting pattern.
9. Tyre inflation pressure : **Front** - 25 Psi **Rear** - 33 Psi (Solo), 36 Psi (Double)
- Ⓒ 10. Never give sudden acceleration; always accelerate gradually
- Ⓒ 11. Simultaneous use of Front and Rear Brakes.
- Ⓒ 12. Never ride with your foot on Rear brake Pedal.
13. Whenever parking the Motorcycle on the Side Stand, ensure that the Fuel Cock Lever is in closed position.
14. Always adjust both the right and left Shock Absorbers to the same position.

INSTALLATION

- 15. Location of Storage and Tool Kit compartments and their use.
- 16. Procedure of opening and closing of L. H. Side Panel.
- 17. Battery Maintenance : Checking of electrolyte level **(To add only distilled water if required & to maintain its Specified Level)**
- 18. Correct Drive Chain Slackness (20 ~30 mm).
- 19. Correct type of Spark Plug and Spark Plug gap.
- 20. Engine Oil (in Gear Box), level checking and explaining the importance of **replacing the Engine Oil after every 2000 KMS Always use YAMALUBE 4T OIL SG Grade.**
- 21. TFF oil to be replaced after every 10000 Kms.
- 22. Running- In Period/ Preventive Maintenance Schedule Instructions
- 23. Information of emission and safety norms (AIS + CATCON).
- 24. Importance and schedule of Free Services
- 25. Warranty Terms and Conditions.



<p>EXPLAINED BY</p> <p>SIGNATURE: _____ NAME: _____</p> <p>MAIN SELLING DLR'S STAMP, SIGNATURE <input style="width: 50px; height: 20px;" type="text"/></p>	<p>CUSTOMER'S SIGN</p> <p>_____</p> <p>_____</p>
---	---



NOTES



CONTENTS

- DO'S & DON'TS for the Motorcycle 1
- Procedure for measurement of 'CO' Emission Level. 2
- List of Components impacting Emission 3

DO'S AND DON'TS FOR THE MOTORCYCLE

1. DO'S (✓)

- ✓ 1 *Always use genuine 'spare parts' purchased from **YAMAHA** Authorised Dealers.*
- ✓ 2 Always use only genuine oils
 - 4T - 20W/40 SG grade - YAMALUBE 4T
- ✓ 3 Always keep your engine well turned. Save environment and also improve Fuel Efficiency
- ✓ 4 • **ALWAYS GET YOUR MOTORCYCLE REPAIRED AND MAINTAINED ONLY AT **YAMAHA** AUTHORISED DEALER.**
 - **YAMAHA** serves you through a wide network of Authorised Dealers.
- ✓ 5. **Check the Following at every scheduled service:-**
 - a) Spark Plug : Check/Reset Gap/Replace as per the recommendations in this Owner's Manual (page no 6-7)
 - b) Carburetor : Cleaning/Adjustment Every 4500 kms
 - c) Air Filter : Clean every 2000 kms as per the environment conditions.
 - d) Piston/Rings/Cylinder : Check / Clean / Replace if necessary
 - e) Exhaust System : Check / Replace if necessary
 - f) Valve Timing : Check / Adjust every 4500 kms
 - g) Compression pressure : Check / Diagnose.
- ✓ 6 Always drive with Starter Lever in OFF position.
- ✓ 7 Use Starter Lever for minimum possible period (1 to 2 minutes) only to start and warm up Engine (may be required only in winter)

DO'S AND DON'TS FOR THE MOTORCYCLE

- ✓ 8 If misfiring, get your Motorcycle diagnosed & attended immediately without running even for a KM.
- ✓ 9 *Get Motorcycle maintained regularly as per details and schedule given in Owner's Manual.*
- ✓ 10 Get emission of your Motorcycle inspected at least once every 3 months.
- ✓ 11 Please follow good driven habits in varying traffic conditions.
- ✓ 12 Switch "OFF" the engine while waiting at signal point.

DON'TS (*)

- * 1. Don't overload/overspeed your Motorcycle.
- * 2. Don't alter or modify your Motorcycle.
- * 3. Never drive with Ignition "OFF" while moving down a slope.
- * 4. Don't turn off the Engine or interrupt the Ignition when the Transmission is in Gear & the Motor cycle is in motion.
- * 5. Don't idle the Engine for a prolonged period.
- * **6. Don't use Non-Genuine Parts.**
- * 7. Don't buy adulterated Petrol/Oil.

'CO' EMISSION LEVEL MEASUREMENT

2. PROCEDURE FOR MEASUREMENT OF "CO" EMISSION LEVEL

- 2.1 **IMPORTANT** : "CO" Measurement Equipment must be duty calibrated.
- 2.2 Check for "NO LEAKAGE" from Exhaust System.
- 2.3 Starter Lever should be in OFF position.
- 2.4 All Electricals should be in OFF position.
- 2.5 Set the Idle speed of the Engine in warmed up condition of Motorcycle as specified.

MODEL	IDLE R.P.M.
LIBERO	1300 - 1500 RPM

- 2.6 Insert the Sampling probe of the Exhaust Gas Analyser inside the Exhaust Muffler of the Motorcycle.
- 2.7
 - If the reading is within specified limits then it is acceptable.
 - If the reading exceeds the norm of 3.5% (by volume) have it adjusted by YMI Authorised Dealer.

3. LIST OF COMPONENTS IMPACTING "EMISSION"

- | | | |
|-------------------------|-----------------|--------------------------------|
| a. Air Filter | f. Rocker Arm | k. Air Intake System |
| b. Carburetor | g. Valves | l. Ignition Coil, CDI, Magneto |
| c. Cylinder | h. Cam Shaft | m. Spark Plug |
| d. Piston Ring & Piston | i. Valve Seals | n. Exhaust System |
| e. Cylinder Head | j. Timing Chain | - AIS, - CAT CON |

Always use
YAMAHA
GENUINE
Parts & Accessories



YAMAHA MOTOR INDIA SALES PRIVATE LIMITED
A-3, SURJPUR INDUSTRIAL AREA, NOIDA DADRI ROAD
SURAJPUR - 201 306 (UP) INDIA

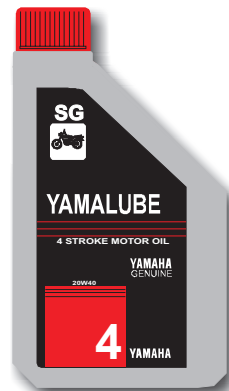

- Longer Engine Life
- Lower Maintenance Cost
- Lower Exhaust Smoke
- Reduces Wear and Tear

1B5-F8199-E0



PRINTED IN INDIA
2Y14(OM-01)284-11-06-E

YAMAHA
LUBRICANTS

1B56

