



# YAMAHA

## SR250G

### Service Manual



## CHAPTER 1. GENERAL INFORMATION

MOTORCYCLE IDENTIFICATION.....	1-1
EXTERNAL VIEW.....	1-2
SPECIAL TOOLS.....	1-2

## CHAPTER 1. GENERAL INFORMATION

### MOTORCYCLE IDENTIFICATION

The frame serial number is located on the right-hand side of the head pipe. The first three digits identify the model. This is followed by a dash. The remaining digits identify the production number of the unit.

The engine serial number is located on a raised boss on the upper rear, right-hand side of the engine. Engine identification follows the same code as frame identification.

#### Starting Serial Number

SR250G	3Y8 000101
--------	------------

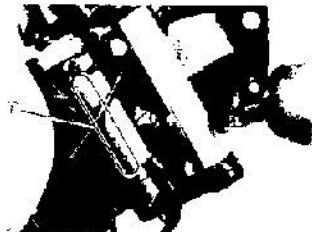

1. frame serial number



1. engine serial number

## EXTERNAL VIEW

## CHAPTER 2

## PERIODIC INSPECTIONS AND ADJUSTMENTS

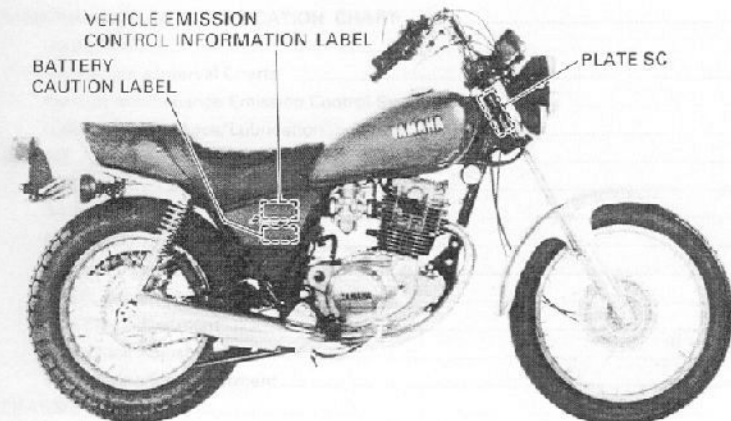

## SPECIAL TOOLS

1. Peckol tactor (P/No. 90890-03112-00)
2. Electro tester (P/No. 90890-03021-00)
3. Dial gauge (P/No. 90890-03097-00)
4. Rotar holding tool (P/No. 90890-01238-00)
5. Flywheel puller (P/No. 90890-01189-00)
6. Clutch holding tool (P/No. TLM 90910-42-00)
7. Crankcase separating tool (P/No. 90890-01135-00)
8. Tappet adjusting tool (P/No. 90890-01311-00)
9. Front fork cylinder coneplate holder (P/No. 90890-01294-00)
10. T type hard a (P/No. 90890-01301-00)
11. Ring nut wrench (P/No. 90890-01266-00)
12. Spoke wrench (P/No. 90890-05067-00)
13. Valve seat cutter set (P/No. T.J.M. 90910-43-20)
14. Valve guide installer (P/No. 90890-04077-00)
15. Valve guide remover (P/No. 90890-01225-00)
16. Valve spring compressor (P/No. 90890-01253-00)
17. Hex key (P/No. 90890-01227-00)
18. Drive chain cutter (P/No. 90890-01286-00)
19. Fuel level gauge (P/No. 90890-01312-00)
20. rocker arm shaft puller bolt (P/No. 90890-01083-00)
21. Rocker arm shaft puller weight (P/No. 90890-01084-00)

## CHAPTER 2. PERIODIC INSPECTIONS AND ADJUSTMENTS

<b>MAINTENANCE AND LUBRICATION CHART</b> .....	2-1
Introduction.....	2-1
Maintenance Interval Charts .....	2-1
Periodic Maintenance Emission Control System .....	2-1
General Maintenance/Lubrication.....	2-2
<b>ENGINE</b> .....	2-3
Carburetor.....	2-3
Air Filter .....	2-3
Engine Oil.....	2-4
Engine Oil and Oil Filter Replacement .....	2-5
Clutch Adjustment .....	2-6
Free Play Adjustment .....	2-6
Cam Chain Adjustment .....	2-7
Valve Clearance Adjustment .....	2-7
<b>CHASSIS</b> .....	2-8
Fuel Petcock .....	2-8
Front Brake and Wheel.....	2-8
Front Brake Adjustment.....	2-8
Spoke Adjustment and Torque.....	2-9
Front Axle .....	2-9
Tire Pressure .....	2-9
Rear Brake and Wheel.....	2-9
Rear Brake Adjustment.....	2-9
Brake Lining Inspection.....	2-9
Spoke Adjustment and Tension.....	2-10
Rear Axle.....	2-10
Tire Pressure.....	2-10
Drive Chain Tension Check.....	2-10
Drive Chain Tension Adjustment.....	2-10
Drive Chain Lubrication .....	2-11
Front Fork Oil Change .....	2-11
Suspension, Steering and Swing Arm.....	2-12
Rear Shock Absorber .....	2-13
Cable Inspection and Lubrication.....	2-13
Throttle Cables and Grip Lubrication .....	2-13
Lubrication of Levers, Pedals, etc.....	2-13
<b>ELECTRICAL</b> .....	2-13
Ignition Timing .....	2-13
Spark Plug.....	2-14

## CHAPTER 2. PERIODIC INSPECTIONS AND ADJUSTMENTS

### MAINTENANCE AND LUBRICATION CHART

#### Introduction

This chapter includes all information necessary to perform recommended inspection and adjustments. These preventative maintenance procedures, if followed, will insure more reliable vehicle operation and a longer service life. The need for costly overhaul work will be greatly reduced. This information applies not only to vehicles already in service, but also to new vehicles that are being prepared for sale. Any service technician performing preparation work should be familiar with this entire chapter.

#### Maintenance Intervals Charts

Proper periodic maintenance is important. Especially important are the maintenance services related to emissions control. These controls not only function to ensure cleaner air but are also vital to proper engine operation and maximum performance. In the following tables of periodic maintenance, the services related to emissions control are grouped separately.

**Periodic Maintenance Emission Control System**

No.	Item	Remarks	Initial break in		Thereafter every	
			1,000 km (600 mi) or 1 month	4,000 km (2,500 mi) or 7 months	3,000 km (2,000 mi) or 6 months	6,000 km (4,000 mi) or 12 months
1*	Cam chain	Check and adjust chain tension	○	○	○	
2*	Valve clearance	Check and adjust valve clearance when engine is cold.	○	○	○	
3	Spark plug	Check condition. Adjust gap/clean. Replace after initial 7,000 km (4,500 mi).		○	○	Replace
4*	Crankcase ventilation system	Check ventilation hose for cracks or damage. Replace if necessary.		○		○
5*	Fuel line	Check fuel hose for cracks or damage. Replace if necessary.		○		○
6*	Exhaust system	Check for leakage. Retighten as necessary. Replace gasket if necessary.		○	○	
7*	Idle speed	Check and adjust engine idle speed. Adjust cable free play if necessary.		○	○	

\* It is recommended that these items be serviced by a Yamaha dealer or other qualified mechanic.

## General Maintenance/Lubrication

No	Item	Remarks	Type	Initial break-in		Thereafter every		
				1,000 km (600 mi) or 1 month	4,000 km (2,500 mi) or 7 months	5,000 km (3,000 mi) or 8 months	8,000 km (4,900 mi) or 12 months	15,000 km (9,300 mi) or 24 months
1	Engine oil	Warm-up engine before draining	Yamalube 4-cycle oil or SAE 20W/40 type "DE" motor oil	○	○		○	
2	Oil filter/ Oil strainer	Replace filter element and clean oil strainer	—	○	○		○	
3*	Air filter	Wet-type filter must be washed and damped with oil	Yamalube 2-cycle oil or equivalent	○	○	○		
4*	Brake system	Adjust free play. Replace shoes if necessary.	—	○	○	○		
5*	Clutch	Adjust free play	—	○	○	○		
6	Drive chain	Apply chain lube thoroughly.	Yamaha chain and cable lube or SAE 10W/30 motor oil	Check chain tension and lube every 500 km (300 mi)				
7	Control and meter cable	Apply chain lube thoroughly.	Yamaha chain and cable lube or SAE 10W/30 motor oil	○	○	○		
8*	Rear arm pivot shaft	Apply grease lightly.	Lithium soap base grease					○
9	Brake pedal shaft	Apply chain lube lightly.	Yamaha chain and cable lube or SAE 10W/30 motor oil		○	○		
10	Brake/clutch lower pivot shafts	Apply chain lube lightly.	Yamaha chain and cable lube or SAE 10W/30 motor oil		○	○		
11	Center stand pivot	Apply chain lube lightly.	Yamaha chain and cable lube or SAE 10W/30 motor oil		○	○		
12*	Front fork oil	Drain completely. Refill to specification.	Yamaha fork oil 10W1 or equivalent					○
13*	Steering ball bearing and races	Check bearings assembly for looseness. Moderately repack every 15,000 km (9,300 mi).	Medium weight wheel bearing grease		○	○		Repack
14*	Wheel bearings	Check bearings for smooth rotation. Replace if necessary.	—		○	○		
1b	Battery	Check specific gravity. Check breathe pipe for proper operation.	—		○	○		

\* It is recommended that these items be serviced by a Yamaha dealer or other qualified mechanic.

### NOTE:

The air filter should be cleaned more often than specified intervals if the motorcycle is operated in extremely dusty area.

## ENGINE

### Carburetor

#### 1. Idle speed setting procedure

Start the engine and warm it up for a few minutes. Set the engine idle speed to specified r/min, by turning the throttle stop screw in to increase the engine speed and back off the screw to decrease the engine speed.

Use a tachometer for checking and adjusting the engine speed.

Idle speed: 1,200 r/min

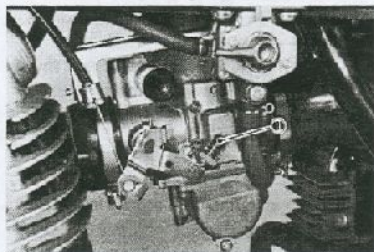

1. Throttle stop screw

#### 2. Idle mixture

The idle mixture is set at the factory by the use of special equipment. No attempt should be made by the dealer to change this adjustment.

#### 3. Throttle cable adjustment

### NOTE:

Idle speed should be set before making this adjustment.

The throttle grip should have a play of 2 ~ 5 mm (0.08 ~ 0.2 in) in the turning direction at the grip flange. If the play is not this range, take the following step for adjustment:

Loosen the adjuster lock nut on the throttle cable, and turn the adjuster in or out so the play is correct. After the adjustment, tighten the lock nut.

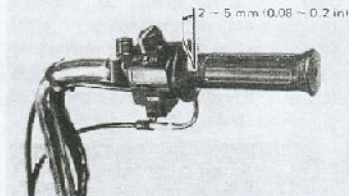

### Air Filter

The air filter protects the engine from dirt which can enter with the intake air and cause rapid engine wear. This dirt is filtered from the air by the air filter element. This model uses a cartridge type air filter element which consists of foam rubber moistened with oil. When this filter element becomes dirty it should be cleaned.

1. Remove the seat and the side cover (left).
2. Remove the air filter element from its base, remove element from guide and clean with solvent. After cleaning, remove the remaining solvent by squeezing the element.

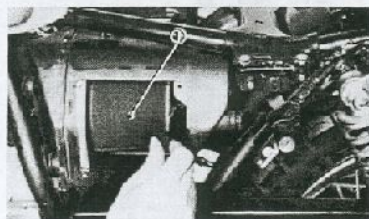
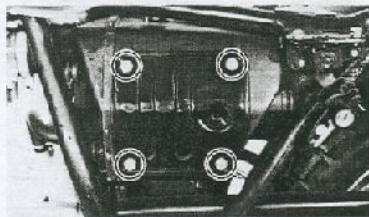

1. Air filter element



- Then apply Yamalube 2-cycle oil or equivalent to the entire surface and squeeze out the excess oil. Element should be wet but not dripping.
- When installing the air filter element in its case, be sure its sealing surface matches perfectly the sealing surface of the case so there is not air leakage.

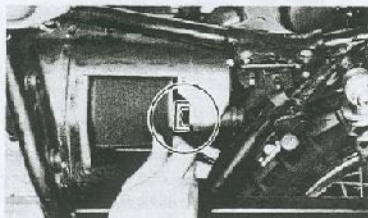

- The air filter element should be cleaned at the specified intervals. It should be cleaned more often if the motorcycle is operated in dusty or wet areas.

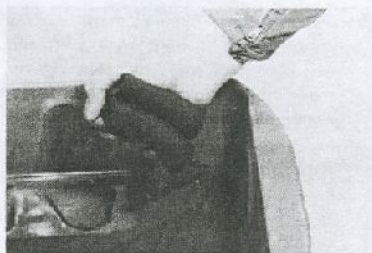

**CAUTION:**  
The engine should never be run without the air cleaner element installed; excessive piston and/or cylinder wear may result.

#### Engine Oil

- Oil level measurement
  - Place the motorcycle on a level place and hold it in an upright position. Warm up the engine for several minutes.

**NOTE:**  
Be sure the motorcycle is positioned straight up when checking the oil level; a slight tilt toward the side can produce false readings.

- With the engine stopped, check the oil level through the level window located at the lower part of the right side crankcase cover.

**NOTE:**  
Wait a few minutes until the oil level settles before checking.

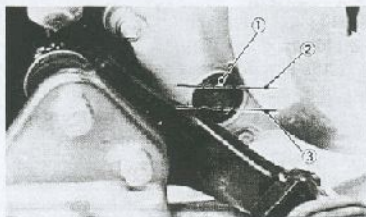

- Level window
- Maximum mark
- Minimum mark

#### 2. Oil capacity

After engine overhaul:  
1.6 lit (1.7 US qt)  
After oil filter replacement:  
1.3 lit (1.4 US qt)

## Engine Oil and Oil Filter Replacement

### CAUTION:

After replacement of engine oil, be sure to check the oil pressure in the following procedure.

1. Remove the air bleed screw from oil filter cover, and loosen the check bolt in the cylinder head.
2. Start the engine and keep it idle running till oil flows out of the bleed hole, and at the check bolt (see the following photo). The check bolt has a slit for checking oil.

If no oil comes out even after a lapse of over one minute, cut the engine immediately for fear of seizure.

Restart the engine after solving the problem(s) and recheck the oil pressure.

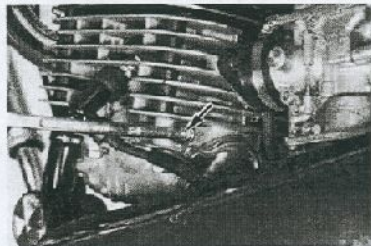

1. Oil filter replacement

### NOTE:

When replacing the engine oil after the break-in period, clean the oil strainer at the bottom of the engine.

- a. Start the engine. After a few minutes of warm-up stop the engine.
- b. Place an oil pan under the engine.

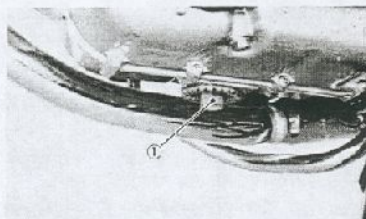

1. Drain plug

- c. Remove the oil filler cap, drain plug and air bleed screw attached to the oil filter cover, and drain the engine oil.

### NOTE:

The oil filter cover is secured by three screws. The lower one should be loosened until the threaded portion comes out completely.



1. Air bleed screw
2. Filter cover screw

### CAUTION:

When removing the drain plug, the compression spring, oil strainer and O-ring will fall off. Take care not to lose these parts.

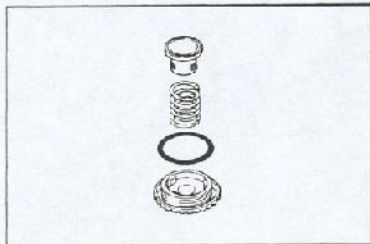

- d. Remove the oil filter cover, and replace the filter element.

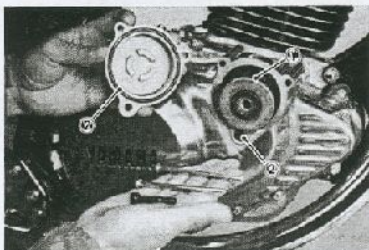

1. Filter element    2. O-ring

- e. Install the drain plug, air bleed screw, oil filter and oil filter cover.

**CAUTION:**

Before reinstalling the drain plug, do not forget to fit the O-ring, compression spring and oil strainer.

**Drain plug torque:**

3.2 m·kg (23.0 ft·lb)

- f. Add 1.3 liters of engine oil. Install the oil filler cap and tighten. Use Yamalube 4-cycle oil or SAE 20W/40 type "SE" oil.

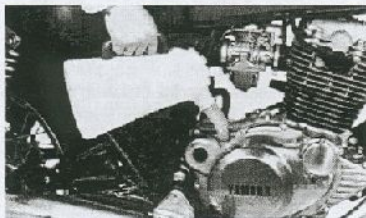

- g. Start the engine and allow a few minutes of warm up. While warming up, check for oil leakage. If oil leaks, stop the engine immediately, and check for the cause.
- h. After warm up, stop the engine and check the oil level. (Refer to page 2-4, "Engine Oil".)
2. Regular oil replacement (without replacing filter)

- a. Start the engine and stop after a few minutes of warm up.
- b. Place an oil receiver under the engine.
- c. Remove the oil filler cap, drain plug and air bleed screw attached to the oil filter cover.

**NOTE:**

The oil filter cover is secured by three screws. The lower one should be removed so that the filter cavity will drain.

- d. Check each O-ring. If damaged replace.
- e. Install the drain bolt and the bleed screw.
- f. Add 1.3 liters of engine oil. Install the oil filler cap and tighten.
- g. Start the engine and allow a few minutes of warm-up. While warming up, check for oil leakage. If oil leaks, stop the engine immediately, and check for the cause.
- h. Stop the engine and check the oil level. (Refer to page 2-4, "Engine Oil".)

**Clutch Adjustment**

This model has two clutch cable length adjusters and a clutch mechanism adjuster. Cable length adjusters are used to take up slack from cable stretch and to provide sufficient free play for proper clutch operation under various operating conditions. The clutch mechanism adjuster is used to provide the correct amount of clutch "throw" for proper disengagement (see page 3-24). Normally, once the mechanism is properly adjusted, the only adjustment required is maintenance of free play at the clutch handlebar lever.

**Free Play Adjustment**

Loosen the handlebar lever adjuster lock nut. Next, turn the length adjuster either in or out until proper lever free play is achieved.

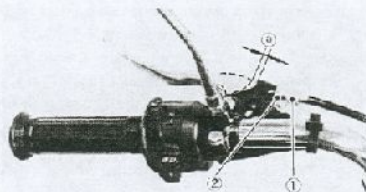

1. Adjuster    2. Lock nut     $\phi = 3 \sim 5 \text{ mm}$   
(0.12 ~ 0.20 in.)

### Cam Chain Adjustment

1. Remove the left crankcase cover.
2. Rotate crank shaft in a counter-clockwise direction (viewed from the left side of the engine) to place all slack in the area of the chain tensioner.

Align the "T" mark on the flywheel with the timing mark on the crankcase at the compression stroke.

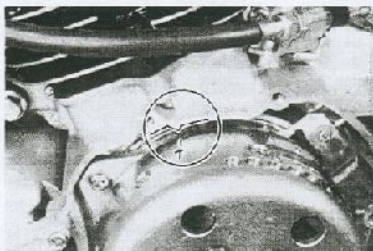

3. Remove the adjuster cap.
4. Loosen the adjuster lock nut.
5. Turn the adjuster in until the push rod (inside the adjuster) is flush with the end of the adjuster.

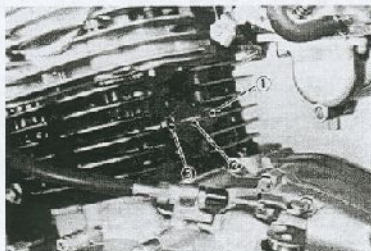

1. Push rod    2. Adjuster    3. Lock nut

### NOTE:

Start the engine. While keeping it idling, check the movement of the push rod. If it moves slightly, the adjustment is correct. If it does not move at all, the adjuster is too tight. Loosen the adjuster so the push rod moves slightly.

6. Tighten the adjuster lock nut.
7. Install the adjuster cap and the left crankcase cover.

Adjuster lock nut tightening torque:  
3.0 m·kg (22 ft·lb)

Adjuster cap tightening torque:  
0.5 m·kg (3.6 ft·lb)

### Valve Clearance Adjustment

1. Remove the seat.
2. Turn the fuel petcock to "ON" and disconnect the fuel pipe.
3. Remove the bolt securing the fuel tank to the frame and remove the fuel tank.
4. Remove intake and exhaust tappet covers and left crankcase cover.

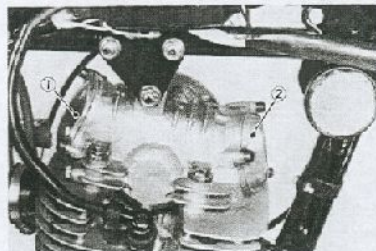

1. Intake tappet cover    2. Exhaust tappet cover

5. Align the "T" mark on the flywheel with the timing mark on the crankcase. This places the piston at the top dead center and the valve clearance should be checked and adjusted at T.D.C. on the compression stroke by observing when the valve adjusters have clearance.
6. Use a feeler gauge to determine the clearance.

Intake valve (Cold):  
0.05 ~ 0.10 mm (0.002 ~ 0.004 in)  
Exhaust valve (Cold):  
0.12 ~ 0.17 mm (0.005 ~ 0.007 in)

- Loosen the valve adjuster lock nut. Turn the adjuster in or out to obtain the correct clearance. Hold the adjuster to prevent it from moving and thoroughly tighten the lock nut.  
Recheck the clearance after tightening.

**NOTE:**

Valve clearance check and adjustment should be done when the engine is cold.

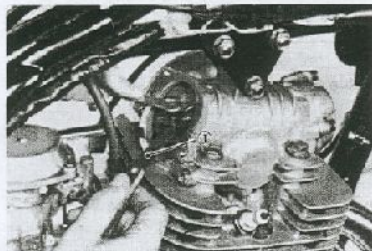

1. Feeler gauge

- Install the intake and exhaust tappet covers and left crankcase cover.
- Install the fuel tank and seat.
- Connect the fuel pipe.

**CHASSIS**

**Fuel Petcock**

- First, drain out the fuel tank and remove the fuel pipe.
- Loosen the fuel cock securing bolts and remove the fuel cock assembly from fuel tank.
- Clean the attached filter with solvent. Examine the filter and replace if damaged.
- Inspect the gasket, replace if damaged and install the outlet fitting.

**Front Brake and Wheel**

**Front Brake Adjustment**

The front brake should be adjusted to suit rider preference within a 5 ~ 8 mm (0.2 ~ 0.3 in) free play at the lever pivot side. Adjustment is accomplished at one of two places; either the handlebar lever holder or the front brake hub.

- Loosen the lock nut.
- Turn the cable length adjuster in or out until adjustment is suitable.
- Tighten the lock nut.
- If proper adjustment can not be obtained at the handlebar lever holder, make a brake hub adjustment.

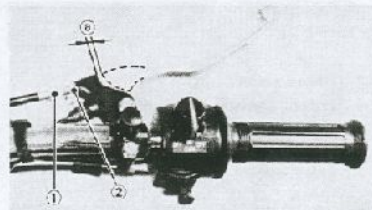

1. Adjuster a. 5 ~ 8 mm (0.2 ~ 0.3 in)  
2. Lock nut

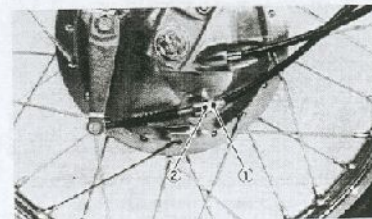

1. Adjuster 2. Lock nut

### Spoke Adjustment and Torque

- a. Raise the wheel off the ground.

#### Spin wheel.

Check rim run out as shown in illustration.

#### Rim runout limits:

Vertical: 2.0 mm (0.08 in)

Lateral: 2.0 mm (0.08 in)

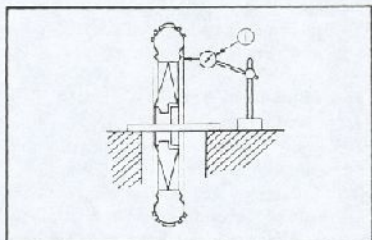

1. Dial gauge

- b. Check each spoke for tightness.

#### Spoke torque:

Front wheel: 0.3 m·kg (2.2 ft·lb)

Rear wheel: 0.3 m·kg (2.2 ft·lb)

### Front Axle

Check axle nut

#### Front axle nut torque:

10.7 m·kg (77.5 ft·lb)

### Tire Pressure

See page 5-3 "Installation"

### Rear Brake and Wheel

#### Rear Brake Adjustment

##### 1. Pedal height

- a. Loosen the adjuster lock nut (for pedal height).
- b. By turning the adjuster bolt clockwise or counterclockwise, adjust the brake pedal position so that its top end is approx. 15 mm (0.6 in) below the footrest top end.
- c. Secure the adjuster lock nut.

#### WARNING:

After adjusting the pedal height, the brake pedal free play should be adjusted.

##### 2. Free play

Turn the adjuster on the brake rod clockwise or counterclockwise to provide the brake pedal end with a free play of 20 ~ 30 mm (0.8 ~ 1.2 in).

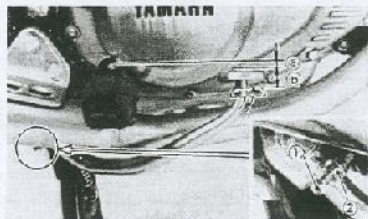

1. Adjuster bolt (for pedal height)
2. Lock nut
  - a. 15 mm (0.6 in)
  - b. 20 ~ 30 mm (0.8 ~ 1.2 in)

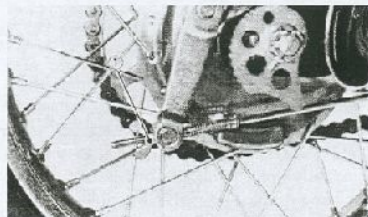

1. Adjuster

### Brake Lining Inspection

To check, see the wear indicator position while depressing the brake pedal or pulling the brake lever. If the indicator reaches to the wear limit line to replace the shoes.

#### Front

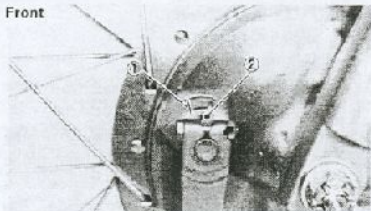

1. Wear limit      2. Wear indicator

#### Rear

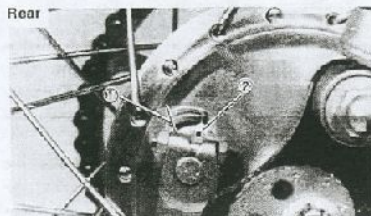

1. Wear limit      2. Wear indicator

#### Spoke Adjustment and Tension

Adjust rear wheel spoke tension per front wheel instructions.

#### Rear Axle

Check axle nut.

Rear axle nut torque:  
10.7 m·kg (77.5 ft·lb)

#### Tire Pressure

See page 5-3 "Installation"

#### Drive Chain Tension Check

##### NOTE:

Before checking and/or adjusting, rotate the rear wheel through several revolutions and check tension at several points to find the tightest point. Check and/or adjust the chain tension with the rear wheel in this "tightest" position.

Inspect the drive chain with the center stand put. Check the tension at the position shown in the illustration. The normal vertical deflection is approximately 25 ~ 35 mm (1.0 ~ 1.4 in). If the deflection exceeds 35 mm (1.4 in) adjust the chain tension.

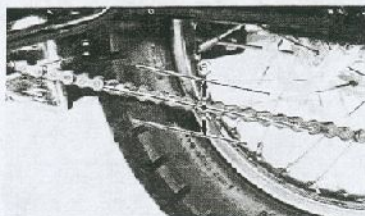

- a. 25 ~ 35 mm (1.0 ~ 1.4 in)

#### Drive Chain Tension Adjustment

1. Loosen the rear brake adjuster.

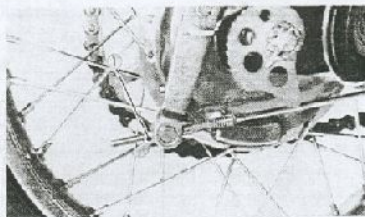

1. Rear brake adjuster

2. Remove the cotter pin of the rear wheel axle nut with pliers.
3. Loosen the rear wheel axle nut.
4. Turn the chain puller both left and right until axle is situated in same puller slot position on each side.

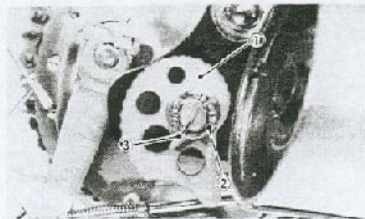

1. Chain puller
2. Axle nut
3. Cotter pin

5. Tighten the rear axle nut.

Axle nut torque:  
10.7 m·kg (77.5 ft·lb)

6. Insert the cotter pin into the rear wheel axle nut and bend the end of the cotter pin as shown in the illustration (if the nut notch and the cotter pin hole do not match, tighten the nut slightly to match).
7. In the final step, adjust the play in the brake pedal.

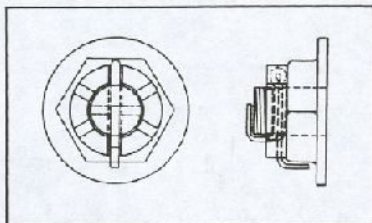

**CAUTION:**

Excessive chain tension will overload the engine and other vital parts; keep the tension within the specified limits. Also, replace the rear axle cotter pin with a new one.

**Drive Chain Lubrication**

1. First, remove dirt and mud from the chain with a brush or cloth and then spray the lubricant between both rows of side plates and on all center rollers.
2. To clean the entire chain, first remove the chain from the motorcycle, dip it in solvent and clean out as possible. Then take the chain out of the solvent and dry it. Immediately lubricate the chain to prevent the formation of rust.

Recommended lubricant:  
Yamaha chain and cable lube or  
SAE 10W/30 motor oil

**Front Fork Oil Change**

**WARNING:**

Securely support the motorcycle so there is no danger of it falling over.

1. Raise the motorcycle or remove the front wheel so that there is no weight on the front end of the motorcycle. Remove the handlebar if necessary.
2. Remove the rubber cap from the top of each fork.

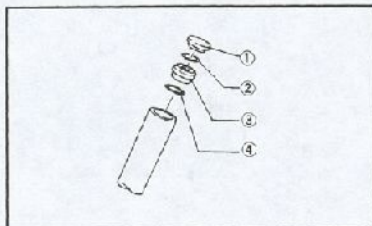

1. Cap
2. Stopper ring
3. Spring seat
4. D-ring

**CAUTION:**

Always use a new stopper ring (wire circlip).

3. The spring seat and fork spring are retained by a stopper ring (spring wire circlip). It is necessary to depress the spring seat and fork spring to remove the stopper ring. Remove the stopper ring by carefully prying out one end with a small screwdriver.
4. Place an open container under each drain hole. Remove the drain screw from each outer tube.
5. When most of the oil has drained, slowly raise and lower the outer tubes to pump out the remaining oil.
6. Inspect the drain screw gasket. Replace if damaged. Reinstall the drain screw.
7. Pour the specified amount of oil into the fork inner tube.

Recommended oil:  
Yamaha fork oil 10Wt or equivalent



Quantity per leg:  
168 cc. (5.7 oz.)

8. After filling, slowly pump the forks up and down to distribute the oil.
9. Inspect the "O" ring on the spring seat. Replace "O" ring if damaged.
10. Reinstall the spring seat, stopper ring and rubber cap.

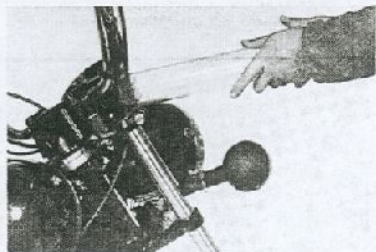

### Suspension, Steering and Swing Arm

1. Steering head adjustment
  - a. Block the motorcycle up so that front wheel is off the ground.
  - b. Grasp the bottom of the forks and gently rock fork assembly backward and forward, checking for any looseness in the steering assembly bearing.
  - c. If the steering head needs adjustment, remove the handlebar cover and loosen the steering fitting bolt.
  - d. Using the ring nut wrench, adjust the steering ring nut until steering head is tight without binding when the forks are turned.

**NOTE:** Excessive tightening of this nut will cause rapid wear of the ball bearings and races. Re-check for looseness and freedom of movement.

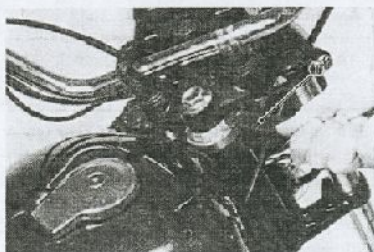

1. Ring nut wrench

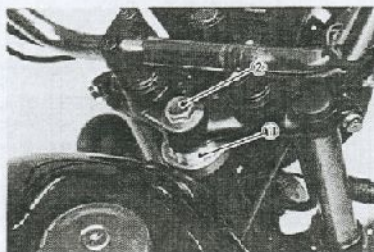

1. Steering ring nut 2. Steering fitting bolt

- a. Tighten the steering fitting bolt.

**NOTE:** After completing the steering adjustment, make certain forks pivot from stop to stop without binding. If binding is noticed, repeat adjustment.

2. Suspension
  - a. Check the all suspension components for proper operation.
  - b. Check the all suspension fittings for proper tightness.
3. Swing arm
  - a. Check for freedom of up and down movement.
  - b. Check side to side freeplay.

Swing arm free play  
1.0 mm (0.04 in) at end of swing arm

- c. Check the all securing bolts for proper tightness.

### Rear Shock Absorber

See Chapter 5 "Rear Shock Absorber".

The spring preload of the rear shock absorbers can be adjusted to suit rider preference and riding conditions. If the spring seat is raised, the spring becomes stiffer and if lowered the spring becomes softer.

#### **—WARNING:**

**Always adjust the shock absorbers on each side to the same position. Uneven adjustment can cause poor handling and loss of stability.**

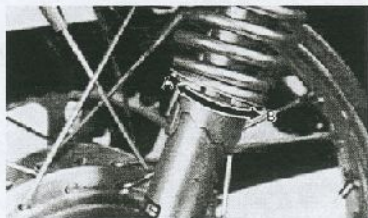

A. Stiffer    B. Softer

### Cable Inspection and Lubrication

1. Damage to the outer housing of the various cables, may cause corrosion and often free movement will be impaired. An unsafe condition may result so replace cables as soon as possible.
2. If the inner cables do not operate smoothly, lubricate or replace them.

#### **Recommended lubricant:**

Yamaha chain and cable lube or  
SAE 10W/30 motor oil

### Throttle Cables and Grip Lubrication

The throttle twist grip assembly should be greased at the time that the cables are lubricated, since the grip must be removed to get at the ends of the throttle cables.

Two screws hold the throttle housing to the handlebar. Once these two screws are removed, the ends of the cables can be held high to pour in several drops of lubricant. With the throttle grip disassembled, coat the metal surfaces of the grip assembly with a suitable all-purpose grease to cut down friction.

### Lubrication of Levers, Pedals, etc.

1. Lubricate the pivoting parts of the brake and clutch levers with recommended lubricant.

#### **Recommended lubricant:**

Yamaha chain and cable lube or  
SAE 10W/30 motor oil

2. Lubricate the shaft of the brake pedal with lithium soap grease.

### ELECTRICAL

#### Ignition Timing

1. Checking the ignition timing  
Ignition timing is checked with a timing light by observing the position of the mark on the case and the marks on the rotor.
  - a. Remove the crankcase cover (L).
  - b. Connect the timing light to the spark plug lead wire.
  - c. Start the engine and keep it running at the specified speed.
  - d. The index projection on the crankcase must be between the two marks for firing on the rotor.  
If not, refer to Chapter 6 "Ignition System".

Specified idling speed: 1,200 r/min

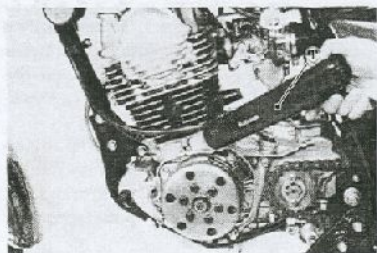

1. Timing light

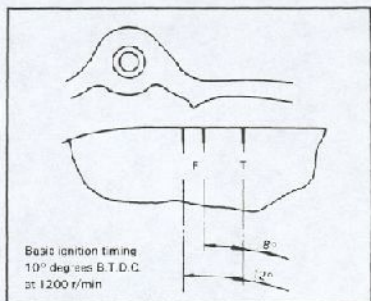

**NOTE:** Ignition timing is not adjustable.

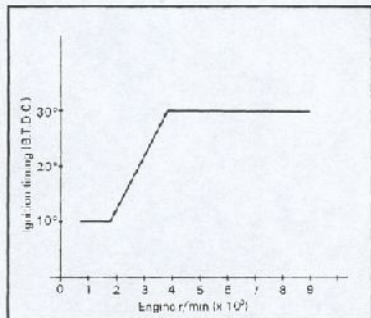

### Spark plug

The life of a spark plug and its discoloring vary according to the habits of the rider. At each periodic inspection, replace burned or fouled plug with new ones of the specified type. It is actually economical to install new plug often since it will tend to keep the engine in good condition and prevent excessive fuel consumption.

1. The spark plug should be inspected and cleaned at the specified intervals.
2. Clean the electrodes of carbon and adjust the electrode gap to the specification.
3. Be sure to use the proper reach, type and electrode gap plug as a replacement to avoid overheating, fouling or piston damage.

Type:

BP7ES (NGK) or W22EP (ND)

Electrode gap:

0.7 ~ 0.8 mm (0.028 ~ 0.031 in.)

Tightening torque:

2.0 m·kg (14.5 ft·lb)

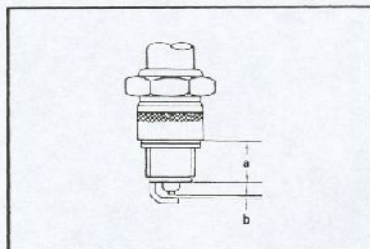

a. 19 mm (0.75 in.)

b. 0.7 ~ 0.8 mm (0.027 ~ 0.031 in.)

## CHAPTER 3. ENGINE OVERHAUL

REMOVAL.....	3-1
Preparation for Removal.....	3-1
Fuel Tank.....	3-1
Muffler, Footrest and Brake Pedal.....	3-1
Wiring and Cables.....	3-1
Carburetor.....	3-2
Drive Chain.....	3-2
Engine Mounting Bolts.....	3-2
DISASSEMBLY.....	3-3
Cylinder Head and Cylinder.....	3-3
Piston Pin and Piston.....	3-5
Crankcase Cover (Right) and Starter Motor.....	3-5
Clutch Assembly and Drive Gear.....	3-6
Clutch Push Lever Axle.....	3-7
Balancer Gear.....	3-7
Oil Pump Assembly.....	3-7
Change Shaft Assembly.....	3-7
Crankcase.....	3-8
Transmission.....	3-8
Crankshaft.....	3-8
INSPECTION AND REPAIRING.....	3-9
Cylinder Head.....	3-9
Valves, Valve Springs, Valve Guides and Valve Seats.....	3-10
Camshaft and Camshaft Bearing.....	3-13
Cylinder.....	3-14
Piston and Piston Rings.....	3-15
Piston Pin.....	3-16
Crankshaft.....	3-16
Oil Pump.....	3-17
Primary Drive.....	3-17
Clutch.....	3-18
Transmission.....	3-18
Bearings and Oil Seals.....	3-19
Crankcase.....	3-20

ENGINE ASSEMBLING AND ADJUSTMENT.....	3-20
Crankshaft Installation.....	3-20
Shifter.....	3-21
Oil Pump.....	3-22
Balancer Drive Gear and Driven Gear.....	3-22
Push Lever Assembly.....	3-23
Clutch.....	3-23
Clutch Adjustment.....	3-24
Crankcase Cover Right.....	3-24
Piston.....	3-24
Cylinder.....	3-25
Cylinder Head.....	3-25
Cam Shaft, Cam Shaft Driven Sprocket and Cam Chain.....	3-25
Drain Plug.....	3-27
MOUNTING.....	3-27

## CHAPTER 3. ENGINE OVERHAUL

### REMOVAL

#### Preparation for Removal

1. All dirt, mud, dust and foreign material should be thoroughly removed from the exterior of the before removal and disassembly. This will prevent any harmful foreign material from entering the interior of engine assembly.
2. Before engine removal and disassembly, be sure you have proper tools and cleaning equipment so you can perform a clean and efficient job.
3. During disassembly of the engine, clean and place all parts in trays in order of disassembly. This will ease and speed assembly time and insure correct re-installation of all engine parts.
4. Start the engine and warm it for a few minutes; turn off the drain plug and drain engine oil.

#### Fuel Tank

1. Remove the seat and fuel tank.
2. Remove the right side cover and disconnect battery wire.

#### Muffler, Footrest and Brake Pedal

1. Remove the bolts holding the exhaust pipe to the cylinder head.
2. Remove the bolts holding the exhaust pipe to the frame.

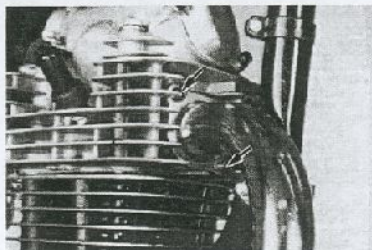
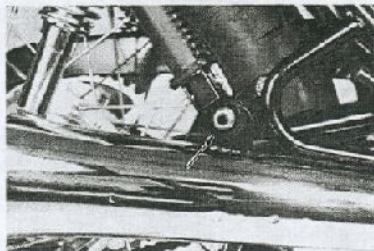

3. Remove the exhaust pipe assembly.
4. Remove the left side footrest.
5. Remove the brake rod wing nut and the return spring.

#### Wiring and Cables

1. Remove the spark plug cap.
2. Remove the change pedal.
3. Remove the left crankcase cover.

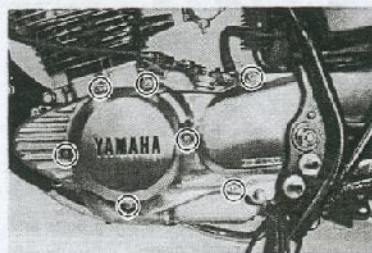

4. Disconnect the magneto lead wire coupler and the band.
5. Disconnect the starter lead wire.
6. Remove the clutch wire at the handlebar lever first and then at clutch push lever. Next, remove the breather pipe.

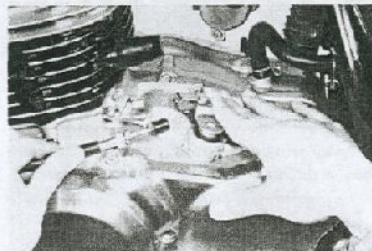

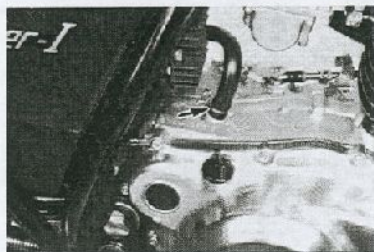

### Carburetor

1. Loosen the carburetor hose clamps as shown in the photo.
2. Remove the carburetor assembly while pulling the carburetor body backward.

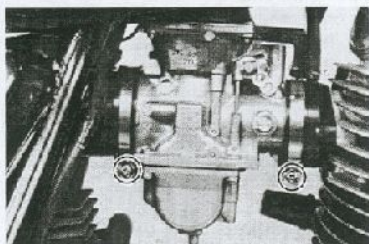

### Drive Chain

1. Loosen the sprocket securing bolts and remove the holder plate.
2. Remove the drive sprocket.

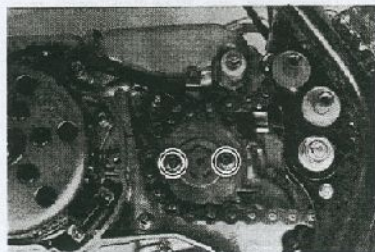

### NOTE:

The following procedure gives an alternative way to remove the chain from the engine.

3. Bring the master link clip slightly before the sprocket wheel, and remove the clip.
4. Set the chain cutter (special tool) on the chain, and remove the chain joint plate. Then, separate the chain.

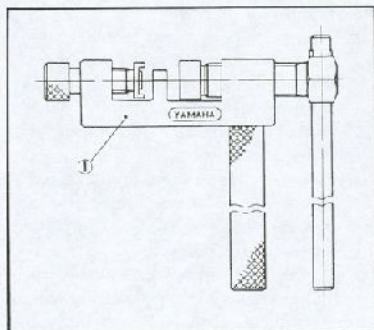

1. Chain cutter

### Engine Mounting Bolts

1. Remove the left hand footrest securing bolts.
2. Remove the engine mounting bolts.
3. Remove the engine from the right side of frame.

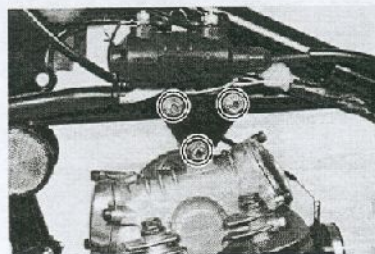
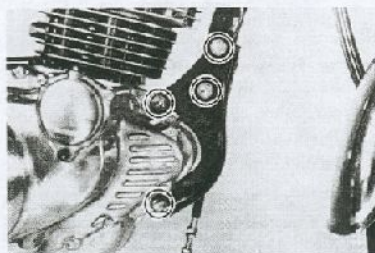

**NOTE:**

The engine and rear arm are installed using the same pivot shaft. Therefore take care so that the pivot shaft is pulled, not entirely cut but further enough to see the engine free.

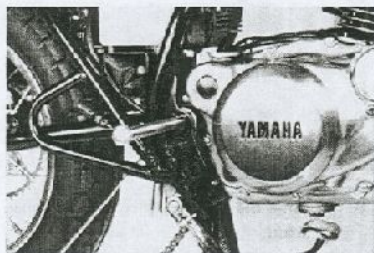
**DISASSEMBLY****Cylinder Head and Cylinder**

1. Remove the cam chain tensioner cap.
2. Loosen the tensioner lock nut.
3. Remove the chain tensioner assembly.

Note the location of each part.

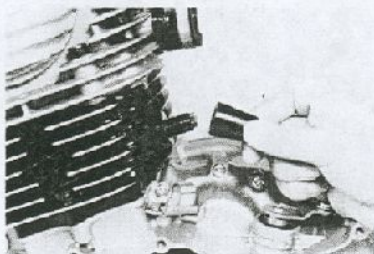

4. Loosen the side cover securing bolts and remove the side cover.
5. Remove the cam sprocket securing bolt (see the following photo). Then remove the flywheel magnet.

**NOTE:**

When removing the cam sprocket, it is not necessary to separate the cam chain.

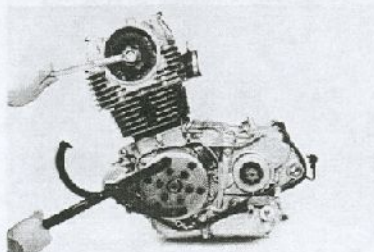
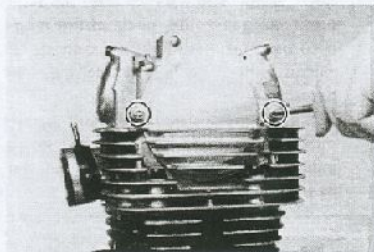



6. Flywheel magneto removal

- a. Remove the flywheel securing nut using the rotor holding tool.

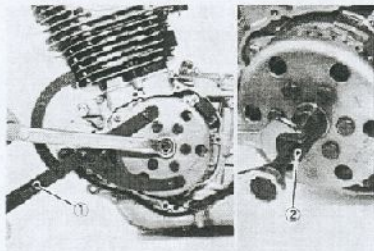

1. Rotor holding tool

2. Flywheel puller

- b. Install the flywheel puller on the flywheel and tighten it.

**NOTE:**

The puller body has a lefthand thread.

- c. While holding the puller body, tighten the push bolt. This will pull the flywheel off the tapered end of the crankshaft.
- d. Remove the magneto base assembly with the lead wire.

**NOTE:**

1. Pay careful attention to the "O-ring" fitted along the outer circle of the magneto base because this ring is made of silicon rubber and is susceptible to damage.
2. If the magneto base is difficult to remove, screw bolts (M8) into the holes indicated by an arrow to pull out the base with.

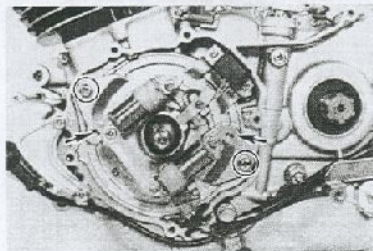

7. Loosen the guide stopper locking nut and bolt.

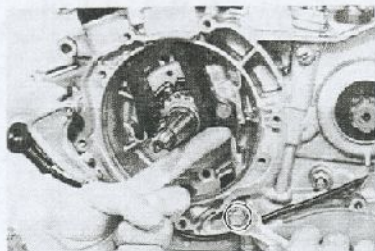

Guide stopper locking nut and bolt

8. Remove the cam chain and cam chain sprocket.

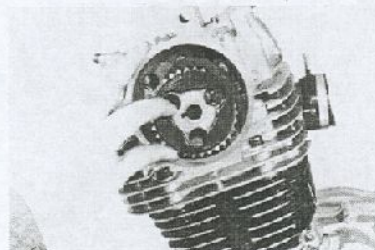

9. Remove the six cylinder head retaining bolts (2 of which are internal hexagon bolts) and the cylinder retaining bolt.

**NOTE:**

Loosen the bolts in the order indicated in the following photo.

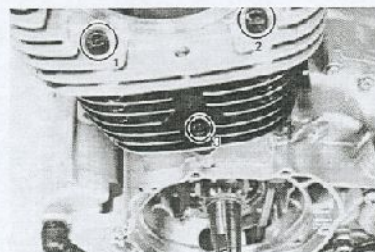

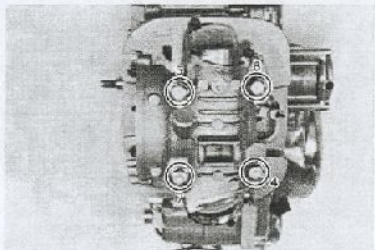

10. Remove the cylinder head and cylinder.
11. Remove the guide stoppers.

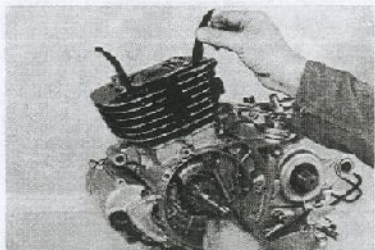

#### Piston Pin and Piston

1. Remove the piston pin clip from the piston.

#### NOTE:

Before removing the piston pin clip, cover the crankcase with a clean rag so you will not accidentally drop the clip into the crankcase.

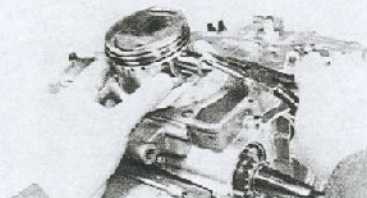

2. Push the piston pin from the opposite side, then pull out.

#### NOTE:

Before removing piston pin, deburr the clip groove and pin hole area.

#### Crankcase Cover (Right) and Starter Motor

1. Remove the oil filter cover holding bolts and the cover.
2. Remove the oil filter element.
3. Remove the crankcase cover holding bolts and the cover.

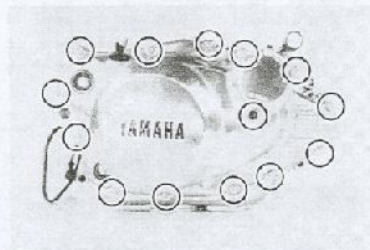

#### NOTE:

For this removal, slits in the crankcase can be used as shown in the photo.

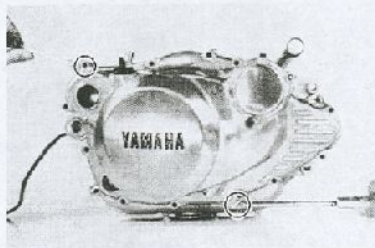

- 4 Remove starter motor assembly.

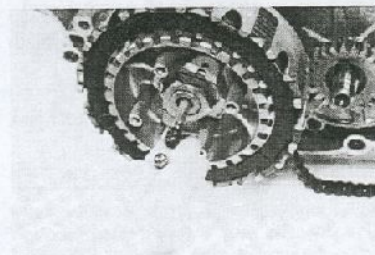
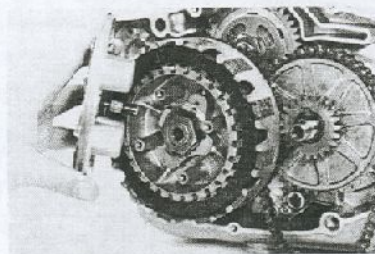
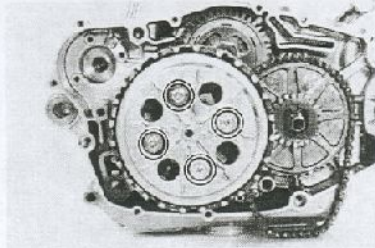
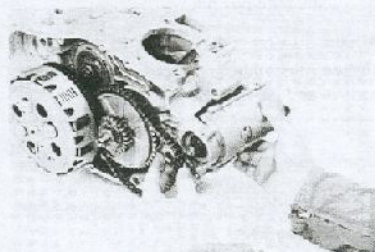

### Clutch Assembly and Drive Gear

1. Loosen primary drive gear by first placing a folded rag between the teeth of the primary gears to lock them as shown in the photo. Then loosen drive gear nut.  
Remove the nut and washer.

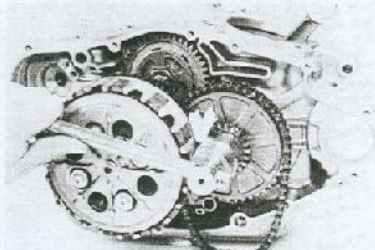

2. Remove the four clutch spring holding screws, pressure plates, clutch plates, friction plates, ball and push rod 2.

3. Install clutch holding tool on clutch boss. Remove lock nut, washer, clutch boss and housing in that order.

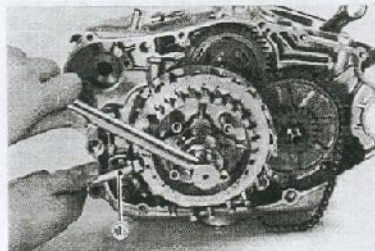

1. Clutch holding tool

### Clutch Push Lever Axle

Loosen and remove the set screw, then remove the push lever axle by pulling it up.

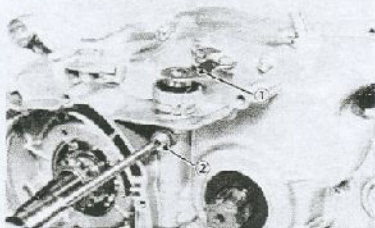

1. Push lever 2. Set screw

### Balance Gear

1. Flatten the lock washer.
2. First place a folded rag between the teeth of the drive gear and balancer gear to lock them. Then loosen the balancer gear securing nut.
3. Remove the balancer gear, the washers and the key.
4. Remove the drive gear and key.

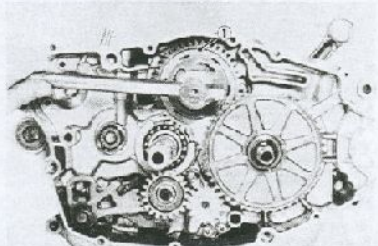

1. Balancer gear

### Oil Pump Assembly

Remove the pump idle gear clip and then loosen the pump cover securing bolts and remove the oil pump assembly.

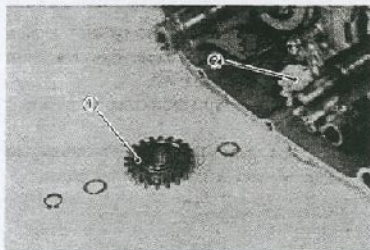

1. Pump idle gear 2. Pump driven gear

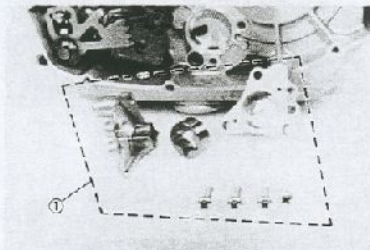

1. Pump Assembly

### Change Shaft Assembly

1. Pull the shift shaft out from the right hand side.
2. Remove the shift lever 2 with the shift lever 3 as an assembly, and then remove the stopper lever assembly with the torsion spring.

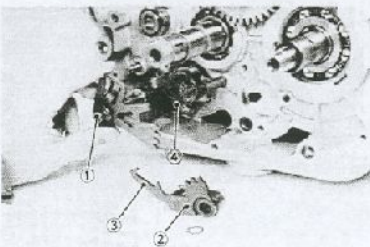

1. Shift shaft 2. Shift lever 2  
3. Shift lever 3 4. Stopper lever assembly

## Crankcase

1. Working in a crisscross pattern, loosen all bolts 1/4 turn each. Remove them after all area loosened.
2. Remove the right crankcase by pulling it up.  
For this removal, slits in the crankcase can be used as shown in the photo.

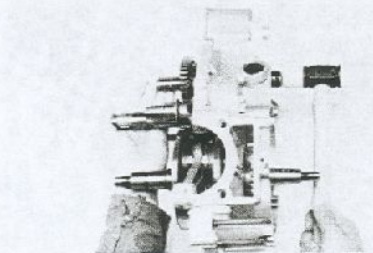
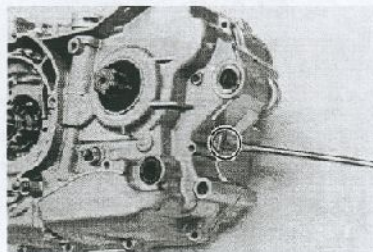
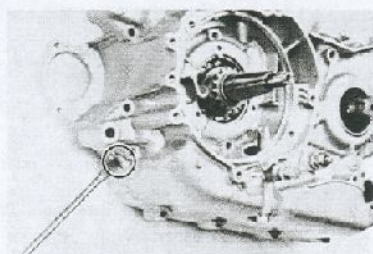
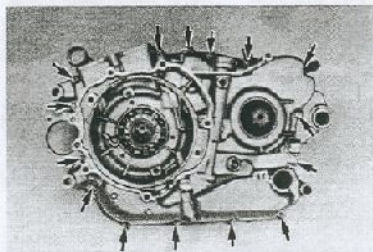

### NOTE:

While removing the drive axle from the crankcase, pay careful attention to the oil seal lip. A recommended practice is to fit the "O" ring and to apply grease over the fitted area.

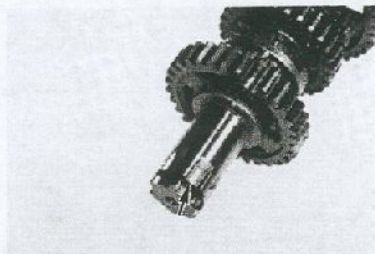

"O" ring

## Crankshaft

Remove crankshaft assembly with the crankcase separation tool (Special tool).

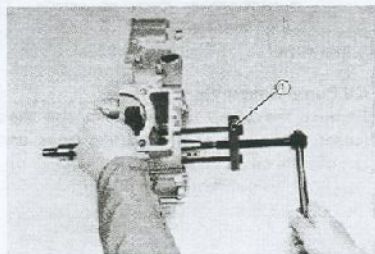

1. Crankcase separation tool

## Transmission

Remove the transmission shaft, shift forks and shift cam. Tap lightly on the transmission drive shaft with a soft hammer to remove.

### NOTE:

Remove assembly carefully. Note the position of each part. Pay particular attention to the location and direction of shift forks.

## INSPECTION AND REPAIRING

### Cylinder Head

1. Remove the intake and exhaust tappet covers.
2. Insert a 6 mm (0.24 in) screw into the rocker shaft, and withdraw the rocker shaft. It should slide out easily.

#### NOTE:

If does not slide out easily, use the special tool as shown.

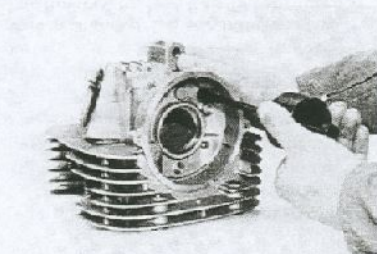
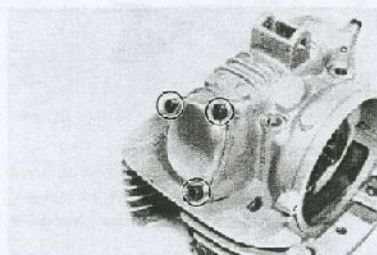

### 3. Rocker arm and rocker shaft

- a. The rocker arm usually wears at two locations: (1) at the rocker shaft hole, (2) at the cam lobe contacting surface.
- b. Measure the rocker arm inside diameter.

#### Standard size:

12.000 ~ 12.018 mm  
(0.472 ~ 0.473 in)

- c. The shaft has been hardened and it should not wear excessively. If a groove has developed in this surface that can be felt, or if it shows a blue discoloration, then the shaft should be replaced

and the lubrication system (pump and passages) checked.

Standard shaft diameter:  
11.975 ~ 11.990 mm  
(0.471 ~ 0.472 in)

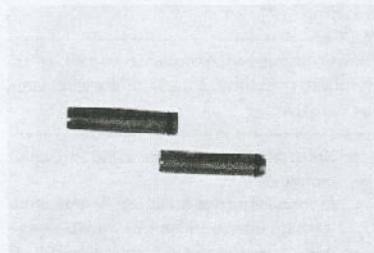
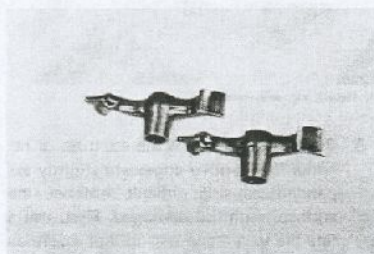

- d. Standard clearance between the rocker shaft and hole should be 0.010 ~ 0.043 mm (0.0004 ~ 0.0017 in). If measurement shows more than 0.1 mm clearance, replace either or both parts as necessary.
4. Compress the valve spring and then remove both retainer locks. Remove the compressor and lift off the retainer and springs.

#### NOTE:

The retainer locks might be partially stuck in the retainer. Use a rubber hammer to tap the edge of the retainer a few times to loosen the retainer locks.

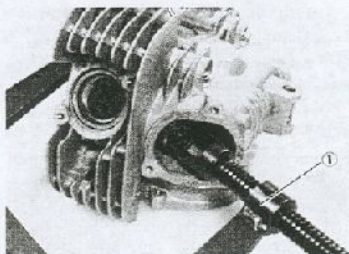

1. Valve spring compression

5. Pull the valve out. If the stem tip or retainer lock groove edges are slightly expanded, causing difficult removal, the surface might be damaged. First, use a fine file to remove any lip that exists on the stem and then remove the valve.

**NOTE:**

Be sure to remove the valve stem seal before removing the valve. Otherwise the seal could be damaged.

6. Decarbonization of the head and components.  
Carbon deposits build up in the combustion chambers, on the valves, and in the exhaust ports. Thoroughly clean all parts with a blunt scraper, then wash in solvent and dry with compressed air. The parts can then be examined and measured for wear.

**Valves, Valve Springs, Valve Guides and Valve Seats**

1. Check the intake and exhaust valve stems for bending and grooved wear. And check the stem ends for wear. Measurements should be done in three positions, upper, middle, and lower.

Intake valve stem diameter:

6.975 ~ 6.990 mm  
(0.2746 ~ 0.2752 in)

Exhaust valve stem diameter:

6.955 ~ 6.970 mm  
(0.2529 ~ 0.2744 in)

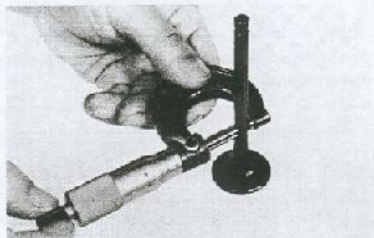

2. Checking the valve springs

- a. This engine use two springs of different sizes to prevent valve float or surging. The chart below shows the basic valve characteristics
- b. Even though the spring is constructed of durable spring steel, it gradually loses some of its tension. This is evidenced one way by a gradual shortening of free length. Use a vernier caliper to measure spring free length. If the free length of any spring has decreased more than 2 mm (0.08 in) from its specification, replace it.

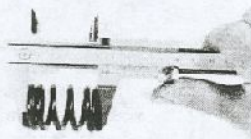

	Outer	Inner
Free length	43.2 mm (1.70 in)	40 mm (1.57 in)
Installed length (Valve closed)	37.1 mm (1.46 in)	34.1 mm (1.34 in)
Installed pressure (Valve closed)	23.7 ± 1.9 kg (52.3 ± 4.2 lb)	12.2 ± 1.0 kg (26.9 ± 2.2 lb)
Compressed length (Valve open)	28.1 mm (1.11 in)	25.1 mm (0.99 in)
Compressed pressure (Valve open)	70.1 ± 4.9 kg (154.6 ± 10.8 lb)	36.6 ± 2.6 kg (80.7 ± 5.7 lb)

- c. Another symptom of a fatigued spring is insufficient spring pressure when compressed. This can be checked using a valve spring compression rate gauge. Test each spring individually. Place it in the gauge and compress the spring first to the specified compressed length with the valve closed (all spring specifications can be found in previous section, Valve Spring) then to the length with the valve open. Note the poundage indicated on the scale at each setting. Use this procedure on the outer springs, then the inner springs.

**NOTE:**

All valve springs must be installed with larger pitch upward as shown below.

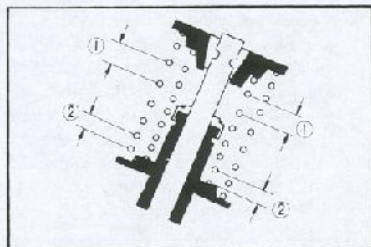

1. Larger pitch 2. Smaller pitch

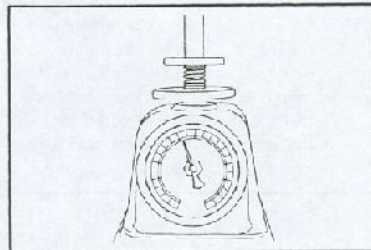

**3. Valve leakage check**

After all work has been performed on the valve and valve seat, and all head parts have been assembled, check for proper valve/valve seat sealing by pouring solvent into each of the intake ports, then the exhaust ports. There should be no leakage by the seat. If this

fluid leaks, disassemble and continue to lap with fine tapping compound. Clean all parts thoroughly, reassemble and check again with solvent. Repeat this procedure as often as necessary to obtain a satisfactory seal.

**4. Valve stem seal**

This seal slips down over the valve stem to prevent excessive amounts of oil from passing down stem and into the combustion chamber. If this seal is cracked, split, or hardened, replace it.

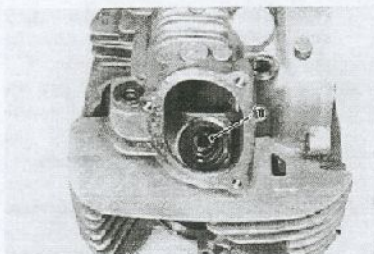

1. Valve stem seal

**5. Valve guide**

- a. If the valve guide inside diameter is beyond serviceable limits, replace with an oversize valve guide.

	Standard	Limit
Guide diameter (I.D.)	7.00 ~ 7.012 mm (0.2755 ~ 0.2761 in)	7.05 mm (0.278 in)

- b. To ease guide removal and reinstallation, and to maintain the correct interference fit, heat the head to 100°C (212°F).

If possible, use an oven to avoid any possibility of head warpage due to uneven heating.

- c. Use the appropriate shouldered drive (special tool) to drive the old guide out and the new guide in.



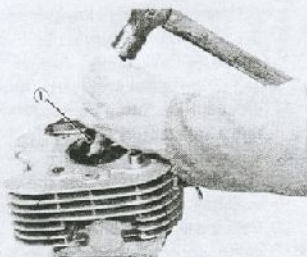

1. Valve guide removal.

- d. After installing the valve guide, use 7 mm (0.276 in) reamer (special tool) to obtain the proper valve clearance.
- e. After fitting the valve guide into the cylinder head, be sure to grind the valve seat, and perform valve lapping. The valve must be replaced by a new one.
6. Grinding the valve seat
  - a. The valve seat is subject to severe wear similar to the valve face. Whenever the valve face is resurfaced, the valve seat should also be resurfaced at a 45° angle. In addition, if a new valve guide has been installed (without any valve repair), the valve seat should be checked to guarantee complete sealing between the valve face and seat.

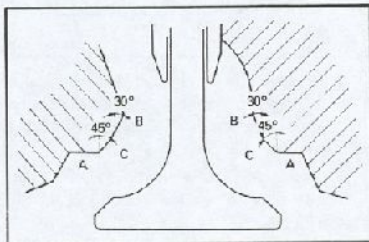

**CAUTION:**

If the valve seat is obviously pitted or worn, it should be cleaned with a valve seat cutter. Use the 45° cutter, and when twisting the cutter, keep an even downward pressure to prevent chatter marks.

If cutting section "A" of the intake valve seat, use "FLAT" cutter (radius cutter).

If cutting section "A" of the exhaust valve seat, use "FLAT" cutter (also radiused).

If cutting section "B", use the 30° cutter.

If cutting section "C", use the 45° cutter.

- b. Measure valve seat width. Apply mechanic's bluing dye (such as Dykem) to the valve face, apply a very small amount of fine grinding compound around the surface of the valve seat, insert the valve into position, and spin the valve quickly back and forth. Lift the valve, clean off all grinding compound, and check valve seat width. The valve seat will have removed the bluing wherever it contacted the valve face. Measure the seat width with vernier calipers. It should measure approximately 1.1 mm (0.043 in). Also, the seat should be uniform in contact area. If valve seat width varies, or if pits still exist, then continue to cut with the 45° cutter. Remove just enough material to achieve a satisfactory seat.

	Standard width	Wear limit
Seat width	1.1 mm (0.043 in)	1.8 mm (0.071 in)

- c. If the valve seat is uniform around the perimeter of the valve face, but is too wide or not centered on the valve face, it must be altered. Use either the "FLAT", 45°, or 30° cutters to correct the improper seat location in the manner described below:

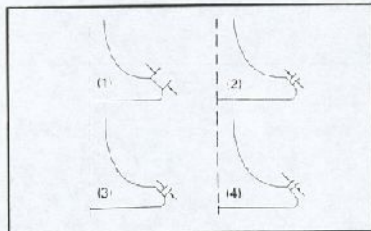

- 1) If the valve face shows that the valve seat is centered on the valve face, but too wide, then lightly use both the "FLAT" and the 30° cutters to reduce the seat width to 1.1 mm (0.043 in).
- 2) If the seat shows to be in the middle of the valve face, but too narrow, use the 45° cutter until the width equals 1.1 mm (0.043 in).
- 3) If the seat is too narrow, and right up near the valve margin, then first use the "FLAT" cutter and then the 45° cutter to get the correct seat width.
- 4) If the seat is too narrow and down near to bottom edge of the valve face, then first use the 30° cutter and then the 45° cutter.
7. Lapping the valve/valve seat assembly
  - a. The valve/valve seat assembly should be lapped if, (1) neither the seat or the valve face are severely worn, or: (2) if the valve face and valve seat have been resurfaced and now require a final light grinding operation for perfect sealing.
  - b. Apply a small amount of coarse lapping compound to the valve face. Insert the valve into the head. Rotate the valve until there is a burnished spot all the way around the valve face. Clean off the coarse compound; then follow the same procedure with fine compound. Continue lapping until the valve face shows a complete and smooth surface all the way around. Clean off all compound material.  
Apply bluing dye to the valve face and rotate the valve face for full seat contact which is indicated by a shiny surface all around the valve face where the bluing has been rubbed away.

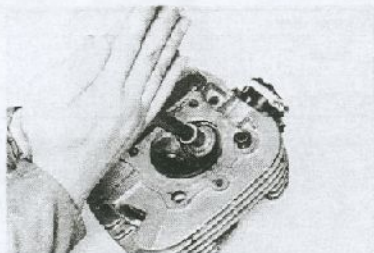

#### Camshaft and Camshaft Bearing

1. Flatten the lock washer.
2. Loosen and remove the bearing retaining bolts.
3. Insert a 10 mm (0.39 in) screw into the camshaft and withdraw the camshaft.

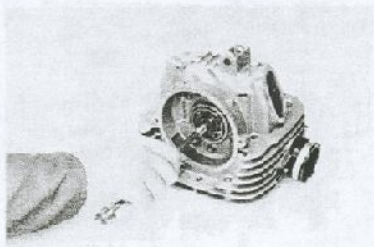

4. Camshaft
  - a. The cam lobe metal surface may have a blue discoloration due to excessive friction. The metal surface could also start to flake off or become pitted. This is due to poor lubrication, incorrect clearances, or normal wear.
  - b. If any of the above wear conditions are readily visible, the camshaft should be replaced.
  - c. Even though the cam lobe surface appears to be in satisfactory condition, the lobes should be measured with a micrometer. Cam lobe wear can occur without scarring the surface. If this wear exceeds a predetermined amount, valve timing and lift are affected. Replace the camshaft if wear exceeds the limits.

Wear limit	A	B
Intake	40.05 mm (1.575 in)	31.99 mm (1.26 in)
Exhaust	40.10 mm (1.575 in)	31.01 mm (1.221 in)

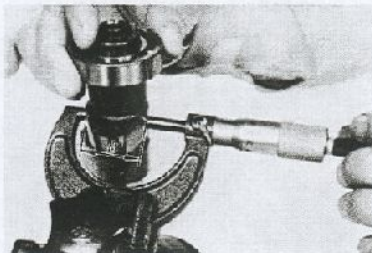
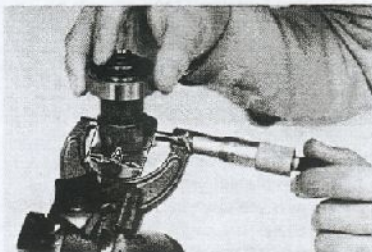

#### 5. Camshaft bearing

Bearings should be cleaned, dried, and the races visually checked for pits, rust spots or chatter marks where the balls have dragged. If any of these conditions exists the bearings should be replaced.

#### NOTE:

Lubricate the bearings immediately after examining them to prevent rust formation.



6. Cam sprocket and cam drive sprocket  
Check the cam sprocket and cam drive sprocket for wear.



#### Cylinder

1. Visually check the cylinder walls for scratches. If vertical scratches are evident, the cylinder wall should be rebored or the cylinder should be replaced.
2. Measure cylinder wall wear in the manner as shown. If wear is excessive, compression pressure will decrease, and engine trouble will occur. Rebore the cylinder wall, and replace the piston and piston rings.

Cylinder wear should be measured at three depths by placing the measuring instrument in parallel to, and at right angles to, the crankshaft. (See the illustration.)

If the cylinder wall is worn more than wear limit, it should be rebored.

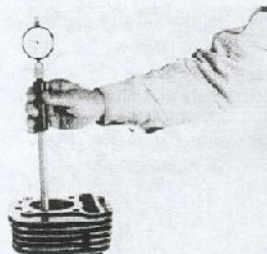

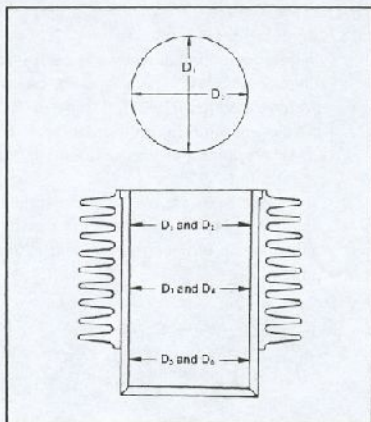

	Standard	Wear limit
Cylinder bore	75.0 ~ 75.02 mm (2.953 ~ 2.954 in)	75.1 mm (2.957 in)
Cylinder taper	—	0.0% mm (0.002 in)

## Piston and Piston Rings

### 1. Piston

- a. Using the micrometer, measure the outside diameter of the piston at the piston skirt.

Measurement should be made at a point 5.5 mm (0.22 in) above the bottom edge of the piston by placing the micrometer in parallel to, and at right angles to, the piston pin.

Piston clearance:  
0.035 ~ 0.055 mm  
(0.0014 ~ 0.0022 in)

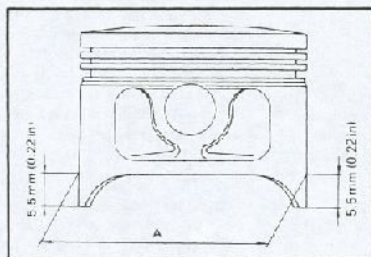

	Size A
Standard	75.00 mm (2.953 in)
Oversize 1	75.25 mm (2.963 in)
Oversize 2	75.50 mm (2.972 in)
Oversize 3	75.75 mm (2.982 in)
Oversize 4	76.00 mm (2.992 in)

- b. Piston ring/ring groove fit must have correct clearance. If the piston and ring have already been used in the engine, the ring must be removed, the ring groove cleaned of carbon. And then the ring should be reinstalled. Use a feeler gauge to measure the gap between the ring and the land.

Side clearance	Top	0.04 ~ 0.08 mm (0.0016 ~ 0.0031 in)
	2nd	0.03 ~ 0.07 mm (0.0012 ~ 0.0028 in)



### 2. Piston ring

- a. The oversize top and middle ring sizes are stamped on top of the ring.

Oversize 1	0.25 mm (0.0098 in)
Oversize 2	0.50 mm (0.0197 in)
Oversize 3	0.75 mm (0.0295 in)
Oversize 4	1.00 mm (0.0394 in)

- b. Expander spacer of the bottom ring (oil control ring) is color-coded to identify sizes. The color mark is painted on the expander spacer.

Size	Color
Oversize 1	Brown
Oversize 2	Blue
Oversize 3	Black
Oversize 4	Yellow

- c. Insert each ring into the cylinder and push it down approximately 20 mm (0.8 in), using the piston crown so that the ring forms the right angles to the cylinder bore. Measure the end gap of the ring with a feeler gauge. If the gap is beyond tolerance, replace the whole set of rings.

**NOTE:**

The end gap on the expander spacer of the oil control ring is unmeasurable. If the oil control ring rails show excessive gap all three components should be replaced.

	Standard	Limit
Top/2nd ring	0.2 ~ 0.4 mm (0.0079 ~ 0.0157 in)	0.80 mm (0.0315 in)
Oil control (Rail)	0.3 ~ 0.9 mm (0.0118 ~ 0.0354 in)	—

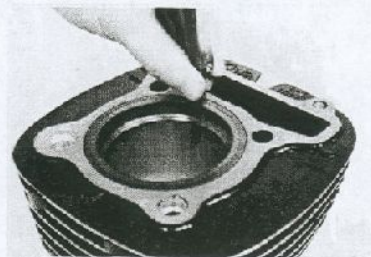

**Piston Pin**

1. Apply a light film of oil to pin. Install in connecting rod small end. Check for play. There should be no noticeable vertical play. If play exists, check connecting rod small end for wear. Replace pin and connecting rod as required.
2. The piston pin should have no noticeable free play in position. If the piston pin is loose, replace the pin and/or the piston.

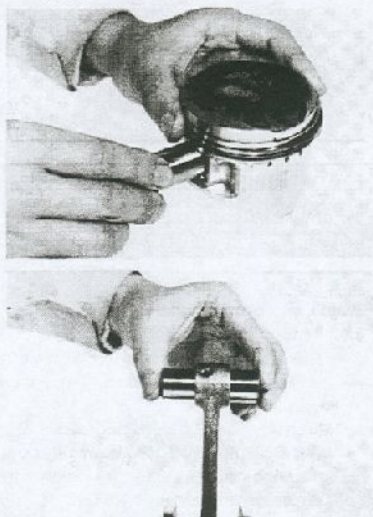

**Crankshaft**

1. Check crankshaft components per chart.

Check connecting rod axial play at small end (to determine the amount of wear or crank pin and bearing at big end).	Small end play should not exceed 2 mm (0.079 in).	If small end play exceeds 2 mm (0.079 in) disassemble crankshaft, check connecting rod, crank pin and big end bearing. Replace defective parts. Play after reassembly should be within 0.8 ~ 1.0 mm (0.031 ~ 0.039 in).
Check the connecting rod side clearance at big end.	Move the connecting rod to one side and insert a feeler gauge. Big end axial play should be within 0.35 ~ 0.65 mm (0.014 ~ 0.026 in).	If excessive axial play is present, 0.7 mm (0.028 in) or more, disassemble the crankshaft and replace any worn parts.
Check crankshaft assembly runout. (Misalignment of crankshaft parts.)	Dial gauge readings should be within 0.03 mm (0.00118 in).	Correct any misalignment by tapping the flywheel with a brass hammer and by using a wedge.

## 2. Crankshaft Specifications

Unit: mm (in.)

Deflection tolerance		Flywheel width	Rod clearance			
			Axial "P"		Side "C"	
Left side "1"	Right side "2"	"F"	New	Max.	Min.	Max.
0.03 (0.0012)	0.03 (0.0012)	58.95 ~ 59.00 (2.321 ~ 2.323)	0.8 ~ 1.0 (0.03 ~ 0.04)	2.0 (0.08)	0.3 (0.0118)	0.65 (0.0256)

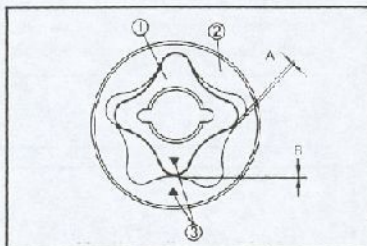
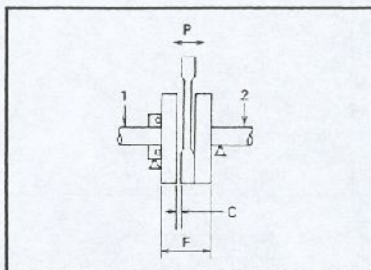

1. Inner rotor 2. Outer rotor 3. Match marks

3. In disassembling and reassembling the crank, follow the illustrated below.

### NOTE:

Make sure oil passages of crank and crank pin are lined up during assembly.

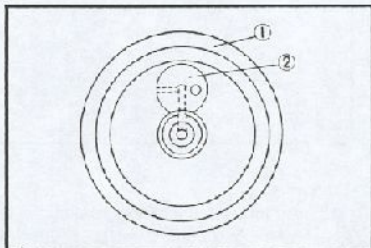

1. Crank assembly 2. Crank pin

### Oil Pump

1. Trochoid pump rotor width

Delivery pump: 12 mm (0.47 in)

2. Rotor dimensions-inner and outer

Clearance between A and B standard:  
0.03 ~ 0.09 mm  
(0.0012 ~ 0.0035 in)

### Primary Drive

The drive gear is mounted on the crankshaft and the driven gear is integral with the clutch assembly and mounted on the transmission main shaft.

Primary reduction ratio		
No. of teeth		Ratio
Drive	Driven	
23	72	3.130

1. Check the drive gear and driven gear for obvious signs of wear or damage from foreign material within the primary case.
2. If primary drive gears exhibit excessive noise during operation, gear lash may be incorrect.

Numbers are scribed on the side of each gear. Add these numbers. If their total exceed tolerance, replace with a numbered gear that will bring total within specification.

### NOTE:

This procedure is rarely required. However, if a gear must be replaced due to damage, it is always advisable to pay strict attention to the lash numbers during replacement.

Lash tolerance	Lash numbers
	183 ~ 185

## Clutch

### 1. Checking friction plates

The friction plates are liable to wear. The standard thickness of the friction plate is 2.8 mm (0.11 in). If it is worn more than 0.3 mm (0.012 in) or has uneven wear, it should be replaced.

Clutch friction plate wear limit:  
2.5 mm (0.10 in)

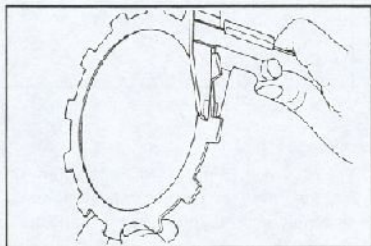

### 2. Measure clutch plates

Check clutch plate warpage, and if warpage is more than specified, the clutch plate should be replaced.

Clutch plate warpage limit:  
0.05 mm (0.0020 in)

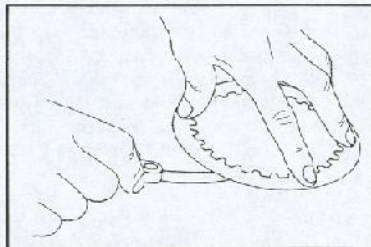

### 3. Checking clutch springs

Using the vernier caliper, measure the free length of each spring. If it measures 1.0 mm (0.04 in) less than specified, it should be replaced.

## Clutch spring specifications:

Number of springs	4
Free length	34.6 mm (1.36 in)
Spring rate	2.6 kg/mm (145.6 lb/in)

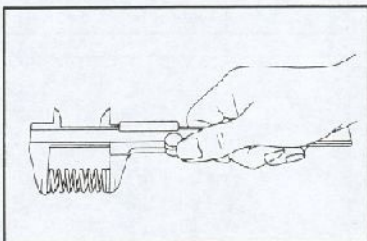

### 4. Checking the push rod

By rolling the push rod on the "V" block, and check for bends. If any bend is found, replace the push rod.

Bend limit: 0.5 mm (0.02 in)

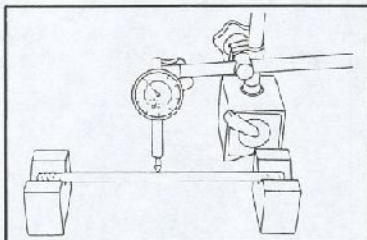

## Transmission

1. Inspect each shift fork for signs of galling on gear contact surfaces. Check for bending. Make sure each fork slides freely on its guide bar.

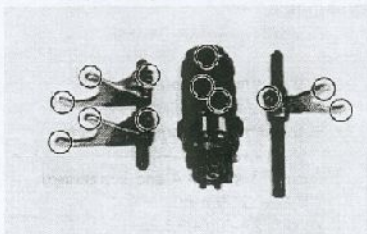

2. Roll the guide bars across a surface plate. If any bar is bent, replace.
3. Check the shift cam grooves for signs of wear or damage. If any profile has excessive wear and/or any damage, replace cam.
4. Check the cam followers on each shift fork wear. The follower should fit snugly into its seat in the shift fork, but not over-tight.  
Check the ends that ride in the grooves in the shift cam. If they are worn or damaged, replace.
5. Check shift cam dowel pins and side plate for looseness, damage, or wear. Repair as required.
6. Check the transmission shafts using a centering device and dial gauge. If any shaft is bent, replace.
7. Carefully inspect each gear. Look for signs of obvious heat damage (blue discoloration). Check the teeth for signs of pitting, galling, or other extreme wear. Replace as required.
8. Check to see that each gear moves freely on its shaft.
9. Check to see that all washers and clip are properly installed and undamaged. Replace bent or loose clips and bent washers.
10. Check to see that each gear properly engages its counterpart on the shaft. Check the mating dogs for rounded edges, cracks, or missing portions. Replace as required.

### Bearings and Oil Seals

#### 1. Inspection

- a. After cleaning and lubrication bearings, rotate inner race with a finger. If rough spots are noticed, replace the bearing.
- b. Check oil seal lips for damage and wear. Replace as required.

#### 2. Removal

- a. Pry oil seal(s) out of place using a slot head screwdriver.  
Always replace all oil seals when overhauling engine.

#### NOTE:

Place a piece of wood under the slot head screwdriver to prevent damage to case.

- b. Drive out bearing(s) with socket and hammer.

#### NOTE:

Bearing(s) are most easily removed or installed if the cases are first heated to approximately 95° ~ 125°C. Bring the case up to proper temperature slowly. Use an oven.

#### 3. Installation

Install bearing(s) and oil seal(s) with their manufacturer's marks or numbers facing outward. (In other words, the stamped letters must be on the side exposed to view.) When installing bearing(s) or oil seal(s), apply a light coating of light-weight lithium base grease to balls and seal lip(s).

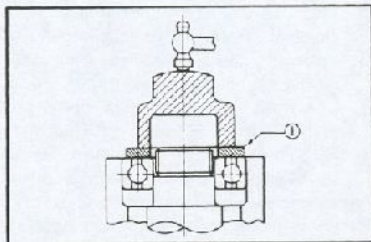

1. Spacer

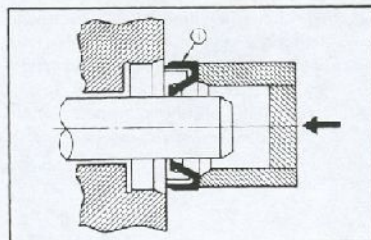

1. Oil seal



**CAUTION:**

The crankshaft oil seal (right side) on the crankcase cover right, should be installed in a way reverse to the normal direction as shown.

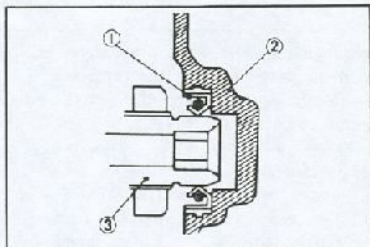

1 Oil seal 2 Crankcase cover 3 Crankshaft

**Crankcase**

1. Thoroughly wash the case halves in mild solvent.
2. Clean all gasket mating surfaces and crankcase mating surface thoroughly.
3. Visually inspect case halves for any cracks, road damage, etc.
4. Check all fittings not previously removed for signs of loosening or damage.
5. If bearings have been removed, check their seats for signs of damage (such as the bearing spinning in the seat, etc.).
6. Check oil delivery passages for signs of blockage.
7. If bearings have not been removed, oil them thoroughly immediately after washing and drying. Rotate the bearing checking for roughness indicating damaged races or balls.
8. Check needle bearing(s) in transmission for damage. Replace as required.

**ENGINE ASSEMBLING AND ADJUSTMENT****Crankshaft Installation**

After all Bearings and seals have been installed in both crankcase halves; install crankshaft as follows:

1. Place the left crankcase underside.
2. Fit the crankshaft onto the left case half by tapping the crankpin area with a soft head hammer while turning the crankshaft. Work slowly and carefully. Make sure the crankshaft is set evenly.

**NOTE:**

Pay attention to the parallelism between the crankweb and the crankcase surface.

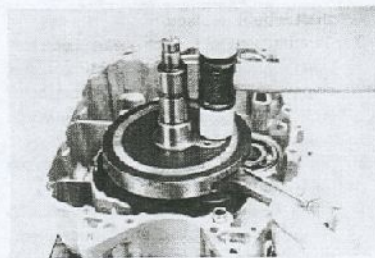

3. Install the drive axle and main axle.

**NOTE:**

While installing the drive axle into the crankcase, pay careful attention to the oil seal lip.

It is recommended to set a suitable "O-ring" into the drive axle groove.

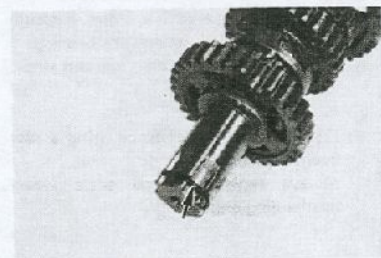

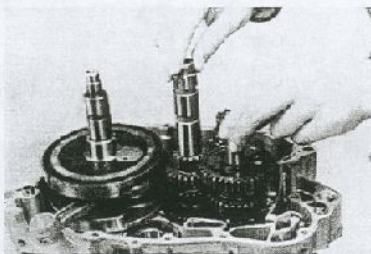

4. Install the shift cam.
5. Install the shift fork 1 and 2.
6. Check to see that all parts move freely prior to installing right case half. Check for correct transmission operation and make certain that all loose shims are in place.

**NOTE:**

Oil each gear and bearing thoroughly.

7. Install the balance weight.
8. Apply Yamaha Bond No. 4 to the mating surfaces of both case halves. Apply thoroughly, over all mating surfaces.

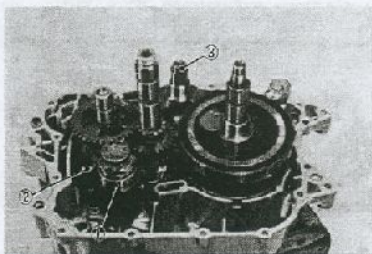

1. Shift cam 2. Shift fork 3. Balance weight

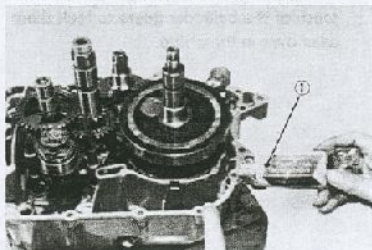

1. Yamaha Bond No. 4

9. Set the crankcase right half onto the shafts and tap lightly on the case with a soft head hammer to assemble.

**NOTE:**

Do not tap on machined surface or end of crankshaft.

10. Install all crankcase bolts and tighten in stages, using a crisscross pattern.
11. After reassembly, apply a liberal coating of 4-stroke engine oil to the crank pin and bearing.
12. Check crankshaft and transmission shafts for proper operation and freedom of movement.

**Shifter**

1. Set the stopper lever.
2. During installation, note the index mark on the shift lever 2 and center of shift lever 1. Align.

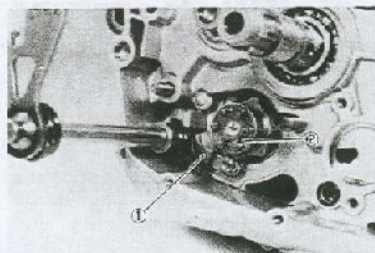

1. Stopper lever 2. Shift cam

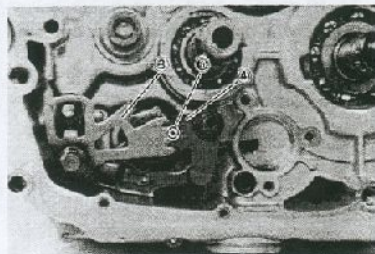

3. Shift lever 1 4. Shift lever 2 5. Align the mark

## Oil Pump

1. Install the delivery pump rotor assembly.

### NOTE:

Apply a liberal coating of 4-stroke engine oil to the oil pump rotor.

2. Install the pump cover with driven gear.
3. Install the oil pump idle gear.

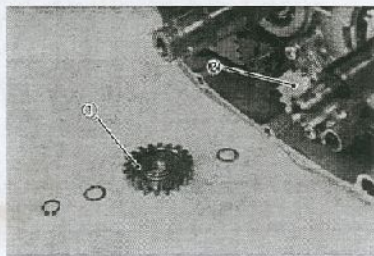
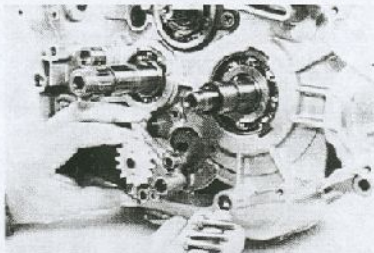

1. Pump idle gear    2. Pump driven gear

## Balancer Drive Gear and Driven Gear

1. Fit into the balancer gear the buffer boss with dowel pins set every other interval.
2. Place bearing covers on both sides of the balancer gear and install.

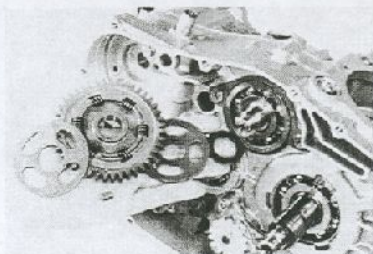
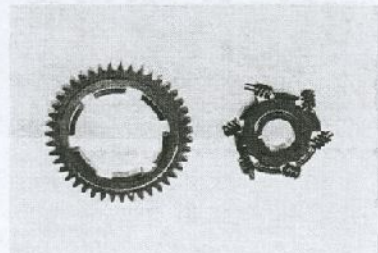

3. Install the keys for the balancer drive and driven gears with the marks in alignment.

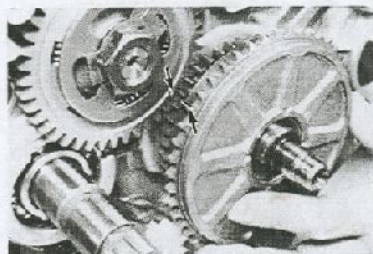
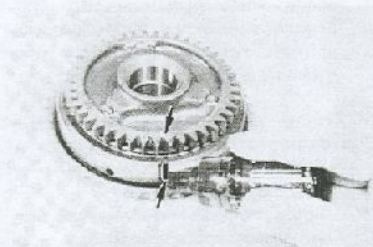

4. Tighten the balancer gear lock nut by first placing a folded rag between the teeth of the balancer gears to lock them as shown in the photo.

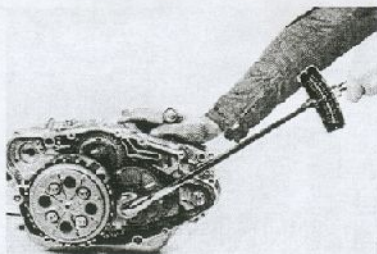

Tightening torque:  
6.0 m·kg (43.4 ft·lb)

5. Bend the lock washer.
6. Install the starter clutch assembly and the primary drive gear then install the starter motor with the chain.

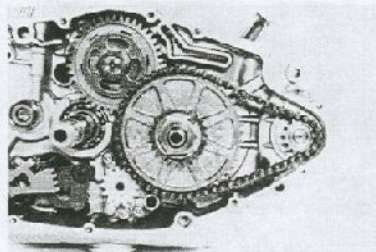

#### Push Lever Assembly

1. Install the push lever assembly.
2. Tighten the set screw.

Set screw torque: 1.2 m·kg (8.7 ft·lb)

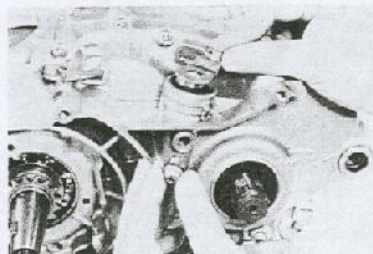

#### Clutch

1. First install the primary drive gear.
2. Install the clutch housing, thrust plate, push rod 2, ball and clutch boss in that order.
3. Install clutch holding tool on clutch boss and tighten lock nut.

Clutch lock nut torque  
7.0 m·kg (50.6 ft·lb)

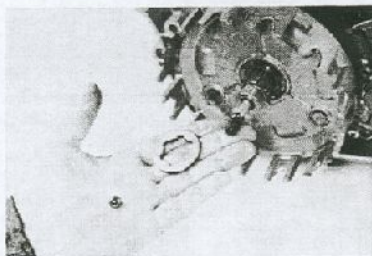

4. Install the push rod 2 and ball into main axle.
5. Install clutch plate and friction pte.
6. Install clutch pressure plate.
7. Continue installation of clutch and friction plates.

#### NOTE:

Align the arrow mark on the clutch boss and pressure plate mark.

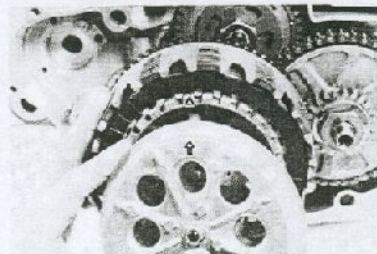

8. Tighten the primary drive lock nut by first placing a folded rag between the teeth of the primary gears to lock them as shown in the photo.

Primary drive lock nut torque:  
7.0 m·kg (50.6 ft·lb)

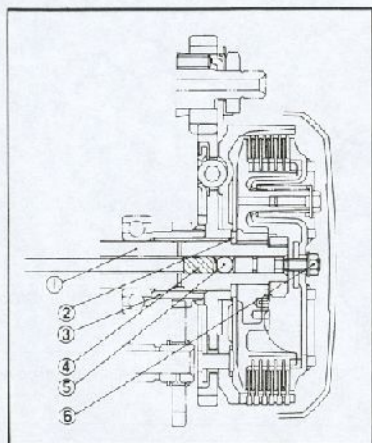
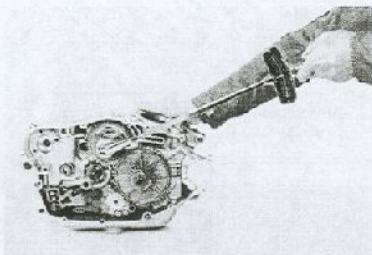

- |                     |                       |
|---------------------|-----------------------|
| 1. Main axle        | 4. Pushrod 2          |
| 2. Thrust plate     | 5. Ball               |
| 3. Kick pinion gear | 6. Pushrod 1 lock nut |

### Clutch Adjustment

With the crankcase index mark and the pointed end of the push lever in line with each other, adjust the push rod and then secure it with the lock nut.

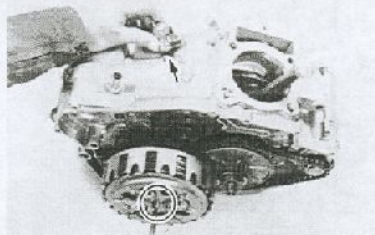

### Crankcase Cover Right

1. Install the crankcase cover.
2. Install the oil filter element and cover.

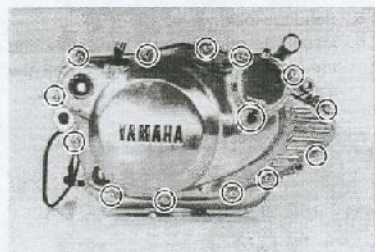

### NOTE:

Tighten the screws using crisscross pattern.

### Piston

1. Mount the piston (rings installed) onto the connecting rod.  
Be sure the arrow stamped on the piston crown points forward.
2. Install new piston pin clips in their grooves.



3. During reassembly, coat the piston ring grooves, piston skirt areas, and piston pin with 4-stroke engine oil.

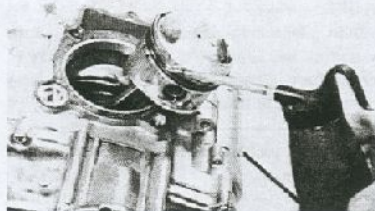

#### Cylinder

1. Install the cam chain guide to the crank case.
2. Install the new "O-ring" and cylinder base gasket.

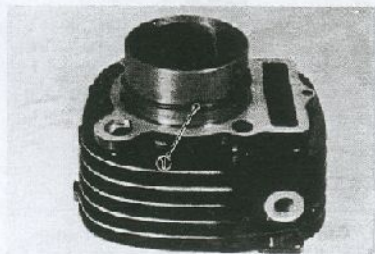

1. O-ring

3. Off-set the three ring end gaps as shown.

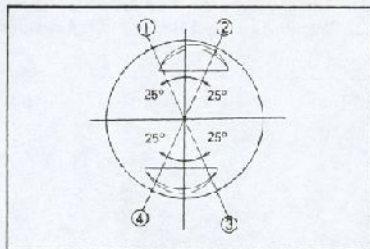

1. Top  
2. Oil ring (Lower roll)    3. 2nd  
4. Oil ring (Upper roll)

4. Install the cylinder with one hand while compressing piston rings with other hand.

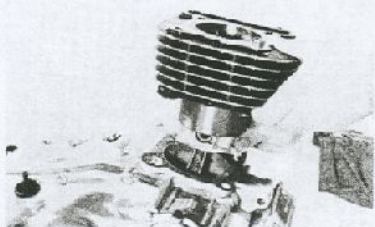

5. Install the cylinder holding bolt.

#### Cylinder Head

1. Install the cylinder head gasket and cylinder head.
2. Tighten the cylinder head temporarily (final tightening to follow)

#### Tightening torque:

10 mm bolt.....	4 pcs
3.7 m·kg (26.8 ft·lb)	
8 mm bolt.....	2 pcs
2.0 m·kg (14.5 ft·lb)	
6 mm bolt.....	1 pc
0.7 m·kg (5.1 ft·lb)	

#### Cam Shaft, Cam Shaft Driven Sprocket, Cam Chain

1. Install the cam shaft, bearing plate and lock washer.
2. Tighten the bolt and bend the lock washer.

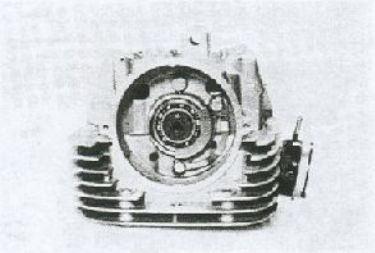

3. Install the chain while aligning the marks on the sprocket and cylinder head and also the marks on the crankshaft and crankcase as shown in the following photos.

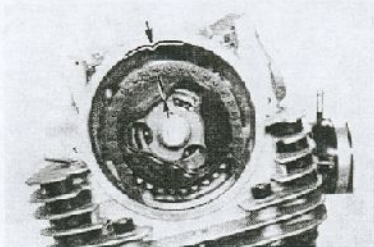

4. Install the flywheel magneto base to left side of crankcase.

**NOTE:**

1. If the "O-ring" is defective, swollen or deteriorated, replace it.
2. Apply a thin coat of grease over the "O-ring" and then put the magneto plate in the crank case.  
Pay attention to the parallelism between the plate and the crankcase surface.
3. Install the lead wire grommet properly.

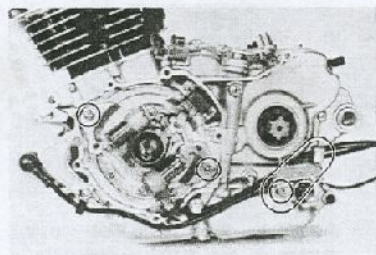

5. Clamp the lead wire to the crankcase.

**NOTE:**

Be sure the lead wire will not become loosen.

6. Install the flywheel.

**NOTE:**

When installing flywheel, make sure woodruff key is properly seated in keyway of crankshaft. Carefully install flywheel taking care to align with woodruff key.

7. Install plate washer, spring washer and lock nut.

Tightening torque: 8.0 m·kg (57.8 ft·lb)

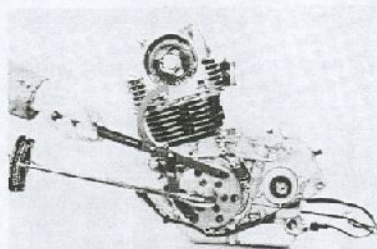

8. Tighten the cam sprocket bolt.

Cam sprocket bolt tightening torque:  
5.5 m·kg (39.8 ft·lb)

9. Install the chain tensioner assembly. Adjust the tensioner. (Refer to the Chapter 2, "Cam chain adjustment")
10. Install the adjuster cap and tighten the cap.

Tightening torque: 0.5 m·kg (3.6 ft·lb)

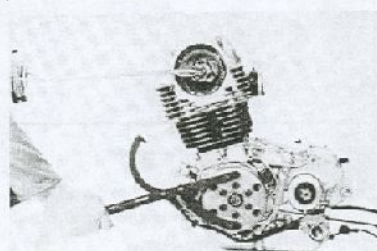



### Drain Plug

Install and tighten the drain plug before filling engine oil.

Tightening torque: 3.2 m·kg (23.1 ft·lb)

## MOUNTING

Refer to Chapter 3, "Removal" and mount the engine in the frame as follows:

1. Place the engine in the frame from right side.
2. Install engine mounting bolts and nuts with proper tightening torque.

Engine mounting bolts	Tightening torque			
	Bolt size	Qty	m·kg	ft·lb
Pivot shaft	14 mm	1	6.5	47.0
Front under	8 mm	4	3.2	23.1
Rear under	8 mm	1	3.2	23.1
Rear under	8 mm	2	2.0	14.5
Upper	8 mm	3	3.2	23.1

3. Install the lead wire, plug cap and breather pipe.
4. Install carburetor assembly.
5. Install the drive sprocket with the drive chain and the sprocket holder. Tighten the two bolts.

Tightening torque: 1.0 m·kg (7.2 ft·lb)

6. Install the plate washer and spacer over the shift shaft.
7. Install the left crankcase cover and tighten bolts.
8. Install the shift pedal and tighten the bolt.
9. Install and adjust the clutch wire as shown in "Chapter 2".
10. Install the exhaust pipe assembly.
11. Install the fuel tank and seat.
12. Install the brake rod wing nut and the return spring.
13. Start the engine and check oil pressure, oil leakage and cam chain adjustment. See Engine oil checking procedure in Chapter 2.



## CHAPTER 4. CARBURETION

AIR FILTER.....	4-1
CARBURETOR.....	4-1
Component.....	4-1
Disassembly.....	4-2
Fuel Level.....	4-4
Function.....	4-5

## CHAPTER 4. CARBURETION

### AIR FILTER

1. The air filter is housed within a case below the seat.

### CARBURETOR

#### Component

2. The filter is made of polyurethane foam with a stiff bristle covering.
3. For carburetor to function properly, the filter must be in place and it must be camp with oil to provide adequate protection for vital engine parts.
4. For air filter maintenance see Chapter 2. "Air Filter"

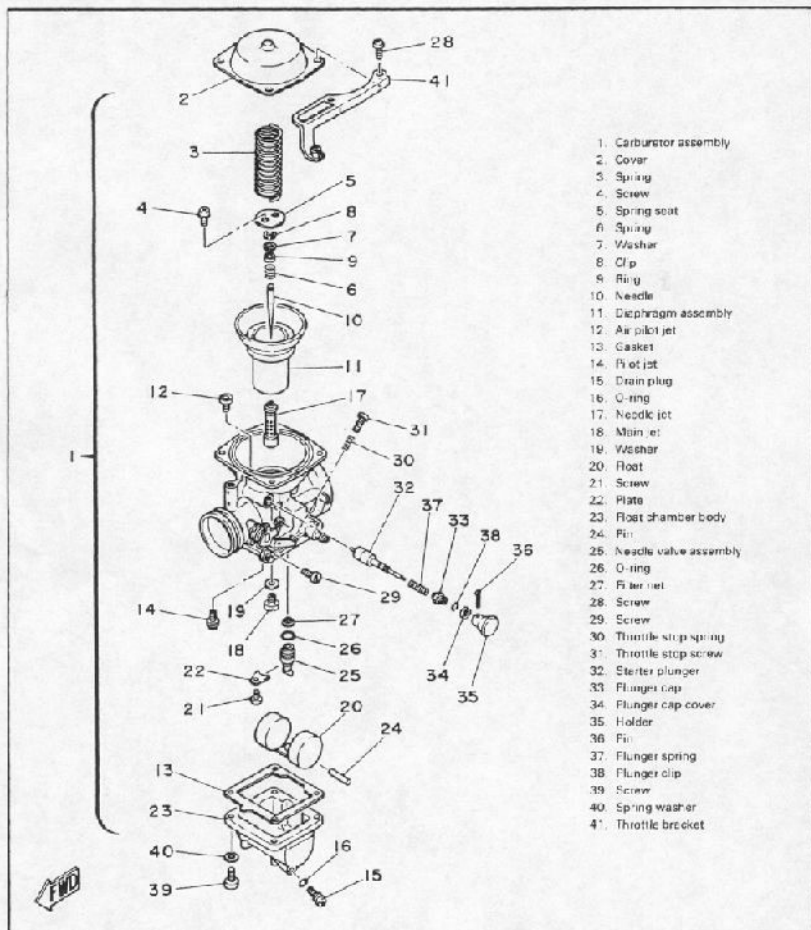

## Disassembly

Remove the following parts as shown.

### NOTE:

1. Wash the carburetor in petroleum base solvent. Wash all associated parts.
2. Using high pressure air, blow out all passages and jets. Never use high pressure air if float is in place.
3. Inspect the needle and seat for signs of excessive wear or attached foreign particles. Replace as required. Always replace inlet needle and inlet seat as an assembly.

#### 1. Starter assembly

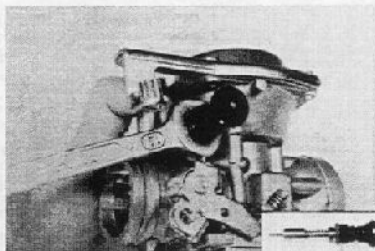

#### 2. Mixing chamber top

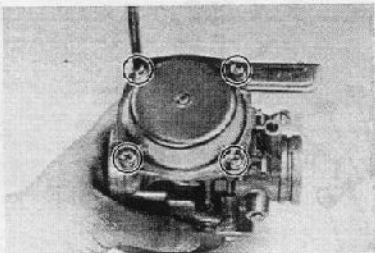

#### 3. Air pilot jet

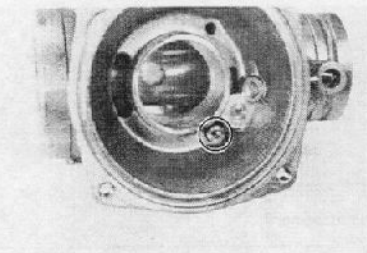

#### 4. Vacuum piston and jet needle

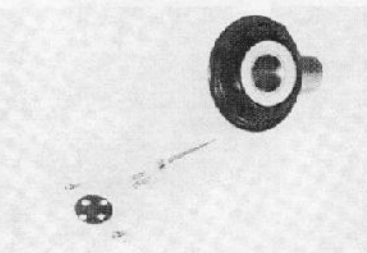
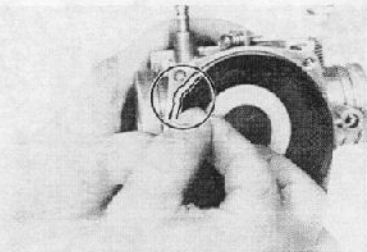

#### 5. Butterfly valve

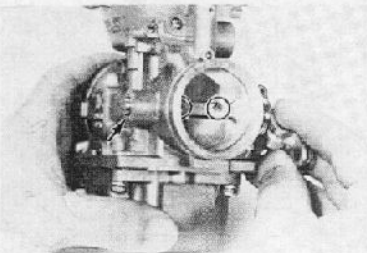

6. Float chamber

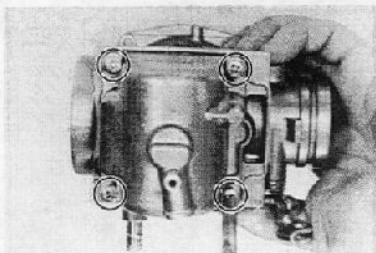

7. Float

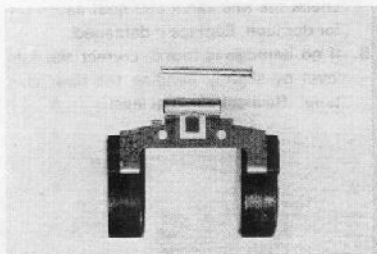
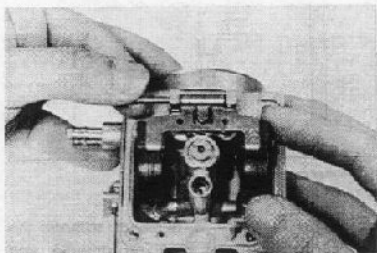

8. Needle valve

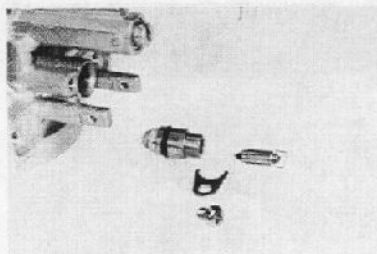

9. Main jet and needle jet

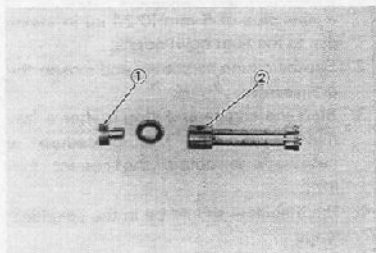
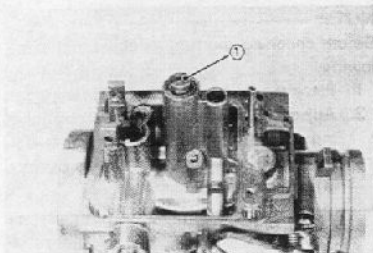

1. Main jet 2. Needle jet

10. Pilot jet

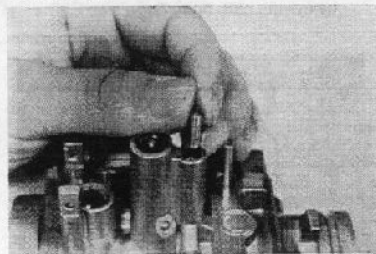

## Fuel Level

### NOTE:

Before checking the fuel level, note the following:

1. Place the motorcycle on a level surface.
2. Adjust the motorcycle position by placing a suitable stand or a garage jack under the engine so that the carburetor is positioned vertically.

1. Connect the level gauge (special tool) or a vinyl pipe of 6 mm (0.24 in) in inside dia. to the float bowl nozzle.
2. Set the gauge as shown and loosen the drain screw.
3. Start the engine and stop it after a few minutes of run. This procedure is necessary to obtain the correct fuel level.
4. The fuel level should be in the specified range.

Specified range:

2 to 4 mm (0.079 ~ 0.148)  
below the carb body edge

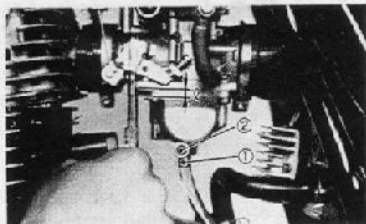

1. Drain nozzle
2. Drain screw
3. Fuel level gauge
2. Fuel level

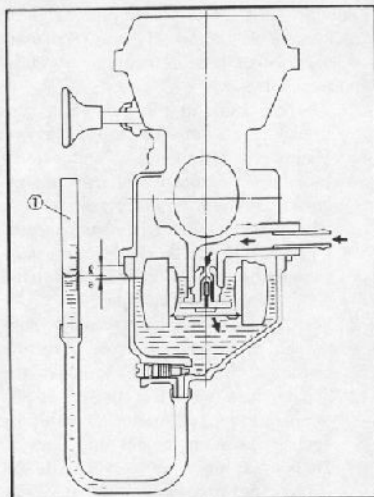

1. Fuel level gauge
2. Fuel level
- a. Surface tension
- b. = 2.0 mm (0.08 in)

5. If the fuel level is incorrect, remove the carburetor from the motorcycle and check the fuel valve and float assembly for damage. Replace if damaged.
6. If no damage is found, correct the fuel level by slightly bending the float arm tang. Recheck the fuel level.

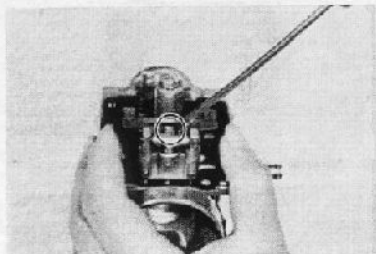

## Function

This model is equipped with "constant velocity" (CV) carburetor mounted on rubber intake manifolds.

1. Air flow through the venturi is controlled by a throttle slide (vacuum piston). The slide is raised and lowered by engine vacuum rather than a cable linked directly to the throttle grip. This type of carburetor compensates automatically for atmospheric pressure changes such as those encountered when riding at high altitudes.
2. With a conventional one-position starter jet, the air-fuel ratio remains the same as that required to start the engine (despite the fact that the engine temperature rises gradually) until the engine operating temperature rises to the point at which use of the starter jet is no longer necessary. In other words, beyond a certain point, the air-fuel mixture is too rich until the engine operating temperature rises to a certain point and the starter jet is shut off.

The newly-adopted two-position type starter jet is designed to supply a mixture of more appropriate richness by switching from one jet to another.

### a. Routes of fuel and air

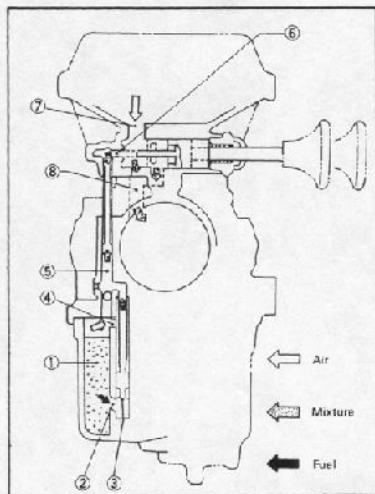

The fuel supplied from the float chamber (1) passes through (2) and is metered by (3). Air is supplied from the air chamber in the float chamber and flows through (4). It is then mixed with the metered fuel. The resultant mixture passes through (5) and flows into the two-position starter jet (6), where it is further mixed with air supplied from the diaphragm (7) and streams into the throttle bore out of (8).

### b. Operation of two-position starter jet

#### Full-open:

To start a cold engine, a rich mixture is required. To supply a rich mixture, pull the starter lever and the way out so that the needle regulating the fuel flow is set free and the flow rate of incoming fuel is increased to a maximum. The fuel is mixed with the air supplied from the diaphragm lower chamber, and thus a rich mixture is produced.

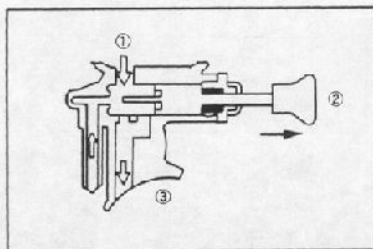

1. Diaphragm lower chamber 2. Full-open 3. Throttle bore

#### Half open:

After starting, that is, during warm-up, a slightly rich mixture is required. Push back the starter lever half-way so that the fuel flow is reduced by the needle. The fuel is mixed with the air from the diaphragm lower chamber, and thus a slightly rich mixture is produced.

1. Float chamber
2. Fuel inlet
3. Starter jet
4. Bleed air jet
5. Mixture passage
6. Needle jet
7. Air inlet
8. Mixture outlet

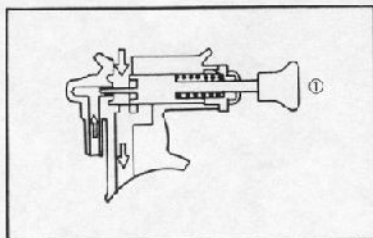

1. Half-open

**Full-closed:**

When the engine fully warms up, no mixture from the starter circuit is necessary. Push the starter lever all the way in so that the flow of incoming fuel is stopped by the plunger, and thus no mixture enters the throttle bore.

**NOTE:**

Use of the starter jet in either open position after the engine has warmed up to operating temperature will result in excessive exhaust emissions and poor performance.

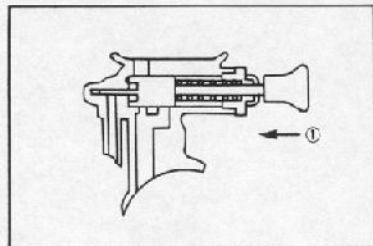

1. Full-closed

## CHAPTER 5. CHASSIS

FRONT WHEEL .....	5-1
Removal .....	5-1
Front Axle .....	5-1
Checking Brake Shoe Wear .....	5-1
Brake Drum .....	5-1
Brake Shoe Plate .....	5-1
Replacing Wheel Bearings .....	5-1
Front Wheel Installation .....	5-1
REAR WHEEL .....	5-2
Removing the Rear Wheel .....	5-2
Checking Brake Shoe Wear .....	5-2
Brake Drum .....	5-2
Replacing Wheel Bearings .....	5-2
Installing Rear Wheel .....	5-2
RIMS AND SPOKES (FRONT AND REAR WHEEL) .....	5-2
Checking for Loose Spokes .....	5-2
Checking Rim "Run-Out" .....	5-2
TIRES AND TUBES .....	5-2
Removal .....	5-2
Installation .....	5-3
DRIVE CHAIN AND SPROCKETS .....	5-3
Drive Sprocket .....	5-3
Driven Sprocket .....	5-4
Chain Inspection .....	5-4
Chain Maintenance .....	5-4
FRONT FORKS .....	5-5
Disassembly .....	5-5
Inspection .....	5-6
Assembly .....	5-6
STEERING HEAD .....	5-6
Adjustment .....	5-6
Disassembly .....	5-6
Inspection .....	5-7
Installation .....	5-7



SWING ARM.....	5-9
Inspection.....	5-9
Lubrication.....	5-9
Removal.....	5-9
REAR SHOCK ABSORBERS.....	5-10
Removal.....	5-10
Inspection.....	5-10
CABLES AND FITTINGS.....	5-10
Cable Maintenance.....	5-10
Throttle Maintenance.....	5-10
Lubrication of Levers, Pedals, etc.....	5-10

## CHAPTER 5. CHASSIS

### FRONT WHEEL

#### Removal

1. Disconnect the brake and speedometer cable at the front brake lever.
2. Remove the cotter pin from the front axle.
3. Remove the front axle nut.
4. Remove the front wheel axle by simultaneously twisting and pulling out on the axle. Then remove the wheel assembly.

#### NOTE:

Raise the front of the motorcycle by placing a suitable stand under the engine.

#### Front Axle

Remove any corrosion from axle with emery cloth. Then place it on a surface plate and check for bending. If bent, replace.

#### Checking Brake Shoe Wear

1. Measure the outside diameter at the brake shoes with slide calipers.

Front brake shoe diameter:  
152 mm (5.98 in)  
Replacement limit:  
148 mm (5.83 in) min.

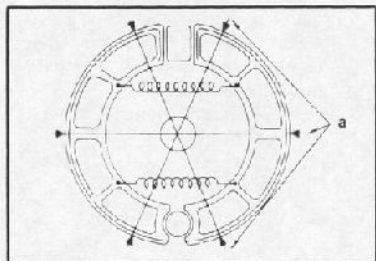

a. Measuring points

2. Remove any glazed areas from brake shoes using coarse sand paper.

#### Brake Drum

Oil or scratches on the inner surface of the brake drum will impair braking performance or result abnormal noises.

Remove oil by wiping with a rag soaked in lacquer thinner or solvent.

Remove scratches by lightly and evenly polishing with emery cloth.

#### Brake Shoe Plate

Remove the camshaft and grease. If the cam face is worn, replace.

#### NOTE:

Before removing the cam lever, put a match mark on the cam lever and camshaft to indicate their positions for easy assembly.

#### Replacing Wheel Bearings

If the bearings allow play in the wheel hub or if wheel does not turn smoothly, replace the bearings as follows:

1. First clean the outside of the wheel hub.
2. Drive the bearing out by pushing the spacer aside (the spacer "floats" between the bearings) and tapping around the perimeter of the bearing inner race with a soft metal drift pin and hammer. Either or both bearings can be removed in this manner.
3. To install the wheel bearing, reverse the above sequence. Be sure to grease the bearing before installation. Use a socket that matches the outside race of the bearing as a tool to drive in the bearing.

#### Front Wheel Installation

When installing front wheel, reverse the removal procedure taking care of the following points:

1. Check for proper engagement of the boss on the outer fork tube with the locating slot on the brake shoe plate.
2. Always secure the front wheel axle as follows:
  - a. Torque the axle nut.

Axle nut torque:  
10.6 m·kg (77.5 ft·lb)

- b. Install a new cotter pin; discard old pin.

## REAR WHEEL

### Removing the Rear Wheel

1. First remove the adjust nut and return spring from the brake rod; then, remove the brake rod and pin from the cam lever while pulling them apart.
2. Remove the cotter pin from the rear axle and loosen the axle nut.
3. The rear wheel can be removed by not necessarily cutting the chain. If you cut the drive chain, use the chain cutter (special tool). See page 3-2.

### Checking Brake Shoe Wear

See front wheel section, "Checking Brake Shoe Wear"

Rear brake shoe diameter: 122 mm (4.80 in) Replacement limit: 118 mm (4.65 in) min.
--

### Brake Drum

See front wheel section, "Brake Drum".

### Replacing Wheel Bearings

See front wheel section, "Replacing Wheel Bearings".

### Installing Rear Wheel

The rear wheel can be reassembled by reversing the disassembly procedure. Note the following points.

1. When installing the chain, make certain the closed end of the master link clip is facing direction of rotation.
2. Check for proper engagement of the boss on the swing arm with the locating slot on the brake shoe plate.
3. Make sure the rear wheel axle is inserted on the left-hand side and that the chain pullers are installed with the punched side outward.
4. Make sure the rear wheel axle nut is properly torqued.

Tightening torque: 10.6 m-kg (76.7 ft-lb)
--

## RIMS AND SPOKES

### (FRONT AND REAR WHEELS)

#### Checking for Loose Spokes

Loose spokes can be checked by bracing the motorcycle off the ground so that the wheel can spin freely.

Slowly rotate the wheel and at the same time let the metal shaft of a fairly heavy screwdriver bounce off each spoke. If all the spokes are tightened approximately the same, then the sound given off by the screwdriver hitting the spokes should sound the same. If one spoke makes a dull flat sound, then check it for looseness. (See chapter 2, "Front brake and wheel".)

#### Checking Rim "Run-Out"

See chapter 2, "Front brake and wheel".

## TIRES AND TUBES

### Removal

1. Remove the valve cap, valve core, and valve stem lock nut.
2. When all air is out of tube, separate tire bead from rim (both sides) by stepping on tire with your foot.
3. Use two tire removal irons (with rounded edges) to work the tire bead over the edge of the rim, starting 180° opposite the tube stem. Take care to avoid pinching the tube as you do this.
4. After you have worked one side of the tire completely off the rim, then you can slip the tube out. Be very careful not to damage the stem while pushing it back out of the rim hole.
5. For tire removal, work the other bead off the rim.

## Installation

Reinstalling the tire and tube can be accomplished by reversing the disassembly procedure. The only difference in procedure would be right after the tubes has been installed, but before the tire has been completely slipped onto the rim, momentarily inflate the tube. This removes any creases that might exist. Release the air and continue with reassembly. Also, right after the tire has been completely slipped onto the rim, check to make sure that the stem comes out of the hole in the rim at a right angle to the rim. Finally, inflate the tire.

	FRONT	REAR
Standard tire	Yokohama 3 00-18-4PR	Yokohama 120/90-16.63P
Cold tire pressure Up to 90 kg (198 lb) load*	1.8 kg/cm <sup>2</sup> (26 psi)	2.0 kg/cm <sup>2</sup> (28 psi)
90 kg (198 lb) load ~ 156 kg (344 lb) load* (Maximum load)	2.0 kg/cm <sup>2</sup> (28 psi)	2.3 kg/cm <sup>2</sup> (32 psi)
High speed riding	2.0 kg/cm <sup>2</sup> (28 psi)	2.3 kg/cm <sup>2</sup> (32 psi)
Minimum tire tread depth	0.8 mm (0.03 in.)	0.8 mm (0.03 in.)

\* Total weight of accessories, etc. excepting motorcycle.

If a tire tread shows cross-wise lines, it means that the tire is worn to its limit. Replace the tire.

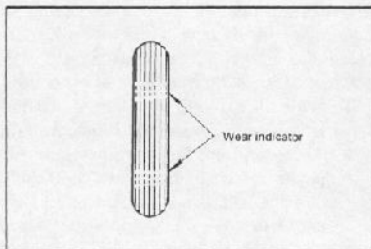

## DRIVE CHAIN AND SPROCKETS

### NOTE:

Please refer to General maintenance and Lubrication charts for additional information.

### Drive Sprocket

With the left crankcase cover removed proceed as follows:

1. Remove the sprocket securing bolts. Remove the holder plate and drive sprocket.
2. Check sprocket wear. Replace if wear decreases tooth width as shown.
3. Replace if tooth wear shows a pattern such as that in the illustration, or as precaution and common sense dictate.
4. Tighten the securing bolts.

### Drive Sprocket

#### Securing Bolt Torque:

1.0 m·kg (7.2 ft·lb)

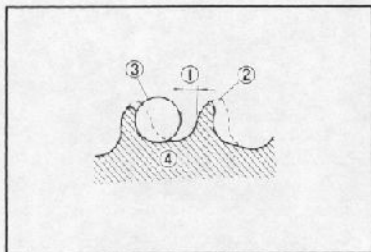

1. 1/4 tooth
2. Corset
3. Roller
4. Sprocket

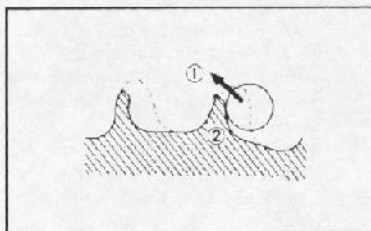

1. Slip off
2. Bent teeth

### Driven Sprocket

With the rear wheel removed, proceed as follows:

1. Using a blunt chisel, flatten the securing nuts lock washer tabs. Remove the securing nuts. Remove the lock washers and sprocket.
2. Check the sprocket wear using procedures for the drive sprocket.
3. Check the sprocket to see that it runs true. If bent, replace.
4. During reassembly, make sure that sprocket and sprocket seat are clean. Tighten the securing nuts in a crisscross pattern. Bend the tabs of the lock washers fully against the securing nut flats.

### Drive Sprocket

#### Securing Nut Torque:

3.0 m-kg (21.7 ft-lb)

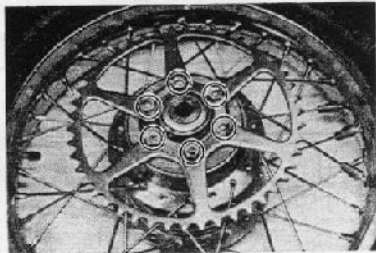

### Chain Inspection

1. With the chain installed on the motorcycle, excessive wear may be roughly determined by attempting to pull the chain away from the rear sprocket. If the chain will lift away more than one-half the length of the sprocket teeth, remove and inspect. (See page 3-2 for chain removal.)

If any portion of the chain shows signs of damage, or if either sprocket shows signs of excessive wear, remove and inspect.

2. Check the chain for stiffness. Hold as illustrated. If stiff, soak in solvent solution, clean with wire brush, dry with high pressure air. Oil chain thoroughly

and attempt to work out kinks. If still stiff, replace chain.

3. Check the side plate for damage. Check to see if excessive play exists in pins and rollers. Check for damaged rollers. Replace as required.

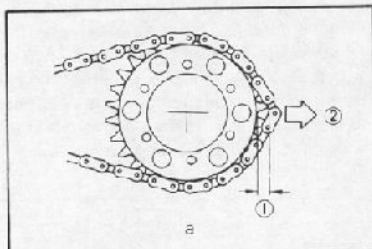

a. Checking for excessively worn chain

1. 1/2 inch
2. Full

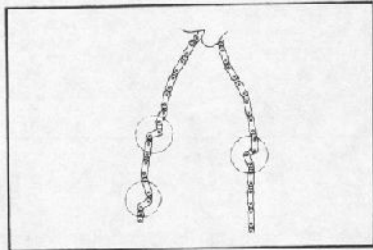

### Chain Maintenance

The chain should be lubricated according to the recommendations given in the General Maintenance/Lubrication charts, or more often if possible. (Preferably after every use.)

1. Wipe off dirt with shop rag. If accumulation is severe, use wire brush, then rag.
2. Apply lubricant between roller and side plates on both inside and outside of chain. Don't skip a portion as this will cause uneven wear. Apply thoroughly. Wipe off excess.

#### Recommended lubricant:

YAMAHA CHAIN AND CABLE LUBE, or SAE 10W/30 motor oil

3. Periodically, remove the chain. Wipe and/or brush excess dirt off. Blow off with high pressure air.

4. Soak chain in solvent, brushing off remaining dirt. Dry with high pressure air. Lubricate thoroughly to make sure lubricant penetrates. Wipe off excess. Reinstall.

## FRONT FORKS

### Disassembly

1. With the front wheel and front brake cable removed, the fork legs can be removed from the upper and lower brackets by loosening upper and lower pinch bolts.

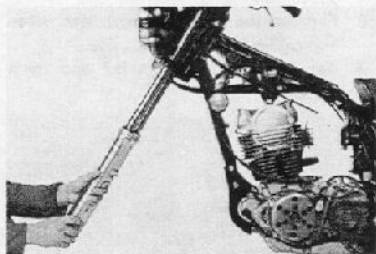

### NOTE:

Before loosening the upper and lower pinch bolts, remove the front fork cap bolts.

2. Remove the caps and drain the oil from both fork tubes.

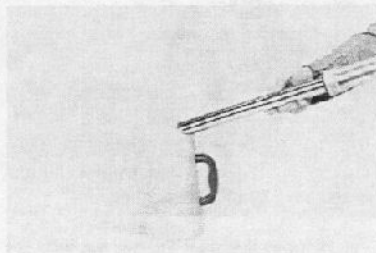

3. Remove the special bolt from bottom of outer tubes.
4. Remove inner tube and damper assembly from outer tube.
5. Pull out damper assembly. Inspect and replace if damaged.

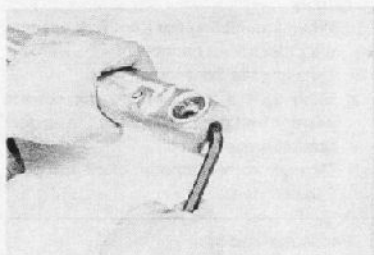

6. To replace the fork seal, remove the dust seal and snap-ring from outer tube.
7. Carefully pry out old seal without damaging fork tube.
8. Insert new seal "open" side down using large socket and steel hammer.

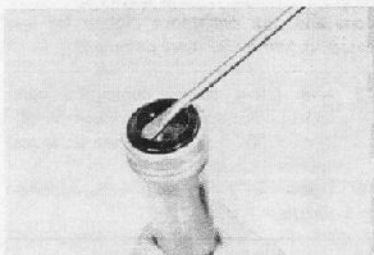

## Inspection

Inspect the inner tube for bends or scratches. If the bend is slight, it can be corrected with a press. It is recommended, however, to replace the tube.

## Assembly

1. When assembling the front fork, reverse the order of disassembly.
2. Installing the front forks
  - a. Bring up the front fork to the correct position and partially tighten the under-bracket mounting bolt.
  - b. Measure correct amount of oil and pour into each leg.

Recommended oil:  
Yamaha fork oil 10Wt or equivalent

Quantity per leg: 168 cc (5.7 U.S. oz)

## NOTE:

Select the weight oil that suits local conditions and your preference (lighter for less damping; heavier for more damping).

3. After filling, slowly pump the outer tubes up and down to distribute the oil.
4. Inspect "O" ring on fork cap bolts and replace if damaged.
5. Tighten all pinch bolts with specified torque.

Tightening torque:  
Inner tube to handle crown (upper bracket):  
2.0 m·kg (14.4 ft·lb)  
Inner tube to under bracket:  
2.0 m·kg (14.4 ft·lb)

## STEERING HEAD

### Adjustment

Refer to Chapter 2, Section 2-12, for steering head adjustment procedure.

### Disassembly

1. Remove the seat and fuel tank.
2. Remove the front wheel and front fender.
3. Remove the front forks.
4. Remove the headlight stay with headlight, horn and flasher lights and put them aside.
5. Remove the meter bracket with the speedo and tachometer.
6. Remove the handlebar with lead wires and cables and put them aside.
7. Remove the upper bracket and main switch.

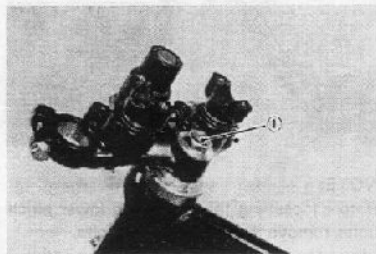

1. Steering fitting bolt

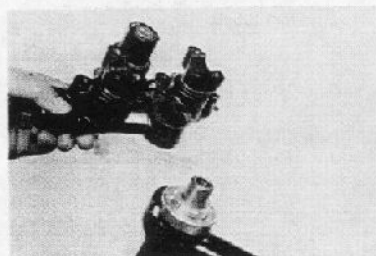

9. Remove the steering ring nut with the steering nut wrench.

## NOTE:

Support the under bracket with one hand to hold the bracket up into the head pipe so that the loose ball bearings will not fall out.

10. While still supporting the under bracket, carefully lift off the upper bearing cover.
11. Lift off the top bearing race and remove all of the ball bearings from the upper bearing assembly.

Ball quantity/size: 19 pcs., 1/4 in

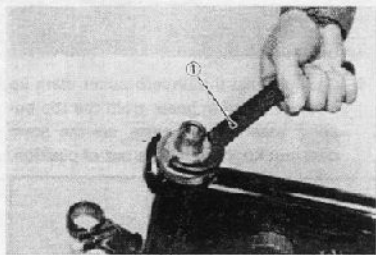

1. Steering nut wrench

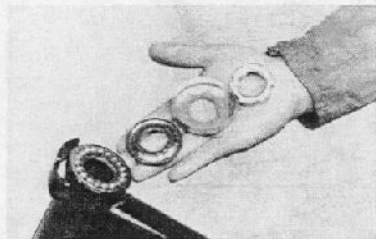

12. Remove the bracket while being very careful not to lose any ball bearings from the lower assembly.

Ball quantity/size: 19 pcs., 1/4 in

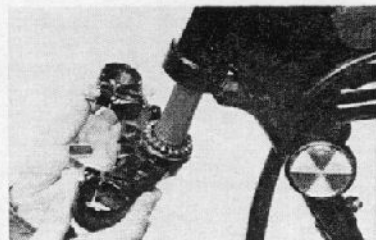

13. Remove the bearing races from head pipe using a drift punch and hammer as shown. Work the race out gradually by tapping lightly around its complete diameter.

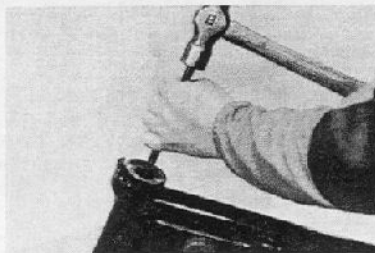

14. Remove the bearing race from the lower bracket by tapping around its diameter with a drift punch and hammer.

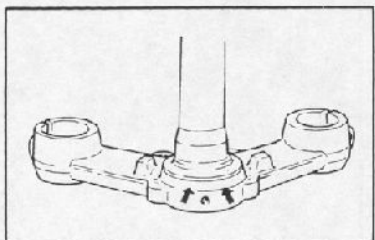

**NOTE:** \_\_\_\_\_  
Remove the dust seal. \_\_\_\_\_

#### Inspection

1. Examine all the balls for pits or partial flatness. If any one is found defective, the entire set (including both races) should be replaced. If either race is pitted, shows rust spots, or is damaged in any way, replace both races and all balls.
2. Examine dust seal under lowest race and replace if damaged.

#### Installation

1. If pressed-in races have been removed, tap in new races.
2. Grease the lower ball race of the bottom assembly and arrange the balls around it. Then apply more grease.
3. Grease the lower ball race of the upper assembly and arrange the balls around it. Then apply more grease and set the top race into place.



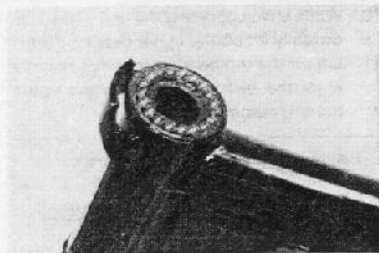
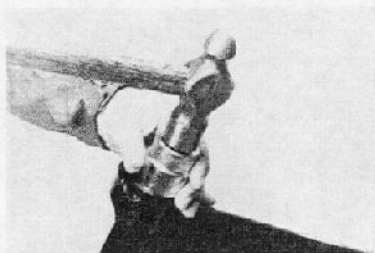

**NOTE:**

Use medium-weight wheel bearing grease of quality manufacture preferably waterproof.

4. Carefully slip the underbracket stem up into the steering head. Hold the top bearing assembly in place so the stem does not knock and balls out of position.

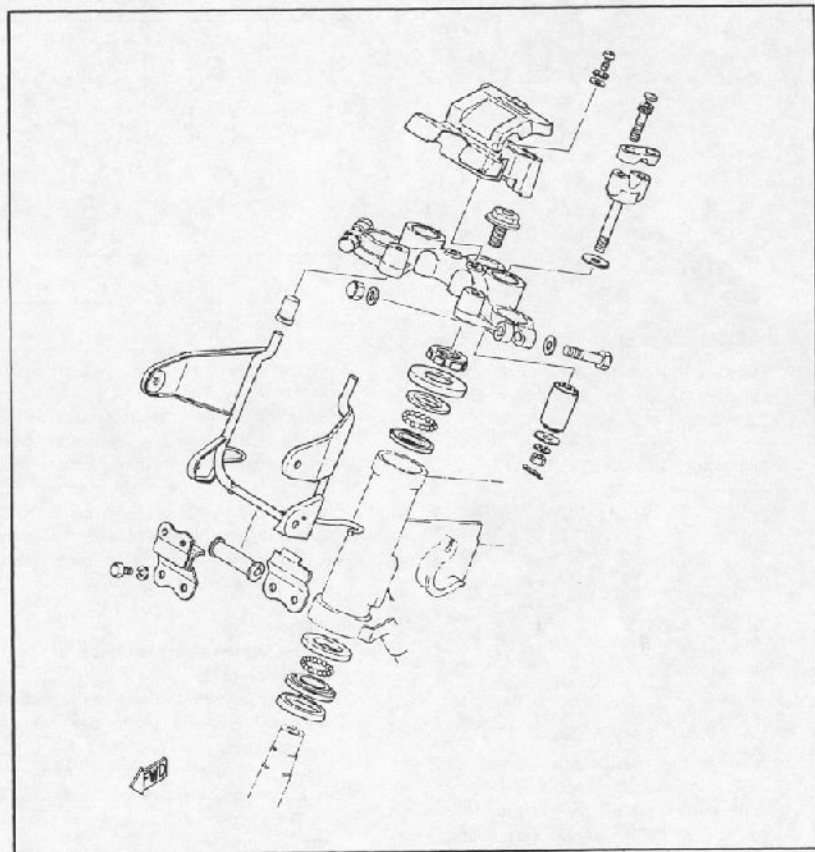

5. Set the upper bearing cover on and install the ring nut. Tighten the ring nut so that all freeplay is taken up, but so the bracket can still pivot freely from lock to lock. Recheck for freeplay after the entire fork unit has been installed. (Refer to Chapter 2, "Steering head adjustment".)
6. Install the fork tubes into the underbracket.
7. Install the upper fork bracket. Tighten the steering fitting bolt. Torque to specification.

Tightening torque:

Steering fitting bolt:

5.3 m·kg (38.3 ft·lb)

8. Tighten the upper fork tube pinch bolts and torque to specification.

Upper fork tube pinch bolt torque:

2.0 m·kg (14.4 ft·lb)

**NOTE:**

Make certain that the tops of fork tubes are adjusted to the same level. If necessary, loosen underbracket pinch bolts and adjust.

9. Install the handlebars and torque to specification.

Handlebar mounting bolt torque

2.0 m·kg (14.4 ft·lb)

10. Install the front wheel.
11. Reconnect the clutch, front brake and check operation.

## SWING ARM

### Inspection

1. With the rear wheel and shock absorbers removed, grasp the ends of the arm and move from right to left to check for the freeplay.

Swing arm freeplay:

1.0 mm (0.04 in)

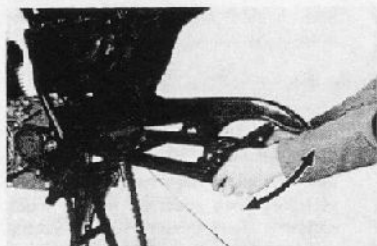

2. If the freeplay is excessive, remove the swing arm and replace the swing arm bushes.

### Lubrication

1. This model is equipped with the oilless bushes, but it is recommended to apply grease on the bushes lightly.

Recommended lubricant:

Lithium soap base grease

2. Wipe off excess grease.

### Removal

1. Remove the nut on the swing arm pivot shaft and tap out the shaft with a long aluminum or brass rod.

**NOTE:**

Carefully remove the arm while noting the location of bushes, oil seal and plate washers.

Pivot shaft torque:

6.5 m·kg (47.0 ft·lb)

2. Tap out the old bushes from each side of the pivot using the long rod.
3. Install the new bushes using a press.

**NOTE:**

Do not hammer in the bushes when installing; it may result in breakage to the bushes.

## REAR SHOCK ABSORBER

### Removal

1. Remove one rear shock absorber at a time, inspect and reinstall before removing the other.

### Inspection

1. Check the rod. If it is bent or damaged, replace the shock absorber.
2. Check for oil leakage. If oil leakage is evident, replace the shock absorber.
3. Operate shock absorber rod to check damping. There should be no noticeable damping as shock extends.
4. Install the shock absorber on the motorcycle.

Rear shock absorber tightening torque:  
3.0 m·kg (21.5 ft·lb)

## CABLES AND FITTINGS

### Cable Maintenance

#### NOTE:

See General Maintenance/Lubrication Charts for additional information.

Cable maintenance is primarily concerned with preventing deterioration through rust and weathering and providing for proper lubrication to allow the cable to move freely within its housing.

Cable removal is straightforward and uncomplicated. Removal will not be discussed within this section. For details, see the individual maintenance section for which the cable is an integral part.

Cable routing is of paramount importance, however, for details of cable routing, see the cable routing diagrams at the end of this manual.

1. Remove the cable.
2. Check for free movement of cable within its housing. If movement is obstructed, check for fraying or kinking of the cable strands. If damage is evident, replace the cable assembly.
3. To lubricate cable, hold in vertical position. Apply lubricant to uppermost end of cable. Leave in vertical position until lubricant appears at bottom end. Allow excess to drain and re-install.

Recommended lubricant:  
YAMAHA CHAIN AND CABLE  
LUBE, or SAE 10W/30 motor oil

### Throttle Maintenance

1. Remove two Phillips head screws from throttle housing assembly and separate two halves of housing.
2. Disconnect cable end from throttle grip assembly and remove grip assembly.
3. Wash all parts in mild solvent and check contact surfaces for burrs or other damage. (Also clean and inspect righthand end of handlebar.)
4. Lubricate contact surfaces with light coat of lithium soap base grease and re-assemble.

#### NOTE:

Tighten housing screws evenly to maintain an even gap between the two halves.

5. Check for smooth throttle operation and quick spring return when released and make certain that housing does not rotate on handlebar.

### Lubrication of Levers, Pedals, etc.

1. Lubricate the pivoting parts of the brake and clutch levers with recommended lubricant.

Recommended lubricant:  
YAMAHA CHAIN AND CABLE  
LUBE, or SAE 10W/30 motor oil

2. Lubricate the shaft of the brake pedal with lithium soap grease.

## CHAPTER 6. ELECTRICAL SYSTEM

IGNITION SYSTEM.....	6-1
Block Diagram .....	6-1
Description .....	6-1
Operation .....	6-1
Ignition Timing.....	6-2
Pick-up Coil Resistance Test .....	6-2
Replacing Procedure of Pickup Coil .....	6-2
Spark Gap Test .....	6-3
Ignition Coil Test.....	6-3
Troubleshooting.....	6-4
SPARK PLUG .....	6-4
CHARGING SYSTEM.....	6-4
Block Diagram .....	6-4
A.C. Magneto Generator Output Test.....	6-4
I.C. Voltage Regulator with Rectifier.....	6-5
LIGHTING SYSTEM.....	6-6
Lighting Circuit.....	6-6
Battery.....	6-6
Lighting Tests and Checks.....	6-7
Flasher Relay and Horn .....	6-7
Switches .....	6-8
STARTING SYSTEM.....	6-9
Description .....	6-9
Function of the Diode in the Relay .....	6-9
Operation.....	6-10
Starter Motor Removal.....	6-11
Starter Motor Inspection .....	6-12
Starter Motor Installation .....	6-14
Starter Relay Switch Inspection .....	6-14

## CHAPTER 6. ELECTRICAL SYSTEM

### IGNITION SYSTEM

#### Block Diagram

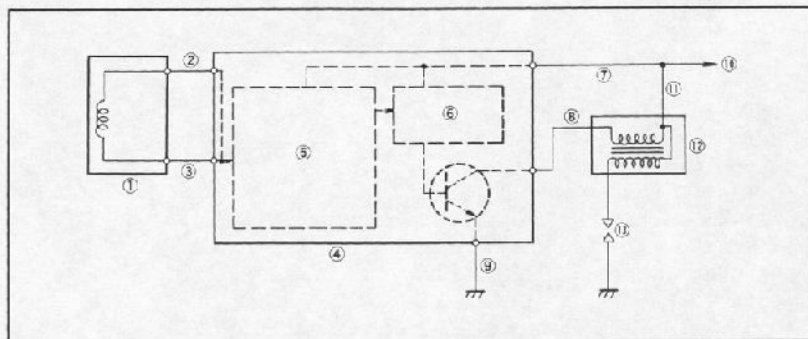

1. Pick-up coil
2. White/Red
3. White/Green
4. T.C.I. unit
5. Duty control, ignition advance control, and protective circuit
6. Amplifier
7. Red/White
8. Orange
9. Black
10. To engine stop switch
11. Red/White
12. Ignition coil
13. Spark plug

#### Description

This model is equipped with a battery operated, fully transistorized breakerless ignition system. By using magnetic pick-up coil the need for contact breaker points is eliminated. This adds to the dependability of the system by eliminating frequent cleaning and adjustment of points and ignition timing. This TCI unit incorporates an automatic advance circuit controlled by signals generated by the pick-up coil. This adds to the dependability of the system by eliminating the mechanical advance. This TCI (Transistor Control Ignition) system consists of two main units: a pick-up unit and an ignitor unit.

#### Operation

The TCI (Transistor Control Ignition) functions on the same principle as a conventional DC ignition system with the exception of using magnetic pick-up coil and a T.C.I. unit in place of contact breaker points.

#### a. Pick-up unit

This unit consists of a pick-up coil and a magnet mounted on the generator base. When the rotor projection passes this pick up coil, the two signals are generated at the pick-up coil and transmitted to the ignitor unit as a signal. The full ignition advance is determined by the length of the rotor projection.

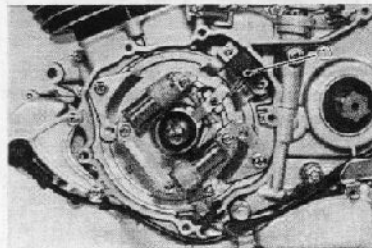

1. Pickup coil

#### b. Ignitor Unit (T.C.I.)

This unit has such functions as the change of wave form, duty control, switching, and electrical ignition advance. The ignition timing is advanced electrically using two signals from the pick-up coil.

The duty control circuit is provided to control the on time period of the primary ignition current to reduce the electrical consumption. This unit also incorporates a protective circuit for the ignition coil. If the ignition switch is turned on and the crankshaft is not turned, the protective circuit stops current flow to the primary coil within a few seconds. When the crankshaft is turned over the current is turned on again by the signals generated by the pick-up coil.

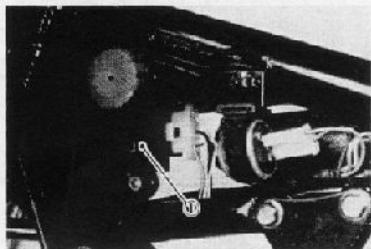

1. Ignitor unit

#### Ignition Timing

Refer to Chapter 2, "Ignition Timing".

If the ignition timing is not correct, replace the defective part.

#### Pick-up Coil Resistance Test

Use a pocket tester or equivalent ohmmeter to determine resistance and continuity of pickup coil windings.

##### Pickup Coil:

W/R ~ W/G

$700\Omega \pm 10\%$  at 20°C (68°F)

#### Replacing Procedure of Pickup Coil

1. Take apart a defective pickup by removing the two holding panhead screws.
2. Move the protector tube to expose the solder connected part. Melt the solder to separate the connection.
3. Solder the leads from a new pickup to the above connection part.
4. Temporarily install the new pickup in its location but as far outward of the rotor as possible.
5. Set the rotor so that the projection on it faces the pickup. Supply an air gap of 0.6 mm (0.02 in) between the projection and the pickup, using a feeler gauge. Then tighten up the pickup in place.

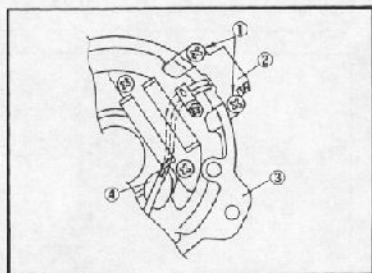

1. Panhead screw

2. Pickup coil

3. Base assembly

4. Solder connected part

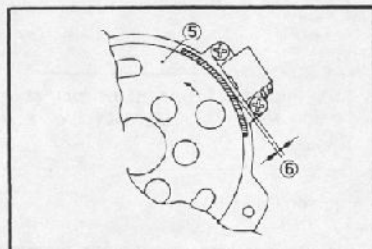

5. Flywheel magnet

6. Air gap

#### CAUTION:

The air gap must not be less than 0.6 mm (0.02 in).

### Spark Gap Test

The entire ignition system can be checked for misfire and weak spark using the "Electro Tester"

If the ignition system will fire across a sufficient gap, the entire ignition system can be considered good.

If not, proceed with individual component tests until the problem is found.

1. Warm-up engine thoroughly so that all electrical components are at operating temperature.
2. Stop engine and connect tester as shown.
3. Start engine and increase spark gap until misfire occurs. (Test at various speed between idle and red line.)

Minimum Spark Gap: 6 mm (0.24 in)

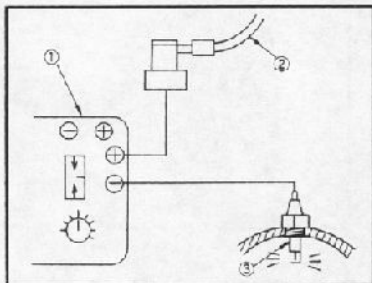

1. Electro tester
2. Plug wire from ignition coil
3. Spark plug

#### CAUTION:

Do not run engine in neutral above 6,000 r/min for more than 1 or 2 seconds.

### Ignition Coil Test

1. Coil spark gap test
  - a. Remove the fuel tank and disconnect ignition coil from wire harness and the spark plug.
  - b. Connect the Electro Tester as shown.
  - c. Connect fully charged 12V battery to tester.
  - d. Turn on spark gap switch and increase gap until misfire occurs.

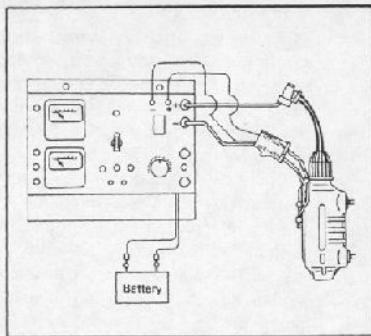

Minimum Spark Gap: 6 mm (0.24 in)

2. Coil winding resistance tests  
Use a pocket tester or equivalent ohmmeter to determine resistance and continuity of primary and secondary coil windings.

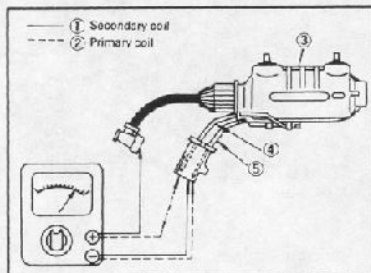

1. Secondary coil
2. Primary coil
3. Ignition coil
4. Red/White
5. Orange

Primary Coil resistance Use ( $\Omega \times 1$ ) scale	Secondary Coil resistance
2.75 $\Omega \pm 10\%$ at 20°C	7.9k $\Omega \pm 20\%$ at 20°C

## Troubleshooting

If the ignition system should become inoperative, the following troubleshooting aids will be useful.

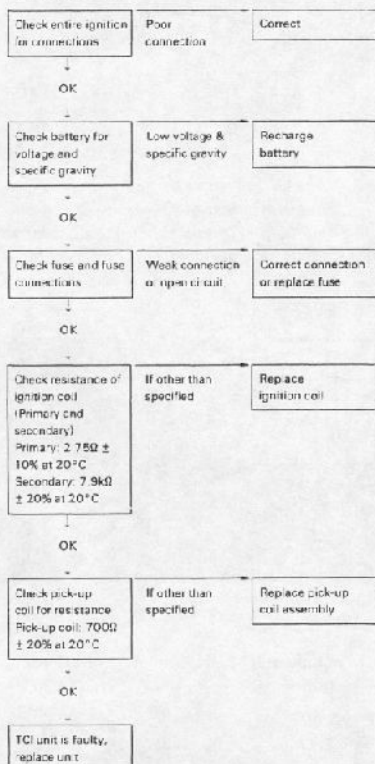

## SPARK PLUG

1. Check the electrode condition and wear, insulator color and electrode gap.
2. Use a wire gauge for measuring the plug gap.
3. If the electrodes become too worn, replace the spark plug.
4. When installing the plug, always clean the gasket surface. Wipe off any grime that might be present on the surface of the spark plug, and torque the spark plug properly.

Type:

BP7ES (NGK) or W22EP (ND)

Electrode gap:

0.7 ~ 0.8 mm (0.028 ~ 0.031 in)

Tightening torque:

2.0 m·kg (14.5 ft·lb)

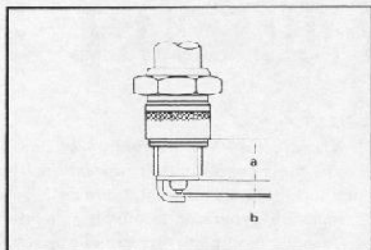

a. 19 mm (0.73 in)

b. 0.7 ~ 0.8 mm (0.027 ~ 0.031 in)

## CHARGING SYSTEM

### Block Diagram

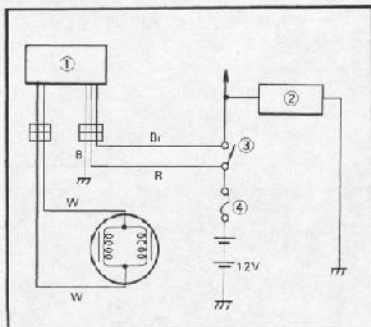

1. I.C. voltage regulator

2. Load

3. Main switch

4. Fuse

### A. C. Magneto Generator Output Test

1. Checking method.

- 1) Connect D.C. voltmeter to the battery terminals.
- 2) Start the engine.
- 3) Accelerate engine to approximately 2,000 r/min or more and check generated voltage.

Generated voltage:  $14.5 \pm 0.5\text{V}$



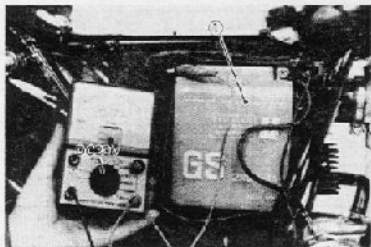

1. Battery

**CAUTION:**

Never disconnect wires from the battery while the generator is in operation. If the battery is disconnected, the voltage across the generator terminals will increase, damaging the semiconductors.

**2. Resistance test of charging coil**

Check the resistance between terminals. If resistance is out of specification, check the coil connections. If the coil connections are good, then the coil is broken inside and it should be replaced.

**Charging coil resistance:**

WHITE ~ WHITE  
 $0.39\Omega \pm 15\%$  at  $20^{\circ}\text{C}$  ( $68^{\circ}\text{F}$ )

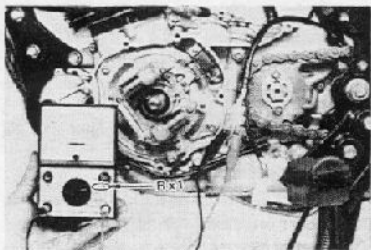

**I.C. Voltage Regulator with Rectifier**

**1. Inspection**

Since I.C. regulator is sealed with a resin, it is impossible to check or replace any of inner parts. If the regulator is found to be defective, it must be replaced with a new one.

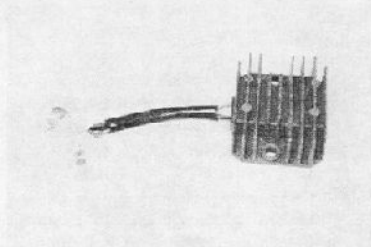

**2. Checking method**

- a. Measure the specific gravity of the battery fluid. If it is less than 1.260, remove the battery and recharge until it is more than 1.260. (See page 6-7 for charging procedures)

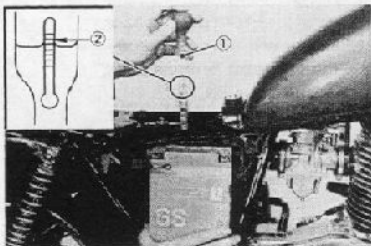

1. Hydrometer  
 2. Reading

- b. Connect D.C. voltmeter to the battery terminals.

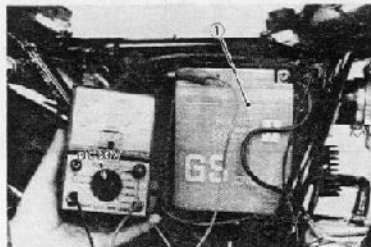

1. Battery

- c. Start engine.
- d. Accelerate engine to approximately 2,000 r/min. or more and check regulated voltage.

Regulated voltage:  $14.5 \pm 0.5V$

- e. If voltage is off, check battery and generator. If generator and battery are good, then IC regulator is broken and it should be replaced.

**NOTE:**

1. Never disconnect wires from the battery while the generator is in operation. If the battery is disconnected, the voltage across the generator terminals will increase, damaging the semiconductors.
2. When checking the regulator being installed on a motorcycle, the battery should not be removed, and it should be fully charged.
3. Never use a high voltage insulation ohmmeter such as a megohmmeter for such a test. If high voltage is applied to the regulator terminals, the regulator will be damaged.

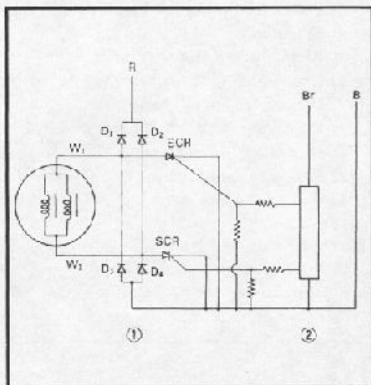

1. Rectifier  
2. Regulator

**3. Checking the silicon rectifier**

- a. Check the silicon rectifier as specified using the Yamaha pocket tester.
- b. Even if only one of the elements is broken, replace the entire assembly.

Checking element:	Pocket test connecting point		Good	Replace (element shorted)	Replace (element opened)
	(+) (red)	(-) (black)			
D <sub>1</sub>	R	W <sub>1</sub>	○	○	x
	W <sub>1</sub>	R	x	○	x
D <sub>2</sub>	R	W <sub>2</sub>	○	○	x
	W <sub>2</sub>	R	x	○	x
D <sub>3</sub>	W <sub>1</sub>	B	○	○	x
	B	W <sub>1</sub>	x	○	x
D <sub>4</sub>	W <sub>2</sub>	B	○	○	x
	B	W <sub>2</sub>	x	○	x

○ Continuity Resistance is approx. 10Ω  
x Discontinuity (∞)

**NOTE:**

In the above table, symbols W<sub>1</sub> and W<sub>2</sub> are provided just for checking purposes; these are not shown on the actual motorcycle.

**CAUTION:**

The silicon rectifier can be damaged if subjected to overcharging. Special care should be taken to avoid a short circuit and/or incorrect connection of the positive and negative leads at the battery. Never connect the rectifier directly to the battery to make a continuity check.

**LIGHTING SYSTEM**

**Lighting Circuit**

See Chapter 7. "Wiring Diagram"

**Battery**

The battery fluid should be checked at specified intervals.

**1. Checking**

- a. If sulfation (white accumulations) occurs on plates due to lack of battery electrolyte, the battery should be replaced.
- b. If the bottom of the cells are filled with corrosive material falling off plates, the battery should be replaced.
- c. If the battery shows the following defects it should be replaced.
  - 1) The voltage will not rise to a specific value even after long hours charging.
  - 2) No gassing occurs in any cell.

## 2. Service life

The service life of a battery is usually 2 to 3 years, but lack of care as described below will shorten the life of the battery.

- Negligence in keeping battery topped off with distilled water.
- Battery being left discharged.
- Over-charging by rushing charge.
- Freezing.
- Filling with water or sulfuric acid containing impurities.
- Improper charging voltage/current on new battery.

Battery type	12V, 12AH
Electrolyte	Specific gravity: 1.280 Quantity: 800 cm <sup>3</sup>
Re-charging current	1.2 Amperes/10 hours (for unit specific gravity reaches 1.280)
Re-fill fluid	Distilled water to maximum level line
Re-fill period	Check once per month or more often as required.

## 3. Storage

If the motorcycle is not used for a long time, remove the battery and have it stored by a battery service shop. The following instructions should be observed by shops equipped with charger.

- Recharge the battery.
- Store the battery in a cool, dry place, and avoid temperatures below 0°C (32°F).
- Recharge the battery before reinstallation.

## Lighting Tests and Checks

The 12V battery provides power for operation of the horn, taillight, brakelight, neutral light and flasher lights, etc. If none of the above operate, always check battery voltage before proceeding further. Low battery voltage indicates either a faulty battery, low battery water, or a defective charging system. See Charging system, for checks of battery and charging system.

### 1. Horn does not work.

- Check for 12V on brown wire to horn.
- Check for good grounding of horn (pink wire) when horn button is pressed.

### 2. Brakelight does not work

- Replace bulb.
- Check for 12V on yellow wire to brakelight.
- Check for 12V on brown wire to each brake switch (front brake and rear brake switches).
- Check for ground on black wire to tail/brakelight assembly.

### 3. Taillight does not work.

- Replace bulb.
- Check for 12V on blue wire.
- Check for ground on black wire to tail/brakelight assembly.

### 4. Flasherlight(s) do not work.

- Replace bulb.
- Right circuit.
  - Check for 12V on dark green wire to light.
  - Check for ground on black wire to light assembly.
- Left circuit.
  - Check for 12V on dark brown wire to light.
  - Check for ground on black wire to light assembly.
- Right and left circuits do not work.
  - Check for 12V on brown wire to flasher switch on left handlebar.
  - Check for 12V on brown wire to flasher relay.
- Replace flasher relay.
- Replace flasher switch.

## Flasher Relay and Horn

### 1. Flasher relay:

The flasher relay is employed 12V, heat ribbon type.

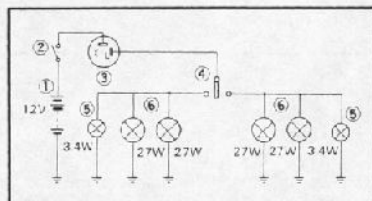

- Battery
- Main switch
- Flasher relay
- Flasher switch
- Flasher indicator light
- Flasher light

2. Horn:

The horn is a 12V, plane type, and has a tone volume adjusting screw on its back.

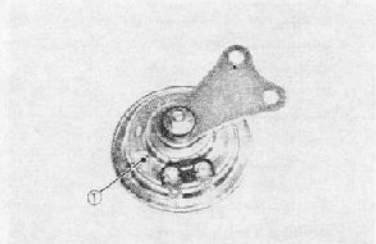

1. Adjusting screw

### Switches

The main switch and right and left handlebar switches may be checked for continuity or shorts with a Pocket Tester on the ( $\Omega$  — 1) scale.

1. Main switch

	R	Br	L/R		
ON	○ — ○ — ○				
OFF				*	
LOCK				*	**
P	○ — ○ — ○			*	**

\* The key can be removed in this position.

\*\* The handlebar can be locked in this position.

2. Engine stop switch

	Br	R/W
OFF		
RUN	○ — ○	
OFF		

3. Dimmer switch

	Y	L/B	G
HI	○ — ○		
LO		○ — ○	

4. Flasher switch

	Dg	sr/W	Ch
R	○ — ○		
N		○ — ○	
L		○ — ○	

5. Horn button

	P	Ground
OFF		
PUSH	○ — C	

6. "Start" button

	Rr	L/R	L/W	Ground
	○	C		
PUSH			○ — C	

## STARTING SYSTEM

### Description

This model is equipped with a starting circuit cut-off switch. The starter motor is so designed that it can be started only when the transmission is in Neutral or the clutch is disengaged.

Accordingly, the starter motor will not start when the transmission is shifted into any position other than neutral, unless the clutch lever is pulled in.

In addition, the starter switch is so constructed that when the "START" switch is turned on, the headlight goes off.

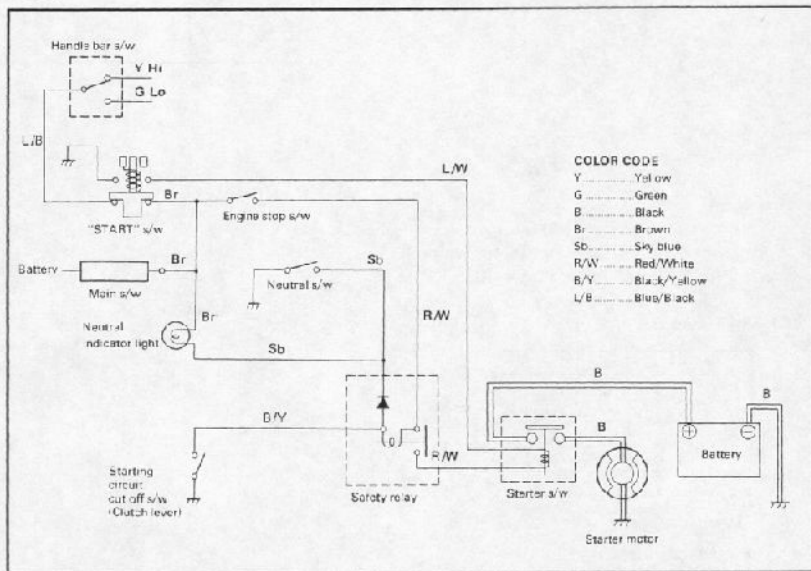

### Function of the Diode in the Relay

When the transmission is in a position other than Neutral:

Turning on the clutch lever switch (Clutch is disengaged by pulling the clutch lever) makes the safety relay to turn on.

In this case, the diode interrupts the flow of current from the main switch to the neutral indicator light and to the relay, and thus the light will not come on.

## Operation

- a) When the transmission is in Neutral:  
 Neutral switch ..... ON  
 Clutch lever switch ..... OFF or ON  
 ○ When the main switch is turned on

while the transmission is in neutral the starting circuit cut-off relay circuit is closed and the relay is actuated.

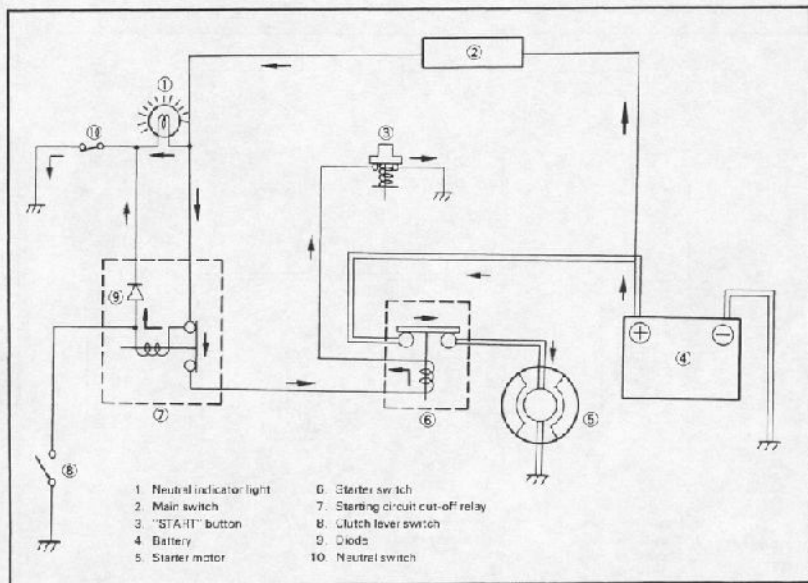

- When the "START" button is pressed, the circuit from the main switch to the relay — starter switch assembly — "START" (button) is closed, and the starter switch assembly is turned on, thus causing the starter motor to start.

- b) When the clutch lever is released while the transmission is in position other than neutral:

Neutral switch ..... OFF  
 Clutch lever switch ..... OFF

- Since the starting circuit cut-off is kept open, the relay is not actuated, and it is impossible to turn on the starter switch assembly by pushing the "START" button.

As a result, the starter motor does not run.

c) When the clutch lever is disengaged by pulling in the clutch lever while the transmission is in a position other than neutral:

Neutral switch.....OFF

Clutch lever switch.....ON

Since the clutch lever switch is on while

the neutral switch is off, the following circuit — main switch — starting circuit cut off relay — clutch lever switch is closed and the relay is actuated.

The subsequent operation is the same as a).

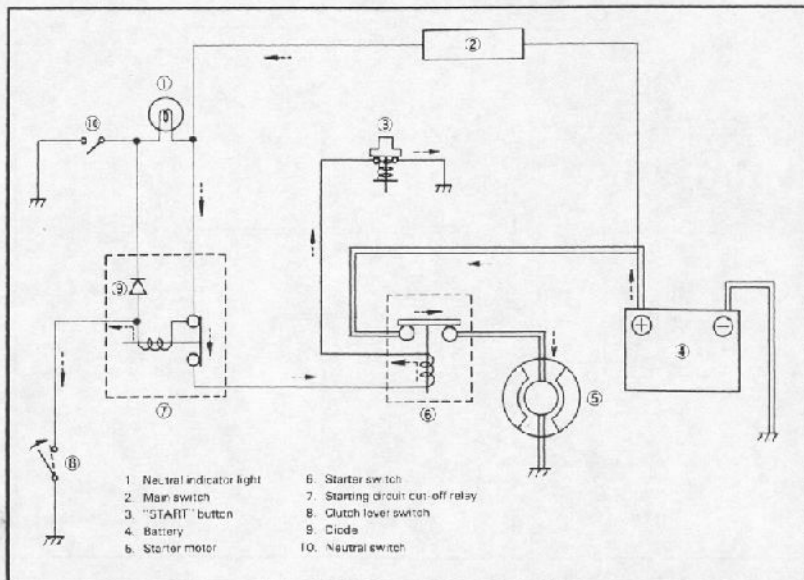

### Starter Motor Removal

1. Disconnect the wires from the battery. Remove the negative wire first.
2. Remove the left crankcase cover.
3. Disconnect the wires from the starter motor.
4. Remove the starter motor by loosening two securing bolts.
5. Place an oil pan under the engine, and drain the engine oil.
6. Remove the right crankcase cover.

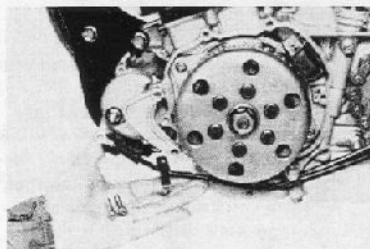

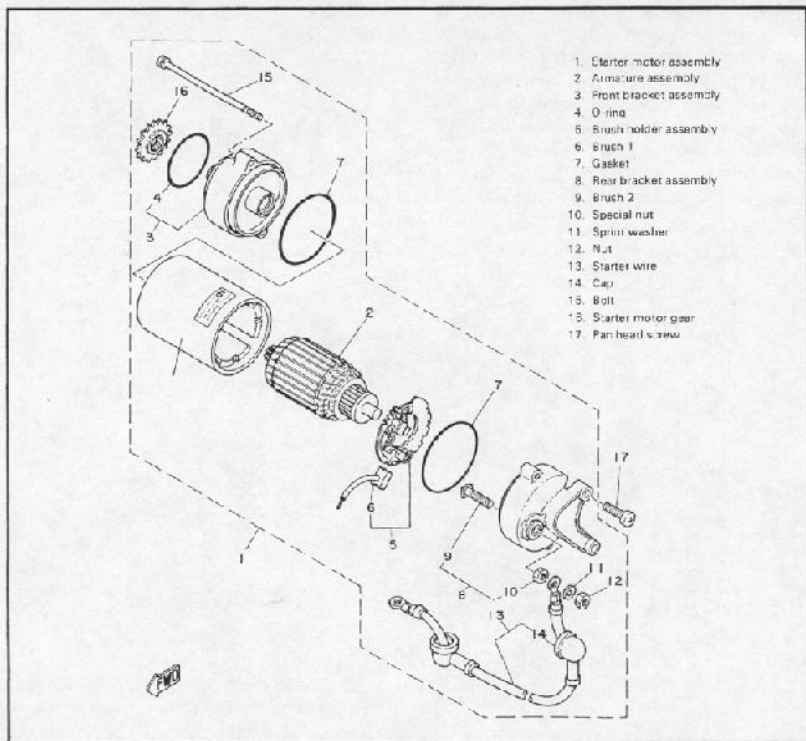

### Starter Motor Inspection

1. Check the outer surface of the commutator. If its surface is dirty, clean with No. 600 grit sand paper.
2. The mica insulation between commutator segments should be 0.4 ~ 0.8 mm (0.016 ~ 0.03 in) below the segment level. If not, scrape to proper limits with appropriately shaped tool. (A hack saw blade can be ground to fit.)

### NOTE:

Mica insulation of commutator must be undercut to ensure proper operation of commutator.

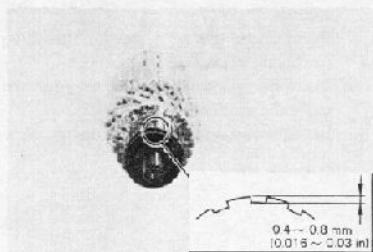



3. The starter's armature should be checked with an ohm meter for insulation breakdown (shorting to each other or to ground) and for continuity. Reference figure is given below.

Coil resistance:

Armature coil: 0.014Ω (20°C)

Continuity check

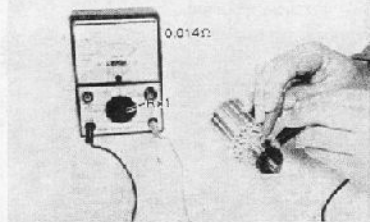

Insulation check

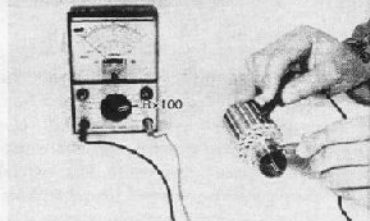

4. Check the front and rear cover bushes for damage. If damaged, the starter assembly must be replaced.

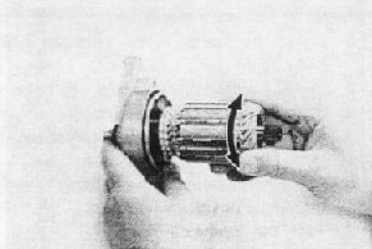
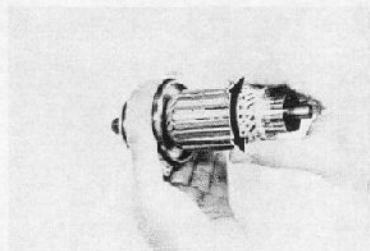

5. Check brush length. Replace brush if at, or near, limits.

Minimum brush length:  
8.5 mm (0.33 in)

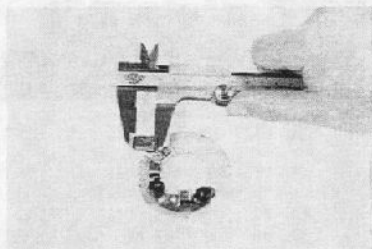

6. Check brush spring pressure. Compare it with a new spring. Replace the old spring if it is weak.

### Starter Motor Installation

1. Install the starter motor with the gear and chain.
2. Install the starter motor securing bolts.
3. Install the right crankcase cover.
4. Connect the wire to the starter motor.
5. Install the left crankcase cover.
6. Connect the wires to the battery. Install the positive wire first.
7. Refill the engine oil.

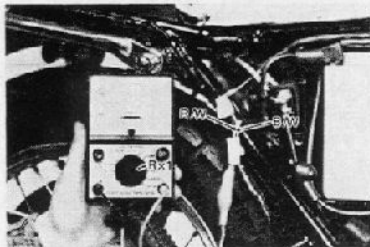

### Starter Relay Switch Inspection

1. Disconnect starter relay leads at the relay.
2. Connect pocket tester leads to the relay terminals (ohms x 1 scale).
3. Turn ignition to "ON" position and engine stop switch to "RUN".
4. Push the starter button. The relay should click once and the scale should read zero. If the scale does not read zero, the relay must be replaced.

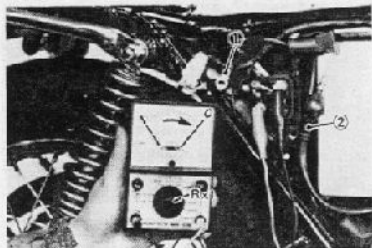

1. Battery lead wire (+)
2. Starter motor lead wire

5. If the relay does not click, check the wires from the starter button and from the battery. Turn the ignition off. Use (ohms x 1) scale on tester. The resistance between (red/white, blue/white) wires should be no more than 3.5 ohms. If there is more resistance, the relay should be replaced.

## CHAPTER 7. APPENDICES

SPECIFICATIONS .....	7-1
General Specifications .....	7-1
Engine Specifications .....	7-1
Chassis Specifications .....	7-7
Electrical Specifications .....	7-8
Torque Specifications .....	7-10
General Torque Specifications.....	7-12
Conversion Tables.....	7-12
LUBRICATION CHART.....	7-13
WIRING DIAGRAM .....	7-14
CABLE ROUTING.....	7-15

## SPECIFICATIONS

### General Specifications

Item	Required «Allowance»
Model: I.B.M. No. Frame I.D. and starting number Engine I.D. and starting number	3Y6 3Y6-000101 3Y6-000101
Dimension: Overall length Overall width Overall height Wheelbase Minimum ground clearance	2,005 mm (78.9 in) 815 mm (32.1 in) 1,125 mm (44.3 in) 1,335 mm (52.6 in) 145 mm (5.7 in)
Weight: Net weight	121 kg (267 lb)
Performance: Climbing ability Minimum turning radius Brake distance	30° 2,300 mm (90.6 in) 14m (45.9 ft) at 50 km/h (31 mph)

### Engine Specifications

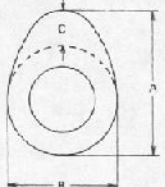
Description	Required «Allowance»												
Engine type Engine model Displacement Bore x stroke Compression ratio Starting system Ignition system Lubrication system	Air cooled 4-stroke, forward incline, single, S O H C. 3Y6 249 cm <sup>3</sup> (15.19 cu.in) 75 x 66.6 mm (2.953 x 2.224 in) 9.2 : 1 Electric starter Battery ignition (Full transistor ignition) Pressure lubricated, wet sump												
Cylinder head: Combustion chamber type Combustion chamber volume (with BP7ES or W22EF) Head gasket thickness	Sphere + Squish 30.4 cm <sup>3</sup> (1.85 cu.in) 1.0 mm (0.039 in)												
Camshaft: Cam drive type Camshaft bearing type (left) (right) Cam chain type and No. of links	Drive chain (left side drive) Ball bearing Needle bearing BF05M, 90L												
Valve dimensions: 	<table border="0"> <tr> <td>A (Cam height) IN</td> <td>40.20 ± 0.05 mm «40.05 mm» (1.583 ± 0.002 in «1.576 in»)</td> </tr> <tr> <td>EX.</td> <td>40.25 ± 0.05 mm «40.10 mm» (1.585 ± 0.002 in «1.579 in»)</td> </tr> <tr> <td>B (Base circle) IN</td> <td>32.14 ± 0.05 mm «31.99 mm» (1.265 ± 0.002 in «1.260 in»)</td> </tr> <tr> <td>EX.</td> <td>32.16 ± 0.05 mm «31.07 mm» (1.266 ± 0.002 in «1.221 in»)</td> </tr> <tr> <td>C (Cam lift) IN</td> <td>8.20 mm (0.323 in)</td> </tr> <tr> <td>EX.</td> <td>8.25 mm (0.325 in)</td> </tr> </table>	A (Cam height) IN	40.20 ± 0.05 mm «40.05 mm» (1.583 ± 0.002 in «1.576 in»)	EX.	40.25 ± 0.05 mm «40.10 mm» (1.585 ± 0.002 in «1.579 in»)	B (Base circle) IN	32.14 ± 0.05 mm «31.99 mm» (1.265 ± 0.002 in «1.260 in»)	EX.	32.16 ± 0.05 mm «31.07 mm» (1.266 ± 0.002 in «1.221 in»)	C (Cam lift) IN	8.20 mm (0.323 in)	EX.	8.25 mm (0.325 in)
A (Cam height) IN	40.20 ± 0.05 mm «40.05 mm» (1.583 ± 0.002 in «1.576 in»)												
EX.	40.25 ± 0.05 mm «40.10 mm» (1.585 ± 0.002 in «1.579 in»)												
B (Base circle) IN	32.14 ± 0.05 mm «31.99 mm» (1.265 ± 0.002 in «1.260 in»)												
EX.	32.16 ± 0.05 mm «31.07 mm» (1.266 ± 0.002 in «1.221 in»)												
C (Cam lift) IN	8.20 mm (0.323 in)												
EX.	8.25 mm (0.325 in)												

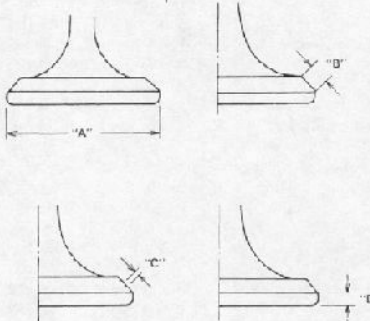
Item	Required «Allowance»
Camshaft runout limit Valve timing: Intake open Intake close Duration Exhaust open Exhaust close Exhaust duration Valve over lap	«0.1 mm (0.0039 in)»  <b>BTDC 28°</b> <b>ABDC 68°</b> <b>276°</b> <b>BBDC 64°</b> <b>ATDC 32°</b> <b>276°</b> <b>60°</b>
<b>Rocker arm and rocker shaft:</b> Rocker arm bearing dia. (I.D.)  Rocker arm shaft dia. (O.D.)  Clearance	12.00 ~ 12.02 mm «12.05 mm» (0.4724 ~ 0.4732 in «0.4744 in»)  11.98 ~ 11.99 mm «11.96 mm» (0.4714 ~ 0.4720 in «0.4709 in»)  0.01 ~ 0.04 mm «0.11 mm» (0.0004 ~ 0.0016 in «0.0043 in»)
<b>Valve, valve seat and valve guide:</b> Valve clearance (cold): IN. EX No. of valves per cylinder Dimensions:	0.05 ~ 0.10 mm (0.0020 ~ 0.0039 in) 0.12 ~ 0.17 mm (0.0047 ~ 0.0067 in) 2 pcs.  

Item	Required «Allowance»
Valve head dia. (A): IN. EX.	38 mm (1.496 in) 32 mm (1.260 in)
Valve face width (B): IN. EX.	2.26 mm (0.089 in) 2.76 mm (0.089 in)
Valve seat width (C): IN. EX.	1.1 mm (0.043 in) 1.1 mm (0.043 in)
Valve margin thickness (D): IN. EX.	1.2 mm (0.047 in) 1.0 mm (0.039 in)
Valve stem outside dia.: IN. EX.	7 <sup>+0.010</sup> <sub>-0.020</sub> mm (0.276 <sup>-0.0034</sup> <sub>-0.0010</sub> in) 7 <sup>+0.030</sup> <sub>-0.045</sub> mm (0.276 <sup>-0.0012</sup> <sub>-0.0018</sub> in)
Valve guide inside dia.: IN. EX.	7 <sup>+0.012</sup> <sub>0</sub> mm (0.276 <sup>-0.0005</sup> <sub>0</sub> in) 7 <sup>+0.012</sup> <sub>0</sub> mm (0.276 <sup>+0.0005</sup> <sub>0</sub> in)
Valve stem to guide clearance: IN. EX.	0.010 ~ 0.037 mm «0.07 mm» (0.0004 ~ 0.0015 in «0.0028 in») 0.030 ~ 0.057 mm «0.1 mm» (0.0012 ~ 0.0022 in «0.0039 in»)
Valve springs:	
Free length: Inner Outer	40 mm «38.8 mm» (1.57 in «1.528 in») 43.2 mm «41.9 mm» (1.70 in «1.650 in»)
Spring rate: Inner Outer	K <sub>1</sub> = 2.07 kg/mm (115.9 lb/in) K <sub>2</sub> = 2.71 kg/mm (151.8 lb/in) K <sub>3</sub> = 3.90 kg/mm (218.4 lb/in) K <sub>4</sub> = 5.18 kg/mm (289.0 lb/in)
Installed length (valve closed): Inner Outer	34.1 mm (1.34 in) 37.1 mm (1.46 in)
Installed pressure (valve closed): Inner Outer	12.19 kg (26.88 lb) 23.72 kg (52.30 lb)
Compressed length (valve open): Inner Outer	25.1 mm (0.988 in) 28.1 mm (1.11 in)
Compressed pressure (valve open): Inner Outer	36.57 kg (80.64 lb) 70.13 kg (154.64 lb)
Wire diameter: Inner Outer	3.0 mm (0.118 in) 4.2 mm (0.165 in)
Winding outside diameter: Inner Outer	21.8 mm (0.858 in) 31.1 mm (1.224 in)
Tilt limit from vertical: Inner Outer	1.7 mm (0.067 in) or 2.5° 1.7 mm (0.067 in) or 2.5°

Allowable tilt from vertical

Direction of windings  
(Top to bottom)

Item	Required «Allowance»
<b>Cylinder</b>	
Material	Aluminum alloy with special cast iron sleeve
Bore size	75.00 ~ 75.02 mm «75.1 mm» (2.9528 ~ 2.9536 in «2.9567 in»)
Taper limit	«0.05 mm» («0.0020 in»)
Out of round limit	«0.01 mm» («0.0004 in»)
<b>Piston</b>	
Piston clearance	0.035 ~ 0.055 mm (0.0014 ~ 0.0022 in)
Piston clearance (measuring position (from piston skirt bottom))	5.5 mm (0.22 in)
Piston pin bore size	20.004 ~ 20.015 mm (0.7876 ~ 0.7880 in)
Piston pin outside diameter	19.995 ~ 20.000 mm (0.7872 ~ 0.7874 in)
Piston pin length	65 mm (2.56 in)
Over size piston diameter: 1st	75.25 mm (2.963 in)
2nd	75.50 mm (2.972 in)
3rd	75.75 mm (2.982 in)
4th	76.00 mm (2.992 in)
<b>Piston ring:</b>	
Piston ring dimension: Top ring B x T	1.2 x 2.9 mm (0.047 x 0.114 in)
2nd ring B x T	1.5 x 3.3 mm (0.059 x 0.130 in)
Oil ring B x T	2.8 x 3.4 mm (0.110 x 0.134 in)
Ring end gap (installed): Top ring	0.2 ~ 0.4 mm «0.7 mm» (0.0079 ~ 0.0157 in «0.028 in»)
2nd ring	0.2 ~ 0.4 mm «0.7 mm» (0.0079 ~ 0.0157 in «0.028 in»)
Oil ring	0.3 ~ 0.9 mm «1.0 mm» (0.012 ~ 0.035 in «0.038 in»)
Ring groove side clearance: Top ring	0.04 ~ 0.08 mm «0.15 mm» (0.0016 ~ 0.0031 in «0.0059 in»)
2nd ring	0.03 ~ 0.07 mm «0.15 mm» (0.0012 ~ 0.0028 in «0.0059 in»)
Oil ring	N.A.
Over size piston ring: 1st	75.25 mm (2.963 in)
2nd	75.50 mm (2.972 in)
3rd	75.75 mm (2.982 in)
4th	76 mm (2.992 in)

Item	Required Allowances
<b>Big end bearing:</b> Type Inside dia. x outside dia. x width Needle dia. x length/quantity	Needle bearing 31 x 41 x 22 mm (1.22 x 1.61 x 0.87 in) 5 x 17.8 mm (0.70 x 0.70 in)/14 pcs
<b>Crankshaft:</b> Crankshaft assembly width (F) Crankshaft deflection (D) Connecting rod large end side clearance (C) Connecting rod small end deflection (P)    Crank pin outside dia. x length Crank bearing type: Left Right Crank oil seal type: Left right	58.95 ~ 59.00 mm (2.3208 ~ 2.3228 in) <math>\leq 0.03 \text{ mm (0.0012 in) or less}</math> 0.35 ~ 0.65 mm (0.0138 ~ 0.0256 in) 0.8 ~ 1.0 mm (<math>\leq 2.0 \text{ mm}</math>) (0.0315 ~ 0.0394 in (<math>\leq 0.079 \text{ in}</math>))  31 x 68 mm (1.22 x 2.28 in) 8306RP—9—ST 8307SH2—9—C4 with special heat treatment SD—25—40—6 KS 57—14—27—6 HS
<b>Clutch</b> Clutch type Clutch push mechanism Primary reduction ratio and method Primary reduction gear backlash number Primary drive gear backlash number Primary driven gear backlash number Friction plate: Thickness/quantity  Clutch plate: Thickness/quantity Warp limit Clutch spring: Free length/quantity  Spring set weight Spring rate Clutch housing thrust clearance Push rod bending limit Push lever axle: Bearing type and size Oil seal type and size	Wet, multiple disc type Inner push, cam axle type 72/23 (3.130) 183 ~ 185 15.81 $\pm$ 0.01 mm (3 Teeth) -0.03 40.03 $\pm$ 0.01 mm (7 Teeth) -0.03 2.8 mm (<math>\leq 2.5 \text{ mm}</math>)/6 pcs. (0.110 in (<math>\leq 0.988 \text{ in}</math>)) 1.2 mm/5 pcs. (0.047 in/5 pcs.) <math>\leq 0.05 \text{ mm (0.0020 in)}></math> 34.5 mm (<math>\leq 33.58 \text{ mm}</math>)/4 pcs. (1.362 in (<math>\leq 1.321 \text{ in}</math>)/4 pcs.) 20.65 kg/27 mm (45.53 lb/1.063 in) 2.6 kg/mm (145.5 lb/in) 0.10 ~ 0.35 mm (0.004 ~ 0.014 in) <math>\leq 0.2 \text{ mm (0.0079 in) or less}></math> Needle bearing (14—20—12) SD—14—26—5 HS
<b>Transmission:</b> Type Gear ratio: 1st 2nd 3rd 4th 5th	Constant mesh, 5 speed 37/14 (2.642) 32/19 (1.684) 29/23 (1.260) 26/26 (1.000) 23/28 (0.821)



Item	Required <Allowance>
Bearing type: Main axle (Left) Main axle (right) Drive axle (Left) Drive axle (right)	6C03 6205 6305 6C04
Oil seal type: Drive axle (Left) Main axle (Left)	SD—25—45—6—L S—17—28—3.5
Secondary reduction ratio and method	46/16 (2.875) chain
Shifting mechanism Operation system Shifting type Oil seal type: Change lever	Return type, left foot operation Guide bar type: cam drum system SD—12—22—5—HS
Air cleaner: Type/quantity	Dried, form rubber/1 pc.
Carburetor: Type and manufacture/quantity I.D. mark Main jet (M.J.) Main air jet (M.A.J.) Pilot air jet (P.A.J.) Jet needle: Clip position (J.N.) Needle jet (N.J.) Pilot jet (P.J.) Mixture screw turns out Starter jet (G.S.) Fuel level Idling engine speed	SOLEX B534-III MIKUNI/1 pc 3Y600 #122.5 #100 #180 5GP25 Y-5 #47.5 Preset #32.5 3 ± 1 mm (0.12 ± 0.04 in) 1,200 r/min
Lubrication: Transmission gear and engine sump oil Quantity Type Oil pump: Type Housing inside diameter Housing depth (delivery) Rotor diameter Rotor thickness (delivery) Outer rotor and housing clearance Top clearance Side clearance Tip clearance Relief valve opening pressure Oil cleaner type	Total amount: 1.6 liter (1.69 US qt) Exchange with oil filter: 1.3 liter (1.37 US qt) Yamalube 20W/40 motor oil or equivalent  Trochoid pump 29.10 ~ 29.13 mm ≦29.28 mm≧ (1.1457 ~ 1.1467 in ≦1.152 in≧) 12.03 ~ 12.07 mm ≦12.10 mm≧ (0.474 ~ 0.475 in ≦0.476 in≧) 28.98 ~ 29.00 mm ≦28.93 mm≧ (1.141 ~ 1.142 in ≦1.139 in≧) 11.98 ~ 12.0 mm ≦11.95 mm≧ (0.4716 ~ 0.4724 in ≦0.4705 in≧)  0.1 ~ 0.15 mm ≦0.35 mm≧ (0.0039 ~ 0.0059 in ≦0.014 in≧) 0.03 ~ 0.09 mm ≦0.14 mm≧ (0.0012 ~ 0.0035 in ≦0.0055 in≧) 0.15 mm or less ≦0.35 mm≧ (0.006 in ≦0.00138 in≧) 1.0 ± 0.2 bar (1.0 kg/cm <sup>2</sup> ) (14.2 lb/in <sup>2</sup> ) Paper and iron net

## Chassis Specifications

Item	Required «Allowance»
<b>Frame:</b> Frame design	Tubular steel diamond frame
<b>Steering system:</b> Caster Trail Number and size of balls in steering head Upper race Lower race Lock to lock angle	29.45° 121 mm (4.8 in) 19 pcs., 1/4 in. 19 pcs., 1/4 in. L.R. 43°
<b>Front suspension:</b> Type Front fork cushion travel Front fork spring Free length: Set length Wire dia. x winding dia. Spring constant  Inner tube outside diameter Front fork oil: Quantity Type	Telescopic fork 140 mm (5.5 in)  530 mm (20.87 in) 498 mm (19.65 in) 3.4 x 22.5 mm (0.13 x 0.89 in) $K_1 = 0.284 \text{ kg/mm}$ (0 ~ 100 mm) (15.9 lb/in (0 ~ 3.94 in)) $K_2 = 0.38 \text{ kg/mm}$ (100 ~ 140 mm) (21.3 lb/in (3.94 ~ 5.51 in))  32 mm (1.26 in) 165 cm <sup>3</sup> (5.68 oz.) Yamaha fork oil 10 wt.
<b>Rear suspension:</b> Type Damper type Rear shock absorber travel Rear wheel travel Rear shock absorber spring: Free length: Set length (soft position) Wire dia. x winding dia. Spring constant  Swing arm free play (limit) Pivot shaft: Outside dia. Bearing type and size Dust seal type and size	Swing arm Oil damper 70 mm (2.95 in) 85 mm (3.35 in)  188 mm (7.40 in) 168 mm (6.61 in) 6.5 x 8.6 mm (0.26 x 2.20 in) $K_1 = 1.4 \text{ kg/mm}$ (0 ~ 50 mm) (78.4 lb/in (0 ~ 1.97 in)) $K_2 = 2.0 \text{ kg/mm}$ (50 ~ 70 mm) (112.0 lb/in (1.97 ~ 2.76 in)) «1 mm (0.039 in)»  16 mm (0.63 in) oil less Bush MHA22-28 4-A
<b>Fuel tank:</b> Capacity Fuel grade	10.7 liter (2.8 US. gal)/Reserve 1.3 liter Regular gasoline
<b>Wheel:</b> Type Tire size: Front Rear Rim type: Front Rear Rim runout (limit): Front/Rear Rim hopping (limit): Front/Rear	Spoke 3.00—18—4PR Yokohama 120/90—16 63P 1.60—18/steel 2.15—16/steel «2.0 mm» («0.08 in») (Front/Rear) «2.0 mm» («0.08 in») (Front/Rear)

Item	Required «Allowance»
Bearing type:	
Front wheel (Left)	6202—RS
Front wheel (Right)	6202/34
Rear wheel (Left)	620311
Rear wheel (Right)	6203
Oil seal type:	
Front wheel (Left)	SD0—50—62—7
Front wheel (Right)	SD—20—35—7
Meter gear	SO—7—14—7
Rear wheel (Left)	.....
Rear wheel (Right)	SD—26—47—7
Secondary drive chain:	
Type	520DS
Number of links	102L
Chain pitch	15.875 mm (0.625 in)
Chain free play	25 ~ 35 mm (0.98 ~ 1.38 in)
Front brake:	
Type	Drum brake (Leading trailing)
Drum inside d.a. «wear limit»	160 mm «162 mm» (6.30 in «6.38 in»)
Shoe dia. x width	152 x 25 mm (5.98 x 0.98 in)
Shoe spring free length	68 mm (2.68 in)
Lining thickness «wear limit»	4 mm «2 mm» (0.16 in «0.08 in»)
Rear brake:	
Type	Drum brake (leading trailing)
Drum inside d.a. «wear limit»	130 mm «132 mm» (5.12 in «5.20 in»)
Shoe dia. x width	122 x 28 mm (4.80 x 1.10 in)
Shoe spring free length	36.5 mm (1.44 in)
Lining thickness «wear limit»	4 mm «2 mm» (0.16 in «0.08 in»)

## Electrical Specifications

Item	Required «Allowance»
voltage:	12V
Ignition system:	
Type	Battery ignition (Full transistor ignition)
Pulsar coil resistance (White/Rod—White/Green)	7000 ± 10% at 20°C (68°F)
Ignition advance:	STD C10 <sup>1</sup> /1,200 r/min
Advance type	Electrical
Advance angle	22°
Advance starting engine speed	2,050 r/min
Full advance engine speed	3,750 r/min
Ignition coil:	
Model/Manufacturer	CM11—55 HITACHI
Spark gap	«6 mm (0.24 in)/500 r/min»
Primary winding resistance	2.750 ± 20% at 20°C (68°F)
Secondary winding resistance	7.9 Ω ± 20% at 20°C (68°F)
Spark plug:	
Type	BP7ES (N.G.K.) or W22EP (NIPPON DENSO)
Spark plug gap	0.7 ~ 0.8 mm (0.028 ~ 0.031 in)
T.C.I. unit	HITACHI

Item	Required « Allowance »
<b>Charging system:</b> A.C. magneto generator: Model/Manufacturer: F170 56/HITACHI Rotor puller thread size: M27 x P1.0 Output: 14V—8A/4,000 r/min Lighting coil resistance: 0.39Ω ± 15% at 20°C (68°F) White—White Rectifier with regulator: Model/Manufacturer: SH222—12C/SHINDENGEN (Rectifier) Type: I.C. type, full wave Capacity: 12A Withstand voltage: 200V Withstand voltage (Regulator): 200V Type: I.C. type Regulating voltage: 14.5 ± 0.5V Allowable amperage: 12A Battery: Model/Manufacturer: 12N 12A 4A/G.S. Capacity: 12V, 12AH Charging rate: 1.2A x 10 hours Specific gravity: 1.280	
<b>Starting system</b> <b>Starter motor</b> Type: Constant mesh type Manufacturer: NIPPON DEN-NSO Model: ADB4D3 Output: 0.5 kW Armature coil resistance: 0.014Ω ± 6% at 20°C (68°F) Field coil resistance: ..... Brush size/Quantity: 12 x 9 x 6 mm (0.47 x 0.35 x 0.24 in)/2 pcs. Wear limit: 8.5 mm (0.33 in) Spring pressure: 800 g (28.2 oz) Commutator O.D./Wear limit: 28 mm (1.10 in)/27 mm (1.06 in) Mica undercut: 0.6 mm (C.02 in) <b>Starter switch</b> Manufacturer: HITACHI Model: A104-70 Amperage rating: Mx. 4A Cut-in voltage: Mx. 6.5V Winding resistance: .....	
<b>Lighting system</b> <b>Headlight type</b> : Sealed beam <b>Bulb wattage/quantity</b> : Headlight: 12V 50W/35W x 1 Tail light: 12V 3CP (8W) x 1 Brake light: 12V 32CP (27W) x 1 Flasher light: 12V 32CP (27W) x 4 Turn indicator light: 12V 3.4W x 2 Motor light: 12V 3.4W x 1 High beam indicator light: 12V 3.4W x 1 Neutral indicator light: 12V 3.4W x 1	

Item	Required «A lowance»
Horn: Model/Manufacturer Winding resistance Amperage	MF—12/NIKKO HORN 4.8Ω ± 10% at 20°C (68°F) 1.5A
Flasher relay: Type Model/Manufacturer Flasher frequency Capacity	Heat ribbon type FR9T21/MITSUBA 90 ± 3 cycle/min 12V 27W x 2 + 3.4W
Fuse: Rating	20A

### Torque Specifications

Part to be tightened	Thread and part name	Tightening torque	
		m·kg	ft·lb
Engine:			
Cylinder head, cylinder	M10 Hex bolt	3.75	27.1
	M8 Internal hex bolt	2.0	14.5
Cylinder head cover	M6 Internal hex bolt	1.0	7.2
	M6 Pan head screw	0.7	5.1
Camshaft bearing plate	M6 Hex bolt	0.8	5.8
Oil checking screw	M6 Hex bolt	0.7	5.1
Spark plug	M14 Hex nut	2.0	14.5
Balancer boss	M16 Hex nut	6.0	43.4
Flywheel magneto	M12 Hex nut	8.0	57.9
Valve clearance	M6 Hex nut	1.35	9.8
Cam sprocket	M10 Bolt	5.5	39.8
Chain tensioner	M6 Bolt	0.8	5.8
	M6 Nut	1.2	8.7
Oil pump	M6 Pan head screw	0.7	5.1
Drain plug	M40	3.2	23.1
Filter cover	M6 Internal hex bolt	1.0	7.2
	M6 Pan head screw	0.7	5.1
Bleed bolt	M5 Hex bolt	0.5	3.6
Carburetor manifold	M6 Internal hex bolt	1.2	8.7
Carburetor clamp hose	M5 Pan head screw	0.2	1.5
Air cleaner case cover	M6 Pan head screw	0.5	3.6
Air cleaner case	M6 Hex bolt	0.7	5.1
Exhaust pipe assembly	M6 Internal hex bolt	1.2	8.7
	M8 Hex bolt	2.0	14.5
Crankcase, Casecover	M6 Pan head screw	0.7	5.1
Balancer bearing plate	M6 Flat head screw	0.7	5.1
Chain tensioner plug	M10 Hex bolt	3.0	21.7
Clutch spring	M6 Hex bolt	0.8	5.8
Clutch boss	M20 Hex nut	0.7	5.1
Primary drive gear	M16 Hex nut	0.7	5.1
Push lever stopper	M8 Hex bolt	1.2	8.7
Push rod adjustment	M6 Hex nut	0.8	5.8
Drive sprocket	M6 Hex bolt	1.0	7.2
Shift cam	M5 Flat head screw	0.37	2.7
Shift pedal	M6 Hex bolt	0.8	5.8
Magneto base	M6 Pan head screw	0.7	5.1

Part to be tightened	Thread and part name	Tightening torque	
		m-kg	ft-lb
Neutral switch	M10	2.0	14.5
Tappet cover positioning bolt	M6 Internal hex bolt	1.0	7.2
<b>Chassis:</b>			
Engine mounting	M8 Hex bolt, nut	3.2	23.1
Engine adjusting plate	M8 Hex bolt, nut	2.0	14.5
Handle crown and inner tube	M8 Hex bolt, nut	2.0	14.5
Handle crown and handle holder	M8 Hex bolt	2.0	14.5
Front fork cap bolt	M30 Hex bolt	2.2	15.9
Under bracket and inner tube	M12 Hex bolt	3.7	26.8
Front wheel shaft	M14 Shaft, nut	10.6	76.7
Pivot shaft	M14 Shaft, nut	6.5	47.0
Rear wheel shaft	M16 Shaft, nut	10.6	76.7
Sprocket wheel	M8 Hex bolt	3.0	21.7
Rear shock absorber	M10 Hex bolt	3.0	21.7
Foot rest	M8 Hex bolt	2.0	14.5
Camshaft lever	M6 Hex bolt, nut	0.8	5.8
Front fork cylinder and outer tube	M10 Socket head bolt	2.3	16.6
Steering ring nut	M25	3.7	26.8
Steering fitting bolt	M14 Hex bolt	5.3	38.3
Spoke	-----	0.2	1.4
Seat belt	M8 Hex bolt	1.5	10.8
Grab bar	M8 Hex bolt	1.5	10.8
Rear foot rest	M10 Flange nut	4.5	32.5

## General Torque Specifications

This chart specifies torque for standard fasteners with standard I.S.O. pitch threads. Torque specifications for special components or assemblies are included in the applicable sections of this book. To avoid warpage, tighten multi-fastener assemblies in a criss-

cross fashion, in progressive stages, until full torque is reached. Unless otherwise specified, torque specifications call for clean, dry threads. Components should be at room temperature.

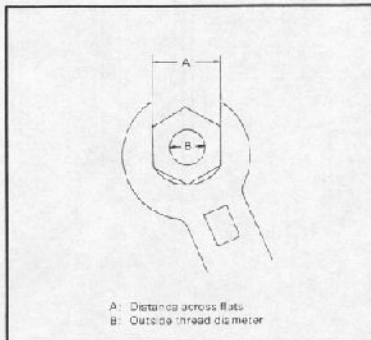

A	B	Torque specification		
		m-kg	ft-lb	in-lb
10 mm	6 mm	1.0	7.2	85
12 mm	8 mm	2.0	15	175
14 mm	10 mm	3.5 ~ 4.0	25 ~ 29	300 ~ 350
17 mm	12 mm	4.0 ~ 4.5	29 ~ 33	350 ~ 400
19 mm	14 mm	6.5 ~ 8.0	33 ~ 36	400 ~ 440
22 mm	16 mm	6.5 ~ 6.5	41 ~ 49	480 ~ 570
24 mm	18 mm	8.8 ~ 7.0	42 ~ 50	500 ~ 600
27 mm	20 mm	7.0 ~ 8.3	50 ~ 60	600 ~ 700

## Conversion Tables

METRIC TO INCH SYSTEM			
	KNOWN	MULTIPLIER	RESULT
TORQUE	m-kg	7.233	ft-lb
	m-kg	86.80	in-lb
	cm-kg l	0.723	ft-lb
	cm-kg	0.8680	in-lb
WT	kg	2.205	lb
	g	0.03527	oz
FLOW/DISTANCE	km/l	2.352	mpg
	km/hr	0.6214	mph
	km	0.6214	mi
	m	3.281	ft
	m	1.094	yd
	cm	0.3937	in
mm	0.03937	in	
VOL. CAPACITY	cc (cm <sup>3</sup> )	0.03382	oz (US liq)
	cc (cm <sup>3</sup> )	0.06102	cu in
	l (liter)	2.1134	pt (US liq)
	l (liter)	1.057	qt (US liq)
	l (liter)	0.2642	gal (US l q)
MISC.	kg/mm	56.007	lb/in
	kg/cm <sup>2</sup>	14.2234	psi (lb/in <sup>2</sup> )
	Centigrade (°C)	9/5 (°C) + 32	Fahrenheit (°F)

INCH TO METRIC SYSTEM			
	KNOWN	MULTIPLIER	RESULT
TORQUE	ft-lb	0.13826	m-kg
	in-lb	0.01182	m-kg
	ft-lb	13.831	cm-kg
	in-lb	1.1521	cm-kg
WT	lb	0.4535	kg
	oz	28.352	g
FLOW/DISTANCE	mpg	0.4252	km/l
	mph	1.609	km/hr
	mi	1.609	km
	ft-lb	0.3048	m
	yd	0.9141	m
	in	2.54	cm
in	25.4	mm	
VOL. CAPACITY	oz (US liq)	29.57	cc (cm <sup>3</sup> )
	cu in	16.387	cc (cm <sup>3</sup> )
	pt (US liq)	0.4732	l (liter)
	qt (US liq)	0.9461	l (liter)
	gal (US l q)	3.785	l (liter)
MISC.	lb/in	0.017855	kg/mm
	psi (lb/in <sup>2</sup> )	0.07031	kg/cm <sup>2</sup>
	Fahrenheit (°F)	5/9 (°F - 32)	Centigrade (°C)

# LUBRICATION CHART

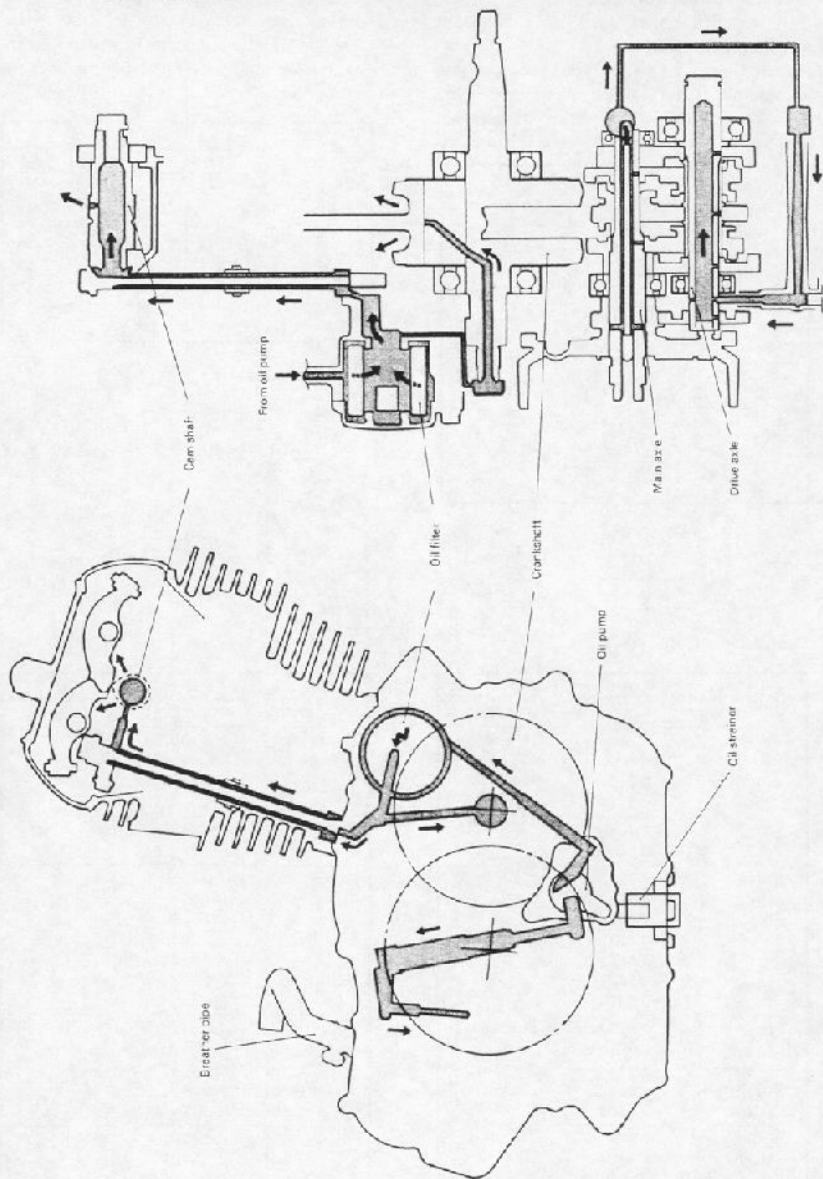



# WIRING DIAGRAM

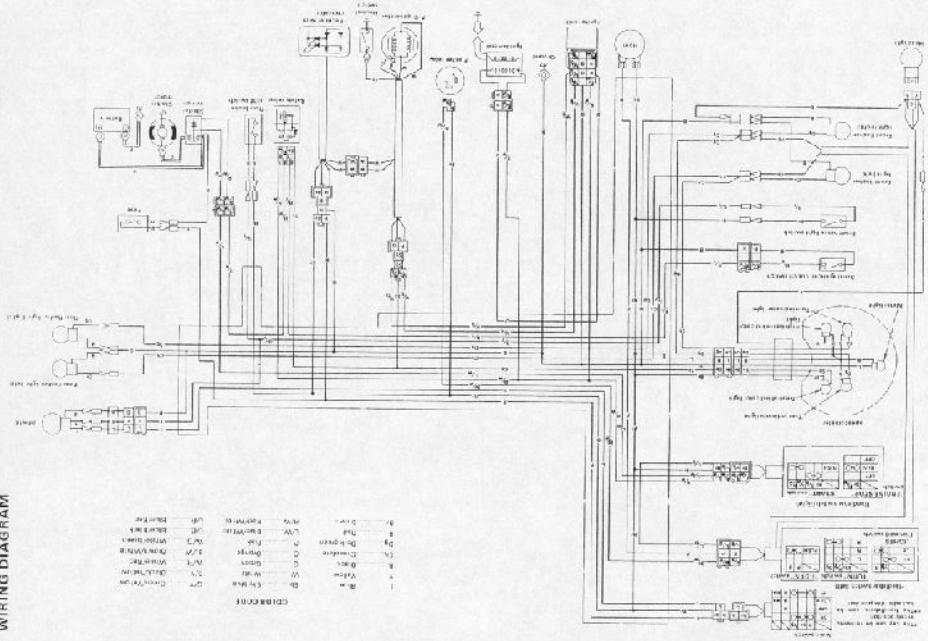

- |   |       |   |       |   |       |   |       |   |       |
|---|-------|---|-------|---|-------|---|-------|---|-------|
| 1 | B. M. | 1 | W. M. | 1 | W. M. | 1 | W. M. | 1 | W. M. |
| 2 | B. M. | 2 | W. M. | 2 | W. M. | 2 | W. M. | 2 | W. M. |
| 3 | B. M. | 3 | W. M. | 3 | W. M. | 3 | W. M. | 3 | W. M. |
| 4 | B. M. | 4 | W. M. | 4 | W. M. | 4 | W. M. | 4 | W. M. |
| 5 | B. M. | 5 | W. M. | 5 | W. M. | 5 | W. M. | 5 | W. M. |
| 6 | B. M. | 6 | W. M. | 6 | W. M. | 6 | W. M. | 6 | W. M. |
| 7 | B. M. | 7 | W. M. | 7 | W. M. | 7 | W. M. | 7 | W. M. |
| 8 | B. M. | 8 | W. M. | 8 | W. M. | 8 | W. M. | 8 | W. M. |
| 9 | B. M. | 9 | W. M. | 9 | W. M. | 9 | W. M. | 9 | W. M. |
1. B. M.  
 2. W. M.  
 3. W. M.  
 4. W. M.  
 5. W. M.  
 6. W. M.  
 7. W. M.  
 8. W. M.  
 9. W. M.

# CABLE ROUTING

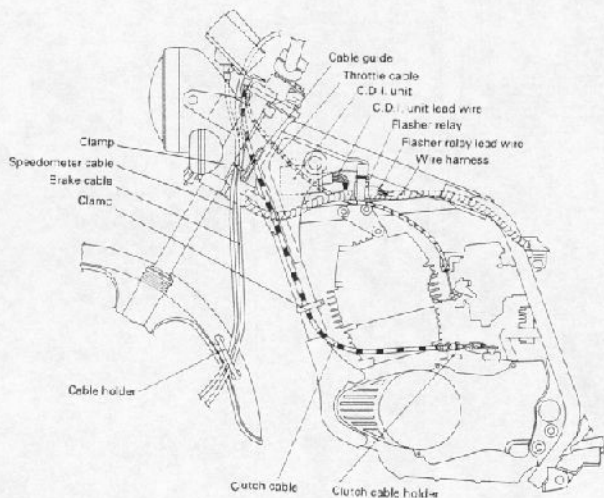
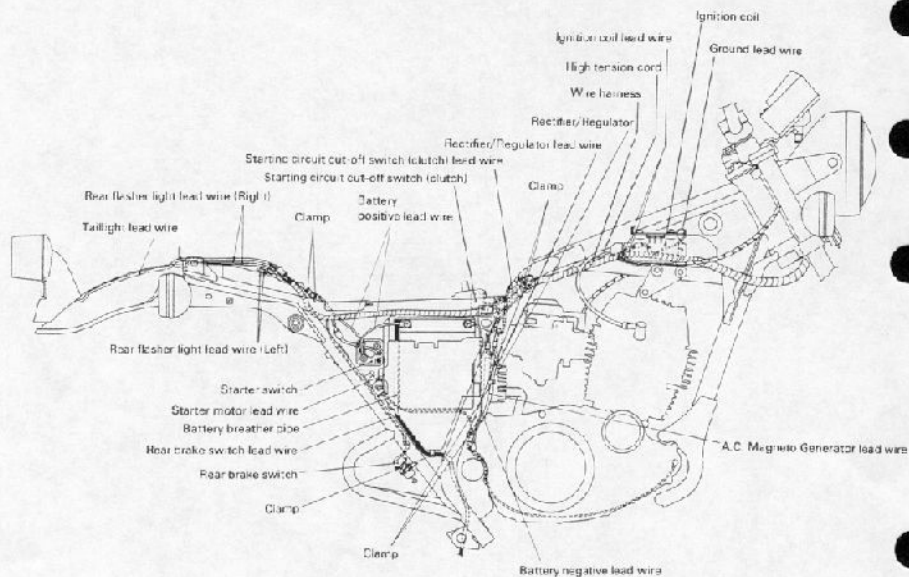

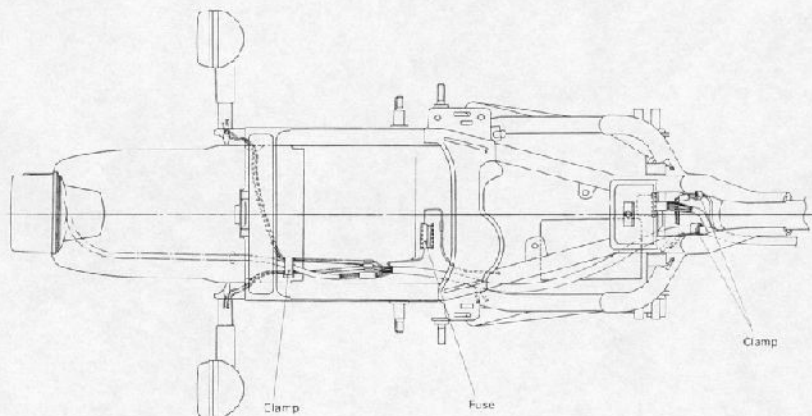
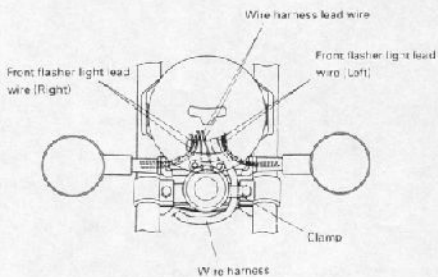
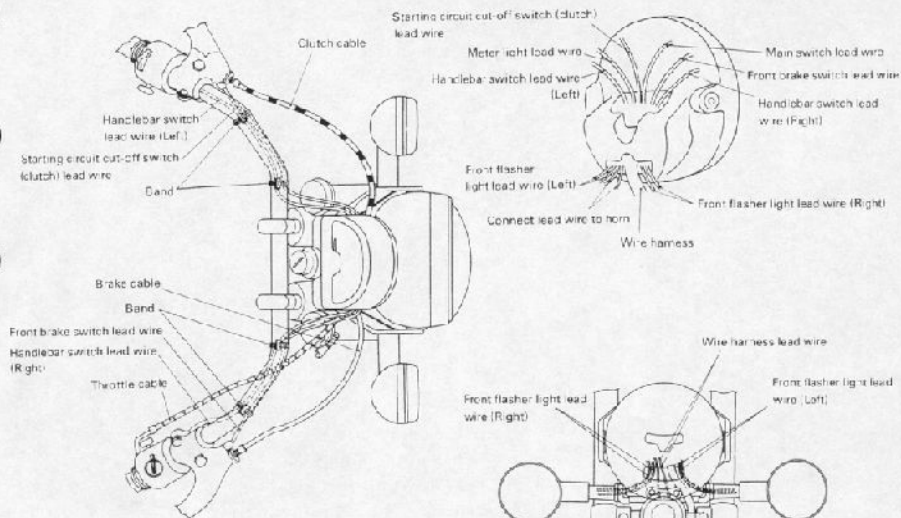

**PROTECT YOUR INVESTMENT**  
**Use *Genuine YAMAHA* Parts And Accessories**



LIT-11616-01-93

YAMAHA MOTOR CORPORATION, U.S.A.  
PRINTED IN U.S.A.