

Bombardier Recreational Products Inc.

BOMBARDIER* ATV

OPERATOR'S GUIDE

INCLUDES
SAFETY, VEHICLE AND MAINTENANCE
INFORMATION



WARNING

Read this guide thoroughly.
It contains important safety information.
Minimum recommended operator age:
A child under 6 years should never
operate an ATV with an engine size 50 cc
or greater.
A child under 12 years should never
operate an ATV with an engine size 70 cc
or greater.

DS50™
DS90™

DS90™ 4 STROKE

2 1 9 0 0 0 3 5 6

This Operator's Guide utilizes the following symbols to emphasize particular information:

 The Safety Alert Symbol indicates a potential personal injury hazard.

 **WARNING** Indicates a potentially hazardous situation which, if not avoided, could result in serious injury or death.

CAUTION: Denotes an instruction which, if not followed, could severely damage vehicle components.

 **WARNING**

YOUR VEHICLE CAN BE HAZARDOUS TO OPERATE. A collision or rollover can occur quickly, even during routine maneuvers such as turning and driving on hills or over obstacles, if you fail to take proper precautions. For your safety, understand and follow all the warnings contained in this Operator's Guide and the labels on your vehicle. **Failure to follow these warnings can result in SEVERE INJURY OR DEATH!** Keep this Operator's Guide with the vehicle at all times.

 **WARNING**

Disregarding any of the safety precautions and instructions contained in this Operator's Guide, Safety Videocassette and on-product labels could cause injury including the possibility of death!

All safety documentation should remain with the vehicle at the time of sale.

All content of the Safety Information section should be interpreted by the reader as a warning which, if not followed, may result in injury including the possibility of death.

In Canada, products are distributed by Bombardier Recreational Products Inc. (BRP)

In USA, products are distributed by Bombardier Motor Corporation of America.

The following trademarks are the property of Bombardier Recreational Products Inc.:

DS50™

DS90™

DS90™ 4-Stroke

FOREWORD

Congratulations on your purchase of a new Bombardier* recreational vehicle, category Y (youth model). It is backed by the BRP warranty and a network of authorized Bombardier ATV dealers ready to provide the parts, service or accessories you may require.

Your dealer is committed to your satisfaction. He has taken training to perform the initial setup and inspection of your vehicle as well as completed the final adjustment before you took possession. At delivery, your dealer would have explained the operation, maintenance and safety features of the vehicle. We trust you have taken full advantage of this! If you need more complete servicing information, please ask your dealer.

At delivery, you were also informed of the warranty coverage and completed the Warranty Registration Form which is to be sent to us for processing. In the near future you should be receiving a warranty card which will confirm our receipt of the registration as well as be used for warranty or recall purposes.

You are invited to contact our customer assistance center should you experience problems which cannot be resolved by an authorized Bombardier ATV dealer.

It is understood that this Operator's Guide may be translated into another language. In the event of any discrepancy, the English version shall prevail. Throughout this document the masculine is used to denote the masculine or feminine.

The information and components/system descriptions contained in this document are correct at the time of publication. Bombardier Recreational Products Inc., however, maintains a policy of continuous improvement of its products without imposing upon itself any obligation to install them on products previously manufactured. Due to late changes, some differences between the manufactured product and the descriptions and/or specifications in this guide may occur. BRP reserves the right at any time to discontinue or change specifications, designs, features, models or equipment without incurring any obligation upon itself.

The illustrations in this document show the typical construction of the different assemblies and may not reproduce the full detail or exact shape of the parts. However, they represent parts that have the same or similar function.

The use of RIGHT and LEFT indications in the text always refers to driving position (when sitting on vehicle).

Specifications are given in the SI metric system with the SAE U.S. equivalent in parenthesis. Where precise accuracy is not required, some conversions are rounded off for easier use.

We recommend genuine Bombardier products for replacement parts and accessories. They've been especially designed for your vehicle and manufactured to meet BRP's demanding standards.

A Shop Manual can be obtained for complete service and maintenance information and more repair information.

TABLE OF CONTENTS

While reading this Operator's Guide, remember that:

WARNING

Indicates a potential hazard that, if not avoided, could result in serious injury or death.

NOTICE	5
Notice to Parents	5
INTRODUCTION	7

SAFETY INFORMATION

SPECIAL SAFETY MESSAGES	10
OPERATION WARNINGS	13
SAFETY WARNING	39
Pre-operation Check	40
Clothing	41
Carrying Loads	42
Recreational Riding	42
Environment	42
Design Limitation	43
Off-Highway Operation	43
General Operating and Safety Precautions	43
Uphill Driving	43
Downhill Driving	44
Side Hilling	44
Drop-Offs	44
Riding Techniques	44
Routine Maintenance	51
LOCATION OF THE IMPORTANT LABELS	52

VEHICLE INFORMATION

HOW TO IDENTIFY YOUR ATV	56
Vehicle Identification Number Location	56
Engine Identification Number Location	56
CONTROLS/INSTRUMENTS/EQUIPMENT	57
1) Throttle Lever	59
2) Speed Limiter Screw	59
3) Front Brake Lever	60
4) Rear Brake Lever	60
5) Brake Lever Lock	60
6) Multi-Function Switch	61

7) Neutral Indicator Light	62
8) Ignition Switch	62
9) Choke Knob Lever	62
10) Fuel Tank Cap	63
11) Fuel Valve	63
12) Footpeg.....	64
13) Seat Latch Knob	64
14) Fuse.....	65
15) Gearshift Pedal	65
16) Kick Start Pedal	66
LIQUIDS	67
Fuel.....	67
Engine Oil.....	67
Battery	69
BREAK-IN PERIOD	70
Engine.....	70
Belt	70
10-Hour Inspection	70
PRE-OPERATION CHECK.....	71
OPERATING INSTRUCTIONS	72
General.....	72
Initial Cold Starting.....	72
Warm Engine Starting	73
Stopping the Engine	73
Shifting the Transmission	73
SPECIAL PROCEDURES.....	74
Flooded Engine.....	74
Engine Overheat.....	74
Post-Operation Care	74
Turn Over	74
ATV Immersion.....	74
Storage and Preseason Preparation.....	74
TRANSPORTATION	76
Transportation	76

MAINTENANCE INFORMATION

MAINTENANCE CHART	78
MAINTENANCE	80
Engine/Transmission.....	80
Air Filter	81
Electrical	83
Drive Train	84
Steering System	86
Suspension	86

Brake	86
Body/Frame	87
TROUBLESHOOTING	88
SPECIFICATIONS.....	91
SI METRIC INFORMATION GUIDE	97

WARRANTY

BRP LIMITED WARRANTY NORTH AMERICA: 2005 BOMBARDIER[†] ATV	100
BRP INTERNATIONAL LIMITED WARRANTY: 2005 BOMBARDIER[†] ATV	104
PRIVACY OBLIGATION/DISCLAIMER.....	108
CHANGE OF ADDRESS/OWNERSHIP.....	109

NOTICE

This Operator's Guide has been prepared to acquaint the owner/operator of a new vehicle with the various vehicle controls, maintenance and safe operating instructions. It is indispensable for the proper use of the product.

This Operator's Guide uses the following symbols.

WARNING

Indicates a potentially hazardous situation which, if not avoided, could result in serious injury or death.

CAUTION: Denotes an instruction which, if not followed, could severely damage vehicle components.

NOTE: Indicates supplementary information needed to fully complete an instruction.

Although the mere reading of such information does not eliminate the hazard, the understanding and application of the information will promote the correct use of this vehicle.

To fully appreciate the pleasures, enjoyment and excitement of using this vehicle, there are some basic rules that **MUST** be observed and followed by any user.

This vehicle is a youth model ATV. It is designed to provide the following speed.

- The DS50 provides a maximum restricted speed of 16 km (10 MPH).
- The DS90 provides a maximum restricted speed of 24 km (15 MPH).

Notice to Parents

Review this Operator's Guide with any vehicle's user.

Please take time with the children to review the instructions on its safe and proper use, while pay attention to the on-product safety labeling before allowing them to ride the vehicle.

Understand the controls and operation of the vehicle, carefully read the Operator's Guide, pay attention to the on-product safety labeling and review them with children before allowing them to ride the vehicle.

A child under 6 years old should never operate the DS50 or an ATV with an engine size 50 cc or higher.

A child under 12 years old should never operate the DS90 or an ATV with an engine size 70 cc or higher.

Always remember that your approach to safety influences the child.

WARNING

An ATV is not a toy.

- Children differ in skills, physical abilities and judgement. Some children may not be able to operate an ATV safely.
- Parents should supervise their children when they use of the ATV at all times.
- Parents should permit continued use only if they determine that the child has the ability to operate the ATV safely.
- No one under 16 years should operate an ATV without adult supervision at all times and never allow continued use of the ATV by a child if he does not have the abilities, the strength or the judgement to operate it safely.
- BRP recommends that all ATV riders take a training course. For safety and training information, contact an authorized Bombardier ATV dealer or call the Specialty Vehicle Institute of America (SVIA) at 1 800 887-2887 or in Canada, the Canada Safety Council (CSC) at 1 (613) 739-1535 ext. 227.

INTRODUCTION

Your dealer should have provided you with some basic information on the particular controls and features of your new youth model ATV. Please take the time to study this Operator's Guide and all on-product warning labels as well as the Safety Videocassette that came with this vehicle. They more completely describe what you should know about this vehicle before riding it.

Whether you are a new user or an experienced rider, it is important for your personal safety as well as passenger safety that you know the controls and features of this vehicle. Equally important is knowing how to properly ride.

Irrespective of your age, experience or state regulations, it is always prudent for you or any other person who may ride your vehicle, to take an approved safe riding course. Please check with your dealer or local authorities for availability in your area. If you are a completely new rider, this should be done before your first ride. Your instructor should be able to provide advice on local conditions and safe riding practices particular to the area.

Riding conditions vary from place to place. Each is subject to weather conditions which may radically change from time to time and from season to season. Riding on sand is different than riding on snow or through forests or marshes. Each location may require a greater degree of awareness and skill may not be suitable with a passenger. Show good judgement. Always proceed with caution. Please do not take any unnecessary risks that could leave you or your passenger stranded or possibly injured.

The vehicle handling, stability and braking distance may be affected when riding with a passenger. Safely reduce speed when riding with a passenger. Allow greater distance for braking.

The contents of this Operator's Guide provide riding information which has been proven reliable by other users. They are not intended as a definitive means of avoiding accidents. How you apply this information, coupled with your mental and physical condition, the particular terrain hazard and your risk acceptance level will have an effect on your riding experience. Have fun... and ride responsibly.

This Operator's Guide has been prepared to acquaint the owner/operator of a new vehicle with the various vehicle controls, maintenance and safe operating instructions. They are indispensable for the proper use of the product.

We would be pleased to receive any comments on the content and format of this Operator's Guide, the Safety Videocassette or on-product warnings labels.

SAFETY INFORMATION

SPECIAL SAFETY MESSAGES

THIS VEHICLE IS NOT A TOY AND CAN BE HAZARDOUS TO OPERATE.

This vehicle handles differently from other vehicles including motorcycles and cars. A collision or rollover can occur quickly, even during routine maneuvers such as turning and driving on hills or over obstacles, if you fail to take proper precautions.

SEVERE INJURY OR DEATH can result if you do not follow these instructions:

- ⚠ Read this Operator's Guide and all on-product warning labels carefully and follow the operating procedures described. Watch and pay attention to the Safety Videocassette before operation.
- ⚠ Never operate this vehicle without proper instruction. Take a training course. Beginners should receive training from a certified instructor. Contact an authorized Bombardier ATV dealer to find out about available training course nearest you or call , in USA, the Specialty Vehicle Institute of America (SVIA) at 1 800 877-2887 or in Canada, the Canada safety Council (CSC) at 1 (613) 739-1535 ext. 227.
- ⚠ Always follow this age recommendation:
 - A child under 6 years old should never operate an ATV with engine size 50 cc or greater.
 - A child under 12 years old should never operate an ATV with engine size 70 cc or greater.
- ⚠ Never allow a child under age 16 to operate a category "Y" (youth model) ATV without adult supervision, and never allow continued use of an ATV by a child if he does not have the abilities to operate it safely.
- ⚠ Never carry a passenger on this vehicle.
- ⚠ Never operate this vehicle on any paved surfaces, including sidewalks, driveways, parking lots and streets .
- ⚠ Never operate this vehicle on any public street, road or highway, even a dirt or gravel one.
- ⚠ Never take place on this vehicle without wearing an approved helmet that fits properly. You should also wear eye protection (goggles or face shield), gloves, boots, long sleeved shirt or jacket, and long pants.
- ⚠ Never consume alcohol or drugs before or while riding this vehicle.
- ⚠ Never operate at excessive speeds. Always go at a speed that is proper for the terrain, visibility, and operating conditions, and your experience.
- ⚠ Never attempt wheelies, jumps, or other stunts.
- ⚠ Always inspect your vehicle each time you use it to make sure it is in safe operating condition. Always follow the inspection and maintenance procedures and schedules described in this Operator's Guide.
- ⚠ Always keep both hands on the handlebars and both feet on the footpegs of the vehicle during operation.
- ⚠ Always go slowly and be extra careful when operating on unfamiliar terrain. Always be alert to changing terrain conditions when operating this vehicle.

- ⚠ Never operate on excessively rough, slippery or loose terrain until you have learned and practiced the skills necessary to control this vehicle on such terrain. Always be especially cautious on these kinds of terrain.
- ⚠ Always follow proper procedures for turning as described further in this Operator's Guide. Practice turning at low speeds before attempting to turn at faster speeds. Do not turn at excessive speed.
- ⚠ Never operate this vehicle on hills too steep for the vehicle or for your abilities. Practice on smaller hills before attempting larger hills.
- ⚠ Always follow proper procedures for climbing hills as described further in this Operator's Guide. Check the terrain carefully before you start up any hill. Never climb hills with excessively slippery or loose surfaces. Shift your weight forward. Never open the throttle suddenly or make sudden gear changes. Never go over the top of any hill at high speed.
- ⚠ Always follow proper procedures for going down hills and for braking on hills as described further in this Operator's Guide. Check the terrain carefully before you start down any hill. Shift your weight backward. Never go down a hill at high speed. Avoid going down a hill at an angle that would cause the vehicle to lean sharply to one side. Go straight down the hill where possible.
- ⚠ Always follow proper procedures for crossing the side of a hill as described further in this Operator's Guide. Avoid hills with excessively slippery or loose surfaces. Shift your weight to the uphill side of the vehicle. Never attempt to turn the vehicle around on any hill until you have mastered the turning technique described in this Operator's Guide on level ground. Avoid crossing the side of a steep hill if possible.
- ⚠ Always use proper procedures if you stall or roll backwards when climbing a hill. To avoid stalling, use proper gear and maintain a steady speed when climbing a hill. If you stall or roll backwards, follow the special procedure for braking described in this Operator's Guide. Dismount on the uphill side or to a side if pointed straight uphill. Turn the vehicle around and remount, following the procedure described further in this Operator's Guide.
- ⚠ Always check for obstacles before operating in a new area. Never attempt to operate over large obstacles, such as large rocks or fallen trees. Always follow proper procedures when operating over obstacles as described further in this Operator's Guide.
- ⚠ Always be careful when skidding or sliding. Learn to safely control skidding or sliding by practicing at low speeds and on level smooth terrain. On extremely slippery surfaces, such as ice, go slowly and be very cautious in order to reduce the chance of skidding out of control.

- ⚠ Never operate this vehicle in fast flowing water or in water deeper than that specified in this Operator's Guide. Remember that wet brakes may have reduced stopping ability. Test your brakes after leaving water. If necessary, apply them several times to let friction dry out the pads.
- ⚠ Always use the size and type tires specified further in this Operator's Guide. Always maintain proper tire pressure as described further in this Operator's Guide.
- ⚠ Never load a youth model ATV.
- ⚠ FOR MORE INFORMATION ABOUT ATV SAFETY, call the Specialty Vehicle Institute of America (SVIA) at 1 800 887-2887 or in Canada, the Canada Safety Council (CSC) at 1 (613) 739-1535 ext. 227 or contact an authorized Bombardier ATV dealer to find out about available training courses nearest you.

OPERATION WARNINGS

While reading this Operator's Guide, remember that:

WARNING

Indicates a potential hazard that, if not avoided, could result in serious injury or death.

The following warning and their format have been requested by the United States Consumer Product Safety Commission and are required to be in the Operator's Guide for all ATVs.

NOTE: The following illustrations are general representations only. Your model may differ.

WARNING



V00A0AQ

POTENTIAL HAZARD

Operating this vehicle without proper instruction.

WHAT CAN HAPPEN

The risk of an accident is greatly increased if the operator does not know how to operate this vehicle properly in different situations and on different types of terrain.

HOW TO AVOID THE HAZARD

Beginning and inexperienced operators should complete the training course offered by BRP. They should then regularly practice the skills learned in the course and the operating techniques described in this Operator's Guide.

For more information about the training course, contact an authorized Bombardier ATV dealer or call BRP at 1 (819) 566-3366.

 **WARNING**



V00A19Q

POTENTIAL HAZARD

Failure to follow the age recommendations for this vehicle.

WHAT CAN HAPPEN

Use by children of ATVs that are not recommended for their age can lead to severe injury or death of the child.

Even though a child may be within the age group for which this vehicle is recommended, he may not have the skills, abilities, or judgment needed to operate this vehicle safely and may be involved in a serious accident.

HOW TO AVOID THE HAZARD

A child under 6 years old should never operate an ATV.

The DS50 model is designed for children 6 years old and above. The DS90 are designed for children 12 years old and above.

No one under 16 should operate a category "Y" (youth model) ATV without adult supervision.

Adults should never allow continued use of the ATV by a child if he does not the abilities, strength or judgement to operate it safely.

⚠ WARNING



V00A02Q

POTENTIAL HAZARD

Carrying a passenger on this vehicle.

WHAT CAN HAPPEN

Greatly reduces your ability to balance and control this vehicle.

Could cause an accident, resulting in harm to you and/or your passenger.

HOW TO AVOID THE HAZARD

Never carry passenger. Even with a long seat that provides unrestricted operator movement, it is not designed nor intended to carry passenger(s).

 **WARNING**

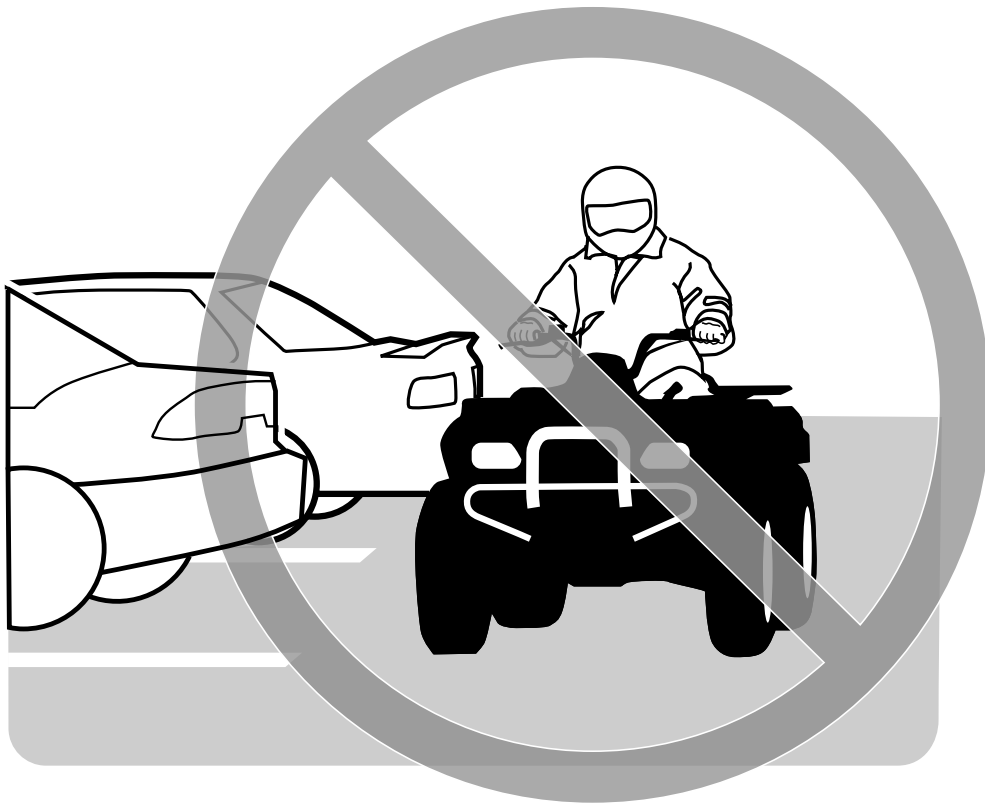

V00A03Q

POTENTIAL HAZARD

Operating this vehicle on paved surfaces.

WHAT CAN HAPPEN

The ATV's tires are designed for off-road use only, not for use on pavement. Paved surfaces may seriously affect handling and control of this vehicle, and may cause the vehicle to go out of control.

HOW TO AVOID THE HAZARD

Never operate this vehicle on any paved surfaces, including sidewalks, driveways, parking lots and streets.

⚠ WARNING



V00A04Q

POTENTIAL HAZARD

Operating this vehicle on public streets, roads or highways.

WHAT CAN HAPPEN

You can collide with another vehicle.

HOW TO AVOID THE HAZARD

Never operate this vehicle on any public street, road or highway, even a dirt or gravel one. In many states or provinces it is illegal to operate ATVs on public streets, roads or highways.

WARNING



V00A06Q

POTENTIAL HAZARD

Riding this vehicle without wearing an approved helmet, eye protection and protective clothing.

WHAT CAN HAPPEN

The following items concern all ATV's operator:

- riding without an approved helmet increases the chances of a severe head injury or death in the event of an accident
- riding without eye protection can result in an accident and increases the chances of a severe injury in the event of an accident
- riding without protective clothing increases the chances of severe injury in the event of an accident.

HOW TO AVOID THE HAZARD

Always wear an approved helmet that fits properly. You should also wear:

- eye protection (goggles or face shield)
- gloves and boots,
- long sleeved shirt or jacket
- long pants.

⚠ WARNING



V00A07Q

POTENTIAL HAZARD

Riding this vehicle after consuming alcohol or drugs.

WHAT CAN HAPPEN

- Could seriously affect your judgment.
- Could cause you to react more slowly.
- Could affect your balance and perception.
- Could result in an accident or death.

HOW TO AVOID THE HAZARD

Never consume alcohol or drugs before or while riding this vehicle.

 **WARNING**

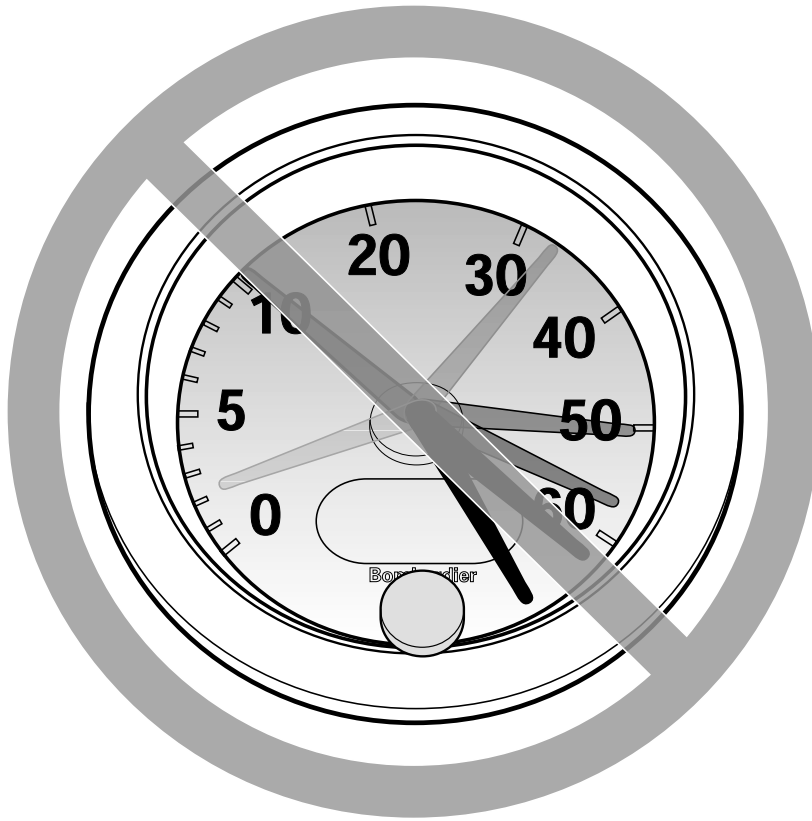

V00A08Q

POTENTIAL HAZARD

Operating this vehicle at excessive speeds.

WHAT CAN HAPPEN

Increases your chances of losing control of the vehicle, which can result in an accident.

HOW TO AVOID THE HAZARD

Always travel at a speed which is proper for the terrain, visibility and operating conditions, and your experience.

⚠ WARNING

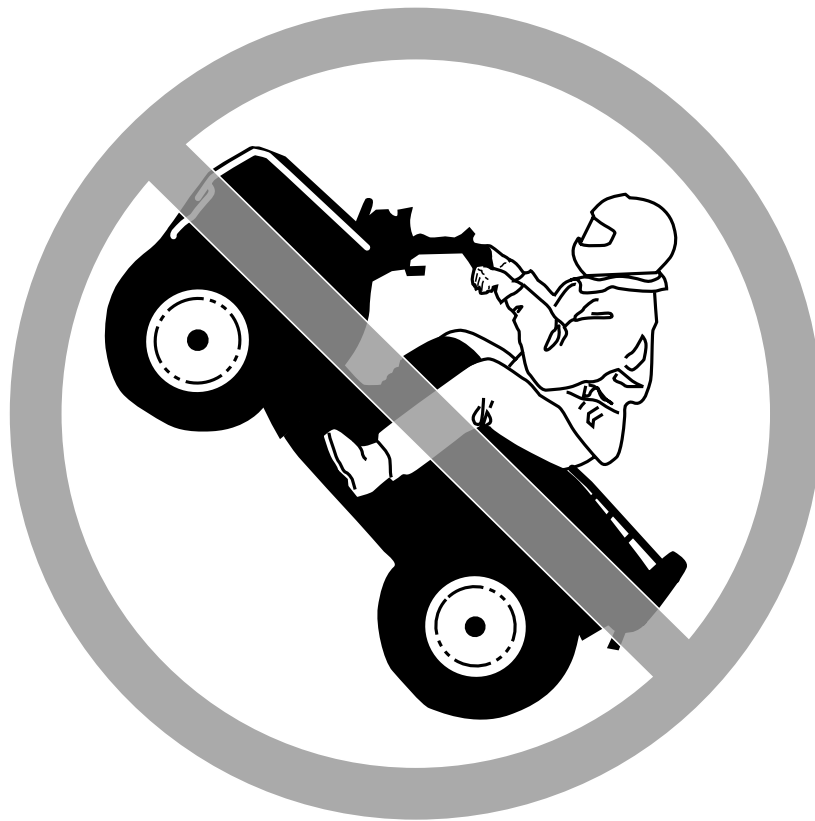

V00A09Q

POTENTIAL HAZARD

Attempting wheelies, jumps and other stunts.

WHAT CAN HAPPEN

Increases the chance of an accident, including an overturn.

HOW TO AVOID THE HAZARD

Never attempt stunts, such as wheelies or jumps. Do not try to show off.

 **WARNING**

POTENTIAL HAZARD

Failure to inspect the vehicle before operating.
Failure to properly maintain the vehicle.

WHAT CAN HAPPEN

Increases the possibility of an accident or equipment damage.

HOW TO AVOID THE HAZARD

Always inspect your vehicle each time you use it to make sure the vehicle is in safe operating condition.

Always follow the inspection and maintenance procedures and schedules described further in this Operator's Guide.

 **WARNING**

POTENTIAL HAZARD

Riding on frozen waterways.

WHAT CAN HAPPEN

Severe injury or death can result if the vehicle and/or operator break through the ice.

HOW TO AVOID THE HAZARD

Never ride this vehicle on a frozen surface before you are sure the ice is thick enough and sound enough to support the vehicle and its load, as well as the force that is created by a moving vehicle.

WARNING



V00A0BQ

POTENTIAL HAZARD

Removing hands from handlebar or feet from the footrests during operation.

WHAT CAN HAPPEN

Removing even one hand or foot can reduce your ability to control the vehicle or could cause you to lose your balance and fall off the vehicle. If you remove a foot from the footrests, your foot or leg may come into contact with the rear wheels, which could injure you or cause an accident.

HOW TO AVOID THE HAZARD

Always keep both hands on the handlebar and both feet on the footrests during vehicle operation.

 **WARNING**

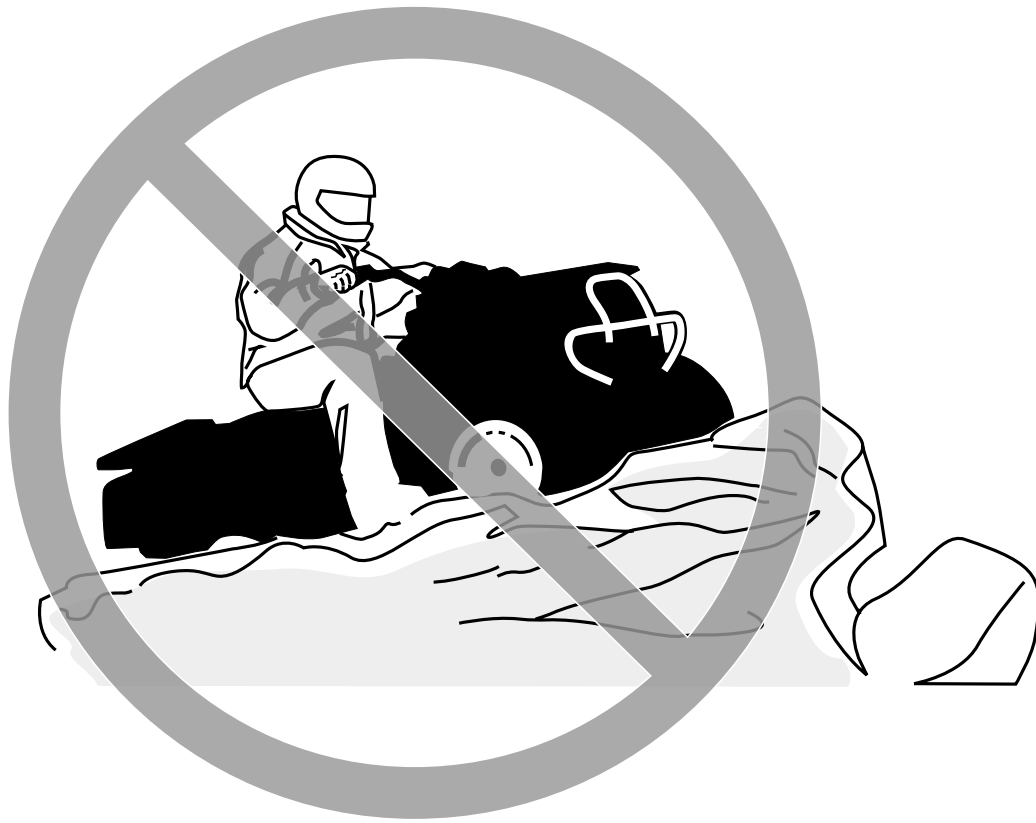

V00A0CQ

POTENTIAL HAZARD

Failure to use extra care when operating this vehicle on unfamiliar terrain.

WHAT CAN HAPPEN

You can come upon hidden rocks, bumps, or holes, without enough time to react.

Could result in the vehicle overturning or loss of control.

HOW TO AVOID THE HAZARD

Go slowly and be extra careful when operating on unfamiliar terrain.

Always be alert to changing terrain conditions when operating the vehicle.

WARNING



V00A0DQ

POTENTIAL HAZARD

Failure to use extra care when operating on excessively rough, slippery or loose terrain.

WHAT CAN HAPPEN

Could cause loss of traction or vehicle control, which could result in an accident, including an overturn.

HOW TO AVOID THE HAZARD

Do not operate on excessively rough, slippery or loose terrain until you have learned and practiced the skills necessary to control this vehicle on such terrain.

Always be especially cautious on these kinds of terrain.

 **WARNING**



V00A0EQ

POTENTIAL HAZARD

Turning improperly.

WHAT CAN HAPPEN

Vehicle could go out of control, causing a collision or overturn.

HOW TO AVOID THE HAZARD

Always follow proper procedures for turning as described further in this Operator's Guide. Practice turning at low speeds before attempting to turn at faster speeds.

Do not turn at excessive speed.

⚠ WARNING



V00A00Q

POTENTIAL HAZARD

Operating on excessively steep hills.

WHAT CAN HAPPEN

The vehicle can overturn more easily on extremely steep hills than on level surfaces or small hills.

HOW TO AVOID THE HAZARD

Never operate this vehicle on hills too steep for the vehicle or for your abilities.

Practice on smaller hills before attempting larger hills.

 **WARNING**



V00A0FQ

POTENTIAL HAZARD

Climbing hills improperly.

WHAT CAN HAPPEN

Could cause loss of control or cause vehicle to overturn.

HOW TO AVOID THE HAZARD

Always follow proper procedures for climbing hills as described further in this Operator's Guide.

Always check the terrain carefully before you start up any hill.

Never climb hills with excessively slippery or loose surfaces.

Shift your weight forward.

Never open the throttle suddenly or make sudden gear changes. The vehicle could flip over backwards.

Never go over the top of any hill at high speed. An obstacle, a sharp drop, or another vehicle or person could be on the other side of the hill.

WARNING



V00A0GQ

POTENTIAL HAZARD

Going down a hill improperly.

WHAT CAN HAPPEN

Could cause loss of control or cause vehicle to overturn.

HOW TO AVOID THE HAZARD

Always follow proper procedures for going down hills as described further in this Operator's Guide. **NOTE:** A special technique is required when braking as you go down a hill.

Always check the terrain carefully before you start down any hill.

Shift your weight backward.

Never go down a hill at high speed.

Avoid going down a hill at an angle which would cause the vehicle to lean sharply to one side. Go straight down the hill where possible.

⚠ WARNING



V00A0HQ

POTENTIAL HAZARD

Improperly crossing hills or turning on hills.

WHAT CAN HAPPEN

Could cause loss of control or cause vehicle to overturn.

HOW TO AVOID THE HAZARD

Never attempt to turn the vehicle around on any hill until you have mastered the turning technique as described further in this Operator's Guide on level ground. Be very careful when turning on any hill.

Avoid crossing the side of a steep hill if possible.

When crossing the side of a hill:

Always follow proper procedures as described further in this Operator's Guide.

Avoid hills with excessively slippery or loose surfaces.

Shift your weight to the uphill side of the vehicle.

WARNING

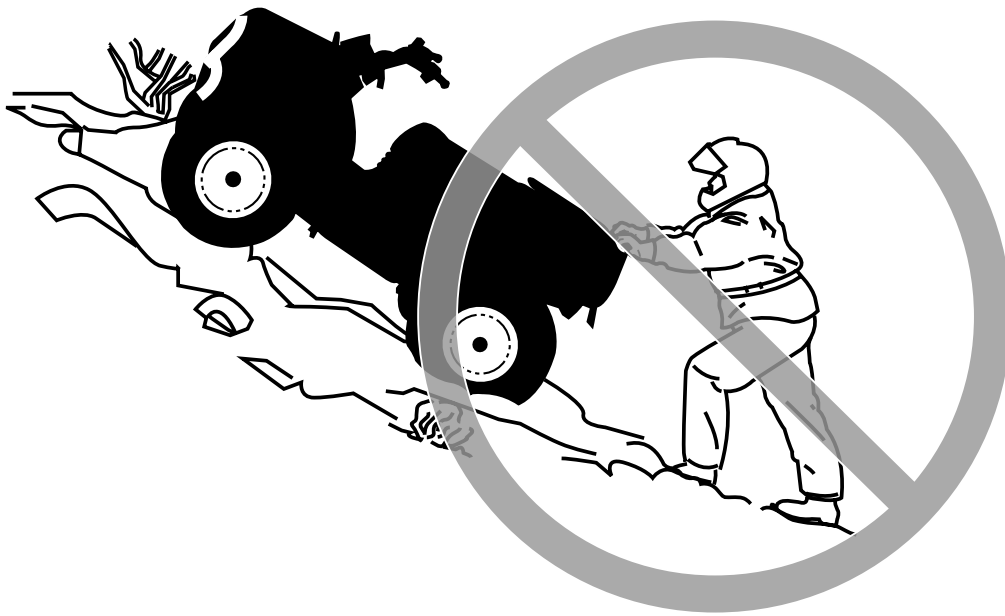

V00A01Q

POTENTIAL HAZARD

Stalling, rolling backwards or improperly dismounting while climbing a hill.

WHAT CAN HAPPEN

Could result in vehicle overturning.

HOW TO AVOID THE HAZARD

Use proper gear and maintain steady speed when climbing a hill.

If you lose all forward speed:

Keep your weight uphill. Never open the throttle suddenly or make sudden gear changes. The vehicle could flip over backwards.

Apply the brakes.

Lock parking brake after you are stopped.

Dismount on uphill side, or to a side if pointed straight uphill.

If you begin rolling backwards:

Keep your weight uphill. Never open the throttle suddenly or make sudden gear changes. The vehicle could flip over backwards.

Never apply the rear brake while rolling backwards.

Apply the front brake gradually.

When fully stopped, apply rear brake as well and lock parking brake.

Dismount on uphill side, or to a side if pointed straight uphill.

Turn the vehicle around and remount, following the procedure described further in this Operator's Guide.

 **WARNING**



V00A0JQ

POTENTIAL HAZARD

Improperly operating over obstacles.

WHAT CAN HAPPEN

Could cause loss of control or a collision.

Could cause the vehicle to overturn.

HOW TO AVOID THE HAZARD

Before operating in a new area, check for obstacles.

Never attempt to ride over large obstacles, such as large rocks or fallen trees.

When you go over obstacles, always follow proper procedures as described further in this Operator's Guide.

WARNING



V00A0KQ

POTENTIAL HAZARD

Skidding or sliding improperly.

WHAT CAN HAPPEN

You may lose control of this vehicle.

You may also regain traction unexpectedly, which may cause the vehicle to overturn.

HOW TO AVOID THE HAZARD

Learn to safely control skidding or sliding by practicing at low speeds and on level smooth terrain.

On extremely slippery surfaces, such as ice, go slowly and be very cautious in order to reduce the chance of skidding or sliding out of control.

WARNING

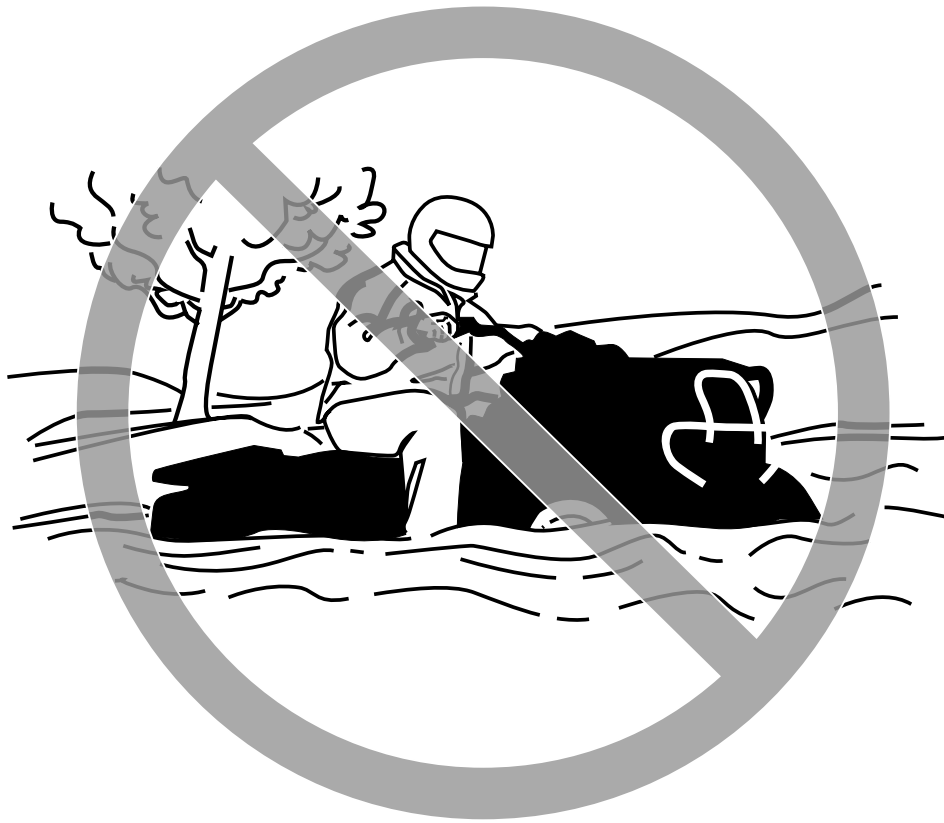

V00A0LQ

POTENTIAL HAZARD

Operating this vehicle through deep or fast flowing water.

WHAT CAN HAPPEN

Tires may float, causing loss of traction and loss of control, which could lead to an accident.

HOW TO AVOID THE HAZARD

Never operate this vehicle in fast flowing water or in water deeper than that specified further in this Operator's Guide.

Check water depth and current before you attempt to cross any water. Water should not go above footrests.

Remember that wet brakes may have reduced stopping ability. Test your brakes after leaving water. If necessary, apply them several times to let friction dry out the pads.

⚠ WARNING



V00A00Q

POTENTIAL HAZARD

Operating this vehicle with improper tires, or with improper or uneven tire pressure.

WHAT CAN HAPPEN

Use of improper tires on this vehicle, or operation of this vehicle with improper or uneven tire pressure, may cause loss of control, and increases the risk of an accident.

HOW TO AVOID THE HAZARD

Always use the size and type of tires specified further in this Operator's Guide for this vehicle.

Always maintain proper tire pressure as described further in this Operator's Guide.

 **WARNING**



V00A0NQ

POTENTIAL HAZARD

Operating this vehicle with improper modifications.

WHAT CAN HAPPEN

Improper installation of accessories or modification of this vehicle may cause changes in handling which in some situations could lead to an accident.

HOW TO AVOID THE HAZARD

Never modify this vehicle through improper installation or use of accessories. All parts and accessories added to this vehicle should be approved by BRP and should be installed and used according to instructions. If you have questions, consult an authorized Bombardier ATV dealer.

Do not install passenger seat or use the racks to carry a passenger.

⚠ WARNING



V00A0PQ

POTENTIAL HAZARD

Overloading this vehicle or carrying or towing cargo improperly.

WHAT CAN HAPPEN

Could cause changes in vehicle handling which could lead to an accident.

HOW TO AVOID THE HAZARD

Never load cargo on this vehicle.

Never tow cargo or another vehicle with this vehicle.

 **WARNING**



V03M01Q

POTENTIAL HAZARD

Transporting inflammable or dangerous material can lead to explosions.

WHAT CAN HAPPEN

This can cause serious injury or death.

HOW TO AVOID THE HAZARD

Never transport inflammable or dangerous material.

While reading this Operator's Guide, remember that:

 **WARNING**

Indicates a potential hazard that, if not avoided, could result in serious injury or death.

SAFETY WARNING

To fully appreciate the pleasures and excitement of riding this vehicle, there are some basic rules and tips that you should follow. Some may be new to you while others may be common sense or obvious. Irrespective, we ask that you take a few minutes to read, with your child, this Operator's Guide completely before he operates this vehicle.

Information in this Operator's Guide is limited. It is strongly recommended that you obtain further information and training from your local authorities, ATV clubs or a recognized ATV training organization such as Specialty Vehicle Institute of America (SVIA) or the Canada Safety Council (CSC).

The U.S. Consumer Product Safety Commission and all ATV manufacturers do not recommended anyone under the age of 16 to ride an ATV having an engine higher than 90 cc and anyone under age of 12 to ride an ATV having an engine higher than 70 cc. For the child's safety, we strongly recommend you also follow and enforce this recommendation. You are the sole judge of a rider's capability to understand the risks and operate a vehicle safely.

Persons with cognitive or physical impairments or who are high risk takers have an increased exposure to overturns or collisions which may result in injury including death.

Become completely familiar with the operational controls and the general operation of the vehicle before venturing into off road conditions. Practice driving in a suitable area free of hazards and feel the response of each control. Drive at low speeds. Higher speeds require greater experience, knowledge and suitable riding conditions.

Not all vehicles are the same. Each has its own unique performance characteristics, controls and features. Each will ride and handle differently.

Never assume that the vehicle will go everywhere safely. Sudden changes in terrain caused by holes, depressions, banks, softer or harder "ground" or other irregularities may cause the vehicle to topple or become unstable. To avoid this, slow down and always observe the terrain ahead. If the vehicle does begin to topple or tipover, it is usually the best advice to immediately get off... AWAY from the direction of the tipover!

Pre-operation Check

WARNING

The pre-operation check is very important prior to operating the vehicle. Always check the proper operation of critical controls, safety features and mechanical components before starting. If not done, severe injury or death might occur.

Before using this vehicle, the operator and/or an adult should always:

- a) Apply parking brake and check if it operates properly.
- b) Check tire pressure and condition.
- c) Check wheels and bearings for wear and damage.
- d) Check location of controls and ensure they work properly.
- e) Verify if steering operates freely.
- f) Activate throttle control lever several times to ensure it operates freely. It must return to idle position when released.
- g) Activate the brake levers to make sure the brakes fully apply. Levers must fully return when released.
- h) Check drive chain for adjustment and lubrication.
- i) Check sprockets for wear and damages.
- j) Check fuel and oil levels.
- k) Check for oil leaks on the engine, transmission and the drive train components.
- l) Ensure fuel valve is in fully open position (ON).
- m) Ensure seat is properly latched.
- n) Look and feel for loose parts while engine is off. Check fasteners.
- o) Ensure the path of travel is free of persons and obstacles.
- p) Check operation of ignition switch, start button, engine stop switch and indicator light.
- q) Start engine, remove parking brake and drive forward slowly a few feet then apply all brakes individually to test them.

Correct any problem you may have found before riding. See an authorized Bombardier ATV dealer as necessary.

Clothing

Actual weather conditions should help you decide how to dress. However, it is important that the operator always wear the appropriate protective clothing and apparel, including an approved helmet, eye protection, boots, gloves, long sleeved shirt and pants. This type of clothing will provide you protection from some of the minor hazards you may encounter en route. Operator must never wear loose clothing such as a scarf that may get entangled in the vehicle or on tree branches and shrubs. Depending on conditions, antifogging goggles or sun glasses may be required. Sun glasses should only be worn during the daytime. Different colored lenses available for goggles or glasses help you distinguish terrain variations.

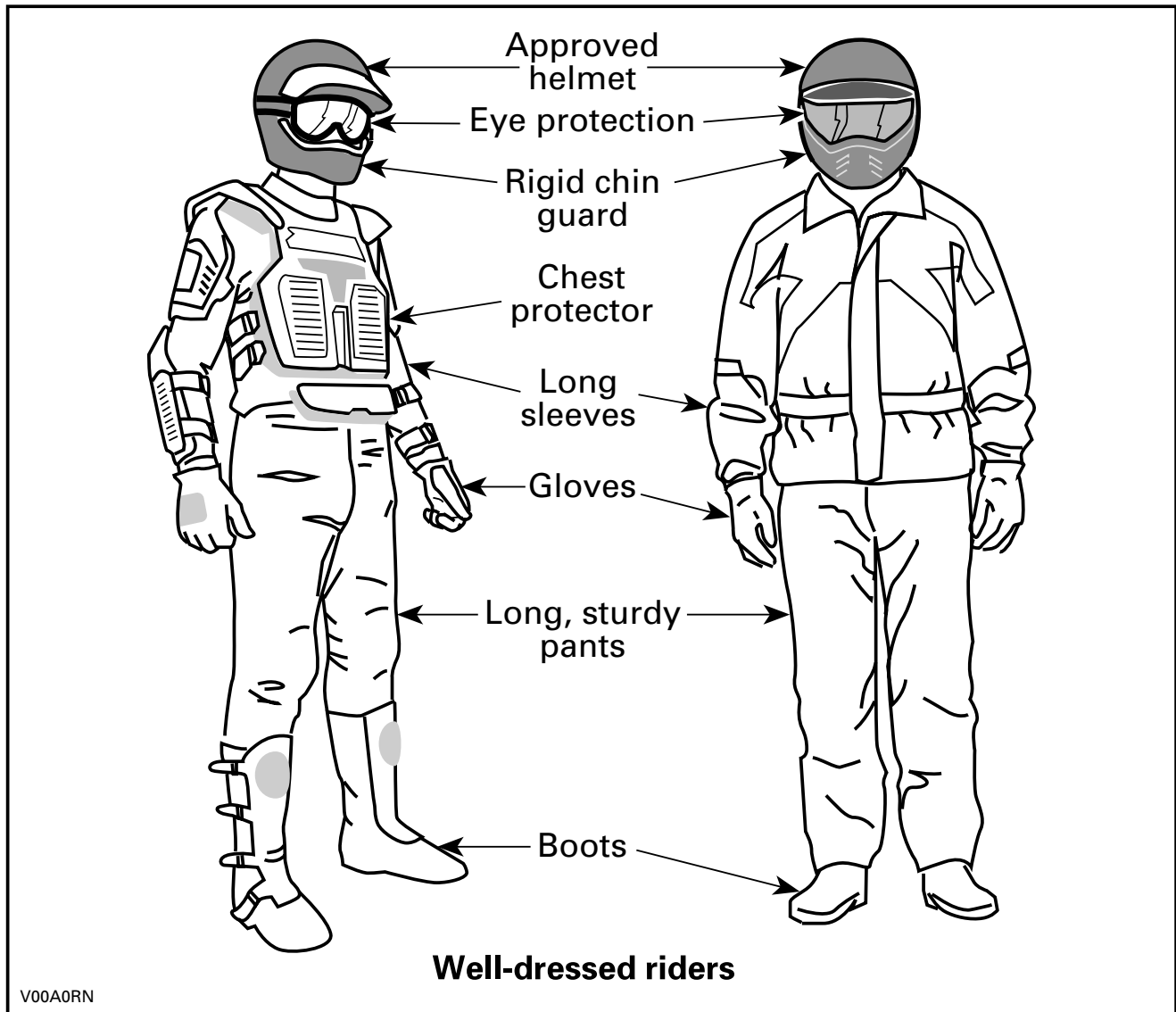

Carrying Loads

This vehicle is designed specifically to carry an operator only. Even with a long seat that provide unrestricted operator movements, it is not designed nor intended to carry passenger(s). Do not install passenger's seat or use the racks or their location to carry passenger(s). Carrying passenger(s) may affect the stability and your control of the vehicle.

Never load cargo on this vehicle.

Recreational Riding

Respect the rights and limitations of others. Stay away from areas designated for other types of off road use. This includes snowmobile trails, equestrian trails, cross country ski trails, mountain bike trails etc. Never assume there are no other users on the trail. Always stay to the complete right of the trail and do not zig zag to one side of the trail then the other. Be prepared to stop or pull off to the side if another trail user appears in front of you.

Always keep a safe distance from other riders. Your judgment of speed, terrain conditions, weather, mechanical condition of your vehicle and the "trust in judgment" you have in others around you will help you make a better choice of appropriate safe distance. This vehicle, like any other motorized vehicle, cannot stop "on a dime".

Before you ride, tell someone where you are planning to travel and your expected time of return. Never consume alcohol or drugs before or while riding!

Depending on the length of your ride, carry additional tools or emergency equipment. Find out where you can get additional gasoline and oil. Be prepared for the possible conditions you may encounter. An emergency first aid kit should always be a consideration.

Environment

One of the benefits of this vehicle is that it can take you off the beaten path away from most communities. However, you should always respect nature and the rights of others to enjoy it. Do not ride in environmentally sensitive areas. Do not drive over forest crops or shrubs... nor cut down trees or take down fencing... nor spin your wheels and destroy the terrain. "Tread Lightly".

Chasing wildlife is in many areas illegal. Wildlife can die of exhaustion after being chased by a motorized vehicle. If you encounter animals on the trail, stop and observe quietly and with caution. It will be one of the better memories of your life.

Observe the rule... "what you take in, carry out". Do not litter. Do not start campfires unless you have permission to do so... and then only ... away from dry areas. The hazards you may create on the trail may cause injury to others or yourself, even at a later date.

Respect farm lands. Always obtain the permission of the landowner before riding on private land. Respect crops, farm animals and property lines. If you come to a closed a gate, close it again after yourself.

Finally, do not pollute streams, lakes or rivers and do not modify the engine or muffling system, or remove any of its components.

Design Limitation

Although the vehicle is exceptionally rugged for its class, it is still a light vehicle by definition and its operation must be restricted to its proper purpose.

The addition of weight to any part of the vehicle changes its gravitational stability and modifies its performance.

Off-Highway Operation

The very nature of off-highway operation is dangerous. Any terrain, which has not been specially prepared to carry vehicles, presents an inherent danger where angularity, terrain substance and exact steepness are unpredictable. The terrain itself presents a continual element of danger, which must be knowingly accepted by anyone venturing over it.

An operator who takes a vehicle off-road should always exercise the utmost care in selecting the safest path and keeping close watch on the terrain ahead of him. On no account should the vehicle be operated by anyone who is not completely familiar with the driving instructions applicable to the vehicle, nor should it be operated on steep or treacherous terrain.

General Operating and Safety Precautions

Care, caution, experience and driving skill are the best precautions against the hazards of vehicle operation.

Whenever there is the slightest doubt that the vehicle can safely negotiate an obstacle or a particular piece of terrain, always choose an alternate route.

In off-road operation, power and traction, not speed, are important. Never drive faster than visibility and your own ability to select a safe route permit.

Constantly watch the terrain ahead for sudden changes in slopes or obstacles, such as rocks or stumps, that may cause loss of stability, resulting in tipover or rollover.

Never operate the vehicle if the controls do not function normally.

When stopped or parked, always apply the parking brake. This is especially important when parking on a slope. On very steep inclines or if the vehicle is carrying cargo, the wheels should be blocked using rocks or bricks. Remember to turn the fuel valve to the closed position.

Uphill Driving

Due to configuration, this vehicle has excellent climbing ability, so much so that tipover is possible before traction is lost. For example, it's common to encounter terrain situations where the top of the hill has eroded to a point that the hill peak rises very sharply. The vehicle can readily negotiate such a condition, however, in doing so, when the front of the vehicle is driven to a point that the vehicle's balance changes rearward tipover can occur.

The same situation may apply if an embedded object causes the front of the vehicle to climb more than desired. If such a situation occurs take an alternate route. Be aware of side hilling dangers when doing so.

It is also wise to know the terrain condition on the other side of the hill or bank. All too often there exists a sharp drop-off that is impossible to negotiate or descend.

Downhill Driving

This vehicle can climb slopes that are steeper than it can safely descend. Therefore, it is essential to assure that a safe route exists to descend a slope before you climb it.

Decelerating while negotiating a slippery downhill slope could “toboggan” the vehicle. Maintain steady speed and/or accelerate slightly to regain control.

Side Hilling

Whenever possible, such operation should be avoided. If necessary, do so with extreme caution. Side hilling on steep inclines could result in rollover. In addition, slippery or unfirm surfaces could result in uncontrollable side sliding. Do not attempt to turn the vehicle downhill with the slide. Avoid all objects or depressions that will intensify the raising of one side of the vehicle higher than the other, thus causing rollover.

Drop-Offs

This vehicle will “bottom-out” and usually stop if either the front or rear wheels are driven over a drop-off. If the drop is sharp or deep, the vehicle will nose dive and tipover.

WARNING

Avoid negotiating drop-offs. Reverse and select an alternate route.

Riding Techniques

Riding your vehicle too fast for the conditions may result in injury. Apply only enough throttle to proceed safely. Statistics show that high speed turns usually result in mishaps and injury. Always remember that this vehicle is heavy! Its pure weight alone may entrap you should it fall and pin you down.

This vehicle is not designed for jumping nor can it, or you, absorb the energy of high impacts such as jumping. Performing “wheelies” can cause the vehicle to flip over onto you. Both practices have a high risk for you and should be avoided at all times.

To maintain proper control it is strongly advised that you keep your hands on the handlebar and within easy reach of all controls. The same holds true for your feet. To minimize the possibility of any leg or foot injury, keep your feet on the footrests at all times. Do not direct your toes outwards nor place your foot out to assist turning as they can be hit or snagged by passing obstacles or may contact the wheels.

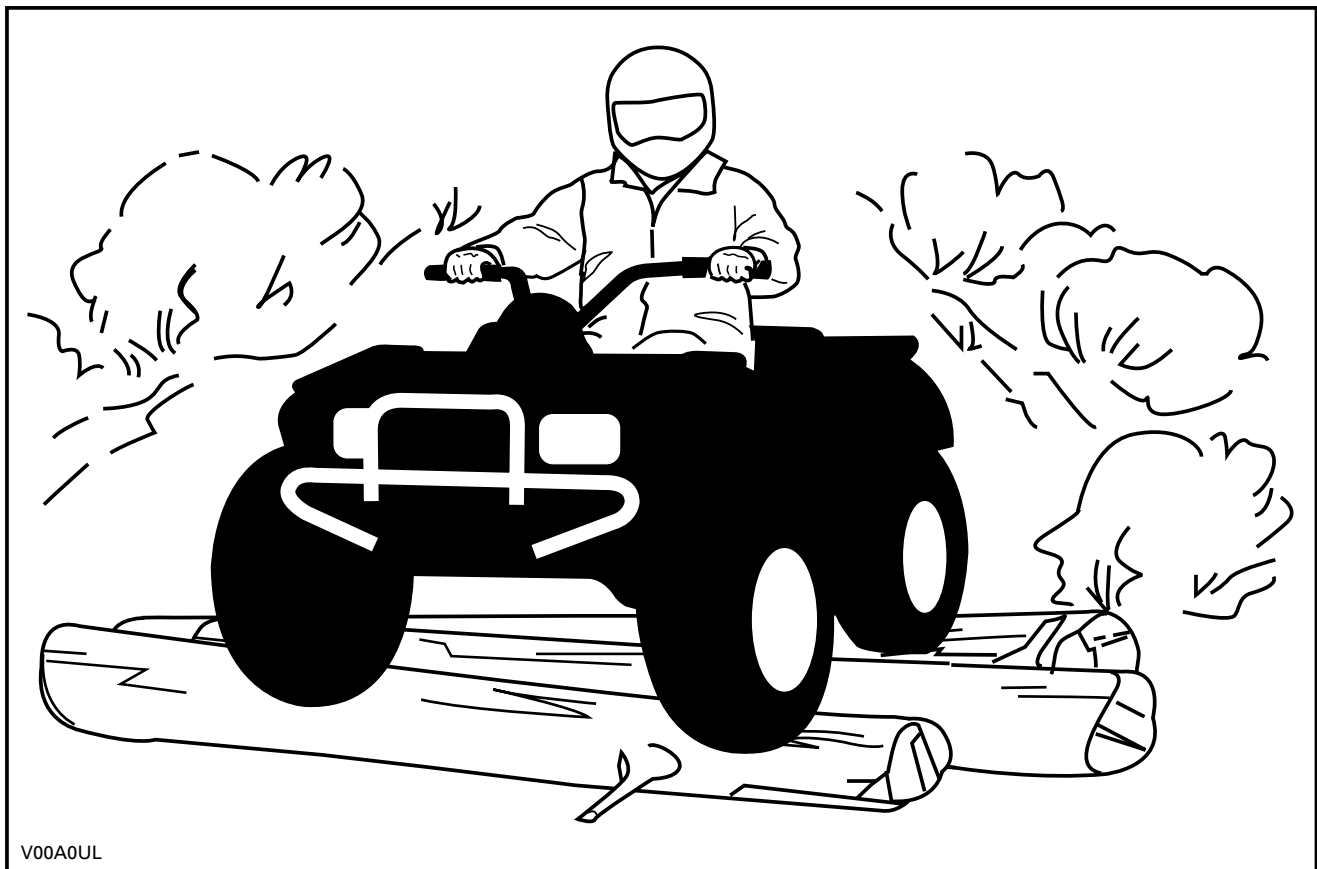

Even though there is an adequate suspensions system on this vehicle there are "washboard" or rough terrain conditions that will make you feel uncomfortable and even cause back injury. "Posting" or riding in a crouched position will often be required. Slow down and allow your flexed legs to absorb impact.

This vehicle is not designed for riding on roads or highways. In most places it is an illegal practice. Riding your vehicle on roads or highways could cause a collision to occur with another vehicle. ATV tires are not suited for paved road use. Pavement may seriously affect the handling and control of the vehicle. Riding on roads or soft shoulders may confuse other road users, especially if your lights are on. If you have to cross a road, the lead driver should get off his vehicle then observe and give directions to the other riders. The last person after crossing then assists the lead driver to cross. Do not travel sidewalks. They are designated for pedestrian use.

Water can be a unique hazard. If it is too deep the vehicle may "float" and topple. Check the water depth and current before you attempt to cross any water. Water should not go above the footrest. Be wary of slippery surfaces such as rocks, grass, logs, etc., both in the water and on its banks. A loss of traction may occur. Do not attempt to enter the water at high speed. The water will act as a brake and could throw you.

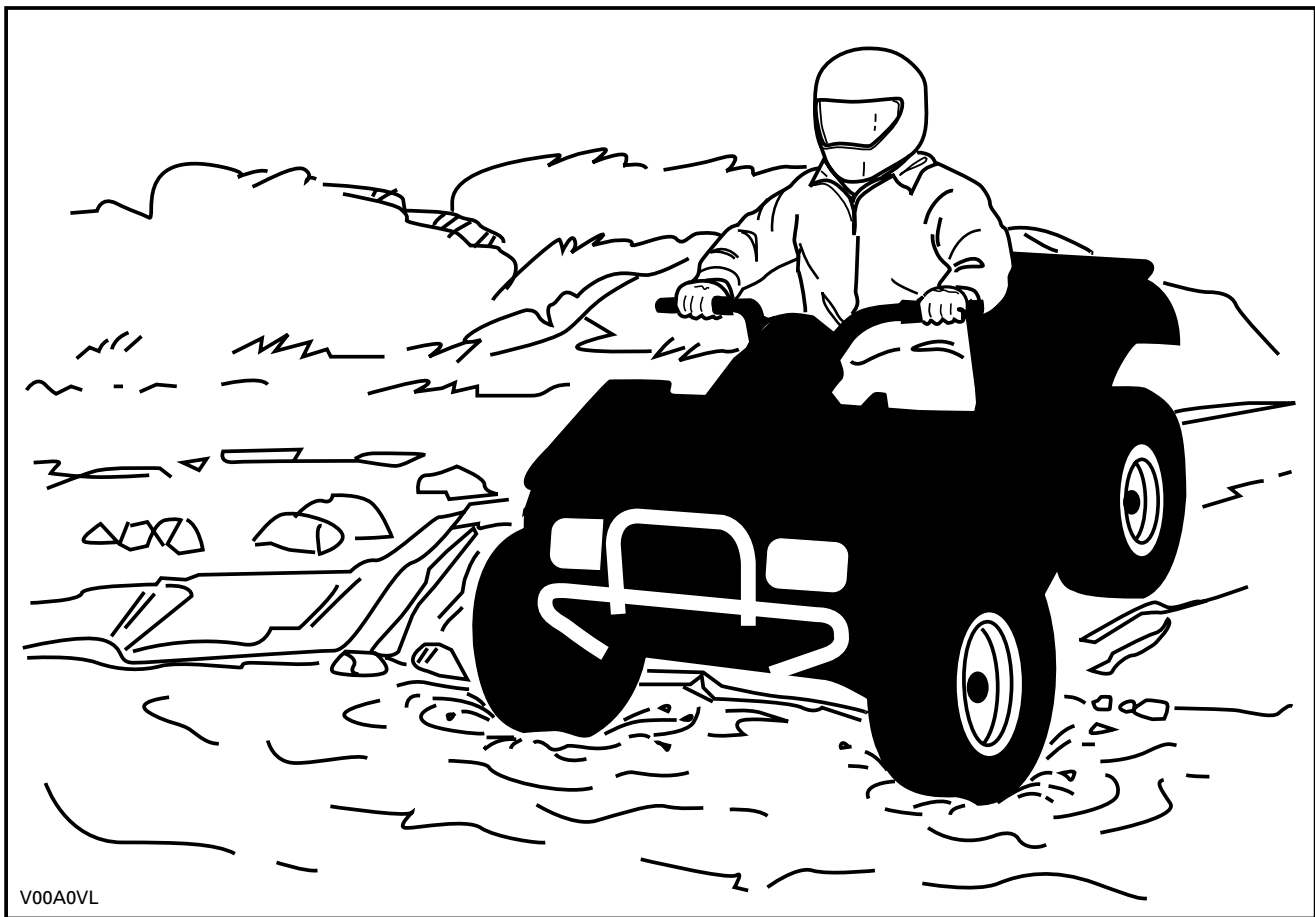

Water will affect the braking ability of your vehicle. Make sure you dry the brakes by applying them several times after the vehicle leaves the water.

Mud or marsh lands may be encountered near water. Be prepared for sudden "holes" or changes in depth. Similarly so, be watchful of hazards such as rocks, logs, etc., partially covered by vegetation.

If your trip crosses frozen waterways, make sure that the ice is thick enough and sound enough to support the total weight of yourself, the vehicle and its load. Be ever watchful of open water... it is a sure indication that the ice thickness will vary. If in doubt, do not attempt to cross.

Ice will also affect the control of vehicle. Slow down and do not "gun" the throttle. This will only result in spinning of the tires and possible tipover of the vehicle. Avoid rapid braking. This again will possibly result in an uncontrolled slide and tipover of the vehicle. Slush should be avoided at all times since it could block the operation or controls of the vehicle

Sand and riding on sand dunes or on snow is another unique experience but there are some basic precautions that should be observed. Wet, deep or fine sand/snow may create a loss of traction and cause the vehicle to slide, drop off or become "bogged" down. If this occurs look for a firmer base. Again, the best advice is to slow down and be watchful of the conditions.

When riding in sand dunes it is advisable to equip the vehicle with an antenna type safety flag. This will help make your location more visible to others over the next sand dune. Proceed carefully should you see another safety flag ahead. Since the antenna type safety flag can snag and rebound on your body if caught, do not use it in areas where there are low hanging branches or obstacles.

Riding on loose stones or gravel is very similar to riding on ice. They will affect the steering of vehicle... possibly causing it to slide and tipover especially at high speeds. In addition, braking distance may be affected. Remember that "gunning" the throttle or sliding may cause loose stones to be ejected rearwards into the path of another rider's way. Never do it deliberately.

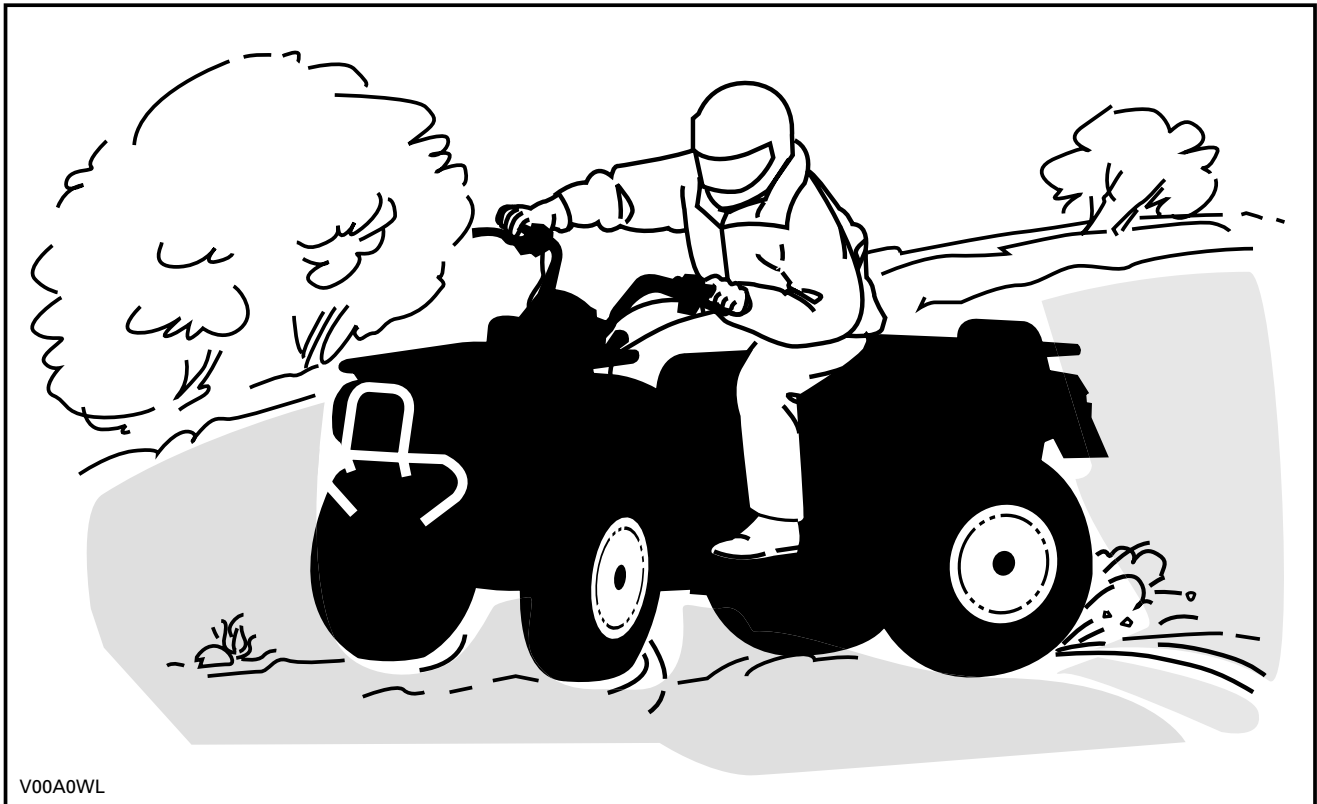

If you do get into a slide or skid, it may help to turn the handlebar into the direction of the skid until you regain control. Never jam the brakes and lock the wheels.

Respect and follow all posted trail signs. They are there to help you and others.

Obstacles in the "trail" should be traversed with caution. This includes loose rocks, fallen trees, slippery surfaces, fences, posts, and embankments and depressions. You should avoid them whenever possible. Remember that some obstacles are too large or dangerous to cross and should be avoided. Small rocks or fallen trees may be safely crossed... approach at a 90° angle. Stand on the footrests while keeping your knees flexed. Adjust speed without losing momentum and do not "gun" the throttle. Hold handgrips firmly. Place your body weight rearwards and proceed. Do not try to lift the vehicle front wheels off the ground. Be aware that the object may be slippery or may move while crossing.

When driving on hills or slopes two things are highly important... be prepared for slippery surfaces or terrain variations and obstacles and... use proper body positioning.

Uphill

Keep your body weight forward towards the top of the hill. Keep your feet on the footpegs and shift into low gear then accelerate and when necessary, change gear quickly as you climb. Do not over-speed since this may cause the front of the vehicle to lift from the ground and fall back on you. If the hill is too steep and you cannot proceed or the vehicle begins to roll backwards, apply the brake, being careful not to slide. Dismount then use the "U" turn or "K" turn (while walking back, next to the vehicle on the up hill side and with a hand on the brake lever, slowly back the rear of the vehicle toward the top of the hill then drive downhill). Always walk or dismount on the upside of the slope while keeping clear of the vehicle and its rotating wheels. Do not try to hold on to the vehicle if it begins to topple. Stay clear. Do not ride over the crest of the hill at high speed. Obstacles, including sharp drop-offs, may exist.

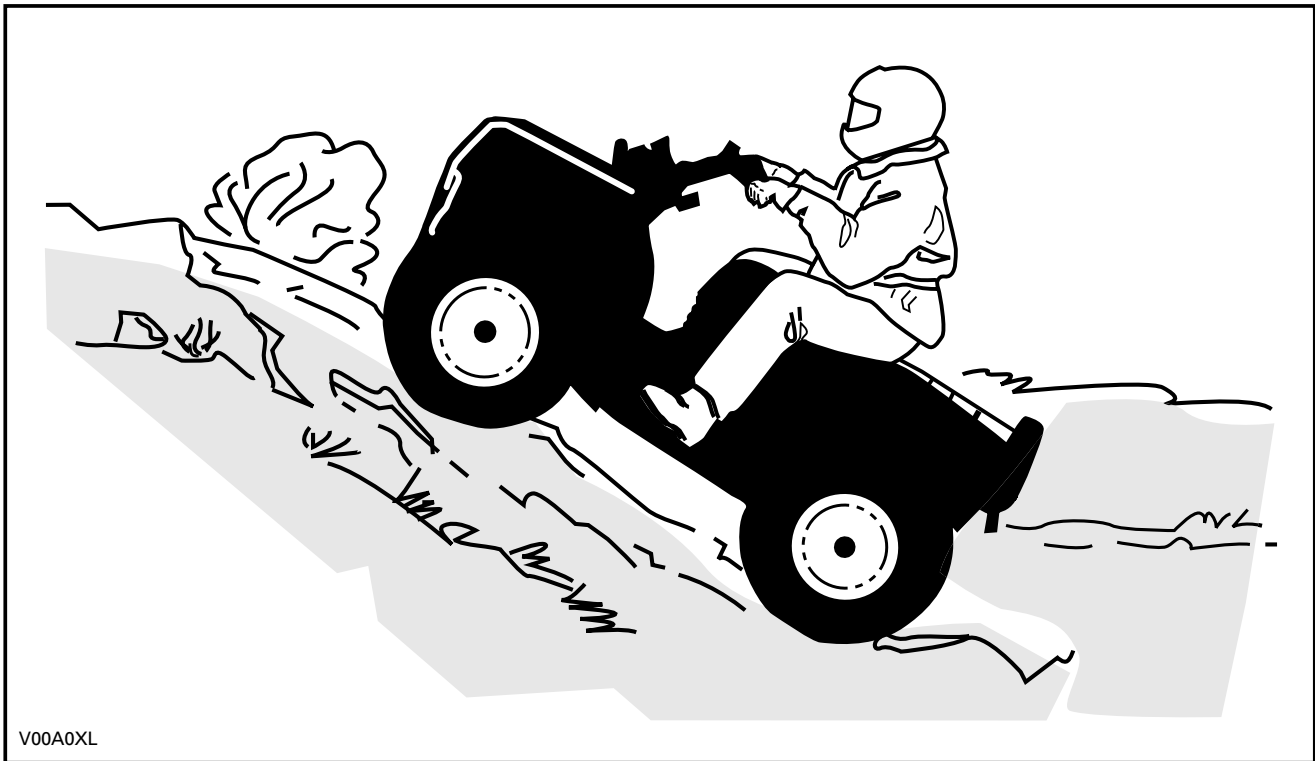

V00A0XL

Downhill

Keep your body weight rearwards. Apply the brake gradually to prevent skidding. Do not "coast" down the slope using solely engine compression or in neutral gear.

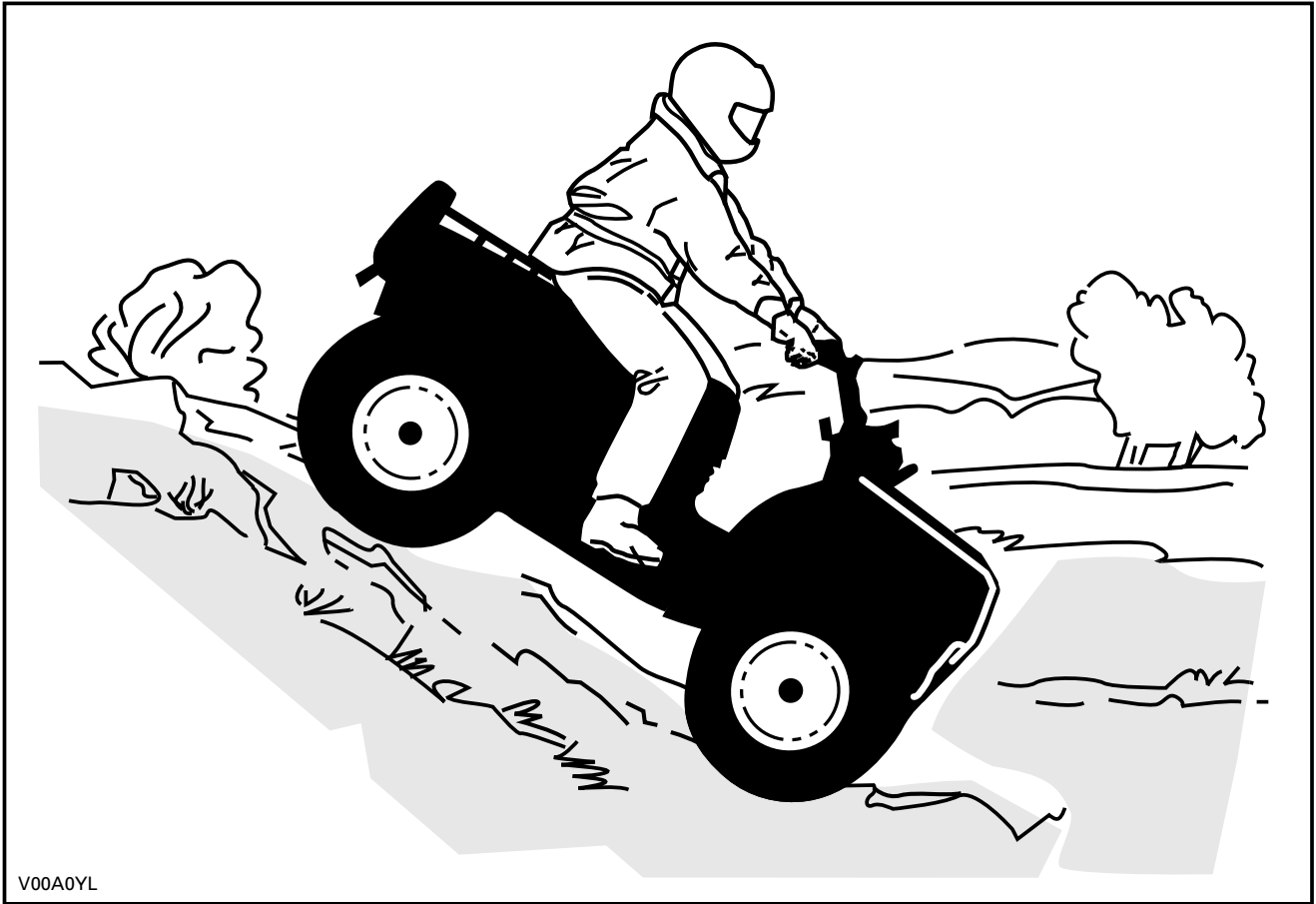

While reading this Operator's Guide, remember that:

WARNING

Indicates a potential hazard that, if not avoided, could result in serious injury or death.

Side hilling

This is one of the **most risky** types of riding since it may drastically change the balance of the vehicle. It should be avoided wherever possible. If it is necessary to do so however, it is important that you **ALWAYS** keep your body weight on the upside of the slope... and be prepared to dismount on that side should the vehicle begin to topple. **Do not try to stop or save the vehicle from damage.**



Routine Maintenance

Once your ride completed, it is wise to remove any build up of snow, ice, mud and grime. Not only will this help you keep your vehicle longer and in good condition for resale but will eliminate potential hazards the next time you use the vehicle. Wash your vehicle in warm soapy water then allow it to dry. (A towel may help). Do not wash your vehicle outside during freezing weather. Apply appropriate lubrication as described in the MAINTENANCE section.

Part of your responsibility towards safety is to respect the contents of this Operator's Guide. It provides valuable advice on how to properly take care of your vehicle. If further assistance is required your authorized Bombardier ATV dealer is always willing to help.

Modification of the vehicle to increase speed and performance may violate the terms and conditions of your vehicle limited warranty. In addition, certain modifications including the removal of engine or exhaust components are illegal under most laws.

Changing the wheel and/or tire size may affect the stability of the vehicle. Incorrect tire pressure may lead to blow outs or cause a tire to move around on its rim and become lost or damaged. Wheels or tires which are damaged should always be replaced.

LOCATION OF THE IMPORTANT LABELS

The following labels are on your vehicle and they should be considered permanent parts of the vehicle. If missing or damaged, they can be replaced free of charge. See an authorized Bombardier ATV dealer.

NOTE: The following illustrations used in this Operator's Guide are a general representation only. Your model may differ.



LABEL 1

⚠ WARNING

Improper ATV use can result in **SEVERE INJURY** or **DEATH**.



ALWAYS USE AN APPROVED HELMET AND PROTECTIVE GEAR.



NEVER USE ON PUBLIC ROADS.



NEVER CARRY PASSENGERS.



NEVER USE WITH DRUGS OR ALCOHOL.

NEVER operate:

- without proper training or instructions.
- at speeds too fast for your skills or the conditions.
- on public roads - a collision can occur with another vehicle.
- with a passenger - passengers affect balance and steering and increase risk of losing control.

ALWAYS:

- use proper riding techniques to avoid vehicle overturns on hills and rough terrain and in turns.
- avoid paved surfaces - pavement may seriously affect handling and control.

LOCATE AND READ OPERATOR'S GUIDE.
FOLLOW ALL INSTRUCTIONS & WARNINGS.

704 900 001

V01M01Z

LABEL 2

⚠ WARNING



NEVER ride as a passenger. Passengers can cause a loss of control, resulting in **SEVERE INJURY** or **DEATH**.

704 900 005

V01M07Z

LABEL 3

⚠ WARNING



Operating this ATV if you are under the age of 6 increases your chance of **SEVERE INJURY** or **DEATH**.

NEVER operate this ATV if you are under age 6.

704 900

V05M02Y

DS50

⚠ WARNING



Operating this ATV if you are under the age of 12 increases your chance of **SEVERE INJURY** or **DEATH**.

NEVER operate this ATV if you are under age 12.

704 900

V05M03Y

DS90 ET DS90 4 STROKE

LABEL 4

⚠ WARNING

Improper tire pressure or overloading can cause loss of control.

Loss of control can result in **SEVERE INJURY** or **DEATH**.

TIRE PRESSURE

- Set with tires cold: DS 50
 - Recommended: FRONT: 55.0 kPa, 8,0 psi.
REAR: 55.0 kPa, 8,0 psi.
 - Minimum FRONT: 41.0 kPa, 6,0 psi.
REAR: 41.0 kPa, 6,0 psi.
- Never set tire pressure below minimum. It could cause the tire to dislodge from the rim.
- Maximum Vehicle Load: 150 lbs. (70 kg). Includes weight of operator and accessories.

704 900 XXX

V05M04Y

VEHICLE INFORMATION

HOW TO IDENTIFY YOUR ATV

The main components of your vehicle (engine and frame) are identified by different serial numbers. It may sometimes become necessary to locate these numbers for warranty purposes or to trace your vehicle in the event of loss. These numbers are required by the authorized Bombardier ATV dealer to complete warranty claims properly. No warranty will be allowed by BRP if the engine identification number (EIN) or vehicle identification number (VIN) is removed or mutilated in any way. We strongly recommend that you take note of all the serial numbers on your vehicle and supply them to your insurance company.

Vehicle Identification Number Location

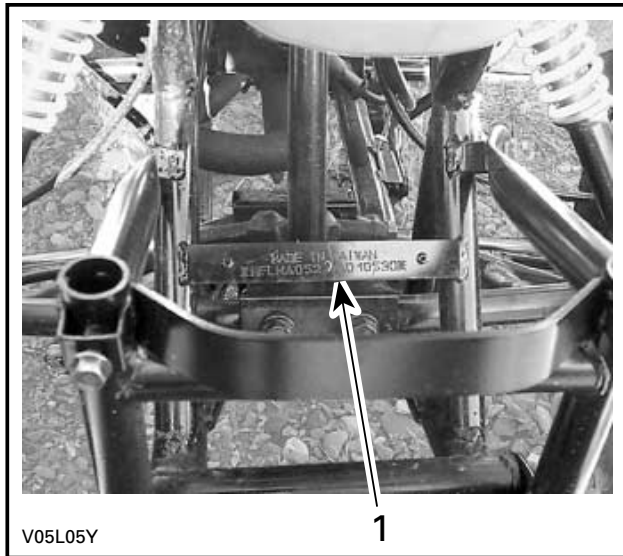

1. V.I.N.

Engine Identification Number Location

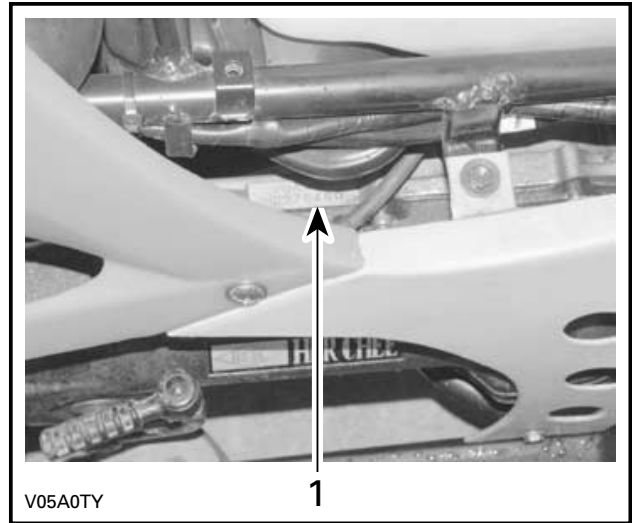

2-STROKE MODELS

1. E.I.N.

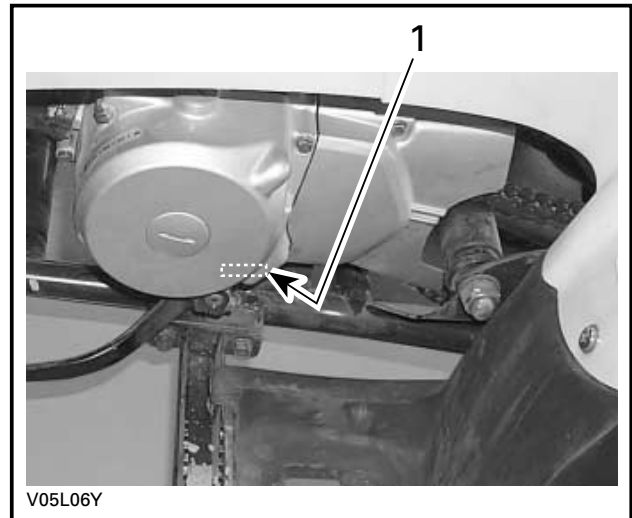

4-STROKE MODELS

1. E.I.N.

CONTROLS/INSTRUMENTS/EQUIPMENT

NOTE: Some controls/instruments/equipment are optional.

2-Stroke Models

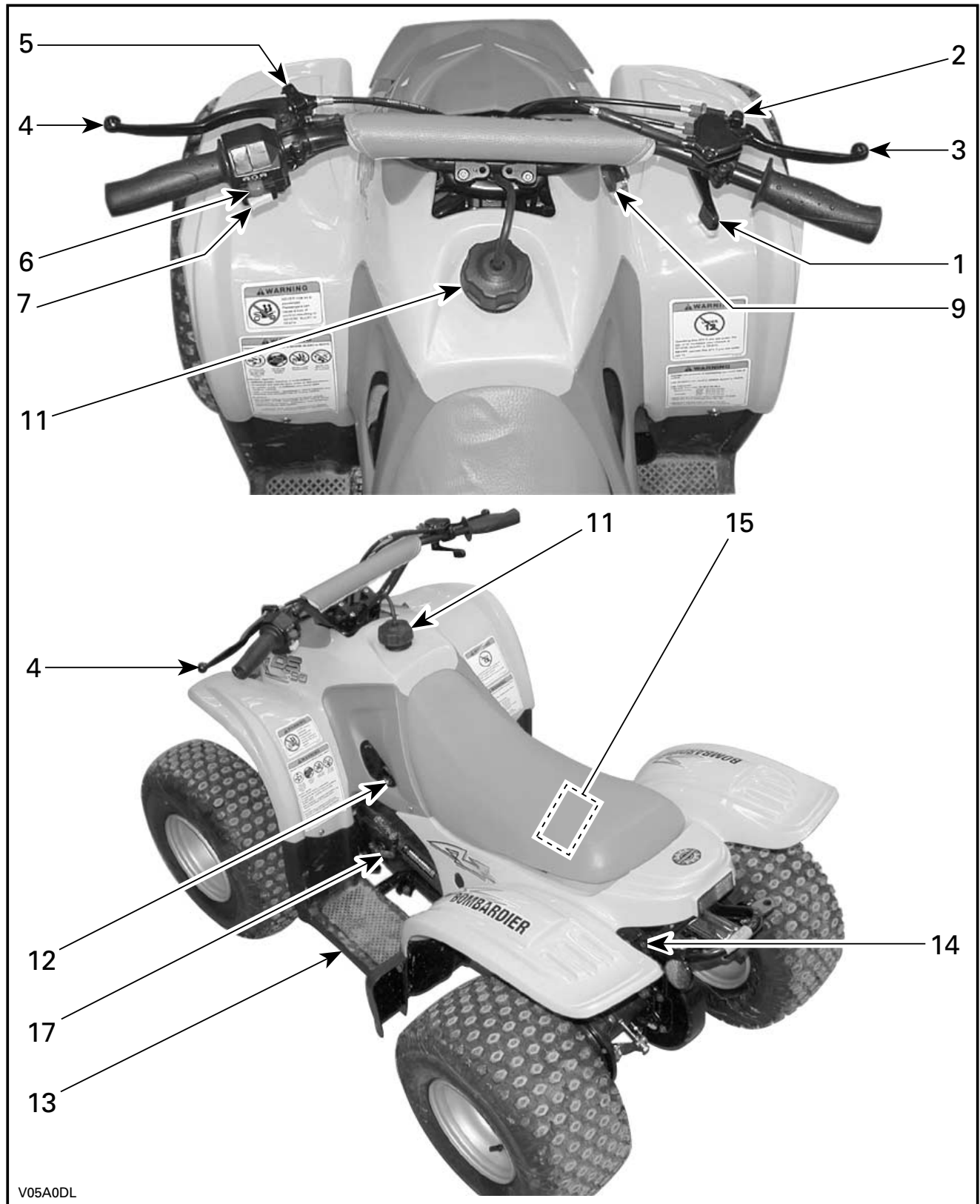

V05A0DL

4-Stroke Models

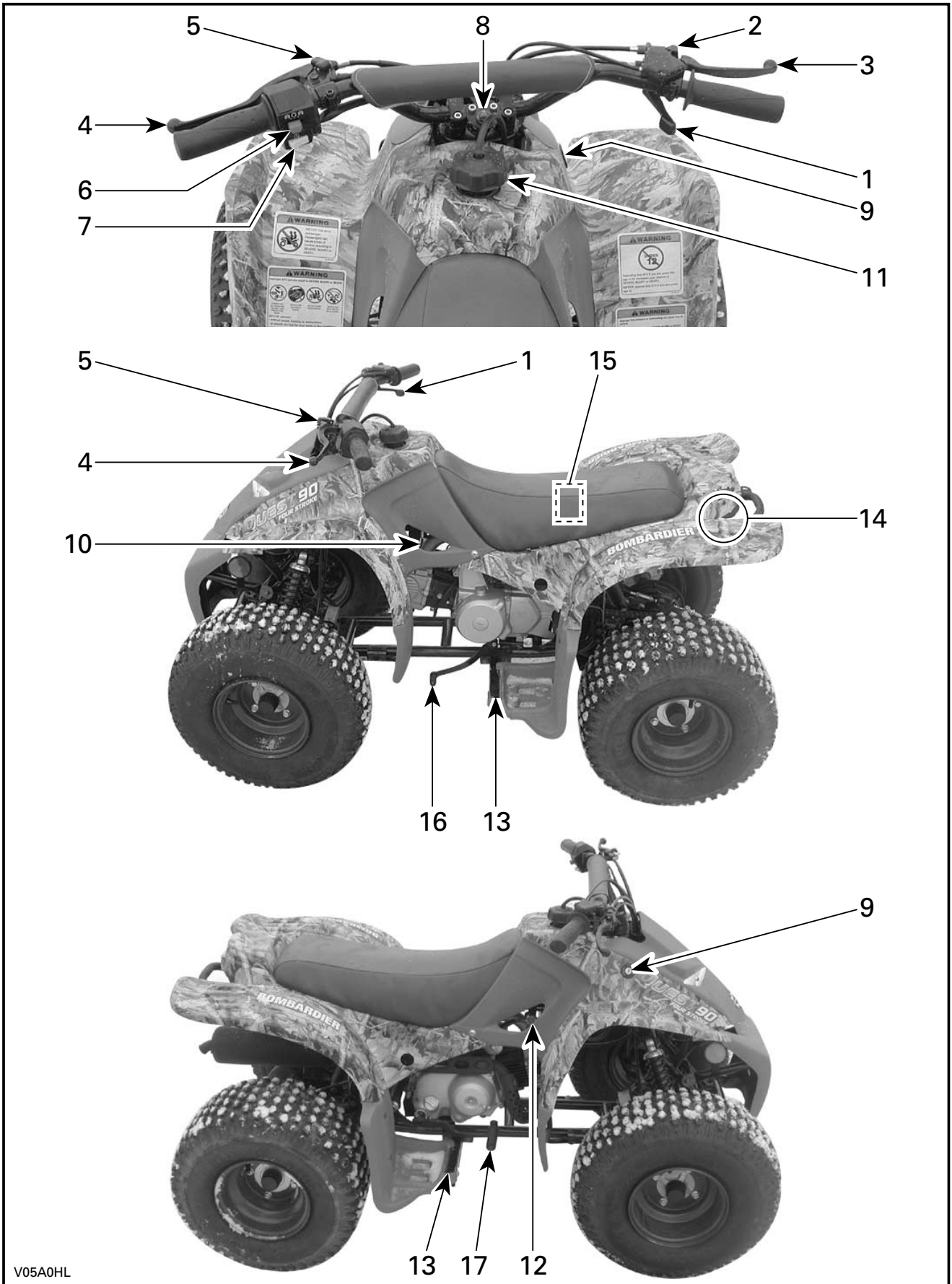

V05A0HL

While reading this Operator's Guide, remember that:

⚠ WARNING

Indicates a potential hazard that, if not avoided, could result in serious injury or death.

NOTE: This section gives basic functions of the various controls of your ATV. For more details of how to operate one control in conjunction with some others, refer to OPERATING INSTRUCTIONS further in this section.

1) Throttle Lever

Located on the right side of handlebar. When pushed, it increases the engine speed that allows the engagement of the transmission on the selected gear.

When released, the engine speed should return automatically to idle and the vehicle will gradually slow down.

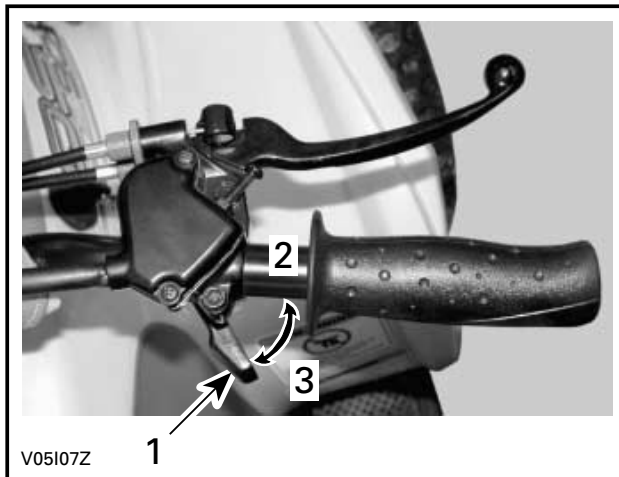

1. Throttle lever
2. To accelerate
3. To decelerate

2) Speed Limiter Screw

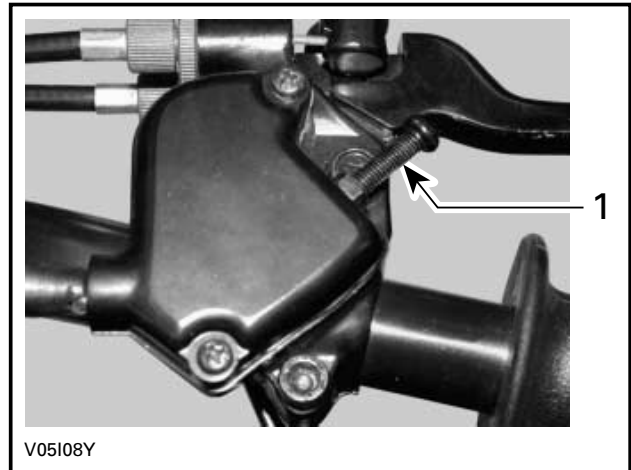

1. Speed limiter screw

Located on the right side of handlebar. With appropriate tools, it is possible to decrease engine speed by screwing in the speed limiter screw and to increase engine speed by unscrewing it.

DS50 Models

Units are shipped from the factory with a restricted speed setting of 16 km/h (10 MPH).

CAUTION: To keep track of original setting, adults must make sure to measure the screw length before making any changes.

Using appropriate tools, adults can unscrew the speed limiter screw to obtain a maximum unrestricted speed setting of 24 km/h (15 MPH).

DS90 2-Stroke and DS90 4-Stroke Models

Units are shipped from the factory with a restricted speed setting of 24 km/h (15 MPH).

Using appropriate tools, adults can unscrew the speed limiter screw to obtain a maximum unrestricted speed setting of 48 km/h (30 MPH).

⚠ WARNING

Adults should always limit the maximum restricted speed within the ability and capacity of the child to operate the vehicle safely. Never allow the child to adjust the speed limiter.

3) Front Brake Lever

Located on the right side of handlebar. When compressed, the brake is applied. When released, it should automatically return to its original position. Braking effect is proportional to the force applied on the lever and to the type and condition of the terrain. The front brake will have also an effect on rear wheels through the drive train.

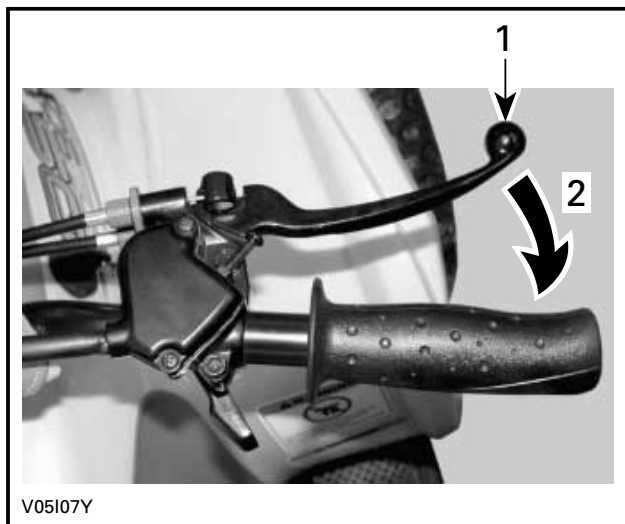

1. Brake lever
2. To apply brake

4) Rear Brake Lever

Located on the left side of handlebar. When compressed, the brake is applied. When released, it should automatically return to its original position. Braking effect is proportional to the force applied on the lever and to the type and condition of the terrain.

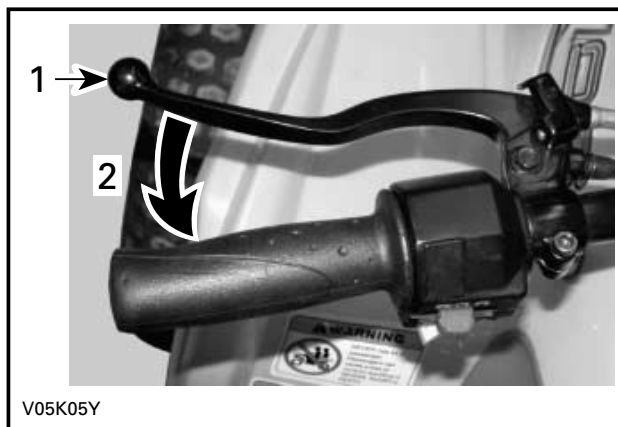

1. Brake lever
2. To apply brake

5) Brake Lever Lock

Located on left side of handlebar on the rear brake lever. When applied, it prevents the vehicle from moving. Useful when the brake needs to be locked for example such as doing a K-turn, during transportation or when the vehicle is not in operation.

⚠ WARNING

Always use the brake lever lock when the vehicle is not in operation.

⚠ WARNING

Make sure brake lever lock is fully disengaged before operating the ATV. When you ride the vehicle, brakes that are caused to drag by a continuous pressure on the lever may cause damage to the brake system and cause loss of braking capacity and/or fire.

To engage mechanism: Squeeze brake lever and maintain while moving lever lock. Brake lever is now compressed and applying rear brakes.

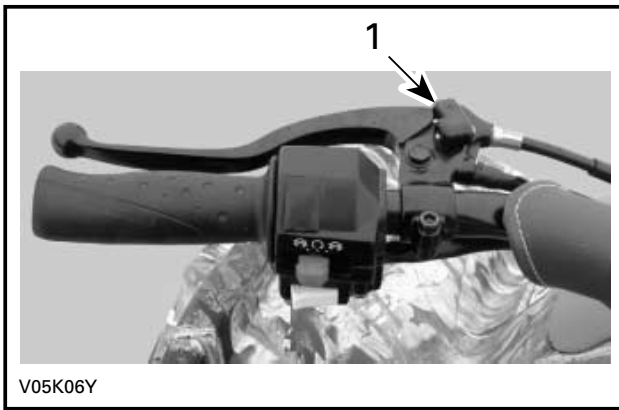

V05K06Y

1. Brake lever lock

To release mechanism: Squeeze brake lever. Lever lock should automatically return to its original position. Brake lever should return to rest position. Always release brake lever lock before riding.

6) Multi-Function Switch

The multi-function switch is located on the left side of the handlebar.

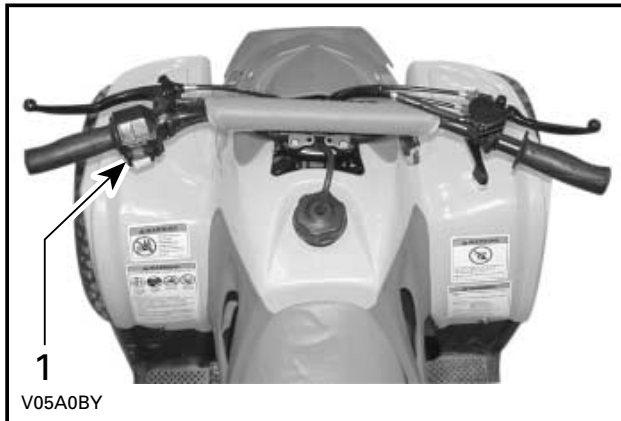

V05A08Y

1. Multi-function switch

The controls located on this multi-function switch are:

Engine Stop Switch

This switch is located in the middle of the multi-function switch.

The engine will turn over but will not start if the engine stop switch is placed in the OFF position.

This switch can be used to stop engine and as an emergency control.

NOTE: While engine can be stopped by turning ignition key OFF, we recommend the engine be stopped by the engine stop switch.

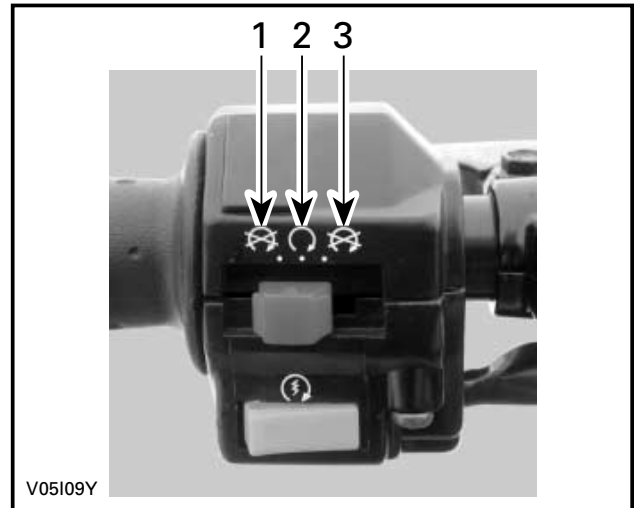

V05109Y

1. OFF
2. ON
3. OFF

Start Button

This button is located at the bottom of the multi-function switch.

To start engine, place the engine stop switch to RUN.

Press and hold the start button. Release immediately after engine is started.

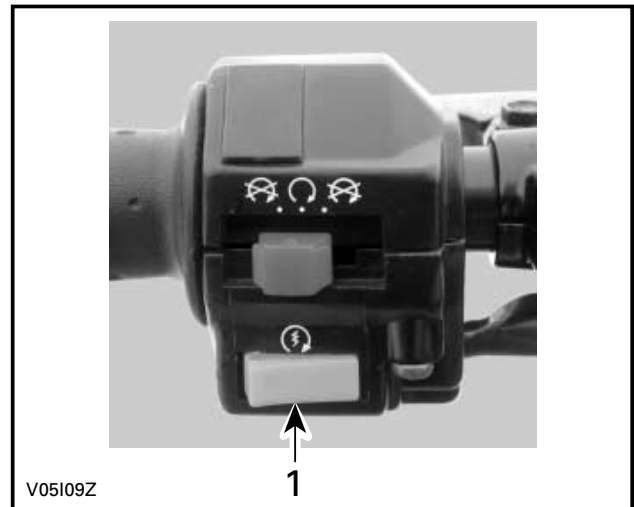

V05109Z

1. Start button

To stop engine, fully release throttle lever then use the engine stop switch.

7) Neutral Indicator Light

4-Stroke Models

Located at center of cluster.

When lit, it indicates the transmission is in neutral position.

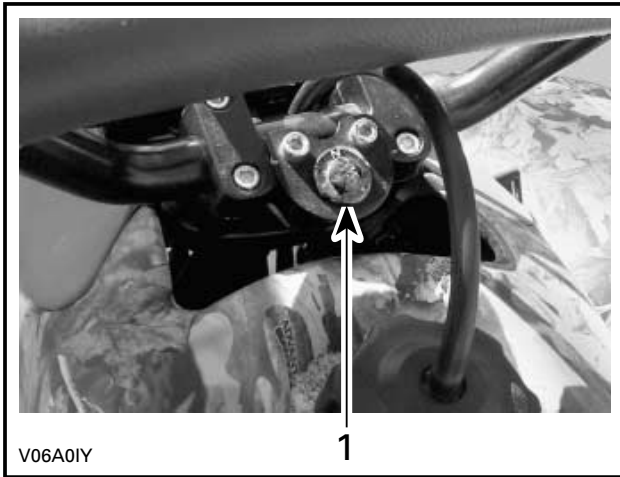

1. Neutral indicator light

8) Ignition Switch

Located on the right side of cluster.

Key-operated, 2-position switch: OFF and ON.



IGNITION SWITCH

Insert key in switch and turn to ON. To remove key, turn key to OFF then pull it out.

NOTE: While engine can be stopped by turning ignition key OFF, we recommend the engine be stopped by the engine stop switch. Always turn ignition switch to OFF after engine has been stopped.

9) Choke Knob Lever

4-Stroke Models

Located on the left side of vehicle. This device features a variable lever to ease cold start.

Position OFF is for normal use with a warm engine (pushed in).



CHOKE KNOB LEVER IN THE OFF POSITION

The full choke position is used for lower temperature (fully extended).



V06C0LY

CHOKE LEVER IN THE FULL CHOKE POSITION

The other positions between OFF and FULL position, will be use depending on the temperature.

10) Fuel Tank Cap

Unscrew counterclockwise and remove cap to allow fuel tank filling then fully tighten clockwise.

⚠ WARNING

Always stop engine before refueling. Open cap slowly. If a differential pressure condition is noticed (whistling sound heard when loosening fuel tank cap) have vehicle inspected and/or repaired before further operation. Fuel is flammable and explosive. Never use an open flame to check fuel level. Never smoke or allow flame or spark in vicinity. Always work in a well-ventilated area. Never top off the fuel tank before placing the vehicle in a warm area. As temperature increases, fuel expands and may overflow. Always wipe off any fuel spillage from the vehicle.

⚠ WARNING

Do not allow children to put fuel in the ATV.

11) Fuel Valve

4-Stroke Models

Located on right side panel under front part of seat. This is a 3-position rotary valve: OFF, ON, RES. Rotate the tab to align its pointer with ON, OFF or RES.

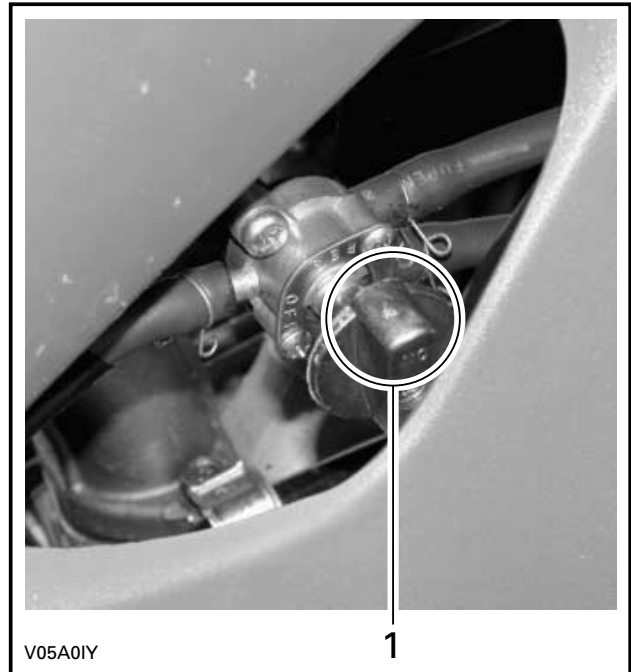

V05A0IY

1

1. Align this pointer with the desired position

2-Stroke Models

Located on left side panel under front part of seat. This is a 3-position rotary valve: OFF, ON, RES. Rotate the tab to align its pointer with ON, OFF or RES.

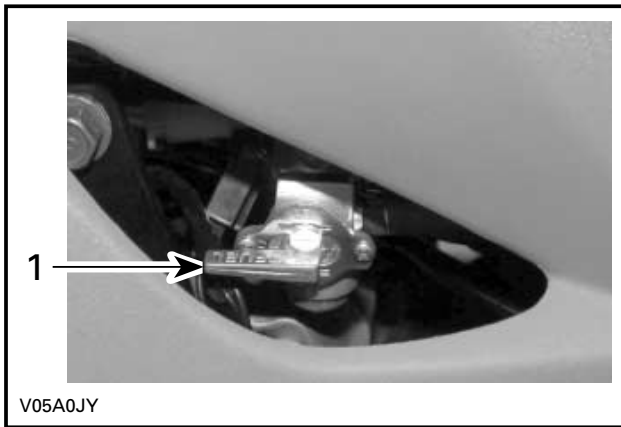

1. Align this pointer toward the desired position

All Models

OFF

Stops fuel supply to carburetor.

CAUTION: Turn valve to OFF position when ATV is not being operated or when transporting.

ON

Allows fuel to flow to carburetor. This is the normal position for operation of the vehicle.

RES (reserve)

When fuel is exhausted in the fuel tank when in the ON position, an emergency supply of fuel is available by turning the knob to RES. Use this position only when the ON supply is empty.

When down to the reserve, refuel as soon as possible. Be sure to turn the valve back to the ON position after refuelling.

CAUTION: Improper opening of fuel valve will restrict the flow of fuel. Make sure valve is fully opened while running.

12) Footpeg

Located on footrest. Use this area to keep your feet stable.

4-Stroke Models

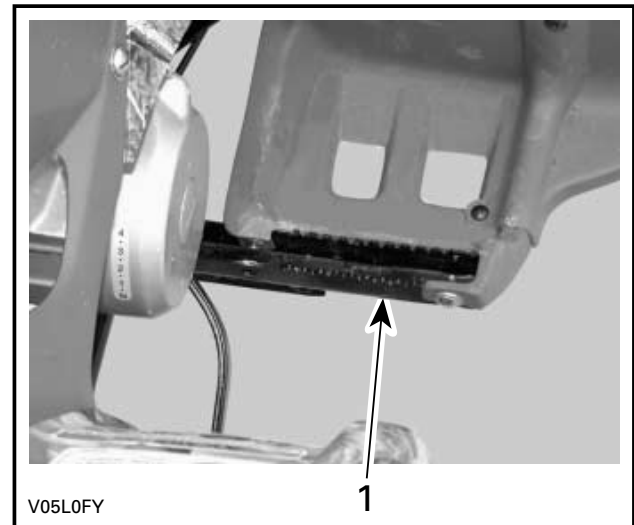

1. Footpeg

2-Stroke Models

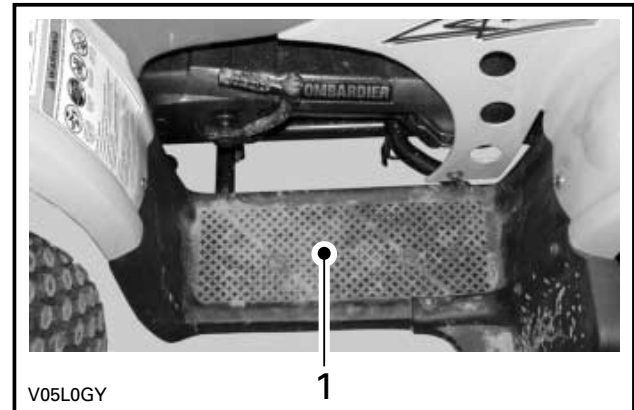

1. Footpeg

13) Seat Latch Knob

Located underneath rear fender, near rear bumper. It allows the removal of seat to give access to engine compartment. Pull knob to release seat.

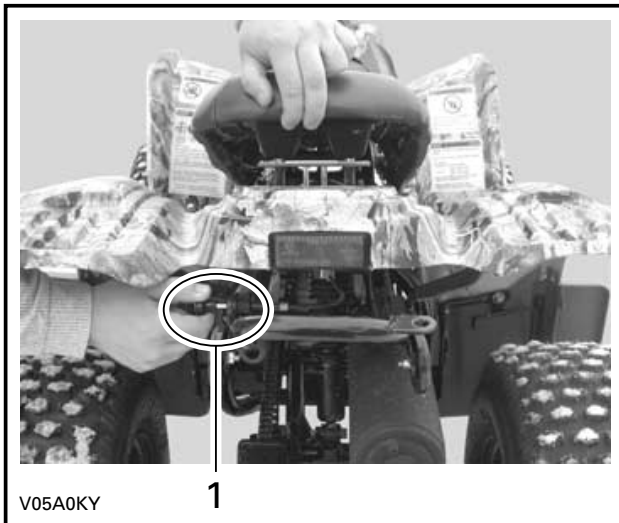

V05A0KY

1

1. Seat release knob

Seat Removal

Pull latch while gently lifting rear of seat. Pull seat rearward then remove it.

Seat Installation

Insert front tab of seat into frame hook. When seat rests in its position, firmly push seat down to latch.

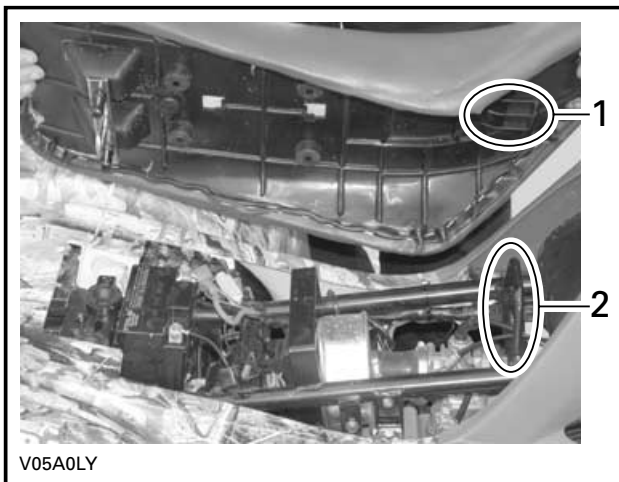

V05A0LY

1. Insert this tab in hook
2. Hook

WARNING

Make sure seat is securely latched before riding.

14) Fuse

The electrical system is protected with a fuse. Refer to MAINTENANCE for details.

The fuse holder is located on the RED (+) cable, near battery.

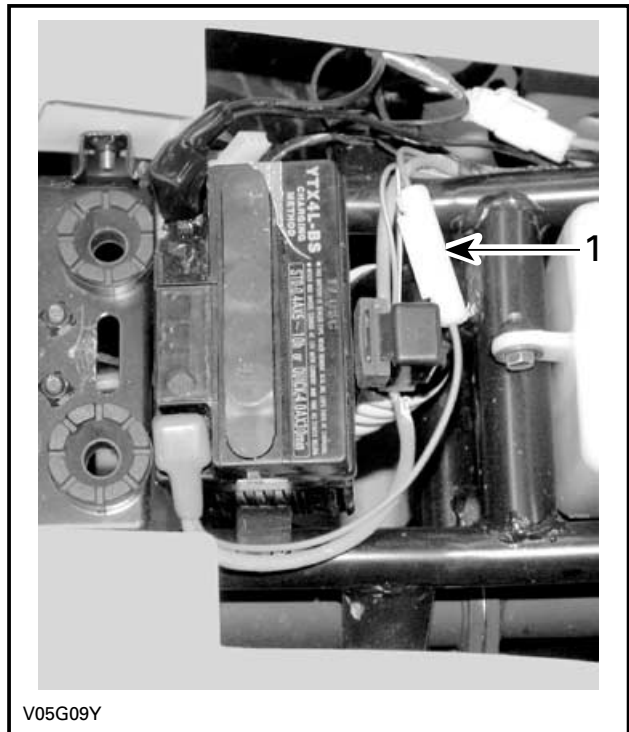

V05G09Y

1. Fuse holder

15) Gearshift Pedal

4-Stroke Models

Located in front of left footpeg.

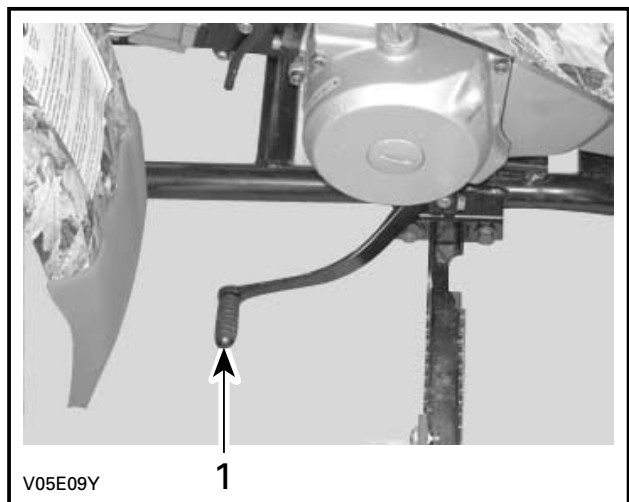

V05E09Y

1. Gearshift pedal

16) Kick Start Pedal

2-Stroke Models

Located on left side of vehicle.

To start engine, gently press pedal down until engagement is felt, then kick down with a rapid follow through motion.

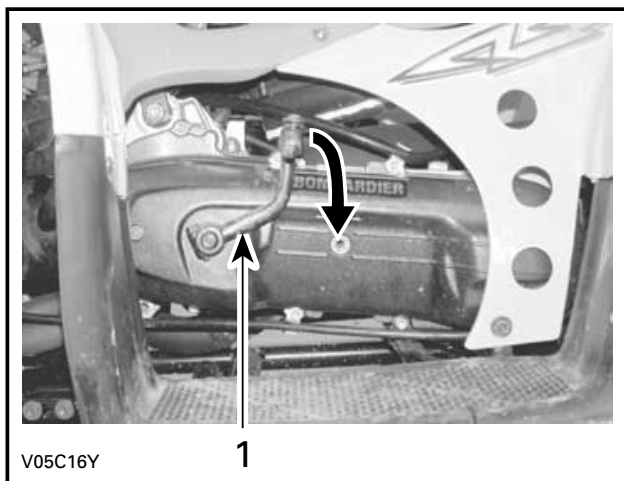

1. Kick start pedal

4-Stroke Models

Located on right side of vehicle.

To start engine, gently lift pedal up until engagement is felt, then pull up with a rapid follow through motion.

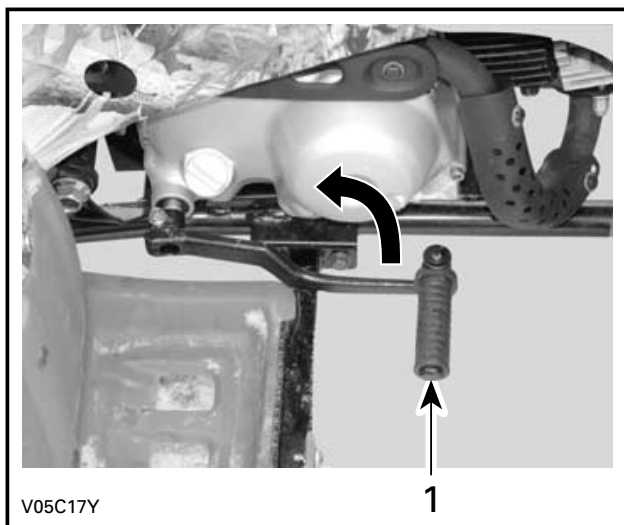

1. Kick start pedal

LIQUIDS

While reading this Operator's Guide, remember that:

WARNING

Indicates a potential hazard that, if not avoided, could result in serious injury or death.

NOTE: This section specifies the recommended liquids and procedures to check their levels. Refer to MAINTENANCE for procedures to replace the liquids.

WARNING

The following procedures should be done by an adult only.

Fuel

Recommended Fuel

Use regular unleaded gasoline or gasohol containing less than 10% of ethanol or methanol, available from most service stations. The gasoline used must have an octane number of 91 $((R + M)/2)$ or higher.

NOTE: In most service stations, pump octane number corresponds to $(R + M)/2$ octane number. Usually a sticker can be found on the pump.

CAUTION: Never experiment with other fuels. The use of unrecommended fuel can result in vehicle performance deterioration and damage to critical parts in the fuel system and engine components.

CAUTION: Never mix oil with fuel.

Fuel Level

WARNING

Always stop engine before refueling. Open cap slowly. If a differential pressure condition is noticed (whistling sound heard when loosening fuel tank cap) have vehicle inspected and/or repaired before further operation. Fuel is flammable and explosive under certain conditions. Never use an open flame to check fuel level. Never smoke or allow flame or spark in vicinity. Always work in a well-ventilated area. Never top off the fuel tank before placing the vehicle in a warm area. As temperature increases, fuel expands and may overflow. Always wipe off any fuel or oil spillage from the vehicle.

Engine Oil

Recommended Oil

4-Stroke Models

Use mineral-base 4-stroke engine oil that meets or exceeds the requirements for API service classification SG, SH or SJ. Always check the API service label on the oil container to be sure it includes the letters SG, SH or SJ. Only use high-quality high-detergent oil. Bombardier synthetic oil is recommended.

2-Stroke Models

Use 2-stroke injection oil only.

Oil Viscosity

4-Stroke Models

SAE 10W40 or SAE 40 is recommended.

Oil Level

2-Stroke Models

Remove seat and check the level through the oil tank. Refill if necessary.

NOTE: The oil tank capacity is 0.9 L (0.95 U.S. quart).

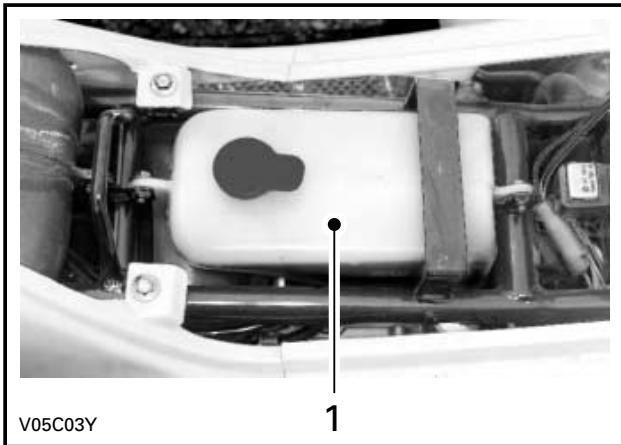

1. Oil tank

4-Stroke Models

CAUTION: Check level frequently and refill if necessary. Do not overfill. Operating the engine with an improper level may severely damage engine. Wipe off any spillage.

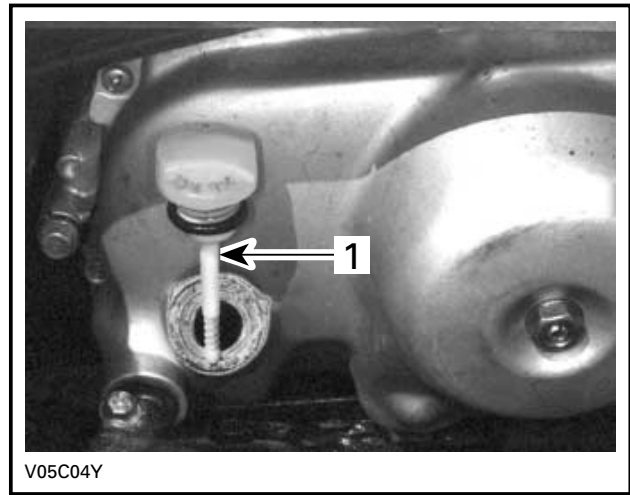

RH SIDE OF ENGINE

1. Dipstick

With vehicle on a level surface, start engine and let it running, around 1 minute, then stop engine check the oil level as follows:

1. Unscrew dipstick then remove it and wipe clean.
2. Reinstall dipstick, screw in it completely.
3. Remove and check oil level. It should be near or equal to the upper mark.

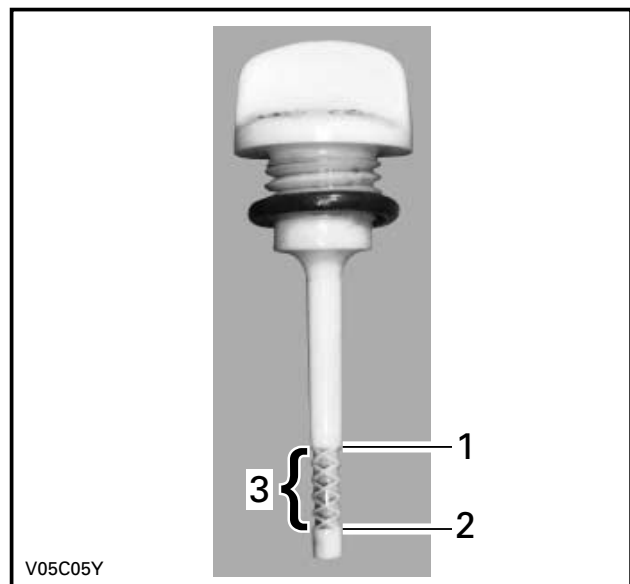

1. Full
2. Add
3. Operating range

To add oil, remove dipstick. Place a funnel into the dipstick hole to avoid spillage.

Add a small amount of oil and recheck oil level.

Repeat until oil level reaches the dipstick's upper mark. **Do not overfill.**

Properly tighten dipstick.

Battery

For any battery maintenance or verification, see an authorized Bombardier ATV dealer.

BREAK-IN PERIOD

Engine

4-Stroke Models

A break-in period of 10 operating hours is required before running the vehicle at sustained full throttle.

CAUTION: Never mix oil with fuel.

During this period, maximum throttle should not exceed 3/4. However, brief full acceleration and speed variations contribute to a good break-in. Continued wide open throttle accelerations, prolonged cruising speeds and engine overheating are detrimental during the break-in period.

2-Stroke Models

To insure maximum durability and optimal performance and to avoid engine damage, please pre-mix the first four tanks of fuel with two-stroke engine oil at 30:1 ratio. Do not operate the ATV at more than half throttle for the first three hours. During the break-in period (first four tanks of fuel), operate the vehicle at various RPM and do not operate the vehicle above half throttle for extended periods.

Belt

2-Stroke Models

A new belt requires a break-in period of 50 km (30 miles). Avoid strong acceleration/deceleration or high speed cruising.

10-Hour Inspection

As with any precision piece of mechanical equipment, we suggest that after the first 10 hours, 400 km (250 m.) or 30 days after the purchase, whichever comes first, your vehicle be inspected by an authorized Bombardier ATV dealer. This inspection will give you the opportunity to discuss the unanswered questions you may have encountered during the first hours of operation.

The 10-hour inspection is at the expense of the vehicle owner.

While reading this Operator's Guide, remember that:

WARNING

Indicates a potential hazard that, if not avoided, could result in serious injury or death.

PRE-OPERATION CHECK

WARNING

The pre-operation check is very important prior to operating the vehicle. Always check the proper operation of critical controls, safety features and mechanical components before starting. If not done as specified here, severe injury or death might occur.

- Start engine and drive forward slowly a few feet and apply all brakes individually to test them.

Correct any problem you may have found. See an authorized Bombardier ATV dealer as necessary.

- Apply parking brake and check if it operates properly.
- Check tire pressure and condition.
- Check wheels and bearings for wear and damage.
- Check location of controls and ensure they work properly.
- Verify steering operates freely.
- Activate throttle control lever several times to ensure it operates freely. It must return to idle position when released.
- Activate the brake levers to make sure the brakes fully apply. Levers must fully return when released.
- Check fuel and oil levels.
- Check for leaks on the engine, transmission and drive train components.
- Check drive chain for lubrication and adjustment.
- Check sprockets for wear and damages.
- Ensure fuel valve is in fully open position (ON).
- Ensure seat is properly latched.
- Look and feel for loose parts while engine is off. Check fasteners.
- Ensure the path of travel is free of persons and obstacles.
- Check operation of ignition switch, start button, engine stop switch and indicator light.

OPERATING INSTRUCTIONS

General

4-Stroke Models

This vehicle has four-forward gears. Transmission must be on NEUTRAL to allow engine starting.

All Models

Insert key in ignition switch and turn to ON. Place the engine stop switch to RUN position then press start button.

Initial Cold Starting

2-Stroke Models

The 2-stroke models have an automatic enricher.

To start the vehicle, place the ignition key to ON, push the engine stop switch to RUN position.

Press start button and hold until engine starts.

CAUTION: Do not hold start button more than 10 seconds. A rest period should be observed between the cranking cycles to let starter cool down. Pay attention not to discharge battery.

NOTE: Throttle assist may be used to help starting the engine faster. Press the throttle lever slightly; if it is pressed too much, the choke system will not be activated.

Release start button immediately when engine has started.

4-Stroke Models

Insert key in ignition switch and turn to ON.

NOTE: Do not forget, place the engine stop switch to RUN position.

In cold weather, colder than 0°C (32°F), fully pull up the choke lever.



V06C0LY

FULL CHOKE POSITION

Press start button and hold until engine starts.

CAUTION: Do not hold start button more than 10 seconds. A rest period should be observed between the cranking cycles to let starter cool down. Pay attention to battery; do not discharge it.

NOTE: Throttle assist may be used to help starting the engine faster. Press the throttle lever slightly; if it is pressed too much, the choke system will not be activated.

Release start button immediately when engine has started.

After a few seconds, push in the choke lever until the best engine RPM is achieved.

NOTE: Overusing choke may flood engine and make it hard to start. Refer to SPECIAL PROCEDURES if it occurs.

When the engine is warm, push the choke lever to OFF and release brakes.



OFF POSITION

Warm Engine Starting

Start the engine as explained above but without any choke. If the engine will not start after two 5-second attempts with the electric starter, pull the choke lever and place it half way position. Start the engine without activating the throttle lever. After few seconds, push the choke lever to OFF.

Stopping the Engine

WARNING

Avoid parking on a slope.

Release throttle and completely stop the vehicle.

Apply the parking brake.

Set transmission lever in NEUTRAL position (**4-stroke models only**).

Push the engine stop switch in OFF position.

Turn key in ignition switch to OFF.

Remove key from ignition switch.

Shifting the Transmission

4-Stroke Models

To shift the transmission, release throttle lever, then operate gearshift pedal as follow.

WARNING

Always release the throttle when shifting gears. Shifting gears without releasing the throttle, could cause loss of control or cause the ATV to overturn.

One full stroke of the pedal shifts the transmission to the next higher or lower gear in the shifting sequence. The pedal should automatically return to its original position.

To upshift to a higher gear, put the end of your boot under gearshift lever and lift up the pedal one full stroke. To downshift, step on the gearshift pedal and depress pedal one full stroke.

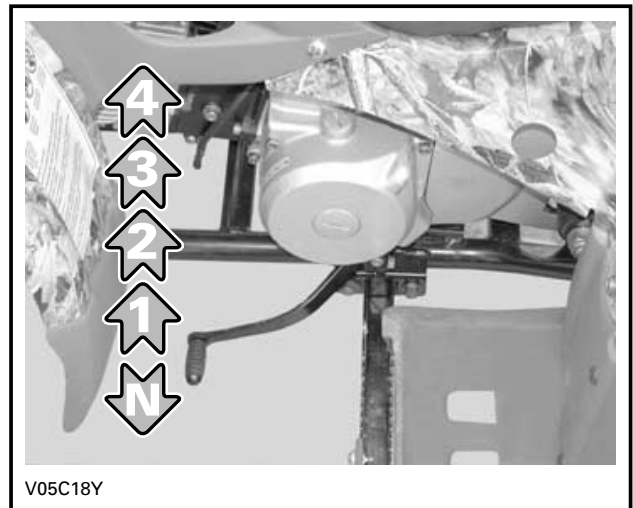

SPECIAL PROCEDURES

Flooded Engine

When the engine does not start after several attempts, the engine may be fuel flooded. Proceed as follows.

Turn ignition switch to ON and ensure choke is not applied.

Ensure the transmission is on NEUTRAL (**4-stroke models only**).

Fully press throttle lever and hold while starting the engine.

As soon as the engine starts, release throttle lever. Do not race engine.

If it does not work:

Disconnect the spark plug cable.

Remove the spark plug.

Crank engine several times. Install new spark plug if possible or clean and dry spark plug.

Start engine as explained above. If engine continues to flood, see an authorized Bombardier ATV dealer.

Engine Overheat

If engine overheats try the following:

Reduce vehicle speed but try to keep vehicle moving to supply air to radiator. If engine is still overheating after approximately one minute, stop vehicle and set transmission to NEUTRAL (**4-stroke models**). Apply parking brake and stop engine.

Let engine cool down.

See an authorized Bombardier ATV dealer as soon as possible.

Post-Operation Care

Never use a high pressure washer to clean these vehicles. **USE LOW PRESSURE ONLY (like a garden hose)**. High pressure can cause electrical and mechanical damages.

When vehicle is used in salt - water environment (beach area), rinsing the vehicle with fresh water is necessary to preserve vehicle and its components. Metallic parts lubrication is highly recommended. Use BOMBARDIER LUBE.

This must be performed at the end of each operating day.

When vehicle is operated in muddy conditions, rinsing the vehicle is recommended to preserve vehicle and its components and to keep lights clean.

Turn Over

When vehicle is turned over or stays tilted on the side, replace the vehicle in its normal operation position (on all four wheels) and wait 3 to 5 minutes before starting engine. Check oil level and refill if necessary.

ATV Immersion

Should the ATV become immersed, it will be necessary to take it to an authorized Bombardier ATV dealer as soon as possible. **DO NOT START THE ENGINE!** Immersion of the ATV can cause serious damage if the correct restart procedure is not followed.

Storage and Preseason Preparation

WARNING

Have an authorized Bombardier ATV dealer inspect fuel system integrity as specified in Maintenance Chart.

When a vehicle is not in use for more than one month, proper storage is a necessity.

See an authorized Bombardier ATV dealer for proper procedures.

When using your ATV after storage, a preparation is required. See an authorized Bombardier ATV dealer for proper procedures.

TRANSPORTATION

While reading this Operator's Guide, remember that:

WARNING

Indicates a potential hazard that, if not avoided, could result in serious injury or death.

Transportation

When transporting a vehicle, secure vehicle to trailer with suitable tie-downs. Using ordinary ropes is not recommended.

WARNING

Never tip this vehicle on end for transporting. We recommend that you carry the vehicle in its normal operating position (on all four wheels).

Place the fuel valve to OFF position.

Apply the parking brake.

Secure the vehicle to front by the front bumper and rear by the rear bumper.



FRONT LOCATION

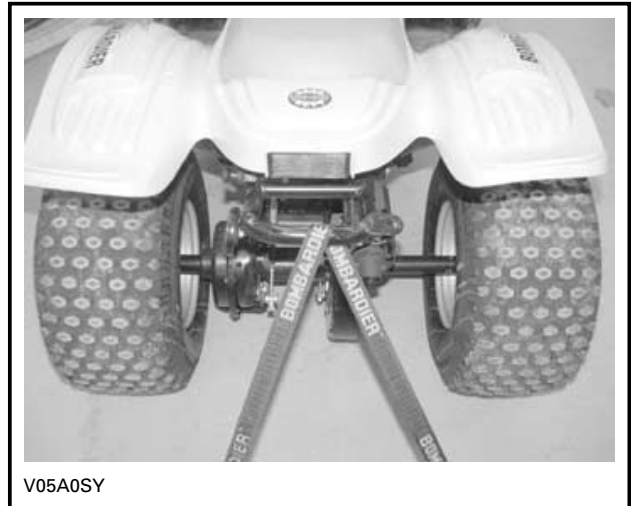

REAR LOCATION

CAUTION: Attaching vehicle at other locations may damage the vehicle.

WARNING

Do not tow this vehicle behind a car or other vehicle. Use a trailer.

MAINTENANCE INFORMATION

MAINTENANCE CHART

The maintenance is very important, if you are not familiar with safe service practices and adjustment procedures, see your authorized Bombardier ATV dealer.

2-Stroke Models

I: Inspect, verify, clean, adjust, lubricate or replace if necessary A: Adjust C: Clean L: Lubricate R: Replace	Initial inspection 10 h or 30 days or 400 km (250 m.) ⁽¹⁾	EVERY			To be performed by
		25 h or 1250 km (800 m.)	50 h or 2500 km (1600 m.)	100 h or 1 year or 5000 km (3100 m.)	
ENGINE/TRANSMISSION					
Gearbox oil level	I		I		Customer
FUEL					
Air filter ⁽³⁾			C	I	Customer
Fuel lines and connections	I		I		Dealer
Carburetor	I		A	C	Dealer
ELECTRICAL					
Spark plug	I			R	Dealer
Battery connections			I		Dealer
DRIVE TRAIN					
Drive chain lubrication/adjustment		EVERY RIDE			Customer
Sprocket wear ⁽³⁾				I	Dealer
STEERING					
Handlebar fasteners ⁽²⁾	I	A		I	Dealer
Tires pressure and wear		EVERY RIDE			Customer
SUSPENSION					
Shock absorbers		I			Customer
BRAKE					
Brake system ⁽²⁾	I	A		I	Dealer
BODY/FRAME					
Fasteners tightness ⁽²⁾	I	I			Customer
Frame lubrication ⁽³⁾			I		Customer

4-Stroke Models

I: Inspect, verify, clean, adjust, lubricate or replace if necessary A: Adjust C: Clean L: Lubricate R: Replace	Initial inspection 10 h or 30 days or 400 km (250 m.) ⁽¹⁾	EVERY			To be performed by
		25 h or 1250 km (800 m.)	50 h or 2500 km (1600 m.)	100 h or 1 year or 5000 km (3100 m.)	
ENGINE/TRANSMISSION					
Clutch system	I			I	Dealer
Engine idle speed	I			I	Dealer
Engine oil level ⁽²⁾	I			R	Customer
Engine oil strainer				C	Dealer
Valve clearance	I			A	Dealer
FUEL					
Air filter ⁽³⁾		C		I	Customer
Fuel filter, fuel lines and connections	I			I	Dealer
Carburetor	I		A	C	Dealer
ELECTRICAL					
Spark plug	I			R	Dealer
Battery connections	I		I		Customer
DRIVE TRAIN					
Drive chain lubrication/adjustment		EVERY RIDE			Customer
Sprocket wear ⁽³⁾				I	Dealer
STEERING					
Handlebar fasteners ⁽²⁾	I	A		I	Dealer
Tires pressure and wear		EVERY RIDE			Customer
SUSPENSION					
Shock absorbers		I			Customer
BRAKE					
Brake system ⁽²⁾	I	A		I	Dealer
BODY/FRAME					
Fasteners tightness ⁽²⁾	I	I			Customer
Frame lubrication ⁽³⁾			I		Customer

(1) To be performed by an authorized Bombardier ATV dealer. The initial maintenance is very important and must not be neglected.

(2) Pre-ride inspection item.

(3) More often under severe use such dusty area, sand, snow, wet or muddy conditions

MAINTENANCE

While reading this Operator's Guide, remember that:

WARNING

Indicates a potential hazard that, if not avoided, could result in serious injury or death.

WARNING

Unless otherwise specified, engine should not be running for all maintenance procedures.

Before performing any service or inspection operation on the vehicle, wait until the engine and exhaust have cooled down to avoid potential burns.

WARNING

Should removal of a locking device (e.g. lock tabs, self-locking fasteners, etc.) be required when undergoing disassembly/assembly, always replace with a new one.

WARNING

All maintenance should be done by an adult or an authorized Bombardier ATV dealer. Do not allow children to attempt repairs or maintenance.

The following covers the maintenance items that can be performed by the customer if desired. Other items found in maintenance chart must be performed by an authorized Bombardier ATV dealer.

NOTE: Among other things, this section gives the procedures to replace the liquids. Refer to LIQUIDS for procedures to check levels and refill.

Engine/Transmission

Oil Change and Oil Filter Replacement

Oil and filter are to be replaced at the same time. Oil change should be done with a warm engine.

WARNING

The engine oil can be very hot. Wait until engine oil is warm.

Ensure vehicle is on a level surface.

Clean the drain plug area.

Remove dipstick.

Place a drain pan under the engine drain plug area.

Unscrew drain plug.

Allow enough time for oil to flow out of oil filter.

Remove the right crankcase cover to replace oil filter.

Remove the oil filter and replace with a new filter.

Wipe out any oil spillage on engine.

Change gasket on drain plug. Clean gasket area on engine and drain plug then reinstall plug. Refill engine at the proper level with the recommended oil. Refer to SPECIFICATIONS for capacity.

Start engine and let idle for a few minutes. Ensure oil filter area and drain plug areas are not leaking.

Stop engine. Wait a while to allow oil to flow down to crankcase then check oil level. Refill as necessary.

Dispose of oil as per your local environmental regulations.

Valve Adjustment

See an authorized Bombardier ATV dealer for valves adjustment.

Insufficient clearance will cause loss of power and possibly damage the valves. Excessive clearance will cause noise.

Air Filter

Air Filter Replacement

2-Stroke Models

The air filter box is located under front fender on the right side of vehicle.

CAUTION: Never remove or modify any component in the air box. The engine carburetion is calibrated to operate specifically with these components. Otherwise, engine performance degradation or damage can occur.

Unlatch clamps retaining the air box cover then remove the cover.

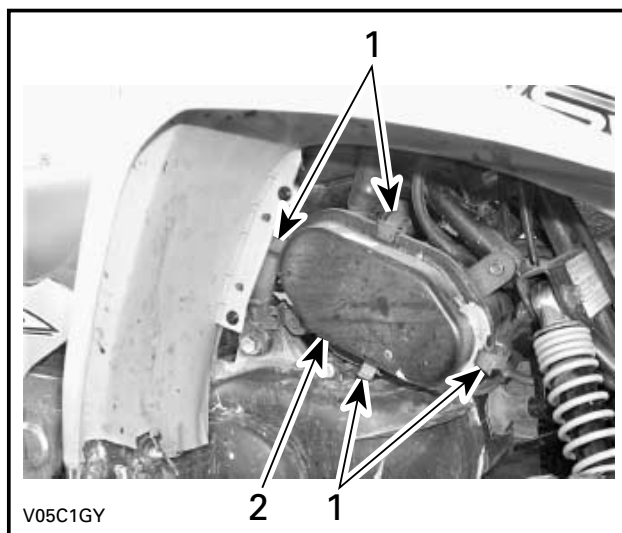

1. Clamps
2. Air box cover

Remove and clean the air filter element.



To clean the air filter element use the following procedure.

Pour cleaning solution (P/N 219 700 341) or an equivalent into a bucket. Put the filter in to soak.

While filter soaks, clean inside the air box.

Rinse the filter with warm water until all cleaning solution disappears.

If the air filter is still dirty, replace it with a new one.

Then, let the filter dry completely.

When the filter is dried, re-oil with air filter oil (P/N 219 700 340) or an equivalent.

CAUTION: Engine performance degradation or severe damages can occur if the air filter is not properly maintained and/or if it not well oiled.

Install the air filter cover and close the clamps.

4-Stroke Models

NOTE: The air filter box is located under the seat.

Removal

Remove:

- seat
- electrical connector



- bolts (one on each side of air filter box cover)

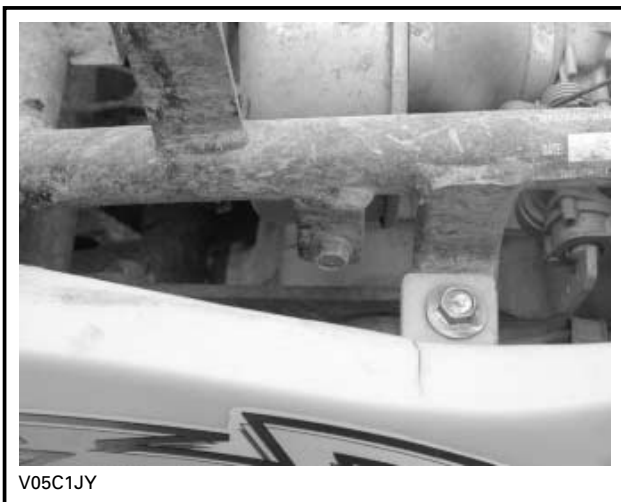

- central nut



- air filter cover
- air filter element.

Installation

When installing the air filter, make sure that air filter makes proper contact with air filter base otherwise, an air by-pass could be created causing engine to suck-in unfiltered air which could cause engine damage.

Following photos show procedure.

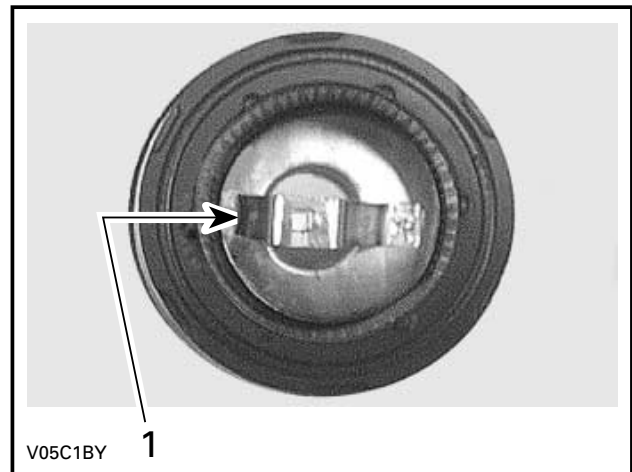

1. Interference between filter rubber edge and base bracket

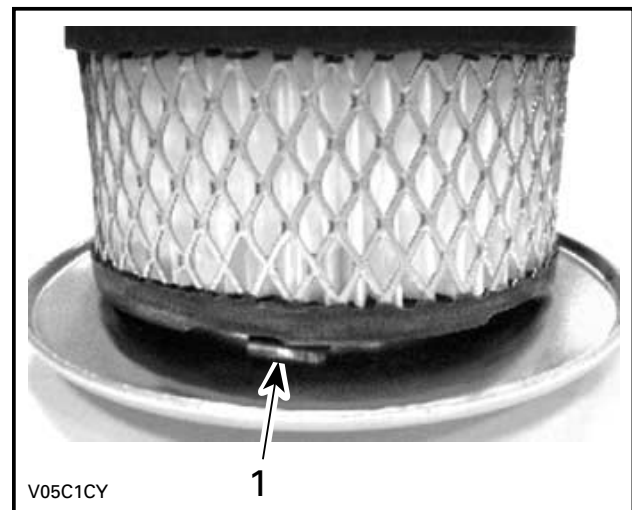

1. Gap between filter and filter base

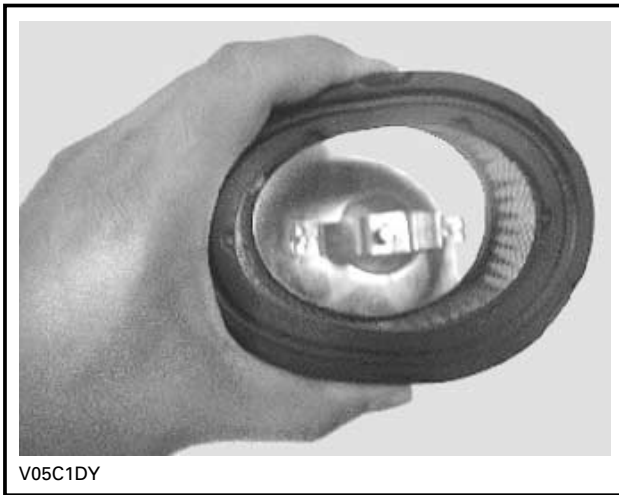

HAND PRESS FILTER INTO AN OVAL SHAPE

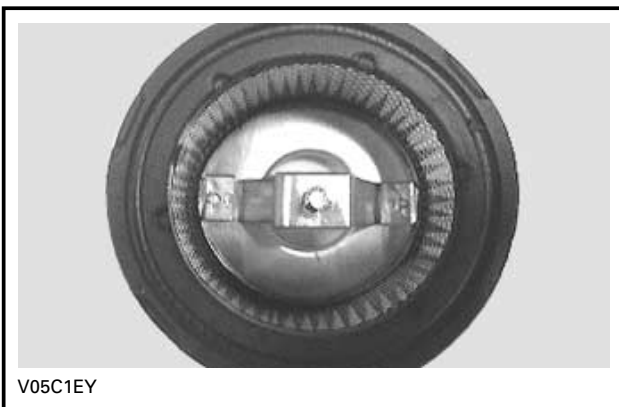

PLACE OVAL FILTER ONTO BASE AS SHOWN

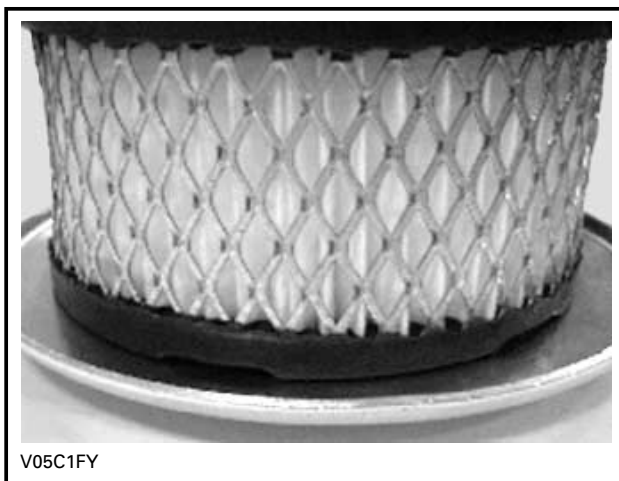

AIR TIGHT FIT, FILTER WITH BASE

Install all other parts by reversing the removal procedure.

Electrical

WARNING

Unless otherwise indicated, always turn ignition switch to the OFF position before performing any maintenance or repair on electrical system.

Battery

WARNING

Never charge a battery while installed in vehicle.

Clean battery post with a wire brush. Apply dielectric grease on post to protect against oxidation.

Removal

Disconnect BLACK (-) cable first then RED (+) cable.

WARNING

Always respect this order for disassembly; disconnect BLACK (-) cable first. Electrolyte or fuel vapors can be present in engine compartment and a spark may ignite them and possibly cause personal injuries.

Remove battery from vehicle being careful not to tilt it so that electrolyte flows out of vent tube.

⚠ WARNING

Battery electrolyte is caustic substance that burns or destroys organic tissues by chemical action. Avoid contact with eyes, skin and clothing. Wear protective eyeglasses and a suitable pair of non-absorbent gloves when removing the battery by hand. Should any electrolyte spillage occur, immediately wash off with a solution of baking soda and water.

Installation

Reinstall battery in vehicle.

⚠ WARNING

Connect RED (+) cable first then BLACK (-) cable. Always connect RED (+) cable first.

Fuse

If the fuse is damaged, replace it by one of the same rating.

CAUTION: Do not use a higher rated fuse as this can cause severe damage.

Fuse holder is located on the RED (+) battery cable.

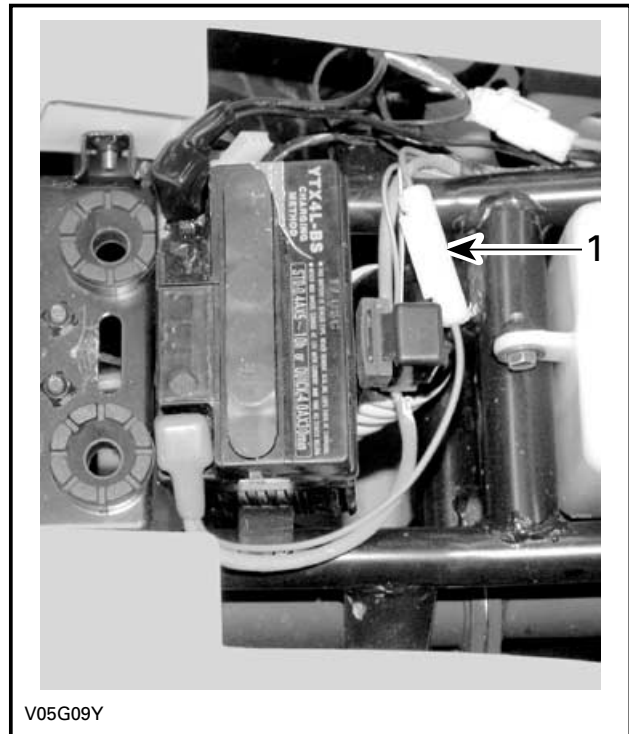

1. Fuse holder

Drive Train

Drive Chain

Check drive chain condition.

The drive chain should be checked, lubricated and adjusted at every ride.

The free-play of the drive chain should be between 20 to 30 mm (25/32 to 1-3/16 in) up and down.

Adjust the drive chain by adjusting the drive chain adjusting nut.

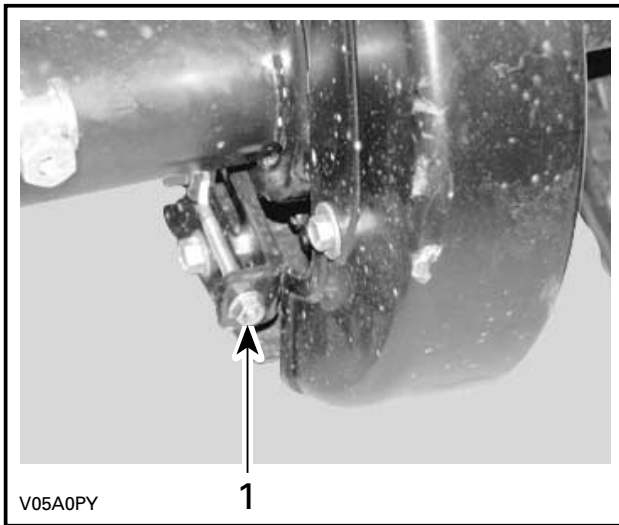

2-STROKE MODELS

1. Drive chain adjusting nut

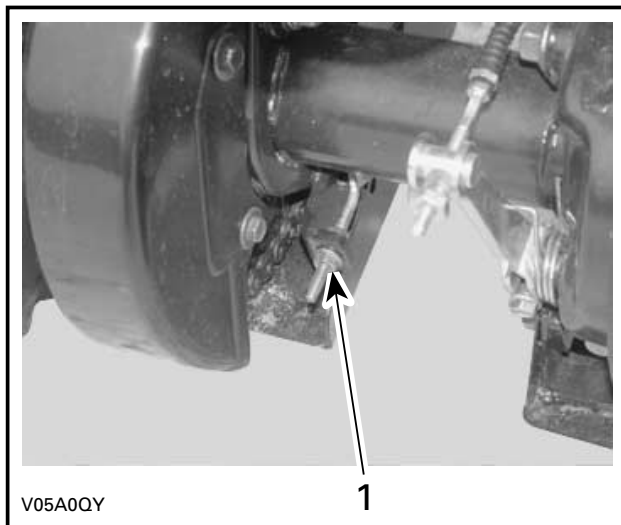

4-STROKE MODELS

1. Drive chain adjusting nut

Wheel

Occasionally, wheel nuts should be removed to apply anti-seize lubricant on studs to ease future removal. This is particularly important when vehicle is used in salt-water environment or in mud. Remove one nut at a time, lubricate then retorque.

Tires/Wheels

Tire Pressure

WARNING

Tire pressure greatly affects vehicle handling and stability. Under-pressure may cause tire to deflate and rotate on wheel. Overpressure may burst the tire. Always follow recommended pressure. Since tires are low-pressure types, a manual pump should be used.

Check pressure when tires are «cold» before using the vehicle. Tire pressure changes with temperature and altitude. Recheck pressure if one of these conditions has changed.

For your convenience, a pressure gauge is supplied in tool box.

TIRE PRESSURE	
FRONT AND REAR	
RECOMMENDED	55 kPa (8 PSI)
MINIMUM	41 kPa (6 PSI)

Although the tires are specifically designed for off-road use, a flat may still occur. Therefore, it is recommended to carry a tire pump and a repair kit.

Tire/Wheel Condition

Check tire for damage and wear. Replace if necessary.

Wheel Removal

Loosen bolts then lift vehicle. Place a support under vehicle. Remove bolts then remove wheel.

At installation, it is recommended to apply anti-seize lubricant on bolts threads. Gently tighten bolts in a criss-cross sequence then apply a final torque.

WHEEL NUTS TORQUE

44 N•m (32 lbf•ft)

Steering System

Throttle Cable Adjustment

The normal throttle free-play is 2 to 6 mm (3/32 to 7/32 in).

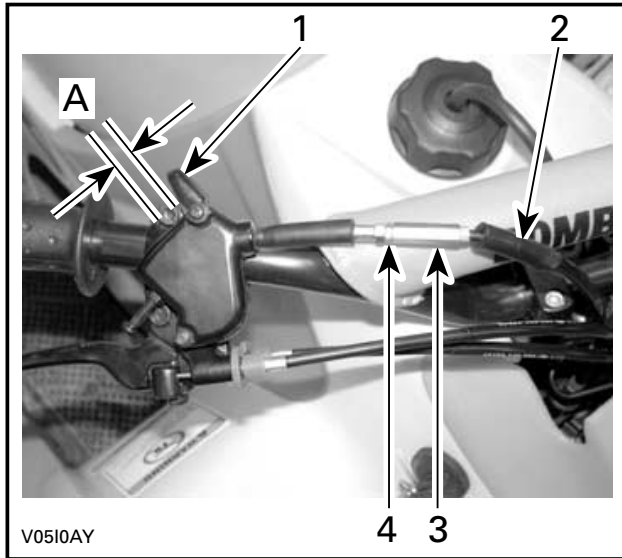

1. Throttle lever
2. Rubber protector
3. Cable adjuster
4. Locking nut
- A. 2 to 6 mm (3/32 to 7/32 in)

To adjust cable, slide rubber protector back to expose throttle cable adjuster.

Loosen locking nut and turn the adjuster to get proper adjustment.

NOTE: Measure throttle free play at the tip of throttle lever.

Tighten locking nut and reinstall protector.

Suspension

Adjustment

Front Shocks

4-Stroke Models

WARNING

Left and right adjusting cams must always be set at the same position. Never adjust one adjusting cam only. Uneven adjustment can cause poor handling and loss of stability, which could lead to an accident.

Preload Adjustment

All Models (front or rear)

Adjust spring preload by turning adjusting cam.

Turn the adjusting cams clockwise for a firmer ride and rough road condition.

Turn the adjusting cams counterclockwise for a light load and a smooth road condition.

Brake

Brake Lever Adjustment

The normal free-play of brake lever is between 10 and 20 mm (13/32 and 25/32 in).

To adjust front brakes, use the adjusters on right brake lever.

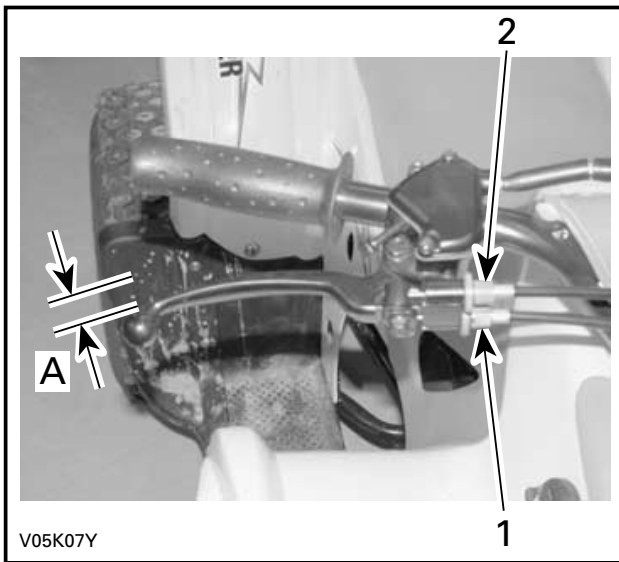

1. Left front brake adjuster
2. Right front brake adjuster
- A. 10 to 20 mm (13/32 to 25/32 in)

To adjust rear brake, turn the adjustment nut at the end of brake cable.

WARNING

Adjustment nut must be aligned with pin, any slight deviation may result in brake pedal backlash when brake is applied.

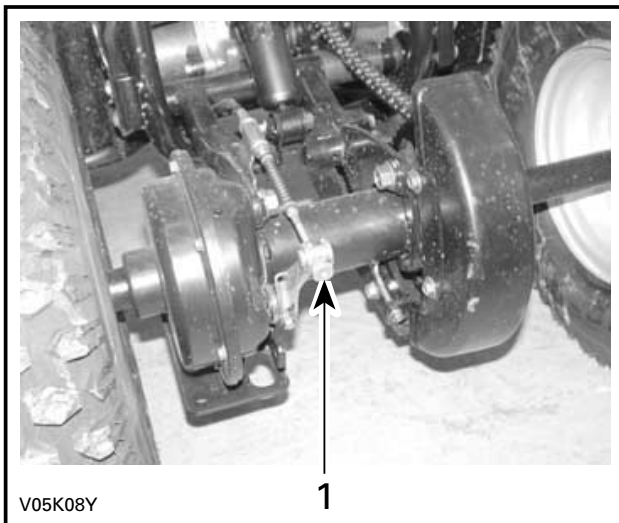

- 2-STROKE MODELS**
1. Adjusting nut

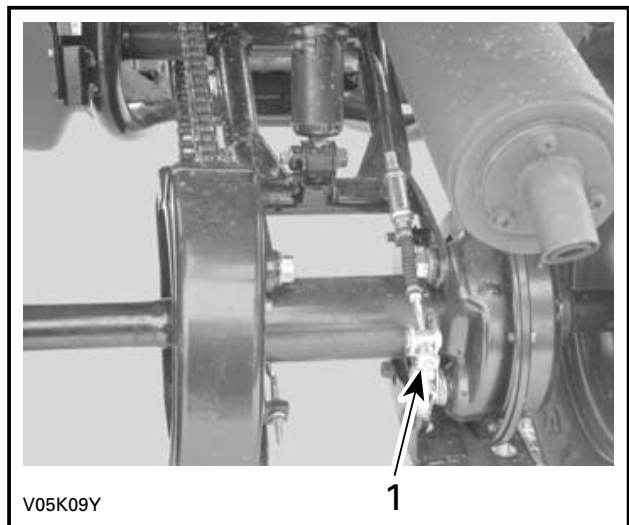

- 4-STROKE MODELS**
1. Adjusting nut

Body/Frame

Engine Compartment

Check engine compartment for any damage and leaks. Ensure all hose clamps are properly secured and no hose is cracked, kinked or otherwise damaged.

Inspect muffler, battery and reservoir fastening devices.

Check electrical connections for corrosion and tightness.

Replace or have damaged parts repaired.

Fasteners

Check fastener condition and tightness on the vehicle. Retighten as required.

Seat Latch

Remove seat and check latch mechanism for wear. See an authorized Bombardier ATV dealer for parts replacement if damaged.

TROUBLESHOOTING

Engine does not turn

1. Ignition switch is in the OFF position.
 - *Place switch to the ON position.*
2. Transmission is not set on NEUTRAL.
 - *Set transmission either in NEUTRAL.*
3. Burnt fuse.
 - *Check main supply fuse.*
4. Weak battery or loose connections.
 - *Check connections and terminals condition.*
 - *Have the battery checked.*
 - *Contact an authorized Bombardier ATV dealer.*
5. Engine stop switch is in the OFF position.
 - *Place switch to the ON position.*

Engine turns over but fails to start

1. Mixture not rich enough to start cold engine.
 - *Check fuel tank level and check starting procedure, particularly use of the choke.*
2. Flooded engine (spark plug wet when removed).
 - *Refer to SPECIAL PROCEDURES.*
3. No fuel to the engine (spark plug dry when removed).
 - *Check fuel tank level; turn fuel valve to ON (also try on RES). A failure of the fuel pump or carburetor may have occurred.*
 - *Contact an authorized Bombardier ATV dealer.*
4. Spark plug/ignition (no spark).
 - *Remove spark plug then reconnect to spark plug cap.*
 - *Check that ignition switch and/or engine stop switch is/are at the ON position.*
 - *Start engine with spark plug grounded to the engine away from spark plug hole. If no spark appears, replace spark plug.*
 - *If trouble persists, contact an authorized Bombardier ATV dealer.*
5. Engine compression.
 - *As the engine is pulled over with the kick stater, "cycles" of resistance should be felt as piston goes past top dead center. If no pulsating resistance is felt, it suggests a major loss of compression. Contact an authorized Bombardier ATV dealer.*

Engine lacks acceleration or power

1. Fouled/damage/worn spark plug.
 - *Clean/verify spark plug and heat range. Replace as required.*
2. Lack of fuel to engine.
 - *Check item ENGINE TURNS OVER BUT FAILS TO START.*
3. Carburetor adjustments.
 - *Contact an authorized Bombardier ATV dealer.*
4. Engine is overheating.
 - *Check ENGINE OVERHEATING in SPECIAL PROCEDURES.*
 - *If overheating persists, contact an authorized Bombardier ATV dealer.*
5. Air filter/box plugged or dirty.
 - *Check air filter and clean if necessary.*
 - *Check the position of the air intake tube.*
6. CVT dirty or wear.
 - *Contact an authorized Bombardier ATV dealer.*

Engine backfire

1. Exhaust system leakage.
 - *Contact an authorized Bombardier ATV dealer.*
2. Engine is running too hot.
 - *See ENGINE LACKS ACCELERATION OR POWER.*
3. Ignition timing is incorrect or there is an ignition system failure.
 - *Contact an authorized Bombardier ATV dealer.*
4. Improper carburetor setting.
 - *Contact an authorized Bombardier ATV dealer.*

Engine misfire

1. Fouled/damaged/worn spark plug.
 - *Clean/verify spark plug and heat range. Replace as required.*
2. Water in fuel.
 - *Drain fuel system and refill with fresh fuel.*

Vehicle cannot reach full speed

1. Engine.
 - *See ENGINE LACKS ACCELERATION OR POWER.*
2. Parking brake.
 - *Ensure brake lever lock is completely removed.*

3. Air filter/box plugged or dirty.
 - *Check air filter and clean if necessary.*
 - *Check the position of the air intake tube.*
4. CVT dirty or wear.
 - *Contact an authorized Bombardier ATV dealer.*

Gearshift lever is hard to move

1. Transmission gears are in a position that prevents the transmission lever from working.
 - *Rock the vehicle back and forth to move the gears in the transmission and allow the transmission lever to be set.*
2. Engine idle speed is set too high.
 - *Adjust the idle speed. Refer to the SPECIFICATIONS.*
3. CVT dirty or wear.
 - *Contact an authorized Bombardier ATV dealer.*

The RPM increases but the vehicle does not move

1. The transmission is in NEUTRAL position.
 - *Set transmission in REVERSE or HI.*
2. CVT is defective.
 - *Contact an authorized Bombardier ATV dealer.*
3. Water in the CVT housing.
 - *Contact an authorized Bombardier ATV dealer.*

SPECIFICATIONS

VEHICLE MODEL		DS90 4-STROKE
ENGINE		
Type		4 stroke, forced air cooled. KA-90
Number of cylinder		Single horizontal cylinder
Number of valves		2 valves
Displacement		86 cc (5.2 cu. in)
Bore	Standard	47 mm (1.85 in)
Stroke		49.5 mm (1.94 in)
Starting		Electric/kick start
Compression ratio		8.1:1
Lubrication		Wet sump with replaceable oil filter
Decompressor		N.A.
TRANSMISSION		
Transmission		Semi - automatic, 4 speed, wet multi-disk
CARBURETION		
Carburetor	Make	Walibro PZ
	Type	VM-16
Idle speed	± 100	1700 RPM
ELECTRICAL		
Ignition type		CDI (Capacitor Discharge Ignition)
Spark plug	Make	NGK
	Type	CR7HSA
	Gap	0.7 mm (.027 in)
Number of spark plug		1
Battery	Type	Maintenance free
	Volt	12 volts, 4 Ah
Starting system		Electric start
Taillight bulb		N.A.
Fuse	Main	7 A

VEHICLE MODEL		DS90 4-STROKE
SUSPENSION		
Front	Type	Independent suspension — A-arm, 2 shock absorbers (oil)
	Travel	35 mm (1.38 in)
Rear	Type	Rigid swing-arm, 1 shock absorber (oil)
	Travel	50 mm (2 in)
TIRES		
Pressure	Front	55 kPa (8 PSI) maximum, 41 kPa (6 PSI) minimum
	Rear	55 kPa (8 PSI) maximum, 41 kPa (6 PSI) minimum
Size	Front	20 x 7-8
	Rear	18 x 9.5-8
WHEELS		
Size	Front	8 x 5.5
	Rear	8 x 7
Wheel nuts torque		44 N•m (32 lbf•ft)
BRAKES		
Front		2, drums
Rear		1, drum
Parking device		LH brake lever whit lock
DIMENSIONS		
Dry mass		120 kg (265 lb)
Overall length		1.53 m (60 in)
Overall width		89 cm (35 in)
Overall height		90 cm (35.5 in)
Wheel base		95.5 cm (38 in)
Ground clearance	Front and under engine	20 cm (7.8 in)
	Rear	21 cm (8 in)

VEHICLE MODEL		DS50 2-STROKE	DS90 2-STROKE
ENGINE			
Type		2 stroke, forced air cooled. JA-50	2 stroke, forced air cooled. JA-90
Number of cylinder		Single horizontal cylinder	
Displacement		49.3 cc (3 cu. in)	82.5 cc (5 cu. in)
Bore	Standard	40 mm (1.57 in)	50 mm (1.96 in)
Stroke		39.2 mm (1.54 in)	42 mm (1.65 in)
Starting		Electric/kick start	
Compression ratio		7:1	6.9:1
TRANSMISSION			
Transmission		Continuously Variable Transmission (CVT)	
CARBURETION			
Carburetor	Make	Mikuni	Mikuni
	Type	VM-16 JET-50	VM-16 JET-100
Idle speed	± 100	1800 RPM	
ELECTRICAL			
Ignition type		CDI (Capacitor Discharge Ignition)	
Spark plug	Make	NGK	
	Type	BPR7HS	
	Gap	0.7 mm (.027 in)	
Number of spark plug		1	
Battery	Type	Maintenance free	
	Volt	12 volts, 4 Ah	
Starting system		Electric start	
Taillight bulb		N.A.	
Fuse	Main	7 A	
SUSPENSION			
Front	Type	Independent suspension— A-arm, 2 shock absorbers (oil)	
	Travel	35 mm (1.38 in)	
Rear	Type	Rigid swing-arm, 1 shock absorber (oil)	
	Travel	50 mm (2 in)	

VEHICLE MODEL		DS50 2-STROKE	DS90 2-STROKE
TIRES			
Pressure	Front	55 kPa (8 PSI) maximum, 41 kPa (6 PSI) minimum	
	Rear	55 kPa (8 PSI) maximum, 41 kPa (6 PSI) minimum	
Size	Front	16 x 8-7	20 x 7-8
	Rear	16 x 8-7	18 x 9.5-8
WHEELS			
Size	Front	7 x 5.5	8 x 5.5
	Rear	7 x 5.5	8 x 7
Wheel nuts torque		44 N•m (32 lbf•ft)	
BRAKES			
Front		2, drums	
Rear		1, drum	
Parking device		LH brake lever whit lock	
DIMENSIONS			
Dry mass		103 kg (227 lb)	108 kg (238 lb)
Overall length		1.47 m (58 in)	1.53 m (60 in)
Overall width		87.5 cm (34 in)	89 cm (35 in)
Overall height		89 cm (35.5 in)	93 cm (37 in)
Wheel base		95.5 cm (38 in)	
Ground clearance	Front and under engine	14 cm (5.5 in)	17 cm (6.7 in)
	Rear	18 cm (7 in)	21 cm (8 in)
LIQUIDS			
Oil type (engine and transmission)		2-stroke engine oil only, Synthetic oil is recommended	
Fuel	Type	Super unleaded gasoline	
	Octane	91 (R + M)/2 or higher	

SI* METRIC INFORMATION GUIDE

BASE UNITS			
DESCRIPTION	UNIT	SYMBOL	
length	meter	m	
mass	kilogram	kg	
force	newton	N	
liquid	liter	L	
temperature	Celsius	°C	
pressure	kilo pascal.....	kPa	
torque	newton-meter	N•m	
land velocity	kilometer per hour.....	km/h	
PREFIXES			
PREFIX	SYMBOL	MEANING	VALUE
kilo	k	one thousand	1000
centi	c	one hundredth of	0.01
milli.....	m	one thousandth of.....	0.001
micro	μ	one millionth of	0.000001
CONVERSION FACTORS			
TO CONVERT	TO (1)	MULTIPLY BY	
in	mm.....	25.4	
in	cm.....	2.54	
in ²	cm ²	6.45	
in ³	cm ³	16.39	
ft	m.....	0.3	
oz	g.....	28.35	
lb	kg.....	0.45	
lbf.....	N.....	4.4	
lbf•in.....	N•m.....	0.11	
lbf•ft.....	N•m.....	1.36	
lbf•ft.....	lbf•in.....	12	
PSI	kPa.....	6.89	
imp. oz	U.S. oz.....	0.96	
imp. oz	mL.....	28.41	
imp. gal	U.S. gal.....	1.2	
imp. gal	L.....	4.55	
U.S. oz.....	mL.....	29.57	
U.S. gal.....	L.....	3.79	
MPH.....	km/h.....	1.61	
Fahrenheit.....	Celsius	(°F - 32) ÷ 1.8	
Celsius	Fahrenheit	(°C x 1.8) + 32	
hp.....	kW.....	.75	

* The international system of units abbreviates SI in all languages.

- (1) To obtain the reverse sequence, divide by the given factor. To convert millimeters to inches, divide by 25.4.

NOTE: Conversion factors are rounded off to 2 decimals for easier use.

WARRANTY

BRP LIMITED WARRANTY NORTH AMERICA: 2005 BOMBARDIER† ATV

1) SCOPE OF THE LIMITED WARRANTY

Bombardier Recreational Products Inc. (BRP)*, warrants its 2005 Bombardier ATVs from defects in material or workmanship for the period and under the conditions described below.

All genuine Bombardier parts and accessories, installed by an authorized Bombardier ATV dealer (as hereinafter defined) at the time of delivery of the 2005 Bombardier ATV, carry the same warranty as that of the ATV.

Carlisle ‡ tires and Warn+++ winches installed as original equipment on ATVs are warranted separately by the tire and winch manufacturer. If such tire or winch are installed on your Bombardier ATV, please contact the manufacturer or ask your authorized Bombardier ATV dealer for warranty coverage and assistance.

Carlisle Tire & Wheel Company (generally for Traxter® tires), 23 Windham Boulevard, Aiken, SC 29805. Warranty Information: in USA 1 800 260-7959 in Canada 1 800 265-6155 in Quebec 1 877 997-4999	Warn Industries inc. (for the winches), 12900 SE Capps Road, Clackamas, Oregon 97015-8903 Customer service: in USA 1 800 543-9276 in Canada 1 800 668-6012 in Quebec 1 800 361-9291
---	---

Generally, the Traxter® ATVs are originally equipped with Carlisle tires. If your ATV is equipped with other tires, they are warranted directly by BRP and not by the tire manufacturer.

Use of the product for racing or any other competitive activity, at any point, even by a previous owner, will render this warranty null and void.

2) WARRANTY COVERAGE PERIOD

This warranty will be in effect from the date of delivery the first retail consumer or the date the product is first put into use, whichever occurs first and for a period of:

SIX (6) CONSECUTIVE MONTHS, for private use or commercial use owners.

The repair or replacement of parts or the performance of service under this warranty does not extend the life of this warranty beyond its original expiration date.

3) CONDITIONS TO HAVE WARRANTY COVERAGE

This warranty coverage is available only on 2005 Bombardier ATVs purchased as new and unused by its first owner from a Bombardier dealer authorized to distribute Bombardier ATV products in the country in which the sale occurred ("Bombardier ATV dealer"), and then only after the BRP specified pre-delivery inspection process is completed and documented. Warranty coverage only becomes available upon proper registration of the product by an authorized Bombardier ATV dealer. Moreover, this warranty coverage is only available if the Bombardier ATV is purchased in the country in which the purchaser resides. BRP will not honor this limited warranty to any private use owner or commercial use owner if the preceding conditions have not been met. Such limitations are necessary in order to allow BRP to preserve both the safety of its products, and also that of its consumers and the general public.

Routine maintenance outlined in the Operator's Guide must be timely performed in order to maintain warranty coverage. BRP reserves the right to make warranty coverage contingent upon proof of proper maintenance.

4) WHAT TO DO TO OBTAIN WARRANTY COVERAGE

The customer must notify a servicing Bombardier ATV dealer within two (2) days of the appearance of a defect, and provide it with reasonable access to the product and reasonable opportunity to repair it. The customer must also present to the authorized Bombardier dealer, proof of purchase of the product and must sign the repair/work order prior to starting the repair in order to validate the warranty repair. All parts replaced under this limited warranty become the property of BRP.

5) WHAT BRP WILL DO

BRP's obligations under this warranty are limited to, at its sole discretion, repairing parts found defective under normal use, maintenance and service, or replacing such parts with new genuine Bombardier parts without charge for parts and labor, at any authorized Bombardier ATV dealer during the warranty coverage period.

BRP reserves the right to improve or modify products from time to time without assuming any obligation to modify products previously manufactured.

6) EXCLUSIONS - ARE NOT WARRANTED

- Normal wear and tear;
- Routine maintenance items, tune ups, adjustments;
- Damage caused by failure to provide proper maintenance and/or storage, as described in the Operator's Guide;
- Damage resulting from removal of parts, improper repairs, service, maintenance, modifications or use of parts not manufactured or approved by BRP or resulting from repairs done by a person that is not an authorized servicing Bombardier ATV dealer;
- Damage caused by abuse, abnormal use, neglect or operation of the product in a manner inconsistent with the recommended operation described in the Operator's Guide;

- Damage resulting from accident, submersion, fire, theft, vandalism or any act of God;
- Operation with fuels, oils or lubricants which are not suitable for use with the product (see the Operator's Guide);
- Water or snow ingestion;
- Incidental or consequential damages, or damages of any kind including without limitation towing, storage, telephone, rental, taxi, inconvenience, insurance coverage, loan payments, loss of time, loss of income.

7) LIMITATIONS OF LIABILITY

THIS WARRANTY IS EXPRESSLY GIVEN AND ACCEPTED IN LIEU OF ANY AND ALL OTHER WARRANTIES, EXPRESSED OR IMPLIED, INCLUDING WITHOUT LIMITATION ANY WARRANTY OF MERCHANTABILITY OR FITNESS FOR A PARTICULAR PURPOSE. TO THE EXTENT THAT THEY CANNOT BE DISCLAIMED, THE IMPLIED WARRANTIES ARE LIMITED IN DURATION TO THE LIFE OF THE EXPRESS WARRANTY. INCIDENTAL AND CONSEQUENTIAL DAMAGES ARE EXCLUDED FROM COVERAGE UNDER THIS WARRANTY. SOME STATES/ PROVINCES DO NOT ALLOW FOR THE DISCLAIMERS, LIMITATIONS AND EXCLUSIONS IDENTIFIED ABOVE, AS A RESULT, THEY MAY NOT APPLY TO YOU. THIS WARRANTY GIVES YOU SPECIFIC RIGHTS, AND YOU MAY ALSO HAVE OTHER LEGAL RIGHTS WHICH MAY VARY FROM STATE TO STATE, OR PROVINCE TO PROVINCE.

Neither the distributor, any Bombardier ATV dealer nor any other person has been authorized to make any affirmation, representation or warranty regarding the product, other than those contained in this limited warranty, and if made, shall not be enforceable against BRP.

BRP reserves the right to modify this warranty at any time, being understood that such modification will not alter the warranty conditions applicable to the products sold while this warranty is in effect.

8) TRANSFER

If the ownership of a product is transferred during the warranty coverage period, this warranty shall also be transferred and be valid for the remaining coverage period provided that BRP is notified of such transfer of ownership in the following way:

- a) The former owner contacts BRP (at the phone number provided below) or an authorized Bombardier ATV dealer and gives the coordinates of the new owner; or
- b) BRP or an authorized Bombardier ATV dealer receives a proof that the former owner agreed to the transfer of ownership, in addition to the coordinates of the new owner.

9) CONSUMER ASSISTANCE

- a) In the event of a controversy or a dispute in connection with this limited warranty, BRP suggests that you try to resolve the issue at the dealership level. We recommend discussing the issue with the authorized dealer's service manager or owner.
- b) If the issue has not yet been resolved, please submit your complaint in writing or call the appropriate number below:

In Canada:

BOMBARDIER RECREATIONAL
PRODUCTS INC.
BOMBARDIER ATV
CUSTOMER ASSISTANCE CENTER
VALCOURT, QC, J0E 2L0
Tel : 1 (819) 566-3366

In USA:

BOMBARDIER MOTOR CORPORATION
OF AMERICA BOMBARDIER
ATV CUSTOMER ASSISTANCE CENTER
7575 BOMBARDIER COURT
WAUSAU WI 54401
Tel : 1 (715) 848-4957

* In the USA, products are distributed and serviced by Bombardier Motor Corporation of America.

© 2004 Bombardier Recreational Products Inc. All rights reserved.

® Registered trademark and ™ trademarks of Bombardier Recreational Products Inc. or its affiliates.

† Bombardier is a trademark of Bombardier Inc. used under license.

‡ Carlisle is a trademark of Carlisle Tire & Wheel Company.

††† Warn is a trademark of Warn Industries Inc.

BRP INTERNATIONAL LIMITED WARRANTY: 2005 BOMBARDIER† ATV

1) SCOPE OF THE LIMITED WARRANTY

Bombardier Recreational Products Inc. (BRP)*, warrants its 2005 Bombardier ATVs from defects in material or workmanship for the period and under the conditions described below.

All genuine Bombardier parts and accessories, installed by an authorized Bombardier ATV dealer (as hereinafter defined) at the time of delivery of the 2005 Bombardier ATV, carry the same warranty as that of the ATV.

Use of the product for racing or any other competitive activity, at any point, even by a previous owner, will render this warranty null and void.

2) WARRANTY COVERAGE PERIOD

This warranty will be in effect from the date of delivery the first retail consumer or the date the product is first put into use, whichever occurs first and for a period of:

SIX (6) CONSECUTIVE MONTHS, for private use or commercial use owners.

The repair or replacement of parts or the performance of service under this warranty does not extend the life of this warranty beyond its original expiration date.

3) CONDITIONS TO HAVE WARRANTY COVERAGE

This warranty coverage is available only on 2005 Bombardier ATVs purchased as new and unused by its first owner from a Bombardier dealer authorized to distribute Bombardier ATV products in the country in which the sale occurred ("Bombardier ATV distributor/dealer"), and then only after the BRP specified pre-delivery inspection process is completed and documented. Warranty coverage only becomes available upon proper registration of the product by an authorized Bombardier ATV distributor/dealer. Moreover, this warranty coverage is only available if the Bombardier ATV is purchased in the country in which the purchaser resides. BRP will not honor this limited warranty to any private use owner or commercial use owner if the preceding conditions have not been met. Such limitations are necessary in order to allow BRP to preserve both the safety of its products, and also that of its consumers and the general public.

Routine maintenance outlined in the Operator's Guide must be timely performed in order to maintain warranty coverage. BRP reserves the right to make warranty coverage contingent upon proof of proper maintenance.

4) WHAT TO DO TO OBTAIN WARRANTY COVERAGE

The customer must notify a servicing Bombardier ATV distributor/dealer within two (2) days of the appearance of a defect, and provide it with reasonable access to the product and reasonable opportunity to repair it. The customer must also present to the authorized Bombardier distributor/dealer, proof of purchase of the product and must sign the repair/work order prior to starting the repair in order to validate the warranty repair. All parts replaced under this limited warranty become the property of BRP.

5) WHAT BRP WILL DO

BRP's obligations under this warranty are limited to, at its sole discretion, repairing parts found defective under normal use, maintenance and service, or replacing such parts with new genuine Bombardier parts without charge for parts and labor, at any authorized Bombardier ATV distributor/dealer.

BRP reserves the right to improve or modify products from time to time without assuming any obligation to modify products previously manufactured.

6) EXCLUSIONS - ARE NOT WARRANTED

The following are not warranted under any circumstances:

- Normal wear and tear;
- Routine maintenance items, tune ups, adjustments;
- Damage caused by failure to provide proper maintenance and/or storage, as described in the Operator's Guide;
- Damage resulting from removal of parts, improper repairs, service, maintenance, modifications or use of parts not manufactured or approved by BRP or resulting from repairs done by a person that is not an authorized servicing Bombardier distributor/dealer;
- Damage caused by abuse, abnormal use, neglect or operation of the product in a manner inconsistent with the recommended operation described in the Operator's Guide;
- Damage resulting from accident, submersion, fire, theft, vandalism or any act of God;
- Operation with fuels, oils or lubricants which are not suitable for use with the product (see the Operator's Guide);
- Water or snow ingestion;
- Incidental or consequential damages, or damages of any kind including without limitation towing, storage, telephone, rental, taxi, inconvenience, insurance coverage, loan payments, loss of time, loss of income.

7) LIMITATIONS OF LIABILITY

THIS WARRANTY IS EXPRESSLY GIVEN AND ACCEPTED IN LIEU OF ANY AND ALL OTHER WARRANTIES, EXPRESSED OR IMPLIED, INCLUDING WITHOUT LIMITATION ANY WARRANTY OF MERCHANTABILITY OR FITNESS FOR A PARTICULAR PURPOSE. TO THE EXTENT THAT THEY CANNOT BE DISCLAIMED, THE IMPLIED WARRANTIES ARE LIMITED IN DURATION TO THE LIFE OF THE EXPRESS WARRANTY. INCIDENTAL AND CONSEQUENTIAL DAMAGES ARE EXCLUDED FROM COVERAGE UNDER THIS WARRANTY. SOME STATES/PROVINCES DO NOT ALLOW FOR THE DISCLAIMERS, LIMITATIONS AND EXCLUSIONS IDENTIFIED ABOVE, AS A RESULT, THEY MAY NOT APPLY TO YOU. THIS WARRANTY GIVES YOU SPECIFIC RIGHTS, AND YOU MAY ALSO HAVE OTHER LEGAL RIGHTS WHICH MAY VARY FROM STATE TO STATE, OR PROVINCE TO PROVINCE.

Neither the distributor, any Bombardier ATV dealer nor any other person has been authorized to make any affirmation, representation or warranty regarding the product, other than those contained in this limited warranty, and if made, shall not be enforceable against BRP.

BRP reserves the right to modify this warranty at any time, being understood that such modification will not alter the warranty conditions applicable to the products sold while this warranty is in effect.

8) TRANSFER

If the ownership of a product is transferred during the warranty coverage period, this warranty shall also be transferred and be valid for the remaining coverage period provided BRP or an authorized Bombardier ATV distributor/dealer receives a proof that the former owner agreed to the transfer of ownership, in addition to the coordinates of the new owner.

9) CONSUMER ASSISTANCE

- a) In the event of a controversy or a dispute in connection with this limited warranty, BRP suggests that you try to resolve the issue at the dealership level. We recommend discussing the issue with the authorized dealer's service manager or owner.
- b) If further assistance is required, the distributor's service department should be contacted in order to resolve the matter.
- c) If the matter still remains unresolved then contact BRP by writing to us at the address listed below.

BOMBARDIER RECREATIONAL
PRODUCTS INC.
BOMBARDIER ATV
CUSTOMER ASSISTANCE CENTER
VALCOURT, QC, J0E 2L0
Tel : 1 (819) 566-3366

* In the USA, products are distributed and serviced by Bombardier Motor Corporation of America.

© 2004 Bombardier Recreational Products Inc. All rights reserved.

† Bombardier is a trademark of Bombardier Inc. used under license.

PRIVACY OBLIGATION/DISCLAIMER

We wish to inform you that your coordinates will be used for safety and warranty purposes. Sometimes, we also use the coordinates of our clients to inform them about our products and to present them offers. Should you prefer not to receive information on our product, services and offers, please let us know by writing to the address below.

Also note that, from time to time, carefully selected and trustworthy organizations may be permitted to use the coordinates of our clients to promote quality products and services. If you prefer not to have your name and address released, please let us know by writing to the address below.

Bombardier
Recreational Products Inc.
Warranty Department
75 J.A. Bombardier Street
Sherbrooke, Québec J1L 1W3
Canada
Fax Number: 1 (819) 566-3590

AFFIX
PROPER
POSTAGE

BOMBARDIER
RECREATIONAL PRODUCTS

WARRANTY DEPARTMENT
75, J.A. Bombardier
Sherbrooke, QC
Canada
J1L 1W3

AFFIX
PROPER
POSTAGE

BOMBARDIER
RECREATIONAL PRODUCTS

WARRANTY DEPARTMENT
75, J.A. Bombardier
Sherbrooke, QC
Canada
J1L 1W3

ATV MODEL No. _____

VEHICLE IDENTIFICATION NUMBER (V.I.N.) _____

ENGINE IDENTIFICATION NUMBER (E.I.N.) _____

Owner: _____
NAME

No. STREET APT

CITY STATE/PROVINCE ZIP/POSTAL CODE

Purchase Date _____
YEAR MONTH DAY

Warranty Expiry Date _____
YEAR MONTH DAY

To be completed by the dealer at the time of the sale.

DEALER IMPRINT AREA

Please verify with your dealer to ensure your vehicle has been registered with BRP.

While reading this Operator's Guide, remember that:

 **WARNING**

Indicates a potential hazard that, if not avoided, could result in serious injury or death.



WARNING

THIS VEHICLE CAN BE HAZARDOUS TO OPERATE.

A collision or rollover can occur quickly, even during routine maneuvers such as turning and driving on hills or over obstacles, if you fail to take proper precautions.

SEVERE INJURY OR DEATH can result if you do not follow these instructions:

- **BEFORE YOU OPERATE THIS ATV, READ THIS OPERATOR'S GUIDE AND ALL ON-PRODUCT LABELS.**
- **NEVER OPERATE THIS ATV WITHOUT PROPER INSTRUCTIONS.** Beginners should complete a certified training course.
- **NEVER CARRY A PASSENGER.** You increase your risk of losing control if you carry a passenger.
- **NEVER OPERATE THIS ATV ON A PAVED SURFACE.** You increase your risk of losing control if you operate this ATV on pavement.
- **NEVER OPERATE THIS ATV ON PUBLIC ROADS.** You can collide with another vehicle if you operate this ATV on a public road.
- **ALWAYS WEAR AN APPROVED HELMET,** eye protection, and protective clothing.
- **NEVER CONSUME ALCOHOL OR DRUGS** before or while operating this vehicle.
- **NEVER OPERATE THIS ATV AT EXCESSIVE SPEEDS.** You increase your risk of losing control if you operate this ATV at speeds too fast for the terrain, visibility conditions, or your experience.
- **NEVER ATTEMPT WHEELIES, JUMPS, OR OTHER STUNTS.**

©™ TRADEMARKS OF BOMBARDIER RECREATIONAL PRODUCTS INC. OR ITS AFFILIATES.
*TRADEMARK OF BOMBARDIER INC. USED UNDER LICENSE.
©2004 BOMBARDIER RECREATIONAL PRODUCTS INC. ALL RIGHTS RESERVED. PRINTED IN CANADA.