

BOMBARDIER® ATV

OPERATOR'S GUIDE

2004

INCLUDES
SAFETY,
TRAINING,
VEHICLE AND
MAINTENANCE
INFORMATION

QUEST™
MAX
MAX XT

TRAXTER®
MAX
MAX XT

WARNING

Read this guide thoroughly.
It contains important safety information.
Minimum recommended age:
Operator: 16 years. Passenger: 12 years.
Do not remove this *Operator's Guide* from
the vehicle.



2 1 9 0 0 0 2 7 4

2004 OPERATOR'S GUIDE QUEST MAX/MAX XT TRAXTER MAX/MAX XT

This *Operator's Guide* utilizes the following symbols to emphasize particular information:

 The Safety Alert Symbol indicates a potential personal injury hazard.

 **WARNING** Indicates a potentially hazardous situation which, if not avoided, could result in serious injury or death.

CAUTION: Denotes an instruction which, if not followed, may damage the ATV and/or components.

 **WARNING**

YOUR ATV CAN BE HAZARDOUS TO OPERATE. A collision or rollover can occur quickly, even during routine maneuvers such as turning and driving on hills or over obstacles, if you fail to take proper precautions.

For your safety, understand and follow all the warnings contained in this *Operator's Guide* and the labels on your vehicle. **Failure to follow these warnings can result in SEVERE INJURY OR DEATH.**

Keep this *Operator's Guide* with the vehicle at all times.

 **WARNING**

Disregarding any of the safety precautions and instructions contained in this *Operator's Guide*, *Safety Videocassette* and on-product labels could cause injury including the possibility of death!

All safety documentation should remain with the vehicle at the time of sale.

All content of the *Safety Information section* should be interpreted by the reader as a warning which, if not followed, may result in injury including the possibility of death.

In USA, products are distributed by Bombardier Motor Corporation of America. In Canada, products are distributed by Bombardier Inc.

The following are trademarks of Bombardier Inc. or its subsidiaries:

BOMBARDIER®
TRAXTER®
QUEST™
ROTAX®

BOMBARDIER
RECREATIONAL PRODUCTS



FOREWORD

Congratulations on your purchase of a new Bombardier® recreational vehicle. It is backed by the Bombardier warranty and a network of authorized Bombardier ATV dealers ready to provide the parts, service or accessories you may require.

Your dealer is committed to your satisfaction. He has taken training to perform the initial set-up and inspection of your vehicle as well as completed the final adjustment before you took possession. At delivery, your dealer would have explained the vehicle for the operation, maintenance and safety features of the vehicle. We trust you have taken full advantage of this! If you need more complete servicing information, please ask your dealer.

At delivery, you were also informed of the warranty coverage and completed the Warranty Registration Form which is to be sent to us for processing. In the near future you should be receiving a warranty card which will confirm our receipt of the registration as well as be used for warranty or recall purposes.

You are invited to contact our customer assistance center should you experience problems which cannot be resolved by an authorized Bombardier ATV dealer.

It is understood that this guide may be translated into another language. In the event of any discrepancy, the English version shall prevail. Throughout this document the masculine is used to denote the masculine or feminine.

The information and components/system descriptions contained in this document are correct at the time of publication. Bombardier Inc., however, maintains a policy of continuous improvement of its products without imposing upon itself any obligation to install them on products previously manufactured. Due to late changes, some differences between the manufactured product and the descriptions and/or specifications in this guide may occur. Bombardier Inc. reserves the right at any time to discontinue or change specifications, designs, features, models or equipment without incurring any obligation upon itself.

The illustrations in this document show the typical construction of the different assemblies and may not reproduce the full detail or exact shape of the parts. However, they represent parts that have the same or similar function.

The use of RIGHT and LEFT indications in the text always refers to driving position (when sitting on vehicle).

Specifications are given in the SI metric system with the SAE U.S. equivalent in parenthesis. Where precise accuracy is not required, some conversions are rounded off for easier use.

We recommend genuine Bombardier products for replacement parts and accessories. They've been especially designed for your vehicle and manufactured to meet Bombardier's demanding standards.

A *Shop Manual* can be obtained for complete service and maintenance information and more repair information.

TABLE OF CONTENTS

While reading this *Operator's Guide*, remember that:

WARNING

Indicates a potential hazard that, if not avoided, could result in serious injury or death.

NOTICE	5
INTRODUCTION	6

SAFETY INFORMATION

SPECIAL SAFETY MESSAGES	10
OPERATION WARNINGS	13
SAFETY WARNING	41
RIDING TIPS	42
Clothing	43
Carrying Loads/Passenger	44
Hauling a Trailer.....	44
Working with your Vehicle	44
Recreational Riding	45
Environment.....	45
Design Limitation	46
Off-Highway Operation	46
General Operating and Safety Precautions	46
Uphill Driving.....	47
Downhill Driving	47
Side Hilling	47
Drop-Offs	47
Riding Techniques.....	48
Routine Maintenance	55
HANG TAG	56
LOCATION OF THE IMPORTANT LABELS	57

SAFETY TRAINING

INTRODUCTION	64
Objective	64
Sections Covered	64
Time Required.....	64
SECTION I – GENERAL SAFETY INFORMATION	65
SECTION II – BOMBARDIER 2-UP VEHICLE	
SAFETY VIDEOCASSETTE	67
SECTION III – OPERATOR'S GUIDE REVIEW	69
SECTION IV – HANDS-ON RIDING	70
DRIVING MANEUVER LIST	71

DEALER CHECK LIST	75
Introduction:	75
Section I: General Safety Information	75
Section II: Bombardier 2-Up Vehicle Safety Videocassette.....	75
Section III: <i>Operator's Guide</i> Review.....	75
Section IV: Hands-On Riding	76
Trainee's Scoring Chart.....	78

VEHICLE INFORMATION

HOW TO IDENTIFY YOUR ATV	80
Engine and Vehicle Identification Number Location.....	80

EMISSION REQUIREMENTS	81
------------------------------------	-----------

CONTROLS/INSTRUMENTS/EQUIPMENT	82
---	-----------

1) Throttle Lever	86
2) Front Brake Lever	86
3) Rear Brake Lever	86
4) Brake Lever Lock.....	87
5) Transmission Lever	88
6) Multi-Function Switch	89
7) Indicator Lights Cluster	92
8) Speedometer	94
9) Rear Passenger Grab Handles.....	96
10) Ignition Switch.....	96
11) Choke Knob Lever	97
12) Fuel Tank Cap	98
13) Fuel Gauge	98
14) Fuel Valve	98
15) Rear Brake Pedal	99
16) Rewind Starter Handle	99
17) Footpeg	100
18) Storage Compartment.....	100
19) Tool Box	101
20) Seat Latch	101
21) Front/Rear Cargo Racks.....	102
22) Air Duct	102
23) Trailer Hitch	102
24) Radiator Cap.....	102
25) 12-Volt Power Outlet.....	103
26) Fuses.....	103
27) Winch	103
28) Winch Control Switch.....	103
29) Fairlead	104

LIQUIDS.....	105
---------------------	------------

Fuel	105
Engine/Transmission Oil	105
Engine Coolant.....	107
Brake Fluid	109
Battery	110

BREAK-IN PERIOD	111
------------------------------	------------

Engine	111
Belt.....	111
10-Hour Inspection.....	111

PRE-OPERATION CHECK	112
OPERATING INSTRUCTIONS	113
General	113
Initial Cold Starting	113
Warm Engine Starting	114
Emergency Manual Starting	114
Stopping the Engine	115
Shifting the Transmission	115
Winch Operation	116
SPECIAL PROCEDURES	117
Flooded Engine	117
Engine Overheat	117
Turn Over	117
ATV Immersion	118
Post-Operation Care	118
Emergency Shifter	118
Storage and Preseason Preparation	119
CARGO AND TRANSPORTATION	120
Cargo	120
Transportation	121

MAINTENANCE INFORMATION

MAINTENANCE CHART	124
MAINTENANCE	126
Engine/Transmission	126
Carburetor	131
Air Intake System	131
Electrical	132
Drive Train	136
Steering System	137
Suspension	139
Brake	140
Body/Frame	141
TROUBLESHOOTING	143
SPECIFICATIONS	146
SI METRIC INFORMATION GUIDE	154

WARRANTY

BOMBARDIER LIMITED WARRANTY NORTH AMERICA	156
BOMBARDIER INTERNATIONAL LIMITED WARRANTY	159
FREQUENTLY ASKED QUESTIONS	162
PRIVACY OBLIGATIONS/DISCLAIMER	164
CHANGE OF ADDRESS/OWNERSHIP	165

NOTICE

This *Operator's Guide* has been prepared to acquaint the owner/operator of a new vehicle with the various vehicle controls, maintenance and safe operating instructions. It is indispensable for the proper use of the product.

This *Operator's Guide* uses the following symbols.

WARNING

Indicates a potentially hazardous situation which, if not avoided, could result in serious injury or death.

CAUTION: Denotes an instruction which, if not followed, could severely damage vehicle components.

NOTE: Indicates supplementary information needed to fully complete an instruction.

Although the mere reading of such information does not eliminate the hazard, the understanding and application of the information will promote the correct use of this vehicle.

To fully appreciate the pleasures, enjoyment and excitement of using this vehicle, there are some basic rules that **MUST** be observed and followed by any user.

INTRODUCTION

Your dealer should have provided you with some basic information on the particular controls and features of your new vehicle. Please take the time to study this *Operator's Guide* and all on-product warning labels as well as the *Safety Videocassette* that came with this vehicle. They more completely describe what you should know about this vehicle before riding it.

Whether you are a new user or an experienced rider, it is important for your personal safety as well as passenger safety that you know the controls and features of this vehicle. Equally important is knowing how to properly ride.

Irrespective of your age, experience or state regulations, it is always prudent for you or any other person who may ride your vehicle, to take an approved safe riding course. Please check with your dealer or local authorities for availability in your area. If you are a completely new rider, this should be done before your first ride. Your instructor should be able to provide advice on local conditions and safe riding practices particular to the area.

Riding conditions vary from place to place. Each is subject to weather conditions which may radically change from time to time and from season to season. Riding on sand is different than riding on snow or through forests or marshes. Each location may require a greater degree of awareness and skill may not be suitable with a passenger. Show good judgement. Always proceed with caution. Please do not take any unnecessary risks that could leave you or your passenger stranded or possibly injured.

The vehicle handling, stability and braking distance may be affected when riding with a passenger. Safely reduce speed when riding with a passenger. Allow greater distance for braking.

The contents of this *Operator's Guide* provide riding information which has been proven reliable by other users. They are not intended as a definitive means of avoiding accidents. How you apply this information, coupled with your mental and physical condition, the particular terrain hazard and your risk acceptance level will have an effect on your riding experience. Have fun... and ride responsibly.

This *Operator's Guide* has been prepared to acquaint the owner/operator of a new vehicle with the various vehicle controls, maintenance and safe operating instructions. They are indispensable for the proper use of the product.

We would be pleased to receive any comments on the content and format of this *Operator's Guide*, the *Safety Videocassette* or on-product warnings labels.

WARNING

Operator:

A person under 16 years old should never operate this vehicle.

Never carry more than one passenger on this vehicle.

The operator is responsible for the safety of the passenger. In doubt, disembark the passenger before executing any maneuver.

The vehicle handling, stability and braking distance may be affected when riding with a passenger. Safely reduce speed when riding with a passenger. Allow greater distance for braking.

Always practice the maneuvers described in this *Operator's Guide* without and with passenger.

Inform the passenger concerning the basic rules for a safe ride.

Passenger:

The passenger should be 12 years old or more and must be capable of keeping his feet on footrests and his hands on grab handles at all times when he is seated on this vehicle.

Passenger should always hold on to rear passenger grab handles. Never hold on to the operator.

Passenger should pay attention to vehicle and operator movements.

Passenger should always wear the appropriate protective gear, including an approved helmet with a rigid chin guard.

Passenger should always keep hands and feet in the proper place during operation.

Never get up during vehicle operation. An excessive movement could cause loss of control.

Failure to follow the recommendations here could cause changes in vehicle handling which could lead to an accident resulting in severe injuries including the possibility of death for the passenger and/or the operator.



SAFETY INFORMATION

SPECIAL SAFETY MESSAGES

THIS VEHICLE IS NOT A TOY AND CAN BE HAZARDOUS TO OPERATE.

This vehicle handles differently from other vehicles including motorcycles and cars. A collision or rollover can occur quickly, even during routine maneuvers such as turning and driving on hills or over obstacles, if you fail to take proper precautions.

SEVERE INJURY OR DEATH can result if you do not follow these instructions:

- ⚠ Read this *Operator's Guide* and all on-product warnings labels carefully and follow the operating procedures described. Watch and pay attention to the *Safety Videocassette* before operation.
- ⚠ Never operate this vehicle without proper instruction.
- ⚠ Always follow this age recommendation: A person under 16 years old should never operate this vehicle.
- ⚠ Never carry more than one passenger on this vehicle. This passenger should be 12 years old or more and must be capable of keeping his feet on footrests and his hands on grab handles at all times when he is seated on the vehicle.
- ⚠ The vehicle handling, stability and braking distance may be affected when riding with a passenger. Safely reduce speed when riding with a passenger. Allow greater distance for braking.
- ⚠ Never operate this vehicle on any paved surfaces, including sidewalks, driveways, parking lots and streets.
- ⚠ Never operate this vehicle on any public street, road or highway, even a dirt or gravel one.
- ⚠ Never take place on this vehicle without wearing an approved helmet that fits properly. The operator and the passenger should also wear eye protection (goggles or face shield), gloves, boots, long sleeved shirt or jacket, and long pants. The passenger should have an approved helmet including a rigid chin guard.
- ⚠ Never consume alcohol or drugs before or while riding this vehicle.
- ⚠ Never operate at excessive speeds. Always go at a speed that is proper for the terrain, visibility, and operating conditions, and your experience.
- ⚠ Never attempt wheelies, jumps, or other stunts.
- ⚠ Always inspect your vehicle each time you use it to make sure it is in safe operating condition. Always follow the inspection and maintenance procedures and schedules described in this *Operator's Guide*.
- ⚠ The operator and the passenger must always keep both hands on the handlebars or grab handles and both feet on the footpegs of the vehicle during operation.
- ⚠ Always go slowly and be extra careful when operating on unfamiliar terrain. Always be alert to changing terrain conditions when operating this vehicle. Always keep in mind that you are carrying a passenger.

- ⚠ Never operate on excessively rough, slippery or loose terrain until you have learned and practiced the skills necessary to control this vehicle on such terrain. Always be especially cautious on these kinds of terrain. Always keep in mind that you are carrying a passenger.
- ⚠ Always follow proper procedures for turning as described further in this *Operator's Guide*. Practice turning at low speeds before attempting to turn at faster speeds. Do not turn at excessive speed. Carrying a passenger may affect the stability and the handling of the vehicle.
- ⚠ Never operate this vehicle on hills too steep for the vehicle or for your abilities. Do not forget, the operator is responsible for the safety of the passenger. In doubt, disembark the passenger before climbing hill. Always remember that the vehicle handling, stability and braking distance may be affected when riding with a passenger.
- ⚠ Always follow proper procedures for climbing hills as described further in this *Operator's Guide*. Check the terrain carefully before you start up any hill. Never climb hills with excessively slippery or loose surfaces. Shift your weight forward. Never open the throttle suddenly or make sudden gear changes. Never go over the top of any hill at high speed. Always keep in mind that you are carrying a passenger.
- ⚠ Always follow proper procedures for going down hills and for braking on hills as described further in this *Operator's Guide*. Check the terrain carefully before you start down any hill. Shift your weight backward. Never go down a hill at high speed. Avoid going down a hill at an angle that would cause the vehicle to lean sharply to one side. Go straight down the hill where possible. Always keep in mind that you are carrying a passenger.
- ⚠ Always follow proper procedures for crossing the side of a hill as described further in this *Operator's Guide*. Avoid hills with excessively slippery or loose surfaces. Shift your weight to the uphill side of the vehicle. Never attempt to turn the vehicle around on any hill until you have mastered the turning technique described in this *Operator's Guide* on level ground. Avoid crossing the side of a steep hill if possible. Always keep in mind that you are carrying a passenger.
- ⚠ Always use proper procedures if you stall or roll backwards when climbing a hill. To avoid stalling, use proper gear and maintain a steady speed when climbing a hill. If you stall or roll backwards, follow the special procedure for braking described in this *Operator's Guide*. First, disembark the passenger then the operator. Dismount on the uphill side or to a side if pointed straight uphill. Turn the vehicle around and remount, following the procedure described further in this *Operator's Guide*.
- ⚠ Always check for obstacles before operating in a new area. Never attempt to operate over large obstacles, such as large rocks or fallen trees. Always follow proper procedures when operating over obstacles as described further in this *Operator's Guide*. Do not forget, the operator is responsible for the safety of the passenger. In doubt, disembark the passenger to get through the obstacles.
- ⚠ Always be careful when skidding or sliding. Never attempt with a passenger; overturn or passenger ejection may occur. Learn to safely control skidding or sliding by practicing at low speeds and on level smooth terrain. On extremely slippery surfaces, such as ice, go slowly and be very cautious in order to reduce the chance of skidding out of control.

- ⚠ Never operate this vehicle in fast flowing water or in water deeper than that specified in this *Operator's Guide*. Remember that wet brakes may have reduced stopping ability. Test your brakes after leaving water. If necessary, apply them several times to let friction dry out the pads. The vehicle braking distance may be affected when riding with a passenger. Safely reduce speed when riding with a passenger. Allow greater distance for braking.
- ⚠ Always be sure there are no obstacles or people behind the vehicle when you operate in reverse. When it is safe to proceed in reverse, go slowly. Take account that the passenger can obstruct your view.
- ⚠ Always use the size and type tires specified further in this *Operator's Guide*. Always maintain proper tire pressure as described further in this *Operator's Guide*.
- ⚠ Never modify this vehicle through improper installation or use of accessories. Only use approved Bombardier accessories. Do not install passenger seats or use the racks to carry more than one passenger.
- ⚠ Never exceed the stated load limits for this vehicle including operator and passenger, all other loads and added accessories. Cargo should be properly distributed and securely attached. Reduce speed and follow instructions in this manual for carrying cargo or pulling a trailer. Allow greater distance for braking.
- ⚠ Do not forget, the operator is responsible for the safety of the passenger. If in doubt, disembark the passenger. Always practice the maneuvers described in this *Operator's Guide* without and with passenger. Always remember that the vehicle handling, stability and braking distance may be affected when riding with a passenger. Safely reduce speed when riding with a passenger. Allow greater distance for braking. In some situations, this vehicle can be used easily with the operator alone but not necessarily with a passenger.

OPERATION WARNINGS

While reading this *Operator's Guide*, remember that:

WARNING

Indicates a potential hazard that, if not avoided, could result in serious injury or death.

NOTE: The following illustrations are general representations only. Your model may differ.

WARNING



V00A0AQ

POTENTIAL HAZARD

Operating this vehicle without proper instruction.

WHAT CAN HAPPEN

The risk of an accident is greatly increased if the operator does not know how to operate this vehicle properly in different situations and on different types of terrain with or without passenger.

HOW TO AVOID THE HAZARD

Beginning and inexperienced operators should complete the training course offered by Bombardier Inc. They should then regularly practice the skills learned in the course and the operating techniques described in this *Operator's Guide*.

 **WARNING**



V00A1AQ

POTENTIAL HAZARD

Failure to follow the age recommendations for this vehicle.

WHAT CAN HAPPEN

A lack of respect for this age recommendation can lead to severe injury or death of the child.

Even though a child may be within the age group for which this vehicle is recommended, he may not have the skills, abilities, or judgment needed to operate this vehicle safely and may be involved in a serious accident.

HOW TO AVOID THE HAZARD

No one under 16 should operate this Bombardier vehicle.

⚠ WARNING



V00A1BQ

POTENTIAL HAZARD

Failure to follow the age recommendations for the passenger.

WHAT CAN HAPPEN

A child, under 12, may not have the ability needed to ride safely and may be involved in a serious accident.

HOW TO AVOID THE HAZARD

No one under 12 should be riding on this vehicle.

⚠ WARNING

POTENTIAL HAZARD

Failure to respect the physical limitations of the passenger.

WHAT CAN HAPPEN

A passenger that cannot completely lean his feet on footrests can be ejected when riding on uneven terrain.

HOW TO AVOID THE HAZARD

The passenger must be able to completely lean his feet on the footrests and his hands on grab handles at all time when seated on the vehicle.

WARNING



V00A1CQ

POTENTIAL HAZARD

Carrying more than one passenger on this vehicle.

WHAT CAN HAPPEN

Carrying more than one passenger reduces your ability to balance and control this vehicle.

Could cause an accident, resulting in harm to you and/or your passengers.

HOW TO AVOID THE HAZARD

Never carry more than one passenger. The long seat is on this vehicle to allow the operator and the passenger to shift position as needed during operation.

WARNING



V00A1DQ

POTENTIAL HAZARD

Operating this vehicle on paved surfaces.

WHAT CAN HAPPEN

The tires are designed for off-road use only, not for use on pavement. Paved surfaces may seriously affect handling and control of the vehicle, and may cause the vehicle to go out of control.

HOW TO AVOID THE HAZARD

Never operate this vehicle on any paved surfaces, including sidewalks, driveways, parking lots and streets.

WARNING



V00A1EQ

POTENTIAL HAZARD

Operating this vehicle on public streets, roads or highways.

WHAT CAN HAPPEN

You can collide with another vehicle.

HOW TO AVOID THE HAZARD

Never operate this vehicle on any public street, road or highway, even a dirt or gravel one. In many states it is illegal to operate this vehicle on public streets, roads and highways.

WARNING



V00A1FQ

POTENTIAL HAZARD

Riding this vehicle without wearing an approved helmet, eye protection and protective clothing. Passenger should also have an approved helmet with a rigid chin guard.

WHAT CAN HAPPEN

The following items concern the operator and the passenger:

- riding without an approved helmet increases the chances of a severe head injury or death in the event of an accident
- riding without eye protection can result in an accident and increases the chances of a severe injury in the event of an accident
- riding without protective clothing increases the chances of severe injury in the event of an accident.

HOW TO AVOID THE HAZARD

Always wear an approved helmet that fits properly. You should also wear:

- eye protection (goggles or face shield)
- rigid chin guard (recommended for the passenger)
- gloves and boots
- long sleeved shirt or jacket
- long pants.

WARNING



V00A07Q

POTENTIAL HAZARD

Riding this vehicle after consuming alcohol or drugs.

WHAT CAN HAPPEN

- Could cause the passenger to fall off.
- Could seriously affect your judgment.
- Could cause you to react more slowly.
- Could affect your balance and perception.
- Could result in an accident or death of passenger and/or operator.

HOW TO AVOID THE HAZARD

The operator and the passenger should never consume alcohol or drugs before or while riding this vehicle.

WARNING

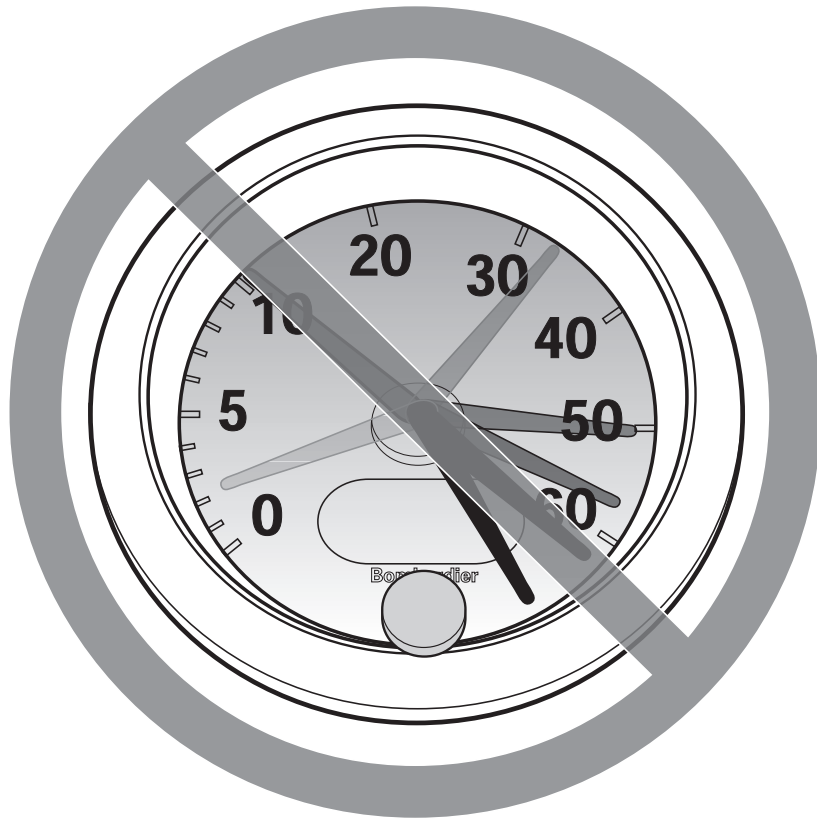

V00A08Q

POTENTIAL HAZARD

Operating this vehicle at excessive speeds.

WHAT CAN HAPPEN

Increases your chances of losing control of the vehicle, which can result in an accident.

HOW TO AVOID THE HAZARD

Always travel at a speed which is proper for the terrain, visibility and operating conditions, and your experience.

The vehicle handling, stability and braking distance may be affected when riding with a passenger. Safely reduce speed when riding with a passenger. Allow greater distance for braking.

WARNING



V00A1GQ

POTENTIAL HAZARD

Attempting wheelies, jumps and other stunts.

WHAT CAN HAPPEN

Increases the chance of an accident, for the operator and the passenger, including an overturn.

HOW TO AVOID THE HAZARD

Never attempt stunts, such as wheelies or jumps. Do not try to show off.

WARNING

POTENTIAL HAZARD

Failure to inspect the vehicle before operating.
Failure to properly maintain the vehicle.

WHAT CAN HAPPEN

Increases the possibility of an accident or equipment damage.

HOW TO AVOID THE HAZARD

Always inspect your vehicle each time you use it to make sure the vehicle is in safe operating condition.

Always follow the inspection and maintenance procedures and schedules described further in this *Operator's Guide*.

WARNING

POTENTIAL HAZARD

Riding on frozen waterways.

WHAT CAN HAPPEN

Severe injury or death can result if the vehicle and/or operator and/or passenger break through the ice.

HOW TO AVOID THE HAZARD

Never ride this vehicle on a frozen surface before you are sure the ice is thick enough and sound enough to support the vehicle and its load, as well as the force that is created by a moving vehicle.

WARNING



V00A1HQ

POTENTIAL HAZARD

Removing hands from handlebars for the operator and from grab handles for the passenger, or feet from the footrests during operation.

WHAT CAN HAPPEN

Removing even one hand or foot can reduce your ability to control the vehicle or could cause you to lose your balance and fall off the vehicle. If you remove a foot from the footrests, your foot or leg may come into contact with the rear wheels, which could injure you or cause an accident.

HOW TO AVOID THE HAZARD

Operator and passenger must always keep both hands on the handlebars or on grab handles and both feet on the footrests during vehicle operation.

WARNING

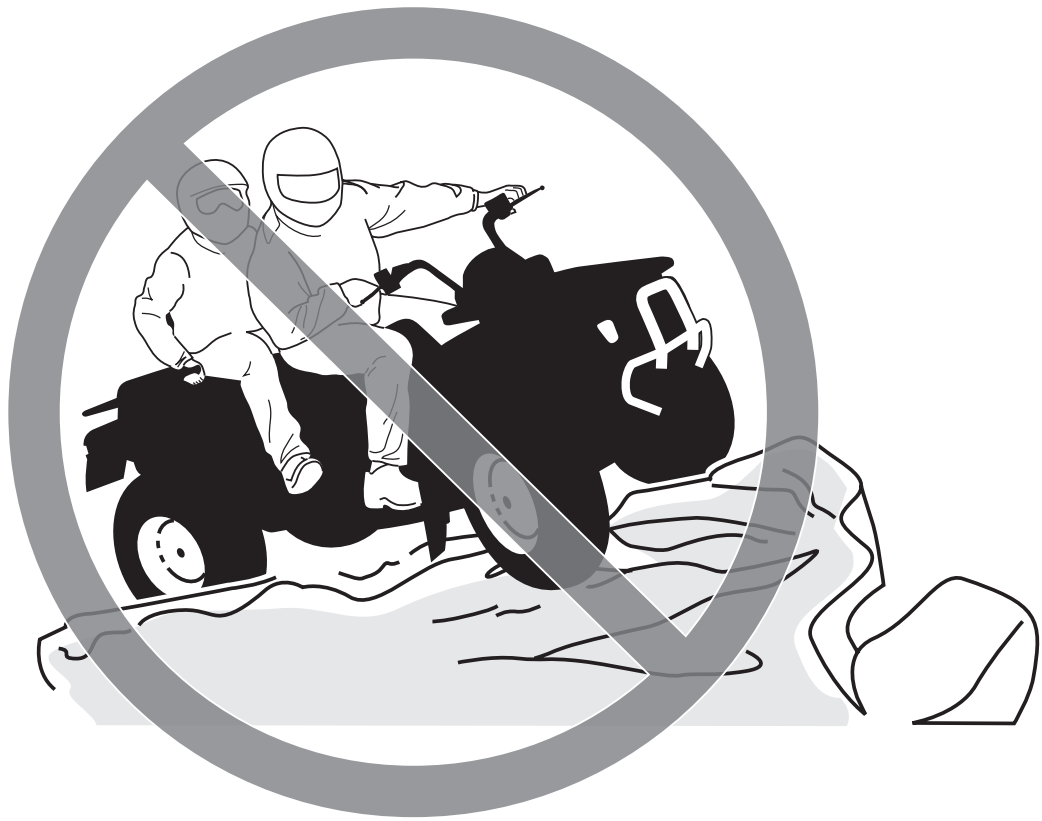

V00A11Q

POTENTIAL HAZARD

Failure to use extra care when operating this vehicle on unfamiliar terrain.

WHAT CAN HAPPEN

You can come upon hidden rocks, bumps, or holes, without enough time to react.

Could result in the vehicle overturning, passenger ejection or loss of control.

HOW TO AVOID THE HAZARD

Go slowly and be extra careful when operating on unfamiliar terrain.

Always be alert to changing terrain conditions when operating the vehicle.

Do not forget, the operator is responsible for the safety of his passenger. Safely reduce speed when riding with a passenger.

WARNING



V00A1JQ

POTENTIAL HAZARD

Failure to use extra care when operating on excessively rough, slippery or loose terrain.

WHAT CAN HAPPEN

Could cause loss of traction or vehicle control, which could result in an accident, including an overturn or passenger ejection.

HOW TO AVOID THE HAZARD

Do not operate on excessively rough, slippery or loose terrain until you have learned and practiced the skills necessary to control this vehicle on such terrain.

Always be especially cautious on these kinds of terrain.

Do not forget, the operator is responsible for the safety of the passenger. In doubt, disembark the passenger before operating on these terrains.

WARNING



V00A1KQ

POTENTIAL HAZARD

Turning improperly.

WHAT CAN HAPPEN

Vehicle could go out of control, causing a collision, an overturn or a passenger ejection.

HOW TO AVOID THE HAZARD

Always follow proper procedures for turning as described further in this *Operator's Guide*. Practice turning at low speeds before attempting to turn at faster speeds.

Do not forget, the operator is responsible for the safety of the passenger. Never perform this maneuver with a passenger. Always remember that the vehicle handling, stability and braking distance may be affected when riding with a passenger.

Do not turn at excessive speed.

WARNING



V00A1LQ

POTENTIAL HAZARD

Operating on excessively steep hills.

WHAT CAN HAPPEN

The vehicle can overturn more easily on extremely steep hills than on level surfaces or small hills.

HOW TO AVOID THE HAZARD

Never operate this vehicle on hills too steep for the vehicle or for your abilities.

Practice, without and with passenger, on smaller hills before attempting larger hills.

Always remember that, even if this vehicle can climb some steep hills, it is not recommended to climb such hills with a passenger; always disembark him before attempting this maneuver. Show good judgement.

WARNING



V00A1MQ

POTENTIAL HAZARD

Climbing hills improperly.

WHAT CAN HAPPEN

Could cause loss of control, passenger ejection or cause vehicle to overturn.

HOW TO AVOID THE HAZARD

Always follow proper procedures for climbing hills as described further in this *Operator's Guide*.

Always check the terrain carefully before you start up any hill. Do not forget, the operator is responsible for the safety of the passenger. In doubt, disembark the passenger before climbing hill. Always remember that the vehicle handling, stability and braking distance may be affected when riding with a passenger.

Never climb hills with excessively slippery or loose surfaces.

Shift operator and passenger weight forward.

Never open the throttle suddenly or make sudden gear changes. The vehicle could flip over backwards.

Never go over the top of any hill at high speed. An obstacle, a sharp drop, or another vehicle or person could be on the other side of the hill.

WARNING



V00A1NQ

POTENTIAL HAZARD

Going down a hill improperly.

WHAT CAN HAPPEN

Could cause loss of control, passenger ejection or cause vehicle to overturn.

HOW TO AVOID THE HAZARD

Always follow proper procedures for going down hills as described further in this *Operator's Guide*. **NOTE:** A special technique is required when braking as you go down a hill.

Always check the terrain carefully before you start down any hill. Do not forget, the operator is responsible for the safety of the passenger. In doubt, disembark the passenger before climbing hill. Always remember that the vehicle handling, stability and braking distance may be affected when riding with a passenger.

Shift operator and passenger weight backward. The passenger must hold the grab handles firmly.

Never go down a hill at high speed.

Avoid going down a hill at an angle which would cause the vehicle to lean sharply to one side. Go straight down the hill where possible.

WARNING



V00A10Q

POTENTIAL HAZARD

Improperly crossing hills or turning on hills.

WHAT CAN HAPPEN

Could cause loss of control, passenger ejection or cause vehicle to overturn.

HOW TO AVOID THE HAZARD

Never attempt this maneuver when the passenger is on board. Always disembark him before executing.

Never attempt to turn the vehicle around on any hill until you have mastered the turning technique as described further in this *Operator's Guide* on level ground. Be very careful when turning on any hill.

Avoid crossing the side of a steep hill if possible.

When crossing the side of a hill:

Always follow proper procedures as described further in this *Operator's Guide*.

Avoid hills with excessively slippery or loose surfaces.

Shift your weight to the uphill side of the vehicle.

WARNING

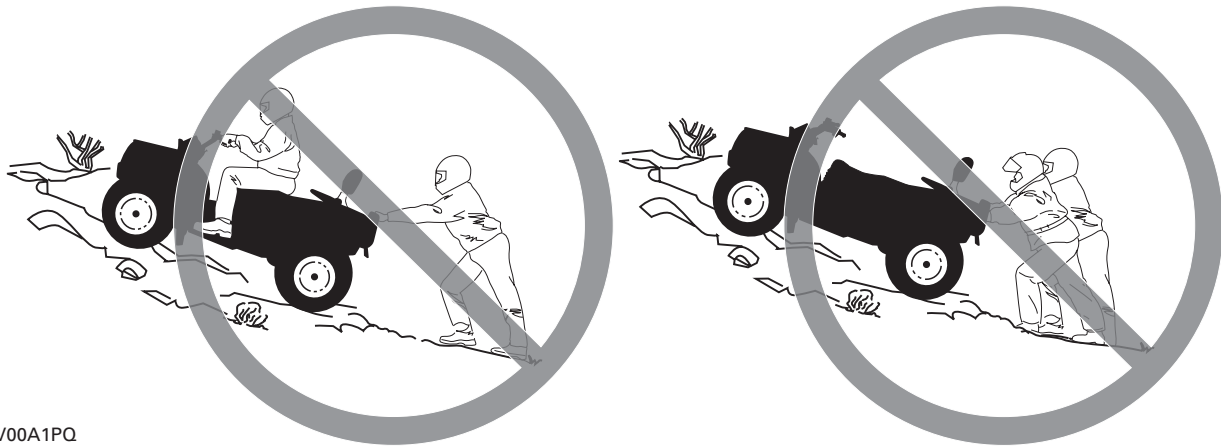

V00A1PQ

POTENTIAL HAZARD

Stalling, rolling backwards or improperly dismounting while climbing a hill.

WHAT CAN HAPPEN

Could result in vehicle overturning.

HOW TO AVOID THE HAZARD

Use proper gear and maintain steady speed when climbing a hill.

If you lose all forward speed:

Keep operator and passenger weight uphill. Never open the throttle suddenly or make sudden gear changes. The vehicle could flip over backwards.

Apply the brakes.

Lock parking brake after you are stopped.

First, disembark the passenger, then you. Dismount on uphill side, or to a side if pointed straight uphill.

If you begin rolling backwards:

Keep operator and passenger weight uphill. Never open the throttle suddenly or make sudden gear changes. The vehicle could flip over backwards.

Never apply the rear brake while rolling backwards.

Apply the front brake gradually.

When fully stopped, apply rear brake as well and lock parking brake.

First, disembark the passenger, then you. Dismount on uphill side, or to a side if pointed straight uphill.

Turn the vehicle around and remount, following the procedure described further in this *Operator's Guide*.

WARNING



V00A1QQ

POTENTIAL HAZARD

Improperly operating over obstacles.

WHAT CAN HAPPEN

Could cause loss of control, passenger ejection or a collision.

Could cause the vehicle to overturn.

HOW TO AVOID THE HAZARD

The operator is responsible for the safety of the passenger. In doubt, disembark the passenger before riding over obstacles. Always remember that the vehicle handling and stability may be affected when riding with a passenger.

Before operating in a new area, check for obstacles.

Never attempt to ride over large obstacles, such as large rocks or fallen trees.

When you go over obstacles, always follow proper procedures as described further in this *Operator's Guide*.

WARNING



V00A1RQ

POTENTIAL HAZARD

Skidding or sliding improperly.

WHAT CAN HAPPEN

You may lose control of this vehicle.

You may also regain traction unexpectedly, which may cause the vehicle to overturn or passenger ejection.

HOW TO AVOID THE HAZARD

Never attempt this maneuver with passenger. Always remember that this vehicle handling and stability may be affected when riding with a passenger.

Learn to safely control skidding or sliding by practicing at low speeds and on level smooth terrain.

On extremely slippery surfaces, such as ice, go slowly and be very cautious in order to reduce the chance of skidding or sliding out of control.

WARNING



V00A1SQ

POTENTIAL HAZARD

Operating this vehicle through deep or fast flowing water.

WHAT CAN HAPPEN

Tires may float, causing loss of traction and loss of control, which could lead to an accident.

HOW TO AVOID THE HAZARD

Never operate this vehicle in fast flowing water or in water deeper than that specified further in this *Operator's Guide*.

Check water depth and current before you attempt to cross any water. Water should not go above footrests.

Remember that wet brakes may have reduced stopping ability. Test your brakes after leaving water. If necessary, apply them several times to let friction dry out the pads. Do not forget, allow greater distance for braking when you ride with a passenger.

WARNING



V00A1TQ

POTENTIAL HAZARD

Improperly operating in reverse.

WHAT CAN HAPPEN

You could hit an obstacle or person behind the vehicle, resulting in serious injury.

HOW TO AVOID THE HAZARD

When you select reverse gear, make sure there are no obstacles or people behind the vehicle. When it is safe to proceed, go slowly. Take account that the passenger can obstruct your view.

WARNING



V00A00Q

POTENTIAL HAZARD

Operating this vehicle with improper tires, or with improper or uneven tire pressure.

WHAT CAN HAPPEN

Use of improper tires on this vehicle, or operation of this vehicle with improper or uneven tire pressure, may cause loss of control, and increases the risk of an accident.

HOW TO AVOID THE HAZARD

Always use the size and type of tires specified further in this *Operator's Guide* for this vehicle.

Always maintain proper tire pressure as described further in this *Operator's Guide*.

WARNING



V00A26Q

POTENTIAL HAZARD

Operating this vehicle with improper modifications.

WHAT CAN HAPPEN

Improper installation of accessories or modification of this vehicle may cause changes in handling which in some situations could lead to an accident.

HOW TO AVOID THE HAZARD

Never modify this vehicle through improper installation or use of accessories. All parts and accessories added to this vehicle should be approved by Bombardier and should be installed and used according to instructions. If you have questions, consult an authorized Bombardier ATV dealer.

Do not install passenger seats or use the racks to carry more than one passenger.

WARNING



V00A1UQ

POTENTIAL HAZARD

Overloading this vehicle or carrying or towing cargo improperly.

WHAT CAN HAPPEN

Could cause changes in vehicle handling which could lead to an accident.

HOW TO AVOID THE HAZARD

Never exceed the stated load capacity for this vehicle including operator and passenger, as well as other loads and added accessories.

Cargo should be properly distributed and securely attached.

Reduce speed when carrying cargo or pulling a trailer. Allow greater distance for braking.

Always follow the instructions in this *Operator's Guide* for carrying cargo or pulling a trailer.

WARNING



V03M01Q

POTENTIAL HAZARD

Transporting inflammable or dangerous material can lead to explosions.

WHAT CAN HAPPEN

This can cause serious injury or death.

HOW TO AVOID THE HAZARD

Never transport inflammable or dangerous material.

While reading this *Operator's Guide*, remember that:

WARNING

Indicates a potential hazard that, if not avoided, could result in serious injury or death.

SAFETY WARNING

To fully appreciate the pleasures and excitement of riding this vehicle, there are some basic rules and tips that you should follow. Some may be new to you while others may be common sense or obvious. Irrespective, we ask that you take a few minutes to read this *Operator's Guide* completely before you operate this vehicle.

Bombardier does not recommend that anyone under the age of 16 to drive this vehicle. The passenger should be 12 years old or more and must be able to keep his feet on the footrests and his hands on the grab handles at all times when he is seated on the vehicle. For the child's safety, we strongly recommend you also follow and enforce this recommendation. You are the sole judge of a rider's capability to understand the risks and operate a vehicle safely.

Persons with cognitive or physical impairments or who are high risk takers have an increased exposure to overturns or collisions which may result in injury including death.

Become completely familiar with the operational controls and the general operation of the vehicle before venturing into off road conditions. Practice driving in a suitable area free of hazards and feel the response of each control. Drive at low speeds. Higher speeds require greater experience, knowledge and suitable riding conditions.

The vehicle handling, stability and braking distance will be affected when riding with a passenger. Safely reduce speed when riding with a passenger. Allow greater distance for braking.

Not all vehicles are the same. Each has its own unique performance characteristics, controls and features. Each will ride and handle differently.

Never assume that the vehicle will go everywhere safely. Sudden changes in terrain caused by holes, depressions, banks, softer or harder "ground" or other irregularities may cause the vehicle to topple or become unstable. To avoid this, slow down and always observe the terrain ahead. If the vehicle does begin to topple or tipover, it is usually the best advice to immediately get off... AWAY from the direction of the tipover!

RIDING TIPS

WARNING

The pre-operation check is very important prior to operating the vehicle. Always check the proper operation of critical controls, safety features and mechanical components before starting. If not done, severe injury or death might occur.

Before using this vehicle, the operator should always:

- a) Disengage the parking brake.
- b) Check the steering operation.
- c) Test throttle operation.
- d) Check brake functions.
- e) Check engine stop switch function.
- f) Verify operation and cleanliness of headlamp and taillight.
- g) Verify fuel and oil levels.
- h) Inspect tires and wheel rims for excessive wear or damage.
- i) Check tire air pressure.
- j) Secure all cargo and storage compartments.
- k) Check backrest condition.
- l) Check passenger grab handles condition.
- m) Educate the passenger concerning the basic rules for a safe ride.

Proceed only if all items are satisfactory.

Clothing

Actual weather conditions should help you decide how to dress. However, it is important that the operator and the passenger always wear the appropriate protective clothing and apparel, including an approved helmet, eye protection, boots, gloves, long sleeved shirt and pants. The passenger should have an approved helmet including a rigid chin guard. This type of clothing will provide you protection from some of the minor hazards you may encounter en route. Operator and passenger must never wear loose clothing such as a scarf that may get entangled in the vehicle or on tree branches and shrubs. Depending on conditions, antifogging goggles or sun glasses may be required. Sun glasses should only be worn during the daytime. Different colored lenses available for goggles or glasses help you distinguish terrain variations.

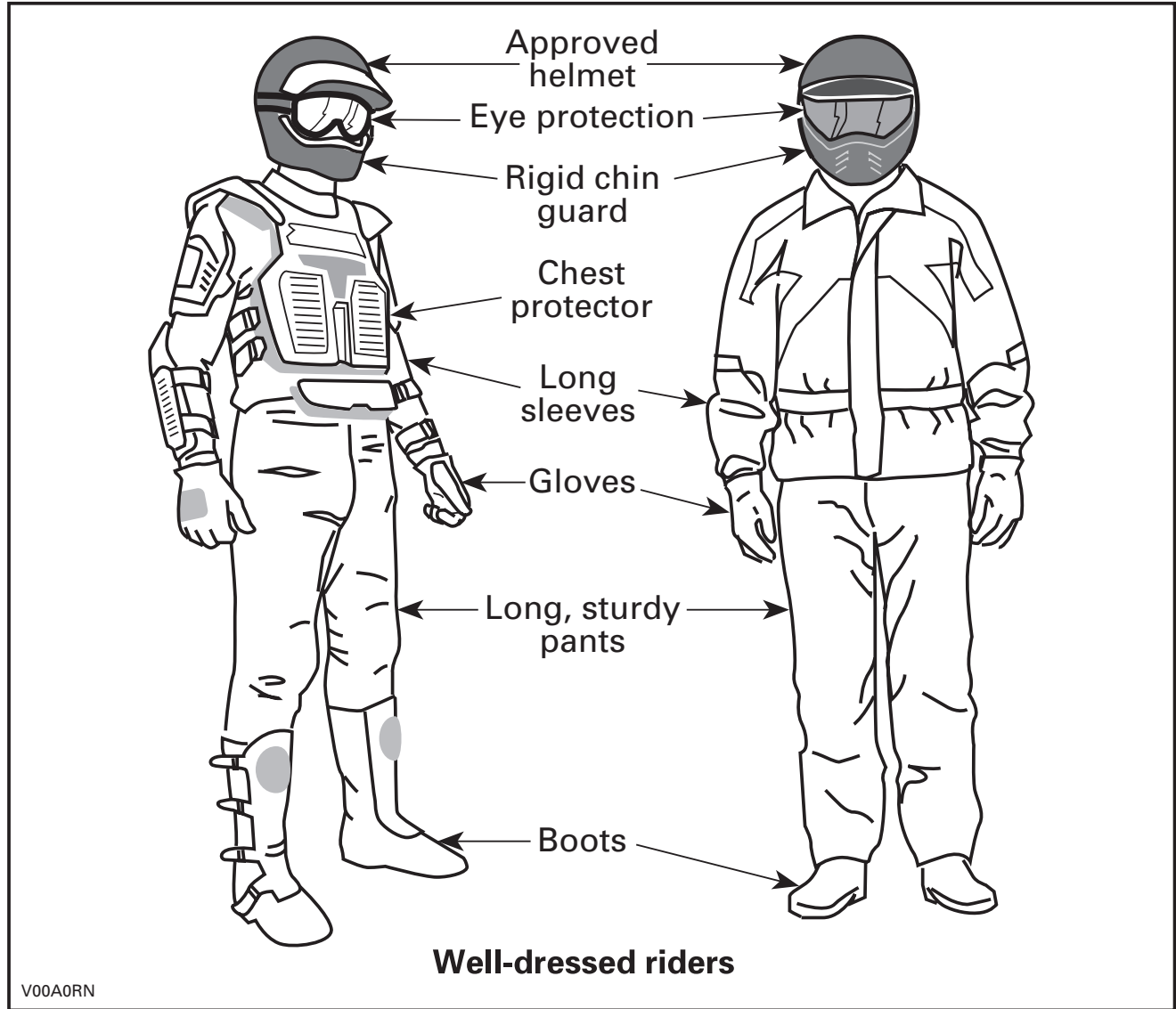

Carrying Loads/Passenger

Any load carried on the vehicle's carrying rack(s) will affect the stability and control of the vehicle. For this reason, do not exceed the load limits of the vehicle manufacturer. Always make sure the load is secured and cannot interfere with your proper control. Always be aware that the "load" may slide or fall off and create an accident. Avoid loads that may protrude sideways and get snagged or caught in brush or other obstacles. Avoid covering and obstructing the headlamp or taillights with the cargo. Always make sure any storage compartment latches are closed. If a removable compartment cover is removed to carry a load, make sure that the load is secure and that smaller objects cannot "fly out". Secure compartment cover to the front rack.

This vehicle is designed specifically to carry an operator and ONE passenger only. Do not install other passenger seats or use the racks or their location to carry other passenger(s). Carrying more than one passenger may affect the stability and your control of the vehicle.

Hauling a Trailer

Riding this vehicle with a trailer substantially increases the risk of toppling, especially on inclined slopes. If a trailer is used behind the vehicle make sure that its hitch is compatible with the one on the vehicle. Make sure the trailer is horizontal with the vehicle. (In some instances a special extension may have to be installed on the vehicle hitch). Use security chains to secure the trailer with the vehicle. This vehicle may require additional stopping distance if hauling heavy loads, especially on inclined surfaces and when a passenger is on board. Be careful not to skid or slide. When stopped or parked, block the vehicle and trailer wheels from possible movement. Always make sure load is evenly distributed on the trailer. Use caution when disconnecting a loaded trailer; it or its load may topple on you or others. Do not turn at high speeds.

Working with your Vehicle

Your vehicle can help you perform a number of different LIGHT tasks ranging from snow removal to pulling wood or carrying cargo. A variety of accessories are available from your authorized Bombardier ATV dealer. However, always respect the load and capacities of the vehicle. Overloading of the vehicle can overstress the components and cause failure. To prevent possible injury, it is equally important to follow the instructions and warnings that accompany the accessory. Avoid any physical exertion through lifting or pulling of heavy loads or manpowering the vehicle. (Continue to read RECREATIONAL RIDING below).

Recreational Riding

Respect the rights and limitations of others. Stay away from areas designated for other types of off road use. This includes snowmobile trails, equestrian trails, cross country ski trails, mountain bike trails etc. Never assume there are no other users on the trail. Always stay to the complete right of the trail and do not zig zag to one side of the trail then the other. Be prepared to stop or pull off to the side if another trail user appears in front of you.

Always keep a safe distance from other riders. Your judgment of speed, terrain conditions, weather, mechanical condition of your vehicle and the "trust in judgment" you have in others around you will help you make a better choice of appropriate safe distance. This vehicle, like any other motorized vehicle, cannot stop "on a dime". The vehicle handling, stability and braking distance may be affected when riding with a passenger. Safely reduce speed when riding with a passenger. Allow greater distance for braking.

Before you ride, tell someone where you are planning to travel and your expected time of return. Never consume alcohol or drugs before or while riding!

Depending on the length of your ride, carry additional tools or emergency equipment. Find out where you can get additional gasoline and oil. Be prepared for the possible conditions you may encounter. An emergency first aid kit should always be a consideration.

Environment

One of the benefits of this vehicle is that it can take you off the beaten path away from most communities. However, you should always respect nature and the rights of others to enjoy it. Do not ride in environmentally sensitive areas. Do not drive over crops or tree shrubs... nor cut down trees or take down fencing... nor spin your wheels and destroy the terrain. "Tread Lightly".

Chasing wildlife is in many areas illegal. Wildlife can die of exhaustion after being chased by a motorized vehicle. If you encounter animals on the trail, stop and observe quietly and with caution. It will be one of the better memories of your life.

Observe the rule... "what you take in, carry out". Do not litter. Do not start campfires unless you have permission to do so... and then only ... away from dry areas. The hazards you may create on the trail may cause injury to others or yourself, even at a later date.

Respect farm lands. Always obtain the permission of the landowner before riding on private land. Respect crops, farm animals and property lines. If you come to a closed a gate, close it again after yourself.

Finally, do not pollute streams, lakes or rivers and do not modify the engine or muffling system, or remove any of its components.

Design Limitation

Although the vehicle is exceptionally rugged for its class, it is still a light vehicle by definition and its operation must be restricted to its proper purpose.

The addition of weight to any part of the vehicle changes its gravitational stability and modifies its performance.

Off-Highway Operation

The very nature of off-highway operation is dangerous. Any terrain, which has not been specially prepared to carry vehicles, presents an inherent danger where angularity, terrain substance and exact steepness are unpredictable. The terrain itself presents a continual element of danger, which must be knowingly accepted by anyone venturing over it.

An operator who takes a vehicle off-road should always exercise the utmost care in selecting the safest path and keeping close watch on the terrain ahead of him. On no account should the vehicle be operated by anyone who is not completely familiar with the driving instructions applicable to the vehicle, nor should it be operated on steep or treacherous terrain.

General Operating and Safety Precautions

Care, caution, experience and driving skill are the best precautions against the hazards of vehicle operation.

Whenever there is the slightest doubt that the vehicle can safely negotiate an obstacle or a particular piece of terrain, always choose an alternate route.

In off-road operation, power and traction, not speed, are important. Never drive faster than visibility and your own ability to select a safe route permit.

Constantly watch the terrain ahead for sudden changes in slopes or obstacles, such as rocks or stumps, that may cause loss of stability, resulting in tip-over or roll-over.

The vehicle handling, stability and braking distance may be affected when riding with a passenger. Safely reduce speed when riding with a passenger. Allow greater distance for braking.

Never operate the vehicle if the controls do not function normally.

When operating in reverse, check that the path behind the vehicle is free of people or obstacles. Proceed slowly and avoid sharp turns. Take into account that the passenger can obstruct your view. Disembark your passenger if necessary.

When stopped or parked, always apply the parking brake. This is especially important when parking on a slope. On very steep inclines or if the vehicle is carrying cargo, the wheels should be blocked using rocks or bricks. Remember to turn the fuel valve to the closed position.

While reading this *Operator's Guide*, remember that:

WARNING

Indicates a potential hazard that, if not avoided, could result in serious injury or death.

Uphill Driving

Due to configuration, this vehicle has excellent climbing ability, so much so that tipover is possible before traction is lost. For example, it's common to encounter terrain situations where the top of the hill has eroded to a point that the hill peak rises very sharply. The vehicle can readily negotiate such a condition, however, in doing so, when the front of the vehicle is driven to a point that the vehicle's balance changes rearward tip over can occur.

The same situation may apply if an embedded object causes the front of the vehicle to climb more than desired. If such a situation occurs take an alternate route. Be aware of sidehilling dangers when doing so.

It is also wise to know the terrain condition on the other side of the hill or bank. All too often there exists a sharp drop-off that is impossible to negotiate or descend.

Downhill Driving

This vehicle can climb slopes that are steeper than it can safely descend. Therefore, it is essential to assure that a safe route exists to descend a slope before you climb it.

Decelerating while negotiating a slippery downhill slope could "toboggan" the vehicle. Maintain steady speed and/or accelerate slightly to regain control.

Side Hilling

Whenever possible, such operation should be avoided. If necessary, do so with extreme caution. Always disembark the passenger before performing this operation. Sidehilling on steep inclines could result in roll-over. In addition, slippery or unfirm surfaces could result in uncontrollable side sliding. Do not attempt to turn the vehicle downhill with the slide. Avoid all objects or depressions that will intensify the raising of one side of the vehicle higher than the other, thus causing roll-over.

Drop-Offs

This vehicle will "bottom-out" and usually stop if either the front or rear wheels are driven over a drop-off. If the drop is sharp or deep, the vehicle will nose dive and tip-over.

WARNING

Avoid negotiating drop-offs. Reverse and select an alternate route.

Riding Techniques

Riding your vehicle too fast for the conditions may result in injury. Apply only enough throttle to proceed safely. Statistics show that high speed turns usually result in mishaps and injury. Always remember that this vehicle is heavy! Its pure weight alone may entrap you should it fall and pin you down.

This vehicle is not designed for jumping nor can it, or you, absorb the energy of high impacts such as jumping. Performing "wheelies" can cause the vehicle to flip over onto you. Both practices have a high risk for you and your passenger and should be avoided at all times.

To maintain proper control it is strongly advised that you keep your hands on the handlebar and within easy reach of all controls. The same holds true for your feet. To minimize the possibility of any leg or foot injury, keep your feet on the footrests at all times. Do not direct your toes outwards nor place your foot out to assist turning as they can be hit or snagged by passing obstacles or may contact the wheels. Your passenger must keep his hands on grab handles and his feet on footrests at all times.

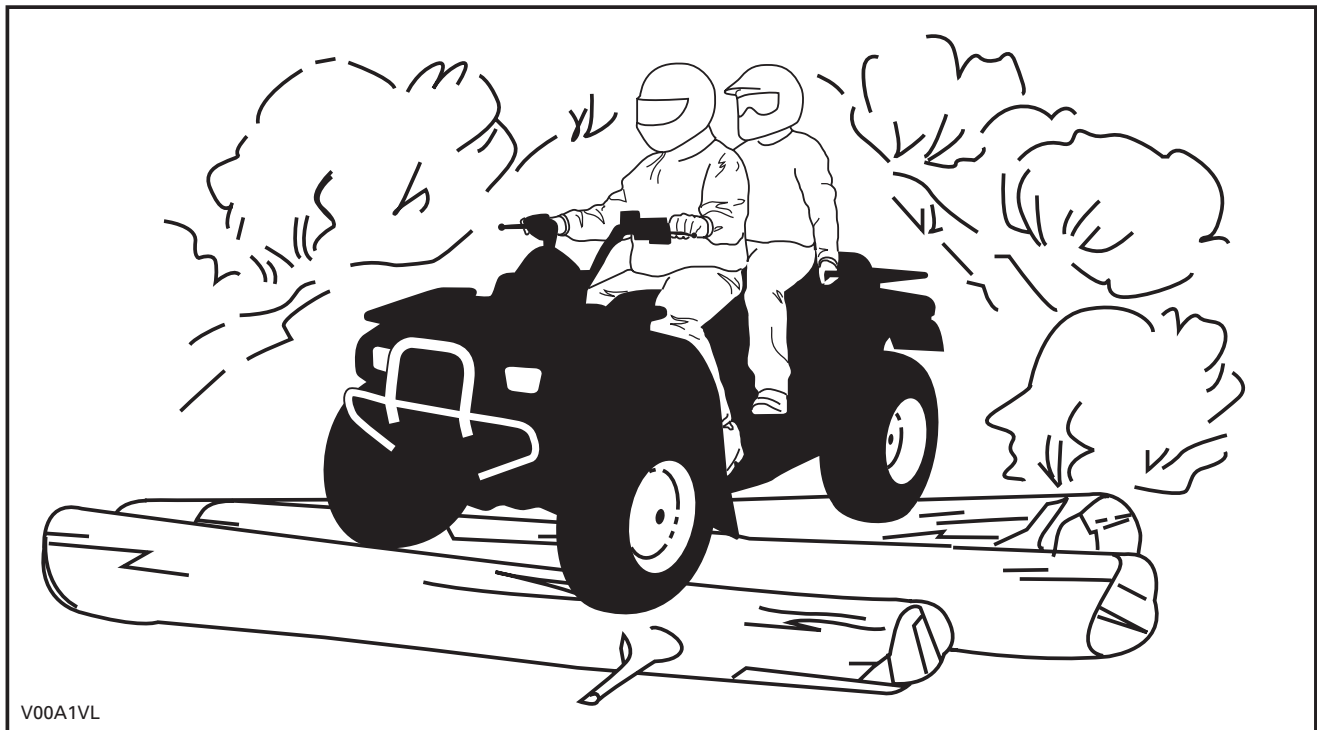

Even though there is an adequate suspensions system on this vehicle there are "washboard" or rough terrain conditions that will make you feel uncomfortable and even cause back injury. "Posting" or riding in a crouched position will often be required. Slow down and allow your flexed legs to absorb impact.

This vehicle is not designed for riding on roads or highways. (In most places it is an illegal practice). Riding your vehicle on roads or highways could cause a collision to occur with another vehicle. The tires of this vehicle are not suited for paved road use. Pavement may seriously affect the handling and control of the vehicle. Riding on roads or soft shoulders may confuse other road users, especially if your lights are on. If you have to cross a road, the lead driver should get off his vehicle then observe and give directions to the other riders. The last person after crossing then assists the lead driver to cross. Do not travel on sidewalks. They are designated for pedestrian use.

Water can be a unique hazard. If it is too deep the vehicle may “float” and topple. Check the water depth and current before you attempt to cross any water. Water should not go above the footrest. Be wary of slippery surfaces such as rocks, grass, logs, etc., both in the water and on its banks. A loss of traction may occur. Do not attempt to enter the water at high speed. The water will act as a brake and could throw you.

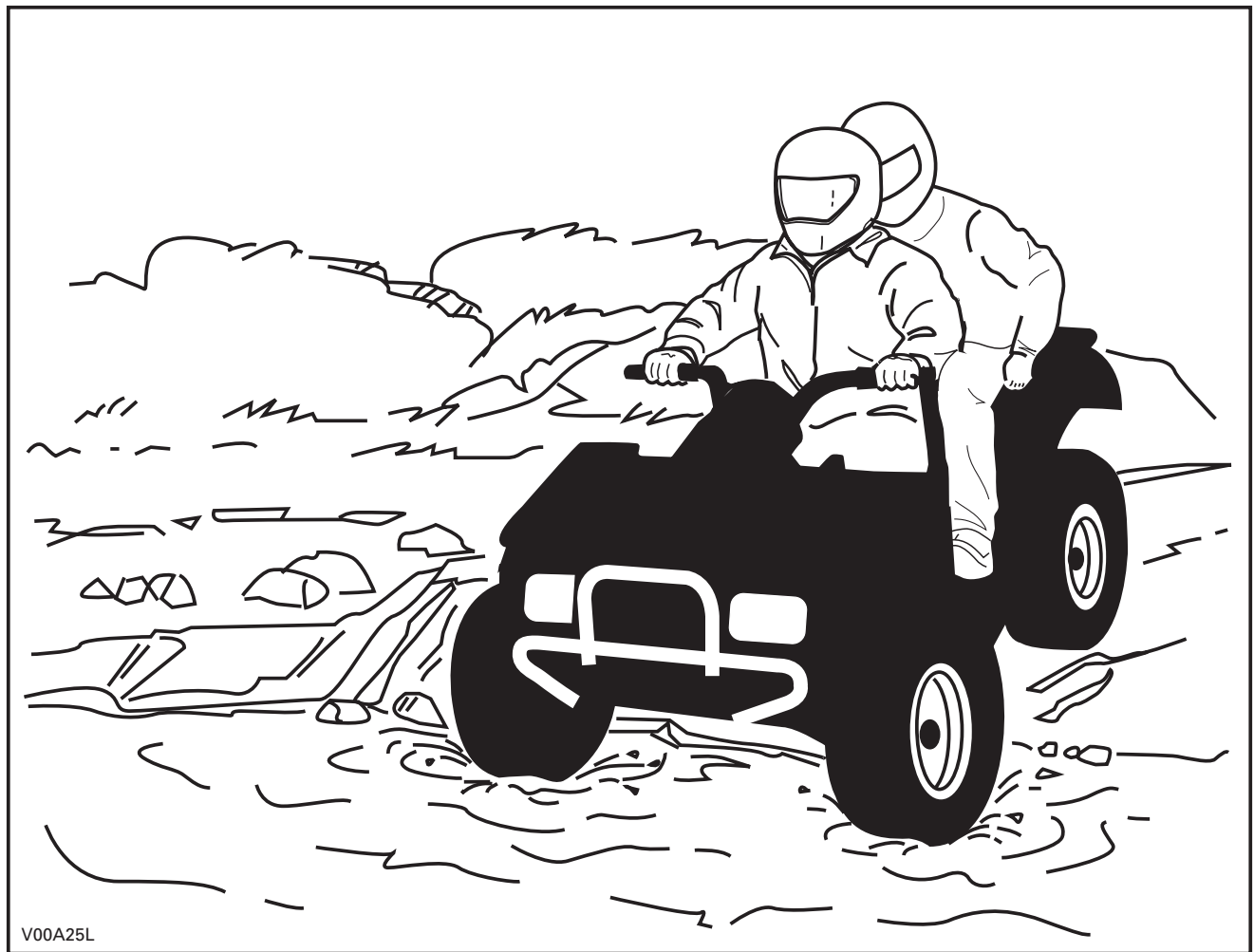

Water will affect the braking ability of your vehicle. Make sure you dry the brakes by applying them several times after the vehicle leaves the water. The vehicle braking distance may be affected when riding with a passenger. Safely reduce speed when riding with a passenger. Allow greater distance for braking.

Mud or marsh lands may be encountered near water. Be prepared for sudden “holes” or changes in depth. Similarly so, be watchful of hazards such as rocks, logs, etc., partially covered by vegetation.

If your trip crosses frozen waterways, make sure that **the ice is thick enough and sound enough** to support the total weight of yourself, your passenger, the vehicle and its load. Be ever watchful of open water... it is a sure indication that the ice thickness will vary. The operator is responsible for the safety of the passenger. If in doubt, do not attempt to cross.

Ice will also affect the control of vehicle. Slow down and do not “gun” the throttle. This will only result in spinning of the tires and possible tipover of the vehicle. Avoid rapid braking. This again will possibly result in an uncontrolled slide and tipover of the vehicle or passenger ejection. Slush should be avoided at all times since it could block the operation or controls of the vehicle. Never attempt this maneuver with a passenger. Always remember that the vehicle handling and stability may be affected when riding with a passenger.

Sand and riding on sand dunes or on snow is another unique experience but there are some basic precautions that should be observed. Wet, deep or fine sand/snow may create a loss of traction and cause the vehicle to slide, drop off or become “bogged” down. If this occurs look for a firmer base. Again, the best advice is to slow down and be watchful of the conditions. When you ride with a passenger, drive slowly.

When riding in sand dunes it is advisable to equip the vehicle with an antenna type safety flag. This will help make your location more visible to others over the next sand bank. Proceed carefully should you see another safety flag ahead. Since the antenna type safety flag can snag and rebound on your body if caught, do not use it in areas where there are low hanging branches or obstacles. Always remember that the vehicle handling and stability may be affected when riding with a passenger.

Riding on loose stones or gravel are very similar to riding on ice. They will affect the steering of vehicle... possibly causing it to slide or cause passenger ejection and tipover especially at high speeds. In addition, braking distance may be affected. Remember that “gunning” the throttle or sliding may cause loose stones to be ejected rearwards into the path of another rider’s way. Never do it deliberately. Always remember that vehicle handling, stability and braking distance may be affected when riding with a passenger.

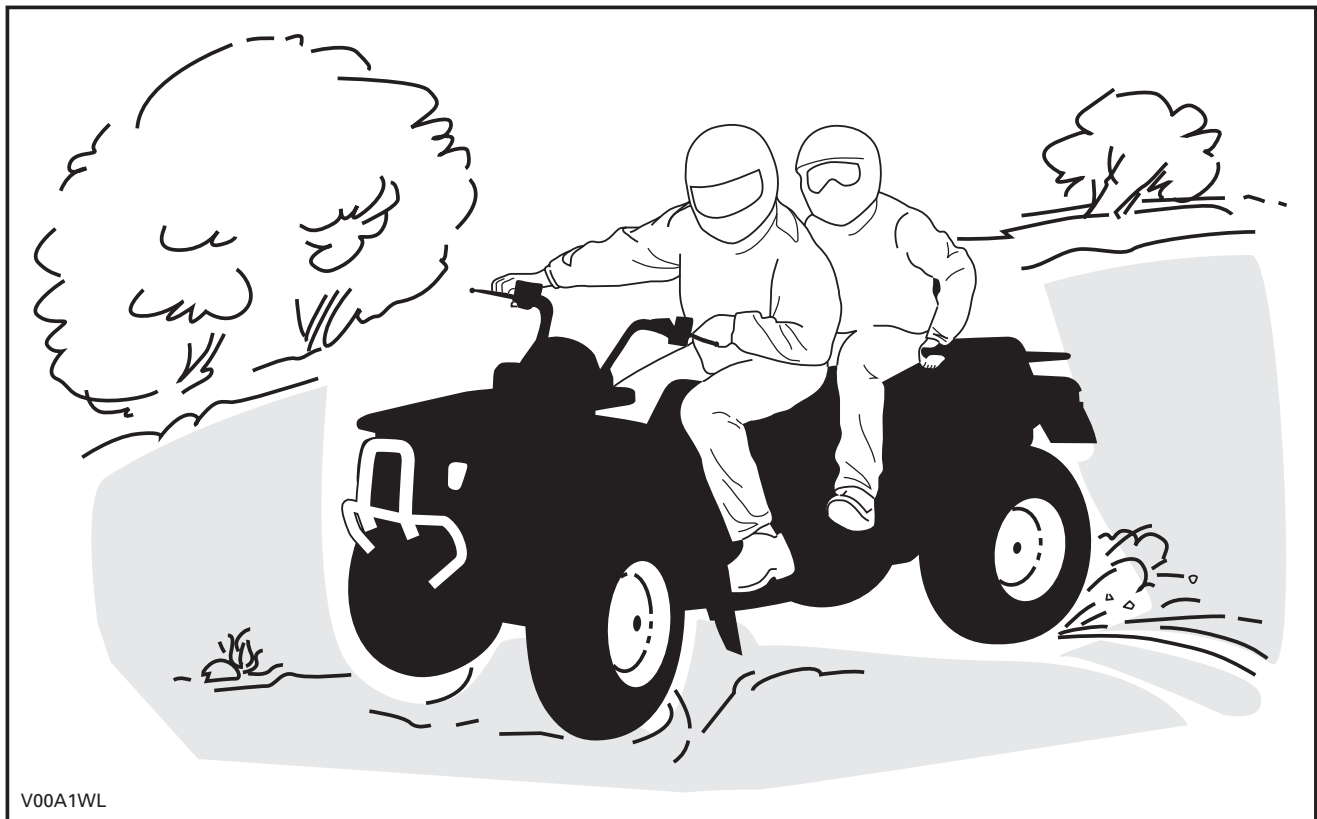

If you do get into a slide or skid, it may help to turn the handlebar into the direction of the skid until you regain control. Never jam the brakes and lock the wheels.

Respect and follow all posted trail signs. They are there to help you and others.

Obstacles in the "trail" should be traversed with caution. This includes loose rocks, fallen trees, slippery surfaces, fences, posts, and embankments and depressions. You should avoid them whenever possible. Remember that some obstacles are too large or dangerous to cross and should be avoided. The operator is responsible for the safety of the passenger and in doubt, disembark the passenger before getting through the obstacles. Small rocks or fallen trees may be safely crossed... approach at a 90° angle. Stand on the footrests while keeping your knees flexed. Adjust speed without losing momentum and do not "gun" the throttle. Hold handgrips firmly. Place your body weight rearwards and proceed. Do not try to lift the vehicle front wheels off the ground. Be aware that the object may be slippery or may move while crossing.

When driving on hills or slopes two things are highly important... be prepared for slippery surfaces or terrain variations and obstacles and... use proper body positioning. The operator is responsible for the safety of the passenger and in doubt, disembark the passenger before getting through the obstacles.

Uphill

Do not forget, the operator is responsible for the safety of the passenger. In doubt, disembark the passenger before climbing hill. Always remember that the vehicle handling, stability and braking distance may be affected when riding with a passenger.

If you decide to keep your passenger, the passenger must synchronize its movements with yours.

Keep your body weight forward towards the top of the hill. Keep your feet on the footpegs and shift into low gear then accelerate and when necessary, change gear quickly as you climb. Do not over-speed since this may cause the front of the vehicle to lift from the ground and fall back on you. If the hill is too steep and you cannot proceed or the vehicle begins to roll backwards, apply the brake, being careful not to slide. Dismount, passenger first, then use the "U" turn or "K" turn (while walking back, next to the vehicle on the up hill side and with a hand on the brake lever, slowly back the rear of the vehicle toward the top of the hill then drive downhill). Always walk or dismount on the upside of the slope while keeping clear of the vehicle and its rotating wheels. Do not try to hold on to the vehicle if it begins to topple. **Stay clear.** Do not ride over the crest of the hill at high speed. Obstacles, including sharp drop-offs, may exist. The passenger should get on the vehicle only when the vehicle has returned to a safe location.

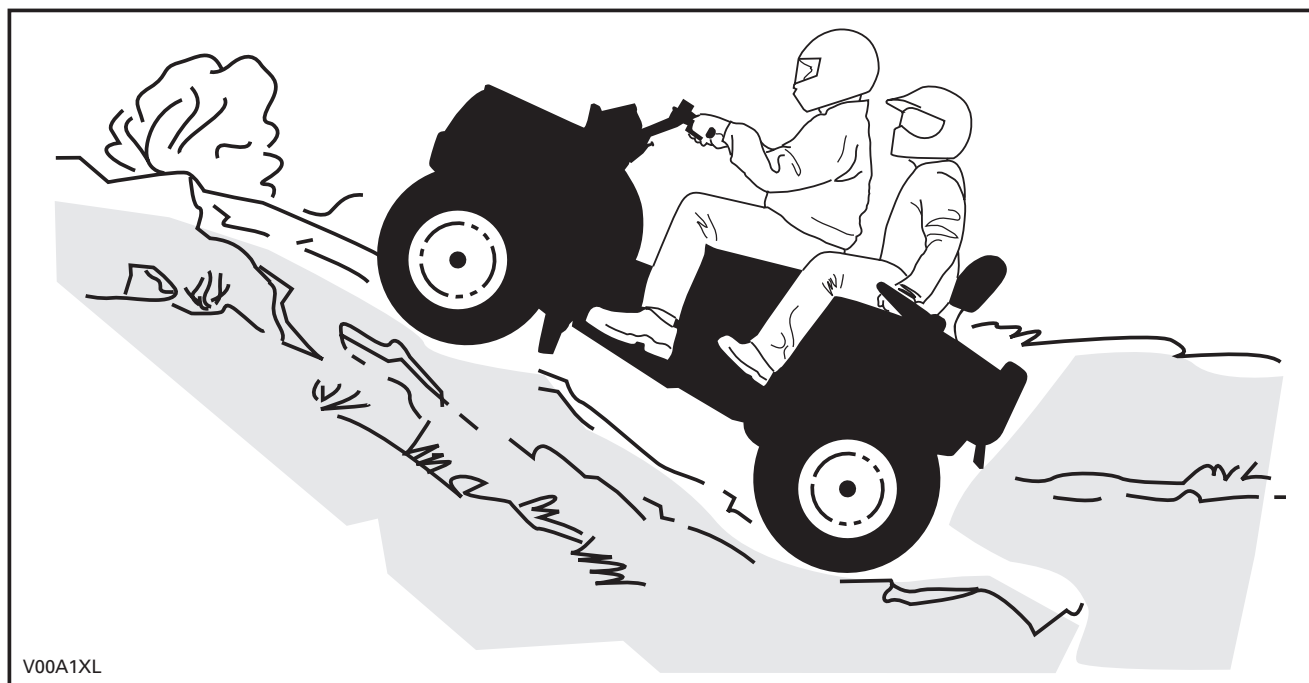

Downhill

Do not forget, the operator is responsible for the safety of the passenger. In doubt, disembark the passenger before going down the hill. Always remember that the vehicle handling, stability and braking distance may be affected when riding with a passenger.

If you decide to keep your passenger, the passenger must synchronize its movements with yours.

Keep your body weight rearwards. Apply the brake gradually to prevent skidding. Do not "coast" down the slope using solely engine compression or in neutral gear.

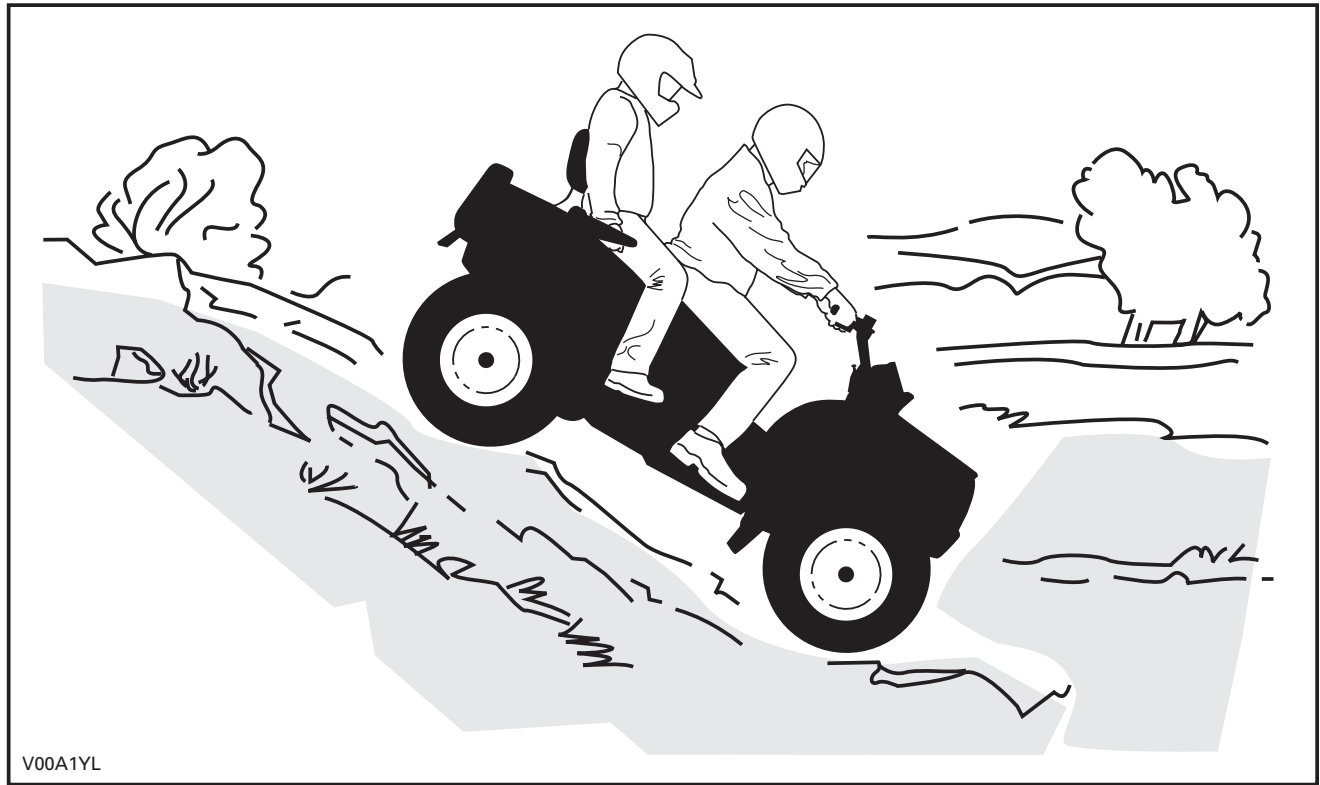

V00A1YL

Sidehilling

Do not forget, the operator is responsible for the safety of the passenger. In doubt, disembark the passenger before proceeding. Always remember that the vehicle handling, stability and braking distance may be affected when riding with a passenger.

If you decide to keep your passenger, the passenger must synchronize its movements with yours.

This is one of the **most risky** types of riding since it may drastically change the balance of the vehicle. It should be avoided wherever possible. If it is necessary to do so however, it is important that you **ALWAYS** keep your body weight on the upside of the slope... and be prepared to dismount on that side should the vehicle begin to topple. **Do not try to stop or save the vehicle from damage.**

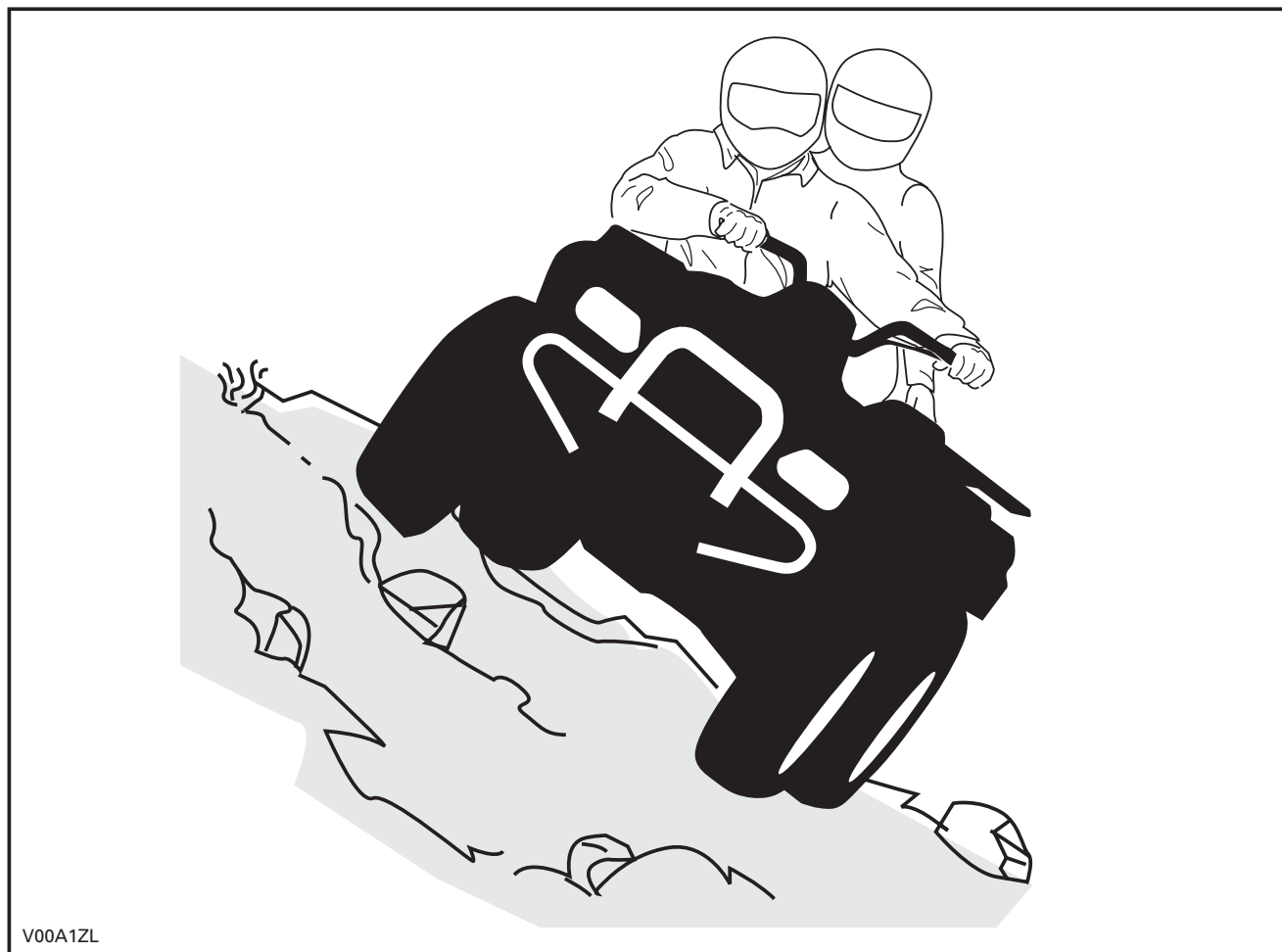

Routine Maintenance

Once your ride completed, it is wise to remove any build up of snow, ice, mud and grime. Not only will this help you keep your vehicle longer and in good condition for resale but will eliminate potential hazards the next time you use the vehicle. Wash your vehicle in warm soapy water then allow it to dry. (A towel may help). Do not wash your vehicle outside during freezing weather. Apply appropriate lubrication as described in the MAINTENANCE section.

Part of your responsibility towards safety is to respect the contents of this *Operator's Guide*. It provides valuable advice on how to properly take care of your vehicle. If further assistance is required your authorized Bombardier ATV dealer is always willing to help.

Modification of the vehicle to increase speed and performance may violate the terms and conditions of your vehicle limited warranty. In addition, certain modifications including the removal of engine or exhaust components are illegal under most laws.

Changing the wheel and/or tire size may affect the stability of the vehicle. Incorrect tire pressure may lead to blow outs or cause a tire to move around on its rim and become lost or damaged. Wheels or tires which are damaged should always be replaced.

The vehicle handling, stability and braking distance may be affected when riding with a passenger. Safely reduce speed when riding with a passenger. Allow greater distance for braking.

The operator is responsible for the safety of the passenger. In doubt, disembark the passenger before executing the maneuver. Use your common sense.

HANG TAG

This vehicle comes with a hang tag and labels containing important safety information.

The labels should be considered permanent parts of the vehicle. If a label comes off or becomes hard to read, please contact an authorized Bombardier ATV dealer for replacements.

Any person who rides this vehicle should read and understand this information before riding.

<p>! WARNING</p> <p>Improper vehicle use can result in SEVERE INJURY or DEATH.</p>  <p>ALWAYS USE AN APPROVED HELMET AND PROTECTIVE GEAR FOR DRIVER AND PASSENGER.</p> <p>NEVER USE ON PUBLIC ROADS.</p> <p>NEVER CARRY MORE THAN 1 PASSENGER.</p> <p>NEVER USE WITH DRUGS OR ALCOHOL.</p> <p>NEVER operate:</p> <ul style="list-style-type: none">• without proper training or instructions.• at speeds too fast for your skills or the conditions.• on public roads - a collision can occur with another vehicle. <p>ALWAYS:</p> <p>use proper riding techniques to avoid vehicle overturns on hills and rough terrain and in turns.</p> <p>avoid paved surfaces - pavement may seriously affect handling and control.</p> <p>LOCATE AND READ OPERATOR'S GUIDE. FOLLOW ALL INSTRUCTIONS & WARNINGS.</p> <p>This hangtag is not to be removed before sale.</p>	<p>2-UP ATV</p> <p>NO OPERATOR UNDER AGE 16</p> <p>NO PASSENGER UNDER AGE 12</p> <p>NEVER CARRY MORE THAN ONE PASSENGER</p> <hr/> <p>THIS VEHICLE IS FOR OFF ROAD USE ONLY.</p> <hr/> <p>TRAINING COURSES TO TEACH RIDING SKILLS ARE PROVIDED WITH THIS VEHICLE. MAKE SURE TO WATCH THE THE SAFETY VIDEO. READ AND UNDERSTAND THE OPERATOR'S MANUAL AND ALL OF THE WARNING LABELS ON THIS VEHICLE BEFORE OPERATING.</p> <hr/> <p>CHECK WITH YOUR DEALER TO FIND OUT ABOUT STATE OR LOCAL LAWS REGARDING VEHICLE OPERATION.</p> <p>This hangtag is not to be removed before sale.</p>
---	--

V01M0WL 704900628

While reading this *Operator's Guide*, remember that:

! WARNING

Indicates a potential hazard that, if not avoided, could result in serious injury or death.

LOCATION OF THE IMPORTANT LABELS

The following labels are on your vehicle. If missing or damaged, they can be replaced free of charge. See an authorized Bombardier ATV dealer.

NOTE: The following illustrations used in this *Operator's Guide* are a general representation only. Your model may differ.

Quest MAX Series

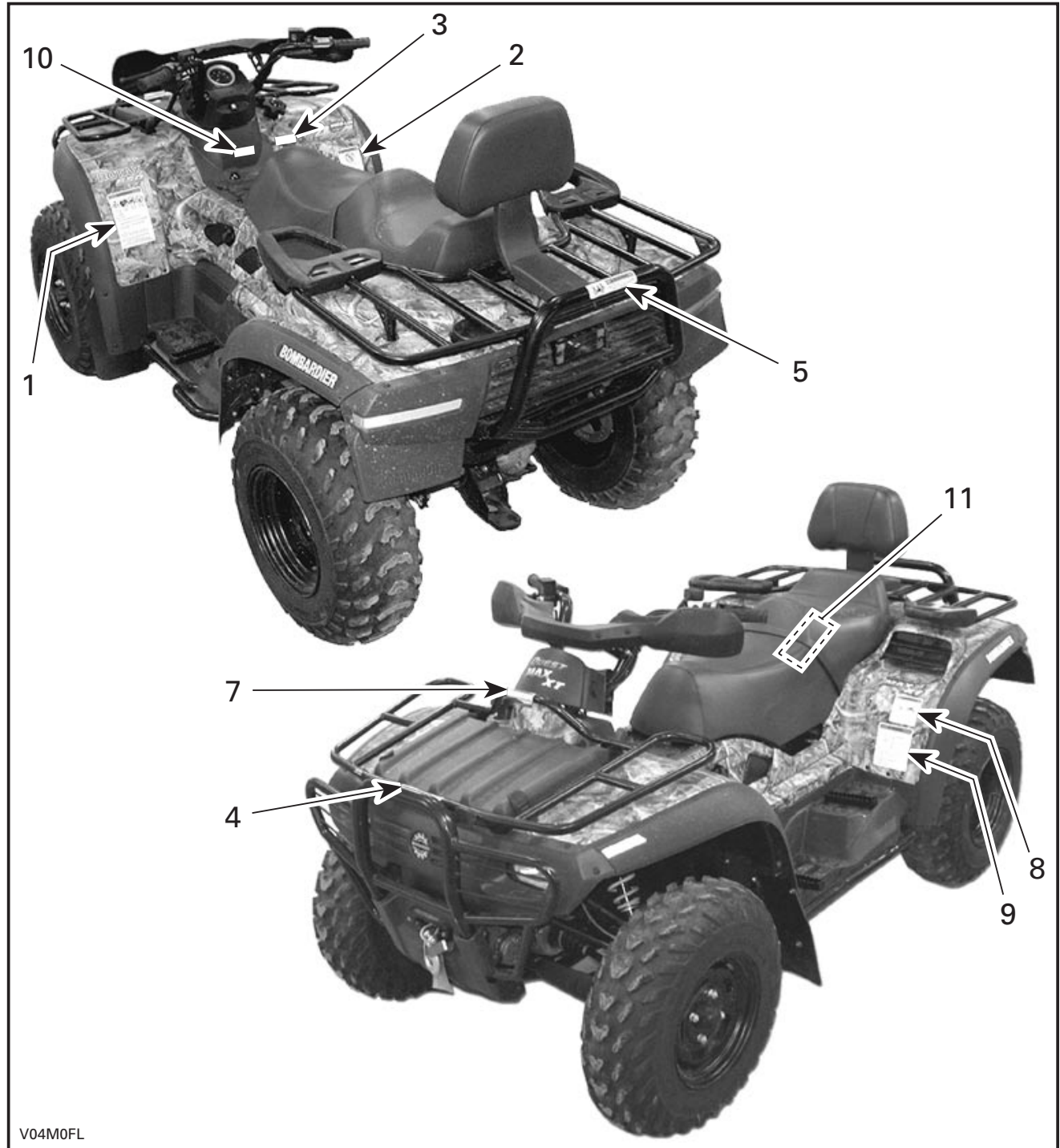

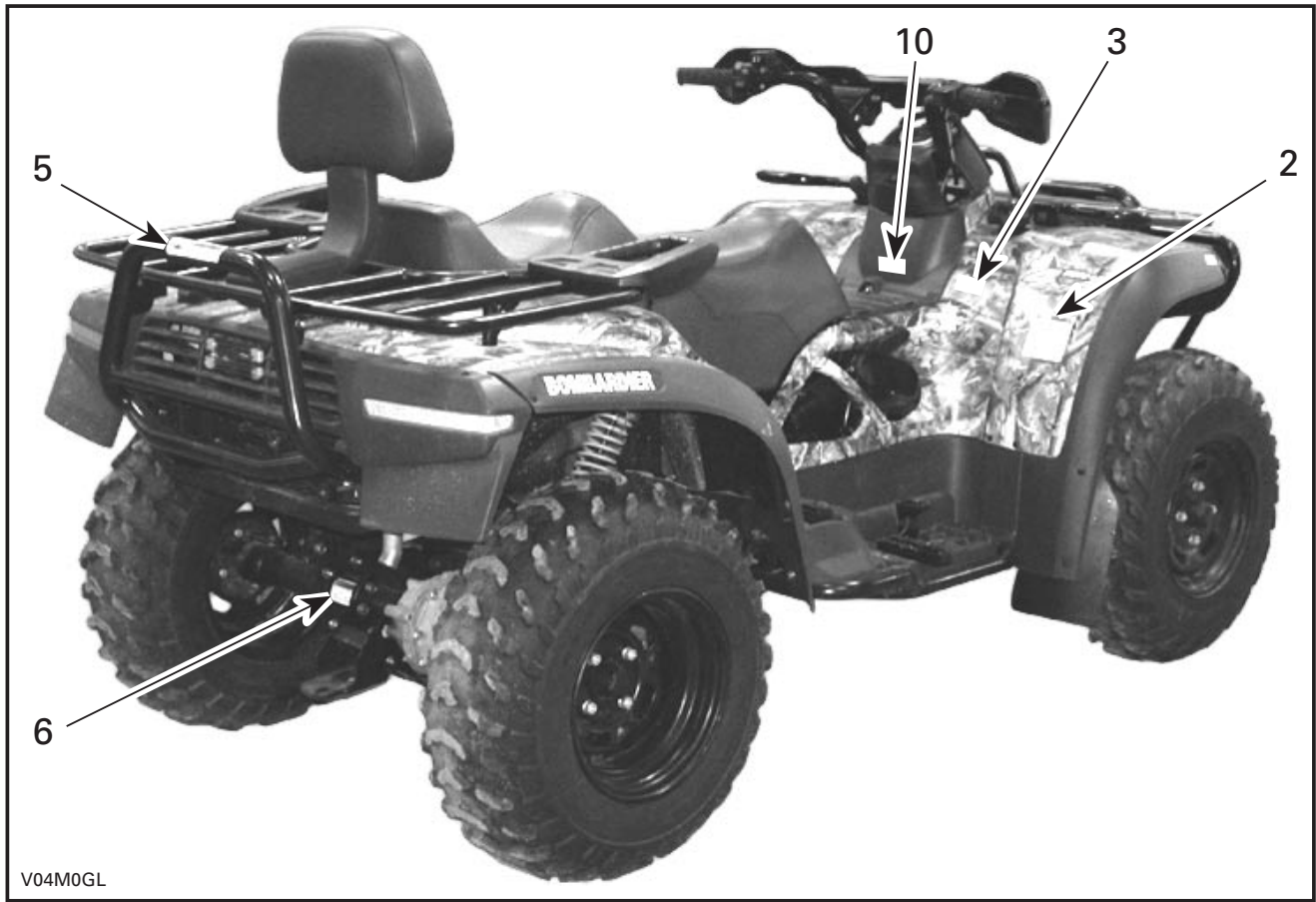

Traxter MAX Series

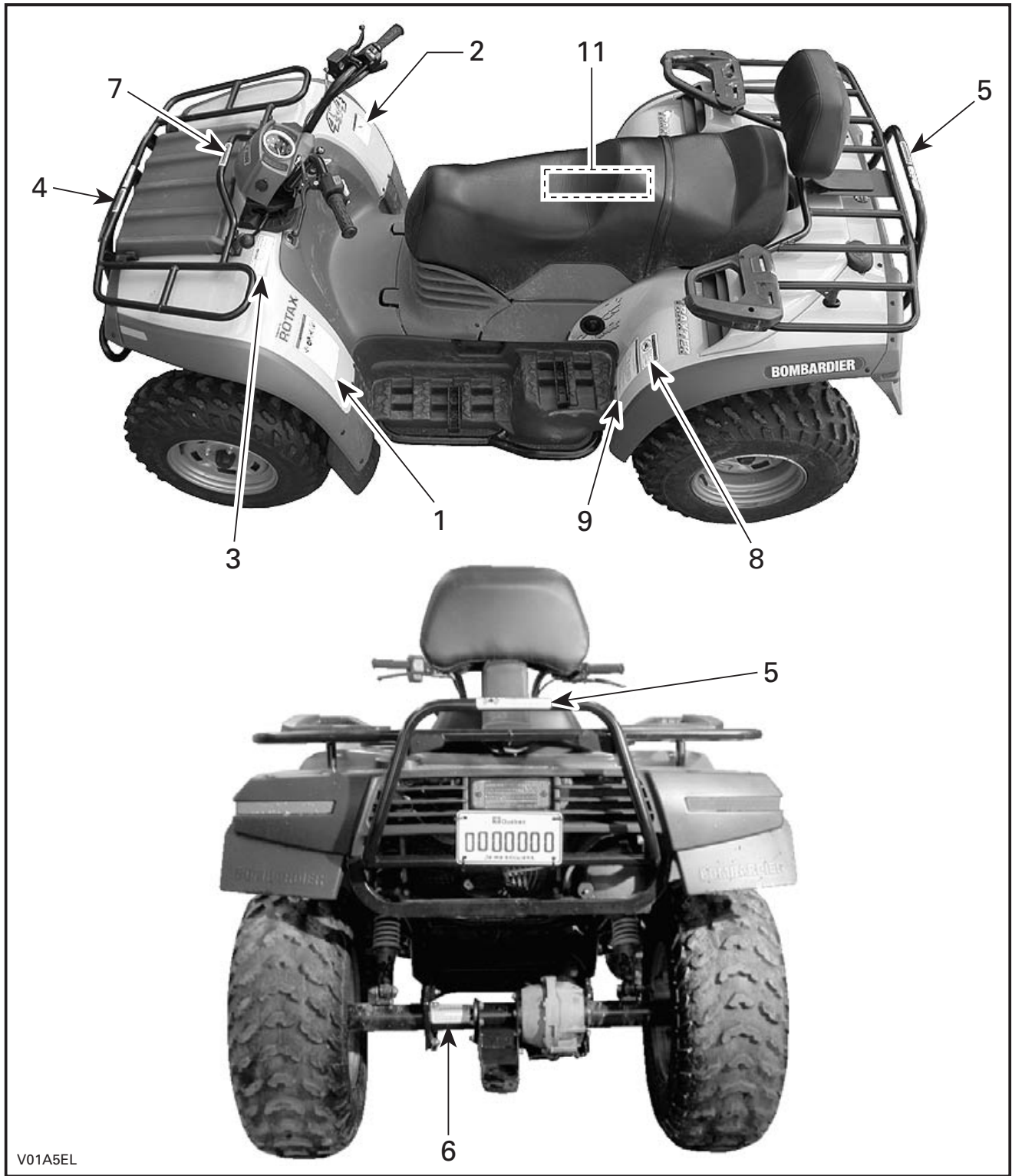

V01A5EL

Label 1

⚠ WARNING

Improper vehicle use can result in **SEVERE INJURY** or **DEATH**.



ALWAYS USE AN APPROVED HELMET AND PROTECTIVE GEAR FOR DRIVER AND PASSENGER.

NEVER USE ON PUBLIC ROADS.

NEVER CARRY MORE THAN 1 PASSENGER.

NEVER USE WITH DRUGS OR ALCOHOL.

NEVER operate:

- without proper training or instructions.
- at speeds too fast for your skills or the conditions.
- on public roads - a collision can occur with another vehicle.

ALWAYS:

use proper riding techniques to avoid vehicle overturns on hills and rough terrain and in turns.

avoid paved surfaces - pavement may seriously affect handling and control.

LOCATE AND READ OPERATOR'S GUIDE. FOLLOW ALL INSTRUCTIONS & WARNINGS.

704 900 451

V01M0QY

QUEST MAX AND TRAXTER MAX SERIES

Label 2

⚠ WARNING

OPERATOR UNDER 16

Operating this vehicle if you are under age 16 increases the chance of **SEVERE INJURY** or **DEATH** to both rider and passenger.

NEVER operate this vehicle if you are under age 16.

NEVER carry more than one passenger.

704 900 515

V01M0RY

QUEST MAX AND TRAXTER MAX SERIES

Label 3

CAUTION

- ATV **MUST** be stopped before shifting transmission lever.
- Always apply foot brake to shift from PARK (P).

704 900 007

V01M03Z

QUEST MAX AND TRAXTER MAX SERIES

Label 4



⚠ WARNING

NEVER carry a passenger on this carrier.

MAXIMUM FRONT LOAD: 90 lbs (40 kg) evenly distributed.
(Includes front storage tray load: 22 lbs (10 kg))

704 900 453

V01M0SY

QUEST MAX AND TRAXTER MAX SERIES

Label 5



⚠ WARNING

NEVER carry a passenger on this carrier.

MAXIMUM REAR LOAD: 175 lbs (80 kg) evenly distributed.
(Includes trailer tongue weight if applicable.)

704 900 917

V01M0TY

QUEST MAX AND TRAXTER MAX SERIES

Label 6

⚠ WARNING

Improper loading of a trailer may cause loss of vehicle control.

- Maximum towing weight: **1100 lb (500 kg)**.
- Maximum tongue weight: **30 lb (14 kg)**.

704 900 009

V01M06Z

QUEST MAX AND TRAXTER MAX SERIES

Label 7

⚠ WARNING

Always latch storage cover.

704 900 038

V01M0BZ

QUEST MAX AND TRAXTER MAX SERIES

Label 8

⚠ WARNING	
Improper vehicle use can result in SEVERE INJURY or DEATH.	
	
NEVER CARRY A PASSENGER UNDER AGE 12.	NEVER CARRY MORE THAN 1 PASSENGER.
NEVER carry a passenger too small to firmly plant feet on footrests and securely grab handles.	
NEVER carry a passenger who is not securely grasping grab handles at all times.	
704 900 634	
V01M0ZY	

QUEST MAX AND TRAXTER MAX SERIES

Label 9

⚠ WARNING	
Improper tire pressure or overloading can cause loss of control. Loss of control can result in SEVERE INJURY or DEATH.	
LOAD	COLD TIRE PRESSURE
UP TO 600 lbs (272 kg)	FRONT MAX : 7 psi, 48 kPa MIN : 5 psi, 35 kPa
	REAR MAX : 7 psi, 48 kPa MIN : 5 psi, 35 kPa
ALWAYS maintain proper tire pressure as shown.	
NEVER exceed the vehicle load capacity of 600 lbs (272 kg)	
Includes weight of operator, passenger, cargo, and accessories (and if applicable, trailer tongue weight).	
LOADING / TRAILER TOWING	
<ul style="list-style-type: none"> • Cargo or trailer can affect stability and handling. • When loading with cargo or towing a trailer <ul style="list-style-type: none"> - reduce speed. - allow more room to stop. - avoid hills and rough terrain. 	
704900752	
V01M12Y	

QUEST MAX SERIES

⚠ WARNING

Improper tire pressure or overloading can cause loss of control. Loss of control can result in SEVERE INJURY or DEATH.

LOAD	COLD TIRE PRESSURE
UP TO 640 lbs (290 kg)	FRONT MAX : 7 psi, 48 kPa MIN : 5 psi, 35 kPa
	REAR MAX : 7 psi, 48 kPa MIN : 5 psi, 35 kPa

ALWAYS maintain proper tire pressure as shown.

NEVER exceed the vehicle load capacity of 640 lbs (290 kg)

Includes weight of operator, passenger, cargo, and accessories (and if applicable, trailer tongue weight).

LOADING / TRAILER TOWING

- Cargo or trailer can affect stability and handling.
- When loading with cargo or towing a trailer
 - reduce speed.
 - allow more room to stop.
 - avoid hills and rough terrain.

704900519

V01M0VY

TRAXTER MAX SERIES

Label 10

CAUTION
CONSOLE MAXIMUM LOAD: 11 lb (5 kg).
704 900 247
V04M08Y

QUEST MAX SERIES

Label 11

VEHICLE EMISSION CONTROL INFORMATION	ENGINE FAMILY: 4BCXX.6442GC EXHAUST EMISSION CONTROL SYSTEM: EM DISPLACEMENT: 644.0cc TUNE-UP SPECIFICATIONS:	BOMBARDIER <i>RECREATIONAL PRODUCTS</i>
	IDLE SPEED:	1100 RPM ± 100 RPM
	IDLE AIR/FUEL MIXTURE SETTING:	FROM POSITION OF PILOT SCREW FOR MAXIMUM SPEED AT IDLE, UNSCREW 3/4 OF TURN
	SPARK PLUG: FUEL: (RON + MON) /2 ENGINE OIL:	NGK DCPR8E ELECTRODE GAP → 0.6 mm - 0.7 mm UNLEADED 87 OCTANE SAE 10W40
THIS VEHICLE CONFORMS TO CALIFORNIA REGULATIONS APPLICABLE TO 2004 MODEL YEAR NEW OFF-ROAD MOTORCYCLES AND ALL TERRAIN VEHICLES AND IS CERTIFIED TO 10 g/bhp-hr HC+NO _x ENGINE FAMILY EXHAUST EMISSION STANDARD.		
		704 900 627

V01M0NL

QUEST MAX SERIES

VEHICLE EMISSION CONTROL INFORMATION	ENGINE FAMILY: 4BCXX.4982GC EXHAUST EMISSION CONTROL SYSTEM: EM DISPLACEMENT: 497.70cc TUNE-UP SPECIFICATIONS:	BOMBARDIER <i>RECREATIONAL PRODUCTS</i>
	IDLE SPEED:	1100 RPM ± 100 RPM
	IDLE AIR/FUEL MIXTURE SETTING:	FROM POSITION OF PILOT SCREW FOR MAXIMUM SPEED AT IDLE, UNSCREW 3/8 OF TURN
	SPARK PLUG: FUEL: (RON + MON) /2 ENGINE OIL:	NGK DR8EA ELECTRODE GAP → 0.6 mm - 0.7 mm UNLEADED 87 OCTANE SAE 10W40
THIS VEHICLE CONFORMS TO CALIFORNIA REGULATIONS APPLICABLE TO 2004 MODEL YEAR NEW OFF-ROAD MOTORCYCLES AND ALL TERRAIN VEHICLES AND IS CERTIFIED TO 10 g/bhp-hr HC+NO _x ENGINE FAMILY EXHAUST EMISSION STANDARD.		
		704 900 625

V01M0XL

TRAXTER MAX SERIES

SAFETY TRAINING

INTRODUCTION

Objective

The objective of this course is to give the Bombardier® 2-UP vehicle owner the information required to operate a 2-UP vehicle safely. The course will be offered to all 2-UP vehicle buyers, and members of their immediate families. Successful completion of the training course is required to complete the sale of the 2-UP vehicle.

The 2-UP vehicle allows you to ride with one passenger. Remember, you should never allow passengers on an ATV not specifically designed for such use.

Sections Covered

1. General Safety Information
2. Bombardier 2-UP vehicle *Safety Video-cassette*
3. *Operator's Guide* Review
4. Hands-on Riding

Time Required

As required, depending on trainee's experience and skills.

SECTION I – GENERAL SAFETY INFORMATION

Objective

The purpose of this section is to:

- a) Explain why this safety training is important.
- b) Discuss CPSC (Consumer Product Safety Commission) Injury and Death Statistics.
- c) Discuss Bombardier's age and size recommendation.
- d) Discuss what protective clothing should be worn by the operator and the passenger while riding the 2-UP vehicle.
- e) Discuss when an operator should begin to ride with a passenger.
- f) Discuss local, state and federal laws pertaining to ATV use.
- g) Discuss the areas where you can ride.

Outline

A) This Course is Provided:

- To make riding more enjoyable to you and your passenger.
- To reduce the chance of injury and death to you and your passenger through safety and risk awareness.
 1. What could happen when proper safety and risk precautions are not followed.
 2. Why you should not carry more than one passenger on your 2-UP vehicle.
 3. Why you and your passenger should keep your feet on your respective footrests at all times, and why your passenger should always hold the grab handles while riding.
 4. Why you and your passenger should not use alcohol or drugs prior to operating your vehicle.
 5. Why you should not ride on paved surfaces.

B) CPSC Statistics

- The CPSC has published statistics of injury and death suffered by riders of ATVs during the last 5 years (January 1997-December 2001):
 1. 417,200 ATV-related injuries
 2. 1,463 ATV-related deaths.

C) Age and Size Requirements for the 2-UP Vehicle

- No one under the age of 16 should operate a 2-UP vehicle.
- No passenger under 12 should be allowed on a 2-UP vehicle. Regardless of age, your passenger should also be able to firmly plant his/her feet on footrests and securely grasp the grab handles.
- Do not allow a person unfamiliar with your 2-UP vehicle to operate it.

D) Protective Clothing that Should be Worn by the Driver and Passenger

- approved helmet (ANSI, SNELL, CSA or DOT)
 1. full face
 2. 3/4 shell
 3. passenger's helmet should have a rigid chin guard
- protective boots
- riding gloves
- eye protection (goggles or face shield)
- long sleeve shirt
- full length pants
- elbow pads (optional)
- knee pads (optional)
- kidney belt (optional).

E) Riding with a Passenger

- Before riding with a passenger, the operator should first become highly familiar with the operation of the 2-UP vehicle.
- Once ready, the operator should begin riding with a passenger at very low speed and on familiar terrain.

F) ATV-Related Local, State and Federal Laws

- Discuss those laws.

G) Areas where you Cannot Ride your 2-UP Vehicle

Basic rules are:

- Do not ride on private land without the owner's permission.
- Do not ride in areas where your Traxter Max might cause permanent damage.
- Do not attempt maneuvers that exceed your ability.
- Always know where you are and where you are going.

Expected Results

Upon completion of this section, you should:

- Know the current injury and death statistics as published by the CPSC.
- Know Bombardier's policy toward drivers under 16 years of age, and passengers under 12 years of age.
- Know what clothing and protective gear should be worn by you and your passenger while riding.
- Know the local, state and federal laws applying to ATV operation.
- Know basic rules of where and how not to ride.

SECTION II – BOMBARDIER 2-UP VEHICLE SAFETY VIDEOCASSETTE

Objective

The purpose of this section is to:

- a) Indicate guidelines prior to viewing the Bombardier 2-UP vehicle *Safety Videocassette*.
- b) Present safety-related information through the Bombardier 2-UP vehicle *Safety Videocassette*.
- c) Answer all questions that may remain at the end through a recap.

Outline

A) Guidelines

Ask to stop the video at any point if a question should arise. Repeat the video if necessary, if you are uncertain on any points.

B) Safety-Related Information

Clothing

Refer to section I.

Age Recommendation

No operator under 16/no passenger under 12 or too small to reach the footrests or the grab handles.

Operator's Guide Usage

You must read and understand the *Operator's Guide*.

Pre-Operating Check

You must do a pre-operating check to assure the vehicle is in safe and proper working order every time you use it.

Body Posture

You and your passenger must position your body weight to lessen the hazard of tipping over. You and your passenger must keep your feet on your respective footrests at all times, and your passenger should always hold the grab handles.

Starting Procedure

The proper method for starting the vehicle.

Uphill and Downhill Riding

The proper method of travelling up and down hills with or without a passenger.

Backing Up

The proper method for backing up.

Sidehilling

The proper method for traversing a hill with or without a passenger.

1. Avoid doing it.
2. Weight transfer.
3. Emergency dismount.

Riding with a Passenger or Load

Handling and braking ability changes when carrying a passenger or load.

Water Crossing

Use caution while crossing water.

Vehicle Transportation

Proper method for loading and preparing the 2-UP vehicle to be transported.

1. Apply parking brake.
2. Transmission lever on PARK position.
3. Turn off fuel valve.
4. Make sure fuel and oil caps are tight
5. Secure front and rear of vehicle

Law Observance

Refer to section I.

C) Recap

- Questions and answers.
- Review of the CPSC injury and death data.
- Review of safety messages, such as wearing protective head gear and clothing.

Expected Results

Upon completion of this section, you should:

- Know the content of the Bombardier 2-UP vehicle *Safety Videocassette*.

SECTION III – OPERATOR’S GUIDE REVIEW

Objective

The purpose of this section is to:

- a) Emphasize the importance of observing the warning and caution symbols.
- b) Review the *Operator’s Guide* and be familiar with the important points of each section.

Outline

A) Warning and Caution Symbols

- Note the warning and caution symbols in each section and what they are warning about; know the consequences of not following these warnings.

B) *Operator’s Guide* Review

- Note the important points of the *Operator’s Guide*:
 1. Table of Contents
 2. Notice Page
 3. Special Safety Messages
 4. Operation Warnings

5. Riding Tips
6. Warning Labels
7. Vehicle Identification Number
8. Controls/Instruments/Equipment
9. Break-In Period
10. Pre-Operation Check
11. Operating Instructions
12. Special Procedures
13. Post-Operating Care
14. Cargo and Transportation
15. Maintenance.

Expected Results

Upon completion of this section, you should:

- Be familiar with the need to review the *Operator’s Guide* frequently.
- Know the meaning of the warning and caution symbols in the *Operator’s Guide* and what they refer to.
- Know all sections in the *Operator’s Guide* and what they refer to.

SECTION IV – HANDS-ON RIDING

Objective

The purpose of this section is to:

- a) Familiarize you with the pre-operation check.
- b) Remind you about the protective clothing that should be worn by you and your passenger while riding the 2-UP vehicle.
- c) Have you drive the 2-UP vehicle and perform all of the basic maneuvers.

Outline

A) Pre-Operation Checks

- Perform pre-operation check on the 2-UP vehicle, using the checklist from the *Operator's Guide* and identify all controls.

B) Protective Clothing

- Wear the proper clothing when riding the 2-UP vehicle:
 1. approved helmet (with a rigid chin guard for the passenger)
 2. riding boots
 3. gloves
 4. eye protection
 5. long sleeve shirt
 6. long Pants
 7. elbow pads (optional)
 8. knee pads (optional)
 9. kidney belt (optional).

C) Basic Maneuvers

- Drive the course performing all of the basic maneuvers described in the attached DRIVING MANEUVER LIST, without a passenger.
 1. Dealer representative demonstrates each of the maneuvers first.
 2. You perform the maneuver without passenger, after being shown how.
 3. Dealer representative checks off the scoring chart when you have completed the maneuvers satisfactorily.
 4. Dealer representative and you continue with the maneuvers one at a time until all have been performed, and checked off.

Expected Results

Upon completion of this section, you should:

- Know how to do a pre-operation check.
- Know the proper clothing to be worn by you and the passenger while riding your 2-UP vehicle.
- Have performed all of the basic riding maneuvers on the riding course.

DRIVING MANEUVER LIST

Hands-on riding practice should incorporate the maneuvers described below. Trainees are required to perform a minimum number of repetitions of each of the eight driving maneuvers. The person giving the training must demonstrate each maneuver and then have the trainee repeat the following minimum number of repetitions.

Maneuver # 1

Starting and stopping practice on a large oval course (minimum repetition: once counterclockwise and once clockwise).

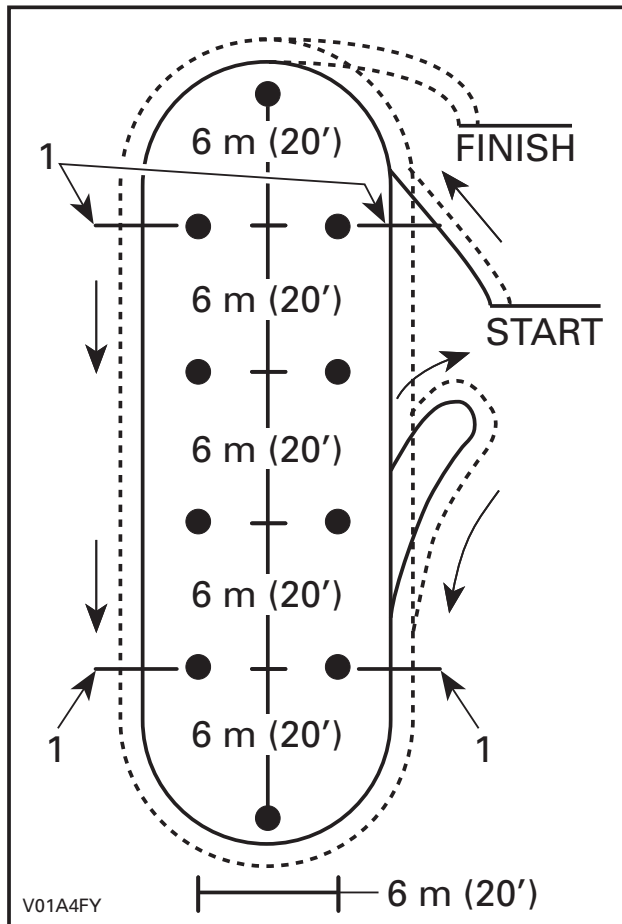

TYPICAL

1. Stop here

Maneuver # 2

Turning left and right - figure 8's (minimum repetition: three times).

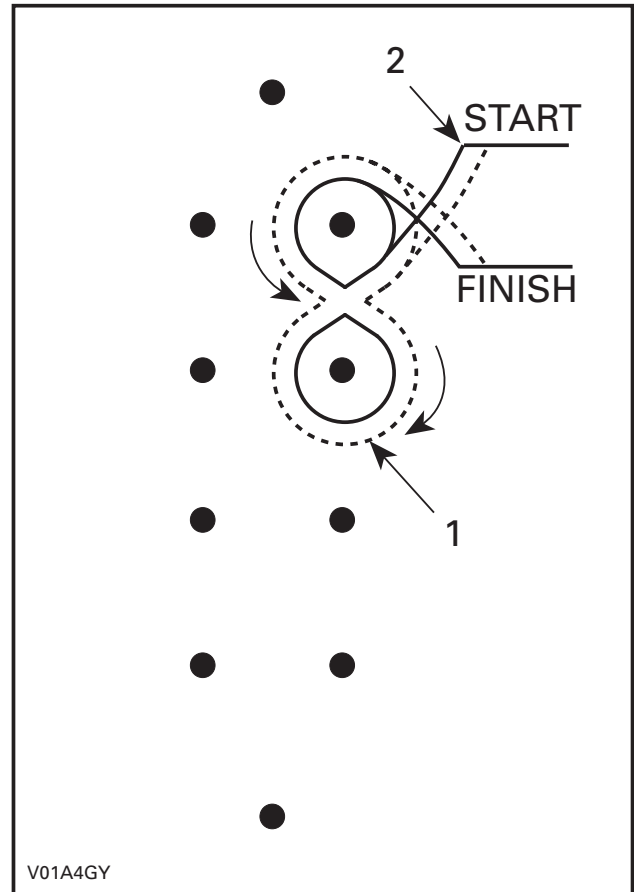

TYPICAL

1. 2 laps or more
2. Finish of 1st maneuver

Maneuver # 3

Sharp turns less than 90° - left and right. Corners 90 degrees and less than 90 degrees (minimum repetition: two clockwise and two counterclockwise).

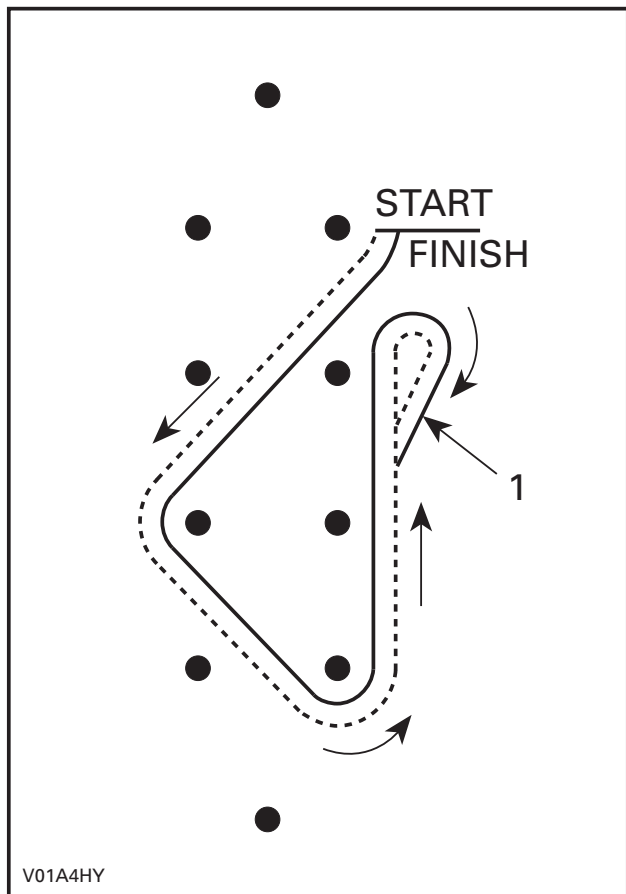

TYPICAL

1. Reverse range

Maneuver # 4

Slalom (minimum repetition: three times).

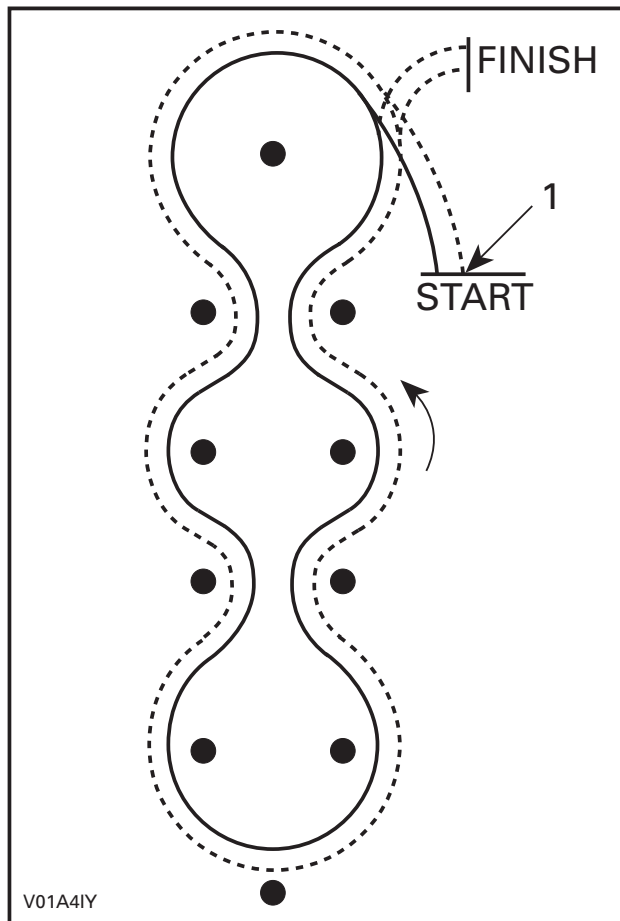

TYPICAL

1. Finish of last maneuver

While reading this *Operator's Guide*, remember that:

WARNING

Indicates a potential hazard that, if not avoided, could result in serious injury or death.

Maneuver # 5

Quick stop: large oval with panic maneuver (minimum repetition: two times).

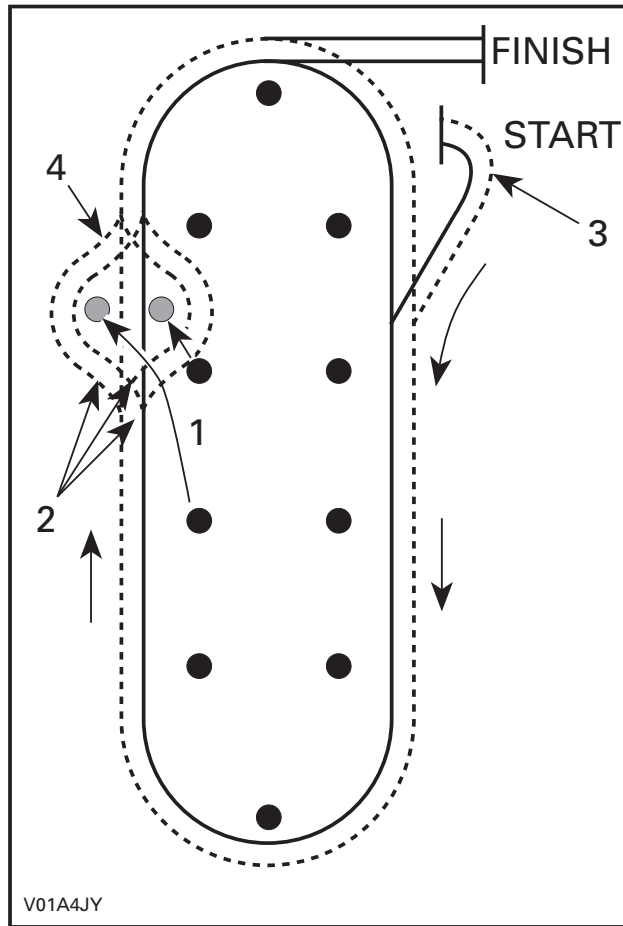

TYPICAL

1. Move 2 cones
2. Instructor specifies left, right or straight on command
3. Finish of last maneuver
4. Instructor signal panic turnout

Maneuver # 6

Riding over obstacle (minimum repetition: once with left wheels, once with right wheels, and once with both wheels).

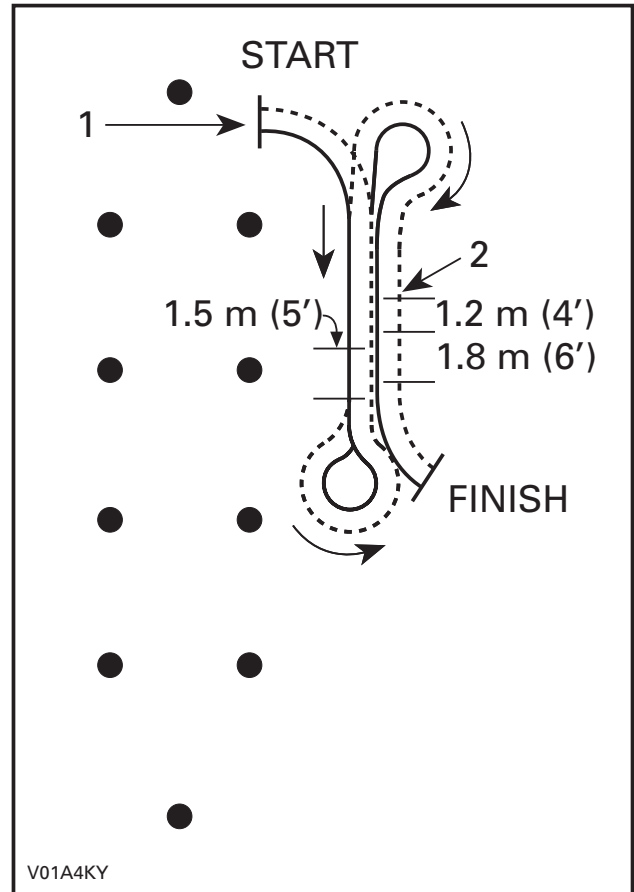

TYPICAL

1. Finish of last maneuver
2. Obstacle

Maneuver # 7

Traversing hills (minimum repetition: once each direction).

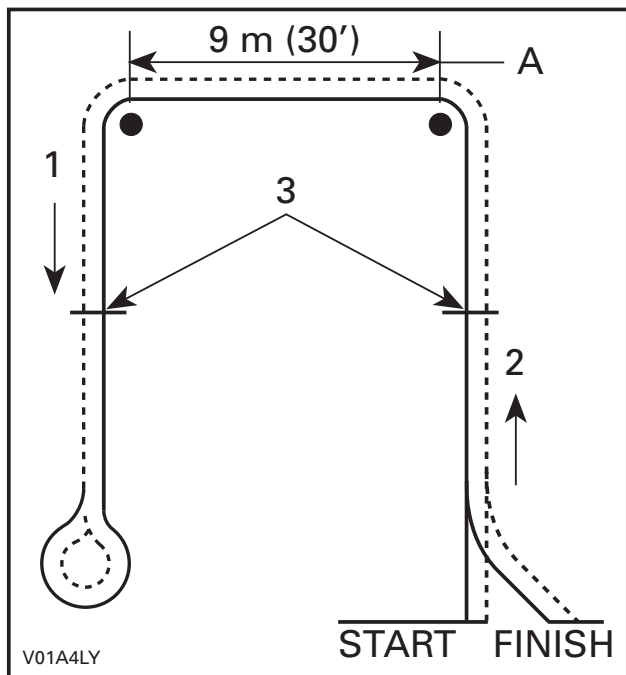

TYPICAL

1. Down
2. Uphill
3. Stop and start here
- A. Traverse

Maneuver # 8

U-turn and K-turn (minimum repetition: one time).

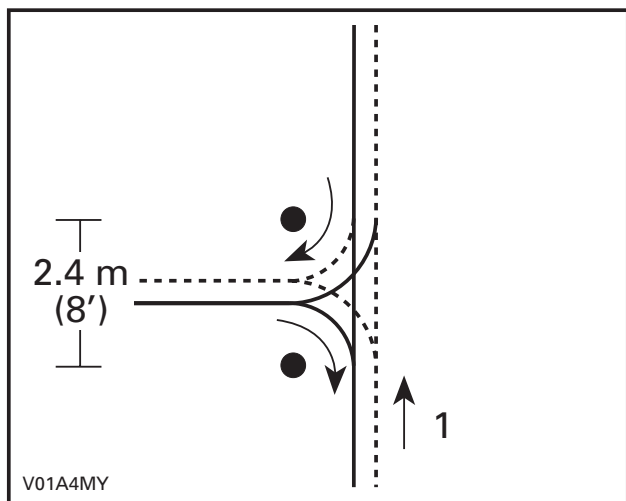

TYPICAL — K-TURN ON HILL WHERE AND IF AVAILABLE

1. Uphill

DEALER CHECK LIST

Name of 2-UP vehicle purchaser: _____

Name of dealer representative: _____

Date: _____

IMPORTANT: This 2-UP vehicle Safety Training Course is mandatory and must be completed for any new 2-UP vehicle purchaser.

Random checks will be performed by a third party agency to ensure the training is being performed.

Failure to perform the required training may lead to disciplinary sanctions from Bombardier, including the non renewal or termination of your dealership.

If you would like further information on the 2-UP vehicle Safety Training Course, please contact the service department at 1 800 366-6992 in the US or 1 800 361-9980 in Canada.

Introduction:

- Make sure your trainee carefully reads the content of the Customer Safety Training Guide.

Section I: General Safety Information

- Explain the reason for safety training.
- Discuss CPSC Injury and Death Statistics.
- Discuss Bombardier's age and size recommendations.
- Discuss what protective clothing should be worn by the operator and the passenger while riding the 2-UP vehicle.
- Discuss local, state and federal laws pertaining to ATV use.
- Discuss what areas are acceptable to ride in.

Section II: Bombardier 2-Up Vehicle *Safety Videocassette*

- Review the Bombardier 2-UP vehicle *Safety Videocassette* with your trainee. Make sure to answer any questions your trainee may have.

Section III: *Operator's Guide* Review

- Review the *Operator's Guide* with your trainee. Emphasize the need for periodic and frequent reviews of the guide.
- Draw trainee's attention to the warning and caution symbols, and explain their meaning.

Section IV: Hands-On Riding

- Perform the pre-operation check with your trainee.
- Remind your trainee about the protective clothing that should be worn by driver and passenger while riding the 2-UP vehicle.
- Demonstrate each of the maneuvers to the trainee.
- Have the trainee drive the 2-UP vehicle and perform all of the following basic maneuvers.

1) Starting and Stopping

Starting and stopping practice on a large oval course (minimum repetition: once counterclockwise and once clockwise).

- Should have a starting area long enough so the operator has enough time to think about the next maneuver before he has to execute it.
- Should incorporate a braking area at least 9 m (30 ft) long in which the trainee will have to negotiate a stop, in a straight line, from various speeds.

2) Turning

Turning left and right - figure 8's (minimum repetition: three times).

3) Sharp Turns

Sharp turns less than 90° – left and right. Corners: 90 degrees and less than 90 degrees (minimum repetition: two clockwise and two counterclockwise).

4) Slalom

Slalom at least 4 markers – each 6 m (20 ft) apart (minimum repetition: three times).

5) Quick Stop

Quick stop as used in article I above. Large oval with panic maneuver (minimum repetition: two times).

6) Riding Over Obstacles

Riding over obstacles – 4 x 4 pieces of wood should be placed in vehicle's path so rider can drive over them (minimum repetition: once with left wheels, once with right wheels, and once with both wheels).

7) Traversing Hills

First, remind the trainee that sidehilling should be avoided if possible.

Where there is a hill available of approximately 8% incline or less, the course should be set up to use the hill to practice traversing (minimum repetition: once each direction). If there is no hill available, make sure to review the description of the maneuver in the *Operator's Guide* with the trainee.

8) K-Turn and U-Turn

Where there is a hill available of approximately 8% incline or less, the course should be set up to use the hill to practice K-turns and U-turns (minimum repetition: one time). If there is no hill available, make sure to review the description of the maneuver in the *Operator's Guide* with the trainee.

- Complete checklist and score card. Purchaser and dealer representative must sign.**
- Copy checklist and score card for your records.**

Trainee's Scoring Chart

EXERCISE	PASS	FAIL
1. Starting and stopping		
2. Turning		
3. Sharp turns		
4. Slalom		
5. Quick stops		
6. Riding over obstacles		
7. Traversing hills (if there is no hill available, make sure to review the description of the maneuver in the <i>Operator's Guide</i> with the trainee)		
8. K-turn and U-turn (if there is no hill available, make sure to review the description of the maneuver in the <i>Operator's Guide</i> with the trainee)		
9. Instructor comments: _____ _____ _____ _____		

NOTE: The dealer must make a photocopy of this scoring card for his record.

Signature of 2-UP vehicle purchaser: _____

Signature of dealer representative: _____

Date: _____

VEHICLE INFORMATION

HOW TO IDENTIFY YOUR ATV

The main components of your vehicle (engine and frame) are identified by different serial numbers. It may sometimes become necessary to locate these numbers for warranty purposes or to trace your vehicle in the event of loss. These numbers are required by the authorized Bombardier ATV dealer to complete warranty claims properly. No warranty will be allowed by Bombardier Inc. if the engine identification number (EIN) or vehicle identification number (VIN) is removed or mutilated in any way. We strongly recommend that you take note of all the serial numbers on your vehicle and supply them to your insurance company.

Engine and Vehicle Identification Number Location

Quest MAX Series

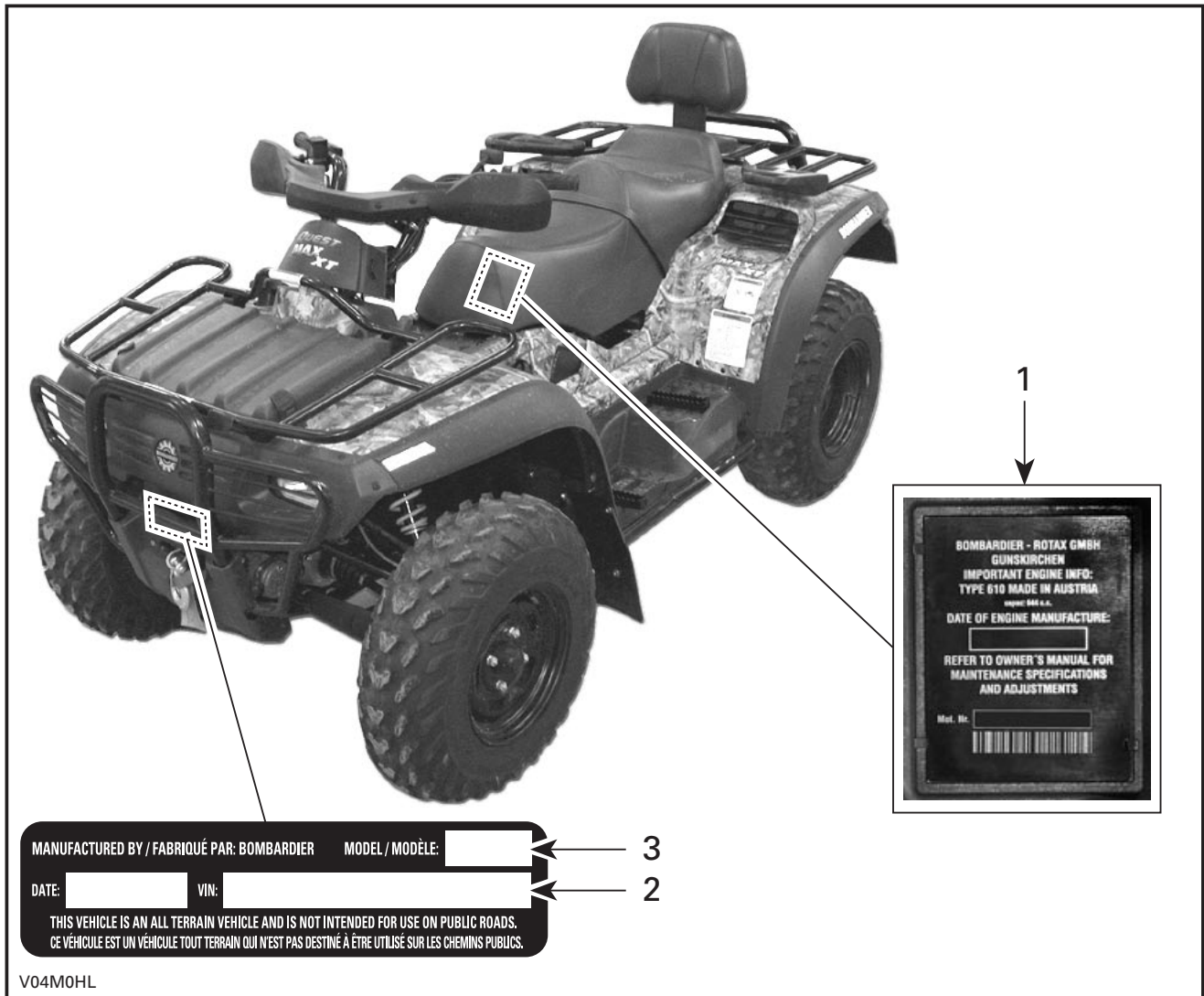

TYPICAL

1. EIN (Engine Identification Number)
2. VIN (Vehicle Identification Number)
3. Model

Traxter MAX Series

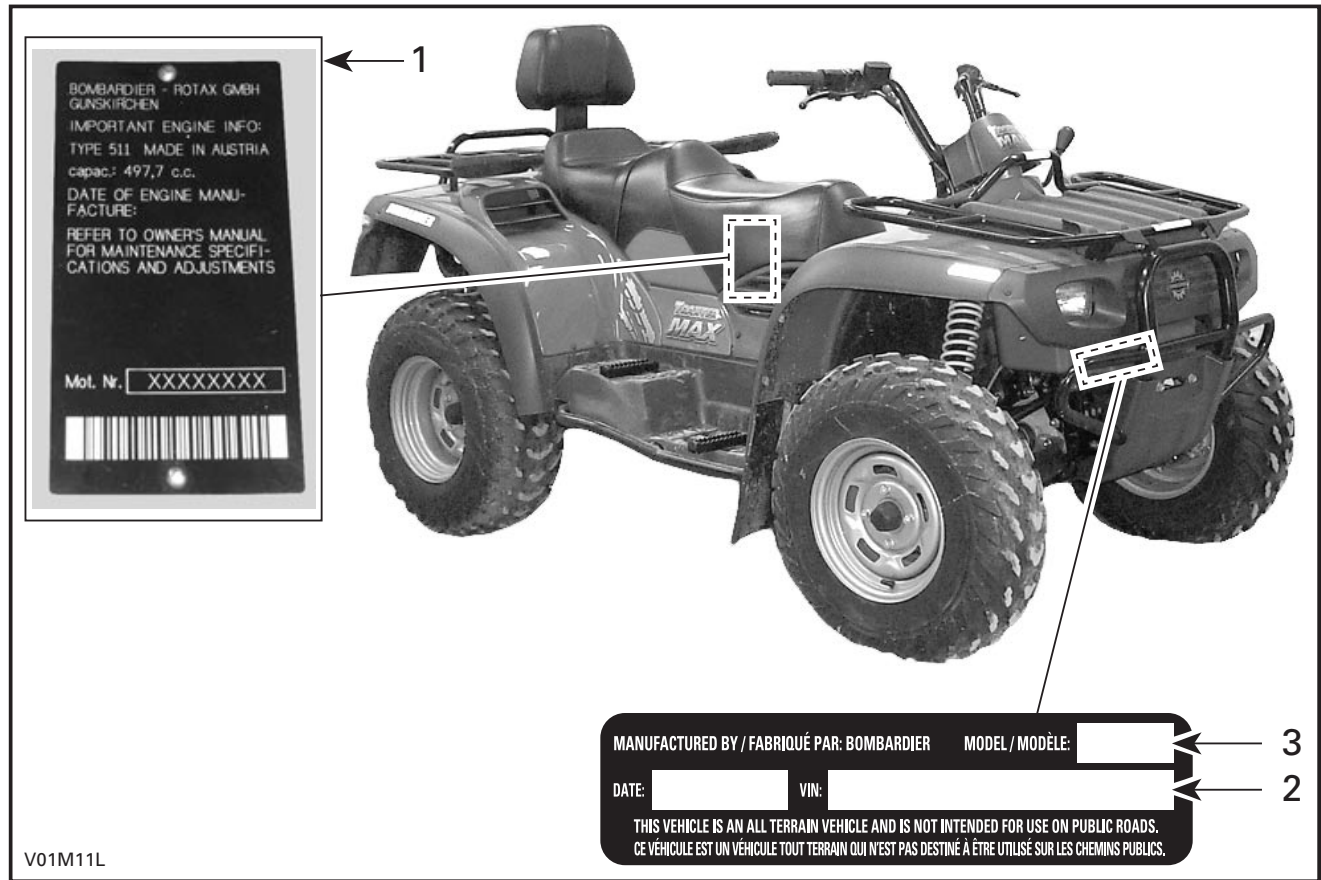

TYPICAL

1. EIN (Engine Identification Number)
2. VIN (Vehicle Identification Number)
3. Model

EMISSION REQUIREMENTS

The California Air Resources Board (CARB) requires that your ATV comply with applicable exhaust emissions standards during its useful life, when operated and maintained according to the instructions supplied.

A non-compliance Red Label (as well as a Green Label) is obtained annually during California Vehicle registration. The appropriate label is denoted by the vehicle identification number (in the 8th character detailed herein).

VEHICLE CATEGORY	VIN 8 th CHARACTER
Non-complying Red Label	Must denote a C or 3
Complying Green Label	Any alphanumeric designation other than a C or 3

CONTROLS/INSTRUMENTS/EQUIPMENT

NOTE: Some controls/instruments/equipment do not apply to some models. In these cases their reference numbers are deliberately missing in the illustrations. Some controls/instruments/equipment are optional on some models.

Quest MAX Series

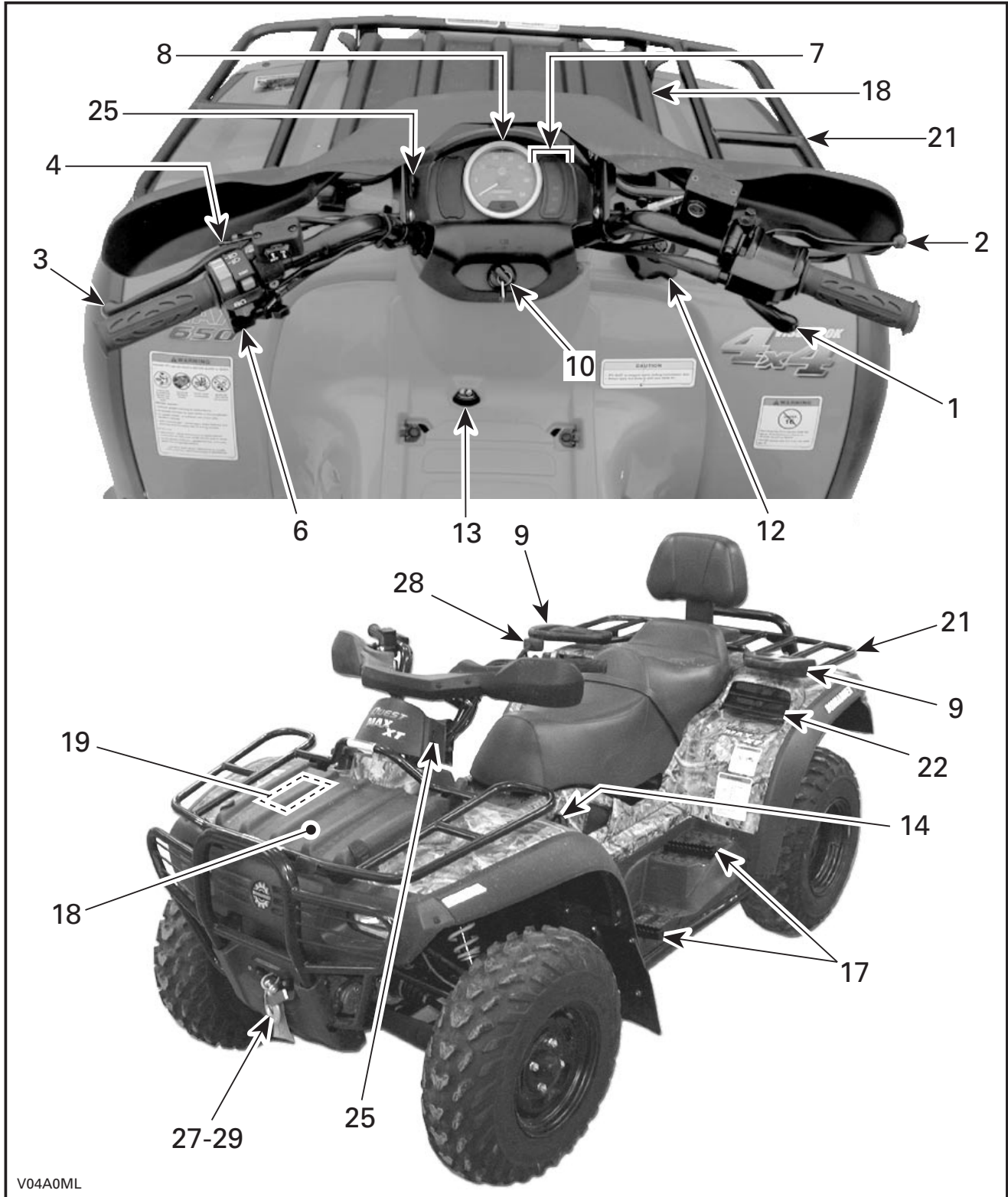

V04A0ML

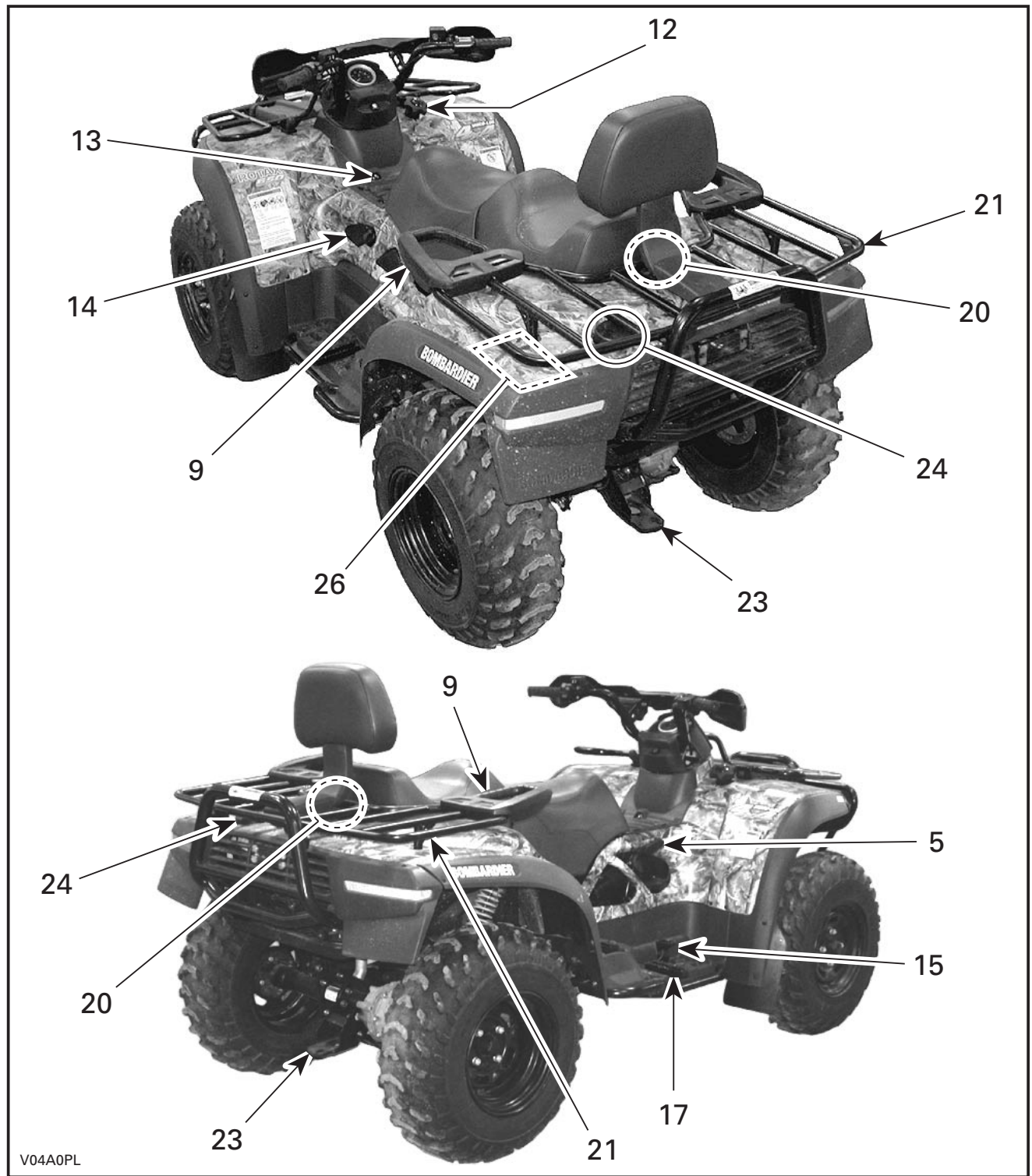

Traxter MAX Series

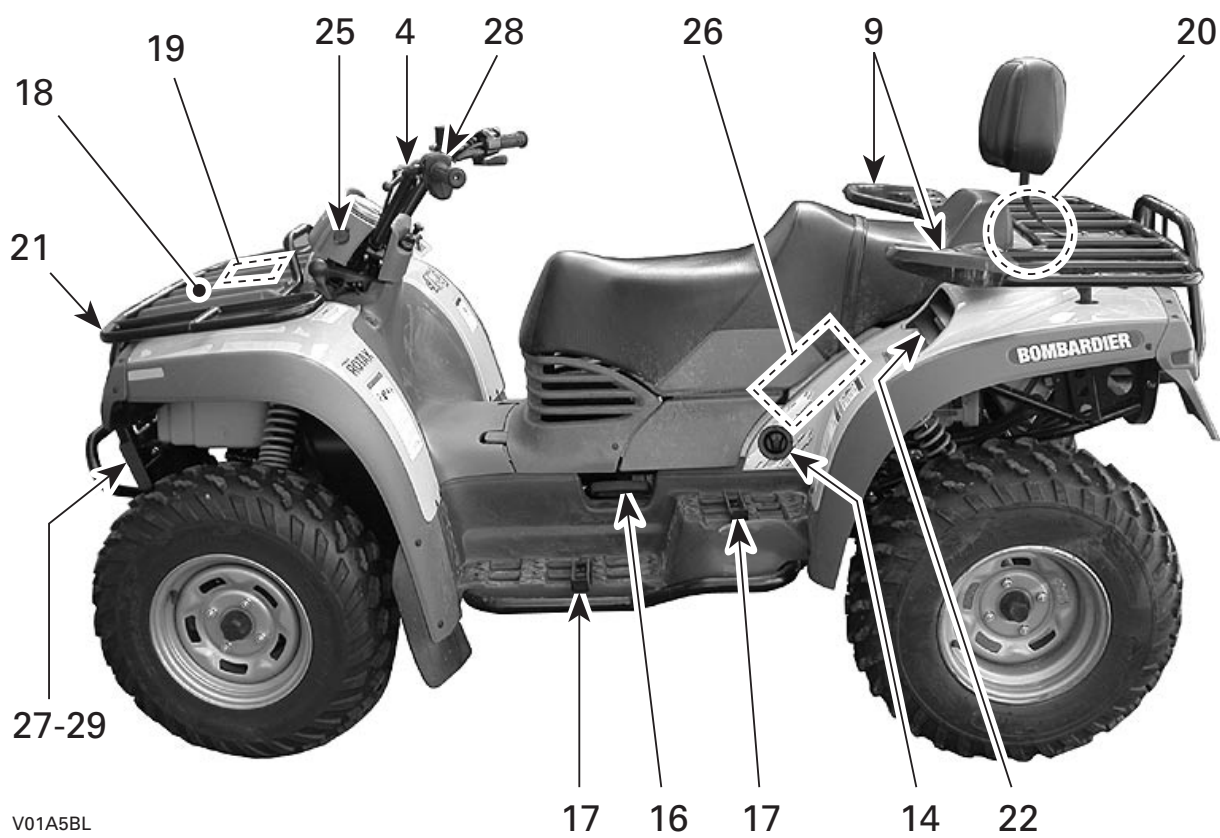
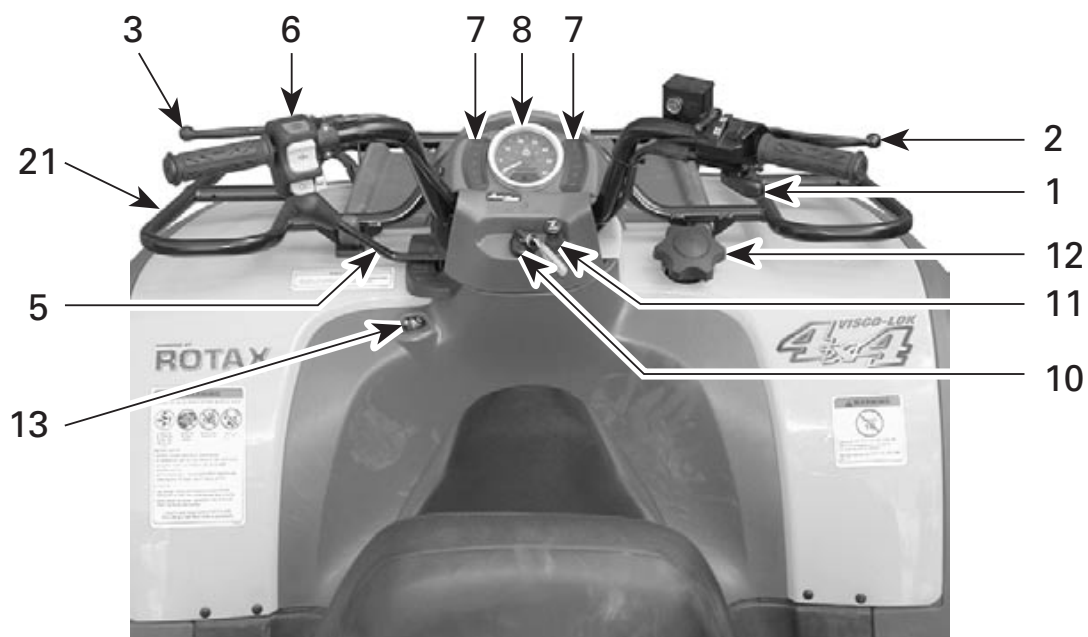

V01A5BL

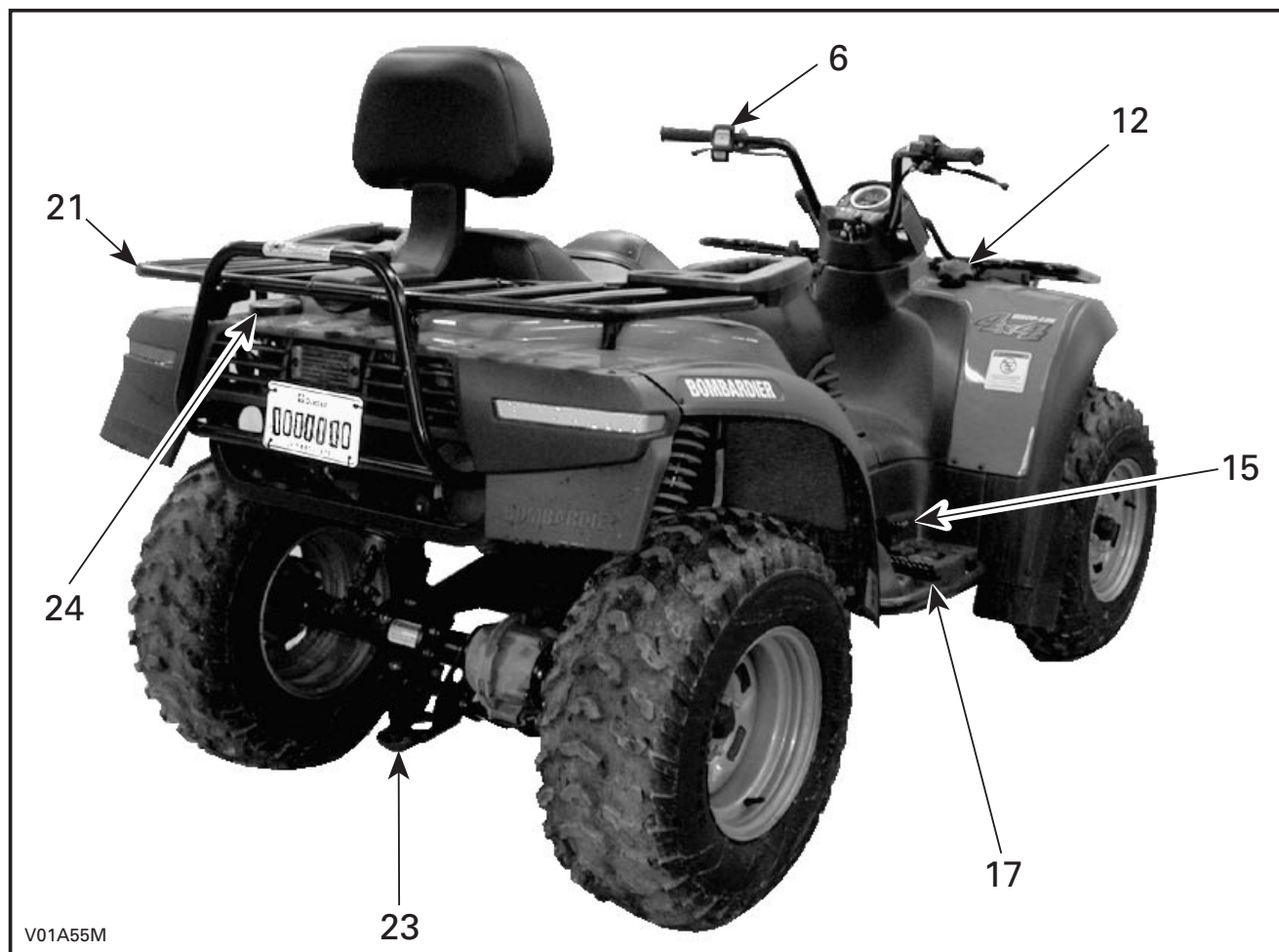

While reading this *Operator's Guide*, remember that:

WARNING

Indicates a potential hazard that, if not avoided, could result in serious injury or death.

NOTE: This section gives basic functions of the various controls of your ATV. For more details of how to operate one control in conjunction with some others, refer to OPERATING INSTRUCTIONS further in this section.

1) Throttle Lever

Quest MAX and Traxter MAX Series

Located on the right side of handlebar. When pushed, it increases the engine speed that allows the engagement of the transmission on the selected gear.

When released, the engine speed should return automatically to idle and the vehicle will gradually slow down.

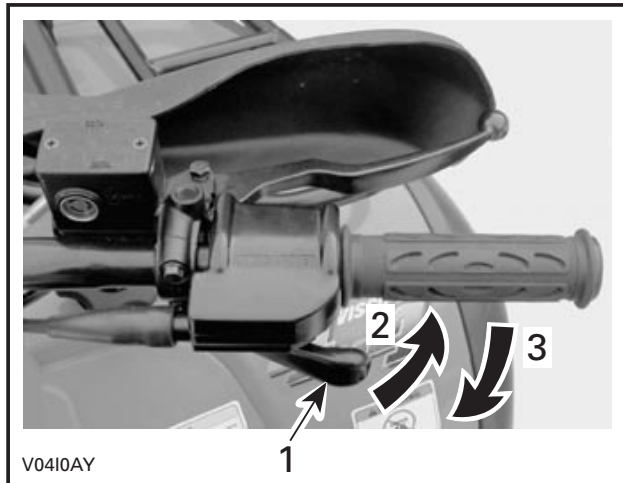

1. Throttle lever
2. To accelerate
3. To decelerate

2) Front Brake Lever

Quest MAX and Traxter MAX Series

Located on the right side of handlebar. When compressed, the brake is applied. When released, it should automatically return to its original position. Braking effect is proportional to the force applied on the lever and to the type and condition of the terrain. The front brake will have also an effect on rear wheels through the drive train.

See the note at REAR BRAKE LEVER below for additional information.

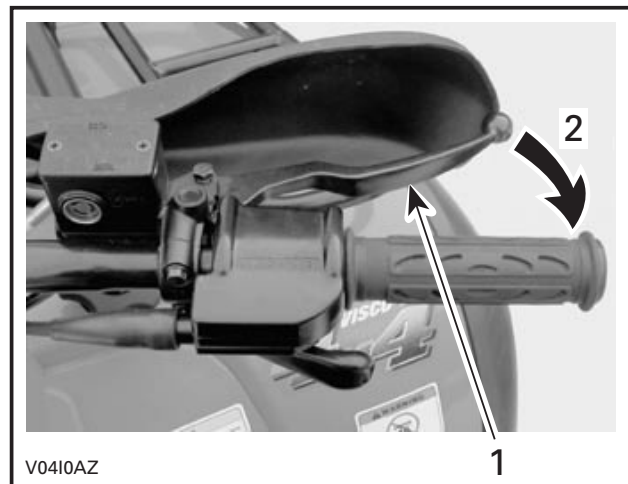

1. Brake lever
2. To apply brake

3) Rear Brake Lever

Quest MAX and Traxter MAX Series

Located on the left side of handlebar. When compressed, the brake is applied. When released, it should automatically return to its original position. Braking effect is proportional to the force applied on the lever and to the type and condition of the terrain.

NOTE: Using the rear brake will have also an effect on front wheels because they are interconnected through the drive train. As on other wheeled vehicles, the vehicle weight is transferred to the front wheels when braking. To obtain greater stopping efficiency, the brake system distributes more braking force to the front wheels. This will affect vehicle handling and steering control when braking vigorously. Take it into account when braking.

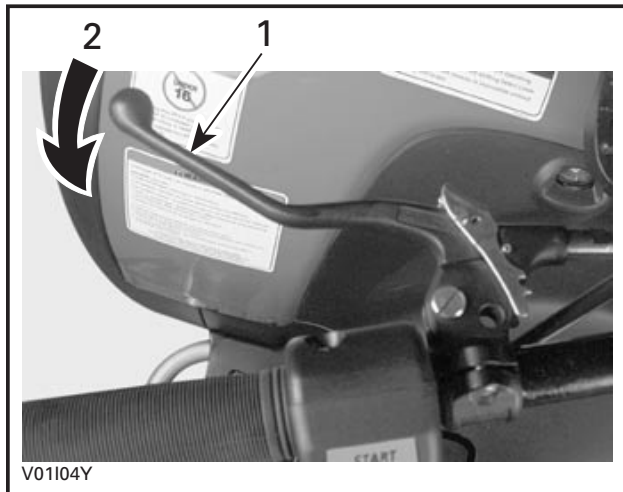

TYPICAL

1. Brake lever
2. To apply brake

4) Brake Lever Lock

Quest MAX and Traxter MAX Series

Located on left side of handlebar on the rear brake lever. When applied, it prevents the vehicle from moving. Useful when the brake needs to be locked for example such as doing a K-turn, during transportation or when the vehicle is not in operation.

⚠ WARNING

Always use the brake lever lock ***and*** engage the PARK position on the transmission lever when the vehicle is not in operation.

⚠ WARNING

Make sure brake lever lock is fully disengaged before operating the ATV.

When you ride the vehicle, brakes that are caused to drag by a continuous pressure on the lever may cause damage to the brake system and cause loss of braking capacity and/or fire.

To engage mechanism: Squeeze brake lever and maintain while moving lever lock. Brake lever is now compressed and applying rear brakes.

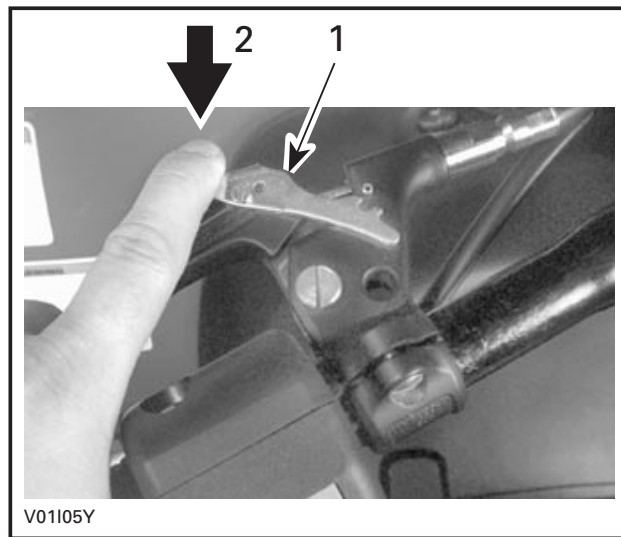

TYPICAL

1. Brake lever lock
2. Press to apply parking brake

To release mechanism: Squeeze brake lever. Lever lock should automatically return to its original position. Brake lever should return to rest position. Always release brake lever lock before riding.

5) Transmission Lever

Quest MAX Series

Located on the right side of vehicle. A 5-position lever: P, R, N, H and L.

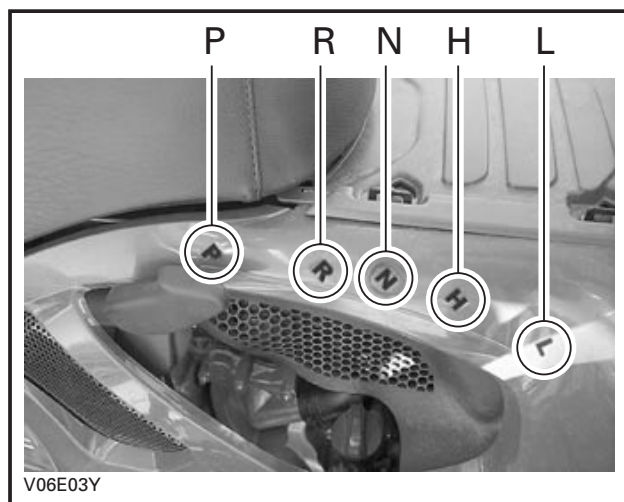

To change the transmission position, completely stop vehicle then move lever to the right then to the desired position while moving lever forward. Do not force lever. If unable to shift, rock the vehicle back and forth to move ATV and try again.

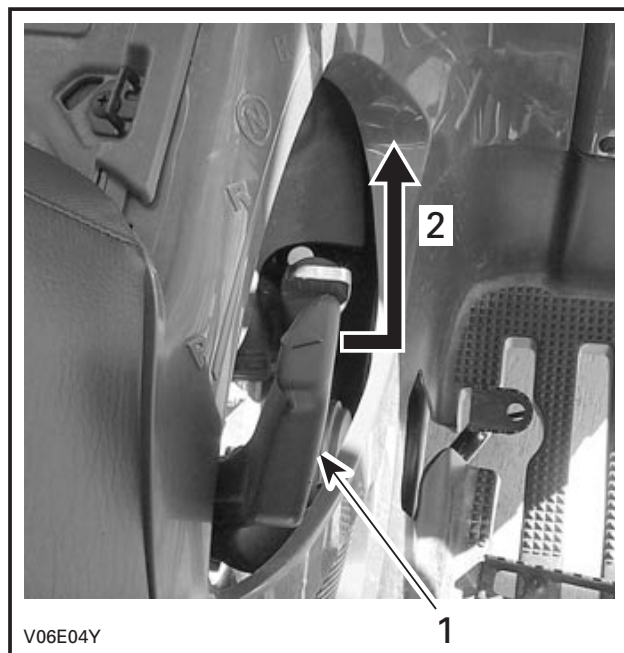

1. Transmission lever
2. To change position

CAUTION: Always completely stop the vehicle and apply the brake prior to moving the transmission lever.

Traxter MAX Series

Located on the left side of steering column. A 5-position lever: P, R, N, H and L.

To change the transmission position, completely stop vehicle then move lever to the desired position while pulling lever upward. Do not force lever. If unable to shift, rock the vehicle back and forth to move the vehicle and try again.

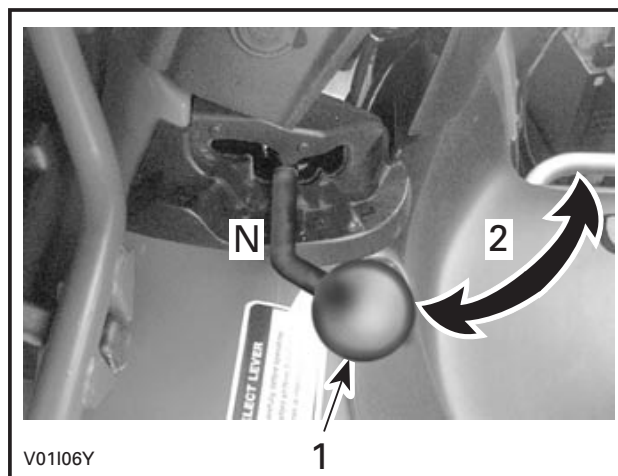

1. Transmission lever
2. To change position

CAUTION: Always completely stop the vehicle and apply the brake prior to moving the transmission lever.

Quest MAX and Traxter MAX Series

P: Park

This position locks the transmission to help prevent vehicle movement. Always use when the vehicle is not in operation. In some circumstances, it may be necessary to rock the vehicle back and forth to move the gears in the transmission to allow the park to be engaged.

R: Reverse

This allows the vehicle to go backward. The vehicle speed is limited.

WARNING

Before moving vehicle in reverse, ensure the path behind is clear of obstacles or bystanders. Remain seated.

N: Neutral

This position disengages the transmission to allow manual vehicle movement or towing.

H: High gear

This selects the high speed range of the transmission in the gear box. It is the normal riding position. It allows the vehicle to reach its maximum speed.

L: Low gear

This selects the low speed range of transmission in the gear box. It is the working position. It allows the vehicle to move slowly with the maximum traction and power.

NOTE: Use the low speed range to pull any load or to climb a steep slope.

6) Multi-Function Switch

Quest MAX Series

The multi-function switch is located on the left side of handlebar.

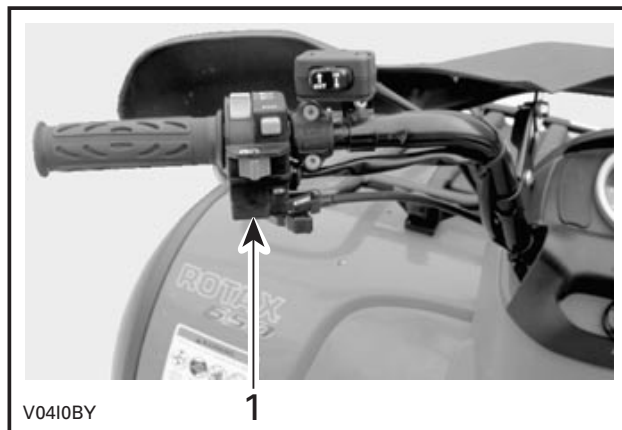

1. Multi-function switch

The controls located on this multi-function switch are:

Headlamp Switch

Located on the top of multi-function switch. Place headlamp switch to LO for the low beam and taillight. Place headlamp switch to HI for the high beam and taillight.

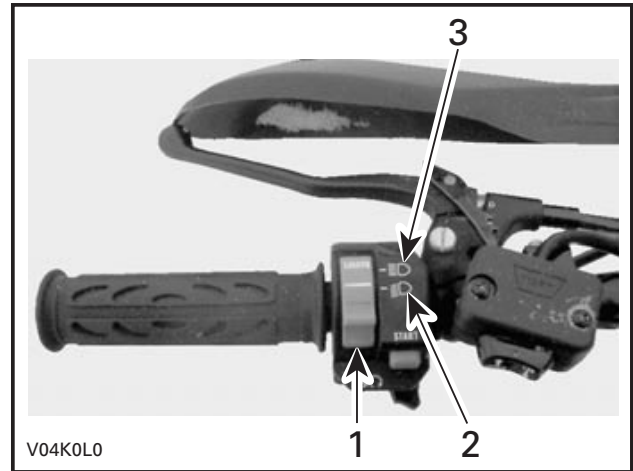

1. Headlamp switch
2. Low beam position
3. High beam position

NOTE: Place ignition switch to ON "without light" position to close the headlamp.



ON POSITION "WITHOUT LIGHT"

Engine Stop Switch

Located at the middle of multi-function switch. The engine will turn over but will not start if the engine stop switch is turned to OFF position.

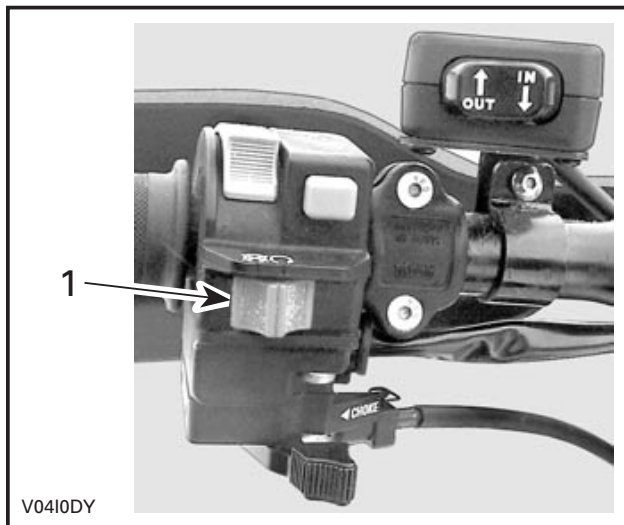

1. Engine stop switch

This switch can be used to stop engine and as an emergency control.

NOTE: While engine can be stopped by turning ignition key OFF, we recommend the engine be stopped by the engine stop switch.

To stop engine, fully release throttle lever then use the engine stop switch.

Start Button

Located above the engine stop switch.

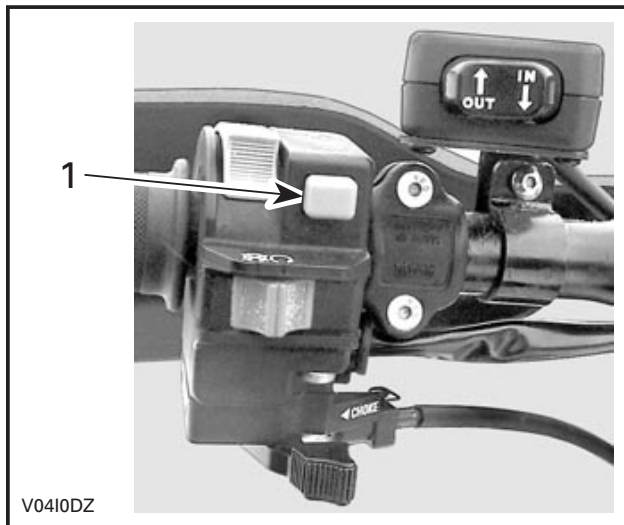

1. Start button

To start engine, place the engine stop switch to RUN.

Press and hold the start button. Release immediately after engine is started.

Choke Lever

Located at bottom of multi-function switch. This device features a variable lever to ease cold start.



CHOKE LEVER IN THE OFF POSITION

Position OFF is for normal use with a warm engine.

The full choke position is used for lower engine temperature.



CHOKE LEVER IN THE FULL CHOKE POSITION

The other positions between OFF and FULL position, will be use depending on the engine temperature.

Traxter MAX Series

The multi-function switch is located on the left side of handlebar.

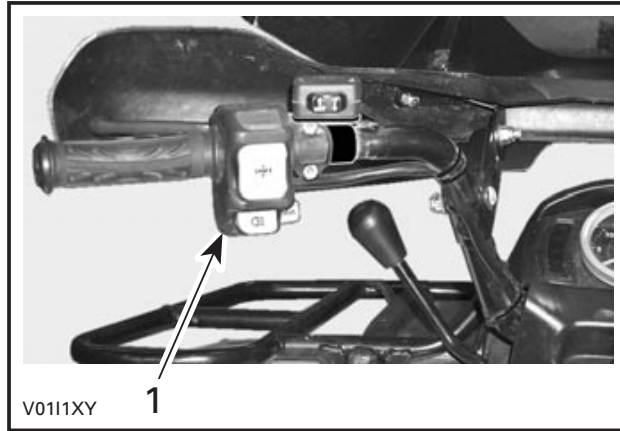

1. Multi-function switch

The controls located on this multi-function switch are:

Electric Gear Shift Button

Located at the middle of multi-function switch. When pressing on the upper face, it shifts the transmission to the next higher gear. When pressing on the lower face, it shifts the transmission to the next lower gear.

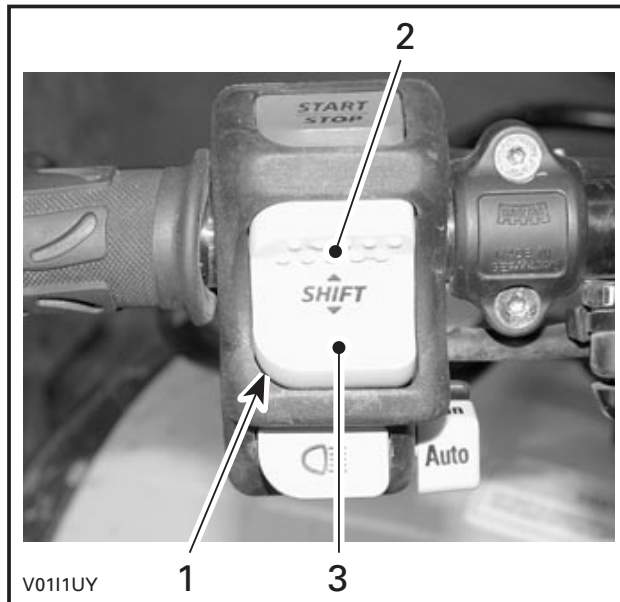

1. Gear shift button
2. Press here to upshift
3. Press here to downshift

The lower the gear, the slower the vehicle speed and the higher the gear, the higher the vehicle speed.

Vehicle must be running to allow gear change.

The button must be released then pressed again to perform another gear shift.

There are 5 gears in high and low gear positions.

On **Traxter MAX series**, all models feature a manual/autoshift selector located beside headlamp dimmer switch, at the bottom of the multi-function switch. It is possible to change the mode at any time, even when vehicle is running.

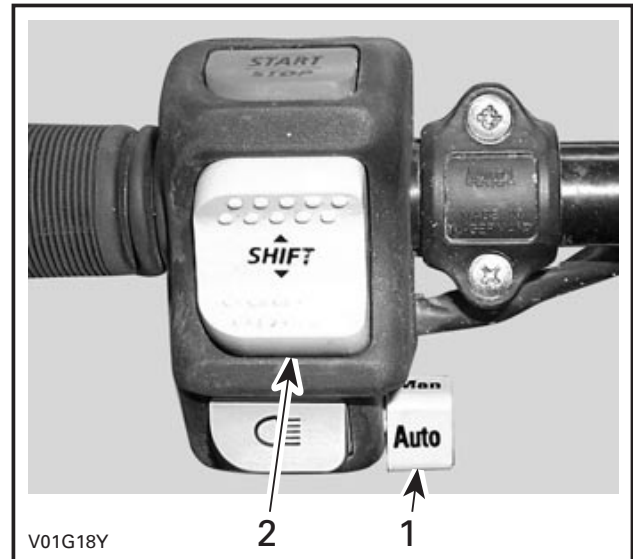

1. Manual/autoshift selector
2. Gear shift button

The autoshift mode activates a change of gear in accordance with the engine RPM and throttle opening. When autoshift mode is selected, just press or release throttle lever.

On some occasions, it may be useful or necessary to manually change the gear selection. The electronic module will allow the rider to override the autoshift mode by pressing the shift button to a lower gear or a higher gear. The autoshift mode will be kept and the shifting sequence will resume after shift is performed.

However, if the vehicle is used in severe conditions, it is highly recommended to use the manual mode (use the gear shift button).

Start/Stop Switch

Located on top of the multi-function switch. Dual function switch.

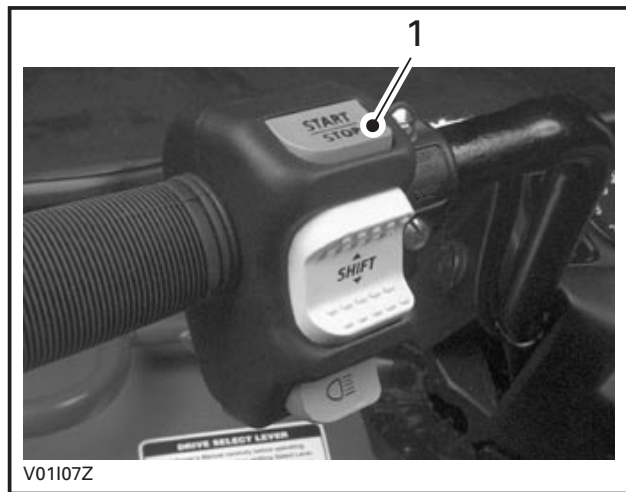

1. Start/stop switch

To start engine, press and hold the switch. Release immediately after engine is started.

To stop engine, fully release throttle lever then press the switch. It is not necessary to hold the switch.

NOTE: While engine can be stopped by turning ignition key OFF, we recommend the engine be stopped by pressing the start/stop switch.

Headlamp Dimmer Switch

Located under the electric gear shift button. Toggle type switch. It allows selection of headlamp intensity.

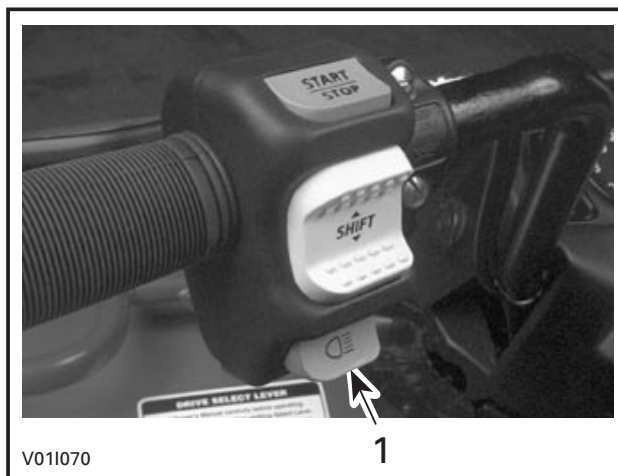

1. Headlamp dimmer switch

7) Indicator Lights Cluster

Quest MAX and Traxter MAX Series

NOTE: When first turning switch to ON (either position), all indicator lights will turn on for a brief moment. This validates their operation. Thereafter, only the lights that are activated will remain on: P, R or N for the **Quest MAX series** and R, N, AUTO, high intensity and gear position for the **Traxter MAX series**.

NOTE: Oil pressure light (**Quest MAX series**) and temperature light (**Traxter MAX series**) stay on until the engine runs.

On **Traxter MAX series**, if all lights flash, it indicates a particular malfunction of the transmission or the electrical system. See an authorized Bombardier ATV dealer as soon as possible.

Traxter MAX Series

Gear Position Display

Located on left side of cluster. It lights up to indicate the gear position whenever the ignition switch is turned on when the transmission lever is NOT in PARK or in NEUTRAL position (whether or not engine is running).

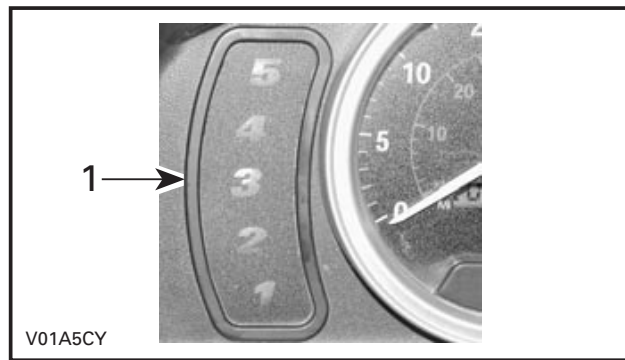

1. Gear position display

If all lights flash **while shifting gear**, it indicates the shifting is not completed yet. Simply wait until the shifting completes or retry the shift with the gear shift button.

If all lights flash **continuously**, it indicates a damaged sensor (gearbox). Although the vehicle can still be operated in this condition, downshifting may increase engine "braking". Drive slowly. See an authorized Bombardier ATV dealer as soon as possible.

Other Indicator Lights

Located on right side of cluster. They light up to monitor different functions.

Quest MAX Series

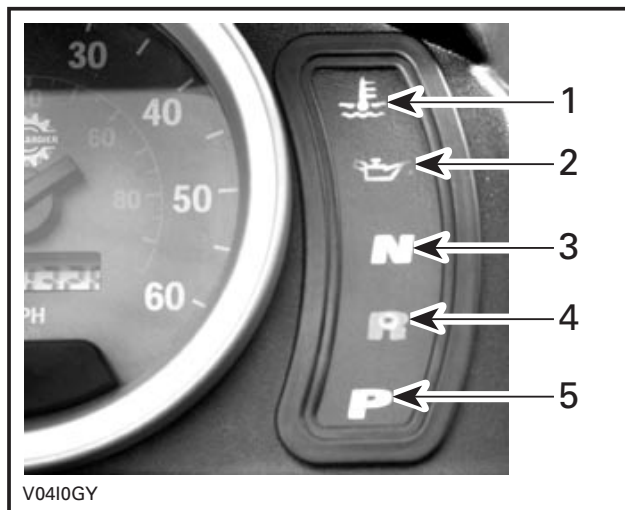

1. Engine temperature
2. Oil pressure
3. Neutral
4. Reverse
5. Park

Traxter MAX Series

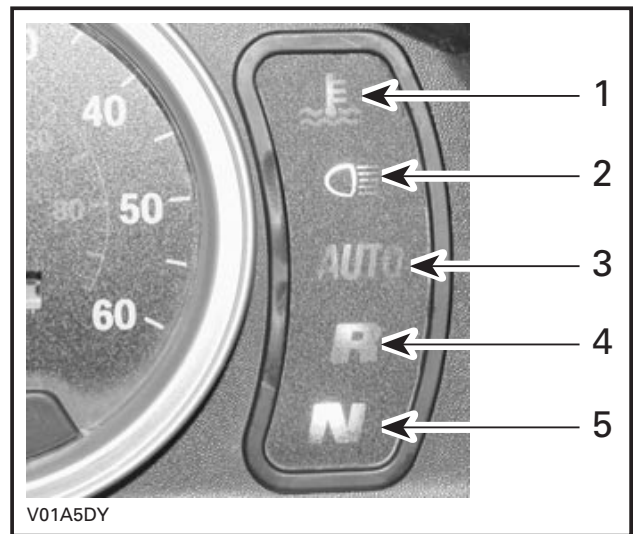

1. Engine
2. High intensity
3. Auto (autoshift mode)
4. Reverse
5. Neutral

If REVERSE and NEUTRAL lights flash **continuously**, it indicates a damaged sensor (sub-transmission). Although the vehicle can still be operated in this condition, downshifting may increase engine "braking". Drive slowly. See an authorized Bombardier ATV dealer as soon as possible.

If AUTO light flashes, it indicates a possible problem with the TPS sensor. The manual mode is immediately selected. See an authorized Bombardier ATV dealer as soon as possible.

Indicator Lights Description

Engine (RED)



Quest MAX Series

When this indicator light is ON, it indicates the engine is overheating.

Traxter MAX Series

Dual function light. When indicator light is ON, it indicates a low oil pressure condition of the engine. When flashing, it indicates the engine is overheating.

This light turns on when the ignition switch is turned on and remains on until engine is running.

If engine overheats, refer to ENGINE OVERHEAT in SPECIAL PROCEDURES.

CAUTION: If the light does not turn off right after engine starting, stop engine. See an authorized Bombardier ATV dealer. Do not use the vehicle until repaired.

Oil Pressure (RED)



Quest MAX Series

When this indicator light is ON, it indicates a low oil pressure condition of the engine.

CAUTION: If the light does not turn off right after engine starting, stop engine. Check engine oil level. Refill if necessary. If the oil level is good, see an authorized Bombardier ATV dealer. Do not use the vehicle until repaired.

High Intensity (BLUE)



Traxter MAX Series

When the indicator light is ON, it indicates high intensity is selected on the headlamps.

Auto (AMBER)



Traxter MAX Series

When lit, it indicates the vehicle is operating in autoshift mode.

Reverse (RED)



Quest MAX and Traxter MAX Series

When lit, it indicates the transmission is engaged in reverse.

Neutral (GREEN)



Quest MAX and Traxter MAX Series

When lit, it indicates the transmission is in neutral position.

Park (AMBER)



Quest MAX Series

When lit, it indicates the transmission is in park position.

8) Speedometer

Quest MAX and Traxter MAX Series

These vehicles are equipped with an electronic speedometer. It indicates the speed of the vehicle either in MPH and km/h.

The speedometer is located at the middle of cluster and it is backlit when the ignition switch is turned ON (either position).

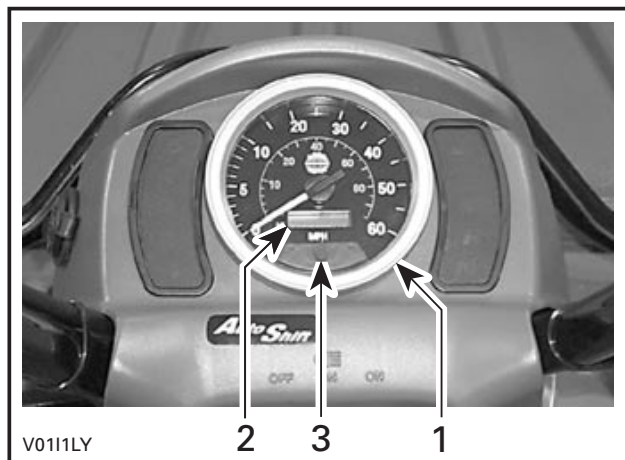

1. Speedometer
2. Odometer/trip meter/hourmeter
3. Display selection button

Change from One Unit to the Other

The speedometer is factory pre-set in miles but it is possible to change its reading to kilometers.

NOTE: The unit modification is applied to the speedometer, odometer and trip meter.

With the ignition switch OFF.

Press and hold the display selection button then turn the ignition switch ON.

The number **514610** for a **Quest MAX**; or **511---** for a **Traxter MAX** will appear in the display. Hold button until the normal display comes back (approximately 7 seconds).



QUEST MAX SERIES

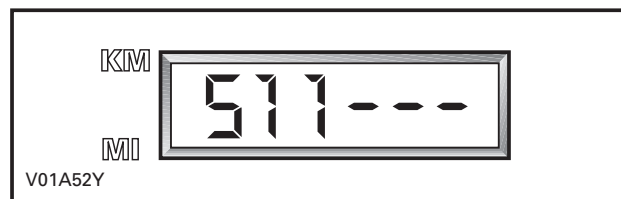

TRAXTER MAX SERIES

After these 7 seconds, the units should be changed from miles to kilometers or vice-versa.

NOTE: A dash appears on the left side of the LCD display to indicate which unit is used.

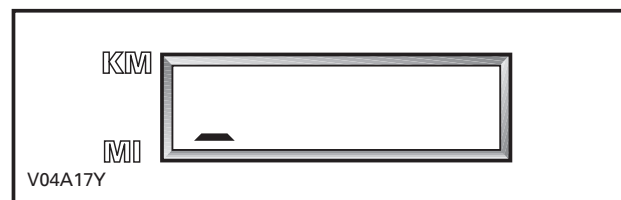

This speedometer being used on many models, it is factory pre-set. However, if the speedometer shows a number applying to another model, release and repress the display button. The number should be changed for the proper number. Hold the button to change the unit until the normal display comes back.

Odometer/Trip Meter/Hourmeter

Combined LCD (Liquid Crystal Display) display. Odometer records the total distance traveled **in miles or in km/h (00000)**. The trip meter records the distance traveled **in miles or in km/h (000.0)** until it is reset. The last right digit indicates the tenth of a mile or in km/h (on trip meter mode only). It can be used to approximately monitor the fuel tank range or distance between two locations for instance. The hourmeter records total hours when the ignition switch is turned ON (**H0000.0**).

Display Selection Button

To change the display momentarily press the button on the speedometer. The display will indicate odometer/trip meter/hourmeter, one after the other.

To reset the trip meter, push and HOLD button until all numbers read zero. The trip meter can be reset at any time, even if the odometer or the hourmeter is selected.



TYPICAL

The odometer can indicate in miles or in kilometers depending which unit is selected.

9) Rear Passenger Grab Handles

Quest MAX and Traxter MAX Series

The grab handles are located on each side of passenger seat.

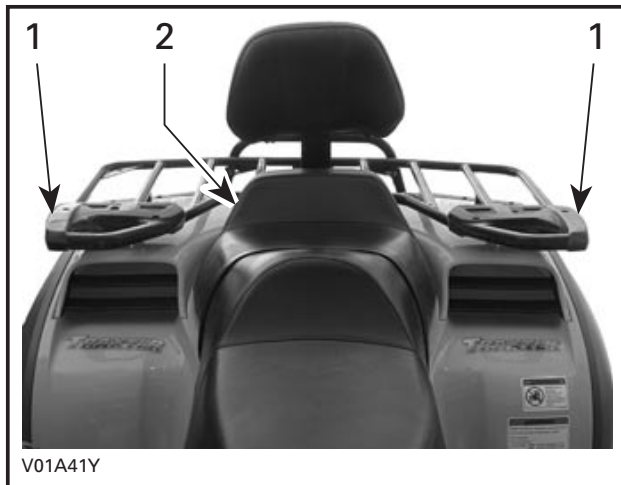

1. Grab handles
2. Passenger seat

The grab handles must be used by the passenger to hold on firmly during vehicle operation.

⚠ WARNING

Never hold on to the operator. Always hold the grab handles firmly.



10) Ignition Switch

Quest MAX and Traxter MAX Series

Located at bottom of cluster.

Key-operated, 3-position switch: OFF, ON with lights and ON without lights.

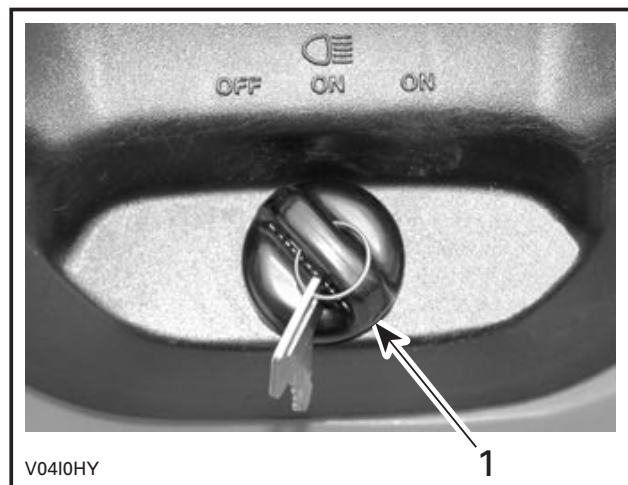

QUEST MAX SERIES

1. Ignition switch

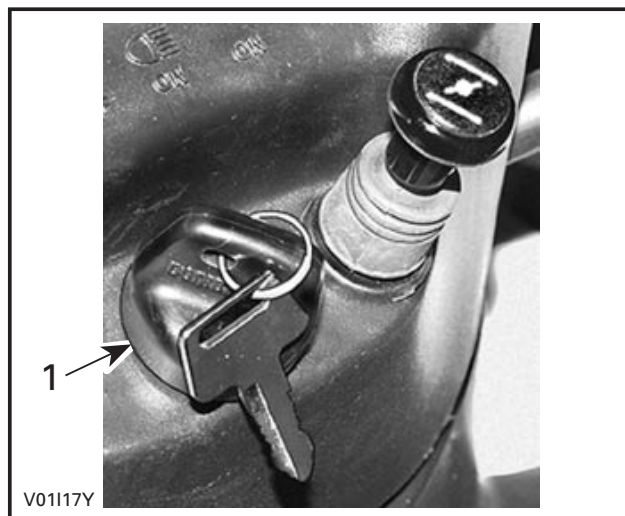

TRAXTER MAX SERIES

1. Ignition switch

Insert key in switch and turn to the desired position. To remove key, turn key to OFF then pull it out.

The ON with lights position, turns on all lights with either the engine running or not. The headlamps automatically dim to low intensity. Remember that having the lights on without the engine running discharges the battery. Always turn ignition to OFF after engine has been stopped.

NOTE: While engine can be stopped by turning ignition key OFF, we recommend the engine be stopped by pressing the start/stop switch.

Traxter MAX Series

Auto Shut-Down

If for some reason, the engine is not started within approximately 6 minutes, the MPEM (Multi-Purpose Electronic Module) will shut down to cut all electrical system functions. Simply turn the key to OFF then to ON to regain normal use.

11) Choke Knob Lever

Traxter MAX Series

Located at bottom of cluster. This device features a variable lever to ease cold start.

Position OFF is for normal use with a warm engine (pushed in).



CHOKE KNOB LEVER IN THE OFF POSITION

The full choke position is used for lower temperature (fully extended).

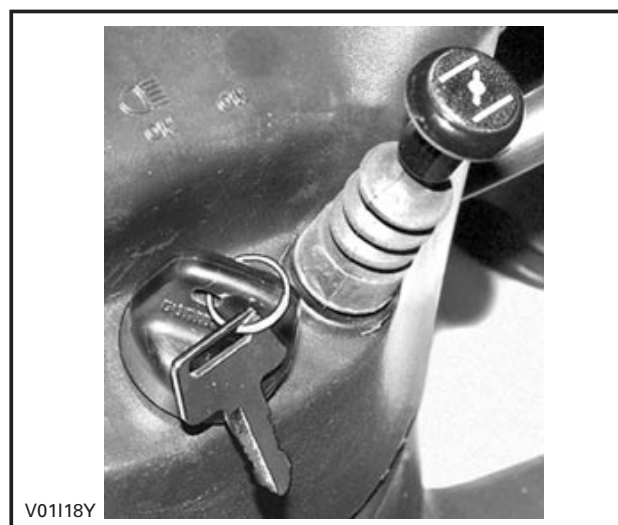

CHOKE LEVER IN THE FULL CHOKE POSITION

The other positions between OFF and FULL position, will be use depending on the temperature.

To adjust the choke lever resistance, lift the rubber bellows then screw the choke lever nut with your fingers. Do not torque excessively because the choke lever won't move easily. Put back the rubber bellows in its original position.

12) Fuel Tank Cap

Quest MAX and Traxter MAX Series

Unscrew counterclockwise and remove cap to allow fuel tank filling then fully tighten clockwise.

⚠ WARNING

Always stop engine before refueling. Open cap slowly. If a differential pressure condition is noticed (whistling sound heard when loosening fuel tank cap) have vehicle inspected and/or repaired before further operation. Fuel is flammable and explosive. Never use an open flame to check fuel level. Never smoke or allow flame or spark in vicinity. Always work in a well-ventilated area. Never top off the fuel tank before placing the vehicle in a warm area. As temperature increases, fuel expands and may overflow. Always wipe off any fuel spillage from the vehicle.

13) Fuel Gauge

Quest MAX and Traxter MAX Series

Located under cluster, the gauge shows an approximate amount of the fuel in tank.



14) Fuel Valve

Located on left side panel under front part of seat. This is a 3-position rotary valve: OFF, ON, RES. Rotate the knob to align its pointer with ON, OFF or RES.

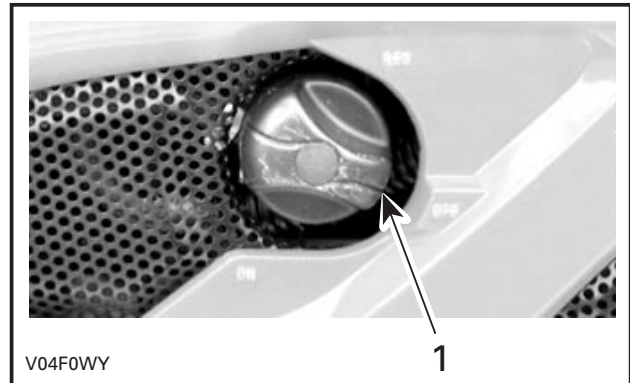

QUEST MAX SERIES

1. Align this pointer toward the desired position

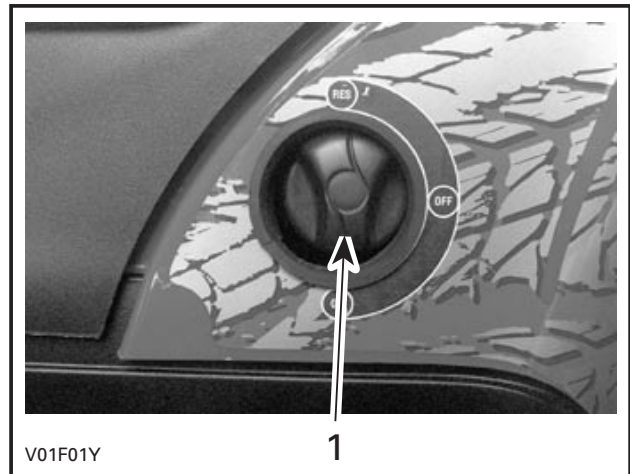

TRAXTER MAX SERIES

1. Align this pointer toward the desired position

OFF

Stops fuel supply to carburetor.

CAUTION: Turn valve to OFF position when the vehicle is not being operated or when transporting.

ON

Allows fuel to flow to carburetor. This is the normal position for operation of the vehicle.

RES (reserve)

When fuel is exhausted in the fuel tank when in the ON position, an emergency supply of fuel is available by turning the knob to RES. The reserve contains approximately 20% of the fuel tank capacity for a **Quest MAX** and 30% for a **Traxter MAX**. Use this position only when the ON supply is empty.

When down to the reserve, refuel as soon as possible. Be sure to turn the valve back to the ON position after refuelling.

CAUTION: Improper opening of fuel valve will restrict the flow of fuel. Make sure valve is fully opened while running.

15) Rear Brake Pedal

Quest MAX and Traxter MAX Series

Located on the right footrest. When pressed down, the rear brake is applied. When released, it should return to its original position. Braking effect is proportional to the force applied on the pedal and to the type and condition of the terrain.

NOTE: The brake will have also an effect on front wheels through the drive train.



QUEST MAX SERIES

1. Rear brake pedal

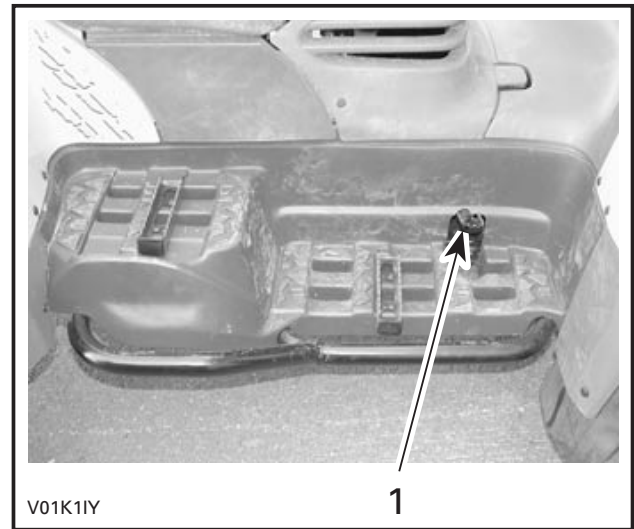

TRAXTER MAX SERIES

1. Rear brake pedal

16) Rewind Starter Handle

Traxter MAX Series

The rewind starter handle is provided as an emergency starting device.

Follow the usual starting procedure; but use the rewind starter instead of the electric starter.

Located on left side panel under front part of seat. Auto-rewind type. To engage mechanism, pull handle slowly until a resistance is felt then continue to slowly pull the handle until the compression stroke **peak** (strong rotating resistance) is passed, then pull vigorously. Slowly release handle.

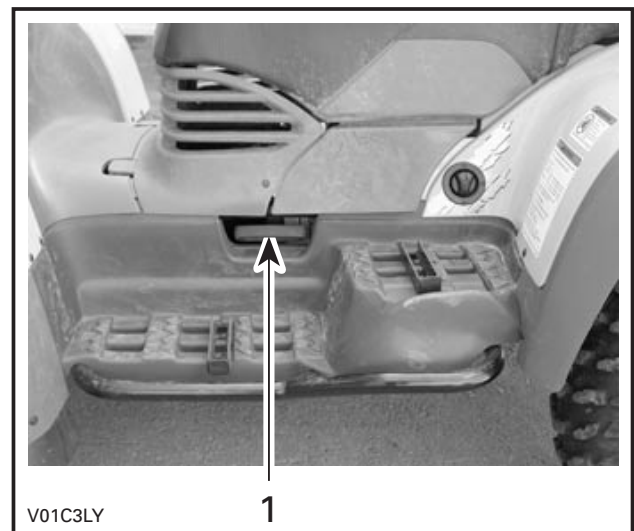

1. Rewind starter handle

17) Footpeg

Quest MAX and Traxter MAX Series

Located on footrest. Use this area to keep your feet stable.

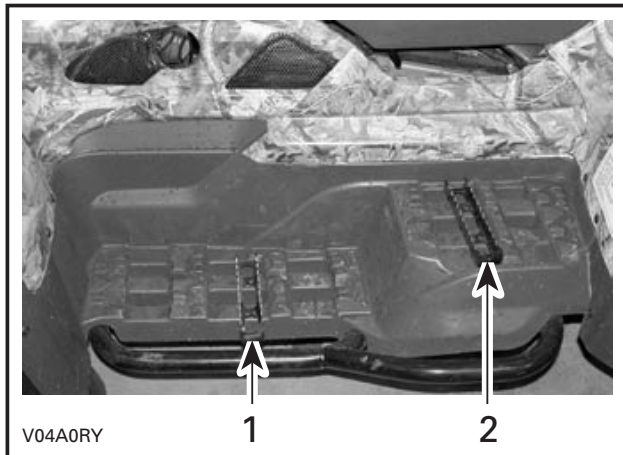

QUEST MAX SERIES

1. Driver's footpeg
2. Passenger's footpeg

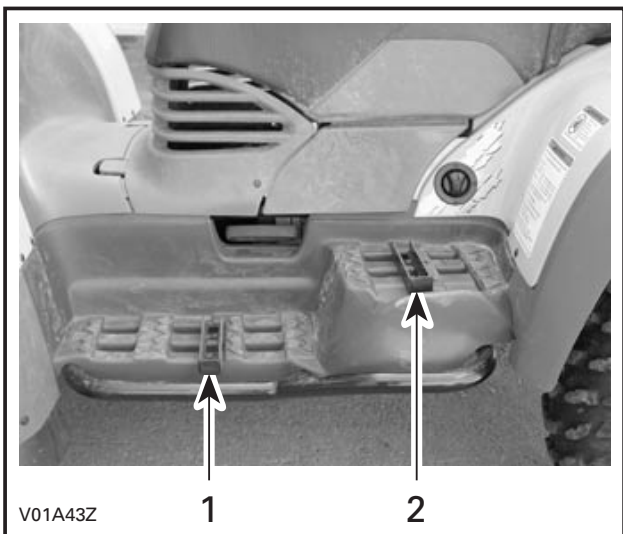

TRAXTER MAX SERIES

1. Driver's footpeg
2. Passenger's footpeg

18) Storage Compartment

Quest MAX and Traxter MAX Series

Located in front of vehicle. Convenient location to carry personal articles such as an a helmet, spare spark plugs, first aid kit, etc. Unlatch cover, gently lift then remove cover.

The compartment is equipped with a drain plug under the tool box. Remove plug to allow draining when necessary. Reinstall plug when finished.

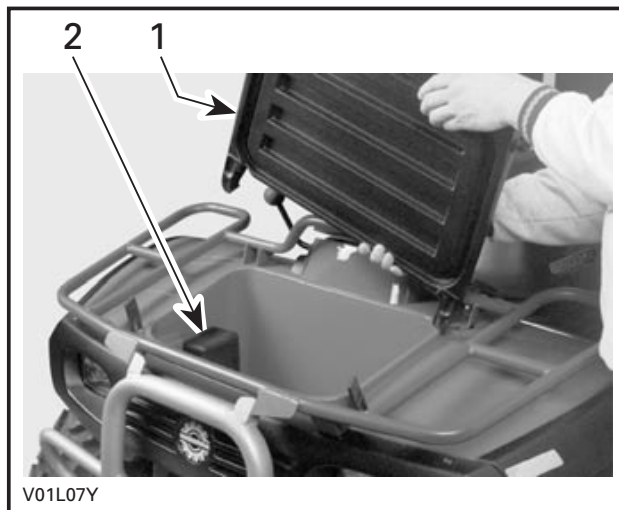

TYPICAL

1. Removing cover
2. Tool box

It also contains this *Operator's Guide* and an *ATV Winch Operator's Manual (XT models)* which should be kept in a waterproof bag and remain with the vehicle at all times.

⚠ WARNING

When engine is running, always engage the PARK position on the transmission lever before opening cover. Never leave any heavy or loose breakable objects in the storage basket. Always latch cover before riding. If storage cover is removed to provide greater carrying area, ensure that cargo is secured and will not "fly out" when riding at speed on rough terrain. Slow down.

19) Tool Box

Quest MAX and Traxter MAX Series

The tool box is located in the storage compartment and it contains tools for basic maintenance.

The tools included in the tool box are:

- pliers (1)
- screwdriver (1)
- open wrench 10/13 mm (1)
- open wrench 15/17 mm (1)
- socket wrench 10/13 mm (1)
- socket wrench 16/18 mm (1)
- tire pressure gauge (1)
- Allen key 3 mm (1)
- fuse 30 A (1)
- fuse 20 A (1)
- fuse 15 A (1).

20) Seat Latch

Located underneath rear end of seat. It allows the removal of seat to give access to engine compartment.

Quest MAX and Traxter MAX Series

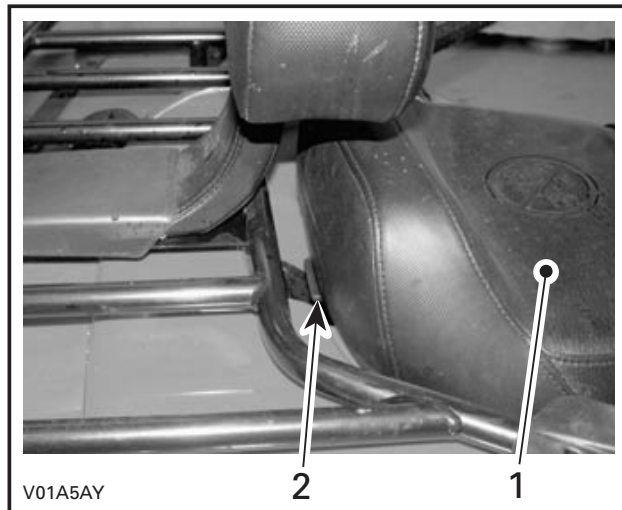

1. Seat
2. Seat latch

Seat Removal

Quest MAX and Traxter MAX Series

Pull latch upward while gently lifting rear of seat. Continue lifting movement until you can release the front retaining devices then completely remove seat.

Seat Installation

⚠ WARNING

Periodically verify the seat lock pin and tighten if needed. Make sure seat is securely latched before riding.

Quest MAX Series

Insert front tab of seat into frame hook. When seat rests in its position, firmly push seat down to latch.

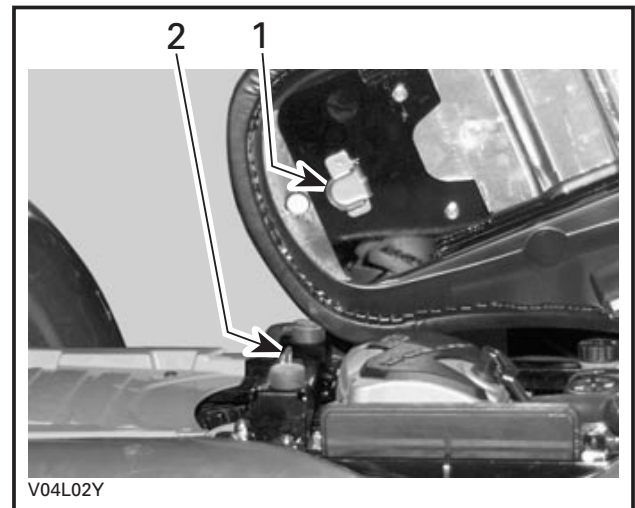

1. Insert this tab in hook
2. Hook

Traxter MAX Series

Place seat to allow the insertion of the U-shaped bracket over the rollers. Gently slide the brackets over rollers then lower seat. When seat rests in its position, firmly push seat down to latch.

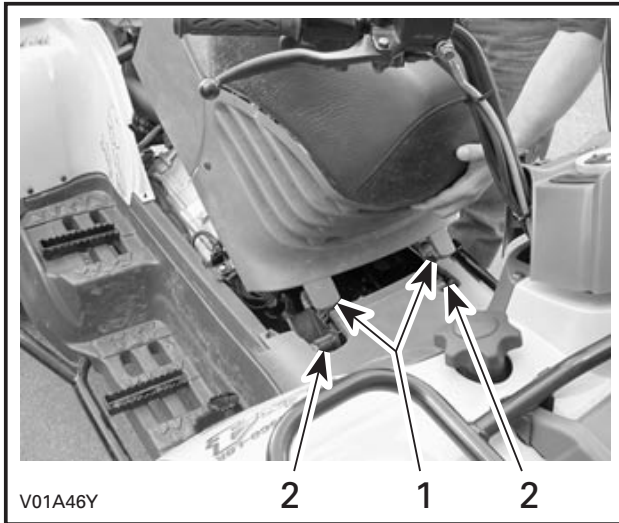

1. U-shaped bracket
2. Rollers

21) Front/Rear Cargo Racks

Quest MAX and Traxter MAX Series

Located on top of chassis at front and rear. Convenient racks to carry gear.

⚠ WARNING

Ensure to properly secure material to rack. Do not overload. Ensure load does not interfere with visibility and/or steering. Do not carry passenger(s).

Refer to SPECIFICATIONS for carrying loads and cargo weight distribution recommendations.

22) Air Duct

Quest MAX and Traxter MAX Series

Located on rear fenders. They force the flow of air to cool radiator and supply air inside air box.

CAUTION: Do not place anything over air intake ducts.

23) Trailer Hitch

Quest MAX and Traxter MAX Series

Located on rear axle. Convenient hitch to install a ball to tow a trailer or other equipment. Install the proper ball size as per trailer manufacturer recommendations. Refer to SPECIFICATIONS for carrying loads and towing recommendations.

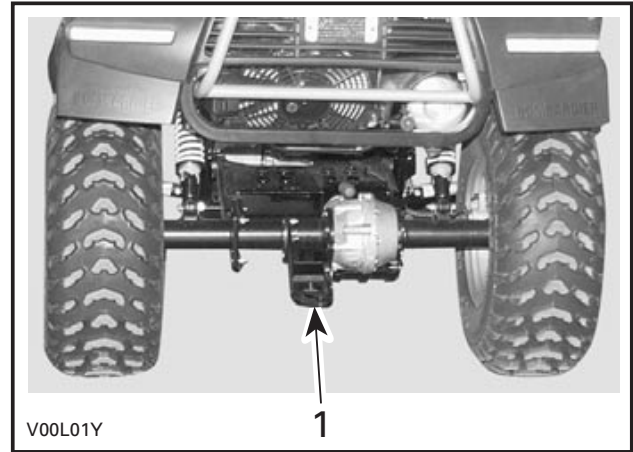

TYPICAL

1. Trailer hitch

⚠ WARNING

Be sure to install the proper ball size that matches the equipment you will tow.

Follow manufacturer's instructions for proper attachment.

24) Radiator Cap

Quest MAX and Traxter MAX Series

Located at rear of rear panel. It provides access to the radiator filling neck.

Pull the protector cap to give access to the radiator cap. When finished, properly reinstall radiator cap then protector cap.

⚠ WARNING

To prevent burning yourself do not remove the radiator cap if the engine is hot.

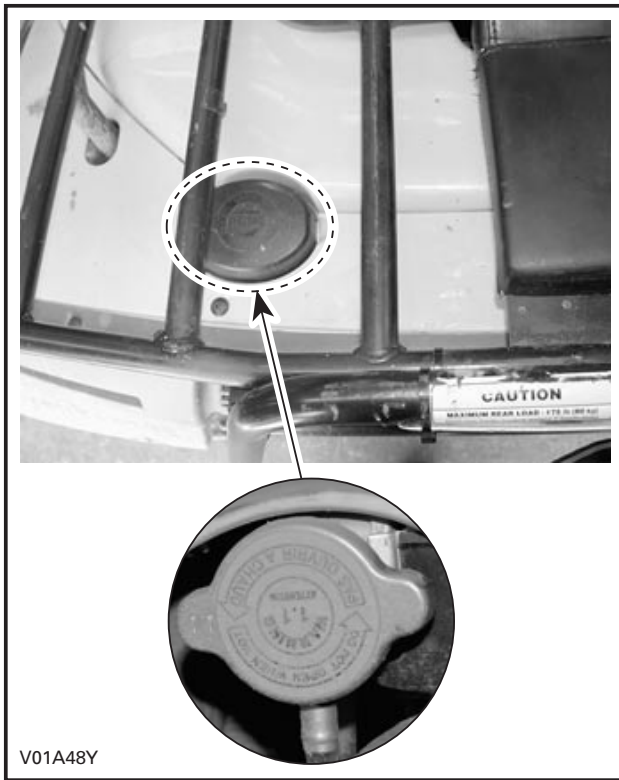

25) 12-Volt Power Outlet

Quest MAX and Traxter MAX Series

It is located on left side of cluster.

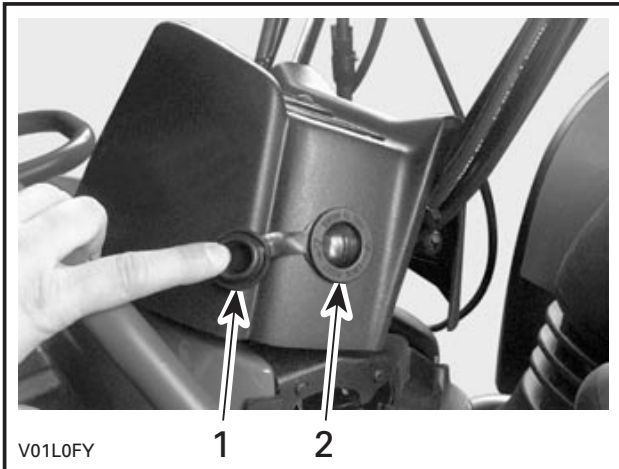

TYPICAL

1. Protective cap
2. Power outlet

Convenient for handheld spotlight or other portable equipment.

Remove cap to use. Always reinstall protective cap after use to protect against weather.

Do not exceed the rating capacity. See SPECIFICATIONS.

An auxiliary supply is available to connect additional accessories. Two wires are hidden in the wiring harness at the rear of vehicle. See an authorized Bombardier ATV dealer for more details.

26) Fuses

Quest MAX and Traxter MAX Series

The electrical system is protected with fuses. Refer to MAINTENANCE for details.

27) Winch

Quest MAX XT and Traxter MAX XT

Located behind front skid plate.

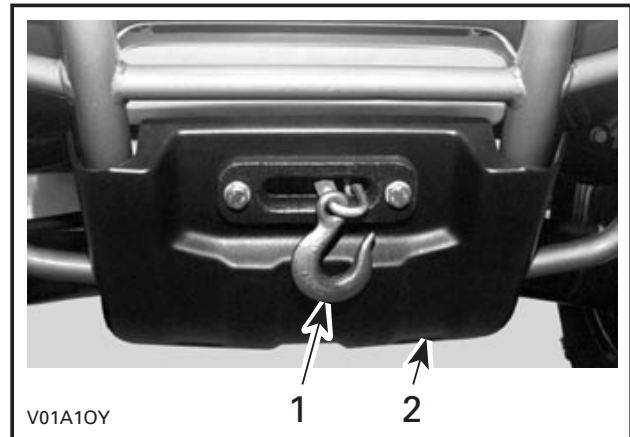

1. Winch
2. Front skid plate

28) Winch Control Switch

Quest MAX XT and Traxter MAX XT

Located on the LH side of the handlebar, near multi-function switch.

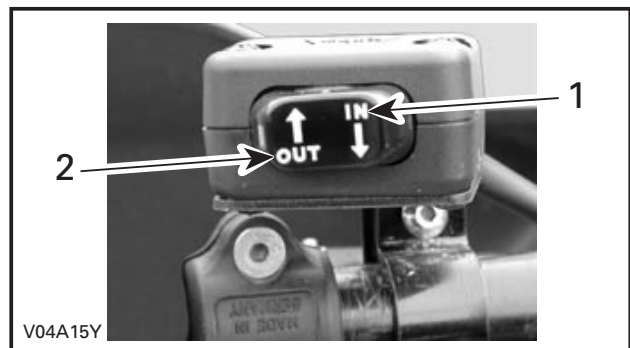

1. In
2. Out

To take out wire rope from winch, press the left side of switch.

To get wire rope into the winch, press the right side of switch.

Refer to *ATV Winch Operator's Manual* for more informations concerning the instructions for use the winch safely.

29) Fairlead

Quest MAX XT and Traxter MAX XT

Located on the front skid plate.

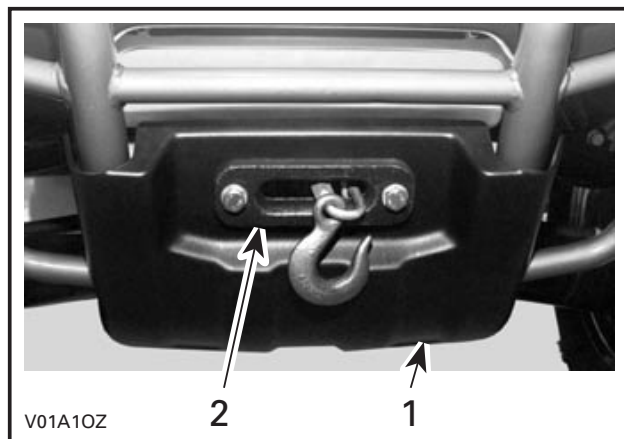

1. *Front skid plate*
2. *Fairlead*

The fairlead is used to prevent the damages to the vehicle and guide the wire rope into the winch.

LIQUIDS

While reading this *Operator's Guide*, remember that:

WARNING

Indicates a potential hazard that, if not avoided, could result in serious injury or death.

NOTE: This section specifies the recommended liquids and procedures to check their levels. Refer to MAINTENANCE for procedures to replace the liquids.

Fuel

Quest MAX and Traxter MAX Series Recommended Fuel

Use regular unleaded gasoline or gasohol containing less than 10% of ethanol or methanol, available from most service stations. The gasoline used must have an octane number of 87 ((R + M)/2) or higher.

NOTE: In most service stations, pump octane number corresponds to (R + M)/2 octane number. Usually a sticker can be found on the pump.

CAUTION: Never experiment with other fuels. The use of unrecommended fuel can result in vehicle performance deterioration and damage to critical parts in the fuel system and engine components.

CAUTION: Never mix oil with fuel. This ATV has a 4-stroke engine. Oil must be added to engine base only.

Fuel Level

WARNING

Always stop engine before refueling. Open cap slowly. If a differential pressure condition is noticed (whistling sound heard when loosening fuel tank cap) have vehicle inspected and/or repaired before further operation. Fuel is flammable and explosive under certain conditions. Never use an open flame to check fuel level. Never smoke or allow flame or spark in vicinity. Always work in a well-ventilated area. Never top off the fuel tank before placing the vehicle in a warm area. As temperature increases, fuel expands and may overflow. Always wipe off any fuel or oil spillage from the vehicle.

Engine/Transmission Oil

Quest MAX and Traxter MAX Series Recommended Oil

Use 4-stroke mineral-based engine oil that meets or exceeds the requirements for API service classification SG, SH or SJ. Always check the API service label on the oil container to be sure it includes the letters SG, SH or SJ. Only use high-quality high-detergent oil.

NOTE: The same oil lubricates both engine and transmission. For improve overall performance and wear protection use **Bombardier synthetic oil (P/N 293 600 039)**. This is a special synthetic oil formulated for clutch type gearbox.

Traxter MAX Series

CAUTION: Use of synthetic or synthetic blend oil, other than Bombardier synthetic oil 5W40 (P/N 293 600 039), may cause clutch slippage.

Oil Viscosity

Quest MAX and Traxter MAX Series

SAE 10W40 is recommended for summer time while SAE 5W30 is recommended for winter time.

Other viscosity should be used if the average temperature is outside the range of the recommended oil. See chart below.

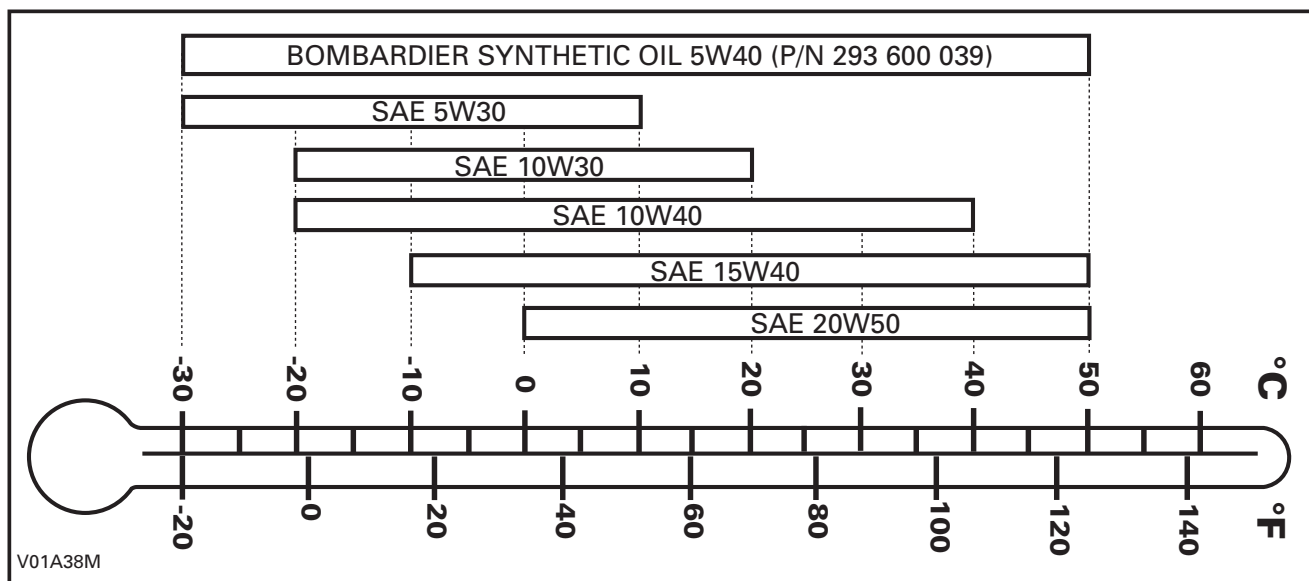

Oil Level

Quest MAX and Traxter MAX Series

CAUTION: Check level frequently and refill if necessary. Do not overfill. Operating the engine/transmission with an improper level may severely damage engine/transmission. Wipe off any spillage.

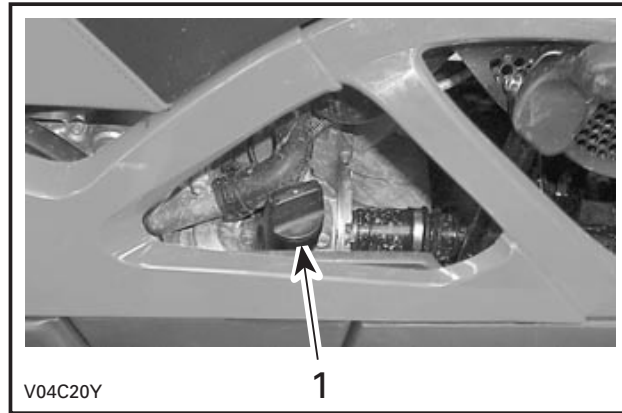

QUEST MAX SERIES — RH SIDE OF ENGINE

1. Dipstick

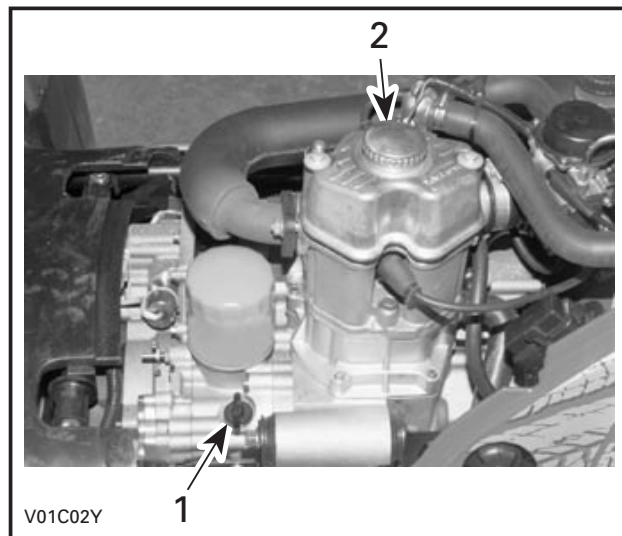

TRAXTER MAX SERIES — LH SIDE OF ENGINE

1. Dipstick
2. Filler cap

With vehicle on a level surface and engine cold, not running, check the oil level as follows:

1. Remove the dipstick and wipe clean.
2. Reinstall dipstick. The dipstick must be insert properly and completely.

3. Remove the dipstick again and check oil level. It should be near or equal with the upper mark.

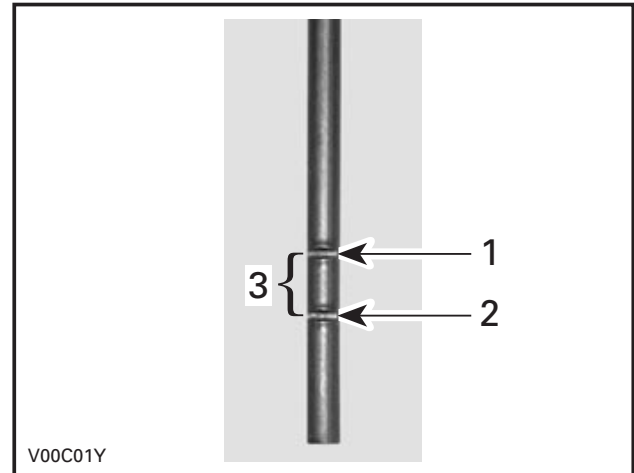

TYPICAL

1. Full
2. Add
3. Operating range

To add oil, remove the dipstick (**Quest MAX series**) or unscrew filler cap (**Traxter MAX series**). Add a small amount of oil and recheck oil level. Repeat until oil level reaches the dipstick's upper mark. **Do not overfill.**

NOTE: Use a funnel to avoid spillage. Properly reinstall the dipstick and/or tighten filler cap then reinstall seat.

Engine Coolant

Quest MAX and Traxter MAX Series Recommended Coolant

Always use ethylene-glycol antifreeze containing corrosion inhibitors specifically for internal combustion aluminum engines.

Cooling system must be filled with Bombardier premixed coolant (P/N 293 600 038) or with distilled water and antifreeze solution (50% water, 50% antifreeze).

Coolant Level

WARNING

Check coolant level with engine cold. Never add coolant in cooling system when engine is hot.

Remove seat.

Quest MAX Series

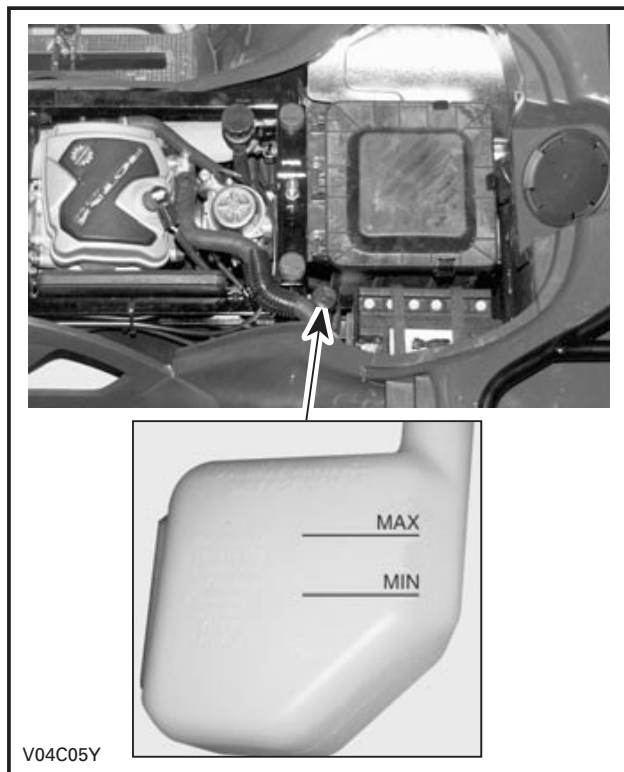

Traxter MAX Series

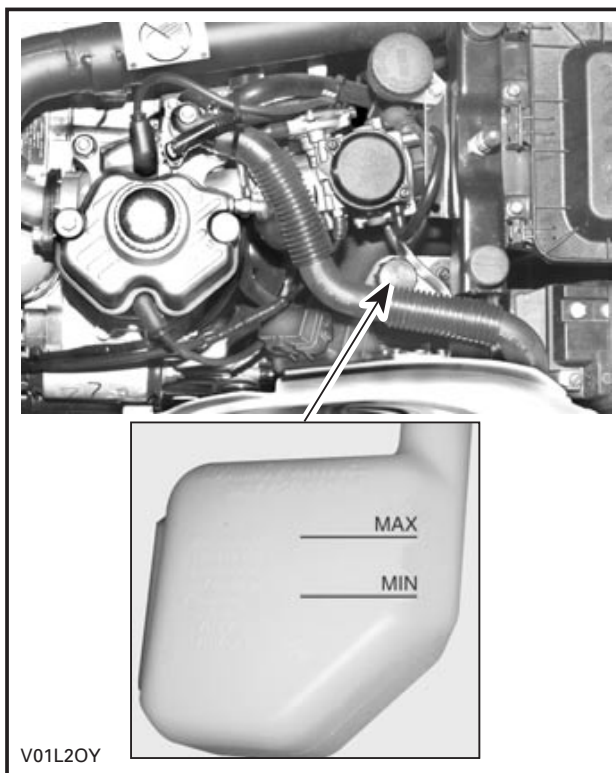

With vehicle on a level surface, liquid should be between MIN. and MAX. level marks of coolant reservoir.

NOTE: When checking level at temperature lower than 20°C (68°F), it may be slightly lower than MIN. mark.

Add coolant up to MAX. mark if required. Use a funnel to avoid spillage. **Do not overflow.**

Properly reinstall and tighten filler cap and reinstall seat.

If the coolant is added in the coolant reservoir, check the level in the radiator too. Add coolant if necessary.

⚠ WARNING

To prevent burning yourself do not remove the radiator cap if the engine is hot.

NOTE: A cooling system that frequently requires coolant is the indication of leaks or engine problems. See an authorized Bombardier ATV dealer.

Coolant Replacement

Refer to MAINTENANCE section.

Brake Fluid

Quest MAX and Traxter MAX Series **Recommended Fluid**

Always use brake fluid meeting the specification DOT 4 only.

CAUTION: To avoid serious damage to the braking system, do not use fluids other than the recommended one, nor mix different fluids for topping up.

Fluid Level

With vehicle on a level surface, check brake fluid in reservoir for proper level. It should be above MIN. mark.

Add fluid as required. **Do not overfill.**

Clean filler cap before removing.

CAUTION: Use only DOT 4 brake fluid from a sealed container. Do not use brake fluid taken from old or already opened containers.

NOTE: A low level may indicate leaks or worn brake pads. See an authorized Bombardier ATV dealer.

Front Brake Fluid Reservoir

Turn steering in the straight-ahead position to ensure reservoir is level.

Check the brake fluid level; the reservoir is full when the fluid reaches of the top of window.

Quest MAX and Traxter MAX Series

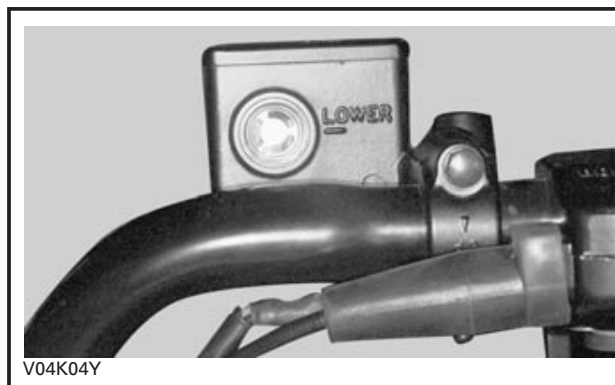

Visually inspect lever boot condition. Check for cracks, tears etc. Replace if damaged.

Rear Brake Fluid Reservoir ***Quest MAX Series***

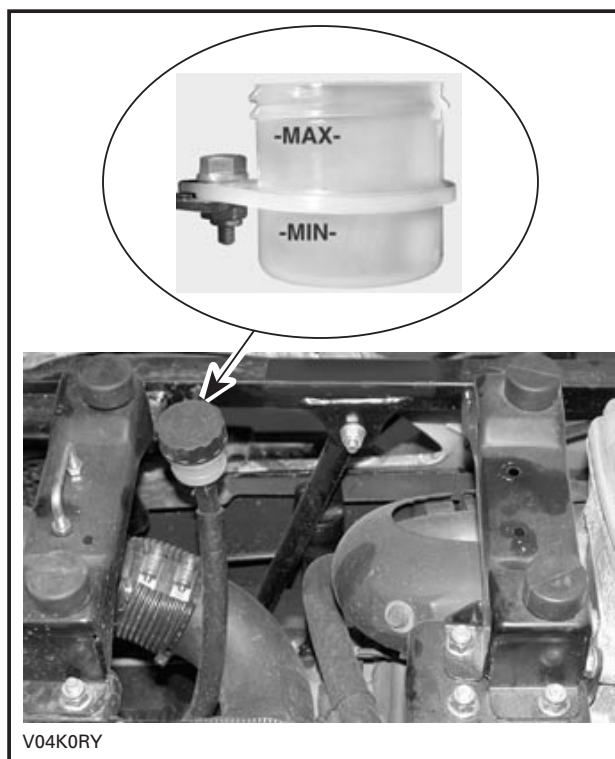

Traxter MAX Series

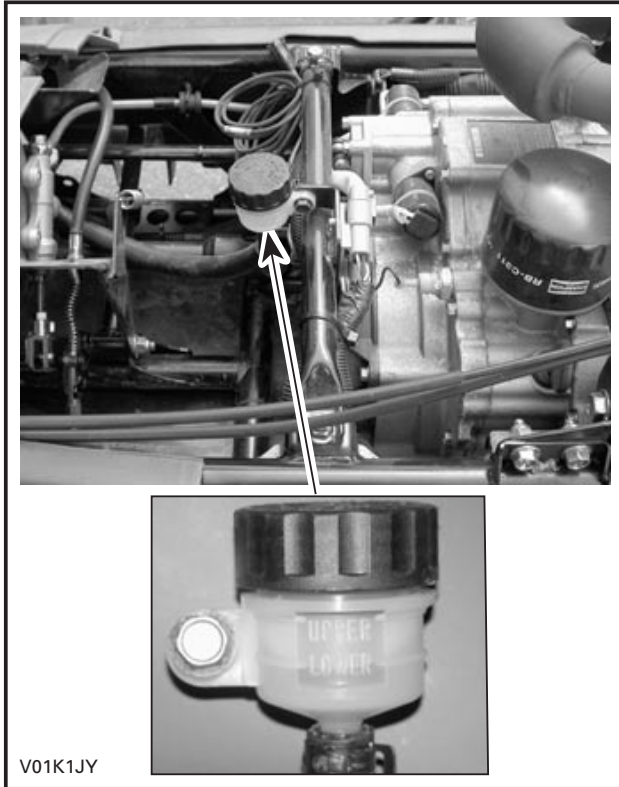

Battery

Quest MAX and Traxter MAX Series

This vehicle is equipped with an electrolyte type battery that requires a minimum of maintenance.

Electrolyte Level

Place the vehicle on a level surface.

Check electrolyte level by the rear left inner fender. Use a flashlight if necessary. Do not use an open flame.

The electrolyte should be between lower and upper marks. If level is low, remove battery from vehicle to add distilled water. Refer to MAINTENANCE for the proper removal/refilling/installation procedure.

BREAK-IN PERIOD

Engine

Quest MAX and Traxter MAX Series

A break-in period of 10 operating hours is required before running the vehicle at sustained full throttle.

CAUTION: Never mix oil with fuel. This vehicle has a 4-stroke engine. Oil must be added to engine base only.

During this period, maximum throttle should not exceed 3/4. **However, brief full acceleration and speed variations contribute to a good break-in.** Continued wide open throttle accelerations, prolonged cruising speeds and engine overheating are detrimental during the break-in period.

Belt

Quest MAX Series

A new belt requires a break-in period of 50 km (30 miles). Avoid strong acceleration/deceleration, pulling a load or high speed cruising.

10-Hour Inspection

Quest MAX and Traxter MAX Series

As with any precision piece of mechanical equipment, we suggest that after the first 10 hours or 30 days after the purchase, whichever comes first, your vehicle be inspected by an authorized Bombardier ATV dealer. This inspection will give you the opportunity to discuss the unanswered questions you may have encountered during the first hours of operation.

The 10-hour inspection is at the expense of the vehicle owner.

While reading this *Operator's Guide*, remember that:

WARNING

Indicates a potential hazard that, if not avoided, could result in serious injury or death.

PRE-OPERATION CHECK

Quest MAX and Traxter MAX Series

WARNING

The pre-operation check is very important prior to operating the vehicle. Always check the proper operation of critical controls, safety features and mechanical components before starting. If not done as specified here, severe injury or death might occur.

- Apply parking brake and check if it operates properly.
- Check tire pressure and condition.
- Check wheels and bearings for wear and damage.
- Check location of controls and ensure they work properly.
- Verify steering operates freely.
- Activate throttle control lever several times to ensure it operates freely. It must return to idle position when released.
- Activate the brake levers and foot pedal to make sure the brakes fully apply. Levers and pedal must fully return when released.
- Ensure transmission lever is working then reset in PARK position.
- Check fuel, oil and coolant levels.
- Check for oil leaks on the engine/transmission and drive train components.
- Ensure fuel valve is in fully open position (ON).
- Clean headlamps and taillight.
- Ensure front storage cover compartment is properly latched.
- Ensure seat is properly latched.
- If you transport cargo, respect load capacity. Ensure cargo is properly secured to the racks.
- If you are pulling a trailer or other equipment, ensure it respects the tongue capacity and towing capacity. Ensure trailer is properly secured to hitch.
- Look and feel for loose parts **while engine is off**. Check fasteners.
- Ensure the path of travel is free of persons and obstacles.
- Check operation of ignition switch, start button, engine stop switch, headlamps, dimmer switch, taillight and indicator lights.
- Start engine and drive forward slowly a few feet and apply all brakes individually to test them.
- Check backrest condition.
- Check passenger grab handles condition.
- Educate the passenger concerning the basic rules of a safe ride.

Correct any problem you may have found. See an authorized Bombardier ATV dealer as necessary.

OPERATING INSTRUCTIONS

General

Quest MAX and Traxter MAX Series

Transmission lever must be on PARK or NEUTRAL to allow engine starting.

For your convenience, an override mode allows to start the engine with the transmission lever in any position. Press and hold the front or rear brake lever or the brake pedal while pressing the start button.

Quest MAX Series

To start engine, place the engine stop switch to RUN position, insert key in ignition switch and turn to ON then press start button.

Traxter MAX Series

The engine can be started in any gear (from 1 to 5).

To start engine, insert key in ignition switch and turn to ON then press the start/stop switch.

Initial Cold Starting

Quest MAX and Traxter MAX Series

Insert key in ignition switch and turn to ON.

In cold weather, colder than 0°C (32°F), place the choke lever in full position.

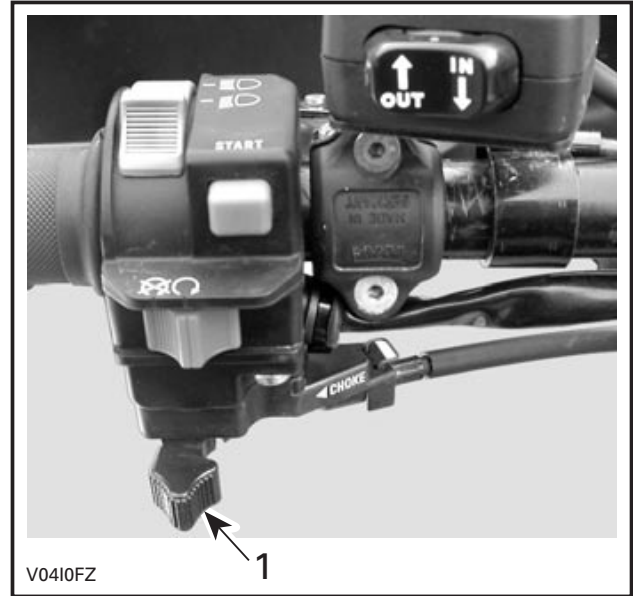

QUEST MAX SERIES

1. Full choke position

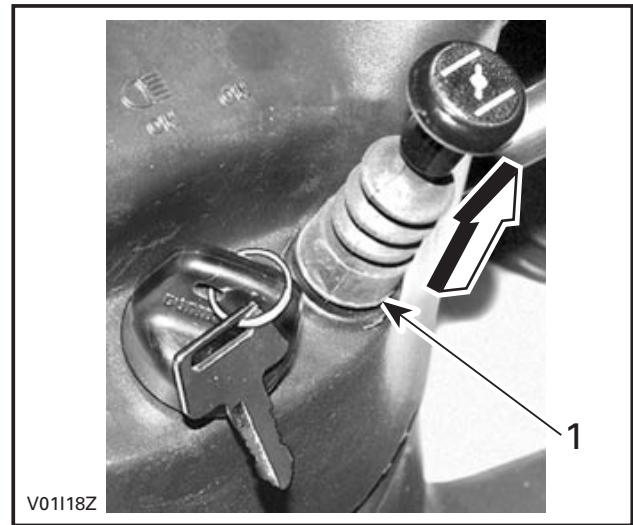

TRAXTER MAX SERIES

1. Full choke position

NOTE: On Traxter MAX series, when the temperature is below - 15°C (5°F), the primer kit (P/N 703 500 045) installation is recommended. See an authorized Bombardier ATV dealer.

Press the start/stop switch or the start button and hold until engine starts.

CAUTION: Do not hold start/stop switch or start button more than 30 seconds. A rest period should be observed between the cranking cycles to let starter cool down. Pay attention to battery; do not discharge it.

NOTE: The throttle can be use to help starting the engine faster. Press the throttle lever slightly. If it is pressed too much, the choke system will not be activated.

Release start/stop switch or start button immediately when engine has started.

After a few seconds, move the choke lever from full choke position to an intermediate position until a best engine RPM is achieved.

NOTE: Over using choke may flood engine and make it hard to start. Refer to SPECIAL PROCEDURES if this occurs.

When the engine is warm, push the choke lever to OFF and release brakes.

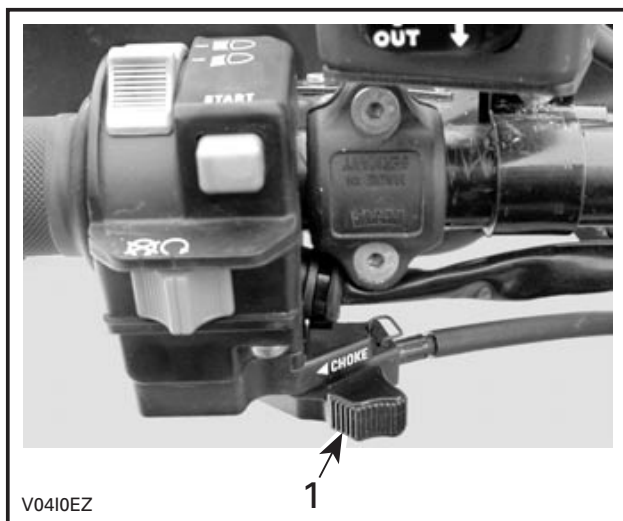

QUEST MAX SERIES

1. OFF position

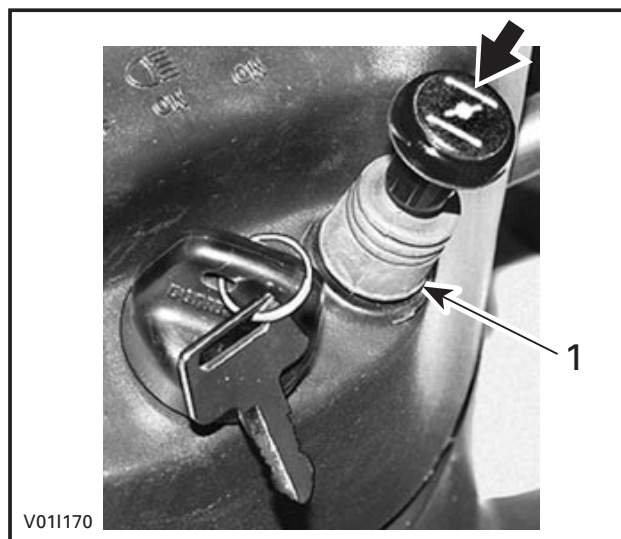

TRAXTER MAX SERIES

1. OFF position

Warm Engine Starting

Quest MAX and Traxter MAX Series

Start the engine as explained above but without the choke. If the engine will not start after two 5-second attempts with the electric starter, place the choke lever between the FULL and the OFF position. Start the engine without activating the throttle lever. After few times, push the choke lever to OFF.

Emergency Manual Starting

Traxter MAX Series

⚠ WARNING

Always place transmission lever on PARK or NEUTRAL before starting engine manually.

Manual start is provided in the event electric start does not work.

If the engine indicator light is turned off, it indicates the electrical system is in the auto shut-down mode. Turn the ignition key OFF then ON to reactivate it.

Follow the same procedure as starting procedures above except use the re-wind starter to start instead.

Grasp manual starter handle firmly and, slowly, crank engine until a resistance appears.

Pass this resistance and release the handle.

Take again the handle firmly and crank engine.

Repeat this procedure completely if necessary.

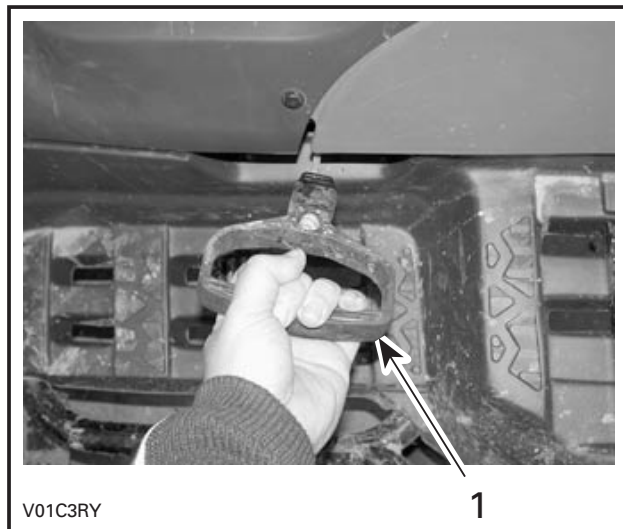

1. Grasp manual starter handle firmly and crank engine

Stopping the Engine

Quest MAX and Traxter MAX Series

WARNING

Avoid parking on an inclined surface.

Release throttle and completely stop the vehicle.

Apply the parking brake by using brake lever lock on rear brake lever.

On **Traxter MAX series**, shift to 1st gear.

Set transmission lever in PARK position.

Press the start/stop switch or push the engine stop switch in OFF position.

Turn key in ignition switch to OFF.

Remove key from ignition switch.

Shifting the Transmission

Quest MAX and Traxter MAX Series

Let engine idle to warm up.

Apply brakes and select the desired gear range H/L.

NOTE: The brake must be applied when the transmission lever is engaged in the park position. Shift to 1st gear for the **Traxter MAX series**.

Release brakes.

CAUTION: Make sure parking brake is fully disengaged before operating the ATV.

Quest MAX Series

Gradually press the throttle lever to increase engine speed and thus engaging the continuously variable transmission (CVT).

At the opposite, when the throttle lever is released, the engine speed decreases.

Traxter MAX Series

Gradually press the throttle lever to increase engine speed and thus engaging the centrifugal clutch.

When vehicle speed increases, slightly release throttle lever while pressing the electric gear shift button to upshift one gear then release button and press throttle lever again to continue the acceleration. Repeat until the last gear if desired or until vehicle speed you want is attained.

NOTE: While any throttle position can be used during shifting, it is recommended to slightly release the throttle position during upshifting.

Reverse the sequence to downshift.

Manual/Autoshift Selector

Traxter MAX Series

When selector is in autoshift mode, the transmission upshifts automatically when the vehicle speed increases. Inversely, when vehicle speed decreases, the transmission downshifts automatically.

Using Reverse

Quest MAX and Traxter MAX Series

CAUTION: When changing from forward to reverse, or vice-versa, always completely stop the vehicle and apply the brake prior to moving the transmission lever.

The same procedures as SHIFTING THE TRANSMISSION above apply except for the following.

Set the transmission lever in REVERSE position.

Winch Operation

Quest MAX XT and Traxter MAX XT

See the *ATV Winch Operator's Manual*. This manual should be kept in the tool box and remain in the vehicle at all time.

SPECIAL PROCEDURES

Flooded Engine

Quest MAX and Traxter MAX Series

When the engine does not start after several attempts, the engine may be fuel flooded. Proceed as follows.

Turn ignition switch to ON and ensure choke is not applied.

Ensure the transmission lever is on PARK.

Fully press throttle lever and hold while starting the engine.

As soon as the engine starts, release throttle lever. Do not race engine.

If it does not work:

Disconnect the ignition coil or unplug the spark plug cables.

Clean the ignition coil or the spark plugs area then remove spark plug(s) (tools are supplied in tool box).

WARNING

Always wear eye protector and gloves when the spark plug hole is cleaned.

Crank engine several times. Add a small quantity of engine oil in cylinder (equivalent to a cap of oil quart). Install new spark plug(s) if possible or clean and dry spark plug(s).

Start engine as explained above. If engine continues to flood, see an authorized Bombardier ATV dealer.

Engine Overheat

Quest MAX and Traxter MAX Series

If engine overheats and indicator light turns on, try the following:

Ensure air ducts are not obstructed.

Check and clean radiator fins. See MAINTENANCE section.

WARNING

The radiator can be very hot; wear gloves before touching radiator.

Reduce vehicle speed but try to keep vehicle moving to supply air to radiator. If engine is still overheating after approximately one minute, stop vehicle and set transmission to PARK. Stop engine.

Place the ignition switch to ON position (**DO NOT RESTART ENGINE YET**). The radiator fan will cool the radiator.

Let engine cool down. Check coolant level and refill if possible.

WARNING

Never refill cooling system when engine is hot.

See an authorized Bombardier ATV dealer as soon as possible.

Turn Over

Quest MAX and Traxter MAX Series

When vehicle is turned over or stays tilted on the side, replace the vehicle in its normal operating position (on all four wheels) and wait 3 to 5 minutes before starting engine. Before starting engine, check engine oil level and refill if necessary. If the oil pressure light stays ON after starting engine, stop engine and see an authorized Bombardier ATV dealer as soon as possible.

ATV Immersion

Quest MAX and Traxter MAX Series

Should the ATV become immersed, it will be necessary to take it to an authorized Bombardier ATV dealer as soon as possible. **DO NOT START THE ENGINE!** Immersion of the ATV can cause serious damage if the correct restart procedure is not followed.

Post-Operation Care

Quest MAX and Traxter MAX Series

When vehicle is used in salt-water environment (beach area, launching/loading boats etc.), rinsing the vehicle with fresh water is necessary to preserve vehicle and its components. Metallic parts lubrication is highly recommended. Use BOMBARDIER LUBE (P/N 293 600 016). This must be performed at the end of each operating day.

When vehicle is operated in muddy conditions, rinsing the vehicle is recommended to preserve vehicle and its components and to keep lights clean.

Emergency Shifter

Traxter MAX Series

If the shifting system is not operational, you may use the emergency shifter. It allows transmission gear change when the vehicle is not in motion. You set the desired gear once then go back home while the transmission remains in this gear. No gear change can take place since the shifting system is not operational. The shifter shaft end is located on rear side of engine.

Place transmission on PARK position.

Remove seat.

Use the special key in the tool box to rotate the emergency shifter. Open the tab of the tool approximately at a right angle (90°). Insert the screwdriver included in the tool box at the end of the special tool so that it can be used as a handgrip.

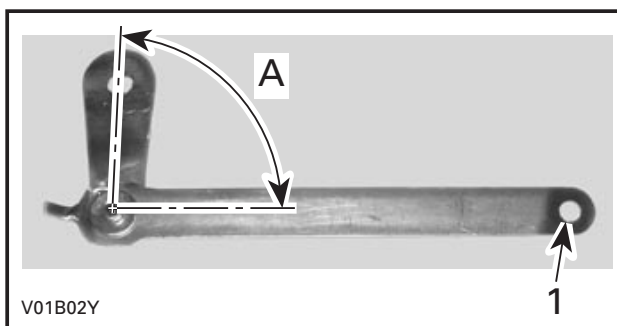

1. Insert the screwdriver here as a handgrip
A. Open tab at a right angle (90°)

⚠ WARNING

The exhaust pipe can be very hot. Wear gloves and/or allow exhaust pipe to cool.

Insert the tool to the end of the shifter shaft.

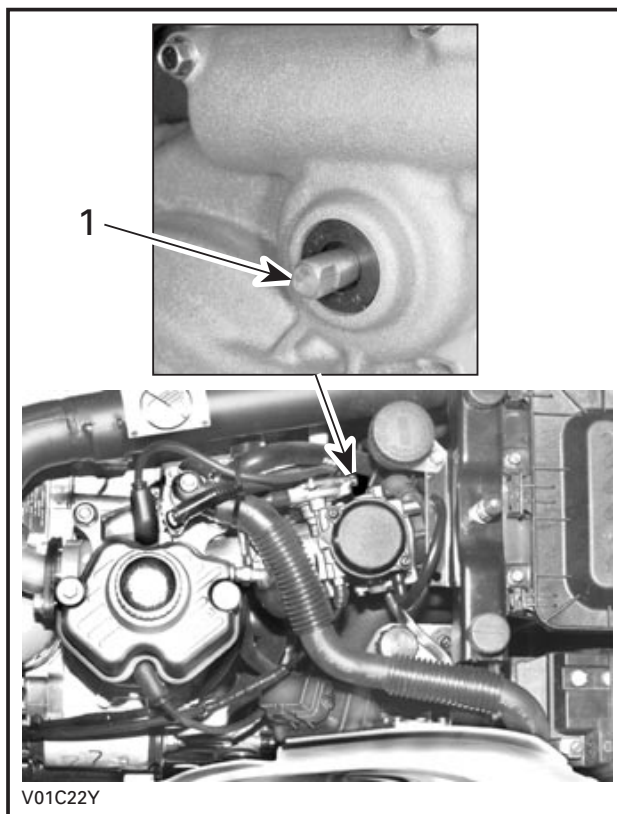

1. Emergency shifter shaft. Insert special tool here

Pull special tool upward to downshift and push downward to upshift. Place the gear in the desired position.

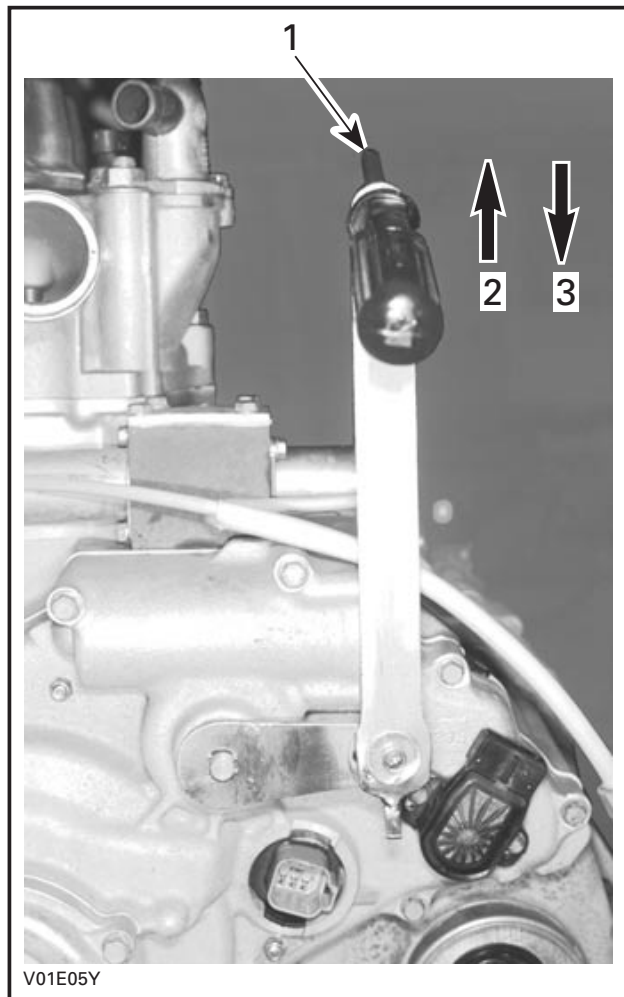

1. Use screwdriver as a handgrip
2. Pull to downshift
3. Push to upshift

NOTE: The 2nd or 3rd gear is recommended.

Remove the special tool. Close the tab of the tool. Replace tool and screwdriver in tool box.

Replace seat.

Storage and Preseason Preparation

Quest MAX and Traxter MAX Series

⚠ WARNING

Have an authorized Bombardier ATV dealer inspect fuel system integrity as specified in MAINTENANCE CHART.

When a vehicle is not in use for more than one month, proper storage is a necessity.

See an authorized Bombardier ATV dealer for proper procedures.

When using your ATV after storage, a preparation is required. See an authorized Bombardier ATV dealer for proper procedures.

CARGO AND TRANSPORTATION

While reading this *Operator's Guide*, remember that:

⚠ WARNING

Indicates a potential hazard that, if not avoided, could result in serious injury or death.

Cargo

⚠ WARNING

The vehicle handling, stability and braking distance are affected when loading racks and using the vehicle. Correct loading and weight distribution are therefore important. Never overload, tow or carry cargo improperly. Always ensure the cargo is safely secured and properly distributed on the rack(s) before operating the vehicle. Safely reduce speed when carrying cargo or pulling a trailer. Allow greater distance for breaking. Always secure cargo as low as possible on the rack(s) to reduce the effect of a higher center of gravity. Failure to follow the recommendations here could cause changes in vehicle handling which could lead to an accident resulting in severe injuries including the possibility of death.

When cargoing vehicle, respect these maximum loads.

Quest MAX Series

TOTAL LOAD ALLOWED:
272 kg (600 lb)
(includes driver and passenger, all other loads and added accessories)

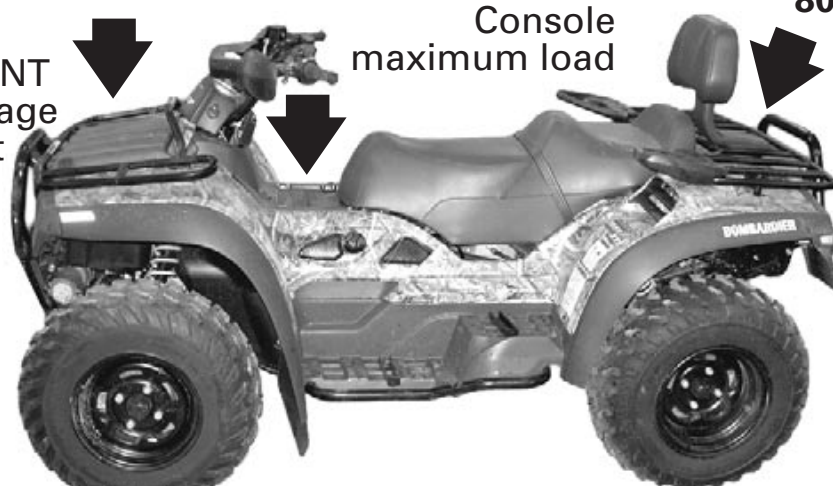
FRONT 40 kg (90 lb) Includes FRONT rack and storage compartment		REAR 80 kg (175 lb) Includes REAR rack and tongue load
---	--	--

5 kg (11 lb)
Console maximum load

V04M0JL

Traxter MAX Series

TOTAL LOAD ALLOWED:
290 kg (640 lb)
(includes driver and passenger, all other loads
and added accessories)

FRONT
40 kg (90 lb)
Includes FRONT
rack and storage
compartment

REAR
80 kg (175 lb)
Includes
REAR
rack and
tongue
load



V01A53L

Transportation

Quest MAX and Traxter MAX Series

When transporting a vehicle, secure vehicle to trailer or in pickup box with suitable tie-downs. Using ordinary ropes is not recommended.

WARNING



V00A174

Never tip this vehicle on end for transporting. We recommend that you carry the vehicle in its normal operating position (on all four wheels).

Place the fuel valve to OFF position.

Select the PARK position and set the parking brake.

Secure the vehicle to front by the front bumper and rear by the frame.

CAUTION: Attaching vehicle at other locations may damage the vehicle.

Front Location

Quest MAX and Traxter MAX Series



TYPICAL

Rear Location

Quest MAX and Traxter MAX Series



V01A3MY

⚠ WARNING

Do not tow this vehicle behind a car or other vehicle. Use a trailer.

MAINTENANCE INFORMATION

MAINTENANCE CHART

The maintenance is very important; if you are not familiar with safe service practices and adjustment procedures, see your authorized Bombardier ATV dealer.

	INITIAL 10 h INSPECTION OR 250 km (150 m.) ①	EVERY				TO BE PERFORMED BY
		25 h OR 625 km (388 m.)	50 h OR 1250 km (777 m.)	100 h OR 1 YEAR OR 2500 km (1553 m.)	200 h OR 2 YEARS OR 5000 km (3107 m.)	
I: Inspect, verify, clean, adjust, lubricate, replace if necessary C: Clean L: Lubricate R: Replace						
ENGINE/TRANSMISSION						
Engine/transmission oil and filter ④	R		R			Customer
Engine/transmission oil strainer cleaning					C	Customer
Engine mount fasteners	I			I		Dealer
Exhaust system	I			I		Dealer
Spark arrester				C		Customer
Condition of seals	I			I		Dealer
Coolant ④	I			②	R	Customer
Radiator cap/cooling system pressure test	I				I	Dealer
Radiator condition/cleanliness (air ducts and radiator fins) ③	I		I			Customer
Rewind starter rope condition				I		Dealer
Clutch and transmission operation				I		Dealer
Drive belt				I		Dealer
Cleaning/condition of drive and driven pulleys				C		Dealer
CVT air inlet/outlet duct condition/cleanliness and sealing	I		I			Dealer
FUEL SYSTEM						
Air filter ④		C ③		R ③		Customer
Fuel lines and connections	I			I		Dealer
Fuel tank strainer					R	Dealer
Carburetor adjustment	I			I		Dealer
ELECTRICAL SYSTEM						
Spark plug(s)	I			R		Dealer
Battery electrolyte level/connections/vent condition	I		I			Customer
Wiring harnesses, cables and lines	I			I		Dealer
Condition of ignition switch and start/stop switch ④	I			I		Customer
Condition of lighting system (HI/LO intensity, brake light, headlamp aiming, etc.) ④	I			I		Customer
Winch connections	Refer to <i>ATV Winch Operator's Manual</i>					Customer
DRIVE TRAIN						
Drive shaft boot and protector ④	I	I				Customer
Drive shaft joint			I			Dealer
Front/rear propeller shaft joint	I		L			Dealer
Wheel bearings condition				I		Customer
Front differential and rear axle oil, seals and vent	I		I		R	Dealer

I: Inspect, verify, clean, adjust, lubricate, replace if necessary C: Clean L: Lubricate R: Replace	INITIAL 10 h INSPECTION OR 250 km (150 m.) ①	EVERY				TO BE PERFORMED BY
		25 h OR 625 km (388 m.)	50 h OR 1250 km (777 m.)	100 h OR 1 YEAR OR 2500 km (1553 m.)	200 h OR 2 YEARS OR 5000 km (3107 m.)	
STEERING/CONTROL SYSTEMS						
Handlebar fasteners				I		Dealer
Throttle/housing/cable ④	I		I			Customer
Choke condition ④	I		I			Customer
Steering system	I			I		Dealer
Tie rod ends			I			Dealer
Wheel nuts/studs	I		I			Customer
Wear/pressure of tires ④	EVERY RIDE					Customer
Front wheel alignment	I			I		Dealer
SUSPENSION						
Swing arm ④				I		Dealer
Shock absorber ④			I			Dealer
A-arm lubrication			I			Customer
BRAKE						
Brake fluid front/rear ④	I	I			R ⑤	Customer
Brake cable	I		I			Dealer
Brake pad		I				Customer
Brake system (discs, hoses etc.)				I		Customer
BODY/FRAME						
Engine compartment	C		C			Customer
Skid plate	EVERY RIDE					Customer
Frame				I		Dealer
Hitch/trailer ball condition (if installed)	I		I			Customer
Chassis fasteners			I			Customer
Seat fasteners	EVERY RIDE					Customer
Backrest	EVERY RIDE					Customer
Grab handles	EVERY RIDE					Customer
Front storage compartment cover/seat latches ④			I			Customer
Vehicle cleaning and protection			C			Customer

- ① To be performed by an authorized Bombardier ATV dealer. The initial maintenance is very important and must not be neglected.
- ② Every 100 hours, check coolant strength.
- ③ More often under severe use such dusty area, sand, snow, wet or muddy conditions.
- ④ Pre-ride inspection item.
- ⑤ Must be performed by an authorized Bombardier ATV dealer.

MAINTENANCE

While reading this *Operator's Guide*, remember that:

⚠ WARNING

Indicates a potential hazard that, if not avoided, could result in serious injury or death.

⚠ WARNING

Unless otherwise specified, engine should not be running for all maintenance procedures.

Before performing any service or inspection operation on the vehicle, wait until the engine and exhaust have cooled down to avoid potential burns.

⚠ WARNING

Should removal of a locking device (e.g. lock tabs, self-locking fasteners, etc.) be required when undergoing disassembly/assembly, always replace with a new one.

The following covers the maintenance items that can be performed by the customer if desired. Other items found in maintenance chart must be performed by an authorized Bombardier ATV dealer.

NOTE: Among other things, this section gives the procedures to replace the liquids. Refer to LIQUIDS for procedures to check levels and refill.

Engine/Transmission

Quest MAX and Traxter MAX Series

Oil Change and Oil Filter Replacement

Oil and filter are to be replaced at the same time. Oil change should be done with a warm engine.

⚠ WARNING

The engine oil can be very hot. Wait until engine oil is warm.

Ensure vehicle is on a level surface.

Clean the drain plug area.

Remove dipstick.

Place a drain pan under the engine drain plug area.

Unscrew drain plug.

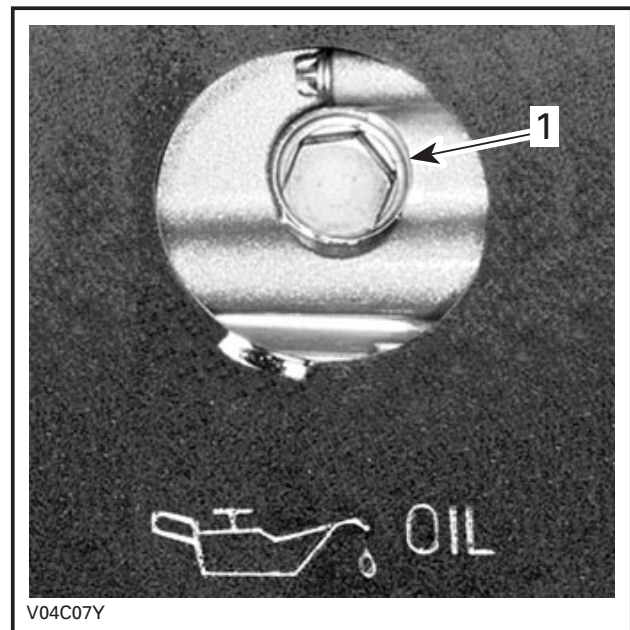

QUEST MAX SERIES

1. Oil drain plug

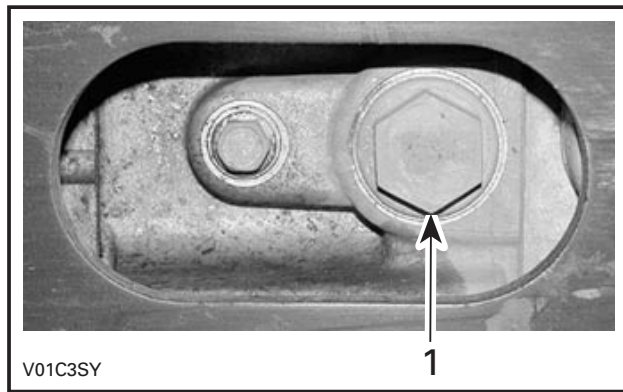

TRAXTER MAX SERIES

1. Oil drain plug

Allow enough time for oil to flow out of oil filter.

Quest MAX Series

Remove the RH side panel then the door in the footrest.

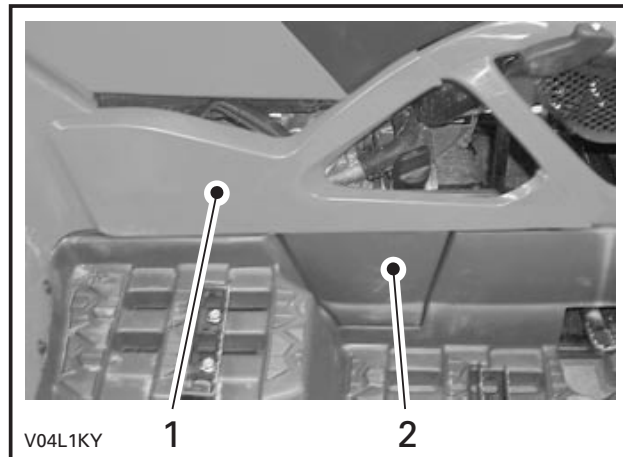

1. Side panel
2. Footrest door

Unscrew the oil filter cover.

Remove the oil filter and replace with a new filter.

NOTE: Check the cover O-ring and change it if necessary.

Wipe out any oil spillage on engine.

Remove skid plate.

Remove oil strainer cover and oil collector, located near drain plug, then clean oil strainer.

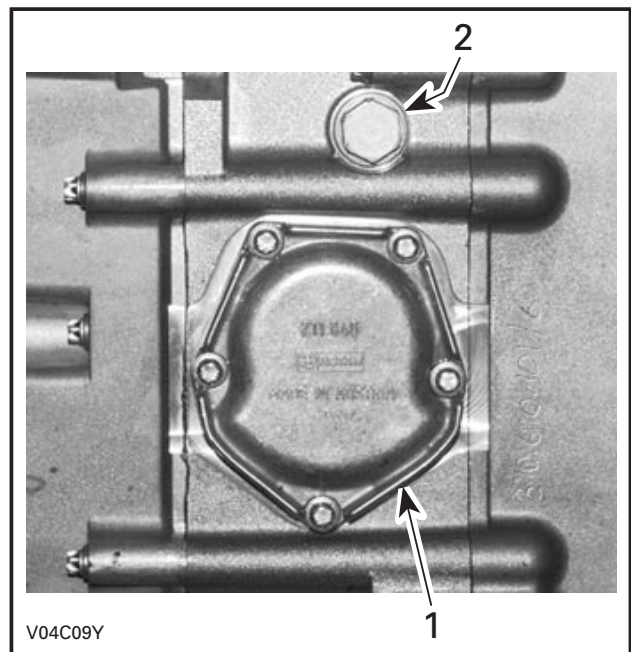

1. Oil strainer cover
2. Oil plug

Traxter MAX Series

Carefully unscrew oil filter and as soon as it can be removed from the engine, turn it upright. Discard filter.

NOTE: Be sure that the old filter O-ring is removed.

CAUTION: Only use Bombardier high pressure filter or suitable equivalent. The Bombardier filter is specifically designed for this engine. This filter does not operate at the same pressure as other brands. Using a non-recommended filter may cause serious engine/transmission damage. See an authorized Bombardier ATV dealer.

Lubricate the O-ring on the filter with engine oil. Install the new filter then screw one full turn after O-ring contact.

Wipe out any oil spillage on engine.

Remove skid plate.

Remove oil strainer cover and oil collector, located near drain plug, then clean oil strainer.

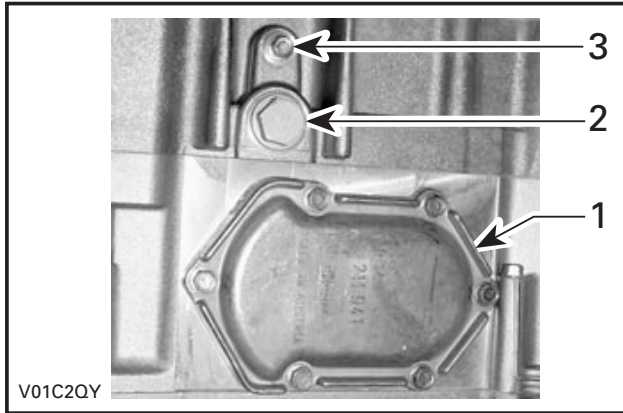

1. Oil strainer cover
2. Oil plug
3. Coolant plug

Quest MAX and Traxter MAX Series

To clean oil strainer, use a solvent then dry with compressed air.

WARNING

Always wear eye protection and gloves.

Reinstall oil strainer, oil collector and oil strainer cover.

Change gasket on drain plug. Clean gasket area on engine and drain plug then reinstall plug. Refill engine at the proper level with the recommended oil. Refer to SPECIFICATIONS for capacity.

Start engine and let idle for a few minutes. Ensure oil filter area and drain plug areas are not leaking.

Stop engine. Wait a while to allow oil to flow down to crankcase then check oil level. Refill as necessary.

Dispose of oil as per your local environmental regulations.

Coolant Replacement

Quest MAX and Traxter MAX Series

WARNING

To avoid burning yourself, do not remove the radiator cap or loosen the engine drain plug if the engine is hot.

Turn the radiator cap counterclockwise and remove it.

On **Quest MAX series**, remove the skid plate under vehicle, the RH side panel and the door in the footrest.

Remove the drain plug and drain the coolant into a suitable container.

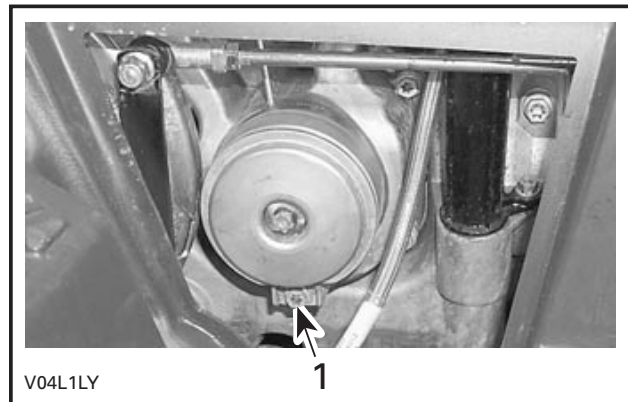

QUEST MAX SERIES — UNDER OIL FILTER COVER

1. Cooling drain plug

NOTE: Do not unscrew the drain plug completely.

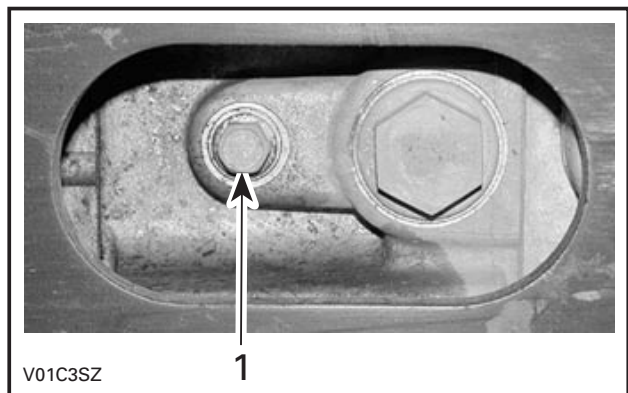

TRAXTER MAX SERIES — UNDER ENGINE

1. Cooling drain plug

Unscrew the bleeding screw on the top of thermostat housing.

Drain the system completely and reinstall the drain plug.

NOTE: On **Traxter MAX series**, lift the rear of vehicle, about 75 mm (3 in).

Pinch hose between radiator and thermostat housing with a large hose pincher (P/N 529 032 500).

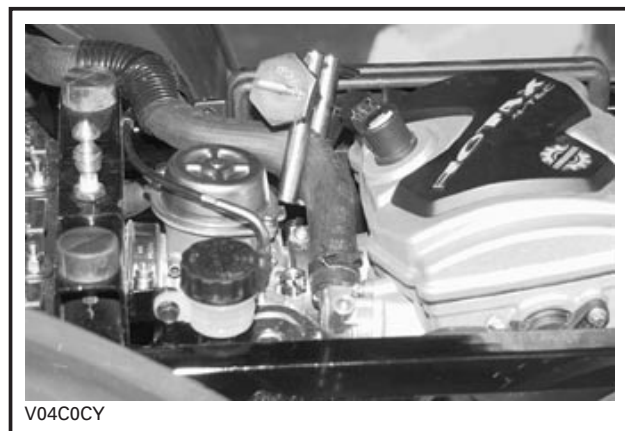

V04C0CY

QUEST MAX SERIES



V03C03Y

TRAXTER MAX SERIES

Fill the radiator until the coolant comes out by the thermostat housing hole. Install the bleeding screw then remove the hose pincher.

Complete the radiator filling.

Check the level in the coolant reservoir and refill if necessary.

Run engine at idle with the radiator cap off. Slowly add additional coolant if necessary.

At this point, wait until engine reaches normal operating temperature. Depress the throttle lever two or three times; then add coolant if required.

Install radiator cap. Inspect all connections for leaks and check coolant level in the reservoir.

Valve Adjustment

Quest MAX and Traxter MAX Series

Valve adjustment is not required on this engine.

Spark Arrester

Quest MAX and Traxter MAX Series

The muffler must be periodically purged of accumulated carbon.

⚠ WARNING

Never run engine in an enclosed area. Never perform this operation immediately after the engine has been run because exhaust system is very hot. Make sure that there are no combustible materials in the area. Wear eye protection and gloves. Never stand behind the vehicle while purging exhaust system. Respect all applicable laws and regulations.

Select a well-ventilated area and make sure the muffler is cool.

Place transmission on PARK position.

Remove the clean-out plug from muffler.

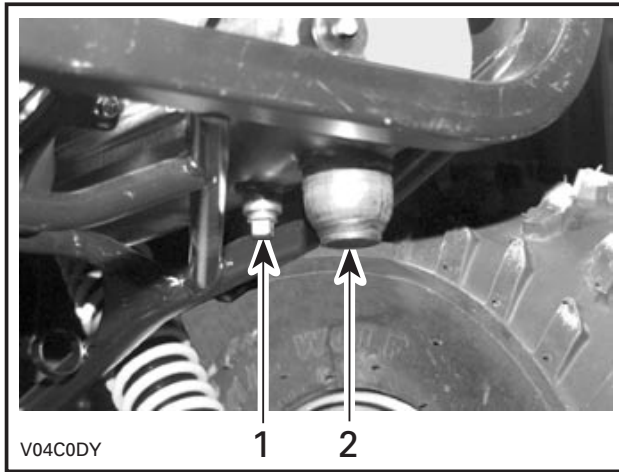

TYPICAL — QUEST MAX SERIES

1. Clean-out plug
2. Muffler

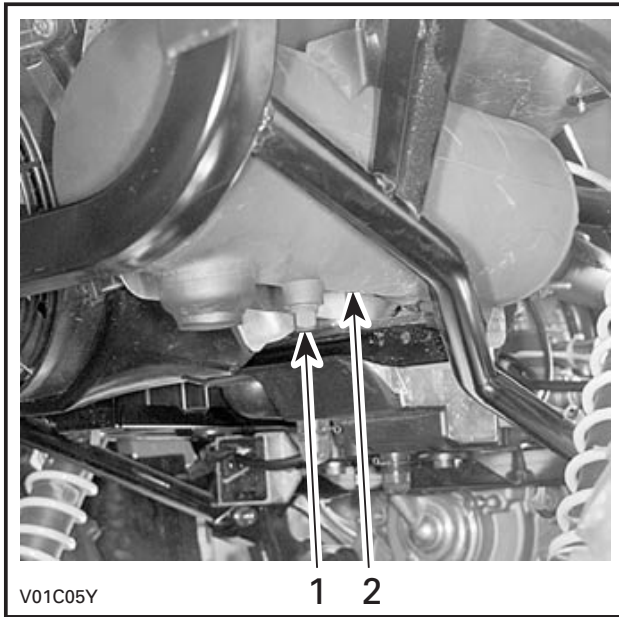

TYPICAL — TRAXTER MAX SERIES

1. Clean-out plug
2. Muffler

Block the end of muffler with a shop rag and start engine.

Momentarily increase engine RPM several times to purge accumulated carbon out of the muffler.

Stop engine and allow muffler to cool.

Reinstall the clean-out plug.

Radiator

Quest MAX and Traxter MAX Series

Periodically check the radiator area and the air ducts for cleanliness. Ensure air ducts are unobstructed to allow air flow going to the radiator.

An access hole is available to inspect the radiator condition and to give access for cleaning.

Remove seat.

Pull on the circumference of the access plug and remove plug.

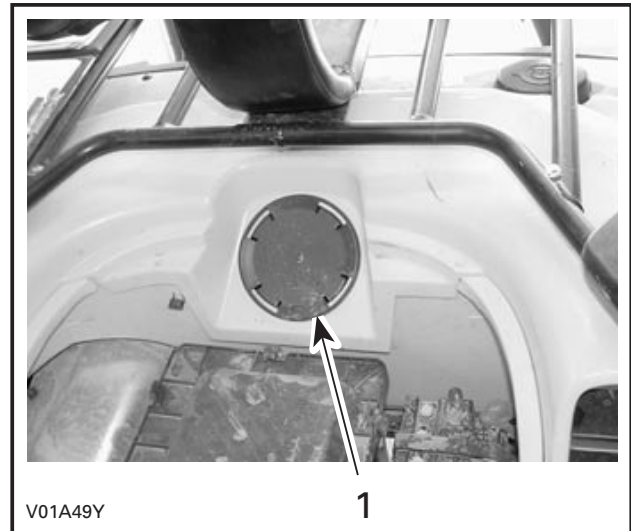

1. Access plug

Inspect radiator fins. They must be clean, free of mud, dirt, leaves and any other deposit that would prevent the radiator from cooling properly.

Remove as much deposits as you can with your hands. If water is available in proximity, try rinsing the radiator fins.

If available, use a garden hose to rinse the radiator fins.

⚠ WARNING

Never clean radiator with your hands when it is hot. Let the radiator cool down before cleaning.

CAUTION: Be careful not to damage the radiator fins when cleaning. Do not use any object/tool that could damage the fins. The fins are purposely thin parts to allow efficient cooling. WHEN HOSING, USE LOW PRESSURE ONLY. NEVER USE A HIGH PRESSURE WASHER.

Properly reinstall access plug and seat.

Carburetor

Quest MAX and Traxter MAX Series

See an authorized Bombardier ATV dealer each year to verify and clean the fuel system.

Air Intake System

Quest MAX and Traxter MAX Series

Air Filter Cleaning/Draining

Periodically inspect air filter box drain tube for liquid or deposits.

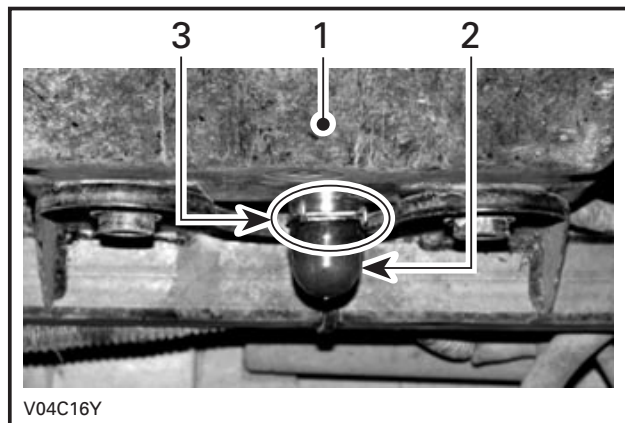

TYPICAL

1. Air filter box
2. Drain tube
3. Clamp

NOTE: If vehicle is used in dusty area, inspect more frequently than specified in MAINTENANCE CHART.

If liquid/deposits are found, squeeze and remove the clamp. Pull drain tube out and empty it.

CAUTION: Do not start engine when liquid/deposits are found in the drain tube.

When liquid/deposits are found, the air filter must be inspected/dried/replaced depending on its condition.

Remove air filter as explained below.

Air Filter Removal

CAUTION: Never remove or modify any component in the air box. Otherwise, engine performance degradation or damage can occur. The engine carburation is calibrated to operate specifically with these components.

Remove seat.

Release clamps and remove air filter box cover.

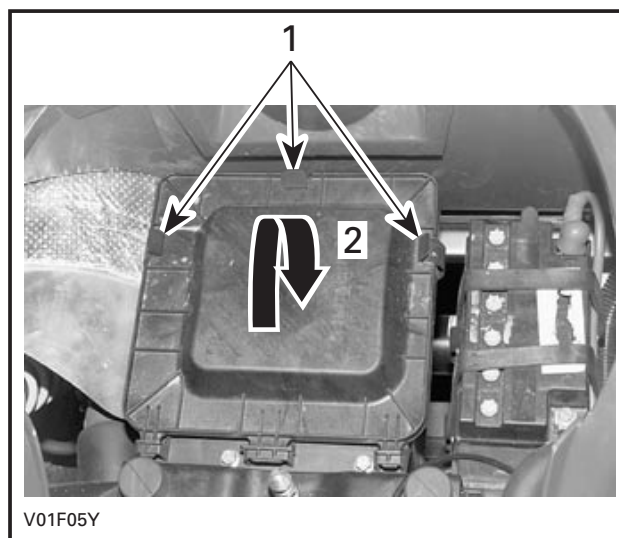

TYPICAL

1. Release clamps
2. Lift to remove

Loosen clamp and remove air filter.

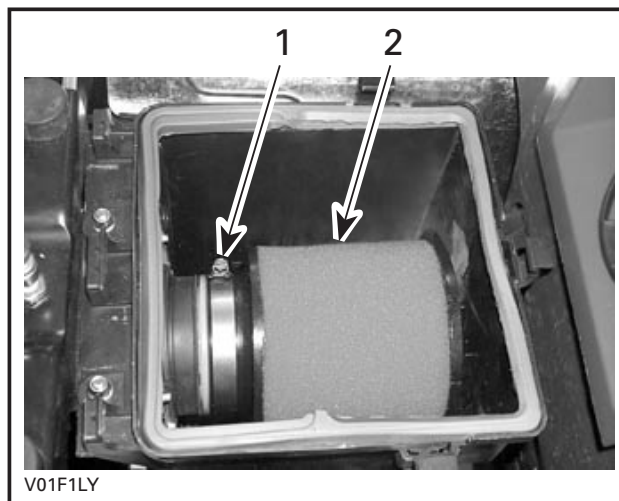

1. Clamp
2. Air filter

Pour air filter cleaning solution (P/N 293 600 059 or an equivalent) into a bucket. Put the filter in to soak.

While filter soaks, clean inside the air box.

Rinse the filter with warm water until all cleaning solution disappears.

NOTE: If the air filter foam is still dirty, replace it with a new one.

Then, let the filter dry completely.

When the filter is dried, re-oil with air filter oil (P/N 293 600 058 or an equivalent).

Air Filter Installation

Properly reinstall removed parts in the reverse order of their removal.

Electrical

Battery

Quest MAX and Traxter MAX Series

⚠ WARNING

Never charge a battery while installed in vehicle.

Removal

Disconnect BLACK (-) cable first then RED (+) cable.

⚠ WARNING

Always respect this order for disassembly; disconnect BLACK (-) cable first. Electrolyte or fuel vapors can be present in engine compartment and a spark may ignite them and possibly cause personal injuries.

Remove the holding straps.

Pull out vent tube from frame.

Remove battery from vehicle being careful not to tilt it so that electrolyte flows out of vent tube.

⚠ WARNING

Battery electrolyte is a caustic substance that burns or destroys organic tissues by chemical action. Avoid contact with eyes, skin and clothing. Wear protective eye-glasses and a suitable pair of non-absorbent gloves when removing the battery by hand. Should any electrolyte spillage occur, immediately wash off with a solution of baking soda and water.

Cleaning

Clean battery, battery casing, cables and battery posts using a solution of baking soda and water.

Remove corrosion from battery cable terminals and battery posts using a firm wire brush. Battery top should be cleaned by soft brush and any grease-cutting soap or baking soda solution.

Refilling

Place battery on a level surface.

Unscrew caps and add distilled water up to upper mark as required. Do not overfill.



1. Upper mark

Properly retighten caps.

Installation

Reinstall battery in vehicle. Fasten battery and make sure to reinstall the vent tube.

⚠ WARNING

Connect RED (+) cable first then BLACK (-) cable. Always connect RED (+) cable first.

NOTE: Place the RED (+) cable between holding straps and battery.

Fuses

⚠ WARNING

Always turn the ignition switch OFF before replacing a defective fuse.

Quest MAX and Traxter MAX Series

If a fuse is damaged, replace it by one of the same rating.

CAUTION: Do not use a higher rated fuse as this can cause severe damage.

On **Quest MAX series**, the fuse holder is located at the rear of the vehicle, on left side, under rear fender.

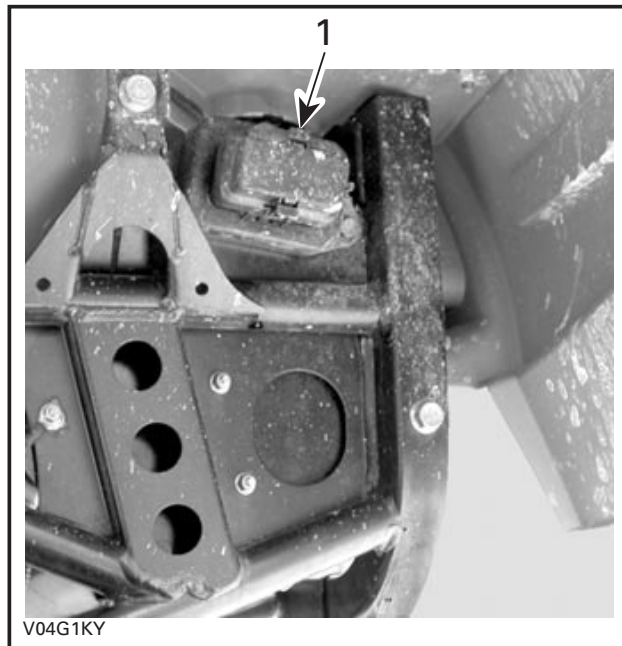

QUEST MAX SERIES

1. Fuse holder

On **Traxter MAX series**, the fuse holder is located in engine compartment on LH side of battery.

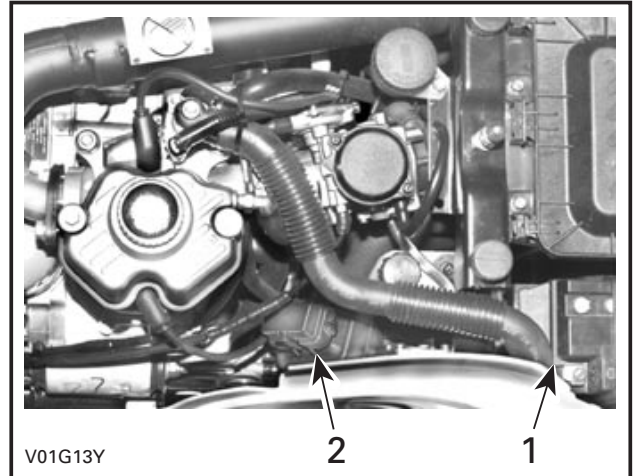

TRAXTER MAX SERIES

1. Battery
2. Fuse holder

Fuses are identified by a number located beside the fuse.

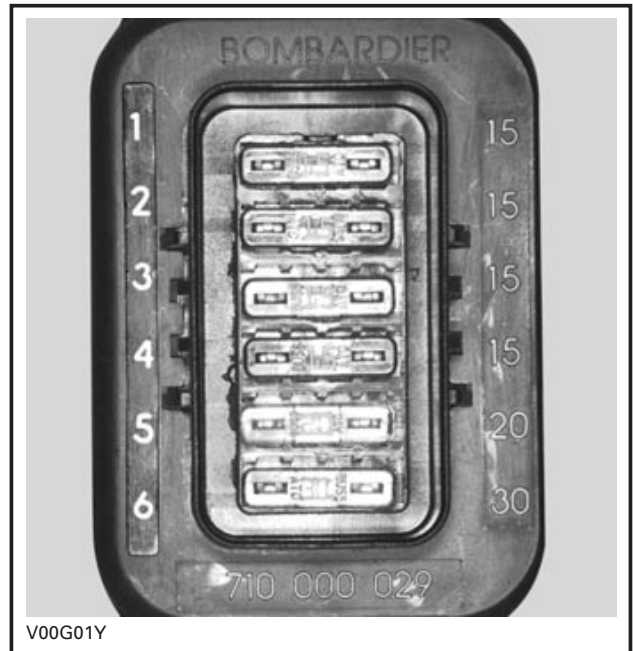

QUEST MAX SERIES

1. Spare
2. Spare
3. Accessories (power outlet and auxiliary supply)
4. Fan
5. Main
6. Charging system

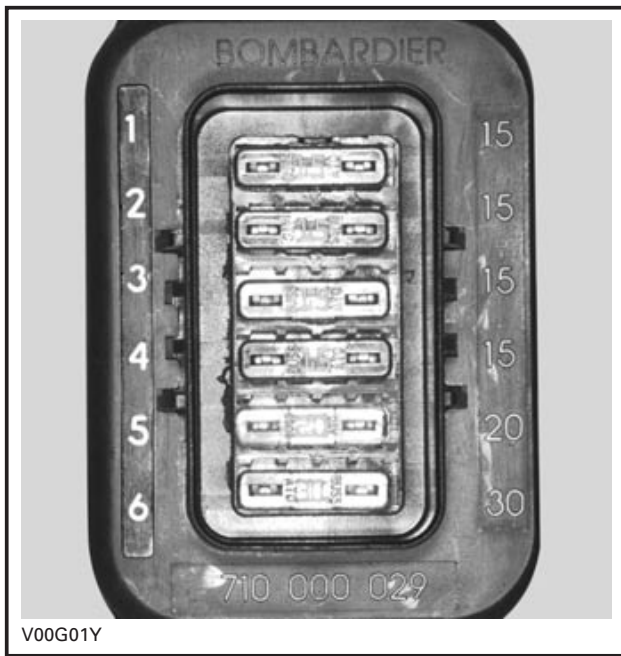

TRAXTER MAX SERIES

1. Ignition system
2. Accessories
(power outlet and auxiliary supply)
3. Solenoids
4. Fan
5. MPEM (Multi-Purpose Electronic Module)
6. Charging system

To remove fuse from holder, remove the fuse holder cover then pull fuse out. Check if filament is melted.

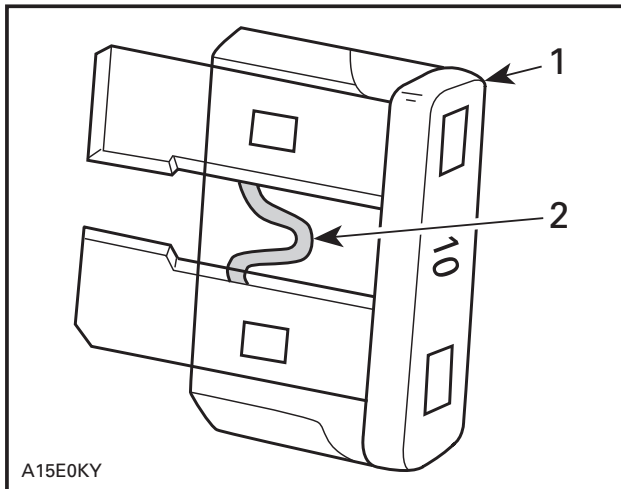

TYPICAL

1. Fuse
2. Check if melted

Bulb Replacement

⚠ WARNING

Always turn the ignition switch OFF before replacing a defective bulb.

Always check light operation after replacement.

Headlamps

Quest MAX Series

CAUTION: Never touch glass portion of an halogen bulb with bare fingers, it shortens its operating life. If glass is touched, clean it with isopropyl alcohol which will not leave a film on the bulb.

Unplug connector from headlamp.

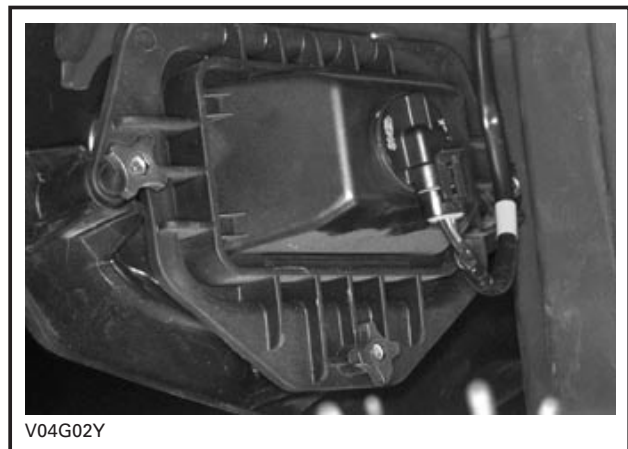

Rotate the bulb socket counterclockwise then remove headlamp.

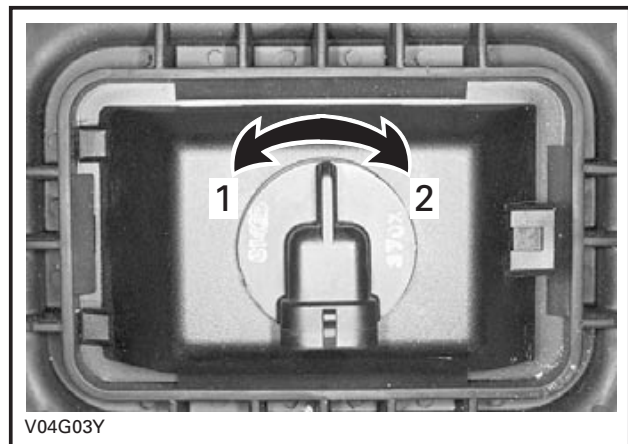

1. Unlock
2. Lock

Properly reinstall removed parts in the reverse order of their removal.

Adjust beam aiming as follows:

Turn knobs to adjust beam height and side orientation to your convenience. Adjust both headlamps evenly.

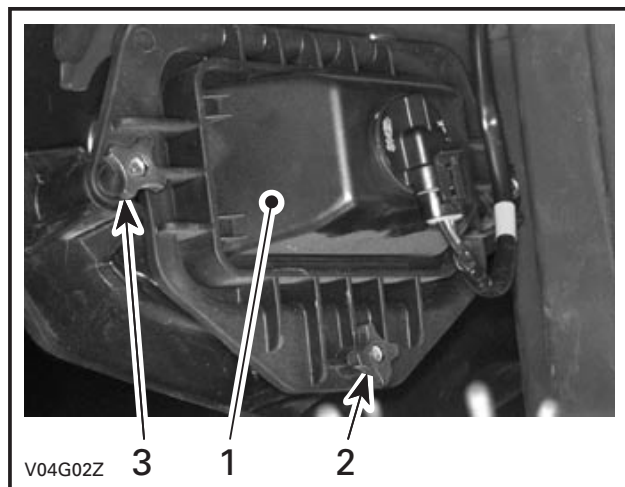

1. Headlamp cover
2. Beam height adjustment
3. Beam side adjustment

Traxter MAX Series

Lift sealed beam cover then remove sealed beam.

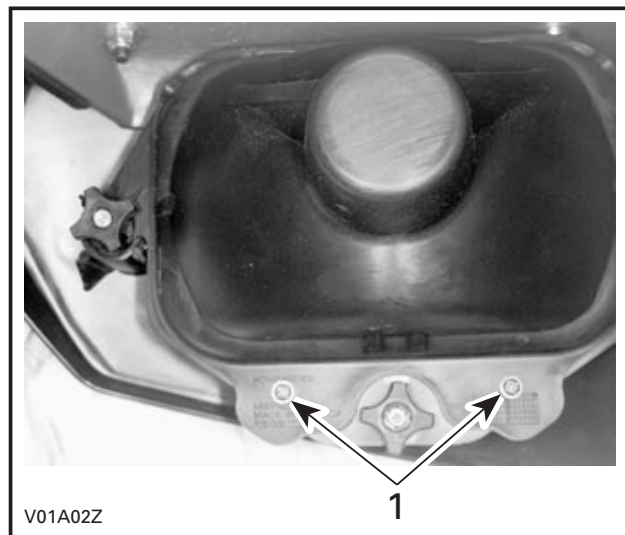

1. Remove screws and lift up the sealed beam cover

Properly reinstall removed parts in the reverse order of their removal.

Adjust beam aiming as follows:

Turn knobs to adjust beam height and side orientation to your convenience. Adjust both headlamps evenly.

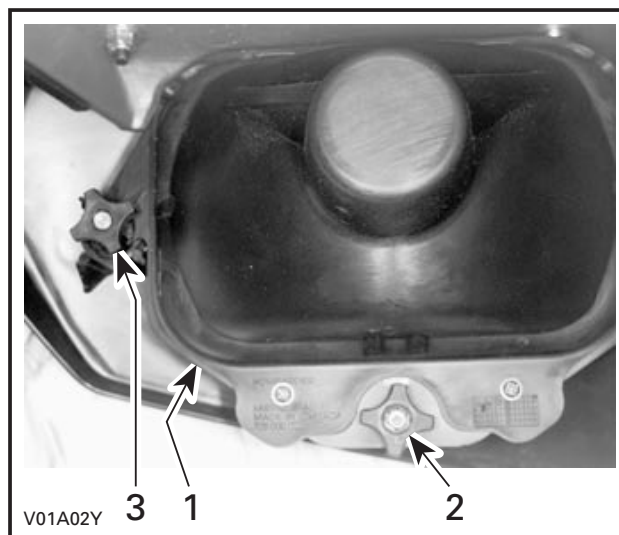

1. Headlamp
2. Beam height adjustment
3. Beam side adjustment

Taillight

Unscrew lens screws to expose bulb.

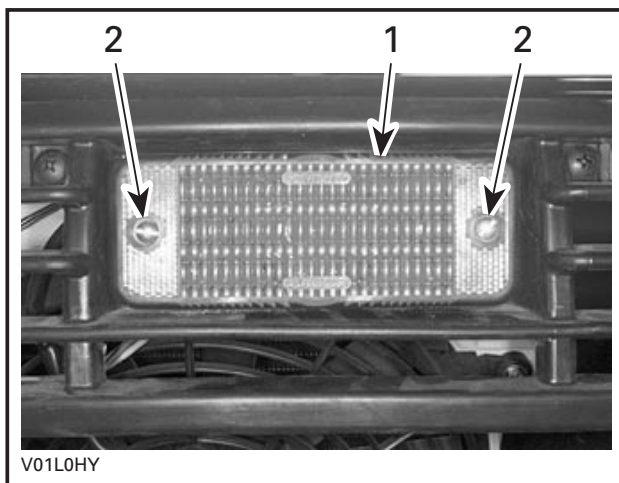

1. Lens
2. Screws

Push bulb in and hold while turning counterclockwise to release.

Install the new bulb by first pushing in while turning clockwise.

Indicator Light

If one LED is burnt in the indicator light cluster, see an authorized Bombardier ATV dealer for replacement of the light cluster.

Speedometer

The speedometer is lighted with LEDs. If one LED burns, replace the speedometer. The LEDs are not available separately.

Drive Train

Quest MAX and Traxter MAX Series

Front Propeller Shaft

Check the front propeller shaft boots for cracks, tears or other damages. See an authorized Bombardier ATV dealer if any damage is detected.

Check if the propeller shaft is straight and not damaged.

Rear Propeller Shaft

Lubricate the rear propeller shaft U-joint steadily. Use synthetic grease (P/N 293 550 033).

Drive Shaft Boot/Protector

Quest MAX and Traxter MAX Series

Visually inspect drive shaft protectors and boot conditions. Check protectors for damage or rubbing against shafts. Check boots for cracks, tears, leaking grease etc. Repair or replace damaged parts as necessary.

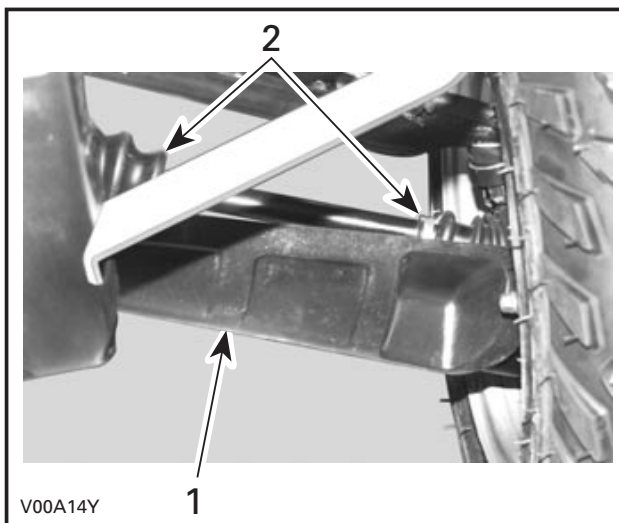

1. Drive shaft protector
2. Drive shaft boots

Wheel

Quest MAX and Traxter MAX Series

Occasionally, wheel nuts should be removed to apply anti-seize lubricant on studs to ease further removal. This is particularly important when vehicle is used in salt-water environment or in mud. Remove one nut at a time, lubricate then retorque.

Wheel Bearing Condition

Quest MAX and Traxter MAX Series

Push and pull the wheels from the upper edge to feel the play. See an authorized Bombardier ATV dealer if there is any play.



Tires/Wheels

Quest MAX and Traxter MAX Series

Tire Pressure

⚠ WARNING

Tire pressure greatly affects vehicle handling and stability. Under-pressure may cause tire to deflate and rotate on wheel. Overpressure may burst the tire. Always follow recommended pressure. Since tires are low-pressure types, a manual pump should be used.

Check pressure when tires are “cold” before using the vehicle. Tire pressure changes with temperature and altitude. Recheck pressure if one of these conditions has changed.

For your convenience, a pressure gauge is supplied in tool box.

TIRE PRESSURE			
QUEST MAX SERIES			
UP TO 272 KG (600 LB)	MAX.	FRONT 48 kPa (7 PSI)	REAR 48 kPa (7 PSI)
	MIN.	35 kPa (5 PSI)	35 kPa (5 PSI)
TRAXTER MAX SERIES			
UP TO 290 KG (640 LB)	MAX.	48 kPa (7 PSI)	48 kPa (7 PSI)
	MIN.	35 kPa (5 PSI)	35 kPa (5 PSI)

Although the tires are specifically designed for off-road use, a flat may still occur. Therefore, it is recommended to carry a tire pump and a repair kit.

Tire/Wheel Condition

Check tire for damage and wear. Replace if necessary.

Do not make a tire rotation. The front and rear tires have a different size. The tires are directional and their rotation must be kept in a specific direction for proper operation.

Wheel Removal

Loosen nuts then lift vehicle. Place a support under vehicle. Remove nuts then remove wheel.

At installation, it is recommended to apply anti-seize lubricant on threads. Gently tighten nuts in a criss-cross sequence then apply a final torque of 75 N•m (55 lbf•ft).

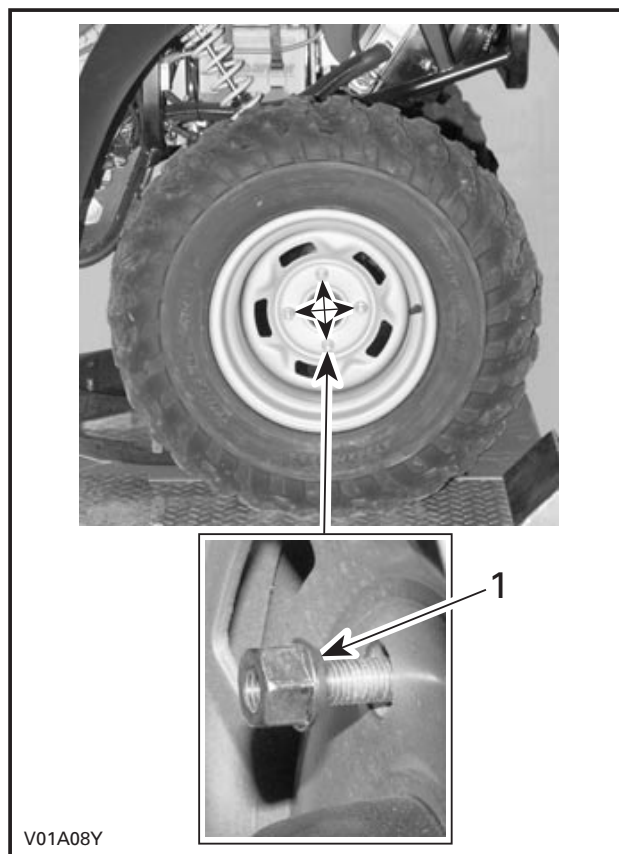

1. Taper side of nut

CAUTION: Always use the recommended wheel nuts (P/N 705 400 013). Using a different nut could cause damages to the rim.

Steering System

Quest MAX and Traxter MAX Series Throttle Cable Lubrication

The throttle cable must be lubricated with Bombardier cable lubricant (P/N 293 600 041) or an equivalent.

WARNING

Using another lubricant could cause the throttle lever/cable sticking or stiffness.

Open the throttle lever housing.

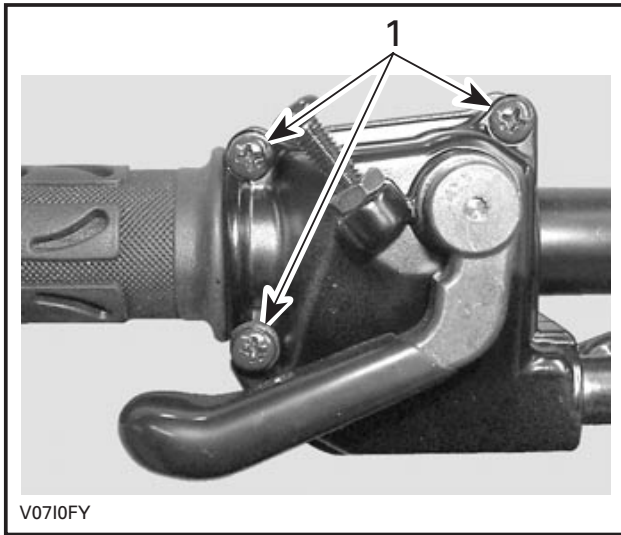

1. Remove these screws

Separate the housing. Slide rubber protector back to expose throttle cable adjuster.

Unscrew the locking nut of the cable adjuster then screw in the adjuster to release the cable tension.

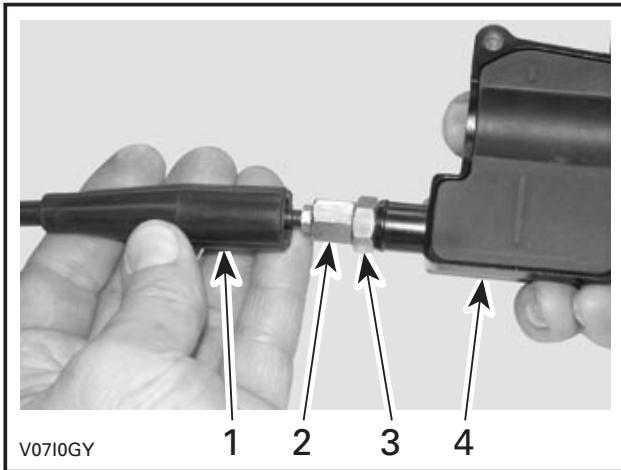

1. Cable protector
2. Throttle cable adjuster
3. Lock nut
4. Throttle lever housing

Remove:

- inner housing protector

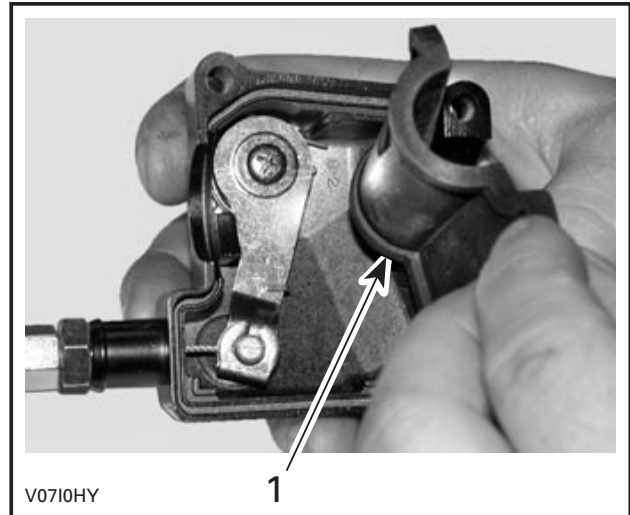

1. Inner housing protector

- the cable from the throttle lever housing.

NOTE: Slide cable in clip slot and remove the end of cable from clip.

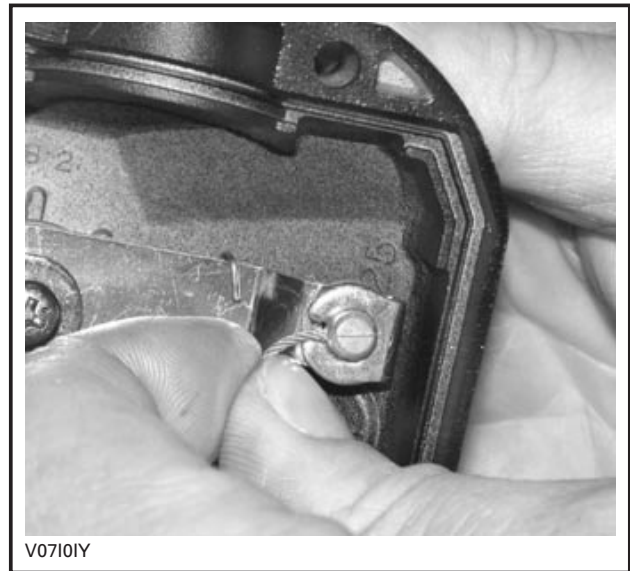

Remove the carburetor side cover.
Insert the needle of spray can in the end of throttle cable adjuster.

⚠ WARNING

Always wear eye protection and gloves when you lubricate a cable.

NOTE: Place a rag around the throttle cable adjuster to prevent the lubricant splash.

Add lubricant until it runs out at carburetor end of the throttle cable.

Reinstall and adjust the cable.

Throttle Lever Adjustment

Slide rubber protector back to expose throttle cable adjuster.

Loosen lock nut then turn the adjuster to obtain correct throttle lever free play.

NOTE: Measure throttle free play at the tip of throttle lever.

Tighten lock nut and reinstall protector.

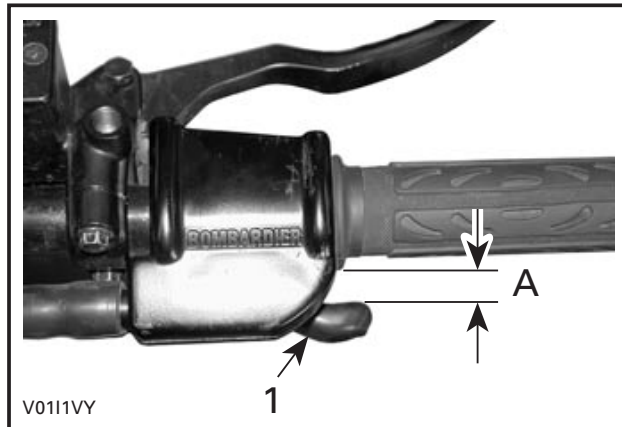

1. Throttle lever
A. 3 to 6 mm (1/8 to 7/32 in)

With the transmission lever on PARK position, start the engine. Check if the throttle cable is adjusted correctly by turning handlebar fully right then fully left. If the engine RPM increases, re-adjust the throttle lever free play.

Suspension

Quest MAX and Traxter MAX Series Lubrication

A-Arms

Lubricate front A-arms. Use suspension synthetic grease (P/N 293 550 033). There are two grease fittings on the upper A-arm and two on the lower A-arm (underneath).

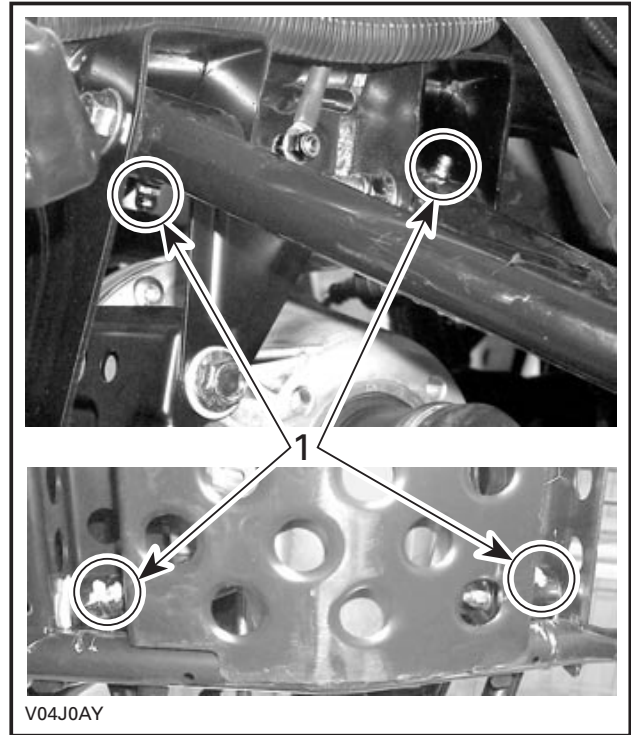

1. Grease fittings

Inspection

A-Arms

Check A-arms for cracks, bending or other damages. See an authorized Bombardier ATV dealer as necessary.

Swing Arm

Check swing arm for distortion, cracks or bending. See an authorized Bombardier ATV dealer if any problem is detected.

Shock Absorbers

Inspect shock absorber for oil leaks and fasteners for tightness. See an authorized Bombardier ATV dealer as necessary.

Adjustment

Rear Shocks

⚠ WARNING

Left and right adjusting cams must always be set at the same position. Never adjust one adjusting cam only. Uneven adjustment can cause poor handling and loss of stability, which could lead to an accident.

Preload Adjustment

Adjust spring preload by turning adjusting cam accordingly with the adjusting wrench in vehicle tool box.

Turn the adjusting cams clockwise for a firmer ride and rough road condition or when carrying cargo or pulling a trailer.

Turn the adjusting cams counterclockwise for a light load and a smooth road condition.

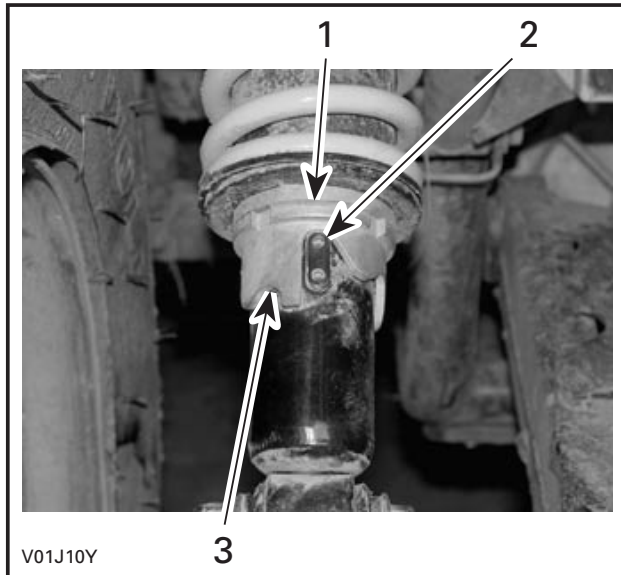

TYPICAL

1. Adjusting cams
2. Smooth adjustment
3. Hard adjustment

Brake

Quest MAX and Traxter MAX Series

⚠ WARNING

Any brake system repair should be performed by an authorized Bombardier ATV dealer.

The front brakes are hydraulic disc types. These brakes are self-adjusting and require no adjustment.

The rear brake employs two systems. The first system uses a cable; an adjustment is necessary. See an authorized Bombardier ATV dealer. The second system is hydraulic and requires no adjustment. The systems are linked together for a higher efficiency.

Inspection

Check the following to keep the brakes in a good operating condition:

- brake system for fluid leaks
- brake for spongy feel
- brake discs for excessive wear and surface condition
- brake pads for wear, damage or looseness.

SERVICE LIMITS	
Brake pads thickness	1 mm (.040 in)
Discs thickness	4.5 mm (.18 in)
Maximum discs warpage	0.2 mm (.01 in)

Brake Fluid Replacement

WARNING

The brake fluid replacement should be performed by an authorized Bombardier ATV dealer.

Brake Cable Lubrication

Remove brake lever and lock (screw, nut and spring).

Remove cable from hand lever. To ease this operation, apply a force on the brake pedal to loosen the cable.

Put the cable luber (P/N 529 035 738) on the cable.

Insert the needle of the spray can in the cable luber hole.

Spray a small quantity of silicone lubricant (P/N 293 600 041) then press the brake pedal to move the brake cable. Repeat this procedure until the silicone lubricant exits the other end of the cable.

Body/Frame

Quest MAX and Traxter MAX Series

Backrest

Before every ride, check backrest condition.

WARNING

Never ride with a passenger if the solidity or the general condition of the backrest is faulty.

Grab Handle

The condition of grab handle must be checked before every ride.

WARNING

Never ride with a passenger if the grab handles are damaged or not fastened securely

Engine Compartment

Check engine compartment for any damage and leaks. Ensure all hose clamps are properly secured and no hose is cracked, kinked or otherwise damaged.

Inspect muffler, battery and reservoir fastening devices. Check electrical connections for corrosion and tightness.

Replace or have damaged parts repaired.

Skid Plate Condition

Check tightness of fasteners and condition of plate for cracks or other damage. Properly retighten fasteners as necessary and have skid plate replaced if damaged.

Hitch/Trailer Ball Condition

Check tightness of fasteners and tightness/condition of trailer ball. Properly retighten as necessary and replace ball if worn.

Fasteners

Check fastener condition and tightness on the vehicle. Retighten as required.

Seat Latch

Remove seat and check the locking mechanism and its pin for wear. See an authorized Bombardier ATV dealer for parts replacement if damaged.

Front Storage Compartment Latch

Check latch condition. See an authorized Bombardier ATV dealer for parts replacement if damaged.

Vehicle Cleaning and Protection

Never use a high pressure washer to clean the vehicle. **USE LOW PRESSURE ONLY** (like a garden hose). High pressure can cause electrical or mechanical damages.

Painted parts which are damaged should be properly repainted to prevent rust.

When required, wash the body with hot water and soap (only use mild detergent). Apply non-abrasive wax.

CAUTION: Never clean plastic parts with strong detergent, degreasing agent, paint thinner, acetone, etc.

Winch

Quest MAX XT and Traxter MAX XT

No lubrication is required for the life of the winch.

Check battery cables at 90 day intervals to be certain that they are clean and tight at all connections.

Inspect the wire rope before and after each winching operation. Replace winch rope when damaged.

For more details, see *ATV Winch Operator's Manual*.

NOTE: This manual should be kept in the tool box and remain with the vehicle at all time.

TROUBLESHOOTING

SYMPTOM: <i>Engine does not turn</i>	
POSSIBLE CAUSES	WHAT TO DO
1. Ignition switch is in the OFF position.	Place switch to ON position.
2. Transmission is not set on PARK or NEUTRAL.	Set transmission either in PARK or in NEUTRAL or press any brake lever.
3. Burnt fuse.	On Quest MAX series , check main fuse condition. On Traxter MAX series , check MPEM and solenoids fuses condition.
4. Weak battery or loose connections.	Check charging system fuse. Check connections and terminals condition. Have the battery checked. Contact an authorized Bombardier ATV dealer.

SYMPTOM: <i>Engine turns over but fails to start</i>	
POSSIBLE CAUSES	WHAT TO DO
1. Burnt fuse.	Check ignition fuse condition.
2. Mixture not rich enough to start cold engine.	Check fuel tank level and check starting procedure, particularly use of the choke. NOTE: On Traxter MAX series , below - 15°C (5°F) the use of fuel primer (optional) is required. Also, it is recommended to add gas line antifreeze.
3. Flooded engine (spark plug(s) wet when removed).	Refer to SPECIAL PROCEDURES.
4. No fuel to the engine (spark plug(s) dry when removed).	Check fuel tank level; turn fuel valve to ON (also try on RES). A failure of the fuel pump or carburetor may have occurred. Contact an authorized Bombardier ATV dealer.
5. Spark plug/ignition (no spark).	Check ignition fuse condition. Remove spark plug(s) then reconnect to ignition coil or spark plug caps. Check that ignition switch and/or engine stop switch(es) is/are at the ON position. Start engine with spark plug(s) grounded to engine away from spark plug holes. If no spark appears, replace spark plug(s). If trouble persists, contact an authorized Bombardier ATV dealer.
6. Engine compression.	As the engine is pulled over with the starter or with the rewind starter, "cycles" of resistance should be felt as piston goes past top dead center. If no pulsating resistance is felt, it suggests a major loss of compression. Contact an authorized Bombardier ATV dealer.

SYMPTOM: <i>Engine lacks acceleration or power</i>	
POSSIBLE CAUSES	WHAT TO DO
1. Fouled or damaged spark plug(s).	Check item ENGINE TURNS OVER BUT FAILS TO START.
2. Lack of fuel to engine.	Check item ENGINE TURNS OVER BUT FAILS TO START.
3. Carburetor adjustments.	Contact an authorized Bombardier ATV dealer.
4. Engine is overheating.	Check ENGINE OVERHEAT in SPECIAL PROCEDURES. If overheating persists, contact an authorized Bombardier ATV dealer.
5. Air filter box plugged or dirty.	Check air filter and clean if necessary. Check deposits in air box drain. Check the position of the air intake tube, reinstall properly if necessary.
6. CVT dirty or wear.	Contact an authorized Bombardier ATV dealer.

SYMPTOM: <i>Engine backfire</i>	
POSSIBLE CAUSES	WHAT TO DO
1. Exhaust system leakage.	Contact an authorized Bombardier ATV dealer.
2. Engine is running too hot.	See ENGINE LACKS ACCELERATION OR POWER.
3. Ignition timing is incorrect or there is an ignition system failure.	Contact an authorized Bombardier ATV dealer.
4. Improper carburetor setting.	Contact an authorized Bombardier ATV dealer.

SYMPTOM: <i>Engine misfire</i>	
POSSIBLE CAUSES	WHAT TO DO
1. Fouled/damaged/worn spark plug(s).	Clean/verify spark plug(s) and heat range. Replace as required.
2. Water in fuel.	Drain fuel system and refill with fresh fuel.

SYMPTOM: <i>Vehicle cannot reach full speed</i>	
POSSIBLE CAUSES	WHAT TO DO
1. Engine.	See ENGINE LACKS ACCELERATION OR POWER.
2. Parking brake.	Ensure brake lever lock is completely removed.
3. Air filter box plugged or dirty.	Check air filter and clean if necessary. Check deposits in air box drain. Check the position of the air intake tube, reinstall properly if necessary.
4. CVT dirty or wear.	Contact an authorized Bombardier ATV dealer.

SYMPTOM: Engine indicator light irregularly flashes at idle speed

POSSIBLE CAUSES	WHAT TO DO
1. Engine idle is set too low.	Contact an authorized Bombardier ATV dealer.

SYMPTOM: Transmission does not shift smoothly

POSSIBLE CAUSES	WHAT TO DO
1. Engine/transmission oil level is low.	Refill engine with recommended oil at the proper level.
2. Transmission shifting system.	Try depressing the throttle lever more while shifting.
3. Improper oil type.	Drain oil in engine and use recommended oil only.
4. Transmission.	See an authorized Bombardier ATV dealer.

SYMPTOM: Transmission lever is hard to move

POSSIBLE CAUSES	WHAT TO DO
1. Transmission gears are in a position that prevents the transmission lever from working.	Rock the vehicle back and forth to move the gears in the transmission and allow the transmission lever to be set.
2. Engine idle speed is set too high.	Adjust the idle speed. Refer to the specification.
3. CVT dirty or wear.	Contact an authorized Bombardier ATV dealer.

SYMPTOM: AUTOSHIFT mode does not work

POSSIBLE CAUSES	WHAT TO DO
1. Multi-function switch problem.	Contact an authorized Bombardier ATV dealer.
2. TPS sensor is defect.	Check TPS connector on carburetor. If the connection is good, contact an authorized Bombardier ATV dealer.
3. Engine.	Contact an authorized Bombardier ATV dealer.

SYMPTOM: The RPM increases but the vehicle doesn't move

POSSIBLE CAUSES	WHAT TO DO
1. Transmission is set on PARK or NEUTRAL.	Move the transmission lever to R, H or L position.
2. CVT is defective.	Contact an authorized Bombardier ATV dealer.
3. Water in the CVT housing.	Contact an authorized Bombardier ATV dealer.

SPECIFICATIONS

VEHICLE MODEL		QUEST™ MAX	QUEST™ MAX XT
ENGINE			
Type		BOMBARDIER-ROTAX, 4-stroke. Over Head Camshaft (OHC), liquid cooled,	
Number of cylinder		Single cylinder	
Number of valves		4 valves with hydraulic lifters (no adjustment)	
Displacement		644 cc (39.3 cu. in)	
Bore	Standard	100 mm (3.9 in)	
Stroke		82 mm (3.2 in)	
Compression ratio		9.5:1	
Lubrication		Wet sump with replaceable oil filter (lubrication of engine and transmission simultaneously)	
Oil filter		BOMBARDIER-ROTAX	
Decompressor		Automatic	
Exhaust system		Spark arrester approved USDA Forest Service	
Air filter		2 stage foam filter	
TRANSMISSION			
Transmission		Continuously Variable Transmission (CVT)	
COOLING			
Type		Liquid cooled	
Radiator		Rear mounted with thermostatic fan	
CARBURETION			
Carburetor make and type		Mikuni BSR42. Constant depression type with manual choke and ECS (Enrichner Coasting System)	
Choke plunger position		Variable	
Idle speed	± 100	1100 RPM	
Fuel pump make and type		Mikuni, external (vacuum-operated)	

VEHICLE MODEL		QUEST™ MAX	QUEST™ MAX XT
ELECTRICAL			
Magneto generator make and type		Denso, 400 W @ 6000 RPM	
Ignition type		CDI (Capacitor Discharge Ignition)	
Ignition timing		Not adjustable	
Engine RPM limiter		7400 RPM (any gear in forward)	
Vehicle speed limiter		15 km/h (9 MPH) in reverse	
Spark plug make and type		NGK DCPR8E	
Number of spark plug		1	
Spark plug gap		0.6 to 0.7 mm (.024 to .027 in)	
Battery		12 V, 19 Ah – electrolyte type battery	
Starting system		Electric start. Start on P, R, N, H, L position (with brakes apply)	
Headlamp		2 x 30 W	
Taillight		8/27 W	
Pilot lamp cluster		LEDS, 0.7 V approx.	
FUSES			
Location no. 1 (spare 15A)		N.A.	
Location no. 2 (spare 15A)		N.A.	
Location no. 3 (accessories)		15 A (power outlet and auxiliary supply)	
Location no. 4 (fan)		15 A	
Location no. 5 (main)		20 A	
Location no. 6 (charging system)		30 A	
DRIVE TRAIN			
Front differential		Shaft driven/single auto-lock differential (shear pump)	
Rear axle		Shaft driven/solid axle	
SUSPENSION			
Front	Type	Independent suspension — double A-arm	
	Travel	178 mm (7 in)	
Rear	Type	Rigid swing-arm	
	Travel	191 mm (7.5 in)	
TIRES			
Pressure	Up to 272 kg (600 lb)	Front	35 kPa (5 PSI) minimum, 48 kPa (7 PSI) maximum
		Rear	35 kPa (5 PSI) minimum, 48 kPa (7 PSI) maximum
Size	Front	25 x 8 – 12	
	Rear	25 x 11 – 12	

VEHICLE MODEL		QUEST™ MAX	QUEST™ MAX XT
WHEELS			
Size	Front	12 x 6.5	
	Rear	12 x 8	
Wheel nut torque		75 N•m (55 lbf•ft)	
BRAKES			
Front		Hydraulic, 2 drilled discs	
Rear		Hydraulic, 1 drilled disc	
Parking		Park through transmission. LH brake lever includes a lock	
LOADING CAPACITY			
Front rack		40 kg (90 lb) includes front storage tray	
Rear rack		80 kg (175 lb) includes tongue load	
Console		5 kg (11 lb)	
Total vehicle load allowed		272 kg (600 lb) includes operator and passenger, all other loads and added accessories (estimate)	
GVWR (Gross Vehicle Weight Rating)		646 kg (1420 lb)	
Towing capacity		500 kg (1100 lb)	
Tongue capacity		14 kg (30 lb) included with rear rack	
Front storage tray		10 kg (22 lb) included with front rack	
DIMENSIONS			
Dry mass		363 kg (798 lb)	
Overall length		2.33 m (92 in)	2.37 m (93 in)
Overall width		1.20 m (47 in)	
Overall height		1.33 m (52 in)	
Seat height		945 mm (37 in)	
Wheel base		1.55 m (61 in)	
Wheel track	Front	992 mm (39 in)	
	Rear	940 mm (37 in)	
Turning radius		2.36 m (93 in)	
Ground clearance	Front and under engine	244 mm (9.6 in)	
	Rear axle	188 mm (7.4 in)	
Weight distribution (front/rear)		49/51 %	

VEHICLE MODEL		QUEST™ MAX	QUEST™ MAX XT
LIQUIDS			
Oil type (engine and transmission)		SAE 10W40, 4-stroke mineral-based engine oil. API classification SG,SH or SJ or Bombardier synthetic oil 5W40. Refer to OIL VISCOSITY CHART for proper grade	
Coolant		Ethylene-glycol/water mix (50% coolant, 50% distilled water). Use coolant specifically designed for aluminum engines	
Fuel	Type	Regular unleaded gasoline	
	Octane	87 (R + M)/2 or higher	
Differential	Front/rear	Synthetic polyolester oil 75W90 (API GL-5)	
Hydraulic brake		Brake fluid, DOT 4	
Propeller shaft joint grease		Shell, Alvania EP-2 only	
CAPACITIES			
Fuel tank		22 L (5.8 U.S. gal) including approximately 4 L (1.1 U.S. gal) reserve	
Engine/transmission oil		Oil change with filter: 2.5 L (2.65 quarts). Total: 3 L (3.17 quarts)	
Coolant		2.5 L (2.65 quarts)	
Differential	Front	610 mL (21 U.S. oz)	
	Rear	250 mL (8.5 U.S. oz)	

W = watt

N.A. = Not applicable

Because of our ongoing commitment to product quality and innovation, Bombardier reserves the right, at any time, to make changes in design and specifications and/or to make additions to, or improvements in its products without imposing any obligation upon itself to install them on its products previously manufactured.

VEHICLE MODEL		TRAXTER® MAX	TRAXTER® MAX XT
ENGINE			
Type		BOMBARDIER-ROTAX, 4-stroke. Longitudinal mount, liquid cooled, OHV	
Number of cylinder		Single cylinder	
Number of valves		2 valves with hydraulic lifters (no adjustment)	
Displacement		498 cc (30.4 cu. in)	
Bore	Standard	89 mm (3.5 in)	
Stroke		80 mm (3.15 in)	
Compression ratio		9:1	
Lubrication		Wet sump with replaceable oil filter (lubrication of engine and transmission simultaneously)	
Oil filter		BOMBARDIER-ROTAX	
Decompressor		Automatic	
Exhaust system		Spark arrester USDA Forest Service approved	
Air filter		2 stage foam filter	
TRANSMISSION			
Clutch		1 centrifugal and 1 multi-disc hydraulically controlled	
Transmission		Dual range (HI-LO) with park, neutral and reverse. 5 speeds. Electronically controlled hydraulic shift. Limited vehicle reverse speed	
COOLING			
Type		Liquid cooled	
Radiator		Rear mounted with thermostatic fan	
CARBURETION			
Carburetor make and type		Mikuni BSR33. Constant depression type with manual choke and ECS (Enrichner Coasting System)	
Choke plunger position		Variable	
Idle speed	± 100	1100 RPM	
Fuel pump make and type		Mikuni, external (vacuum-operated)	

VEHICLE MODEL		TRAXTER® MAX	TRAXTER® MAX XT
ELECTRICAL			
Magneto generator make and type		Denso, 400 W @ 6000 RPM	
Ignition type		IDI (Inductive Discharge Ignition)	
Ignition timing		Not adjustable	
Engine RPM limiter		7700 RPM (any gear in forward)	
Vehicle speed limiter		15 km/h (9 MPH) in reverse	
Spark plug make and type		NGK DR8EA	
Number of spark plug		2	
Spark plug gap		0.6 to 0.7 mm (.024 to .027 in)	
Battery		12 V, 19 Ah – electrolyte type battery	
Starting system		Electric start and manual rewind starter. Start in any gear (with brake applied)	
Headlight		2 x 55 W, H4703	
Taillight		8/27 W, 1157	
Pilot lamp cluster		LEDS, 0.7 V approx.	
FUSES			
Ignition (no. 1)		15 A	
Accessories (no. 2)		15 A (power outlet and auxiliary supply)	
Solenoids (no. 3)		15 A	
Fan (no. 4)		15 A	
MPEM (Multi-Purpose Electronic Module) (no. 5)		20 A	
Charging system (no. 6)		30 A	
DRIVE TRAIN			
Front differential		Shaft driven/single auto-lock differential (shear pump)	
Rear axle		Shaft driven/solid axle	
Turning radius		2.36 m (93 in)	
SUSPENSION			
Front	Type	Independent suspension — double A-arm	
	Travel	178 mm (7 in)	
Rear	Type	Rigid swing-arm	
	Travel	190.5 mm (7.5 in)	
TIRES			
Pressure	Up to 290 kg (640 lb)	Front	35 kPa (5 PSI) minimum, 48 kPa (7 PSI) maximum
		Rear	35 kPa (5 PSI) minimum, 48 kPa (7 PSI) maximum
Size		Front	25 x 8 – 12 TRAILWOLF
		Rear	26 x 10 – 12 TRAILWOLF

VEHICLE MODEL		TRAXTER® MAX	TRAXTER® MAX XT
WHEELS			
Size	Front	12 x 6.5	
	Rear	12 x 8	
Wheel nut torque		75 N•m (55 lbf•ft)	
BRAKES			
Front		Hydraulic, 2 drilled discs	
Rear		Hydraulic, 1 drilled disc	
Parking		Park through transmission. LH brake lever includes a lock	
LOADING CAPACITY			
Front rack		40 kg (90 lb) includes front storage tray	
Rear rack		80 kg (175 lb) includes tongue load	
Total vehicle load allowed		290 kg (640 lb) includes operator and passenger, all other loads and added accessories (estimate)	
GVWR (Gross Vehicle Weight Rating)		682 kg (1500 lb)	
Towing capacity		500 kg (1100 lb)	
Tongue capacity		14 kg (30 lb) included with rear rack	
Front storage tray		10 kg (22 lb) included with front rack	
DIMENSIONS			
Dry mass		361 kg (795 lb)	
Overall length		2.34 m (92 in)	
Overall width		1.20 m (47 in)	
Overall height		1.33 m (52 in)	
Seat height		945 mm (37 in)	
Wheel base		1.55 m (61 in)	
Wheel track	Front	992 mm (39 in)	
	Rear	940 mm (37 in)	
Ground clearance	Front and under engine	244 mm (9.6 in)	
	Rear axle	188 mm (7.4 in)	
Weight distribution (front/rear)		47/53%	

VEHICLE MODEL		TRAXTER® MAX	TRAXTER® MAX XT
LIQUIDS			
Oil type (engine and transmission)		SAE10W40, 4-stroke mineral-based engine oil. API classification SG,SH or SJ or Bombardier synthetic oil 5W40. Do not use other synthetic oil, synthetic blend oil or special additive. Refer to OIL VISCOSITY CHART for proper grade	
Coolant		Ethylene-glycol/water mix (50% coolant, 50% distilled water). Use coolant specifically designed for aluminum engines	
Fuel	Type	Regular unleaded gasoline	
	Octane	87 (R + M)/2 or higher	
Differential	Front/rear	Synthetic polyolester oil 75W90 (API GL-5)	
Hydraulic brake		Brake fluid, DOT 4	
Propeller shaft joint grease		Shell, Alvania EP-2 only	
CAPACITIES			
Fuel tank		20 L (5.3 U.S. gal) including approximately 6 L (1.6 U.S. gal) reserve	
Engine/transmission oil		Oil change with filter: 2.5 L (2.65 quarts). Total: 3 L (3.17 quarts)	
Coolant		2.5 L (2.65 quarts)	
Differential	Front	610 mL (21 U.S. oz)	
	Rear	250 mL (8.5 U.S. oz)	

W = watt

N.A. = Not applicable

Because of our ongoing commitment to product quality and innovation, Bombardier reserves the right, at any time, to make changes in design and specifications and/or to make additions to, or improvements in its products without imposing any obligation upon itself to install them on its products previously manufactured.

SI* METRIC INFORMATION GUIDE

BASE UNITS			
DESCRIPTION	UNIT	SYMBOL	
length	meter	m	
mass	kilogram	kg	
force	newton	N	
liquid	liter	L	
temperature	Celsius	°C	
pressure	kilo pascal	kPa	
torque	newton-meter	N•m	
land velocity	kilometer per hour	km/h	
PREFIXES			
PREFIX	SYMBOL	MEANING	VALUE
kilo	K	one thousand	1000
centi	C	one hundredth of	0.01
milli	m	one thousandth of	0.001
micro	μ	one millionth of	0.000001
CONVERSION FACTORS			
TO CONVERT	TO ①	MULTIPLY BY	
in	mm	25.4	
in	cm	2.54	
in ²	cm ²	6.45	
in ³	cm ³	16.39	
ft	m	0.3	
oz	g	28.35	
lb	kg	0.45	
lbf	N	4.4	
lbf•in	N•m	0.11	
lbf•ft	N•m	1.36	
lbf•ft	lbf•in	12	
PSI	kPa	6.89	
imp. oz	U.S. oz	0.96	
imp. oz	mL	28.41	
imp. gal	U.S. gal	1.2	
imp. gal	L	4.55	
U.S. oz	mL	29.57	
U.S. gal	L	3.79	
MPH	km/h	1.61	
Fahrenheit	Celsius	$(°F - 32) \div 1.8$	
Celsius	Fahrenheit	$(°C \times 1.8) + 32$	
hp	kW75	

* The international system of units abbreviates SI in all languages.

① To obtain the reverse sequence, divide by the given factor. To convert **millimeters** to **inches**, divide by 25.4.

NOTE: Conversion factors are rounded off to 2 decimals for easier use.

WARRANTY

BOMBARDIER LIMITED WARRANTY NORTH AMERICA: 2004 BOMBARDIER® ATV

1. SCOPE OF THE LIMITED WARRANTY

In Canada, BOMBARDIER INC. (hereinafter "BOMBARDIER"), and in the USA, BOMBARDIER ON BEHALF OF BOMBARDIER MOTOR CORPORATION OF AMERICA (BMCA) warrants its 2004 BOMBARDIER ATV from defects in material or workmanship for the period described below.

All genuine BOMBARDIER parts and accessories, installed by an authorized BOMBARDIER ATV dealer (as hereinafter defined) at the time of delivery of the 2004 BOMBARDIER ATV, carry the same warranty as that of the ATV.

Following tires and winches supplied as original equipment on your ATV are warranted separately by the individual tire or winch manufacturer as identified below. If an original tire or winch on your BOMBARDIER ATV has a defect in material or workmanship, please contact these manufacturers or ask your authorized BOMBARDIER dealer for assistance.

Carlisle Tire & Wheel Company
(TRAXTER AND QUEST TIRES)
23 Windham Boulevard
Aiken, SC 29805

Warn Industries Inc. (Winch)
12900 SE Capps Road
Clackamas, Oregon 97015-8903

Warranty Information:

In USA 1 800 260-7959
In Canada 1 800 265-6155
In Quebec 1 877 997-4999

Customer service:

In USA 1 800 543-9276
In Canada 1 800 668-6012
In Quebec 1 800 361-9291

Please note that for any other 2004 ATV models, unless differently specified, tires are warranted directly by BOMBARDIER and not by the manufacturer company which produce these tires.

Use of the product for racing or any other competitive activity, at any point, even by a previous owner, will render this warranty null and void.

2. WARRANTY COVERAGE PERIOD

This warranty will be in effect FROM THE DATE OF DELIVERY TO THE FIRST RETAIL CONSUMER or the date the product is first put into use, whichever occurs first and for a period of:

SIX (6) CONSECUTIVE MONTHS, for private use or commercial use owners.

The repair or replacement of parts or the performance of service under this warranty does not extend the life of this warranty beyond its original expiration date.

3. CONDITIONS TO HAVE WARRANTY COVERAGE

This warranty coverage is available only on 2004 BOMBARDIER ATV purchased as new and unused by its first owner from a BOMBARDIER dealer authorized to distribute Bombardier ATV products in the country in which the sale occurred (hereinafter "BOMBARDIER ATV dealer"), and then only after the BOMBARDIER specified pre-delivery inspection process is completed and documented. Moreover, this warranty coverage is only available if the Bombardier ATV is purchased in the country in which the purchaser resides. Bombardier will not honor this limited warranty to any personal use owner or commercial use owner where the preceding conditions have not been met. Warranty coverage only becomes available upon proper registration of the product by an authorized BOMBARDIER ATV dealer. Such limitations are necessary in order to allow BOMBARDIER to preserve both the safety of its products, and also that of its consumers and the public.

Routine maintenance outlined in the *Operator's Guide* must be timely performed in order to maintain warranty coverage. BOMBARDIER reserves the right to make warranty coverage contingent upon proof of proper maintenance.

4. WHAT TO DO TO OBTAIN WARRANTY COVERAGE

The customer must notify a servicing BOMBARDIER ATV dealer within two (2) days of the appearance of a defect, and provide it with reasonable access to the product and reasonable opportunity to repair it. The customer must also present to the authorized BOMBARDIER dealer, proof of purchase of the product and must sign the repair/work order prior to starting the repair in order to validate the warranty repair. All parts replaced under this limited warranty become the property of BOMBARDIER.

5. WHAT BOMBARDIER WILL DO

BOMBARDIER's obligations under this warranty are limited to, at its sole discretion, repairing parts found defective under normal use, maintenance and service, or replacing such parts with new genuine BOMBARDIER parts without charge for parts and labor, at any authorized BOMBARDIER ATV dealer during the warranty coverage period.

BOMBARDIER reserves the right to improve or modify products from time to time without assuming any obligation to modify products previously manufactured.

6. EXCLUSIONS - ARE NOT WARRANTED

- Normal wear and tear;
- Routine maintenance items, tune ups, adjustments;
- Damage caused by failure to provide proper maintenance and/or storage, as described in the *Operator's Guide*;
- Damage resulting from removal of parts, improper repairs, service, maintenance, modifications or use of parts not manufactured or approved by BOMBARDIER or resulting from repairs done by a person that is not an authorized servicing BOMBARDIER ATV dealer;
- Damage caused by abuse, abnormal use, neglect or operation of the product in a manner inconsistent with the recommended operation described in the *Bombardier ATV Operator's Guide*;
- Damage resulting from accident, submersion, fire, theft, vandalism or any act of God;
- Operation with fuels, oils or lubricants which are not suitable for use with the product (see the *Operator's Guide*);
- Water or snow ingestion;
- Incidental or consequential damages, or damages of any kind including without limitation towing, storage, telephone, rental, taxi, inconvenience, insurance coverage, loan payments, loss of time, loss of income.

7. LIMITATIONS OF LIABILITY

THIS WARRANTY IS EXPRESSLY GIVEN AND ACCEPTED IN LIEU OF ANY AND ALL OTHER WARRANTIES, EXPRESSED OR IMPLIED, INCLUDING WITHOUT LIMITATION ANY WARRANTY OF MERCHANTABILITY OR FITNESS FOR A PARTICULAR PURPOSE. TO THE EXTENT THAT THEY CANNOT BE DISCLAIMED, THE IMPLIED WARRANTIES ARE LIMITED IN DURATION TO THE LIFE OF THE EXPRESS WARRANTY. INCIDENTAL AND CONSEQUENTIAL DAMAGES ARE EXCLUDED FROM COVERAGE UNDER THIS WARRANTY. SOME STATES/PROVINCES DO NOT ALLOW FOR THE DISCLAIMERS, LIMITATIONS AND EXCLUSIONS IDENTIFIED ABOVE, AS A RESULT, THEY MAY NOT APPLY TO YOU. THIS WARRANTY GIVES YOU SPECIFIC RIGHTS, AND YOU MAY ALSO HAVE OTHER LEGAL RIGHTS WHICH MAY VARY FROM STATE TO STATE, OR PROVINCE TO PROVINCE.

Neither the distributor, any BOMBARDIER ATV dealer nor any other person has been authorized to make any affirmation, representation or warranty regarding the product, other than those contained in this limited warranty, and if made, shall not be enforceable against BOMBARDIER.

BOMBARDIER reserves the right to modify this warranty at any time, being understood that such modification will not alter the warranty conditions applicable to the products sold while this warranty is in effect.

8. TRANSFER

If the ownership of a product is transferred during the warranty coverage period, this warranty shall also be transferred and be valid for the remaining coverage period provided that BOMBARDIER is notified of such transfer of ownership in the following way:

- a) The former owner contacts BOMBARDIER (at the phone number provided below) or an authorized BOMBARDIER ATV dealer and gives the coordinates of the new owner; or
- b) BOMBARDIER or an authorized BOMBARDIER ATV dealer receives a proof that the former owner agreed to the transfer of ownership, in addition to the coordinates of the new owner.

9. CONSUMER ASSISTANCE

- a) In the event of a controversy or a dispute in connection with this BOMBARDIER LIMITED WARRANTY, BOMBARDIER suggests that you try to resolve the issue at the dealership level. We recommend discussing the issue with the authorized dealer's service manager or owner.
- b) If the issue has not yet been resolved, please submit your complaint in writing or call the appropriate number below:

In Canada:

BOMBARDIER INC.
RECREATIONAL PRODUCTS
BOMBARDIER ATV
CUSTOMER ASSISTANCE CENTER
VALCOURT QC J0E 2L0
Tel.: (819) 566-3366

In USA:

BOMBARDIER MOTOR
CORPORATION OF AMERICA
RECREATIONAL PRODUCTS
BOMBARDIER ATV
CUSTOMER ASSISTANCE CENTER
7575 BOMBARDIER COURT
WAUSAU WI 54401
Tel.: (715) 848-4957

© 2003 Bombardier Inc. All rights reserved

® Registered trademark of Bombardier Inc. or its subsidiaries.

BOMBARDIER INTERNATIONAL LIMITED WARRANTY: 2004 BOMBARDIER® ATV

1. SCOPE OF THE LIMITED WARRANTY

BOMBARDIER INC. (hereinafter "BOMBARDIER"), warrants its 2004 BOMBARDIER ATV from defects in material or workmanship for the period described below.

All genuine BOMBARDIER parts and accessories, installed by an authorized BOMBARDIER distributor/dealer (as hereinafter defined) at the time of delivery of the 2004 BOMBARDIER ATV, carry the same warranty as that of the ATV.

Use of the product for racing or any other competitive activity, at any point, even by a previous owner; will render this warranty null and void.

2. WARRANTY COVERAGE PERIOD

This warranty will be in effect FROM THE DATE OF DELIVERY TO THE FIRST RETAIL CONSUMER or the date the product is first put into use, whichever occurs first and for a period of:

SIX (6) CONSECUTIVE MONTHS, for private use or commercial use owners.

The repair or replacement of parts or the performance of service under this warranty does not extend the life of this warranty beyond its original expiration date.

3. CONDITIONS TO HAVE WARRANTY COVERAGE

This warranty coverage is available only on 2004 BOMBARDIER ATV purchased as new and unused by its first owner from a BOMBARDIER distributor/dealer authorized to distribute BOMBARDIER ATV products in the country in which the sale occurred (hereinafter "BOMBARDIER ATV distributor/dealer", and then only after the BOMBARDIER specified pre-delivery inspection process is completed and documented. Moreover, this warranty coverage is only available if the BOMBARDIER ATV is purchased in the country in which the purchaser resides. BOMBARDIER will not honor this limited warranty to any personal use owner or commercial use owner where the preceding conditions have not been met. Warranty coverage only becomes available upon proper registration of the product by an authorized BOMBARDIER ATV distributor/dealer. Such limitations are necessary in order to allow BOMBARDIER to preserve both the safety of its products, and also that of its consumers and the public.

Routine maintenance outlined in the *Operator's Guide* must be timely performed in order to maintain warranty coverage. BOMBARDIER reserves the right to make warranty coverage contingent upon proof of proper maintenance.

4. WHAT TO DO TO OBTAIN WARRANTY COVERAGE

The customer must notify a servicing BOMBARDIER ATV distributor/dealer within two (2) days of the appearance of a defect, and provide it with reasonable access to the product and reasonable opportunity to repair it. The customer must also present to the authorized BOMBARDIER distributor/dealer, proof of purchase of the product and must sign the repair/work order prior to starting the repair in order to validate the warranty repair. All parts replaced under this limited warranty become the property of BOMBARDIER.

5. WHAT BOMBARDIER WILL DO

BOMBARDIER's obligations under this warranty are limited to, at its sole discretion, repairing parts found defective under normal use, maintenance and service; or replacing such parts with new genuine BOMBARDIER parts without charge for parts and labour, at any authorized BOMBARDIER distributor/dealer.

BOMBARDIER reserves the right to improve or modify products from time to time without assuming any obligation to modify products previously manufactured.

6. EXCLUSIONS - ARE NOT WARRANTED

- Normal wear and tear;
- Routine maintenance items, tune ups, adjustments;
- Damage caused by failure to provide proper maintenance and/or storage, as described in the *Operator's Guide*;
- Damage resulting from removal of parts, improper repairs, service, maintenance, modifications or use of parts not manufactured or approved by BOMBARDIER or resulting from repairs done by a person that is not an authorized servicing BOMBARDIER distributor/dealer;
- Damage caused by abuse, abnormal use, neglect or operation of the product in a manner inconsistent with the recommended operation described in the *Operator's Guide*;
- Damage resulting from accident, submersion, fire, theft, vandalism or any act of God;
- Operation with fuels, oils or lubricants which are not suitable for use with the product (see the *Operator's Guide*);
- Water or snow ingestion;
- Incidental or consequential damages, or damages of any kind including without limitation towing, storage, telephone, rental, taxi, inconvenience, insurance coverage, loan payments, loss of time, loss of income.

7. LIMITATIONS OF LIABILITY

THIS WARRANTY IS EXPRESSLY GIVEN AND ACCEPTED IN LIEU OF ANY AND ALL OTHER WARRANTIES, EXPRESSED OR IMPLIED, INCLUDING WITHOUT LIMITATION ANY WARRANTY OF MERCHANTABILITY OR FITNESS FOR A PARTICULAR PURPOSE. TO THE EXTENT THAT THEY CANNOT BE DISCLAIMED, THE IMPLIED WARRANTIES ARE LIMITED IN DURATION TO THE LIFE OF THE EXPRESS WARRANTY. INCIDENTAL AND CONSEQUENTIAL DAMAGES ARE EXCLUDED FROM COVERAGE UNDER THIS WARRANTY. SOME JURISDICTIONS DO NOT ALLOW FOR THE DISCLAIMERS, LIMITATIONS AND EXCLUSIONS IDENTIFIED ABOVE, AS A RESULT, THEY MAY NOT APPLY TO YOU. THIS WARRANTY GIVES YOU SPECIFIC RIGHTS, AND YOU MAY ALSO HAVE OTHER LEGAL RIGHTS WHICH MAY VARY FROM COUNTRY TO COUNTRY.

Neither the distributor, any BOMBARDIER dealer nor any other person has been authorized to make any affirmation, representation or warranty regarding the product, other than those contained in this limited warranty, and if made, shall not be enforceable against BOMBARDIER.

BOMBARDIER reserves the right to modify this warranty at any time, being understood that such modification will not alter the warranty conditions applicable to the products sold while this warranty is in effect.

8. TRANSFER

If the ownership of a product is transferred during the warranty coverage period, this warranty shall also be transferred and be valid for the remaining coverage period provided that BOMBARDIER is notified of such transfer of ownership in the following way:

BOMBARDIER or an authorized BOMBARDIER ATV distributor/dealer receives a proof that the former owner agreed to the transfer of ownership, in addition to the co-ordinates of the new owner. The distributor will then forward this information directly to BOMBARDIER.

9. CONSUMER ASSISTANCE

- a) In the event of a controversy or a dispute in connection with this BOMBARDIER LIMITED WARRANTY, BOMBARDIER suggests that you try to resolve the issue at the dealership level. We recommend discussing the issue with the authorized dealer's service manager or owner.
- b) If further assistance is required, the distributor's service department should be contacted in order to resolve the matter.
- c) If the matter still remains unresolved then contact BOMBARDIER by writing to us at the address listed below.

BOMBARDIER INC.
RECREATIONAL PRODUCTS
BOMBARDIER ATV
CUSTOMER ASSISTANCE CENTER
VALCOURT QC J0E 2L0
Tel: (819) 566-3366

FREQUENTLY ASKED QUESTIONS

Q: Why must my vehicle be registered with the factory? After all, I do have my original invoice as proof of when I purchased my vehicle.

A: *Registration is very important and an authorized Bombardier ATV dealer must register your vehicle with Bombardier Inc. Make sure the registration card has been sent. All of this will allow you to:*

a) *Have warranty work performed at any authorized Bombardier ATV dealer in North America. Your registration card will provide the dealer with all the necessary data to complete warranty claim forms.*

b) *Be advised by Bombardier Inc. should there be a safety recall or a particular warranty campaign.*

c) *Be contacted much faster by the police, in the event that they find your vehicle subsequent to a theft.*

Q: Why must my vehicle be registered with the governing body having jurisdiction over vehicle use?

A: *Vehicle registration has two purposes: In many provinces or States, it is mandatory to register a vehicle in the same way as for a car. It allows the State or province to maintain records of existing vehicles. In some jurisdictions, governmental agencies use part of the registration fees for establishing and maintaining trails.*

Q: Where can I find information on the lubrication and maintenance of my vehicle?

A: *In the Operator's Guide provided with the vehicle at the time of delivery.*

Q: Will the entire warranty be voided or cancelled, if I do not operate or maintain my new vehicle exactly as specified in the *Operator's Guide*?

A: *The warranty of the new vehicle cannot be "Voided" or "Cancelled" if predelivered by an authorized Bombardier ATV dealer. However, if a particular failure is caused by operation or maintenance other than what is shown in the Operator's Guide, THAT failure may not be covered under warranty. This includes service work performed by the customer, oil and filter change and especially the critical adjustments such as the carburetor.*

Q: Would you give some examples of abnormal use or strain, neglect or abuse which may affect the limited warranty coverage?

A: *These terms are general and overlap each other in some cases. Some specific examples may include: running the engine out of oil, operating the vehicle with a broken or damaged part which causes another part to fail, and so on. If you have any specific questions on operation or maintenance, please contact an authorized Bombardier ATV dealer for advice.*

Q: What costs are my responsibility during the warranty period?

A: *The customer's responsibility includes all costs of normal maintenance services, non-warranty repairs, accidents and collision damage, as well as oils, and spark plugs, and incidental or consequential damages costs as explained in the warranty.*

Q: Are "Genuine" Bombardier replacement parts used in warranty repairs also covered by the limited warranty coverage?

A: *Yes. When installed by an authorized Bombardier ATV dealer, any "Genuine" Bombardier part used in warranty repairs assumes the remaining warranty that exists on the vehicle.*

Q: If I sell my vehicle within the warranty period, will the new owner qualify for the balance of the limited warranty coverage?

A: *Yes, provided the re-sale has been registered with the manufacturer.*

Q: How can I receive the best owner assistance?

A: *The satisfaction, safety and goodwill of the owners of Bombardier products are of primary concern to your ATV dealer and Bombardier Inc. Normally, any problems that arise in connection with the sales transaction or the operation of your vehicle will be handled by your Dealer's Sales or Service Departments. It is recognized, however, that despite the best intentions of everyone concerned, misunderstandings will sometimes occur. Frequently, complaints are the result of a breakdown in communications and can quickly be resolved by a member of the dealership management. If the problem already has been reviewed with the Sales Manager or Service Manager, contact the Dealer Principal himself or the General Manager.*

We are always pleased to receive your comments on this Bombardier ATV.

PRIVACY OBLIGATIONS/DISCLAIMER

We wish to inform you that your coordinates will be used for safety and warranty purposes. Sometimes, we also use the coordinates of our clients to inform them about our products and to present them offers. Should you prefer not to receive information on our products, services and offers, please let us know by writing to the address below.

Also note that, from time to time, carefully selected and trustworthy organizations may be permitted to use the coordinates of our clients to promote quality products and services. If you prefer not to have your name and address released, please let us know by writing to the address below:

**Bombardier Inc.
Recreational Products**

Warranty Department
75 J.A. Bombardier Street
Sherbrooke, Québec J1L 1W3
Canada

Fax Number (819) 566-3590



AFFIX
PROPER
POSTAGE

BOMBARDIER
RECREATIONAL PRODUCTS

WARRANTY DEPARTMENT
75, J.A. BOMBARDIER ST.
SHERBROOKE (QUÉBEC)
CANADA J1L 1W3



AFFIX
PROPER
POSTAGE

BOMBARDIER
RECREATIONAL PRODUCTS

WARRANTY DEPARTMENT
75, J.A. BOMBARDIER ST.
SHERBROOKE (QUÉBEC)
CANADA J1L 1W3

VEHICLE MODEL No. _____

VEHICLE IDENTIFICATION NUMBER (V.I.N.) _____

ENGINE IDENTIFICATION NUMBER (E.I.N.) _____

Owner: _____
NAME

No. _____ STREET _____ APT _____

CITY _____ STATE/PROVINCE _____ ZIP/POSTAL CODE _____

Purchase Date _____
YEAR MONTH DAY

Warranty Expiry Date _____
YEAR MONTH DAY

To be completed by the dealer at the time of the sale.

DEALER IMPRINT AREA

Please verify with your selling dealer to ensure your ATV has been registered with Bombardier.

 **WARNING**

Indicates a potential hazard that, if not avoided, could result in serious injury or death.



⚠ WARNING

THIS VEHICLE CAN BE HAZARDOUS TO OPERATE.

A collision or rollover can occur quickly, even during routine maneuvers such as turning and driving on hills or over obstacles, if you fail to take proper precautions.

SEVERE INJURY OR DEATH can result if you do not follow these instructions:

- **BEFORE YOU OPERATE THIS VEHICLE, READ THIS OPERATOR'S GUIDE AND ALL ON-PRODUCT LABELS.**
- **NEVER OPERATE THIS ATV WITHOUT PROPER INSTRUCTIONS.** Beginners should complete a certified training course.
- **NEVER CARRY MORE THAN ONE PASSENGER.** You increase your risk of losing control if you carry more than one passenger.
- **NEVER OPERATE THIS VEHICLE ON A PAVED SURFACE.** You increase your risk of losing control if you operate this vehicle on pavement.
- **NEVER OPERATE THIS VEHICLE ON PUBLIC ROADS.** You can collide with another vehicle if you operate this vehicle on a public road.
- **OPERATOR AND PASSENGER SHOULD ALWAYS WEAR AN APPROVED HELMET,** eye protection, and protective clothing.
- **NEVER CONSUME ALCOHOL OR DRUGS** before or while riding this vehicle.
- **NEVER OPERATE THIS VEHICLE AT EXCESSIVE SPEEDS.** You increase your risk of losing control if you operate this vehicle at speeds too fast for the terrain, visibility conditions, or your experience.
- **NEVER ATTEMPT WHEELIES, JUMPS, OR OTHER STUNTS.**

®™TRADEMARKS OF BOMBARDIER INC. OR ITS SUBSIDIARIES.
©2003 BOMBARDIER INC. ALL RIGHTS RESERVED
PRINTED IN CANADA

